



**INSTALLATION
AND
OPERATING
INSTRUCTIONS**

Gas Griddles

**MODELS: GGT-18H, -24H, -36H, -48H
&
MODELS: GGM-18H, -24H, -36H, 48H**

(US & Canadian units are convertible and are assembled for Natural Gas)
(European units are not convertible and assembled for the appropriate gas)

IMPORTANT FOR FUTURE REFERENCE

Please complete this information and retain this manual for the life of the equipment. For Warranty Service and/or Parts, this information is required.

Model Number

Serial Number

Date Purchased



FOR YOUR SAFETY: Do not store or use gasoline or other flammable vapors and liquids in the vicinity of this or any other appliance.



WARNING: Improper installation, operation, service or maintenance can cause property damage, injury or death. Read and understand these instructions thoroughly before positioning, installing, maintaining or servicing this equipment.





P/N 8838800 4-08



APW WYOTT Foodservice Equipment Company



P.O. Box 1829
Cheyenne, WY 82003



+1 (307) 634-5801 Phone
+1 (307) 637-8071 Fax



+1 (800) 752-0863 Toll Free
www.apwwyott.com

 **CAUTION:** These models are designed, built, and sold for commercial use. If these models are positioned so the general public can use the equipment, make sure that cautions, warnings, and operating instructions are clearly posted near each unit so that anyone using the equipment will use it correctly and not injure themselves or harm the equipment. 

 **WARNING:** Improper installation, adjustment, alteration, service or maintenance can cause property damage, injury or death. Read the installation, operating and maintenance instructions thoroughly before installing or servicing this equipment. 

 **WARNING:** Install per the spacing requirements listed in the installation section of this manual. We strongly recommend having a competent professional install the equipment. 



 **WARNING:** For your safety do not store or use gasoline or other flammable vapors and liquids in the vicinity of this or any other appliance. Keep the area free and clear of combustibles. (See ANZI Z83. 14B, 1991). 

 **NOTICE:** Instructions to be followed if anyone smells gas should be posted in a prominent place. These may be obtained from the gas supplier. 

GAS PRESSURE

The appliance and it's individual shutoff valve (to be supplied by user) must be disconnected from the gas supply piping system during any pressure testing of that system at test pressures in excess of ½ psi (3.45 kPa).

The appliance must be isolated from the gas supply piping system by closing it's individual manual shut-off valve during any pressure testing of the gas supply piping system at test pressures equal to or less than ½

 **WARNING:** A factory authorized agent should handle all maintenance and repair. Before doing any maintenance or repair, contact APW Wyott. 

Congratulations on your purchase of APW Wyott commercial cooking or refrigeration equipment. APW Wyott takes pride in the design and quality of our products. When used as intended and with proper care and maintenance, you will experience years of reliable operation from this equipment. To ensure best results, it is important that you read and follow the instructions in this manual carefully.

TABLE OF CONTENTS:

<u>ITEM</u>	<u>PAGE</u>	<u>ITEM</u>	<u>PAGE</u>
Safety Precautions.....	3	Service/Repair.....	7
Specifications & Dimensions.....	4	Conversion.....	8
General Installation Instructions.....	4	GGT Calibration Procedure/Probe Location.....	9
Lighting Instructions.....	5	Troubleshooting.....	11
Operating Instructions.....	6	Replacement Parts Lists & Exploded Views.....	12
Cleaning/Maintenance.....	7	Warranty.....	16

LOCATION OF DATA PLATE

The data plate is located on the right side panel.

IMMEDIATELY INSPECT FOR SHIPPING DAMAGE

All containers should be examined for damage before and during unloading. The freight carrier has assumed responsibility for its safe transit and delivery. If equipment is received damaged, either apparent or concealed, a claim must be made with the delivering carrier.

A) Apparent damage or loss must be noted on the freight bill at the time of delivery. It must then be signed by the carrier representative (Driver). If this is not done, the carrier may refuse the claim. The carrier can supply the necessary forms.

B) Concealed damage or loss if not apparent until after equipment is uncrated, a request for inspection must be made to the carrier within 15 days. The carrier should arrange an inspection. Be certain to hold all contents and packaging material.



Installation and start-up should be performed by a qualified installer who thoroughly read, understands and follows these instruction.



If you have questions concerning the installation, operation, maintenance or service of this product, write Technical Service Department APW Wyott Foodservice Equipment Company, P.O. Box 1829, Cheyenne, WY 82003.



SAFETY PRECAUTIONS



Before installing and operating this equipment be sure everyone involved in its operation is fully trained and is aware of all precautions. Accidents & problems can result by a failure to follow fundamental rules and precautions.



The following words and symbols, found in this manual, alert you to hazards to the operator, service personnel or the equipment. The words are defined as follows:



 **DANGER:** This symbol warns of imminent hazard which will result in serious injury or death. 



 **WARNING:** This symbol refers to a potential hazard or unsafe practice, which could result in serious injury or death. 



 **CAUTION:** This symbol refers to a potential hazard or unsafe practice, which may result in minor or moderate injury or product or property damage. 



 **NOTICE:** This symbol refers to information that needs special attention or must be fully understood even though not dangerous. 



 **NOTICE:** This product is intended for commercial use only. Not for household use. 

 **CAUTION:** These models are designed, built, and sold for commercial use. If these models are positioned so the general public can use the equipment make sure that cautions, warnings, and operating instructions are clearly posted near each unit so that anyone using the equipment will use it correctly and not injure themselves or harm the equipment. 

 **WARNING:** Improper installation, operation, service or maintenance can cause property damage, injury or death. Read and understand these instructions thoroughly before positioning, installing, maintaining or servicing this equipment. 

 **WARNING:** Keep the appliance free & clear of all combustible substances. If gas odor is detected at any time, immediately shut unit down at the main shutoff valve. Do not permit any open flames in the area of the appliance. Immediately contact an authorized Service Agency or your local Gas Supplier for service. 

 **WARNING:** Do not obstruct either the air inlet (underneath unit) or the ventilation air (back of unit). Provisions must be provided to provide an adequate air supply to the griddle. 

 **NOTICE:** Local codes regarding installation vary greatly from one area to another. The National Fire Protection Association, Inc., states in its NFPA96 latest edition that local codes are “Authority Having Jurisdiction” when it comes to requirement for installation of equipment. Therefore, installation should comply with all local codes. 

SPECIFICATIONS AND DIMENSIONS

MODEL	WIDTH IN. (MM)	DEPTH IN. (MM)	HEIGHT IN. (MM)	# OF BURNERS	BTU/kW PER BURNER	TOTAL BTU/kW HOUR	W.C. IN. (”Mbar”)
GGT-18	18 (457)	26 (661)	17-3/4(451)	1	37,500/11	37,500/11	6/10(15/25)
GGT-24	24 (610)	26 (661)	17-3/4(451)	2	25,000/7.3	50,000/14.6	6/10(15/25)
GGT-36	36 (915)	26 (661)	17-3/4(451)	3	25,000/7.3	75,000/22	6/10(15/25)
GGT-48	48 (1220)	26 (661)	17-3/4(451)	4	25,000/7.3	100,000/29.3	6/10(15/25)
GGM-18	18 (457)	26 (661)	17-3/4(451)	1	37,500/11	37,500/11	6/10(15/25)
GGM-24	24 (610)	26 (661)	16-3/4(426)	2	25,000/7.3	50,000/14.6	6/10(15/25)
GGM-36	36 (915)	26 (661)	16-3/4(426)	3	25,000/7.3	75,000/22	6/10(15/25)
GGM-48	48 (1220)	26 (661)	16-3/4(426)	4	25,000/7.3	100,000/29.3	6/10(15/25)

Griddle Surface Dimensions

MODEL	WIDTH IN. (MM)	DEPTH IN. (MM)
GGT-18 and GGM-18	17 13/16” / (452)	19 1/2” / (496)
GGT-24 and GGM-24	23 13/16” / (605)	19 1/2” / (496)
GGT-36 and GGM-36	35 13/16” / (910)	19 1/2” / (496)
GGT-48 and GGM-48	47 13/16” / (1215)	19 1/2” / (496)

GENERAL INSTALLATION INSTRUCTIONS

Ensure gas supply and gas type, as shown on unit nameplate agree.

Unit installation must conform with the National Fuel Gas Code, ANSI Z223.1-1996, the National Gas Installation Code, CAN/CGA-B149.1, or the Propane Installation Code, CAN/CGA-B149.2 as applicable and in accordance with local codes.

Screw legs into the permanently fastened nuts on the four corners of the unit and tighten by hand. Level the unit by turning the adjustment screw at the bottom of each leg. Do not slide unit with legs mounted, lift if necessary to move unit.

Pipe threading compound must be resistant to the action of liquefied petroleum gases.

Caution: DO NOT use an open flame to check for leaks. Check all gas piping for leaks with a soap and water solution before operating unit.

THESE UNITS ARE SUITABLE FOR INSTALLATION ON NON-COMBUSTIBLE SURFACES ONLY.

Noncombustible clearances:

0" sides (0 mm) 0" rear (0 mm) 4" floor (102mm)

Do not obstruct the flow of combustion and ventilation air, under the unit by the legs or behind the unit by the flue.

Adequate clearance for air openings into the combustion chamber is required. Do not place objects between the bottom of the unit and the counter top.

There must be adequate clearance for removal of the front panel. All major parts except the burners are removable thru the front if the gas line is disconnected.

European Community Installation Instructions:

"THIS APPLIANCE MUST BE FITTED BY A COMPETENT PERSON. IN THE UK, CORGI REGISTERED INSTALLERS (INCLUDING THE REGIONS OF BRITISH GAS) UNDERTAKE TO WORK TO SAFE AND SATISFACTORY STANDARDS. THIS APPLIANCE MUST BE INSTALLED IN ACCORDANCE WITH THE GAS SAFETY (INSTALLATION AND USE) REGULATIONS AND THE RELEVANT BUILDING REGULATIONS / IEE. REGULATIONS. DETAILED RECOMMENDATIONS ARE CONTAINED IN THE FOLLOWING BRITISH STANDARD CODES OF PRACTICE - BS 6172, BS 5440 PART 2, BS 6891"

"THIS APPLIANCE MUST BE INSTALLED IN ACCORDANCE WITH THE RULES IN FORCE"

"MUST BE INSTALLED IN A WELL VENTILATED AREA. Ventilation requirements ie. B.S. 5440."

LIGHTING INSTRUCTIONS

GGT and GGM Griddles are furnished with either a pilot safety valve or a standing pilot (not available in the European Community). Please follow the instructions for your unit.

Pilot Safety Valve Lighting Instructions

1. Turn on main gas supply to unit, on-off valve located behind the unit (not supplied with unit).
2. Turn the burner control knobs to "OFF" position. Wait at least 5 minutes to allow any gas which may have accumulated in the firebox compartment to escape.
3. Through the hole in the front panel, press red button on the pilot safety valve and light through observation hole in firebox. Keep red button on pilot safety depressed for at least 1 minute after pilot has lit. If pilot does not light, repeat this step.

Standing Pilot Lighting Instructions (Not Available in the European Community)

The pilot lights on the griddles have been set at the factory. A screwdriver maybe required for the first lighting to adjust the flame for your elevation.

1. Turn off the manual shut off valve and wait 5 minutes to clear the gas.
2. Turn all knobs to the "OFF" position.
3. Turn the manual shut off valve on.
4. Hold an ignition source (match) at the pilot. When the flame is established, remove the ignition source.

5. Turn the burner knobs to "HI". If the burner does not ignite, promptly open the pilot valve more. If the pilot flame appears larger than necessary, turn it down and reset burner ignition. The pilot flame should be as small as possible but large enough to guarantee reliable ignition of the burners when the knobs are turned to "HI".

Lighting main burner

To light burner, turn knob to "max." Then back off to the desired flame level. The range of adjustment is virtually infinite between high and off. (At small flame, there is a preset low).

Main burner air supply:

1. For efficient burner operation, a proper balance of gas volume and primary air supply must be maintained which will result in complete combustion. Insufficient air supply results in a yellow streaming flame. Primary air supply is controlled by an air shutter on the front of the burner.
2. Loosen the screws on the front of the burner and adjust the air shutter to just eliminate the yellow tips of the burner flame. Lock the air shutter in place by tightening the screws.

European Community

If adjustment becomes necessary in the field, it should be done by a factory authorized and trained technician who should seal the screw after the adjustment to safeguard against unauthorized tampering by the end user.

All burners are lit from constantly burning pilots. Turning the thermostat to the desired temperature is all that is required to put the unit in service.

Do not permit fans to blow directly at the unit. Wherever possible, avoid open windows next to the units' sides or back. Avoid wall type fans which create air cross-currents within a room.

It is also necessary that sufficient air should be allowed to enter the room to compensate for the amount of air removed by any ventilating system. Otherwise, a subnormal atmospheric pressure will occur, which will effect operation and cause undesirable working conditions.

A properly designed and installed hood will act as the heart of the ventilating system for the room or area in which the unit is installed and will leave the unit independent of changing draft conditions.

All valves must be checked and lubricated periodically. This must be done by an authorized service representative in your area.

OPERATING INSTRUCTIONS

Season Griddle:

Heat to low temperature (300 - 350 F/150-180C) and pour on a small amount of cooking oil, about one ounce (30cc) per square foot of surface. Spread the oil over the entire griddle surface with a cloth to create a thin film. Wipe off any excess oil with a cloth. Repeat this procedure 2 to 3 times until the griddle has a slick, mirror-like surface.

Operation:

Turn the burners on about 15-20 minutes before cooking for preheating. Set the knobs to the desired flame height or temperature. Each valve will control the gas flow to the burner to bring that area of the plate up to the set temperature. If different temperature settings are to be used, adjoining areas should be set at progressively higher temperatures using the lowest temperatures on the outside burners. A uniform and systematic approach to the loading of the griddle will produce the most consistent product results.

CLEANING / MAINTENANCE



CAUTION: Use only non-abrasive cleaners. Abrasive cleaners could scratch the finish of your unit, marring it's appearance and making it susceptible to dirt accumulation. Do Not use steel wool, other abrasive cleaners or cleaners/sanitizers containing chlorine, iodine, ammonia or bromine chemicals as these will deteriorate the stainless steel and glass material and shorten the life of the unit.



Initial Cleaning:

Prior to operating your new griddle, thoroughly wash the griddle surface and the exterior with a mild detergent or soap solution. Do not use abrasive cleaners since this might damage the cabinet finish. If the stainless steel surfaces become discolored, scrub by rubbing only in the direction of the finished grain.

Cleaning:

1. Always turn unit off and allow it to cool completely before cleaning. Clean thoroughly before first use.
2. After each use, clean the griddle with wire brush or flexible spatula.
3. Once a day, thoroughly clean splash back, sides and front. Remove the grease drawer, empty it and wash it out.
4. Once a week, clean the griddle surface thoroughly. If necessary, use a griddle stone, wire brush or steel wool on the surface. Rub with the grain of the metal while the griddle is still warm. A detergent may be used on the plate surface to help clean it; but, care must be taken to be sure the detergent is thoroughly removed. After removal of the detergent, the surface of the plate should then be covered with a thin film of oil to prevent rusting. Clean stainless surfaces with a damp cloth and polish with a soft dry cloth. To remove discoloration, use a nonabrasive cleaner. After each "weekly" cleaning, the griddle must be seasoned again. If the griddle usage is very high, the "weekly" cleaning procedures may be done more often than once a week.



CAUTION: Clean the regulator at least once a month. Make sure the vent opening is open and not blocked in any way. Failure to do so will cause variations in pressure. Your unit will not function as well and it could shorten the life of the product.



Extended Shutdown:

Turn the manual shutoff valve to "OFF"; (field installed valve not supplied by the manufacturer); turn all control knobs to the "OFF" position; and shut off the pilot flame by turning the adjustment on the pilot valve.

If the griddle is to be shut down for an extended period, put a heavy coat of grease over the griddle plate.

SERVICE / REPAIR

NOTE: THIS APPLIANCE MUST ONLY BE SERVICED BY AN AUTHORIZED AGENT.

NOTE: Parts protected by the manufacturer or his agent are not to be adjusted by the installer unless the installer is an authorized service agent.

If you have any questions or problems contact your nearest APW/Wyott Service Representative.

CONVERSION:

Instructions are for conversion from Natural Gas to Propane (L.P.) on all GGT & GGM models .
The conversion should be done before connecting the unit to the gas supply.

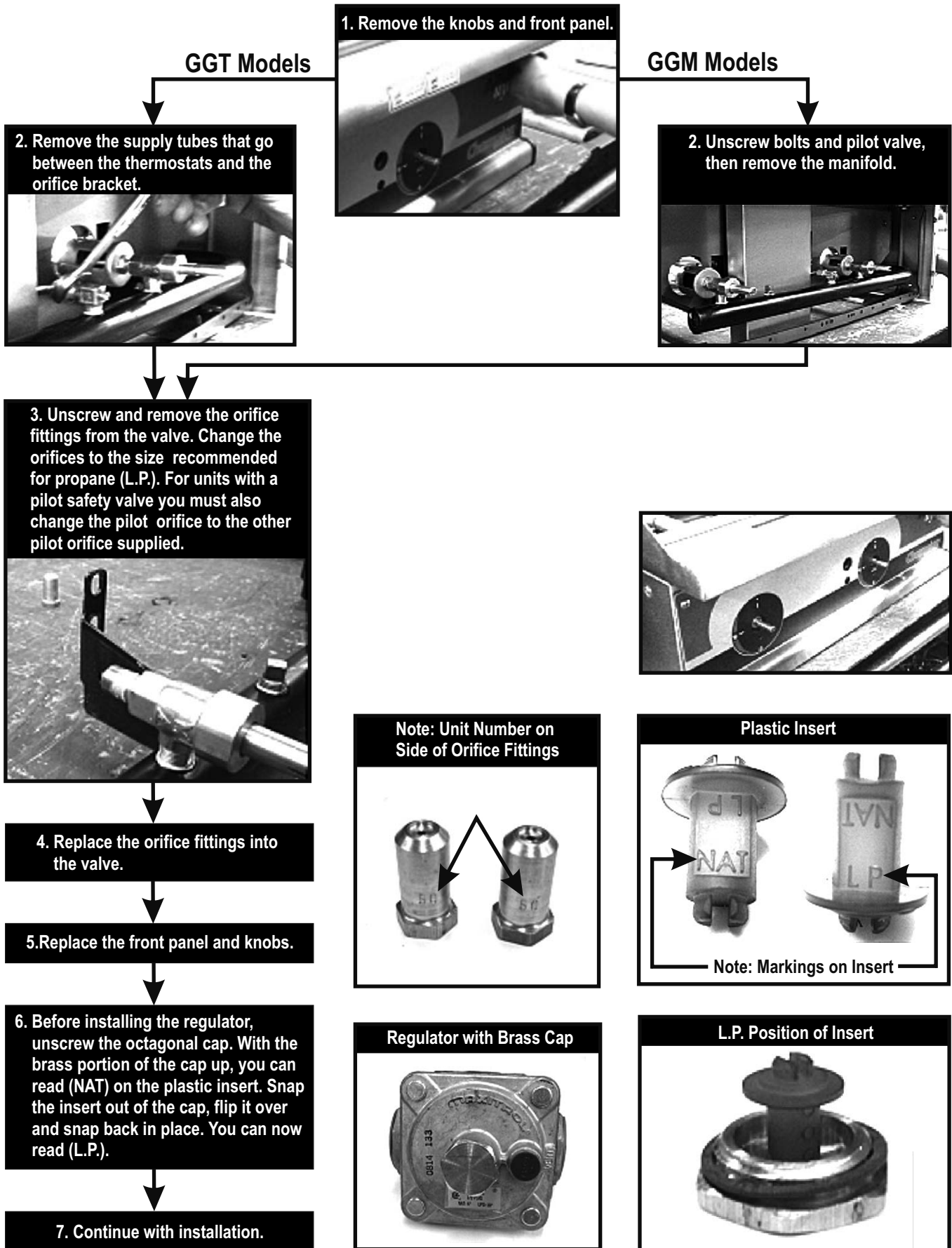

GGT CALIBRATION PROBE LOCATION

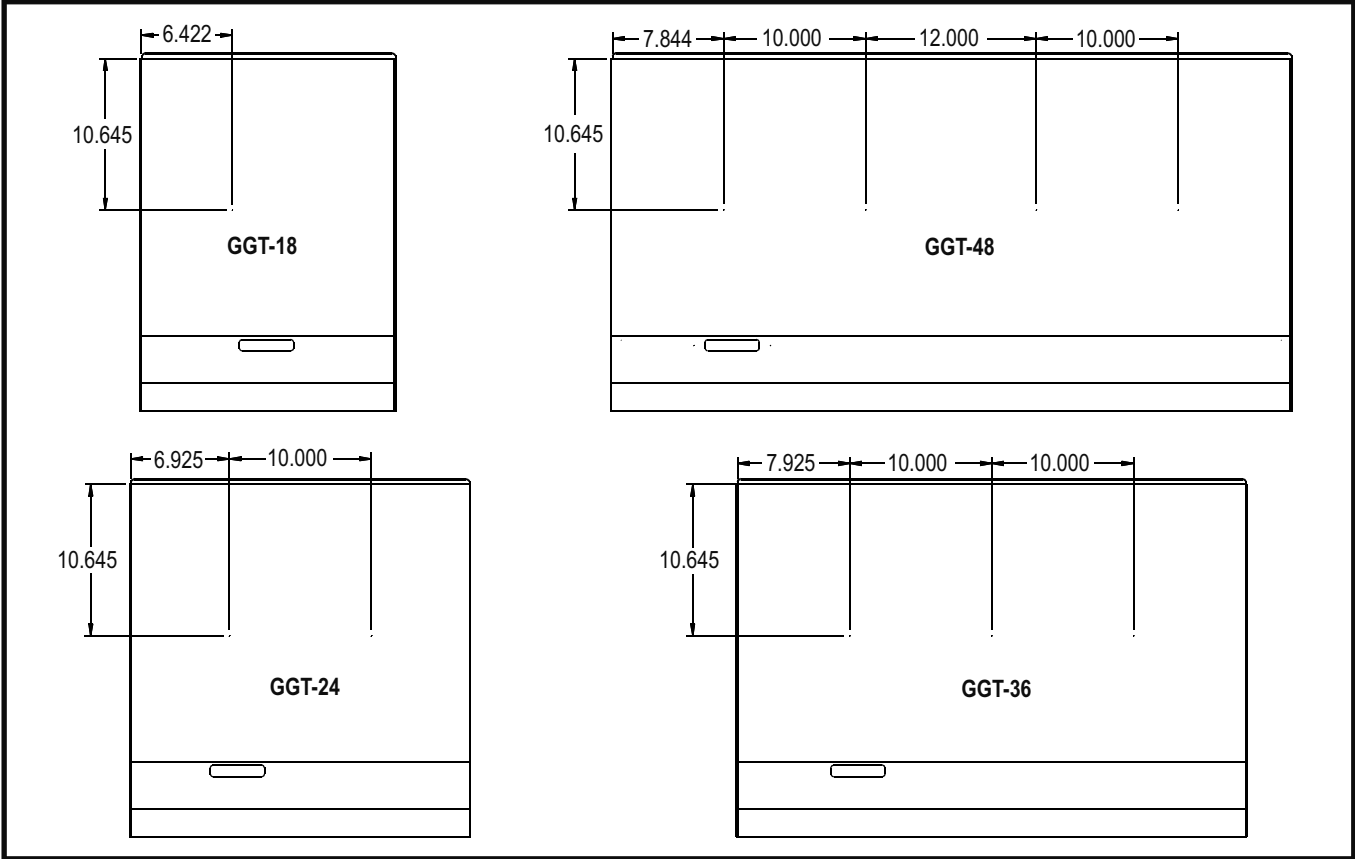

CALIBRATION PROCEDURE FOR GGT GRIDDLES

Locate the reading positions

Make sure the griddle surface is clean. Grease or food particles on the griddle will result in inaccurate thermostat calibration.

Mark the locations where the temperature probe will be placed for testing. See the sketch provided. Starting from the left side of the griddle measure 8" to the right and 10-5/8" from the rear splash guard. With a felt tip pen mark this location. This is the location directly over the center of the left thermostat bulb. From this point measure right 10" remaining 10-5/8" from the rear splash guard. Mark this location with a felt tip pin. This is the location over the next thermostat bulb. For a 36" GGT repeat this one more time 10" to the right and for the 48" GGT repeat this twice more 10" to the right always remaining 10-5/8" from the splash guard. After all locations are marked **center the temperature probe on each marked location**, and then trace a circle around the probe.

This procedure will place the temperature probe over the center of each thermostat bulb, and this is the only place temperature readings should be taken.

Set all thermostats to 350°F and allow them to cycle three to four times, or allow the griddle to preheat for ½ hour before proceeding. This makes sure the griddle temperatures have saturated the surface.

Determine the differential

Note the temperature for each section of the griddle as the burners ignite.

Note the temperature for each section of the griddle as the flame extinguishes.

The flame extinguish temperature minus the ignition temperature equals the differential.

EXAMPLE: Flame extinguished 367°F
 Flame ignition 341°F
 Difference 26° F = Differential

If the temperature differential is large than 75°F, there is probably a problem with your system. It may not be the thermostat. First make sure you thermostat probe is flat against the griddle plate and is making good contact. Dirt under the probe will cause inaccurate readings. Next make sure the thermostat bulb is held tightly in its holder. If you can pull the capillary tube and the bulb moves it is not held tight enough against the griddle plate. This will cause variations in the temperature of the griddle surface. If both of these items have been checked and you still have a differential over 75°F then the thermostat is bad replace it.

Determine the average temperature

Note the temperature for each section of the griddle as the burners ignite.

Note the temperature for each section of the griddle as the flame extinguishes.

The flame extinguish temperature plus the flame ignition temperature divided by two equals the average temperature.

EXAMPLE: Flame extinguished 367°F
 Flame ignition 341°F
 708° / 2
 Average temperature = 354°F

If the average temperature is within 15°F of the dial marking you probably leave the calibration where it is. If the average temperature is outside of 15°F of the dial setting you will want to calibrate the thermostat. To calibrate a thermostat first remove the knob by pulling it straight off the shaft. Next take a small flat head screw drive and turn the screw inside the shaft, clockwise to decrease, counterclockwise to increase. ¼ turn clockwise will decrease the temperature approximately 24°F. ¼ turn counterclockwise will increase the temperature approximately 24°F. Adjust and re-measure the average temperature until you get the temperature to your desired point.

NOTE: avoid making more than ½ turn at a time. Calibration is not linear and you can get the thermostat significantly out of calibration to a point where it is difficult to reset.

If after adjusting the thermostat three times and getting no change in calibration the thermostat is bad. Then replace the thermostat.

NOTES: _____

TROUBLESHOOTING GUIDE

PROBLEM	POSSIBLE CAUSE
Heat does not come on when thermostat is turned on.	Thermostat is bad.
	Pilot burner not lit.
	Gas valve is bad.
Pilot burner will not light.	Obstructed pilot orifice.
	Pilot gas turned off at automatic pilot.
	Automatic pilot valve is bad.
Pilot burner will not stay lit.	Thermocouple is bad.
	Thermocouple is not hot enough.
	Obstructed or wrong size pilot orifice.
	Gas supply is not purged of air.
	Air is blowing pilot light out.
Fat appears to smoke excessively.	Heat is set too high.
	Moisture in the food may be turning into steam.
Food sticks to griddle.	Heat is set too high.
	Griddle surface needs cleaning and/or seasoning.
	Surface under food may not have been covered with enough cooking oil.
Food burned around edges or contains dark specks.	Heat is set too high.
	Griddle surface needs cleaning and/or seasoning.
	Surface under food may not have been covered with enough cooking oil.
Food is undercooked inside.	Heat is set too high.
	Food may not have been cooked for long enough time.
Food tastes greasy or has objectionable off-flavor.	Food itself may have off flavor.
	Food may have been stored improperly before cooking.
	Too much griddle fat used.
	Heat is set too low.
Noticeable build-up of gum on griddle.	Heat is set too high
	Griddle surface needs cleaning and/or seasoning.
	Too much griddle fat used.

PARTS LISTS & EXPLODED VIEWS

GGM GRIDDLES (EXPLODED VIEW)

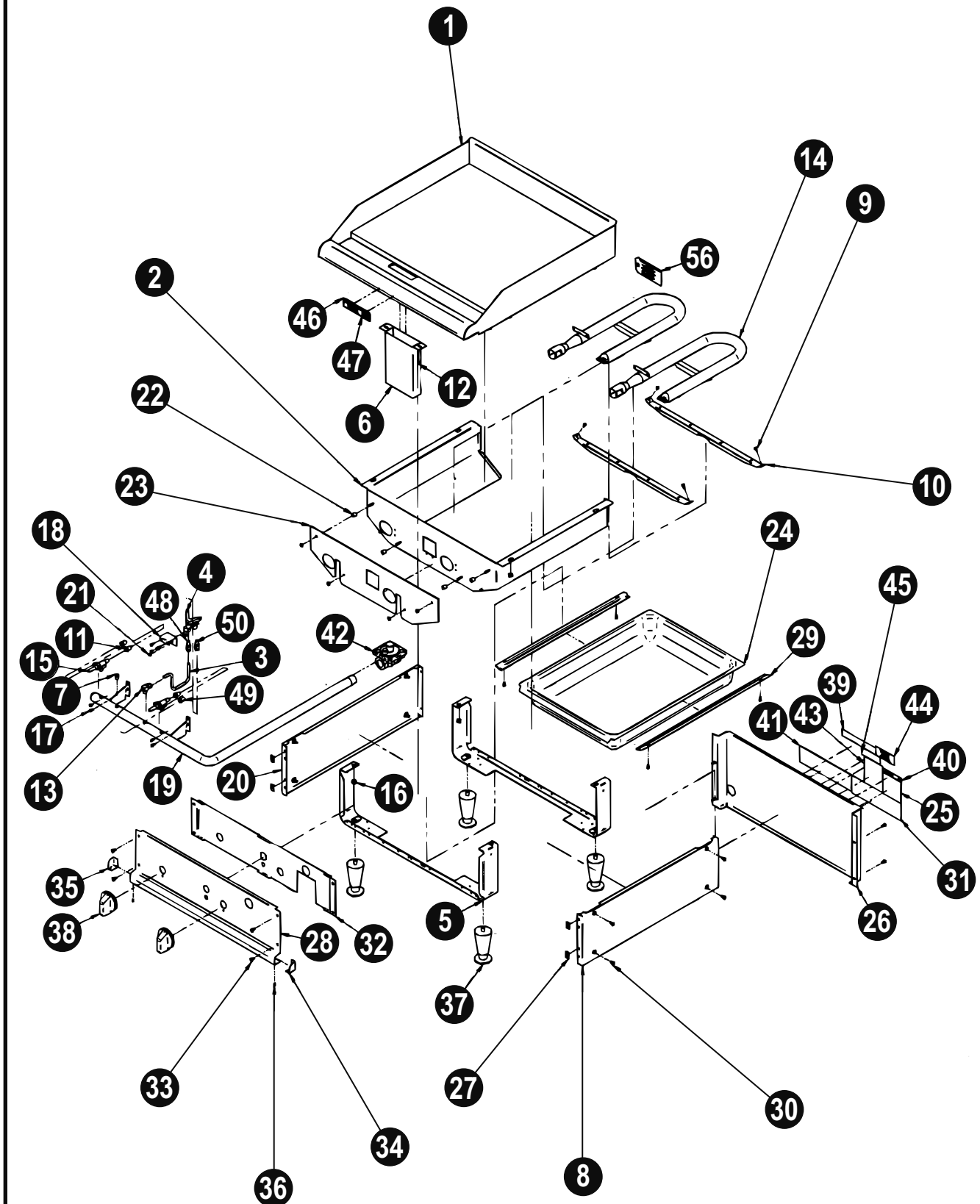

GGM - PARTS LIST

ITEM	P/N	DESCRIPTION	QTY	ITEM	P/N	DESCRIPTION	QTY
1	218215-20	Weldment, Griddle GGM-18	1	24	24251-00	Pan, Grease 18"	Varies
	218216-20	Weldment, Griddle GGM-24	1		24250-00	Pan, Grease 24"	Varies
	218217-20	Weldment, Griddle GGM-36	1	25	8861000	Label, Spec	1
	218218-20	Weldment, Griddle GGM-48	1	26	218215-12	Panel, Back GGM-18	1
2	218215-11	Body, 18" Firebox GGM	1		218216-12	Panel, Back GGM-24	1
	218216-11	Body, 24" Firebox GGM	1		218217-12	Panel, Back GGM-36	1
	218217-11	Body, 36" Firebox GGM	1		218218-12	Panel, Back GGM-48	1
	218218-11	Body, 48" Firebox GGM	1	27	8196601	Nut, U-Type	4
3	21820728	Tube, Pilot Supply GGM-18	1	28	21820719	Panel, Control	1
	21820727	Tube, Pilot Supply GGM-24/36/48	Varies		21820819	Panel, Control	1
4	2066154	Pilot, Top	1		21820919	Panel, Control	1
	2092800	Pilot, Broiler	Varies		21821019	Panel, Control	1
5	218207-23	Support, Leg-18	2	29	30047501	Guide, Grease Slide	Varies
	218208-23	Support, Leg-24	2	30	8170700	Screw, 10-32x1/2, Type AB	Varies
	218209-23	Support, Leg-36	2	31	8837120	Label, Orifice Size	1
	218210-23	Support, Leg-48	2	32	218207-24	Baffle, Front Panel 18"	1
6	218207-16	Side, Grease Chute	Varies		218208-24	Baffle, Front Panel 24"	1
7	2092517	Plug, 1/8 NPTM	Varies		218209-24	Baffle, Front Panel 36"	1
8	218220-50	Side Panel, RH	1		218210-24	Baffle, Front Panel 48"	1
9	81546-00	#8 X 3/8	4	33	81973-00	T/S #10 X 1/2 TPB Tr Hd	4
10	218207-17	Support, Burner-18	2	34	218208-26	Cap, End Control Panel R.H.	1
	218208-17	Support, Burner-24	2	35	218208-27	Cap, End Control Panel L.H.	1
	218209-17	Support, Burner-36	2	36	8353000	Pop Rivet	2
	218210-17	Support, Burner-48	2	37	8632000	Leg, 4" Adj., 2000 Lb Cap.	4
11	2066844	Orifice, #44	Varies	38	8705800	Knob, Med. Duty Unit	Varies
12	8417100	Nut, Hex, KEPS 10-32	Varies	39	8837129	Label, Instr.-location	1
13	2065643	Valve, Pilot 90° 1/8NPT X 3/16CC GGM-18	Varies	40	8832600	Label, Service Hotline	1
	2068001	Pilot Valve GGM-24/36/48	Varies	41	8837130	Decal, Oper. Instr.	1
14	21813075	Burner, "S"	1	42	2067300	Regulator, Convertible 3/4 1/2 PSIG	1
	21813175	Burner, "U"	Varies	43	8809920	Decal, Improper Install	1
15	2068200	Valve, Gas, On-Off	Varies	44	8825300	Decal, Leg	1
16	8436200	Nut, Hex 5/16-18 S/S	Varies	45	8822325	Decal, UL Sanitation, NSF Std. 4	1
17	8153100	#8-32 X 3/8 Type T	Varies	46	43813103	Label, Warning, Hot Surface	1
18	218207-29	Bracket, Pilot GGM-18	1	47	43813149	Label, Warning, Hot Surface (French)	1
	218208-25	Bracket, Pilot GGM-24/36/48	Varies	48	2092903	Pilot Natural @ 6" W.C.	Varies
19	21820715	Manifold, 18" GCRB	1	49	2066850	Orifice, #50	Varies
	21820730	Manifold, 18" GCRB Pilot Safety	1	50	2092904	Orifice, Pilot L.P.	Varies
	21820815	Manifold, 24" GCRB	1	52*	8899300	List Of Service Agencies	1
	21820830	Manifold, 24" GCRB Pilot Safety	1	53*	8838800	Manual, GGT-H/GGM-H Champion II	1
	21820915	Manifold, 36" GCRB	1	55*	8837201	Bag, Cloth, 4"x6" W/drawstring	1
	21820930	Manifold, 36" GCRB Pilot Safety	1	56*	8837190	Tag, Orifice Location	1
	21821015	Manifold, 48" GCRB	1	58*	8824618	Decal, Front Panel GCB/GCRB/GGM-18	1
	21821030	Manifold, 48" GCRB Pilot Safety	1		8824624	Decal, Front Panel GCB/GCRB/GGM-24	1
20	218220-49	Side Panel, LH	1		8824636	Decal, Front Panel GCB/GCRB/GGM-36	1
21	8163100	M/S Tr Hd Ph 10-32x1/4	Varies		8824648	Decal, Front Panel GCB/GCRB/GGM-48	1
22	21813085	Spacer	Varies	59*	2092610	Coupling, 3/4" Pipe X 3" Long	1
23	218207-18	Baffle, 18" Front Heat	1	60*	2092592	Nipple, 3/4 X Close Schd 40 Black	1
	218208-18	Baffle, 24" Front Heat	1	61*	2092611	Elbow, 3/4 Black Pipe	1
	218209-18	Baffle, 36" Front Heat	1	62*	2092613	Pipe, Black 3/4" X 23" Long Thrd Both Ends	1
	218210-18	Baffle, 48" Front Heat	1			*NOT SHOWN	

GGT GRIDDLES (EXPLODED VIEW)

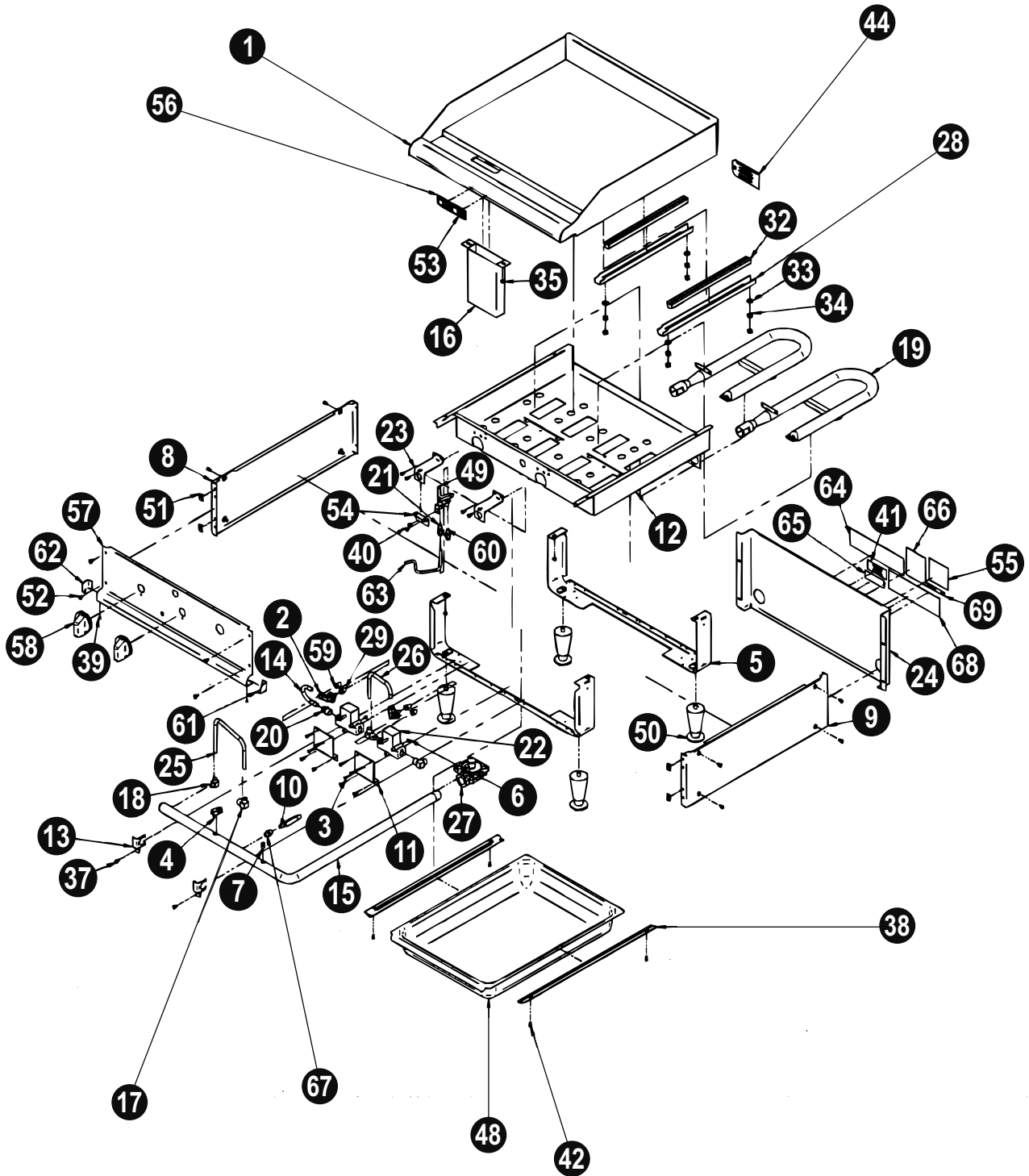

GGT (PARTS LIST)

Item	P/N	Description	Quan	Item	P/N	Description	Quan
1	218219-60	Weldment, Griddle, GGT -18	1	30*	2300100	Bags, Poly 36x27x44	1
	218220-60	Weldment, Griddle, GGT -24	1	32	1018064	Insulation, Thermostat Bulb	2
	218221-60	Weldment, Griddle, GGT -36	1	33	8509300	Washer, Flat, SAE, 5/16	4
	218222-60	Weldment, Griddle, GGT -48	1	34	8436200	Nut, Hex 5/16-18 S/S	8
2	2092614	Elbow, 3/8CC X 3/8NPT, No Hood	Varies	35	8417100	Nut, Hex, Keps 10-32	6
3	81108-00	M/S Tr Hd Ph 6-32 x 1"	Varies	36*	2300000	29x19x44 Poly	1
4	2065614	Valve, Pilot GGT-18	1	37	8170700	Screw, 10-32x1/2, Type AB	20
	2068001	Pilot Valve GGT-24/36/48	Varies	38	30047501	Guide, Grease Slide	2
5	218207-23	Support, Leg GCRB/GCB/GGM/GGT-18	2	39	8353000	Pop Rivet	2
	218208-23	Support, Leg GCRB/GCB/GGM/GGT-24	2	40	8163100	M/S Pn Hd Ph 10-32 X 1/4"	2
	218208-23	Support, Leg GCRB/GCB/GGM/GGT-36	2	41	8825300	Decal, Leg	1
	218208-23	Support, Leg GCRB/GCB/GGM/GGT-48	2	42	8153100	#8-32 X 3/8 Type T	4
6	8400100	Nut, Hex Keps, #6-32	Varies	43*	8824518	Decal, GGT-18 Front Panel	1
7	2092517	Plug, 1/8 NPTM	1		8824524	Decal, GGT-24 Front Panel	1
8	218220-49	Side Panel, LH	1		8824536	Decal, GGT-36 Front Panel	1
9	218220-50	Side Panel, RH	1		8824548	Decal, GGT-48 Front Panel	1
10	21822047	Tube, T-Stat/Hood Orifice GGT-24/36/48	Varies	44	8837190	Tag, Orifice Location	1
11	21822034	Bracket, Thermostat GGT	Varies	45*	8837201	Bag, Cloth, 4"x6" W/Drawstring	1
12	21821911	Firebox, GGT -18	1	46*	8838800	Manual, GGT-H/GGM-H Champion li	1
	21814020	Firebox, GGT -24	1	47*	8899300	List Of Service Agencies	1
	21822121	Firebox, GGT -36	1	48	24251-00	Pan, Grease 18"	Varies
	21814022	Firebox, Ggt -48	1		24250-00	Pan, Grease 24"	Varies
13	21822035	Bracket, Manifold GGT	Varies	49	2066154	Pilot, Top GGT-18	1
14	21822046	Tube, T-Stat/Hood Orifice	Varies		2092800	Pilot, Broiler GGT-24/36/48	1
15	21821915	Manifold, GGT-18H	1	50	8632000	Leg, 4" Adj., 2000 Lb Cap.	4
	21822029	Manifold, GGT-24H	Varies	51	8196601	Nut, U-Type	4
	21822130	Manifold, GGT-36H	1	52	81973-00	T/S #10 X 1/2 TPB Tr Hd	4
	21822029	Manifold, GGT-48H	1	53	43813149	Label, Warning Hot Surface (French)	1
15*	21821930	Manifold, GGT-18H Pilot Safety	1	54	21821920	Bracket, Pilot Top T-Pile GGT-18	1
	21822030	Manifold, GGT-24H Pilot Safety	1		21814036	Bracket, Pilot GGT-24/36/48	1
	21822035	Manifold, GGT-36H Pilot Safety	1	55	8861000	Label, Spec	1
	21822235	Manifold, GGT-48H Pilot Safety	1	56	43813103	Label, Warning, Hot Surface	1
16	218207-16	Side, Grease Chute	2	57	21821916	Panel, Control GGT-18H	1
17	2092506	Elbow, 3/8C X 3/8 Ipt Male	Varies		21822023	Panel, Control GGT-24H	1
18	2069020	Elbow, 1/8 Pipe To 3/8 Comp.	Varies		21822124	Panel, Control GGT-36H	1
19	2065855	Burner, "S" GGT-18	1		21822225	Panel, Control GGT-48H	1
19	2065850	Burner, "U" GGT-24/36/48	Varies	58	8705810	Knob, Large Cookline Gray .25 Shaft	Varies
20	2092623	3/8 Comp X 3/8 NPT Male Straight	Varies	59	2066850	Orifice, #50 GGT-18	Varies
21	2092903	Pilot Nat @ 6" W.C. GGT-24/36/48	1		2066854	Orifice, #54 GGT-24/36/48	Varies
22	2067700	Thermostat, Gas Snap Action	Varies	60	2092904	Orifice, Pilot L.P. GGT-24/36/48	Varies
23	21814019	Bracket, Orifice	2	61	218208-26	Cap, End Control Panel R.H.	1
24	21821912	Panel, Back GGT -18	1	62	218208-27	Cap, End Control Panel L.H.	1
	21822026	Panel, Back GGT -24	1	63	21821949	Tube, Pilot Supply Standing GGT-18	1
	21822127	Panel, Back GGT -36	1		21822048	Tube, Pilot Supply GGT-24/36/48	Varies
	21822228	Panel, Back GGT -48	1	64	8837130	Decal, Oper. Instr.	1
25	21822045	Tube, Manifold/T-Stat	Varies	65	8822325	Decal, UL Sanitation, NSF Std. 4	1
26	21822044	Tube, Manifold/T-Stat GGT-24/36/48	1	66	8809920	Decal, Improper Install	1
27	2067300	Regulator, Convertable 3/4 1/2 PSIG	1	67	2092624	3/8 Comp X 1/8 NPT Male Straight	Varies
28	21723090	Cover, Thermostat Bulb	Varies	68	8837120	Label, Orifice Size	1
29	2066837	Orifice, #37 GGT-18	1	69	8832600	Label, Service Hotline	1
	2066844	Orifice, #44 GGT-24/36/48	Varies			*NOT SHOWN	

APW WYOTT EQUIPMENT LIMITED WARRANTY

APW Wyott Foodservice Equipment Company warrants its equipment against defects in materials and workmanship, subject to the following conditions:

This warranty applies to the original owner only and is not assignable.

Should any product fail to function in its intended manner under normal use within the limits defined in this warranty, at the option of APW Wyott such product will be repaired or replaced by APW Wyott or its Authorized Service Agency. APW Wyott will only be responsible for charges incurred or service performed by its Authorized Service Agencies. The use of other than APW Wyott Authorized Service Agencies will void this warranty and APW Wyott will not be responsible for such work or any charges associated with same. The closest APW Wyott Authorized Service Agent must be used.

This warranty covers products shipped into the 48 contiguous United States, Hawaii, metropolitan areas of Alaska and Canada. There will be no labor coverage for equipment located on any island not connected by roadway to the mainland.

Warranty coverage on products used outside the 48 contiguous United States, Hawaii, and metropolitan areas of Alaska and Canada may vary. Contact the international APW Wyott distributor, dealer, or service agency for details.

Time Period

One year for parts and one year for labor, effective from the date of purchase by the original owner. The Authorized Service Agency may, at their option, require proof of purchase. Parts replaced under this warranty are warranted for the un-expired portion of the original product warranty only.

Exceptions

- ***Gas/Electric Cookline:** Models GCB, GCRB, GF, GGM, GGT, CHP-H, EF, EG, EHP. Three (3) Year Warranty on all component parts, except switches and thermostats. (2 additional years on parts only. No labor on second or third year.)
- ***Broiler Briquettes, Rock Grates, Cooking Grates, Burner Shields, Fireboxes:** 90 Day Material Only. No Labor.
- ***Heat Strips:** Models FD, FDL, FDD, FDDL. Two (2) Year Warranty on element only. No labor second year.
- ***Glass Windows, Doors, Seals, Rubber Seals, Light Bulbs:** 90 Day Material Only. No Labor.

In all cases, parts covered by extended warranty will be shipped FOB the factory after the first year.

Portable Carry In Products

Equipment weighing over 70 pounds or permanently installed will be serviced on-site as per the terms of this warranty. Equipment weighing 70 pounds or under, and which is not permanently installed, i.e. with cord and plug, is considered portable and is subject to the following warranty handling limitations. If portable equipment fails to operate in its intended manner on the first day of connection, or use, at APW Wyott's option or its Authorized Service Agency, it will be serviced on site or replaced.

From day two through the conclusion of this warranty period, portable units must be taken to or sent prepaid to the APW Wyott Authorized Service Agency for in-warranty repairs. No mileage or travel charges are allowed on portable units after the first day of use. If the customer wants on-site service, they may receive same by paying the travel and mileage charges. Exceptions to this rule: (1) countertop warmers and cookers, which are covered under the Enhanced Warranty Program, and (2) toasters or rollergrills which have in store service.

Exclusions

The following conditions are not covered by warranty:

- *Equipment failure relating to improper installation, improper utility connection or supply and problems due to ventilation.
- *Equipment that has not been properly maintained, calibration of controls, adjustments, damage from improper cleaning and water damage to controls.
- *Equipment that has not been used in an appropriate manner, or has been subject to misuse or misapplication, neglect, abuse, accident, alteration, negligence, damage during transit, delivery or installation, fire, flood, riot or act of god.
- *Equipment that has the model number or serial number removed or altered.

If the equipment has been changed, altered, modified or repaired by other than an Authorized Service Agency during or after the warranty period, then the manufacturer shall not be liable for any damages to any person or to any property, which may result from the use of the equipment thereafter.

This warranty does not cover services performed at overtime or premium labor rates. Should service be required at times which normally involve overtime or premium labor rates, the owner shall be charged for the difference between normal service rates and such premium rates. APW Wyott does not assume any liability for extended delays in replacing or repairing any items beyond its control.

In all cases, the use of other than APW Wyott Authorized OEM Replacement Parts will void this warranty.

This equipment is intended for commercial use only. Warranty is void if equipment is installed in other than commercial application.

Water Quality Requirements

Water supply intended for a unit that has in excess of 3.0 grains of hardness per gallon (GPG) must be treated or softened before being used. Water containing over 3.0 GPG will decrease the efficiency and reduce the operation life of the unit.

Note: Product failure caused by liming or sediment buildup is not covered under warranty.

“THE FOREGOING WARRANTY IS IN LIEU OF ANY AND ALL OTHER WARRANTIES EXPRESSED OR IMPLIED INCLUDING ANY IMPLIED WARRANTY OF MERCHANTABILITY OR FITNESS FOR PARTICULAR PURPOSES AND CONSTITUTES THE ENTIRE LIABILITY OF APW WYOTT. IN NO EVENT DOES THE LIMITED WARRANTY EXTEND BEYOND THE TERMS STATED HEREIN.”

9/05