



**INSTALLATION AND OPERATING INSTRUCTIONS**

**HOTROD® ROLLER GRILLS  
SLANTED HOTROD® ROLLER GRILLS  
FULL MENU HOTROD® ROLLER GRILLS**

**Model Numbers:** HR & HRS -31, -50, -45, -75 & -85 (BC, BD, BW, S, SBC, SBD, SBW)

**INTENDED FOR OTHER THAN HOUSEHOLD USE**

**RETAIN THIS MANUAL FOR FUTURE REFERENCE**

**UNIT MUST BE KEPT CLEAR OF COMBUSTIBLES AT ALL TIMES**

**IMPORTANT FOR FUTURE REFERENCE**

Please complete this information and retain this manual for the life of the equipment. For Warranty Service and/or Parts, this information is required.

\_\_\_\_\_   
Model Number

\_\_\_\_\_   
Serial Number

\_\_\_\_\_   
Date Purchased



**WARNING:** For your safety do not store or use gasoline or other flammable vapors or liquids in the vicinity of this or any other appliance. Keep the area free and clear of combustibles. (See ANZI Z83.14B, 1991)



**WARNING:** Improper installation, adjustment, alteration, service or maintenance can cause property damage, injury or death. Read the Installation, Operating and Maintenance Instructions thoroughly before installing or servicing this equipment.



This equipment has been engineered to provide you with year-round dependable service when used according to the instructions in this manual and standard commercial kitchen practices.

Phone: +1 (307) 634-5801  
Fax: +1 (307) 637-8071  
Toll Free: +1 (800) 752-0863  
Website: [www.apwwyott.com](http://www.apwwyott.com)  
E-mail: [info@apwwyott.com](mailto:info@apwwyott.com)

P/N 8893920 10/13

**APW WYOTT**  
P.O. Box 1829  
Cheyenne, WY 82003

**APW Wyott** takes pride in the design and quality of our products. When used as intended and with proper care and maintenance, you will experience years of reliable operation from this equipment. To ensure best results, it is important that you read and follow the instructions in this manual carefully.



Installation and start-up should be performed by a qualified installer who thoroughly read, understands and follows these instruction.



If you have questions concerning the installation, operation, maintenance or service of this product, write Technical Service Department APW/Wyott Foodservice Equipment Company, P.O. Box 1829, Cheyenne, WY 82003.



## SAFETY PRECAUTIONS



Before installing and operating this equipment be sure everyone involved in its operation are fully trained and are aware of all precautions. Accidents and problems can result by a failure to follow fundamental rules and precautions.

The following words and symbols, found in this manual, alert you to hazards to the operator, service personnel or the equipment. The words are defined as follows:

 **DANGER:** This symbol warns of imminent hazard which will result in serious injury or death. 



 **WARNING:** This symbol refers to a potential hazard or unsafe practice, which could result in serious injury or death. 



 **CAUTION:** This symbol refers to a potential hazard or unsafe practice, which may result in minor or moderate injury or product or property damage. 



 **NOTICE:** This symbol refers to information that needs special attention or must be fully understood even though not dangerous. 



---



---



 **CAUTION:** These models are designed, built, and sold for commercial use. If these models are positioned so the general public can use the equipment make sure that cautions, warnings, and operating instructions are clearly posted near each unit so that anyone using the equipment will use it correctly and not injure themselves or harm the equipment. 



 **WARNING: *SHOCK HAZARD*** - Do not open any panels that require the use of tools. 



 **WARNING:** Improper installation, adjustment, alteration, service or maintenance can cause property damage, injury or death. Read the Installation, Operating and Maintenance Instructions thoroughly before installing or servicing this equipment. 



 **NOTICE:** The unit when installed, must be electrically grounded and comply with local codes, or in the absence of local codes, with the national electrical code ANSI/NFPA70- latest edition. Canadian installation must comply with CSA-STANDARD C.22.2 Number 0 M1982 General Requirements-Canadian Electrical Code Part II, 109-M1981- Commercial Cooking Appliances. 

 **NOTICE:** Local codes regarding installation vary greatly from one area to another. The National Fire Protection Association, Inc. states in its NFPA96 latest edition that local codes are "Authority Having Jurisdiction" when it comes to requirement for installation of equipment. Therefore, installation should comply with all local codes. 

 **WARNING:** Check the data plate on this unit before installation. Connect the unit only to the voltage and frequency listed on the data plate. Connect only to 1 or 3 phase as listed on the data plate. 

 **WARNING:** Disconnect device from electrical power supply and place a Tag Out-Lockout on the power plug, indicating that you are working on the circuit. 

 **CAUTION:** Maintenance & repair should be handled by a factory authorized agent. Before doing any maintenance or repair, contact APW Wyott. 

 **NOTICE:** Install according to the spacing requirements listed in the installation section of this manual. We strongly recommend having a competent professional install this equipment. A licensed electrician should make the electrical connections and connect power to the unit. Local codes should always be used when connecting these units to electrical power. In the absence of local codes, use the latest version of the National Electrical Code. 

## CONTENTS

<i><b>Description</b></i>	<i><b>Page</b></i>	<i><b>Description</b></i>	<i><b>Page</b></i>
Safety Precautions.....	2	HR-31 (Parts List).....	11
Specifications .....	4	HR-50 (Parts List).....	12
General Installation Instructions .....	5	HR-45, 75 & 85 (Exp View).....	13
Installation .....	6	HR-45, 75 & 85 BC .....	14
Operation .....	6	HR-45, 75 & 85 BW.....	15
Cleaning .....	6	HR-45 (Parts List) .....	16
Service .....	7	HR-75 (Parts List) .....	17
Parts Lists & Exploded Views.....	8	HR-85 (Parts List).....	18
HR-31 & 50 BW (Exp View).....	8	Wiring Diagrams.....	19
HR-31 & 50 BC (Exp View).....	9	Warranty.....	20
HR-31 & 50 (Exp View).....	10		

### LOCATION OF DATA PLATE

The data plate for the Hot Rod is located on the back of the unit.

### IMMEDIATELY INSPECT FOR SHIPPING DAMAGE

All containers should be examined for damage before and during unloading. The freight carrier has assumed responsibility for its safe transit and delivery. If equipment is received damaged, either apparent or concealed, a claim must be made with the delivering carrier.

A) Apparent damage or loss must be noted on the freight bill at the time of delivery. It must then be signed by the carrier representative (Driver). If this is not done, the carrier may refuse the claim. The carrier can supply the necessary forms.

B) Concealed damage or loss if not apparent until after equipment is uncrated, a request for inspection must be made to the carrier within 15 days. The carrier should arrange an inspection. Be certain to hold all contents and packaging material.

Installation and start-up should be performed by a qualified installer who thoroughly read, understands and follows these instructions.

## SPECIFICATIONS

MODEL	WIDTH	DEPTH	HEIGHT	VOLTAGE	AMPS
HR-31	23.75"	18.625"	9.125"	120	8.3
HR-31BC	23.75"	18.625"	13.1875"	120	8.3
HR-31BD	23.75"	18.625"	13.1875"	120	8.3
HR-31BW	23.75"	18.625"	13.1875"	120	8.3
HRS-31	23.75"	18.625"	9.125"	120	8.3
HRS-31BC	23.75"	18.625"	13.1875"	120	8.3
HRS-31BD	23.75"	18.625"	13.1875"	120	8.3
HRS-31BW	23.75"	18.625"	13.1875"	120	8.3
HR-31S	23.75"	18.375"	11.75"	120	8.3
HR-31SBC	23.75"	18.375"	16.125"	120	8.3
HR-31SBD	23.75"	18.375"	16.125"	120	8.3
HR-31SBW	23.75"	18.375"	16.125"	120	8.3
HRS-31S	23.75"	18.375"	11.75"	120	8.3
HRS-31SBC	23.75"	18.375"	16.125"	120	8.3
HRS-31SBD	23.75"	18.375"	16.125"	120	8.3
HRS-31SBW	23.75"	18.375"	16.125"	120	8.3
HR-50	34.75"	18.625"	9.125"	120	11
HR-50BC	34.75"	18.625"	13.1875"	120	11
HR-50BD	34.75"	18.625"	13.1875"	120	11
HR-50BW	34.75"	18.625"	13.1875"	120	11
HRS-50	34.75"	18.625"	9.125"	120	11
HRS-50BC	34.75"	18.625"	13.1875"	120	11
HRS-50BD	34.75"	18.625"	13.1875"	120	11
HRS-50BW	34.75"	18.625"	13.1875"	120	11
HR-50S	34.75"	18.375"	11.75"	120	11
HR-50SBC	34.75"	18.375"	16.125"	120	11
HR-50SBD	34.75"	18.375"	16.125"	120	11
HR-50SBW	34.75"	18.375"	16.125"	120	11
HRS-50S	34.75"	18.375"	11.75"	120	11
HRS-50SBC	34.75"	18.375"	16.125"	120	11
HRS-50SBD	34.75"	18.375"	16.125"	120	11
HRS-50SBW	34.75"	18.375"	16.125"	120	11
HR-45	23.75"	29.56"	10.875"	120	12.2
HR-45BC	23.75"	29.56"	13.75"	120	12.2
HR-45BW	23.75"	29.56"	13.75"	120	12.2
HRS-45BC	23.75"	29.56"	13.75"	120	12.2
HRS-45BW	23.75"	29.56"	13.75"	120	12.2
HR-75	34.75"	29.56"	10.875"	120	16.6
HR-75BC	34.75"	29.56"	16.75"	120	16.6
HR-75BW	34.75"	29.56"	16.75"	120	16.6
HRS-75BC	34.75"	29.56"	16.75"	120	16.6
HRS-75BW	34.75"	29.56"	16.75"	120	16.6
HR-85BW	34.75"	29.56"	16.75"	120	18.7
HRS-85BW	34.75"	29.56"	16.75"	120	18.7
HR-31	23.75"	18.625"	9.125"	208/240	3.2/4.8

# GENERAL INSTALLATION INSTRUCTIONS

This unit has been inspected and tested at the factory prior to shipment.

Unpack the unit and remove all packing materials. Place on a flat horizontal surface at the desired location.



**WARNING:** Check the data plate on this unit before installation. Connect the unit only to the voltage and frequency listed on the data plate. Connect only to 1 or 3 phase as listed on the data plate.



**WARNING: IMPROPER GROUNDING COULD RESULT IN ELECTRICAL SHOCK!** This appliance is equipped with a three prong (grounded) plug for your protection against electrical shock hazard and should be plugged directly into a properly grounded three prong receptacle. Do not cut or remove the grounding prong from this plug.



**CAUTION:** Do not use ordinary steel wool as any particles left on the surface will rust.



*NEVER USE* a wire brush, steel or abrasive scouring pads (except stainless), scraper, file or other steel tools. Surfaces which are marred collect dirt more rapidly and become more difficult to clean. Marring also increases the possibility of corrosive attack.

*NEVER* use any corrosive cleaner. Use only cleaners approved for stainless steel.

*NEVER* use cleaning solvents with a hydrocarbon base.

## GENERAL INSTALLATION:

1. Always clean equipment thoroughly before first use. (See general cleaning instructions)
2. Check ratings label for your model designation and electrical ratings.
3. For best results, use stainless steel countertops.
4. Attach legs to unit.

## GENERAL OPERATION INSTRUCTIONS:

1. Trained personnel should operate all food service equipment.
2. Do not allow your customers to come into contact with any surface labeled "CAUTION HOT".
3. Where applicable, never pour cold water into dry heated units.
4. Where applicable, do not cook, warm or hold food directly in liner/well pans. Always use steam table pans/inserts, etc.
5. NEVER hold food below 140° F.

## GENERAL CLEANING INSTRUCTIONS:

1. Never clean any electrical unit by immersing it in water. Turn the unit off and allow it to cool before surface cleaning.
2. Always clean equipment thoroughly before first use. Clean unit daily. Except where noted on charts: use warm, soapy water. Mild cleansers and plastic scouring pads may be used to remove baked-on food and water scale on metal unit. NOTE: do not clean roller tubes with abrasive cleaners or scouring pads. Follow instructions on page 6.
3. Unplug electrical unit before cleaning or servicing. All service should be performed by an APW Wyott authorized service agency.

## GENERAL TROUBLESHOOTING:

### *Always ask and check:*

1. Is the unit connected to a live power source?
2. Check the circuit breaker.

3. Is power switch on and pilot light glowing?
4. Check the rating label. Are you operating unit on the proper voltage?

If the above checks out and you still have problems, call an APW Wyott authorized service agency.

## INSTALLATION

Place the HOTROD<sup>®</sup> directly on a countertop or on a matching APW Wyott Bun Warmer or Bun Cabinet (available separately). Place the unit close to an AC outlet, of the correct voltage, to avoid undue strain on the power cord.

**CAUTION:** To avoid equipment damage, make certain that the nameplate voltage is the same as the outlet voltage.

If the plug is to be removed and replaced with a plug more suitable for your area, the color code for the power cable is:

Neutral (N) = White or Blue    Live (L) = Black or Brown    Safety Earth (E) = Green or Yellow/Green

After a suitable location has been chosen, wipe the rollers and the drip pan with a damp cloth. The unit is ready for use.

## OPERATION



**WARNING:** This unit is not intended to hold potentially hazardous foods such as un-cooked or un-preserved meats and sausages.



There are three simple controls on the front of this unit: a switch, which controls the tube rotation, and two adjustable heat controls, which activates the two banks of heating elements in the roller tubes. Both heat controls have a light above them indicating either "Front" or "Back". The front heat control activates the first 5 or 6 (depending on if your unit has 10 or 11 tubes). The back Control activates the remaining 5 tubes. Each bank of tubes can be heated independently of the others and at separate temperature settings. Variations in voltage and ventilation make experimenting the best guide to power level adjustment.

When a preferred adjustment is found, and it is desired to return consistently to the same spot on the controls, the controls can be fine-tuned by aligning with a mark on the knob. This adjustment does not require a service visit.

## CLEANING

### DAILY CLEANING INSTRUCTIONS:

1. Heat the unit.
2. Using a moist cloth filled with crushed or flaked ice, wipe each tube. Wipe the tubes from each end to the center. This will keep as much of the loosened particles out of the bearings as possible. Extend the cloth as far as possible between the rollers.
3. With the heated rollers wiped with an ice filled cloth to loosen the particles, now, wipe clean with another cloth. Continue to wipe from the end of the rollers to the center. This will reduce the grease and partials getting into the bearings and drive mechanism. This will extend the life of the unit and extend the period between routine maintenance of the drive mechanism.

**CAUTION:** NEVER use abrasive powders or pads; these cleaners may damage the roller finish. Also, the particles may get into the drive mechanism shortening the unit life.

4. Remove the drip pan and wash it in hot, soapy water, then rinse.
5. If stains are still present, add a light detergent to the cloth and repeat.
6. Replace the pan and turn the unit off if the grill will not be immediately used.

Alternate Cleaning Method using optional 3M sponge (#21807305) and cleaning handle (#21807300):

1. Turn heat down to lower setting (i.e. "hold" temperature) and allow grill to cool.
2. If the grill has considerable grease build-up, wipe the excess grease from the rollers with a lint free towel or paper towel before using the soap and sponge.
3. Place sponge onto cleaning handle.
4. Immerse sponge in warm, soapy water.
5. Scrub rollers starting from the outside of the roller working your way to the center. Rinse sponge and re-wet with the soapy solution as needed.
6. Ensure that entire roller surface is cleaned.
7. Dry with a lint free towel or paper towel.

**NOTE:** Cleanup will be faster if the product is specifically made for cooking on roller grills. Several meat packers now offer this product.

For high-volume applications or for products that have a high sugar or fat content, the HOTROD® may require more frequent cleaning. For longer life of your HOTROD®, follow instructions for periodic cleaning throughout the day.

**PERIODIC CLEANING THROUGHOUT THE DAY:**

1. For high-volume applications or for product that has a high fat content clean the rollers every 3-4 hours.
2. Clean by removing the product from the rollers and wiping with a damp cloth from outside end of the rollers to the center. Replace the product and continue cooking. There should be no need to turn off the heat when wiping down the rollers. But care should be taken not to bring hands into direct contact with the rollers as a burn could result.

**NOTE: THIS APPLIANCE SHALL NOT BE CLEANED WITH A WATER JET.**

**SERVICE**

Service work should be performed only by a qualified technician who is experienced in and knowledgeable with the operation of commercial gas, electric, steam cooking equipment. Contact the Authorized Service Agency for reliable service, dependable advice or other assistance and for genuine factory parts.

**IF THE SUPPLY CORD IS DAMAGED, IT MUST BE REPLACED BY THE MANUFACTURER OR ITS SERVICE AGENT OR A SIMILARLY QUALIFIED PERSON IN ORDER TO AVOID A HAZARD.**

**NOTES:** \_\_\_\_\_  
\_\_\_\_\_  
\_\_\_\_\_  
\_\_\_\_\_  
\_\_\_\_\_  
\_\_\_\_\_  
\_\_\_\_\_  
\_\_\_\_\_  
\_\_\_\_\_  
\_\_\_\_\_  
\_\_\_\_\_

# PARTS LISTS & EXPLODED VIEWS

## HR-31 & 50 BW (EXPLODED VIEW)

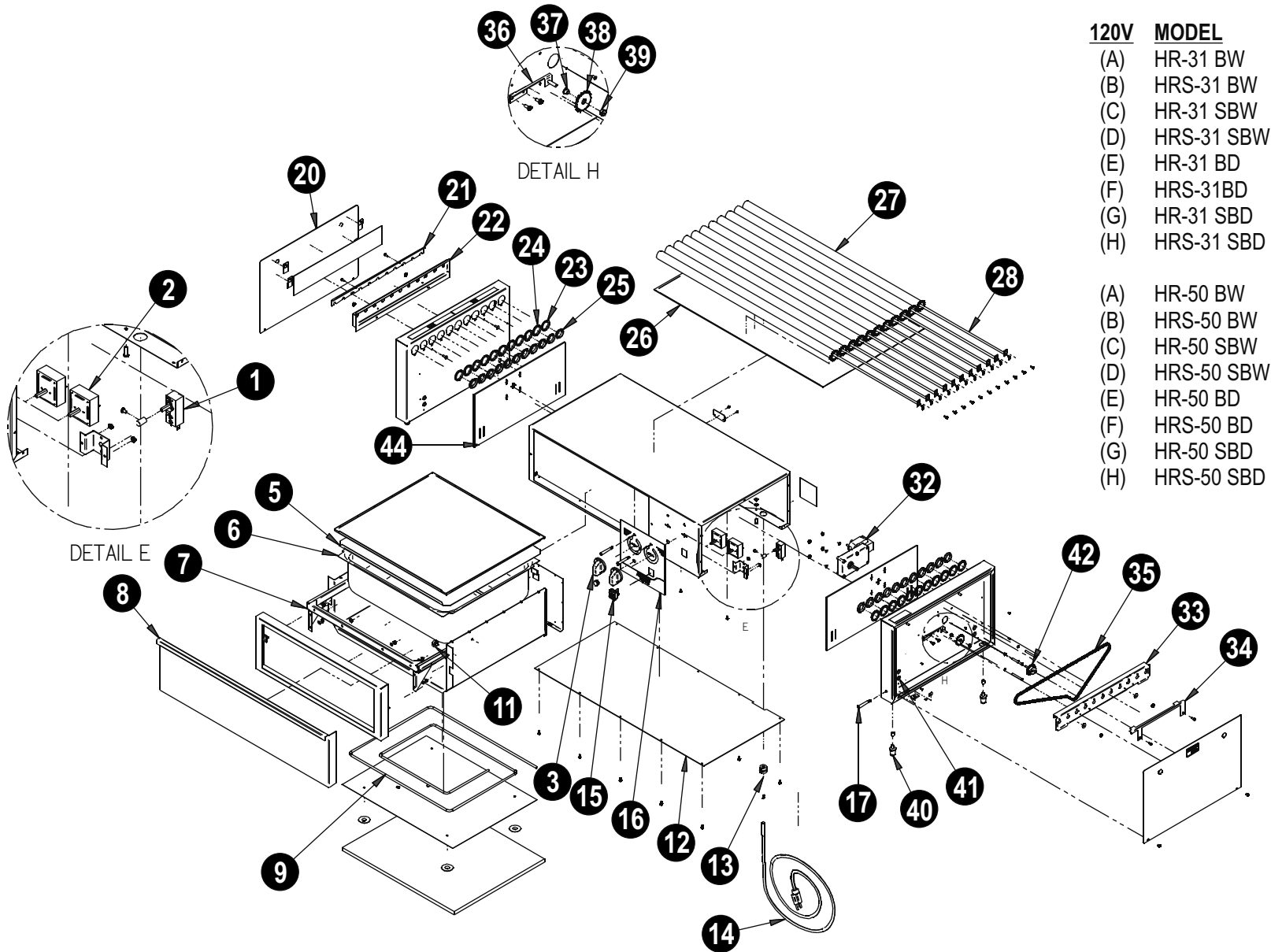

120V	MODEL	208/240V
(A)	HR-31 BW	
(B)	HRS-31 BW	
(C)	HR-31 SBW	
(D)	HRS-31 SBW	
(E)	HR-31 BD	
(F)	HRS-31BD	
(G)	HR-31 SBD	
(H)	HRS-31 SBD	
(A)	HR-50 BW	
(B)	HRS-50 BW	
(C)	HR-50 SBW	
(D)	HRS-50 SBW	
(E)	HR-50 BD	
(F)	HRS-50 BD	
(G)	HR-50 SBD	
(H)	HRS-50 SBD	



# HR-31 & 50 BC EXPLODED VIEW

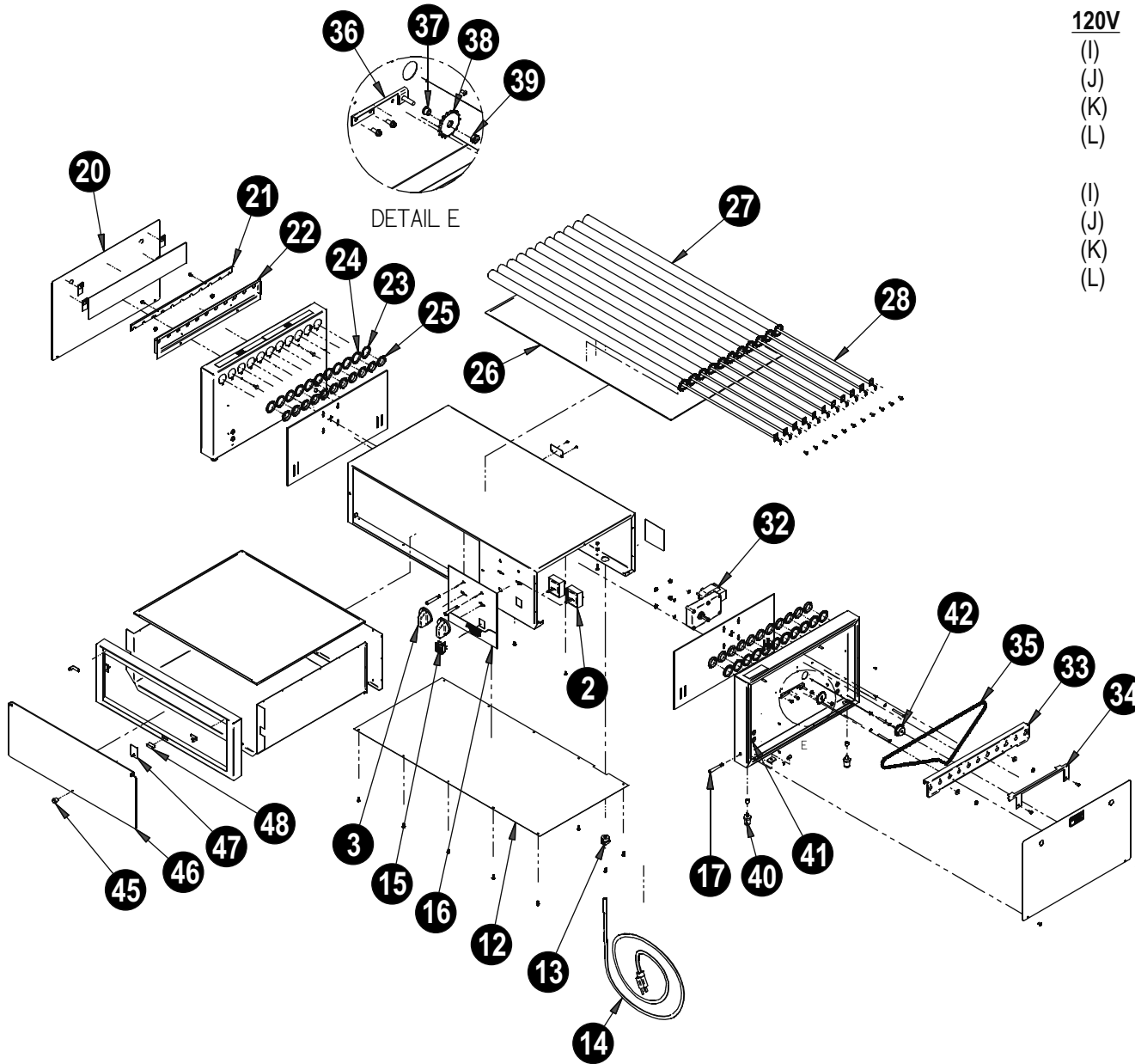

120V	MODEL	208/240V
(I)	HR-31 BC	
(J)	HRS-31 BC	
(K)	HR-31 SBC	
(L)	HRS-31 SBC	
(I)	HR-50 BC	
(J)	HRS-50 BC	
(K)	HR-50 SBC	
(L)	HRS-50 SBC	

# HR-31 & 50 EXPLODED VIEW

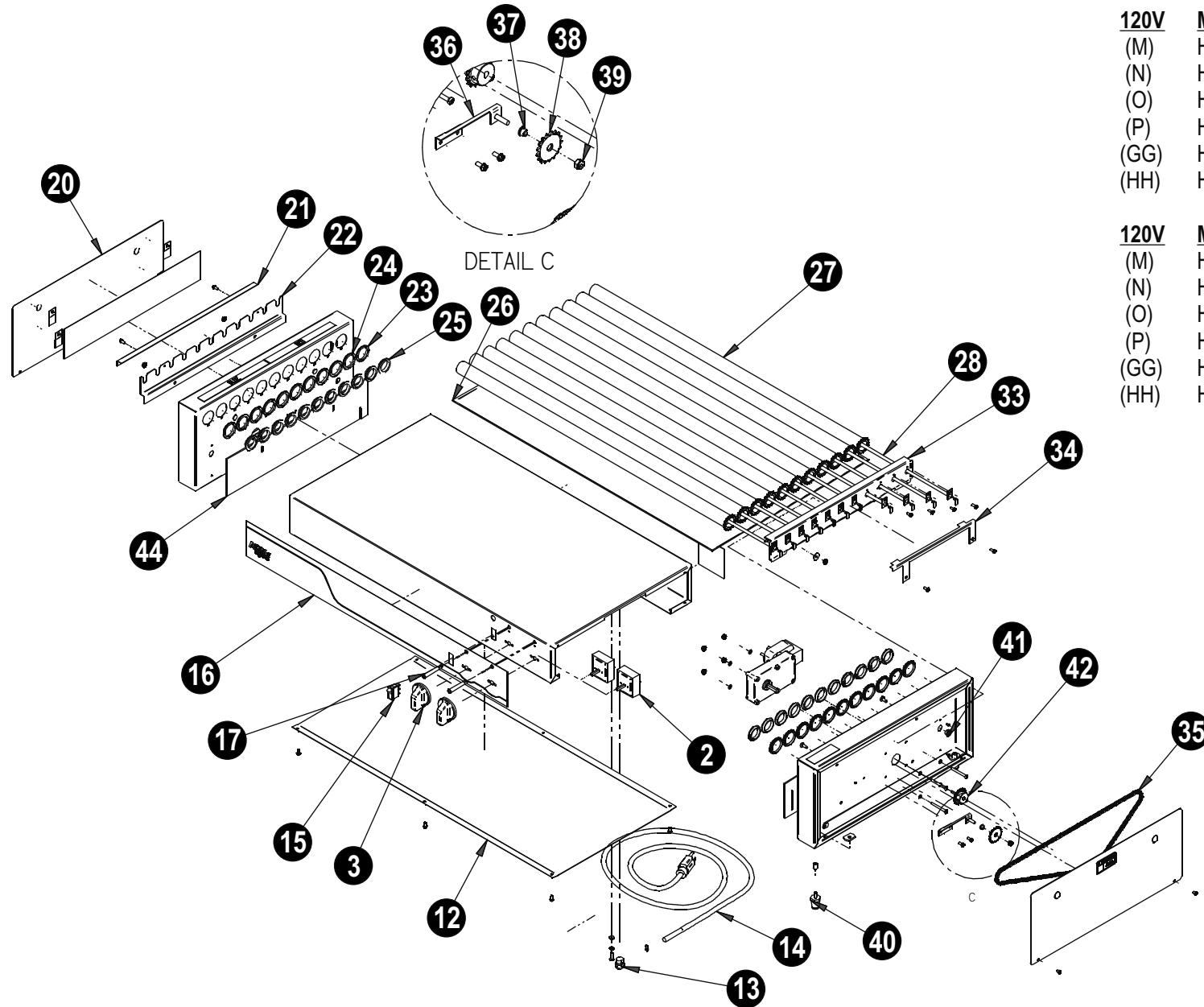

120V	MODEL	208/240
(M)	HR-31	(CC)
(N)	HRS-31	(DD)
(O)	HR-31S	(EE)
(P)	HRS-31S	(FF)
(GG)	HR-31SR	
(HH)	HRS-31SR	(JJ)

120V	MODEL	208/240
(M)	HR-50	(CC)
(N)	HRS-50	(DD)
(O)	HR-50S	(EE)
(P)	HRS-50S	(FF)
(GG)	HR-50SR	
(HH)	HRS-50SR	

# HR-31 PARTS LIST

Item	P/N	Description	Qty	Used On
1	1481510	Thermostat	1	A B C D
2	1327900	Infinite Switch	2	A B C D E F G H I J K L M N O P G G H H
2	1328200	Infinite Switch	2	CC D D E E F F J J
3	8705610	Knob	2	A B C D E F G H I J K L M N O P C C D D E E F F G G H H J J
5	21794621	Pan, Cover	1	A B C D E F G H
6	2421600	Pan, 2/3 6" Deep	1	A B C D E F G H
7	21794619	Weldm't, Drawer Frame	1	A B C D E F G H
8	21834618	Drawer, Front HR-31	1	A B C D E F G H
9	1431101	Heater, Rope 200W 120V	1	A B C D
9	1431113	Heater, Rope 200W 208V	1	
11	8641500	Bearings, Stainless Roller Slides	4	A B C D E F G H
12	21807405	Bottom, HR-31	1	A B C D E F G H I J K L
12	21771411	Bottom, HR-31	1	M N O P C C D D E E F F G G H H J J
13	8967400	Strain Relief Right Angle	1	A B C D E F G H I J K L
13	8968900	Strain Relief Right Angle	1	M N O P C C D D E E F F G G H H J J
14	1542002	Cordset, 5-15P 14/3 90C SJO	1	M N O P G G H H
14	1532500	Cordset, SJTO 16-3	1	A B C D E F G H I J K L
14	1542005	Cordset, 14/3 500C W/NEMA 6-15P	1	C C D D E E F F J J
14	782068	Cordset, 12/3 SJTOW NEMA 5-20P	1	
15	1331800	Switch Rocker	1	M N O P C C D D E E F F
15	47591400	Switch Rocker	1	A B C D E F G H I J K L G G H H J J
16	21808154	Decal, HR-31 & 45BW	1	A B C D
16	21807654	Decal, HR-31BD & BC	1	E F G H I J K L
16	8815600	Decal, HR-31 Front Panel	1	M N O P C C D D E E F F G G H H J J
17	1513903	Light, Indicator, 250V	1	A B C D E F G H I J K L
18	21797415	Panel, End L.H. Slant	1	C D G H K L
18	21749520	Panel, Left Slant HR	1	O P E E F F J J
19	21797414	Panel, End R.H. Slant	1	C D G H K L
19	21749510	Panel, Right Slant HR	1	O P E E F F J J
20	21833914	Panel, End	2	A B E F I J
20	21747001	Panel, End	2	M N C C D D G G H H
21	21794611	Heater Retainer, Front	1	A B E F I J C C D D G G H H
21	21748100	Heater Retainer, Front	1	M N O P G G H H J J
21	21795111	Heater Retainer, Front Slant	1	C D G H K L E E F F
22	21794609	Element Support	1	A B E F
22	21748000	Support, Element	1	M N C C D D G G H H
22	21794609	Support, Element	1	A B E F I J
22	21795109	Support, Element Slant	1	C D G H K L
22	21771025	Support, Element Slant	1	O P E E F F J J
23	21793400	Bearing, Hot Rod	4	A B C D E F G H I J K L M N O P C C D D E E F F G G H H J J
24	21748900	Bearing, Hot Rod	V.	A B C D E F G H I J K L M N O P C C D D E E F F G G H H J J
25	422300	Seal, Grease	V.	A B C D E F G H I J K L M N O P C C D D E E F F G G H H J J
26	21771412	Pan, Drip HR-31	1	A B C D E F G H I J K L M N O P C C D D E E F F G G H H J J
27	21771429	Roller Tube-31 Plated	V.	A C E G I K M O C C E E H H J J
27	21771418	Roller Tube-31 Xylan Coating	V.	B D F H J L N P D D F F G G
28	1431532	Element, HR-31 120V	V.	A B C D E F G H I J K L M N O P G G H H J J
28	1431533	Element, HR-31 220V, 115W	V.	C C D D E E F F
32	1212000	Motor, Gear 110V, 60HZ	1	A B C D E F G H I J K L M N O P G G H H J J
32	1211700	Motor, Gear 240V 50-60HZ	1	C C D D E E F F
33	21748303	Chain Guide Bracket	1	A B E F I J M N C C D D G G H H
33	21771016	Chain Guide Bracket	1	C D G H K L O P E E F F J J
34	21748312	Bracket, Gage	1	A B E F I J M N G G H H
34	21771017	Bracket, Gage	1	C D G H K L O P J J
35	21748505	Chain	1	A B E F I J M N C C D D G G H H
35	21748511	Chain Drive HR Slant, Wide Spacing	1	C D G H K L O P E E F F J J
36	21792309	Tensioner	1	A B C D E F G H I J K L M N O P C C D D E E F F G G H H J J
37	21792308	Bushing	1	A B C D E F G H I J K L M N O P C C D D E E F F G G H H J J
38	21748501	Sprocket	1	A B C D E F G H I J K L M N O P C C D D E E F F G G H H J J
39	8414700	Nut #10-32	1	A B C D E F G H I J K L M N O P C C D D E E F F G G H H J J
40	8662100	Leg, 1" Chrome	4	A B C D E F G H I J K L M N O P G G H H J J
41	8966400	Bushing, Snap HEYCO #2820	V.	A B C D E F G H I J K L M N O P C C D D E E F F G G H H J J
42	21748510	Sprocket, 17 Tooth w/Hub	1	A B C D E F G H I J K L M N O P C C D D E E F F G G H H J J
43	21750710	Insulation, Leftside CHAIO TAI HR	1	M N O P C C D D E E F F G G H H J J
44	21838116	Insulation, HR	2	A B C D E F G H I J K L
44	21750700	Insulation, HR Motor Side	1	M N O P C C D D E E F F G G H H J J
45	8702000	Knob, 8-32 Thread	1	I J K L
46	21794643	Door, BC-31	1	I J K L
47	21749953	Plate, Strike	1	I J K L
48	8705000	Magnet	1	I J K L

## HR-50 PARTS LIST

Item	P/N	Description	Qty	Used On
1	1481510	Thermostat	1	A B C D
2	1327900	Infinite Switch	2	A B C D E F G H I J K L M N O P GG HH JJ
2	1328200	Infinite Switch	2	CC DD EE FF
3	8705610	Knob	2	A B C D E F G H I J K L M N O P CC DD EE FF GG HH JJ
5	21794621	Pan, Cover	1	A B C D E F G H
6	2421600	Pan, 2/3 6" Deep	1	A B C D E F G H
7	21794619	Weldm't, Drawer Frame	1	
8	21834618	Drawer, Front HR-50	1	A B C D E F G H
9	1431101	Heater, Rope 200W 120V	1	A B C D
9	1431113	Heater, Rope 200W 208V	1	
11	8641500	Bearings, Stainless Roller Slides	4	A B C D E F G H
12	21807405	Bottom, HR-50	1	A B C D E F G H I J K L
12	21771411	Bottom, HR-50	1	M N O P CC DD EE FF GG HH JJ
13	8967400	Strain Relief Right Angle	1	A B C D E F G H I J K L
13	8968900	Strain Relief Right Angle	1	M N O P CC DD EE FF GG HH JJ
14	1542002	Cordset, 5-15P 14/3 90C SJO	1	M N O P GG HH
14	1532500	Cordset, SJTO 16-3	1	A B C D E F G H I J K L
14	1542005	Cordset, 14/3 500C W/NEMA 6-15P	1	CC DD EE FF JJ
14	782068	Cordset, 12/3 SJTOW NEMA 5-20P	1	
15	1331800	Switch Rocker	1	M N O P CC DD EE FF
15	47591400	Switch Rocker	1	A B C D E F G H I J K L GG HH JJ
16	21808154	Decal, HR-31 & 45BW	1	A B C D
16	21807655	Decal, HR-50BD & BC	1	E F G H I J K L
16	8816550	Decal, HR-50 Front Panel	1	M N O P CC DD EE FF GG HH JJ
17	1513903	Light, Indicator, 250V	1	A B C D E F G H I J K L
18	21797415	Panel, End L.H. Slant	1	C D GH K L
18	21749520	Panel, Left Slant HR	1	OP EE FF JJ
19	21797414	Panel, End R.H. Slant	1	C D GH K L
19	21749510	Panel, Right Slant HR	1	OP EE FF JJ
20	21833914	Panel, End	2	A B EF I J
20	21747001	Panel, End	2	M N CC DD GG HH
21	21794611	Heater Retainer, Front	1	A B EF I J CC DD GG HH
21	21748100	Heater Retainer, Front	1	M N O P GG HH JJ
21	21795111	Heater Retainer, Front Slant	1	C D GH K L EE FF
22	21794609	Element Support	1	A B EF
22	21748000	Support, Element	1	M N CC DD GG HH
22	21794609	Support, Element	1	A B EF I J
22	21795109	Support, Element Slant	1	C D GH K L
22	21771025	Support, Element Slant	1	OP EE FF JJ
23	21793400	Bearing, Hot Rod	4	A B C D E F G H I J K L M N O P CC DD EE FF GG HH JJ
24	21748900	Bearing, Hot Rod	V.	A B C D E F G H I J K L M N O P CC DD EE FF GG HH JJ
25	422300	Seal, Grease	V.	A B C D E F G H I J K L M N O P CC DD EE FF GG HH JJ
26	21748450	Pan, Drip HR-50	1	A B C D E F G H I J K L M N O P CC DD EE FF GG HH JJ
27	21752380	Roller Tube-50 Plated	V.	A C E G I K M O CC EE HH JJ
27	21752370	Roller Tube-50 Xylan Coating	V.	B D F H J L N P DD FF GG
28	1431532	Element, HR-50 120V	V.	A B C D E F G H I J K L M N O P GG HH JJ
28	1431450	Element, HR-50 220V, 115W	V.	CC DD EE FF
32	1212000	Motor, Gear 110V, 60HZ	1	A B C D E F G H I J K L M N O P GG HH JJ
32	1211700	Motor, Gear 240V 50-60HZ	1	CC DD EE FF
33	21748303	Chain Guide Bracket	1	A B EF I J MN CC DD GG HH
33	21771016	Chain Guide Bracket	1	C D GH K L OP EE FF JJ
34	21748312	Bracket, Gage	1	A B EF I J MN GG HH
34	21771017	Bracket, Gage	1	C D GH K L OP JJ
35	21748505	Chain	1	A B EF I J MN CC DD GG HH
35	21748511	Chain Drive HR Slant, Wide Spacing	1	C D GH K L OP EE FF JJ
36	21792309	Tensioner	1	A B C D E F G H I J K L M N O P CC DD EE FF GG HH JJ
37	21792308	Bushing	1	A B C D E F G H I J K L M N O P CC DD EE FF GG HH JJ
38	21748501	Sprocket	1	A B C D E F G H I J K L M N O P CC DD EE FF GG HH JJ
39	8414700	Nut #10-32	1	A B C D E F G H I J K L M N O P CC DD EE FF GG HH JJ
40	8662100	Leg, 1" Chrome	4	A B C D E F G H I J K L M N O P GG HH JJ
41	8966400	Bushing, Snap HEYCO #2820	V.	A B C D E F G H I J K L M N O P CC DD EE FF GG HH JJ
42	21748510	Sprocket, 17 Tooth w/Hub	1	A B C D E F G H I J K L M N O P CC DD EE FF GG HH JJ
43	21750710	Insulation, Leftside CHAIO TAI HR	1	M N O P CC DD EE FF GG HH JJ
44	21838116	Insulation, HR	2	A B C D E F G H I J K L
44	21750700	Insulation, HR Motor Side	1	M N O P CC DD EE FF GG HH JJ
45	8702000	Knob, 8-32 Thread	1	I J K L
46	21794643	Door, BC-50	1	I J K L
47	21749953	Plate, Strike	1	I J K L
48	8705000	Magnet	1	I J K L

HR-45, 75 & 85 EXPLODED VIEW

120V	MODEL	208/240
(M)	HR-45,75,85	(CC)
(N)	HRS-45,75,85	(DD)

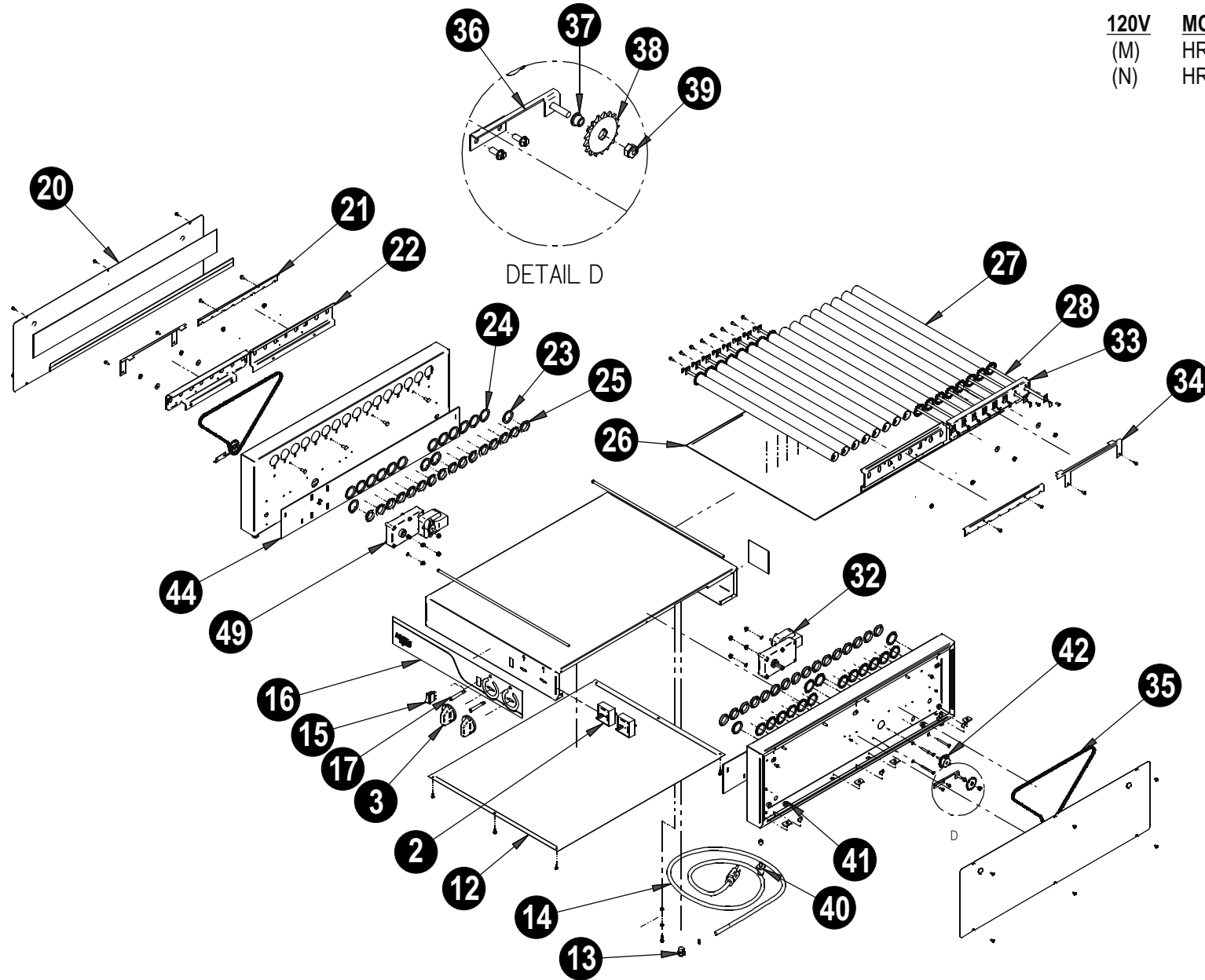

HR-45, 75 & 85 BC EXPLODED VIEW

120V	MODEL	208/240V
(I)	HR-45, 75, BC	
(J)	HRS-45, 75, BC	

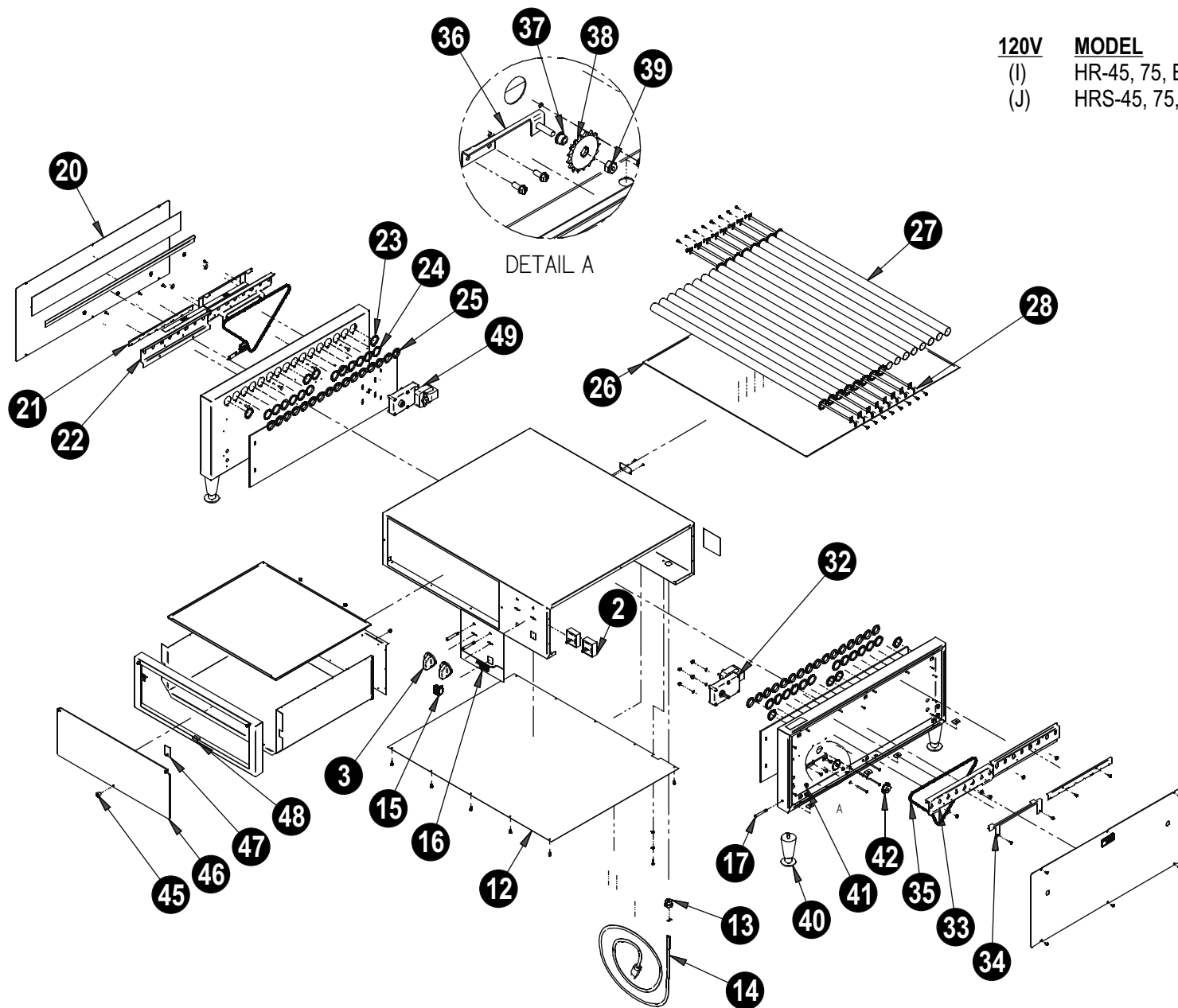

HR-45, 75 & 85 BW EXPLODED VIEW

120V	MODEL	208/240V
(A)	HR-45, 75, BW	
(B)	HRS-45, 75, BW	
(E)	HR-45, 75, BD	
(F)	HRS-45, 75, BD	

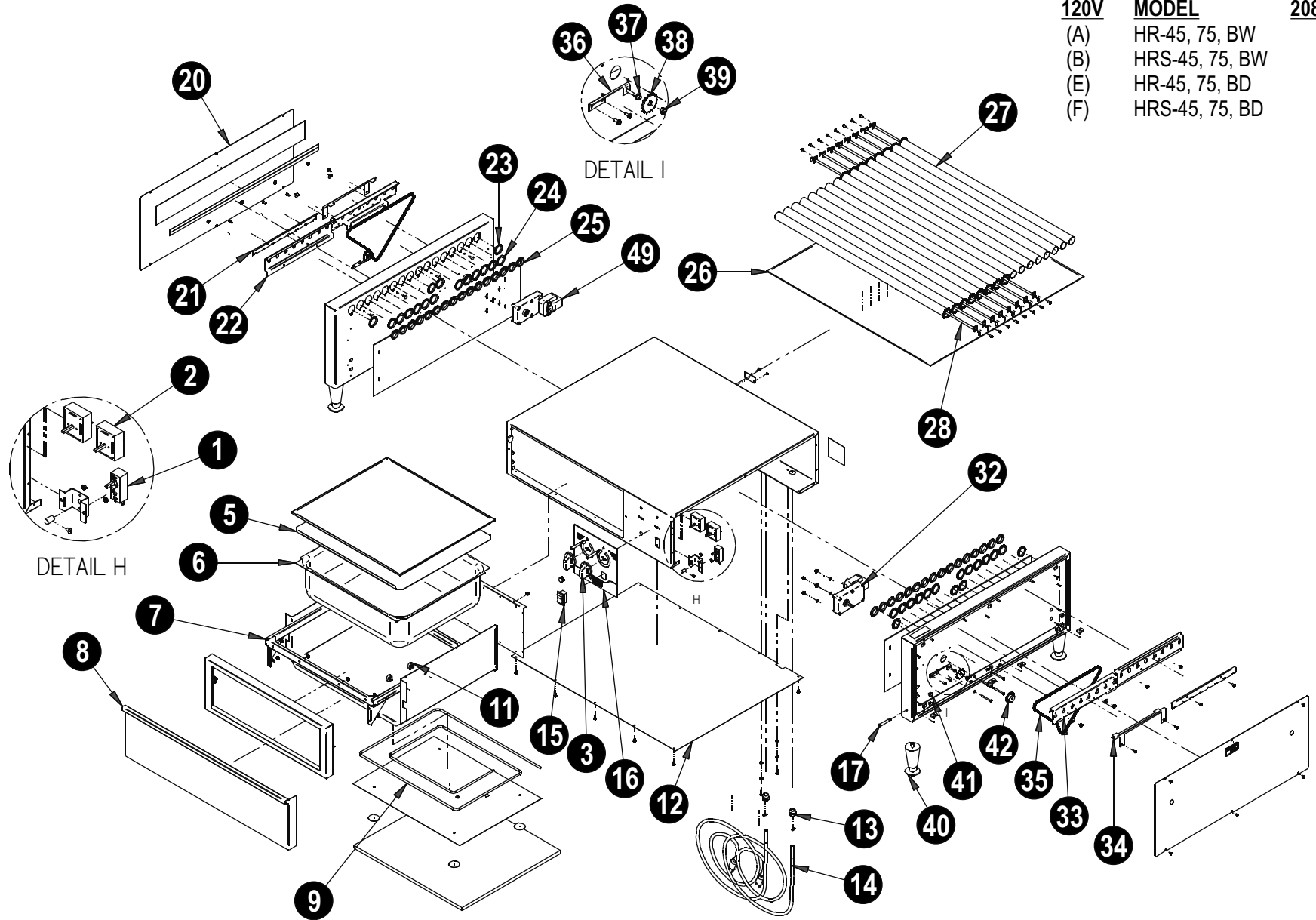

## HR-45 PARTS LIST

Item	P/N	Description	Qty	Used On
1	1481510	Thermostat	1	A B
2	1327900	Infinite Switch	2	A B I J M N
2	1328200	Infinite Switch	2	
3	8705610	Knob	2	A B I J M N
5	21794821	Pan, Cover HR-45BWE	1	A B
6	2420200	Pan, 12x20x6 Deep	1	A B
7	21794619	Weldm't, Drawer Frame	1	
8	21794818	Drawer, Front HR-45	1	A B
9	1431102	Heater, Rope, 84" 300W 120V	1	A B
9	1431113	Heater, Rope 200W 208V	1	
11	8641500	Bearings, Stainless Roller Slides	4	A B
12	21807805	Bottom, HR-45	1	A B I J
12	21771421	Bottom, HR-45	1	M N
13	8967501	Strain Relief 12/3	1	A B
13	8968900	Strain Relief Right Angle	1	I J M N
14	1542002	Cordset, 5-15P 14/3 90C SJO	1	I J M N
14	1532500	Cordset, SJTO 16-3	1	
14	1542005	Cordset, 14/3 500C W/NEMA 6-15P	1	
14	782068	Cordset, 12/3 SJTOW NEMA 5-20P	1	A B
15	1331800	Switch Rocker	1	M N
15	47591400	Switch Rocker	1	A B I J
16	21808154	Decal, HR-45BW	1	A B
16	21807654	Decal, HR-31BD & BC	1	I J
16	8815600	Decal, HR-31 Front Panel	1	M N
17	1513903	Light, Indicator, 250V	1	A B I J
20	21807814	Panel, End	2	A B I J
20	21752465	Panel, End	2	M N
21	21792239	Heater Retainer, Front	1	A B I J M N
21	21748100	Heater Retainer, Front	1	
22	21792234	Element Support	1	A B I J M N
22	21807888	Support, Element Rope Heater	1	
22	21794609	Support, Element	1	
23	21793400	Bearing, Hot Rod	4	A B I J M N
24	21748900	Bearing, Hot Rod	V.	A B I J M N
25	422300	Seal, Grease	V.	A B I J M N
26	21771420	Pan, Drip HRS-45	1	A B I J M N
27	21771429	Roller Tube-31 Plated	V.	A I M
27	21771418	Roller Tube-31 Xylan Coating	V.	B J N
28	1431532	Element, HR-31 120V	V.	A B I J M N
32	1212000	Motor, Gear 110V, 60HZ	1	A B I J M N
32	1211700	Motor, Gear 240V 50-60HZ	1	
33	21792336	Chain Guide Bracket	1	A B I J M N
33	21771016	Chain Guide Bracket	1	
34	21748312	Bracket, Gage	1	A B I J M N
34	21771017	Bracket, Gage	1	
35	21792251	Chain	1	A B I J M N
36	21792309	Tensioner	1	A B I J M N
37	21792308	Bushing	1	A B I J M N
38	21748501	Sprocket	1	A B I J M N
39	8414700	Nut #10-32	1	A B I J M N
40	8662100	Leg, 1" Chrome	4	A B I J M N
41	8966400	Bushing, Snap HEYCO #2820	V.	A B I J M N
42	21748510	Sprocket, 17 Tooth w/Hub	1	A B I J M N
43	21750710	Insulation, HR-45-75-85	1	M N
44	21807816	Insulation, HR Right Side	1	A B I J
44	21807817	Insulation, HR Left Side	1	A B I J
45	8702000	Knob, 8-32 Thread	1	I J
46	21794643	Door, BC-31	1	I J
47	21749953	Plate, Strike	1	I J
48	8705000	Magnet	1	I J
49	1212300	Motor, Gear 110V, 60HZ	1	A B I J M N



## HR-75 PARTS LIST

Item	P/N	Description	Qty	Used On
1	1481510	Thermostat	1	A B
2	1327900	Infinite Switch	2	A B I J M N
2	1328200	Infinite Switch	2	CC DD
3	8705610	Knob	2	A B I J M N CC DD
5	21792221	Pan, Cover HR-45BWE	1	A B
6	2421401	Pan, Modified	1	A B
7	21794619	Weldm't, Drawer Frame	1	
8	21833918	Drawer, Front	1	A B
9	1431105	Heater, Rope, 108" 400W 120V	1	A B
9	1431113	Heater, Rope 200W 208V	1	
11	8641500	Bearings, Stainless Roller Slides	4	A B
12	21792205	Bottom Cover	1	A B I J
12	21771461	Bottom Cover	1	M N CC DD
13	8968900	Strain Relief 90 deg	1	CC DD
13	8967500	Strain Relief 14/3	1	A B
13	8967501	Strain Relief 12/3	1	I J
13	8967400	Strain Relief	1	M N
14	1542002	Cordset, 5-15P 14/3 90C SJO	1	
14	1532500	Cordset, SJTO 16-3	1	M N
14	1542005	Cordset, 14/3 500C W/NEMA 6-15P	1	CC DD
14	1537000	Cordset, 14-3 NEMA 5-15P	1	A B
14	782068	Cordset, 12/3 SJTO W/NEMA 5-20P	1	I J
15	1331800	Switch Rocker	1	M N CC DD
15	47591400	Switch Rocker	1	A B I J
16	21808155	Decal, HR-50BW	1	A B
16	21807655	Decal, HR-50BC	1	I J
16	8816550	Decal, HR-50 Front Panel	1	M CC DD
17	1513903	Light, Indicator, 250V	1	A B I J M CC DD
20	21807814	Panel, End	2	A B I J
20	21752465	Panel, End	2	M CC DD
21	21792239	Heater Retainer, Front	1	A B I J M CC DD
21	21748100	Heater Retainer, Front	1	
22	21792234	Element Support	1	A B I J M CC DD
22	21807888	Support, Element Rope Heater	1	
22	21794609	Support, Element	1	
23	21793400	Bearing, Hot Rod	4	A B I J M CC DD
24	21748900	Bearing, Hot Rod	V.	A B I J M CC DD
25	422300	Seal, Grease	V.	A B I J M CC DD
26	21752488	Pan, Drip	1	A B I J M CC DD
27	21752380	Roller Tube-31 Plated	V.	A I M CC
27	21752370	Roller Tube-31 Xylan Coating	V.	B J DD
28	1431550	Element, HR-50 120V	V.	A B I J M
32	1212000	Motor, Gear 110V, 60HZ	1	A B I J M
32	1211700	Motor, Gear 240V 50-60HZ	1	CC DD
33	21792336	Chain Guide Bracket	1	A B I J M CC DD
33	21771016	Chain Guide Bracket	1	
34	21748312	Bracket, Gage	1	A B I J M
34	21771017	Bracket, Gage	1	
35	21792251	Chain Drive 33-3/4" J36P	1	A B I J M CC DD
36	21792309	Tensioner	1	A B I J M CC DD
37	21792308	Bushing	1	A B I J M CC DD
38	21748501	Sprocket	1	A B I J M CC DD
39	8414700	Nut #10-32	1	A B I J M CC DD
40	8632000	Leg, 4" ADJ, 2000 lb Cap	4	A B I J M
40	8662100	Leg, 1" Chrome	4	M CC DD
41	8966400	Bushing, Snap HEYCO #2820	V.	A B I J M CC DD
42	21748510	Sprocket, 17 Tooth w/Hub	1	A B I J M CC DD
43	21750715	Insulation, HR-45-75-85	1	M CC DD
44	21807816	Insulation, HR Right Side	1	A B I J
44	21807817	Insulation, HR Left Side	1	A B I J
45	8702000	Knob, 8-32 Thread	1	I J
46	21795618	Bun Cabinet Door	1	I J
47	21749953	Plate, Strike	1	I J
48	8705000	Magnet	1	I J
49	1211800	Motor, Gear 240V 50-60HZ	1	CC DD
49	1212300	Motor, Gear 110V, 60HZ	1	A B I J M

## HR-85 PARTS LIST

Item	P/N	Description	Qty	Used On
1	1481510	Thermostat	1	
2	1327900	Infinite Switch	2	
2	1328200	Infinite Switch	2	CC DD
3	8705610	Knob	2	CC DD
5	21792221	Pan, Cover HR-45BWE	1	
6	2421401	Pan, Modified	1	
7	21794619	Weldm't, Drawer Frame	1	
8	21833918	Drawer, Front	1	
9	1431105	Heater, Rope, 108" 400W 120V	1	
9	1431113	Heater, Rope 200W 208V	1	
11	8641500	Bearings, Stainless Roller Slides	4	
12	21792205	Bottom Cover	1	
12	21771461	Bottom Cover	1	CC DD
13	8968900	Strain Relief 90 deg	1	CC DD
13	8967500	Strain Relief 14/3	1	
13	8967501	Strain Relief 12/3	1	
13	8967400	Strain Relief	1	
14	1542002	Cordset, 5-15P 14/3 90C SJO	1	
14	1532500	Cordset, SJTO 16-3	1	
14	1542005	Cordset, 14/3 500C W/NEMA 6-15P	1	CC DD
14	1537000	Cordset, 14-3 NEMA 5-15P	1	
14	782068	Cordset, 12/3 SJTOW NEMA 5-20P	1	
15	1331800	Switch Rocker	1	CC DD
15	47591400	Switch Rocker	1	
16	21808155	Decal, HR-50BW	1	
16	21807655	Decal, HR-50BC	1	
16	8816550	Decal, HR-50 Front Panel	1	CC DD
17	1513903	Light, Indicator, 250V	1	CC DD
20	21807814	Panel, End	2	
20	21752465	Panel, End	2	CC DD
21	21778135	Heater Retainer, Front	1	CC DD
21	21748100	Heater Retainer, Front	1	
22	21778134	Element Support	1	CC DD
22	21807888	Support, Element Rope Heater	1	
22	21794609	Support, Element	1	
23	21793400	Bearing, Hot Rod	4	CC DD
24	21748900	Bearing, Hot Rod	V.	CC DD
25	422300	Seal, Grease	V.	CC DD
26	21752488	Pan, Drip	1	CC DD
27	21752380	Roller Tube-31 Plated	V.	CC
27	21752370	Roller Tube-31 Xylan Coating	V.	DD
28	1431550	Element, HR-50 120V	V.	
32	1212000	Motor, Gear 110V, 60HZ	1	
32	1211700	Motor, Gear 240V 50-60HZ	1	CC DD
33	21832492	Chain Guide Bracket, HR-85	1	CC DD
33	21771016	Chain Guide Bracket	1	
34	21748312	Bracket, Gage	1	
34	21771017	Bracket, Gage	1	
35	21748507	Chain Drive 34-1/2" J38P	1	CC DD
36	21792309	Tensioner	1	CC DD
37	21792308	Bushing	1	CC DD
38	21748501	Sprocket	1	CC DD
39	8414700	Nut #10-32	1	CC DD
40	8632000	Leg, 4" ADJ, 2000 lb Cap	4	
40	8662100	Leg, 1" Chrome	4	CC DD
41	8966400	Bushing, Snap HEYCO #2820	V.	CC DD
42	21748510	Sprocket, 17 Tooth w/Hub	1	CC DD
43	21750715	Insulation, HR-45-75-85	1	CC DD
44	21807816	Insulation, HR Right Side	1	
44	21807817	Insulation, HR Left Side	1	
45	8702000	Knob, 8-32 Thread	1	
46	21795618	Bun Cabinet Door	1	
47	21749953	Plate, Strike	1	
48	8705000	Magnet	1	
49	1211800	Motor, Gear 240V 50-60HZ	1	CC DD
49	1212300	Motor, Gear 110V, 60HZ	1	

# WIRING DIAGRAMS

## MODEL INCLUDE ALL HR-31 AND 50

(View with unit upside down, looking from the back.)

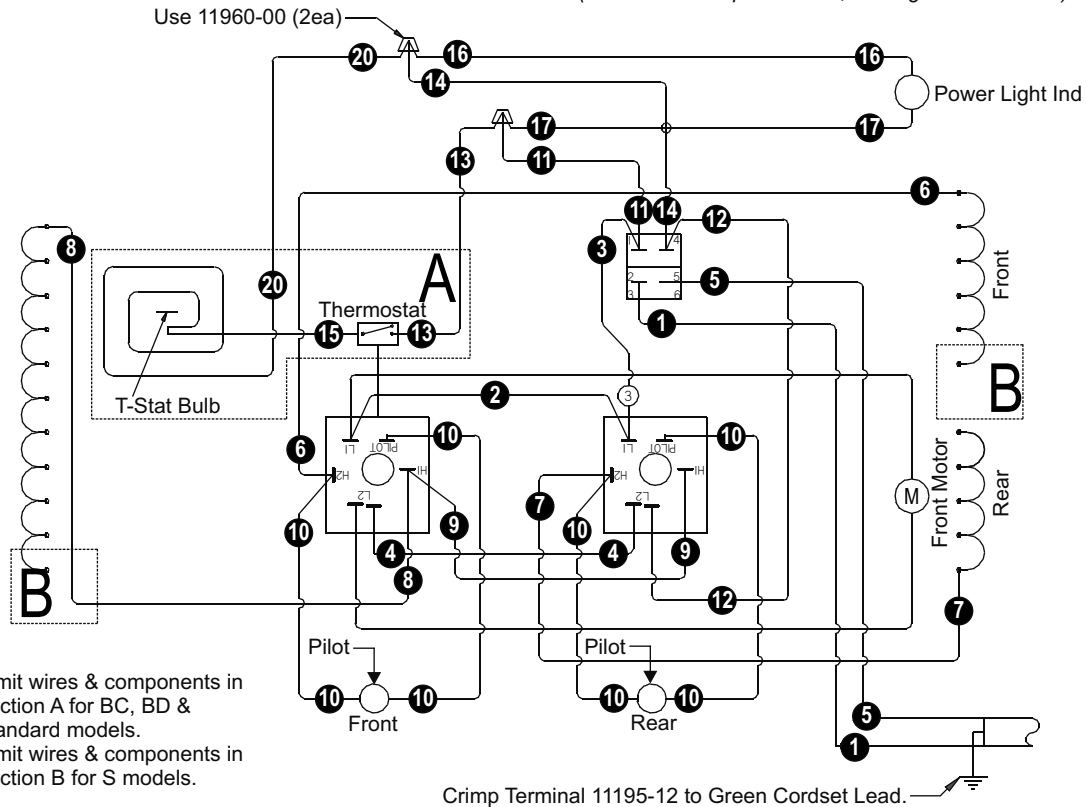

**NOTE:**

1. Omit wires & components in section A for BC, BD & standard models.
2. Omit wires & components in section B for S models.

## MODEL INCLUDE ALL HR-45, 75 AND 85

(View with unit upside down, looking from the back.)

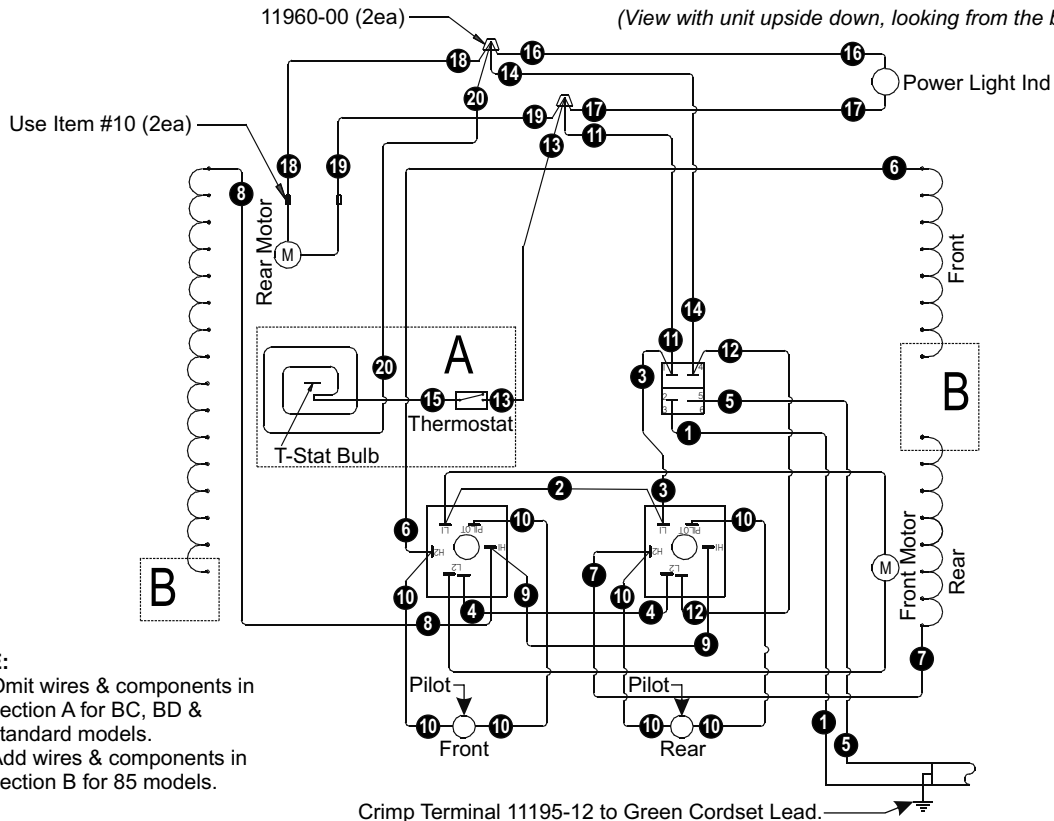

**NOTE:**

1. Omit wires & components in section A for BC, BD & standard models.
2. Add wires & components in section B for 85 models.

## APW WYOTT EQUIPMENT LIMITED WARRANTY

APW Wyott Foodservice Equipment Company warrants its equipment against defects in materials and workmanship, subject to the following conditions:

This warranty applies to the original owner only and is not assignable.

Should any product fail to function in its intended manner under normal use within the limits defined in this warranty, at the option of APW Wyott such product will be repaired or replaced by APW Wyott or its Authorized Service Agency. APW Wyott will only be responsible for charges incurred or service performed by its Authorized Service Agencies. The use of other than APW Wyott Authorized Service Agencies will void this warranty and APW Wyott will not be responsible for such work or any charges associated with same. The closest APW Wyott Authorized Service Agent must be used.

This warranty covers products shipped into the 48 contiguous United States, Hawaii, metropolitan areas of Alaska and Canada. There will be no labor coverage for equipment located on any island not connected by roadway to the mainland.

Warranty coverage on products used outside the 48 contiguous United States, Hawaii, and metropolitan areas of Alaska and Canada may vary. Contact the international APW Wyott distributor, dealer, or service agency for details.

### Time Period

One year for parts and one year for labor, effective from the date of purchase by the original owner. The Authorized Service Agency may, at their option, require proof of purchase. Parts replaced under this warranty are warranted for the un-expired portion of the original product warranty only.

### Exceptions

- \***Gas/Electric Cookline:** Models GCB, GCRB, GF, GGM, GGT, CHP-H, EF, EG, EHP. Three (3) Year Warranty on all component parts, except switches and thermostats. (2 additional years on parts only. No labor on second or third year.)
- \***Broiler Briquettes, Rock Grates, Cooking Grates, Burner Shields, Fireboxes:** 90 Day Material Only. No Labor.
- \***Heat Strips:** Models FD, FDL, FDD, FDDL. Two (2) Year Warranty on element only. No labor second year.
- \***Glass Windows, Doors, Seals, Rubber Seals, Light Bulbs:** 90 Day Material Only. No Labor.

In all cases, parts covered by extended warranty will be shipped FOB the factory after the first year.

### Portable Carry In Products

Equipment weighing over 70 pounds or permanently installed will be serviced on-site as per the terms of this warranty. Equipment weighing 70 pounds or under, and which is not permanently installed, i.e. with cord and plug, is considered portable and is subject to the following warranty handling limitations. If portable equipment fails to operate in its intended manner on the first day of connection, or use, at APW Wyott's option or its Authorized Service Agency, it will be serviced on site or replaced.

From day two through the conclusion of this warranty period, portable units must be taken to or sent prepaid to the APW Wyott Authorized Service Agency for in-warranty repairs. No mileage or travel charges are allowed on portable units after the first day of use. If the customer wants on-site service, they may receive same by paying the travel and mileage charges. Exceptions to this rule: (1) countertop warmers and cookers, which are covered under the Enhanced Warranty Program, and (2) toasters or rollergrills which have in store service.

### Exclusions

The following conditions are not covered by warranty:

- \*Equipment failure relating to improper installation, improper utility connection or supply and problems due to ventilation.
- \*Equipment that has not been properly maintained, calibration of controls, adjustments, damage from improper cleaning and water damage to controls.
- \*Equipment that has not been used in an appropriate manner, or has been subject to misuse or misapplication, neglect, abuse, accident, alteration, negligence, damage during transit, delivery or installation, fire, flood, riot or act of god.
- \*Equipment that has the model number or serial number removed or altered.

If the equipment has been changed, altered, modified or repaired by other than an Authorized Service Agency during or after the warranty period, then the manufacturer shall not be liable for any damages to any person or to any property, which may result from the use of the equipment thereafter.

This warranty does not cover services performed at overtime or premium labor rates. Should service be required at times which normally involve overtime or premium labor rates, the owner shall be charged for the difference between normal service rates and such premium rates. APW Wyott does not assume any liability for extended delays in replacing or repairing any items beyond its control.

In all cases, the use of other than APW Wyott Authorized OEM Replacement Parts will void this warranty.

This equipment is intended for commercial use only. Warranty is void if equipment is installed in other than commercial application.

### Water Quality Requirements

Water supply intended for a unit that has in excess of 3.0 grains of hardness per gallon (GPG) must be treated or softened before being used. Water containing over 3.0 GPG will decrease the efficiency and reduce the operation life of the unit.

**Note: Product failure caused by liming or sediment buildup is not covered under warranty.**

**“THE FOREGOING WARRANTY IS IN LIEU OF ANY AND ALL OTHER WARRANTIES EXPRESSED OR IMPLIED INCLUDING ANY IMPLIED WARRANTY OF MERCHANTABILITY OR FITNESS FOR PARTICULAR PURPOSES AND CONSTITUTES THE ENTIRE LIABILITY OF APW WYOTT. IN NO EVENT DOES THE LIMITED WARRANTY EXTEND BEYOND THE TERMS STATED HEREIN.”**

9/05