

**INSTALLATION
AND
OPERATING
INSTRUCTIONS**

TORTILLA GRILL

MODEL: TG-2025

! NOTICE: This product is intended for commercial use only. Not for household use. **!**

! WARNING: Improper installation, operation, service or maintenance can cause property damage, injury or death. Read and understand these instructions thoroughly before positioning, installing, maintaining or servicing this equipment. **!**

IMPORTANT FOR FUTURE REFERENCE

Please complete this information and retain this manual for the life of the equipment. For Warranty Service and/or Parts, this information is required.

_____ Model Number

_____ Serial Number

_____ Date Purchased



ANSI/NSF4

P/N 8832200 8/07

APW WYOTT Foodservice Equipment Company

P.O. Box 1829
Cheyenne, WY 82003

+1 (307) 634-5801 Phone
+1 (307) 637-8071 Fax

+1 (800) 752-0863 Toll Free
www.apwwyott.com

TABLE OF CONTENTS:

ITEM	PAGE	ITEM	PAGE
Safety Precautions	2	Cleaning	5
Owners Information	3	Troubleshooting	5
Warranty Information	3	Preventative Maintenance Schedule	6
Specifications	3	Wiring Diagram	6
Installation Instructions	4	Parts List w/Exploded View	7
Operation	4	Warranty	8

Congratulations on your purchase of APW Wyott commercial cooking or refrigeration equipment. APW Wyott takes pride in the design and quality of our products. When used as intended and with proper care and maintenance, you will experience years of reliable operation from this equipment. To ensure best results, it is important that you read and follow the instructions in this manual carefully.

IMMEDIATELY INSPECT FOR SHIPPING DAMAGE

All containers should be examined for damage before and during unloading. The freight carrier has assumed responsibility for its safe transit and delivery. If equipment is received damaged, either apparent or concealed, a claim must be made with the delivering carrier.



A) Apparent damage or loss must be noted on the freight bill at the time of delivery. It must then be signed by the carrier representative (Driver). If this is not done, the carrier may refuse the claim. The carrier can supply the necessary forms.



B) Concealed damage or loss if not apparent until after equipment is uncrated, a request for inspection must be made to the carrier within 15 days. The carrier should arrange an inspection. Be certain to hold all contents and packaging material.



Installation and start-up should be performed by a qualified installer who thoroughly read, understands and follows these instruction.



If you have questions concerning the installation, operation, maintenance or service of this product, write Technical Service Department APW Wyott Foodservice Equipment Company, P.O. Box 1829, Cheyenne, WY 82003.



SAFETY PRECAUTIONS

 **DANGER:** This symbol warns of imminent hazard which will result in serious injury or death. 

 **WARNING:** This symbol refers to a potential hazard or unsafe practice, which could result in serious injury or death. 

 **CAUTION:** This symbol refers to a potential hazard or unsafe practice, which may result in minor or moderate injury or product or property damage. 

 **NOTICE:** This symbol refers to information that needs special attention or must be fully understood even though not dangerous. 

 **CAUTION:** APW Wyott equipment is designed, built, and sold for commercial use and should be operated by trained personnel only. Clearly post all CAUTIONS, WARNINGS and OPERATING INSTRUCTIONS near each unit to insure proper operation and to reduce the chance of personal injury and/or equipment damage. This product is used for the hot holding of food products only. 

WARNING: Always disconnect power before servicing the unit. Surfaces will remain hot after power has been turned off. Allow unit to cool before cleaning or servicing. Never clean the unit by immersing it in water. The unit is not protected against water jets; **DO NOT CLEAN DRYWELL WITH A WATER JET.** Always clean equipment properly before first use.

OWNER'S INFORMATION

General Information:

1. Always clean equipment thoroughly before first use. (See general cleaning instructions).
2. Check rating label for your model designation and electrical rating.

General Operation Instructions:

1. All foodservice equipment should be operated by trained personnel.
2. Do not allow your customers to come in contact with any surface labeled "CAUTION HOT".
3. Never touch Grill platen or body while operating.

WARRANTY INFORMATION

Reliability Backed By APW Wyott's Warranty:

All APW Wyott Countertop Tortilla Grills are backed by a one year parts and labor warranty, including On-Site Service calls within 50 miles of authorized service technicians.

Service Information: Service Hotline (800) 733-2203

SPECIFICATIONS

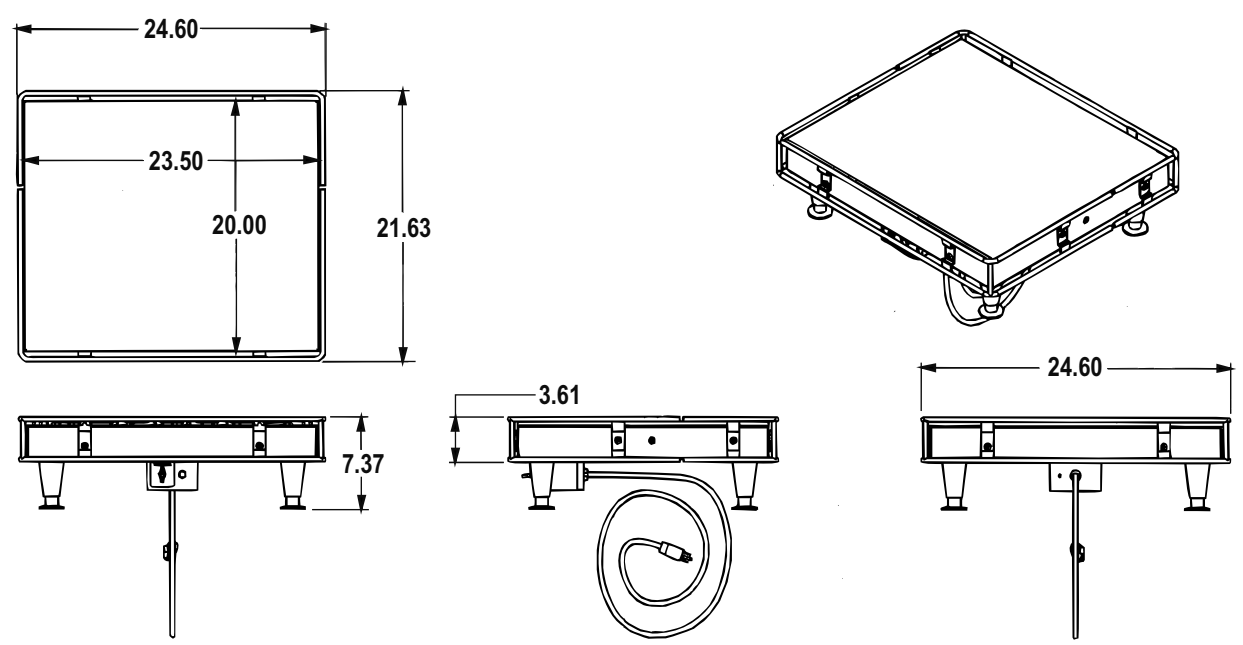

Dimensions:	TG-2025 Tortilla Grill:	25.50" W x 21.00" D x 3.13" H
Electrical Ratings for Grills:	TG-2025 Tortilla Grill:	1200W, 208V, 5.7A, Single Phase 1600W, 240V, 6.7A, Single Phase
Power Cord:	6' power cord with NEMA6-15P plug.	
Shipping Weight:	TG-2025 Tortilla Grill:	79 lbs. (174kg)



INSTALLATION INSTRUCTIONS

If the carton appears damaged, or damage is discovered once the carton is opened, stop immediately and contact the freight company to file a damage claim.

1. Remove all external packaging that is protecting unit.
2. Remove unit from shipping container. The unit can be lifted and positioned in place on a countertop. Face the controls toward the operator. Note: Do not bend or scratch the heating surface.
3. Remove all packaging from the unit.
4. Visually inspect the unit for damage.
5. **Stainless Steel:** To remove normal dirt or product residue from stainless steel, use ordinary soap and water with or without detergent applied with a sponge or cloth. Dry thoroughly with a clean cloth. Never use corrosive cleaner. **Do not use chlorine-based cleaners.**

 **CAUTION:** Use only non-abrasive cleaners. Abrasive cleaners could scratch the finish of your unit, marring it's appearance and making it susceptible to dirt accumulation. Do Not use steel wool, other abrasive cleaners or cleaners/sanitizers containing chlorine, iodine, ammonia or bromine chemicals as these will deteriorate the stainless steel and Hard Anodized heated surface and shorten the life of the unit. 

6. Place unit in operating location. Make sure that the operating location is in an area where the ambient temperature is held constant (minimum 70°F). Please avoid areas such as near exhaust fans and air conditioning ducts. Support arms are used to weld to existing structure. Ensure that Grill is level, left to right & front to back.

OPERATION

1. The switch that operates the grill is located on the control box on the bottom of the unit.
2. The On/Off switch is used to turn the unit on or off. Once the unit is turned on, adjust the temperature using the thermostat to the desired temperature up to a maximum of 450°F.
3. **Note:** Before touching the On/Off button, please read the following statements: The unit's external surface temperatures will be hot. Use caution when touching these areas to avoid injury.
4. The Grill has one thermostat with it's bulb located in the center of the heated surface.

 **WARNING: External Surface Temperatures could cause Severe Burns. Do not touch platen or fins once power is applied.** 

Control Operation

This Grill has one heated zone and is operated by a toggle switch and controlled by a thermostat. The switch has ON/OFF on the label. The thermostat has an international increase symbol.

CLEANING

Procedure Frequency:



Daily at Closing



Supplies:



● Soap and Warm Water



● Food Service Towels

● Grill Pad

 **WARNING:** DO NOT immerse GRILL assembly or platen in water. 

 **CAUTION:** Use only non-abrasive cleaners. Abrasive cleaners could scratch the finish of your unit, marring it's appearance and making it susceptible to dirt accumulation. Do Not use steel wool, other abrasive cleaners or cleaners/sanitizers containing chlorine, iodine, ammonia or bromine chemicals as these will deteriorate the stainless steel and glass material and shorten the life of the unit. 

 **WARNING:** DO NOT touch heated surfaces of the grill. 

 **WARNING:** DO NOT use unapproved abrasive pads or cleaning solutions. 

Procedure (Daily):

1. Turn off Grill and allow time for cooling.

NOTE: DO NOT add ice or water to the Grill surface to accelerate cooling, this can damage the heated surface. Allow time for heated surface to cool.

2. Dampen a cloth with soapy water and/or non-abrasive cleaner.
3. Apply the damp cloth to the heated surface and stainless steel trim, but do not pour soapy water onto heated surface.

NOTE: Typical cleaning should require small amount of non-abrasive cleaner.

4. Apply adequate pressure to the damp cloth to remove soil; hard scrubbing is not necessary.
5. Wet a clean towel and ring out the excess water in sink or bucket.
6. Wipe heated surface with damp towel to remove left over soap, non-abrasive cleanser and soil from heated surface and stainless steel trim.
7. Rinse the towel and wipe the heated surface again until heated surface is absolutely clean.

TROUBLESHOOTING

Always ask and check the following:

Not getting power:

1. Is the unit connected to a live power source of the proper voltage?
2. Check the rating label. Is the unit connected to the correct power source?
3. Check the circuit breaker.
4. Is power switch "ON"?
5. If the above checks out, and you still have problems, call your local service agent.

PREVENTATIVE MAINTENANCE SCHEDULE

Please follow the cleaning section for the daily preventative maintenance schedule.

- ➔ DO NOT USE ABRASIVES OR CLEANING SOLUTIONS ON THIS APPLIANCE.
- ➔ DO NOT IMMERSE THE GRILL IN WATER.
- ➔ DO NOT ATTEMPT TO MAINTENANCE, OR SERVICE THE UNDERSIDE OF THE GRILL.

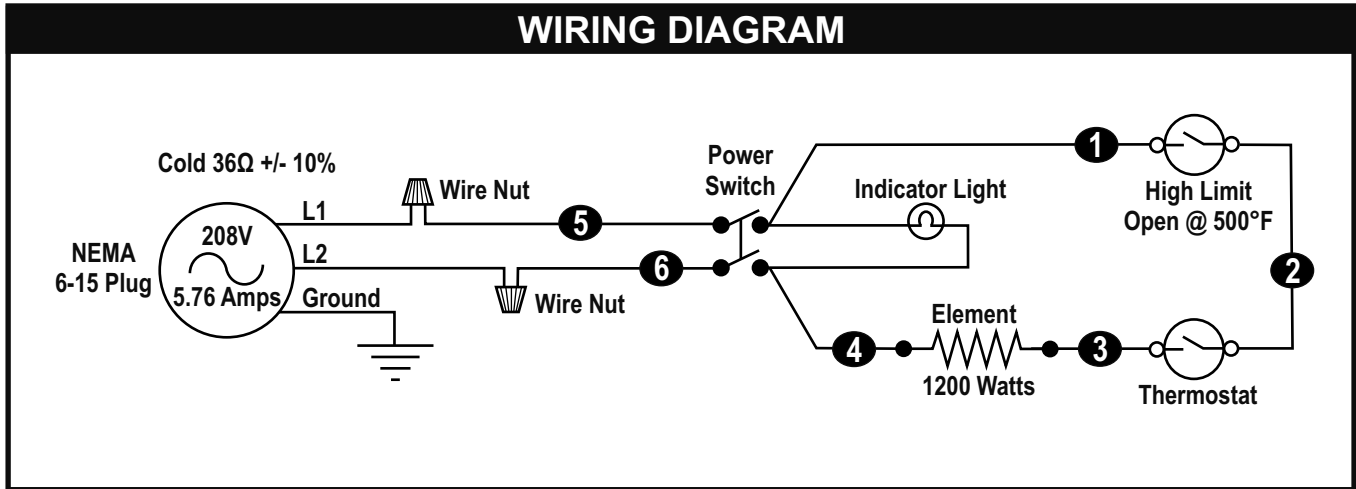

PARTS LIST w/EXPLODED VIEW

ITEM	P/N	DESCRIPTION	QUAN
1	4881545	Plate, 20 x 23.5 x I Line Grill	1
2	4881810	W/Assy, Main Frame	1
3	4881815	Bottom, Counter Grill	1
4	4881557	Gasket	1
5	4881538	Label, On/Off	1
6	1302900	Switch, On/Off 30 Amp DPST	1
7	4881541	Switch, High Limit	1
8	4881562	Weldment, Burn Guard	1
9	4881558	Clip, Element	34
10	4881598	Element, I Line Grill 208V	1
11	1489100	Thermostat, Snap Action Open 450°F	1
12	4881519	Cover, Thermostat	1
13	4881513	Insulation, .250 Pyrogel	2
14	4881512	Insulation, Super Wool 2"	1
15	4881820	Weldment, Burn Guard	1
16	8632000	Leg, 4" Adj. 2000 Lb Capacity	4
17	21806250	Box, Switch & Light	1
18	1531900	Cordset, NEMA 6-15P Type SO, 600V, 90°C	1
19	45653000	Light, Indicator 250V, Ø 1/2" Amber	1
20	8967500	Strain Relief, 14/3	1
21	8969600	Bushing, Snap, Heyco	1
22	1487101	Thermostat	1
23	8705508	Knob, Thermostat	1

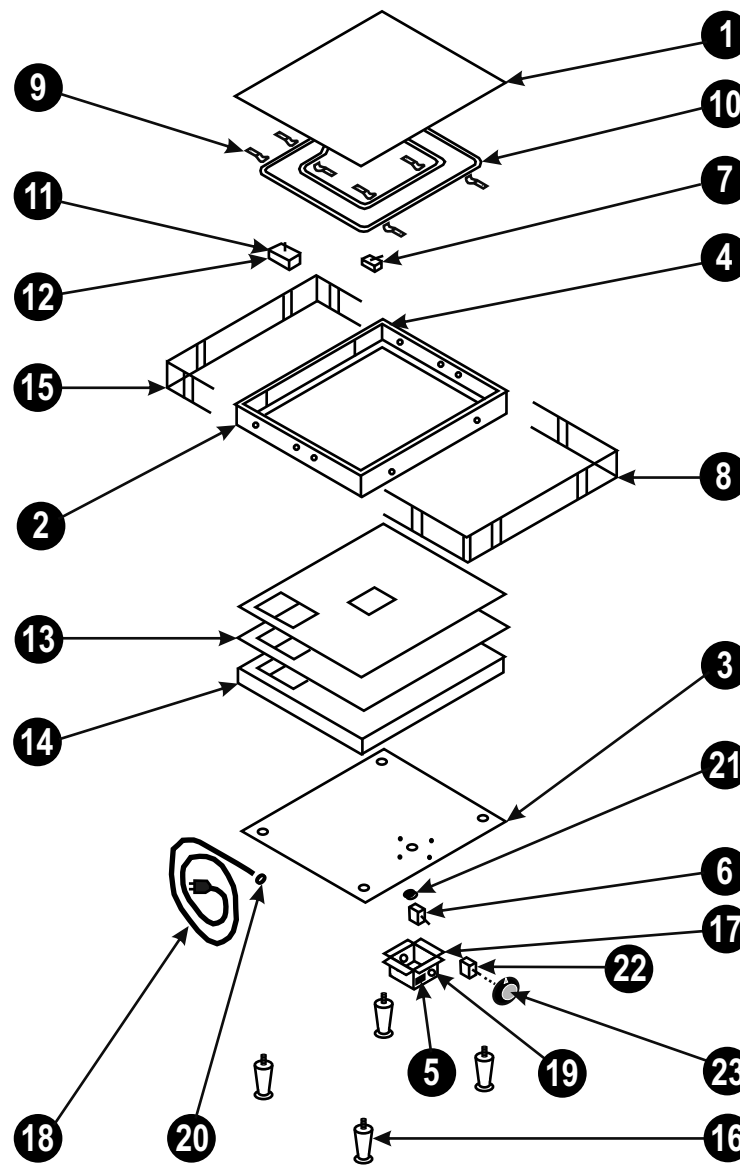

APW WYOTT EQUIPMENT LIMITED WARRANTY

APW Wyott Foodservice Equipment Company warrants its equipment against defects in materials and workmanship, subject to the following conditions:

This warranty applies to the original owner only and is not assignable.

Should any product fail to function in its intended manner under normal use within the limits defined in this warranty, at the option of APW Wyott such product will be repaired or replaced by APW Wyott or its Authorized Service Agency. APW Wyott will only be responsible for charges incurred or service performed by its Authorized Service Agencies. The use of other than APW Wyott Authorized Service Agencies will void this warranty and APW Wyott will not be responsible for such work or any charges associated with same. The closest APW Wyott Authorized Service Agent must be used.

This warranty covers products shipped into the 48 contiguous United States, Hawaii, metropolitan areas of Alaska and Canada. There will be no labor coverage for equipment located on any island not connected by roadway to the mainland.

Warranty coverage on products used outside the 48 contiguous United States, Hawaii, and metropolitan areas of Alaska and Canada may vary. Contact the international APW Wyott distributor, dealer, or service agency for details.

Time Period

One year for parts and one year for labor, effective from the date of purchase by the original owner. The Authorized Service Agency may, at their option, require proof of purchase. Parts replaced under this warranty are warranted for the un-expired portion of the original product warranty only.

Exceptions

***Gas/Electric Cookline:** Models GCB, GCRB, GF, GGM, GGT, CHP-H, EF, EG, EHP. Three (3) Year Warranty on all component parts, except switches and thermostats. (2 additional years on parts only. No labor on second or third year.)

***Broiler Briquettes, Rock Grates, Cooking Grates, Burner Shields, Fireboxes:** 90 Day Material Only. No Labor.

***Heat Strips:** Models FD, FDL, FDD, FDDL. Two (2) Year Warranty on element only. No labor second year.

***Glass Windows, Doors, Seals, Rubber Seals, Light Bulbs:** 90 Day Material Only. No Labor.

In all cases, parts covered by extended warranty will be shipped FOB the factory after the first year.

Portable Carry In Products

Equipment weighing over 70 pounds or permanently installed will be serviced on-site as per the terms of this warranty. Equipment weighing 70 pounds or under, and which is not permanently installed, i.e. with cord and plug, is considered portable and is subject to the following warranty handling limitations. If portable equipment fails to operate in its intended manner on the first day of connection, or use, at APW Wyott's option or its Authorized Service Agency, it will be serviced on site or replaced.

From day two through the conclusion of this warranty period, portable units must be taken to or sent prepaid to the APW Wyott Authorized Service Agency for in-warranty repairs. No mileage or travel charges are allowed on portable units after the first day of use. If the customer wants on-site service, they may receive same by paying the travel and mileage charges. Exceptions to this rule: (1) countertop warmers and cookers, which are covered under the Enhanced Warranty Program, and (2) toasters or rollergrills which have in store service.

Exclusions

The following conditions are not covered by warranty:

*Equipment failure relating to improper installation, improper utility connection or supply and problems due to ventilation.

*Equipment that has not been properly maintained, calibration of controls, adjustments, damage from improper cleaning and water damage to controls.

*Equipment that has not been used in an appropriate manner, or has been subject to misuse or misapplication, neglect, abuse, accident, alteration, negligence, damage during transit, delivery or installation, fire, flood, riot or act of god.

*Equipment that has the model number or serial number removed or altered.

If the equipment has been changed, altered, modified or repaired by other than an Authorized Service Agency during or after the warranty period, then the manufacturer shall not be liable for any damages to any person or to any property, which may result from the use of the equipment thereafter.

This warranty does not cover services performed at overtime or premium labor rates. Should service be required at times which normally involve overtime or premium labor rates, the owner shall be charged for the difference between normal service rates and such premium rates. APW Wyott does not assume any liability for extended delays in replacing or repairing any items beyond its control.

In all cases, the use of other than APW Wyott Authorized OEM Replacement Parts will void this warranty.

This equipment is intended for commercial use only. Warranty is void if equipment is installed in other than commercial application.

Water Quality Requirements

Water supply intended for a unit that has in excess of 3.0 grains of hardness per gallon (GPG) must be treated or softened before being used. Water containing over 3.0 GPG will decrease the efficiency and reduce the operation life of the unit.

Note: Product failure caused by liming or sediment buildup is not covered under warranty.

"THE FOREGOING WARRANTY IS IN LIEU OF ANY AND ALL OTHER WARRANTIES EXPRESSED OR IMPLIED INCLUDING ANY IMPLIED WARRANTY OF MERCHANTABILITY OR FITNESS FOR PARTICULAR PURPOSES AND CONSTITUTES THE ENTIRE LIABILITY OF APW WYOTT. IN NO EVENT DOES THE LIMITED WARRANTY EXTEND BEYOND THE TERMS STATED HEREIN."

9/05