

**INSTALLATION  
AND  
OPERATING  
INSTRUCTIONS**

Model: **FT 800**

**FASTRAC™ HORIZONTAL CONVEYOR TOASTER**

**INTENDED FOR OTHER THAN HOUSEHOLD USE**

**RETAIN THIS MANUAL FOR FUTURE REFERENCE  
UNIT MUST BE KEPT CLEAR OF COMBUSTIBLES AT ALL TIMES**

**TABLE OF CONTENTS**

Safety Precautions .....	2
Important Safety Instructions .....	3
General Information .....	4
Installation Instructions .....	4
Operation Instructions .....	5
Cleaning Instructions .....	5
Warranty Procedure .....	6
Troubleshooting .....	6
Replacement Parts List .....	8
Wiring Diagram .....	10
Warranty .....	11

**! WARNING:** Improper installation, adjustment, alteration, service or maintenance can cause property damage, injury or death. Read the Installation, Operating and Maintenance Instructions thoroughly before installing or servicing this equipment. **!**

This equipment has been engineered to provide you with year-round dependable service when used according to the instructions in this manual and standard commercial kitchen practices.

Phone: +1 (214) 421-7366  
 Fax: +1 (214) 565-0976  
 Toll Free: +1 (800) 527-2100  
 Website: [www.apwwyott.com](http://www.apwwyott.com)  
 E-mail: [info@apwwyott.com](mailto:info@apwwyott.com)

P/N 67190 9/06

**APW WYOTT**  
 729 Third Avenue  
 Dallas, TX 75226

## IMPORTANT FOR FUTURE REFERENCE

Please complete this information and retain this manual for the life of the equipment. For Warranty Service and/or Parts, this information is required.

\_\_\_\_\_

Model Number

\_\_\_\_\_

Serial Number

\_\_\_\_\_

Date Purchased

**Notes:** \_\_\_\_\_

\_\_\_\_\_

\_\_\_\_\_

\_\_\_\_\_

\_\_\_\_\_

\_\_\_\_\_

\_\_\_\_\_

\_\_\_\_\_

\_\_\_\_\_

\_\_\_\_\_

\_\_\_\_\_

## SAFETY PRECAUTIONS

Before installing and operating this equipment be sure everyone involved in its operation are fully trained and are aware of all precautions. Accidents and problems can result by a failure to follow fundamental rules and precautions.

The following words and symbols, found in this manual, alert you to hazards to the operator, service personnel or the equipment. The words are defined as follows:



**DANGER:** This symbol warns of imminent hazard which will result in serious injury or death.



**WARNING:** This symbol refers to a potential hazard or unsafe practice, which could result in serious injury or death.



**CAUTION:** This symbol refers to a potential hazard or unsafe practice, which may result in minor or moderate injury or product or property damage.



**NOTICE:** This symbol refers to information that needs special attention or must be fully understood even though not dangerous.











































**APW Wyott** takes pride in the design and quality of our products. When used as intended and with proper care and maintenance, you will experience years of reliable operation from this equipment. To ensure best results, it is important that you read and follow the instructions in this manual carefully.

Installation and start-up should be performed by a qualified installer who thoroughly read, understands and follows these instruction.

If you have questions concerning the installation, operation, maintenance or service of this product, contact APW Wyott Foodservice Equipment Company's "Technical Service Department".

# 1. IMPORTANT SAFETY INSTRUCTIONS

	<b>IMPORTANT:</b> Read the following important safety instructions to avoid personal injury or death, and to avoid damage to the equipment or property.	
	<b>WARNING:</b> Do not allow untrained personnel to operate the toaster.	
	<b>NOTICE:</b> Do not use toppings (butter, etc.) on product as product is inverted during normal operation.	
	<b>WARNING:</b> To avoid any injury, turn the power switch off at the fuse disconnect switch/circuit breaker or unplug the unit from the power source and allow to cool completely before performing any maintenance or cleaning.	
	<b>WARNING:</b> Unit is not waterproof. DO NOT submerge in water. Do not operate if it has been submerged in water. Do not clean the unit with a water jet.	
	<b>WARNING:</b> Operating toaster without legs invalidates any warranty claims.	
	<b>WARNING:</b> Neglecting to keep the fan opening clean could result in toaster failure.	
	<b>WARNING:</b> Operating the toaster without the Reflector Tray reduces the toasting capabilities.	
	<b>WARNING:</b> Neglecting to keep fan opening clean could result in toaster failure.	
	<b>WARNING:</b> APW Wyott toasters are designed, built, and sold for commercial use. If positioned where the general public can use them, make sure that all cautions, warnings, and operating instructions are clearly posted near each unit to insure proper operation, reduce the chance of personal injury and/or equipment damage.	
	<b>WARNING:</b> Plug unit into a properly grounded electrical outlet of the correct voltage, size and plug configuration. If the plug and receptacle do not match, contact a qualified electrician to determine the proper voltage and size and install the proper electrical outlet.	
	<b>WARNING:</b> To avoid electrical shock, always unplug the unit before performing cleaning or maintenance.	
	<b>WARNING:</b> For safe and proper operation, the unit must be located a reasonable distance from combustible walls and materials. If safe distances are not maintained, discoloration or combustion could occur.	
	<b>WARNING:</b> To avoid electrical shock or personal injury, do not steam clean or use excessive water on the unit.	
	<b>WARNING:</b> If service is required on this unit, contact your authorized APW Wyott Service Agent, or contact the APW Wyott Service Department directly at (214) 421-7366 or (800) 527-2100; fax (214) 565-0976.	
	<b>WARNING:</b> This product has no "user" serviceable parts. To avoid damage to the unit or injury to personnel, use only Authorized APW Wyott Service Agents and genuine APW Wyott Parts when service is required..	
	<b>CAUTION:</b> Some exterior surfaces on the unit will get hot. Use caution when touching these areas to avoid injury.	
	<b>CAUTION:</b> Use only non-abrasive cleaners. Abrasive cleaners could scratch the finish of your unit, marring it's appearance and making it susceptible to dirt accumulation.	
	<b>WARNING:</b> In Europe, appliance must be connected by an earthing cable to all other units in the complete installation and thence to an independent earth connection in compliance with EN 60335-1 and/or local codes	
	<b>WARNING:</b> An earthing cable must connect the appliance to all other units in the complete installation and from there to an independent earth connection.	

**CAUTION:** The National Sanitation Foundation (NSF) requires that units over 36" (91 cm) in length or weighing more than 80 lbs. (36 kg) to be either sealed or raised on the installation surface. If this unit cannot be sealed at the point of use, 4" (10 cm) legs are included to allow for proper cleaning access below unit.

**WARNING:** Genuine APW Wyott Replacement Parts are specified to operate safely in the environments in which they are used. Some aftermarket or generic replacement parts do not have the characteristics that will allow them to operate safely in APW Wyott equipment. It is essential to use APW Wyott Replacement Parts when repairing APW Wyott equipment. Failure to use APW Wyott Replacement Parts may subject operators of the equipment to hazardous electrical voltage, resulting in electrical shock or burn.

**CAUTION:** Locate the unit at the proper counter height, in an area that is convenient for use. The location should be level to prevent the unit or its contents from accidentally falling, and strong enough to support the weight of the unit and food.

**WARNING:** Failure to provide clearances will cause unit failure and invalidate warranty claims (see installation instructions).

## GENERAL INFORMATION

- I. Consult the rating label for model and serial number. Write this information below before proceeding:  
A. Model # \_\_\_\_\_ B. Serial # \_\_\_\_\_
  - II. Overall Dimensions w/Wire Feeder - 14.6" H (371mm) x 15.2" W (385 mm) x 22.8"D (579mm)
  - III. Product Opening - 1.5" H (38mm) x 10.50" W (267mm)
  - IV. Productivity (per hour) - results will vary depending on line voltage and bread dryness.
  - V. Electrical Requirements
    - A. Single phase, 208-240 volts, 2850 watts, 13.7 amps.
    - B. Cordset configuration
      1. Each toaster is equipped with a three-wire grounded cordset and standard three-prong plug.
      2. In the United States, a four foot cordset with NEMA 6-20P plug.
      3. In Canada, a six foot cordset with NEMA 6-20P plug.
- Net/Shipping Weight - 39lb.(17.7kg) /47lb.(21.4kg)

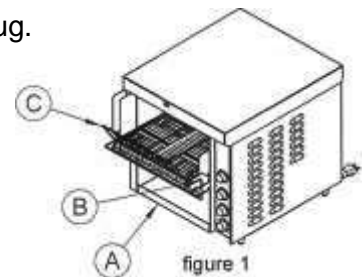

## INSTALLATION INSTRUCTIONS

- I. Check Contents - refer to Figure 1, account for the following parts:
  - A. Toast Drawer - shipped in place
  - B. Reflector Tray - shipped in place
  - C. Wire Feeder - inside Reflector Tray
  - D. Instruction Manual - shipped loose

**NOTE: DO NOT OPERATE THE TOASTER WITH THE REFLECTOR TRAY REMOVED FROM ITS POSITION**

- II. Position Wire Feeder - refer to Figure 2

- A. Pull out Reflector Tray
- B. Rotate Wire Feeder
- C. Slide Reflector Tray back
- D. **WARNING:** Operating the toaster without the Reflector Tray reduces toasting capabilities.

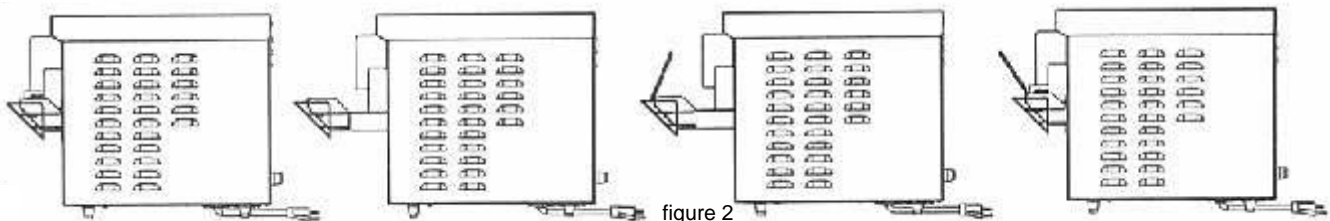

- III. Toaster Placement
- A. Locate the toaster near a grounded receptacle of the proper configuration (see below). Plug the cordset directly into receptacle (DO NOT USE AN EXTENSION CORD).
    - 1. In the United States, NEMA 6-20R.
    - 2. In Canada, NEMA 6-20R.
  - B. Place the toaster on a flat surface providing the following minimum clearances:
    - 1. Base = one inch (provided with legs installed).
    - 2. Side and back walls = one inch
    - 3. Overhead = Enough space to allow adequate heat displacement.
    - 4. WARNING: Failure to provide these clearances will cause unit failure and invalidate warranty claims.
  - C. Position toaster where customers will not contact any surface labeled "CAUTION HOT".

**NOTE: DO NOT OPERATE THE TOASTER WITH THE LEGS REMOVED.**

## **OPERATION INSTRUCTIONS**

### **I. PREPARATION**

- A. Clean the toaster thoroughly before first use (See cleaning instructions).
- B. Controls Familiarity
  - 1. Main Power Switch - four (4) position rotary switch
    - a) Full Power: rotary switch turned RIGHT ( 3 o'clock). ( HIGH)
    - b) Power Off: rotary switch turned to TOP or BOTTOM. (12 and 6 o'clock) (OFF)
    - c) Standby Power: rotary switch turned LEFT (9 o'clock). ( STANDBY)
  - 2. Conveyor Speed Control: Set knob to the five (5) position for warm-up.
- C. Temperature Settings: Set both Top and Bottom heat knobs to 12 (max.) for warm up. One (1) is the minimum heat setting. Power to the heating elements is off when the knobs are in the OFF ( 0 ) position.
- D. Warm-up time: Allow fifteen (15) minutes.

### **II. NORMAL USE**

- A. Loading Product
  - 1. Place product on the Wire Feeder. The conveyor will automatically draw product through the toaster at a speed determined by conveyor speed control.
- B. Toasting Darkness: determined by conveyor speed.
  - 1. Darkest toasting - set conveyor speed control to one (1).
  - 2. Lightest toasting - set conveyor speed control to ten (10).
  - 3. Other factors affecting toasting darkness.
    - a) Product moistness - moister product requires slower speeds
    - b) Sugar content in product - product with more sugar requires slower speeds
    - c) Product Temperature - cooler product requires slower speeds
  - 4. For best results, use day old bread stored at room temperature.
- C. The conveyor belt, drive motor, and shaft bearings do not require lubrication.

## **CLEANING INSTRUCTIONS**

**NEVER CLEAN THE TOASTER BY IMMERSING IT IN WATER. DO NOT CLEAN WITH A WATER JET.**

### **I. DAILY CLEANING**

- A. With the toaster ELEMENTS OFF and cool, turn the toaster ON and set conveyor speed to four (4).
- B. Using a plastic abrasive pad, wipe the conveyor belt in a back and forth motion (side-to-side) motion to remove baked-on product. Wipe clean the conveyor belt in the same manner with a hot, damp cloth.
- C. Turn OFF the toaster.

- D. Slide the reflector/crumb tray out of the toaster by pulling forward. Dispose of crumbs and wash the tray in hot, soapy water. Dry the tray and place it back into the toaster.
- E. Remove the bottom toast drawer from the toaster by sliding it out and lifting up. Dispose of crumbs and wash the drawer in hot, soapy water. Wipe crumbs from inside the toaster with a hot, damp cloth. Dry the drawer and place it back into the toaster.
- F. Wipe the exterior surfaces of the toaster with a hot, damp cloth.

## II. PERIODIC CLEANING

- A. Conveyor Belt
  - 1. Remove the conveyor belt from the toaster.
  - 2. Use needle-nose pliers to bend a link to the inside until the hook clears the link above.
  - 3. Repeat on the other side.
  - 4. Pull the loosened links together and slide through the center-of-belt link.
  - 5. Clean the belt thoroughly (See item 2 under "daily cleaning").
  - 6. Install the conveyor belt by reversing the order of steps noted above (See item 1).

**NOTE: DO NOT INSTALL BELT BACKWARDS OR UPSIDE DOWN. ALIGN LINKS ACROSS SHAFT SPROCKET TEETH.**
- B. Cooling Intake Fan
  - 1. Unplug and lay the toaster on its side.
  - 2. Brush dirt and debris from the fan opening and fan guard.
  - 3. **WARNING:** Neglecting to keep the fan-opening clean could result in toaster failure.

## WARRANTY PROCEDURE

If warranty service is needed on your *FASTRAC™*, follow these steps:

- I. Identify the model and serial number from the rating label on your toaster.
- II. Consult the enclosed directory, find the service agency nearest you, call the number listed or the 24-hour toll free service hot line, 1-800-733-2203. If there is not a service agency listed for your area, the parts distributor will provide service for your toaster.
- III. To order parts consult the enclosed directory. The parts distributor is listed at the beginning of each state listing. The parts distributors have a complete stock of parts for your toaster.

## TROUBLESHOOTING

- I. Always ask and check the following:
  - A. Is the unit connected to a live power source?
  - B. Check the circuit breaker.
  - C. Is power switch on?
  - D. Is the unit operating on proper voltage? (see rating label)
  - E. Is power cord damaged? If YES, replace **ONLY** with an IDENTICAL power cord.
- II. If problems exist after checking the above, check the chart below.
- III. If any service is needed (*italicized items*), call an APW Wyott authorized service agency. All service should be performed by an APW Wyott authorized service agency.

**TROUBLESHOOTING CHART:**

THE PROBLEM	THE CAUSE	THE SOLUTION
Won't toast...	a. Toaster cold. b. Wrong power switch position. c. Wrong conveyor speed setting.	a. Allow five (5) minutes for warm up. b. Position power switch to full power. c. Reduce conveyor speed.
Toasts unevenly...	d. Only part of product surface is Toasted. e. Product located too far to side of conveyor.	d. Reduce conveyor speed. e. Place product on conveyor between end links.
Product sticks to conveyor or slide..	f. Butter or butter substitute used on product. g. Conveyor surface has baked-on oil residue. h. Very moist or doughy product. i. Product not defrosted or thawed.	f. Discontinue use of butter or butter substitute. g. Follow daily cleaning methods to remove & prevent residue. h. Use different source or day-old product. i. Defrost/thaw product.
No power...	j. No power to receptacle. k. Toaster unplugged. l. Loose connections. m. Power switch.	j. Check circuit breaker. k. Plug in toaster. l. Check connections. m. Check that switch is on & operational.
Won't heat...	n. Loose connections. o. Faulty power switch. p. Burnt out element.	n. Check connections. o. Replace power switch. p. Replace element.
Lighter toast Under peak loads.	q. Speed control setting. r. Very moist product. s. Product too cold. t. Toaster cavity temperature being quenched.	q. Reduce speed control setting. r. Use different source or day old product. s. Allow product to warm to room temperature. t. Add 1" or more spacing between product.
Conveyor won't move...	u. No power. v. Conveyor links are binding. w. Drive chain too loose or too tight. x. Loose or bad connection between speed control and conveyor motor. y. Conveyor motor burnt out. z. Speed control burnt out.	u. Check circuit breaker. v. Check conveyor for bent links. w. Adjust drive chain. x. Check for loose or bad connection. y. Replace conveyor motor. z. Replace speed control.

## REPLACEMENT PARTS LIST - FT 800

ITEM	P/N	DESCRIPTION	QTY
1	34236	TERMINAL BLOCK END MTG	1
2	34237	TERMINAL BLOCK (6) .250 MALE	3
3	38254	IDLER SHAFT ASSY	1
4	83956	DRIVE SHAFT ASSY	2
5	38244	CRUMB TRAY/REFLECTOR ASSY	1
6	38129	TOAST DRAWER	1
7	38131	WIRE FEEDER	1
8	54093	ELEMENT 208V 1400W	2
	54094	ELEMENT 240V 1400W	2
9	58188	LABEL, CONTROL PANEL	1
10	89490	SWITCH, MAIN ROTARY	1
11	82903	#25 DRIVE CHAIN, " PITCH, 65 PITCHES	1
12	PS0021	WIRE BELT, 3 SEGMENT, 2.43' OF 82920 (65 LINKS)	1
13	83248	BEARING SHAFT	2
14	83222	RHEOSTAT 208/240V TERM.	1
15	69104	INFINITE CONTROL 208V 15AMP CURVE "B"	2
	69103	INFINITE CONTROL 240V 15AMP CURVE "B"	2
16	83261	DRIVEN SPROCKET, #25B12 TOOTH X 3/8" BORE (1/4" PITCH)	1
17	83260	DRIVE SPROCKET, #25B18 TOOTH X5/16" BORE (1/4" PITCH)	1
18	83277	POWER CORD 208-240V, 20 AMP PLUG	1
19	83267	LEG 1" CHROMED PLASTIC	4
20	38125	BEARING, FLANGED, POLYMER	2
21	85143	MOTOR, 230V 60HZ, 9RPM	1
22	85284	COOLING FAN	1
23	85288	FAN CORD	1
24	88705	KNOB	4
25	89111	STRAIN RELIEF	1
26	38247	WIRE GUARD	1
27	85287	FAN GUARD	1
28	69154	FAN CONTROL THERMOSTAT	1



# EXPLODED VIEW - FT 800

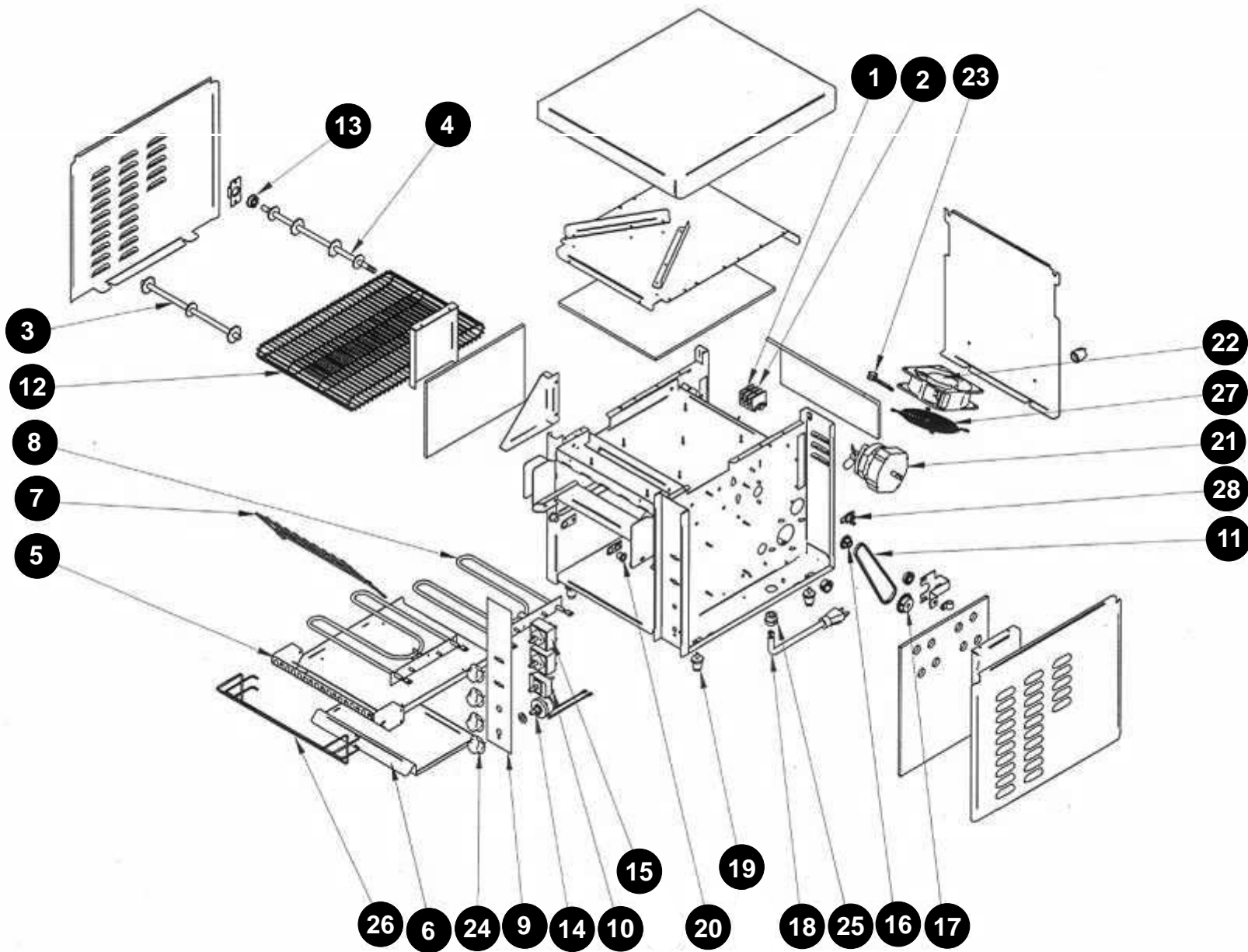

# WIRING DIAGRAM - MODEL FT 800



**IMPORTANT NOTICE:** The information contained in this section of the manual is intended for individuals possessing backgrounds of electrical and mechanical experience, such as an authorized APW Wyatt service technician. APW or the seller cannot be responsible for the interpretation of this information, nor can it assume any liability in connection with its use.

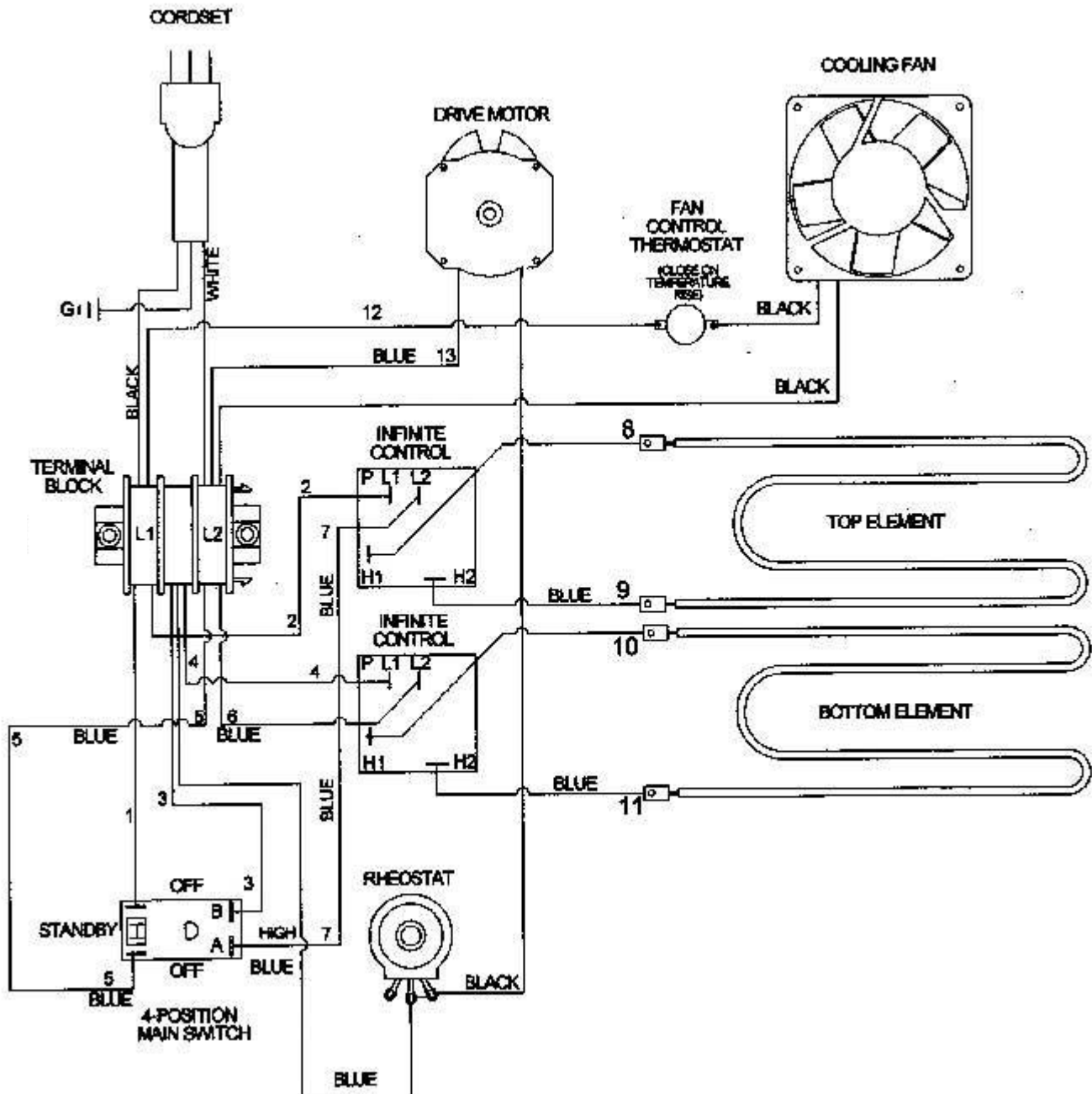

## APW WYOTT EQUIPMENT LIMITED WARRANTY

APW Wyott Foodservice Equipment Company warrants its equipment against defects in materials and workmanship, subject to the following conditions:

This warranty applies to the original owner only and is not assignable.

Should any product fail to function in its intended manner under normal use within the limits defined in this warranty, at the option of APW Wyott such product will be repaired or replaced by APW Wyott or its Authorized Service Agency. APW Wyott will only be responsible for charges incurred or service performed by its Authorized Service Agencies. The use of other than APW Wyott Authorized Service Agencies will void this warranty and APW Wyott will not be responsible for such work or any charges associated with same. The closest APW Wyott Authorized Service Agent must be used.

This warranty covers products shipped into the 48 contiguous United States, Hawaii, metropolitan areas of Alaska and Canada. There will be no labor coverage for equipment located on any island not connected by roadway to the mainland.

Warranty coverage on products used outside the 48 contiguous United States, Hawaii, and metropolitan areas of Alaska and Canada may vary. Contact the international APW Wyott distributor, dealer, or service agency for details.

### Time Period

One year for parts and one year for labor, effective from the date of purchase by the original owner. The Authorized Service Agency may, at their option, require proof of purchase. Parts replaced under this warranty are warranted for the un-expired portion of the original product warranty only.

### Exceptions

- \***Gas/Electric Cookline:** Models GCB, GCRB, GF, GGM, GGT, CHP-H, EF, EG, EHP. Three (3) Year Warranty on all component parts, except switches and thermostats. (2 additional years on parts only. No labor on second or third year.)
- \***Broiler Briquettes, Rock Grates, Cooking Grates, Burner Shields, Fireboxes:** 90 Day Material Only. No Labor.
- \***Heat Strips:** Models FD, FDL, FDD, FDDL. Two (2) Year Warranty on element only. No labor second year.
- \***Glass Windows, Doors, Seals, Rubber Seals, Light Bulbs:** 90 Day Material Only. No Labor.

In all cases, parts covered by extended warranty will be shipped FOB the factory after the first year.

### Portable Carry In Products

Equipment weighing over 70 pounds or permanently installed will be serviced on-site as per the terms of this warranty. Equipment weighing 70 pounds or under, and which is not permanently installed, i.e. with cord and plug, is considered portable and is subject to the following warranty handling limitations. If portable equipment fails to operate in its intended manner on the first day of connection, or use, at APW Wyott's option or its Authorized Service Agency, it will be serviced on site or replaced.

From day two through the conclusion of this warranty period, portable units must be taken to or sent prepaid to the APW Wyott Authorized Service Agency for in-warranty repairs. No mileage or travel charges are allowed on portable units after the first day of use. If the customer wants on-site service, they may receive same by paying the travel and mileage charges. Exceptions to this rule: (1) countertop warmers and cookers, which are covered under the Enhanced Warranty Program, and (2) toasters or rollergrills which have in store service.

### Exclusions

The following conditions are not covered by warranty:

- \*Equipment failure relating to improper installation, improper utility connection or supply and problems due to ventilation.
- \*Equipment that has not been properly maintained, calibration of controls, adjustments, damage from improper cleaning and water damage to controls.
- \*Equipment that has not been used in an appropriate manner, or has been subject to misuse or misapplication, neglect, abuse, accident, alteration, negligence, damage during transit, delivery or installation, fire, flood, riot or act of god.
- \*Equipment that has the model number or serial number removed or altered.

If the equipment has been changed, altered, modified or repaired by other than an Authorized Service Agency during or after the warranty period, then the manufacturer shall not be liable for any damages to any person or to any property, which may result from the use of the equipment thereafter.

This warranty does not cover services performed at overtime or premium labor rates. Should service be required at times which normally involve overtime or premium labor rates, the owner shall be charged for the difference between normal service rates and such premium rates. APW Wyott does not assume any liability for extended delays in replacing or repairing any items beyond its control.

In all cases, the use of other than APW Wyott Authorized OEM Replacement Parts will void this warranty.

This equipment is intended for commercial use only. Warranty is void if equipment is installed in other than commercial application.

### Water Quality Requirements

Water supply intended for a unit that has in excess of 3.0 grains of hardness per gallon (GPG) must be treated or softened before being used. Water containing over 3.0 GPG will decrease the efficiency and reduce the operation life of the unit.

**Note: Product failure caused by liming or sediment buildup is not covered under warranty.**

**"THE FOREGOING WARRANTY IS IN LIEU OF ANY AND ALL OTHER WARRANTIES EXPRESSED OR IMPLIED INCLUDING ANY IMPLIED WARRANTY OF MERCHANTABILITY OR FITNESS FOR PARTICULAR PURPOSES AND CONSTITUTES THE ENTIRE LIABILITY OF APW WYOTT. IN NO EVENT DOES THE LIMITED WARRANTY EXTEND BEYOND THE TERMS STATED HEREIN."**

9/05



---

Phone: +1 (214) 421-7366  
Fax: +1 (214) 565-0976  
Toll Free: +1 (800) 527-2100  
Website: [www.apwwyott.com](http://www.apwwyott.com)  
E-mail: [info@apwwyott.com](mailto:info@apwwyott.com)

**APW WYOTT**  
729 Third Avenue  
Dallas, TX 75226