



**INSTALLATION AND OPERATING INSTRUCTIONS**

**Gas Foodwarmer**

**MODEL: GWW (Convertible)**

**PRODUCT MANUAL**

- Safety Instructions
- Installation Instructions
- Operation Instructions
- Maintenance Instructions
- Replacement Parts List
- Warranty/Service Information

**IMPORTANT FOR FUTURE REFERENCE**

Please complete this information and retain this manual for the life of the equipment. For Warranty Service and/or Parts, this information is required.

\_\_\_\_\_   
 Model Number

\_\_\_\_\_   
 Serial Number

\_\_\_\_\_   
 Date Purchased



**FOR YOUR SAFETY:** Do not store or use gasoline or other flammable vapors and liquids in the vicinity of this or any other appliance.



**WARNING:** Improper installation, operation, service or maintenance can cause property damage, injury or death. Read and understand these instructions thoroughly before positioning, installing, maintaining or servicing this equipment.



P/N 8806065 2-06

**APW WYOTT Foodservice Equipment Company**

P.O. Box 1829  
Cheyenne, WY 82003

+1 (307) 634-5801 Phone  
+1 (307) 637-8071 Fax

+1 (800) 752-0863 Toll Free  
[www.apwwyott.com](http://www.apwwyott.com)

Installation and start-up should be performed by a qualified installer who thoroughly read, understands and follows these instructions.



If you have questions concerning the installation, operation, maintenance or service of this product, write Technical Service Department APW Wyott Foodservice Equipment Company, P.O. Box 1829, Cheyenne, WY 82003.



## 1. SAFETY PRECAUTIONS



Before installing and operating this equipment be sure everyone involved in its operation is fully trained and is aware of all precautions. Accidents and problems can result by a failure to follow fundamental rules and precautions.



Shut off gas flow through the appliance before cleaning or servicing unit.

The following words and symbols, found in this manual, alert you to hazards to the operator, service personnel or the equipment. The words are defined as follows.

 **DANGER:** This symbol warns of imminent hazard which will result in serious injury or death. 



 **WARNING:** This symbol refers to a potential hazard or unsafe practice, which could result in serious injury or death. 



 **CAUTION:** This symbol refers to a potential hazard or unsafe practice, which may result in minor or moderate injury or product or property damage. 



 **NOTICE:** This symbol refers to information that needs special attention or must be fully understood even though not dangerous. 



## GENERAL INFORMATION



### THIS MANUAL SHOULD BE RETAINED FOR FUTURE REFERENCE



 **CAUTION:** These models are designed, built, and sold for commercial use. If these models are positioned so the general public can use the equipment, make sure that cautions, warnings, and operating instructions are clearly posted near each unit so that anyone using the equipment will use it correctly and not injure themselves or harm the equipment. 



 **WARNING:** A factory authorized agent should handle all maintenance and repair. Before doing any maintenance or repair, contact APW Wyott. 



 **WARNING:** Install per the spacing requirements listed in the installation section of this manual. We strongly recommend having a competent professional install the equipment. A licensed electrician should make the electrical connections and connect power to the unit. Local codes should always be used when connecting these units to electrical power. In the absence of local codes, use the latest version of the National Electrical Code. 



 **WARNING:** A factory authorized agent should handle all maintenance and repair. Before doing any maintenance or repair, contact APW Wyott. 



 **WARNING:** An earthing cable must connect the appliance to all other units in the complete installation and from there to an independent earth connection. 



 **NOTICE:** This product is intended for commercial use only. Not for household use. 



 **WARNING: SHOCK HAZARD:** Do not open any panels that require the use of tools. 

 **WARNING:** Improper installation, adjustment, alteration, service or maintenance can cause property damage, injury or death. Read installation, operating and maintenance instructions thoroughly before installing or servicing this equipment. 

 **NOTICE:** The unit, when installed, must be electrically grounded and comply with local codes, or, in the absence of local codes, with the national electrical code ANSI/NFPA70-latest edition. Canadian installation must comply with CSA-STANDARD C.22.2 Number 0 M1982 General Requirements-Canadian Electrical Code Part II, 109-M1981-Commercial Cooking Appliances. 

 **NOTICE:** Local codes regarding installation vary greatly from one area to another. The National Fire Protection Association, Inc., states in its NFPA96 latest edition that local codes are "Authority Having Jurisdiction" when it comes to requirement for installation of equipment. Therefore, installation should comply with all local codes. 

 **WARNING:** For your safety do not store or use gasoline or other flammable vapors or liquids in the vicinity of this or any other appliance. Keep the area free and clear of combustibles. (See ANZI Z83.14B, 1991) 

 **NOTICE:** Instructions to be followed if anyone smells gas should be posted in a prominent place. These may be obtained from the gas supplier. 

### GAS PRESSURE

The appliance and its individual shutoff valve must be disconnected from the gas supply piping system during any pressure testing of that system at test pressures in excess of ½ psi (3.45 kPa).

The appliance must be isolated from the gas supply piping system by closing its individual manual shut-off valve during any pressure testing of the gas supply piping system at test pressures equal to or less than ½ psi (3.45 kPa).

Congratulations on your purchase of APW Wyott commercial cooking or refrigeration equipment. APW Wyott takes pride in the design and quality of our products. When used as intended and with proper care and maintenance, you will experience years of reliable operation from this equipment. To ensure best results, it is important that you read and follow the instructions in this manual carefully.

The countertop foodwarmer provides countertop warming capabilities. The unit incorporates a 4000 BTU burner for efficient operation.

## TABLE OF CONTENTS:

SECTION	ITEM	PAGE
1	Safety Precautions	2
2	General Installation Instructions	4
3	Specifications	5
4	Lighting Instructions	6
5	Maintenance	6
6	Conversion	7
7	Replacement Parts List & Exploded View	8
8	Warranty	11

### LOCATION OF DATA PLATE

The data plate for the gas warmer well is located on the back side of the front panel.

### IMMEDIATELY INSPECT FOR SHIPPING DAMAGE

All containers should be examined for damage before and during unloading. The freight carrier has assumed responsibility for its safe transit and delivery. If equipment is received damaged, either apparent or concealed, a claim must be made with the delivering carrier.

A) Apparent damage or loss must be noted on the freight bill at the time of delivery. It must then be signed by the carrier representative (Driver). If this is not done, the carrier may refuse the claim. The carrier can supply the necessary forms.

B) Concealed damage or loss if not apparent until after equipment is uncrated, a request for inspection must be made to the carrier within 15 days. The carrier should arrange an inspection. Be certain to hold all contents and packaging material.

Installation and start-up should be performed by a qualified installer who thoroughly read, understands and follows these instruction.

If you have questions concerning the installation, operation, maintenance or service of this product, write Technical Service Department APW Wyott Foodservice Equipment Company, P.O. Box 1829, Cheyenne, WY 82003.

## 2. GENERAL INSTALLATION INSTRUCTIONS:

Ensure gas supply and gas type, as shown on unit nameplate agree.

Unit installation must conform with the National Fuel Gas Code, ANSI Z223.1-1996, the National Gas Installation Code, CAN/CGA-B149.1, or the Propane Installation Code, CAN/CGA-B149.2 as applicable and in accordance with local codes.

Screw legs into the permanently fastened nuts on the four corners of the unit and tighten by hand. Level the unit by turning the adjustment screw at the bottom of each leg. Do not slide unit with legs mounted, lift if necessary to move unit.

Pipe gas supply to unit.

Pipe threading compound must be resistant to the action of liquefied petroleum gases.



**Caution:** DO NOT use an open flame to check for leaks. Check all gas piping for leaks with a soap and water solution before operating unit.



### 3. SPECIFICATIONS

These units are suitable for installation on combustible and noncombustible surfaces.

NONCOMBUSTIBLE CLEARANCES	
Sides	Rear
0"	0"

COMBUSTIBLE CLEARANCES	
Sides	Rear
3"	3"

#### Gas Foodwarmer:

These gas units are designed for countertop operation. They are used for holding products at serving temperature and producing evenly cooked products.

#### Gas:

GWW (1) 4000 BTU/HR burner with (1) standing pilot. Convertable to natural or propane gas.

#### Dimensions:

14" W x 24 3/4" Lg x 14 41/64"

#### Capacity:

GWW 22 Quarts. Accepts 12" x 20" or fractional pans.

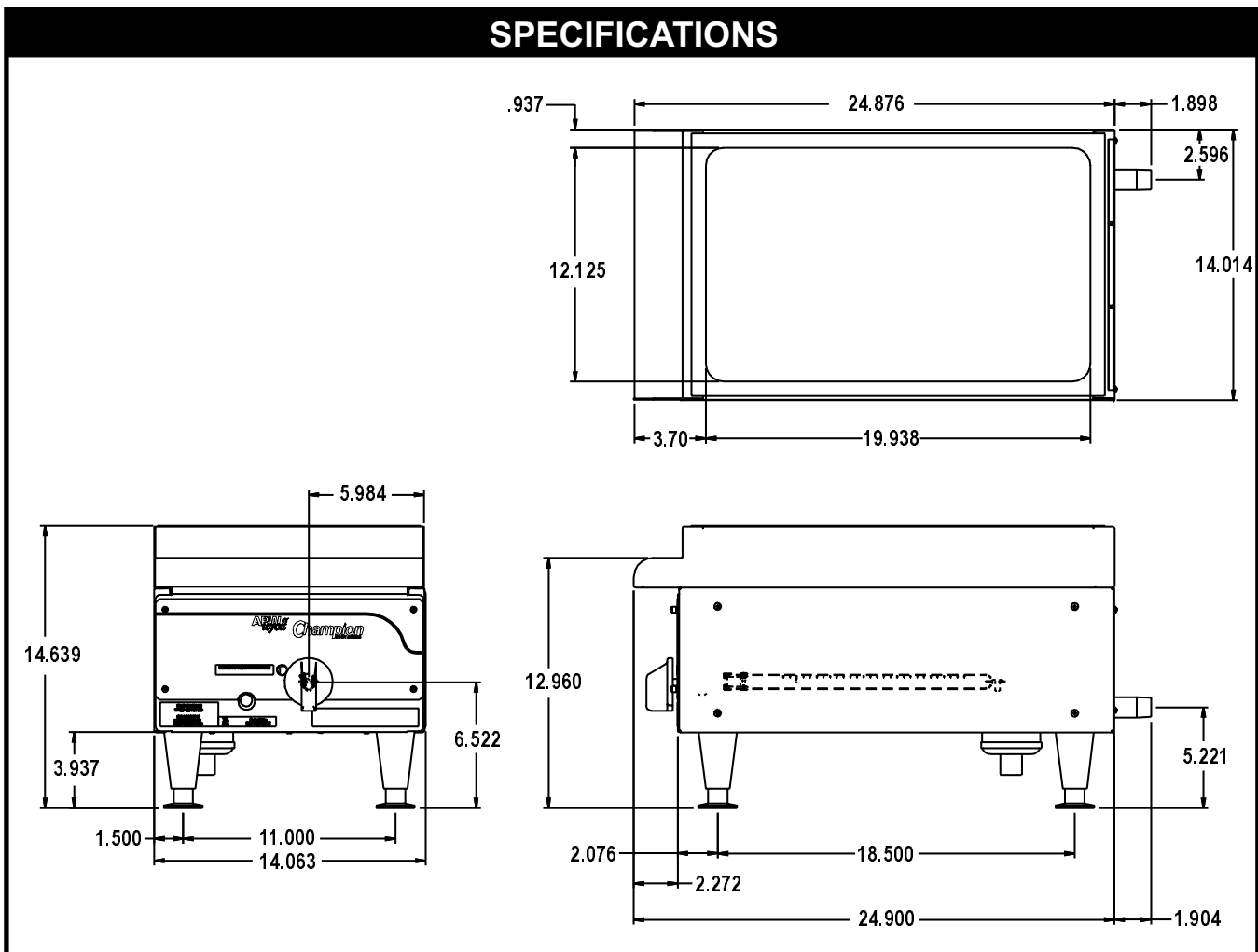

## 4. LIGHTING INSTRUCTIONS

Lighting instructions are located on the inside of the front panel. Access to the manifold and pilot valves are gained through the front panel.

### Lighting Pilot Burner:

1. Turn on main gas supply to unit.
2. Turn the burner control knob to the "OFF" position. Open the front panel and wait at least 5 minutes to allow any gas which may have accumulated in the burner compartment to escape.
3. Depress red button on pilot safety valve and light through observation hole in manifold baffle. Keep red button on pilot safety valve depressed for at least 1 minute after pilot has lit. If pilot does not light, repeat this step.
4. To adjust the pilot flame, turn adjustment screw next to the red button. Turning the adjustment screw clockwise increases the pilot flame. A properly sized pilot should be 1/2" to 3/4" long.
5. These units are equipped with a factory preset regulator with an outlet pressure of 4" W.C. (Water column) for natural gas and 10" W.C. For propane gas supply, and should require no further adjustment.

### Lighting Main Burner:

Since the burner is lit from constantly burning pilot, turn knob to "HI" to put the unit in operation; then adjust to any desired position between "LO" and "HI".

### Main Burner Air Supply:

For efficient burner operation, a proper balance of gas volume and primary air supply must be maintained which will result in complete combustion. Insufficient air supply results in a yellow streaming flame. Primary air supply is controlled by an air shutter on the burner.

Loosen the screws on the front of the burner, and adjust the air shutter to eliminate the yellow on the burner flame. Lock the air shutter in place by tightening the screws.

All burners are lit from constantly burning pilots, turning the control valve as desired is all that is required to put the unit in service.

Do not permit fans to blow directly on the unit. Wherever possible, avoid open windows next to the unit's sides or back. Avoid wall type fans which create air cross-currents within the room.

It is also necessary that sufficient air should be allowed to enter the room to compensate for the amount of air removed by any ventilating system. Otherwise, a subnormal atmosphere will occur, adversely affecting operation and causing undesirable working conditions.

A properly designed and installed hood will act as the heart of the ventilating system for the room or area in which the unit is installed, and will leave the unit independent of changing draft conditions.

All valves must be checked and lubricated periodically. Consult the authorized service representative in your area.

## 5. MAINTENANCE

### Extended Shutdown:

Turn the manual shutoff valve to "OFF"; turn all control knobs to the "OFF" position and shut off the pilot flame by turning the adjustment screw on the pilot valve.

The entire flue duct opening, located on the rear of the unit, must be left uncovered.

### Daily:



1. The appliance is not a cooking device. It is intended to keep hot cooked foods at serving temperatures.

**CAUTION: The foodwarmer is for wet operation only. Do not operate the unit dry. If the unit runs dry, follow these steps:**

- A. Turn control knob to "OFF".
  - B. Wait until the pan well is cool enough to be handled. Do not pour water in the hot pan well.
  - C. Remove pan well and thoroughly wash the internal bottom surface per weekly cleaning instructions.
  - D. Replace pan well, add water and resume normal operation.
2. For proper operation, add approximately three quarts of water in the pan well. Check amount of water daily, or after every four hours of operation. Add water as necessary.
  3. The pan well is not intended for use as a food container, but only to store water. Food to be kept warm must be in separate containers.
  4. Since the burner is lit from a constantly burning pilot, turn the control knob to "HI" to put the unit in operation; then adjust to any desired position between "LO" and "HIGH".
  5. Turn unit on about 15 to 20 minutes before use.
  6. Clean pan well and top surface daily. Clean unit regularly. A clean unit looks nicer, lasts longer and performs better.

**Weekly:**

Clean the pan well thoroughly. If necessary, use steel wool on warm pan well. A detergent may also be used on the pan well to help clean it, but care must be taken to ensure that the detergent is thoroughly removed.

	<b>CAUTION:</b> Clean the regulator at least once a month. Make sure the vent opening is open and not blocked in any way. Failure to do so will cause variations in pressure. Your unit will not function as well and it could shorten the life of the product.	
--	---	--

## 6. CONVERSION

For conversion from natural gas to propane (L.P.).

This conversion should be done before connecting the unit to the gas supply.

1. Remove the knobs and front panel.
2. Remove the main burners.
3. Remove the orifice fittings from the valves.
4. Replace the orifice fittings with the size recommended for propane (L.P.).
5. Replace the main burners.
6. With the unit on its back or side, reverse the plug in the pressure regulator. The marking on the plug while facing out should match the type of gas supplied.
7. Replace the front panel and knobs.
8. Continue with the installation.

**Note:** Manifold pressure should be checked after the unit is connected to the gas supply. It should be 10 inches (25.4 cm) water column for (L.P.). Leak test all joints.

If you should have any questions or problems, contact your nearest APW Wyott Service Representative.

# REPLACEMENT PARTS LIST & EXPLODED VIEW

48 49 50 51 → NOT SHOWN

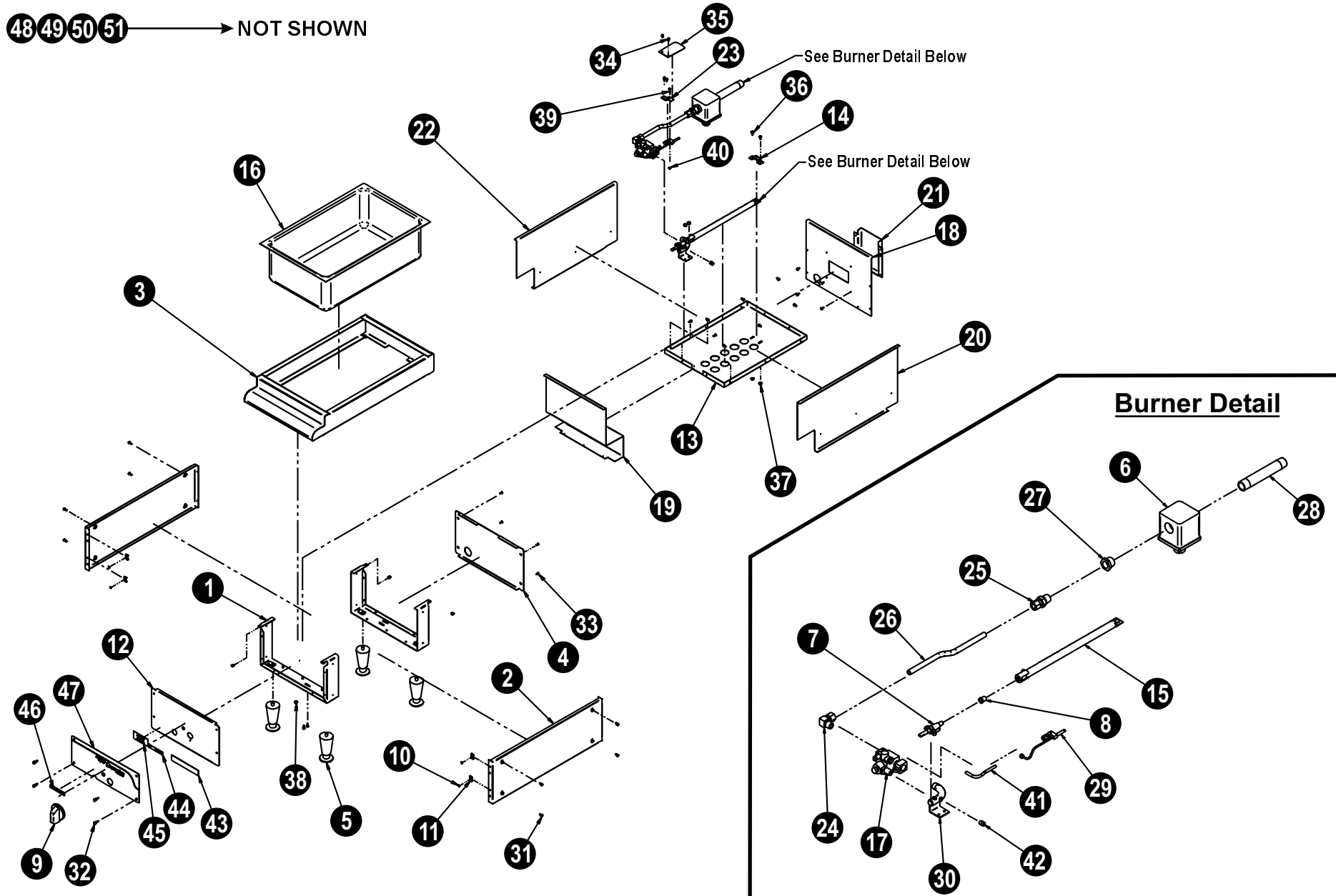



ITEM	PART NUMBER	DESCRIPTION	QUANTITY
1	21817920	SUPPORT, LEG, 14"	2
2	21813313	SIDE PANEL, LH & RH	2
3	21817910	WELDMENT, TOP, WELL	1
4	21817921	BACK PANEL	1
5	86320-00	LEG, 4"	4
6	2066105	PRESSURE REG, 3/4NPT	1
7	2068000	VALVE, GAS, ON-OFF	1
8	2066842	HOOD, ORIFICE, #42	1
9	8705600	KNOB, MED. DUTY UNIT	1
10	8196602	RETAINER	4
11	8196601	NUT, U-TYPE	4
12	21817927	FRONT PANEL,	1
13	21817928	BOTTOM PANEL	1
14	82016400	BRCKT, BURNER SUPPORT	1
15	2065815	BURNER, GAS WARMER	1
16	3100719	PAN, WARMER WELL	1
17	2065607	PILOT SFTY VALVE, 300°F	1
18	21817922	PANEL, INSIDE, BACK	1
19	21817923	FRONT SHIELD	1
20	21817925	PANEL, INSIDE RIGHT	1
21	21817926	FLUE, 14" GAS WARMER	1
22	21817924	PANEL, INSIDE, LEFT	1
23	82016801	PILOT MOUNTING BRACKET	1
24	2092502	ELBOW, 1/2 C x 3/8 NPT	1
25	2092526	UNION 1/2C TO 1/2IPT	1
26	21817930	TUBING, BURNER	1
27	2092591	REDUCER, HEX BUSHING	1
28	2092588	NIPPLE, 3/4 X 6	1
29	2066153	PILOT	1
30	2066008	MANIFOLD, ASSEMBLY	1
31	8170700	SCREW, 10-32x1/2, TYPE AB	8
32	3100724	CAPTIVE SCRW, QK OPEN	4
33	81300-00	8-32 X 3/8 TYPE T	4
34	8153100	#8-32 x 3/8 TYPE T	25
35	21817931	PILOT SHIELD	1
36	81629-00	#10-24 X 1/2 TR HD S/S	4
37	84237-00	HEX NUT 10-32 KEPS	4
38	8417100	NUT, HEX, KEPS 10-32	4
39	8110100	M/S TR HD PH 6-32x3/4"	1
40	8402900	KEPS HEX NUT, 6-32 SS	1
41	21817929	TUBE, PILOT SUPPLY	1
42	2092517	PLUG, 1/8 NPTM	1
43	8837129	LABEL, INSTR.-LOCATION	1
44	8832600	LABEL, SERVICE HOTLINE	1
45	8825300	DECAL, LEG	1
46	8837123	LABEL, OBSERVATION HOLE	1
47	21817932	DECAL, FRONT PANEL 14"	1
48*	2907500	CARTON, RSC <b>(NOT SHOWN)</b>	1
49*	2300100	BAGS, POLY 36X27X44 <b>(NOT SHOWN)</b>	1
50*	8837400	BOX LABEL, APW/WYOTT <b>(NOT SHOWN)</b>	1
51*	8899300	LIST OF SERVICE AGENCIES <b>(NOT SHOWN)</b>	1



## APW WYOTT EQUIPMENT LIMITED WARRANTY

APW Wyott Foodservice Equipment Company warrants its equipment against defects in materials and workmanship, subject to the following conditions:

This warranty applies to the original owner only and is not assignable.

Should any product fail to function in its intended manner under normal use within the limits defined in this warranty, at the option of APW Wyott such product will be repaired or replaced by APW Wyott or its Authorized Service Agency. APW Wyott will only be responsible for charges incurred or service performed by its Authorized Service Agencies. The use of other than APW Wyott Authorized Service Agencies will void this warranty and APW Wyott will not be responsible for such work or any charges associated with same. The closest APW Wyott Authorized Service Agent must be used.

This warranty covers products shipped into the 48 contiguous United States, Hawaii, metropolitan areas of Alaska and Canada. There will be no labor coverage for equipment located on any island not connected by roadway to the mainland.

Warranty coverage on products used outside the 48 contiguous United States, Hawaii, and metropolitan areas of Alaska and Canada may vary. Contact the international APW Wyott distributor, dealer, or service agency for details.

### Time Period

One year for parts and one year for labor, effective from the date of purchase by the original owner. The Authorized Service Agency may, at their option, require proof of purchase. Parts replaced under this warranty are warranted for the un-expired portion of the original product warranty only.

### Exceptions

- \***Gas/Electric Cookline:** Models GCB, GCRB, GF, GGM, GGT, CHP-H, EF, EG, EHP. Three (3) Year Warranty on all component parts, except switches and thermostats. (2 additional years on parts only. No labor on second or third year.)
- \***Broiler Briquettes, Rock Grates, Cooking Grates, Burner Shields, Fireboxes:** 90 Day Material Only. No Labor.
- \***Heat Strips:** Models FD, FDL, FDD, FDDL. Two (2) Year Warranty on element only. No labor second year.
- \***Glass Windows, Doors, Seals, Rubber Seals, Light Bulbs:** 90 Day Material Only. No Labor.

In all cases, parts covered by extended warranty will be shipped FOB the factory after the first year.

### Portable Carry In Products

Equipment weighing over 70 pounds or permanently installed will be serviced on-site as per the terms of this warranty. Equipment weighing 70 pounds or under, and which is not permanently installed, i.e. with cord and plug, is considered portable and is subject to the following warranty handling limitations. If portable equipment fails to operate in its intended manner on the first day of connection, or use, at APW Wyott's option or its Authorized Service Agency, it will be serviced on site or replaced.

From day two through the conclusion of this warranty period, portable units must be taken to or sent prepaid to the APW Wyott Authorized Service Agency for in-warranty repairs. No mileage or travel charges are allowed on portable units after the first day of use. If the customer wants on-site service, they may receive same by paying the travel and mileage charges. Exceptions to this rule: (1) countertop warmers and cookers, which are covered under the Enhanced Warranty Program, and (2) toasters or rollergrills which have in store service.

### Exclusions

The following conditions are not covered by warranty:

- \*Equipment failure relating to improper installation, improper utility connection or supply and problems due to ventilation.
- \*Equipment that has not been properly maintained, calibration of controls, adjustments, damage from improper cleaning and water damage to controls.
- \*Equipment that has not been used in an appropriate manner, or has been subject to misuse or misapplication, neglect, abuse, accident, alteration, negligence, damage during transit, delivery or installation, fire, flood, riot or act of god.
- \*Equipment that has the model number or serial number removed or altered.

If the equipment has been changed, altered, modified or repaired by other than an Authorized Service Agency during or after the warranty period, then the manufacturer shall not be liable for any damages to any person or to any property, which may result from the use of the equipment thereafter.

This warranty does not cover services performed at overtime or premium labor rates. Should service be required at times which normally involve overtime or premium labor rates, the owner shall be charged for the difference between normal service rates and such premium rates. APW Wyott does not assume any liability for extended delays in replacing or repairing any items beyond its control.

In all cases, the use of other than APW Wyott Authorized OEM Replacement Parts will void this warranty.

This equipment is intended for commercial use only. Warranty is void if equipment is installed in other than commercial application.

### Water Quality Requirements

Water supply intended for a unit that has in excess of 3.0 grains of hardness per gallon (GPG) must be treated or softened before being used. Water containing over 3.0 GPG will decrease the efficiency and reduce the operation life of the unit.

**Note: Product failure caused by liming or sediment buildup is not covered under warranty.**

**"THE FOREGOING WARRANTY IS IN LIEU OF ANY AND ALL OTHER WARRANTIES EXPRESSED OR IMPLIED INCLUDING ANY IMPLIED WARRANTY OF MERCHANTABILITY OR FITNESS FOR PARTICULAR PURPOSES AND CONSTITUTES THE ENTIRE LIABILITY OF APW WYOTT. IN NO EVENT DOES THE LIMITED WARRANTY EXTEND BEYOND THE TERMS STATED HEREIN."**

9/05



---

**APW WYOTT Foodservice Equipment Company**

P.O. Box 1829  
Cheyenne, WY 82003

+1 (307) 634-5801 Phone  
+1 (307) 637-8071

+1 (800) 752-0863 Toll Free  
[www.apwwyott.com](http://www.apwwyott.com)