



INSTALLATION AND OPERATING INSTRUCTIONS

HEATED PUMP/DISPENSERS

Models:

CCW MK VII - 120V (43593-01)

CCW MK VII - 240V (43593-25)

RCCW MK VII - 120V (43593-90)

LCCW MK VII - 120V (43593-00)

RLCCW MK VII - 120V (43593-95)

RLCCW MK VII - 220V/240V (43593-20)

INTENDED FOR OTHER THAN HOUSEHOLD USE



WARNING: Improper installation, adjustment, alteration, service or maintenance can cause property damage, injury or death. Read the Installation, Operating and Maintenance Instructions thoroughly before installing or servicing this equipment.



IMPORTANT FOR FUTURE REFERENCE

Please complete this information and retain this manual for the life of the equipment. For Warranty Service and/or Parts, this information is required.

Model Number

Serial Number

Date Purchased

This equipment has been engineered to provide you with year-round dependable service when used according to the instructions in this manual and standard commercial kitchen practices.

Phone: +1 (307) 634-5801
Fax: +1 (307) 637-8071
Toll Free: +1 (800) 752-0863
Website: www.apwwyott.com
E-mail: info@apwwyott.com

P/N 88828-07 9/05

APW WYOTT
P.O. Box 1829
Cheyenne, WY 82003

APW Wyott takes pride in the design and quality of our products. When used as intended and with proper care and maintenance, you will experience years of reliable operation from this equipment. To ensure best results, it is important that you read and follow the instructions in this manual carefully.



Installation and start-up should be performed by a qualified installer who thoroughly read, understands and follows these instruction.



If you have questions concerning the installation, operation, maintenance or service of this product, write Technical Service Department APW/Wyott Foodservice Equipment Company, P.O. Box 1829, Cheyenne, WY 82003.



SAFETY PRECAUTIONS



Before installing and operating this equipment be sure everyone involved in its operation are fully trained and are aware of all precautions. Accidents and problems can result by a failure to follow fundamental rules and precautions.



The following words and symbols, found in this manual, alert you to hazards to the operator, service personnel or the equipment. The words are defined as follows:



 **DANGER:** This symbol warns of imminent hazard which will result in serious injury or death. 



 **WARNING:** This symbol refers to a potential hazard or unsafe practice, which could result in serious injury or death. 



 **CAUTION:** This symbol refers to a potential hazard or unsafe practice, which may result in minor or moderate injury or product or property damage. 



 **NOTICE:** This symbol refers to information that needs special attention or must be fully understood even though not dangerous. 



 **CAUTION:** These models are designed, built, and sold for commercial use. If these models are positioned so the general public can use the equipment make sure that cautions, warnings, and operating instructions are clearly posted near each unit so that anyone using the equipment will use it correctly and not injure themselves or harm the equipment. 

 **IMPORTANT:** We strongly recommend having a licensed electrician install this equipment. The electrician should be familiar with all local and national electrical codes. 



 **WARNING:** Check the data plate on this unit before installation. Connect the unit only to the voltage and frequency listed on the data plate. Connect only to 1 or 3 phase as listed on the data plate. 

 **NOTICE:** The unit when installed, must be electrically grounded and comply with local codes, or in the absence of local codes, with the national electrical code ANSI/NFPA70- latest edition. Canadian installation must comply with CSA-STANDARD C.22.2 Number 0 M1982 General Requirements-Canadian Electrical Code Part II, 109-M1981- Commercial Cooking Appliances. 

 **WARNING:** Disconnect device from electrical power supply and place a Tag Out-Lockout on the power plug, indicating that you are working on the circuit. 

 **WARNING:** Install per the spacing requirements listed in the installation section of this manual. We strongly recommend having a competent professional install the equipment. A licensed electrician should make the electrical connections and connect power to the unit. Local codes should always be used when connecting these units to electrical power. In the absence of local codes, use the latest version of the National Electrical Code. 

 **WARNING:** Improper installation, adjustment, alteration, service or maintenance can cause property damage, injury or death. Read the Installation, Operating and Maintenance Instructions thoroughly before installing or servicing this equipment. 

 **CAUTION:** Maintenance & repair should be handled by a factory authorized agent. Before doing any maintenance or repair, contact APW Wyott. 

IMMEDIATELY INSPECT FOR SHIPPING DAMAGE

All containers should be examined for damage before and during unloading. The freight carrier has assumed responsibility for its safe transit and delivery. If equipment is received damaged, either apparent or concealed, a claim must be made with the delivering carrier.

A) Apparent damage or loss must be noted on the freight bill at the time of delivery. It must then be signed by the carrier representative (Driver). If this is not done, the carrier may refuse the claim. The carrier can supply the necessary forms.

B) Concealed damage or loss if not apparent until after equipment is uncrated, a request for inspection must be made to the carrier within 15 days. The carrier should arrange an inspection. Be certain to hold all contents and packaging material.

Installation and start-up should be performed by a qualified installer who thoroughly read, understands and follows these instructions.

CONTENTS

Safety Precautions.....	2
General Information.....	3
Cleaning The Dispenser.....	4
Cleaning The Pump.....	4
Sanitizing Guidelines.....	5
Parts Lists w/Exploded Views.....	6
Warranty.....	7

GENERAL INFORMATION

General Installation

1. Always clean equipment thoroughly before first use. (See general cleaning instructions.)
2. Check rating label for your model designation & electrical rating.
3. For best results, use stainless steel counter tops.
4. Attach legs to units, if needed.

General Operation Instructions

1. All foodservice equipment should be operated by trained personnel.
2. Do not allow your customers to come in contact with any surface labeled "CAUTION HOT".
3. Where applicable, never pour cold water into dry heated units.
4. Where applicable, do not cook, warm or hold food directly in liner pans (well) pans. Always use steam table pans/insets, etc. .
5. NEVER hold food below 140° F.

General Cleaning Instructions

1. NEVER clean any electrical unit by immersing it in water. Turn unit off and allow to cool down before surface cleaning.
2. Always clean equipment thoroughly before first use. Clean unit daily. Except where noted on charts: Use warm, soapy water. Mild cleansers & PLASTIC scouring pads may be used to remove baked-on food and water scale on metal units.
3. Unplug electrical units before cleaning or servicing. All service should be performed by an APWWYOTT authorized service agency.

General Troubleshooting

Always ask & check:

1. Is the unit connected to a live power source.
2. Check circuit breaker.
3. Is power switch on?
4. Check rating label. Are you operating unit on proper voltage? .

If the above checks out and you still have problems, call an APWWYOTT authorized service agency.

Operating

1. Clean the dispenser and pump according to the cleaning instructions before using the first time.
2. This dispenser is intended for heating food by the double-boiler method. Product purchased in a No.10 size can may be heated in the original can. Be sure to remove the top first. If contents of No.10 can are not to be completely used in a day, the optional stainless container, Part No. 43593-50 is recommended. This container will not rust as the commercial can does.

Putting food directly into the dispenser is not recommended as it might scorch and stick. In addition, the pump suction tube will be about 1 1/8" short of the bottom.

3. Put 2 1/2 cups of water into the pot (do not overfill) making certain the spider (16) is in place before putting in either the can or the container of food.
4. Plug power cord into appropriate, grounded outlet.

NOTE: Increase or decrease the temperature as required; the settings are in approximately 12°F increments, a value which will change slightly with ambient temperature and voltage. If a specific temperature is required, use a product thermometer. After setting, allow 30 minutes for temperature to stabilize. Stirring will speed stabilizing. Remember, thick materials such as cheese or fudge conduct heat poorly.

If the dispenser steams noticeably, the temperature setting should be reduced.

CLEANING THE DISPENSER

NOTE: Refer to the pump instructions for cleaning the pump.

1. The outer shell of the dispenser is stainless steel. Wipe it with a clean, damp cloth and mild detergent.

Warning: Avoid abrasive cleaners which can damage the stainless steel finish. Do not immerse the heated dispenser in water or damage to the electrical parts or shock hazard could occur.

2. Wash the inside of the dispenser with detergent and water, but DO NOT IMMERSE. Rinse well but avoid spraying water in control knob opening or around the lighted display.
3. Prepare a sanitizing solution according to the Sanitizing Guidelines. Place the solution into the container for about 10 minutes. Pour it out and allow the dispenser to air dry. Do not touch the inside of the container after sanitizing it.

CLEANING THE PUMP

Clean the pump daily according to the following instructions. Note the way the pump comes apart, so you can reassemble it in reverse order.

1. Remove the spout plug (10) with its O-ring (11).
2. While holding the pump with lid upright, (as it is on the warmer), unscrew, counterclockwise, the retaining nut (3) and lift out the knob (1), piston rod (2), seal (4), O-ring (5) and spacer (32).
3. While still upright, lift off pot cover (19) and thread it over the spout.
4. Still upright, remove plug (8) with its O-ring (9).
5. Tip the pump body weldment (22) to remove balls (7) and spring (6).
6. Exercising care not to nick or scratch any surface, separate the seal and O-rings, (4), (5), (9), and (11), from the mating steel parts.
7. Wash all parts thoroughly in detergent and water using the brush provided; rinse in hot water. Wash seal and O-rings separately from metal parts to avoid damage to the soft seal and O-ring surfaces. A very small nick can cause a large leak.
8. Reassemble the pump and lid using reverse procedure. Be sure to replace the spring tang down.

9. Prepare a sanitizing solution and pump it through the pump, dispensing at least 1/2 cup of sanitizer.
10. Allow the sanitizer to stand in the pump for about 10 minutes, then drain it from the pump and container. Allow them to air dry.
CAUTION: Do not touch the insides of the container or pump with your hands after sanitizing.

SANITIZING GUIDELINES

Sanitize the heated dispenser at least once each day using the following four-step procedure:

1. Wash with detergent
2. Rinse with warm water
3. Sanitize with an approved sanitizer (specifications below)
4. Allow to air dry

Some local health departments have a list of approved brand food equipment sanitizers. That list can help you choose an acceptable sanitizer for this machine. If your health department does not have the list, you may acquire one from the State of Wisconsin, by writing to:

State of Wisconsin
Division of Health
Dept. of Health and Social Services P.O. Box 309
Madison, WI 53701

When preparing the sanitizing solution, make sure it contains the chemical compound, Quaternary Ammonium ("Quat"). Following the manufacturer's label instructions, prepare the solution with a minimum concentration of 200 parts per million (PPM).

NOTE: Do not use chlorine-based sanitizers because they may damage the plastic parts.

Do not use iodine-based sanitizers because they may discolor the plastic parts and disflavor the product.

PARTS LIST & EXPLODED VIEW

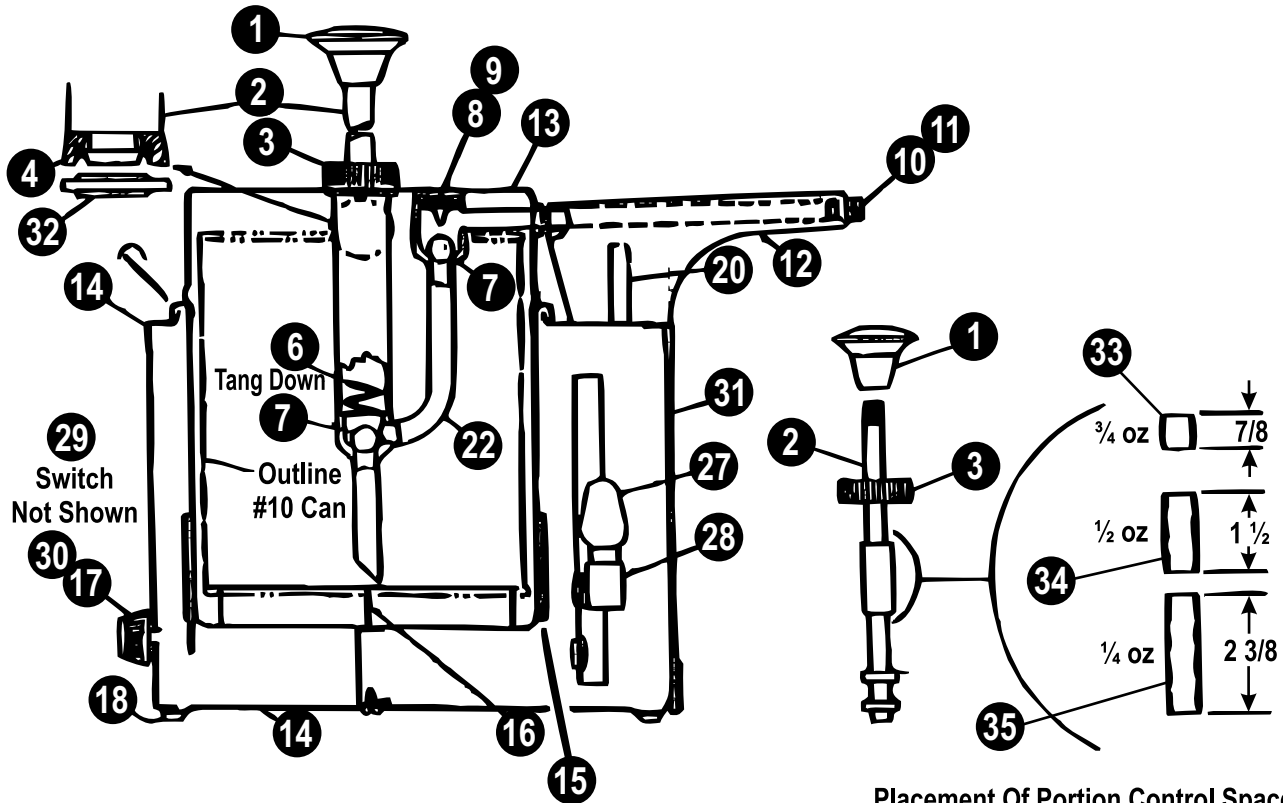

Placement Of Portion Control Spacer

Item	P/N	Description	Item	P/N	Description
1	87314-00	Knob	20	14046-00	Ceramic Heater, 120V
2	40709-00	Piston Rod		14046-01	Ceramic Heater, 240V
3	43773-00	Retaining Nut	21	43593-10	Pot Weldment
4	21139-00	Seal	22	43593-31	Pump Body Weldment
5	21325-00	O-Ring	*27	15198-00	Lamp, 10W, 125V <i>Lighted (L) Models Only</i>
6	89500-00	Spring			NOTE: Lamps are wired in parallel for 120V, & in series for 240V
7	86605-00	Ball	*28	15198-01	Lamp Socket
8	43593-32	Plug	29	13318-00	Switch
9	21326-00	O-Ring	30	87007-00	Thermostat Knob
10	43593-33	Spout Plug	31	458062-00	Transparencies: Hot Cheese Nachos <i>Lighted (L) Models Only</i>
11	21118-10	O-Ring		458063-00	Transparencies: Hot Buttery Popcorn <i>Lighted (L) Models Only</i>
12	43593-22	Heater Housing, 120V		458064-00	Transparencies: Hot Fudge <i>Lighted (L) Models Only</i>
	43593-24	Heater Housing, 240V		458066-00	Transparencies: Hot Cheese <i>Lighted (L) Models Only</i>
13	43593-03	Box Weldment: CCW		458068-00	Transparencies: Hot Dog Chili <i>Lighted (L) Models Only</i>
	43593-02	Box Weldment: LCCW		456822-00	Decals: Hot Cheese Nachos <i>Un-Lighted Models Only</i>
	43593-91	Box Weldment: RCCW		456815-00	Decals: Hot Buttery Popcorn <i>Un-Lighted Models Only</i>
	43593-94	Box Weldment: RLCCW		456814-00	Decals: Hot Fudge <i>Un-Lighted Models Only</i>
14	43593-09	Box Bottom		456796-00	Decals: Hot Cheese <i>Un-Lighted Models Only</i>
15	14047-50	Heater, 120V		456798-00	Decals: Hot Dog Chili <i>Un-Lighted Models Only</i>
	14047-51	Heater, 240V	32	43593-60	Spacer
16	43593-19	Spider	33	43593-99	3/4 oz. Spacer Portion Control
17	14898-00	Thermostat	34	43593-98	1/2 oz. Spacer Portion Control
18	21164-01	Foot	35	43593-97	1/4 oz. Spacer Portion Control
19	43593-12	Pot Cover			

APW WYOTT EQUIPMENT LIMITED WARRANTY

APW Wyott Foodservice Equipment Company warrants its equipment against defects in materials and workmanship, subject to the following conditions:

This warranty applies to the original owner only and is not assignable.

Should any product fail to function in its intended manner under normal use within the limits defined in this warranty, at the option of APW Wyott such product will be repaired or replaced by APW Wyott or its Authorized Service Agency. APW Wyott will only be responsible for charges incurred or service performed by its Authorized Service Agencies. The use of other than APW Wyott Authorized Service Agencies will void this warranty and APW Wyott will not be responsible for such work or any charges associated with same. The closest APW Wyott Authorized Service Agent must be used.

This warranty covers products shipped into the 48 contiguous United States, Hawaii, metropolitan areas of Alaska and Canada. There will be no labor coverage for equipment located on any island not connected by roadway to the mainland.

Warranty coverage on products used outside the 48 contiguous United States, Hawaii, and metropolitan areas of Alaska and Canada may vary. Contact the international APW Wyott distributor, dealer, or service agency for details.

Time Period

One year for parts and one year for labor, effective from the date of purchase by the original owner. The Authorized Service Agency may, at their option, require proof of purchase. Parts replaced under this warranty are warranted for the un-expired portion of the original product warranty only.

Exceptions

- ***Gas/Electric Cookline:** Models GCB, GCRB, GF, GGM, GGT, CHP-H, EF, EG, EHP. Three (3) Year Warranty on all component parts, except switches and thermostats. (2 additional years on parts only. No labor on second or third year.)
- ***Broiler Briquettes, Rock Grates, Cooking Grates, Burner Shields, Fireboxes:** 90 Day Material Only. No Labor.
- ***Heat Strips:** Models FD, FDL, FDD, FDDL. Two (2) Year Warranty on element only. No labor second year.
- ***Glass Windows, Doors, Seals, Rubber Seals, Light Bulbs:** 90 Day Material Only. No Labor.

In all cases, parts covered by extended warranty will be shipped FOB the factory after the first year.

Portable Carry In Products

Equipment weighing over 70 pounds or permanently installed will be serviced on-site as per the terms of this warranty. Equipment weighing 70 pounds or under, and which is not permanently installed, i.e. with cord and plug, is considered portable and is subject to the following warranty handling limitations. If portable equipment fails to operate in its intended manner on the first day of connection, or use, at APW Wyott's option or its Authorized Service Agency, it will be serviced on site or replaced.

From day two through the conclusion of this warranty period, portable units must be taken to or sent prepaid to the APW Wyott Authorized Service Agency for in-warranty repairs. No mileage or travel charges are allowed on portable units after the first day of use. If the customer wants on-site service, they may receive same by paying the travel and mileage charges. Exceptions to this rule: (1) countertop warmers and cookers, which are covered under the Enhanced Warranty Program, and (2) toasters or rollergrills which have in store service.

Exclusions

The following conditions are not covered by warranty:

- *Equipment failure relating to improper installation, improper utility connection or supply and problems due to ventilation.
- *Equipment that has not been properly maintained, calibration of controls, adjustments, damage from improper cleaning and water damage to controls.
- *Equipment that has not been used in an appropriate manner, or has been subject to misuse or misapplication, neglect, abuse, accident, alteration, negligence, damage during transit, delivery or installation, fire, flood, riot or act of god.
- *Equipment that has the model number or serial number removed or altered.

If the equipment has been changed, altered, modified or repaired by other than an Authorized Service Agency during or after the warranty period, then the manufacturer shall not be liable for any damages to any person or to any property, which may result from the use of the equipment thereafter.

This warranty does not cover services performed at overtime or premium labor rates. Should service be required at times which normally involve overtime or premium labor rates, the owner shall be charged for the difference between normal service rates and such premium rates. APW Wyott does not assume any liability for extended delays in replacing or repairing any items beyond its control.

In all cases, the use of other than APW Wyott Authorized OEM Replacement Parts will void this warranty.

This equipment is intended for commercial use only. Warranty is void if equipment is installed in other than commercial application.

Water Quality Requirements

Water supply intended for a unit that has in excess of 3.0 grains of hardness per gallon (GPG) must be treated or softened before being used. Water containing over 3.0 GPG will decrease the efficiency and reduce the operation life of the unit.

Note: Product failure caused by liming or sediment buildup is not covered under warranty.

"THE FOREGOING WARRANTY IS IN LIEU OF ANY AND ALL OTHER WARRANTIES EXPRESSED OR IMPLIED INCLUDING ANY IMPLIED WARRANTY OF MERCHANTABILITY OR FITNESS FOR PARTICULAR PURPOSES AND CONSTITUTES THE ENTIRE LIABILITY OF APW WYOTT. IN NO EVENT DOES THE LIMITED WARRANTY EXTEND BEYOND THE TERMS STATED HEREIN."

9/05



Phone: +1 (307) 634-5801
Fax: +1 (307) 637-8071
Toll Free: +1 (800) 752-0863
Website: www.apwwyott.com
E-mail: info@apwwyott.com

APW WYOTT
P.O. Box 1829
Cheyenne, WY 82003