

# Owner's Manual



## Commercial Microwave Oven

Keep these instructions for future reference.  
If the oven changes ownership, this manual  
must accompany oven.

### Contents

Model Identification .....	2
Grounding/Earthing Instructions .....	3
Installation .....	3
Display and Features .....	4
Using the Oven Control (Electronic Models) .....	7
Programming the Oven Control (Electronic Models) .....	8
Electronic Dial Operation .....	9
Care and Cleaning .....	10
Before Calling for Service .....	10

# Model Identification

---

When contacting Amana, provide product information. Product information is located on oven serial plate. Record the following information:

Model Number: \_\_\_\_\_

Serial or S/N Number: \_\_\_\_\_

Date of installation: \_\_\_\_\_

Dealer's name and address: \_\_\_\_\_

\_\_\_\_\_

\_\_\_\_\_

Any questions or to locate an authorized Amana servicer, call Amana ComServ Service Support.

– **Inside** the U.S.A. or Canada, call toll-free at 866-426-2621.

– **Outside** the U.S.A. and Canada, call 319-622-2808.

– **Email:** [CommercialService@amana.com](mailto:CommercialService@amana.com).

Warranty service must be performed by an authorized Amana servicer. Amana also recommends contacting an authorized Amana servicer, or Amana ComServ Service Support if service is required after warranty expires.

## Unpacking Oven

- Inspect oven for damage such as dents in door or inside oven cavity.
- Report any dents or breakage to source of purchase immediately.  
**Do not attempt to use oven if damaged.**
- Remove all materials from oven interior.
- If oven has been stored in extremely cold area, wait a few hours before connecting power.

## Radio Interference

Microwave operation may cause interference to radio, television, or a similar oven. Reduce or eliminate interference by doing the following:

- Clean door and sealing surfaces of oven according to instructions in *Care and Cleaning* section.
- Place radio, television, etc. as far as possible from oven.
- Use a properly installed antenna on radio, television, etc. to obtain stronger signal reception.

## Oven Placement

- Do not install oven next to or above source of heat, such as pizza oven or deep fat fryer. This could cause microwave oven to operate improperly and could shorten life of electrical parts.
- Do not block or obstruct oven filter. Allow access for cleaning.
- Install oven on level countertop surface.
- Place warning label in a conspicuous place close to microwave oven. (50 Hz models only)
- Outlet should be located so that plug is accessible when oven is in place.

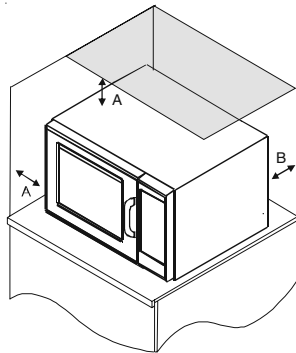

A—Allow at least 4" (10.2 cm) of clearance around top and sides of oven. Proper air flow around oven cools electrical components. With restricted air flow, oven may not operate properly and life of electrical parts is reduced.

B—Allow at least 4" (10.2 cm) between air discharge on back of oven and back wall.

### Oven Clearances

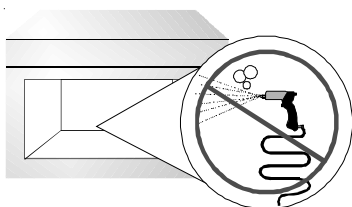

**DO NOT power spray**

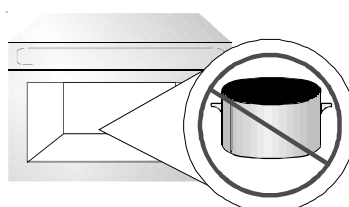

**No metal pans**

## **WARNING**

To avoid risk of electrical shock or death, this oven must be earthed.

## **WARNING**

To avoid risk of electrical shock or death, do not alter the plug.

## Grounding/Earthing Instructions

### Oven **MUST** be grounded.

Grounding reduces risk of electric shock by providing an escape wire for the electric current, if an electrical short occurs. This oven is equipped with a cord having a ground wire with a grounding plug. The plug must be plugged into an outlet that is properly installed and grounded.

Consult a qualified electrician or servicer if grounding instructions are not completely understood, or if doubt exists as to whether the oven is properly grounded.

### Do not use an extension cord.

If the product power cord is too short, have a qualified electrician install a three-slot receptacle. This oven should be plugged into a separate circuit with the electrical rating as provided in product specifications (available on Amana's wavelink website). When a microwave oven is on a circuit with other equipment, an increase in cooking times may be required and fuses can be blown.

## External Equipotential

### Earthing Terminal (*export only*)

Equipment has secondary earthing terminal. Terminal provides external earthing connection used in addition to earthing prong on plug. Located on outside of oven back, terminal is marked with symbol shown below.



# Display and Features (some models)



## START/+30 SEC Pad

The START/+30 SEC pad is used to begin a cooking cycle and to increase the reheat time in 30 second increments.

- The START/+30 SEC pad is used to reheat for 30 seconds at 100% (full power). The oven will start immediately and 30 seconds will be added to the time counting down each time the pad is pressed up to a maximum reheating time of 5 minutes.

NOTE: Pressing the START/+30 SEC pad is only available in Manual Time Entry mode.



## STOP/RESET Pad

The STOP/RESET pad stops a cooking sequence in progress and must be pressed again to clear out any remaining cooking time.

When the STOP/RESET pad is used to end a programming change, the changes are discarded.



## Single Pad Programming

This feature enables each numbered pad to be programmed for a specific cooking cycle. To use this feature, simply program the pad to the desired length of time and power level. Press the pad once and the microwave will begin cooking. Number pads 1-10 are preprogrammed at the factory, but can be changed.



## Double Pad Programming

This feature enables 10 additional programmed entries to be made. Each entry will be assigned a double digit number. When using the double pad programming, a pad must be pressed twice within 2 seconds to start the cooking cycle.



## QTY 2X Pad

The QTY 2X pad doubles the preset cooking time. The QTY 2X pad can be used with either single or double pad programming. Maximum cooking time is 60 minutes except when cooking with full power (100%). In case of full power (100%), maximum cooking time is 20 minutes.

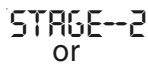

## Stage Cooking

Stage cooking is a cooking sequence with specific power level and time changes. The user can program up to three different power level changes and the specific amount of cooking time at each stage. Each power level/cooking time combination is known as a stage. Stage cooking is available only on electronic control models. Maximum cooking time is 60 minutes except when cooking with full power (100%). In case of full power (100%), maximum cooking time is 20 minutes.



## Program Pad

This feature allows you to program a number pad for a specific power level and cooking time of your choice in any stage cooking.



## Power Level Pad

The POWER LEVEL pad allows you to program a cooking cycle for a specific power level (100%, 80%, 60%, 40%).

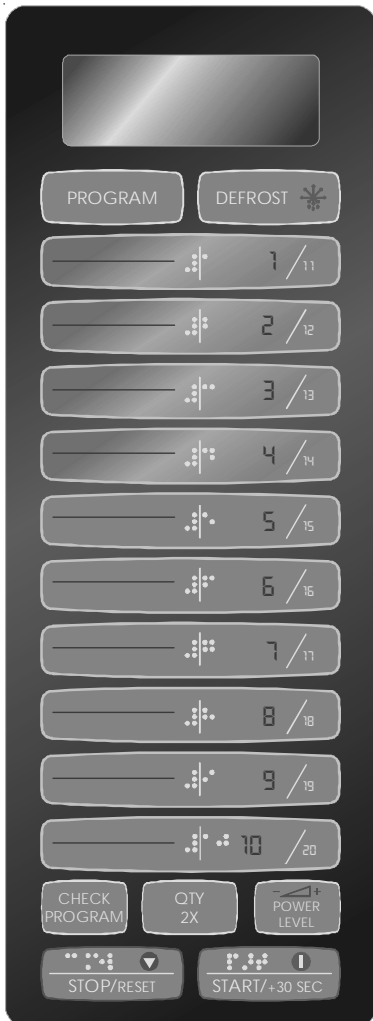

# Display and Features (some models)

## ? If These Features are Different from Yours

These features are intended to show the variety that is available in the product line. If your microwave does not have all the options that are shown, it is not a mistake. The information provided applies to several of the models in the product line.

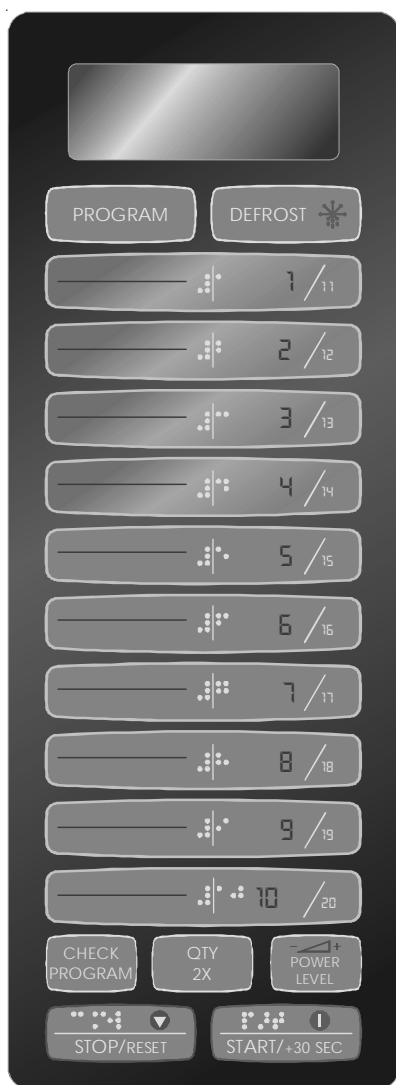

## Check Program Pad

This feature allows you to check the programmed cooking time and power level of any programmed pad.

1. Press CHECK PROGRAM pad.
  - **CHECK** displays.
2. Press desired numeric pad.
  - **PROG--XX** displays (XX indicates program number).
  - **STAGE-1** displays then flashes to cooking time and power level.  
example: **00:30 HI**
  - display repeats for next stage(s)
3. Press STOP/RESET pad to exit Check Program function.



## Power Save Mode

This function is used for saving energy by:

1. Press and hold CHECK PROGRAM pad for 3 seconds.
  - **CHECK** displays, oven beeps and display goes blank.
2. To operate oven in Power Save mode, press any pad.
  - **:0** displays and all keypad functions will be the same as in normal mode.
  - If keypad is not touched within 10 seconds, display will go blank.
3. To deactivate, press any pad and then hold CHECK PROGRAM pad for 3 seconds.
  - **CHECK** displays and oven beeps.
4. Press STOP/RESET pad to have oven return to normal operating mode.

## Program Lock Function

This feature locks the control panel and prevents unwanted oven operations.

1. Press and hold STOP/RESET pad for 3 seconds to activate.
  - Oven beeps and **:0** along with a key graphic  appear in display.
2. Press and hold STOP/RESET pad for 3 seconds to deactivate.
  - Oven beeps and key graphic  disappears from display.

## Mute Function

This function mutes the keypad beep sound (except for end of cycle beep) by:

1. Press and hold QTY 2X pad for 3 seconds.
  - **DOUBLE** displays, oven beeps and **MUTE** displays for 1 second, then **:0** appears in display.
2. To deactivate, press and hold QTY 2X pad for 3 seconds.
  - **DOUBLE** displays, oven beeps and **:0** appears in display.



## Defrost Pad

When DEFROST is selected, the automatic cycle divides the defrosting time into periods of alternating defrost and stand times by cycling on and off. Maximum defrost time is 60 minutes.

# Display and Features (some models)

## Cooking Display

DISPLAYS	DESCRIPTION
: □	Displays when oven control will accept entries.
60:00	Displays cooking time. If stage cooking is programmed, total cooking time is displayed.
DOUBLE	Displays when the QTY2X pad is pressed.
100% 80% 60% 40%	These settings display the current microwave power level used.

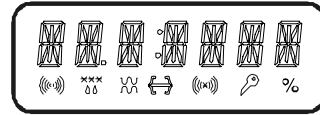

## Display

Some items in the display can be seen but are not available depending on the model. During normal operation of oven, not all items will be displayed at same time.

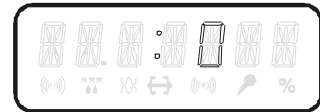

## Programming Display

DISPLAYS	DESCRIPTION
PROGRAM	Displays when oven is in programming mode.
CHECK	Displays when CHECK PROGRAM pad is pressed.
STAGE -- _	Displays when programming a specific cooking stage and when checking the cooking cycle of a programmed pad. The oven beeps once at the change of each number (1 through 3).

## Ready Condition

: □ displays when an oven control will accept entries.

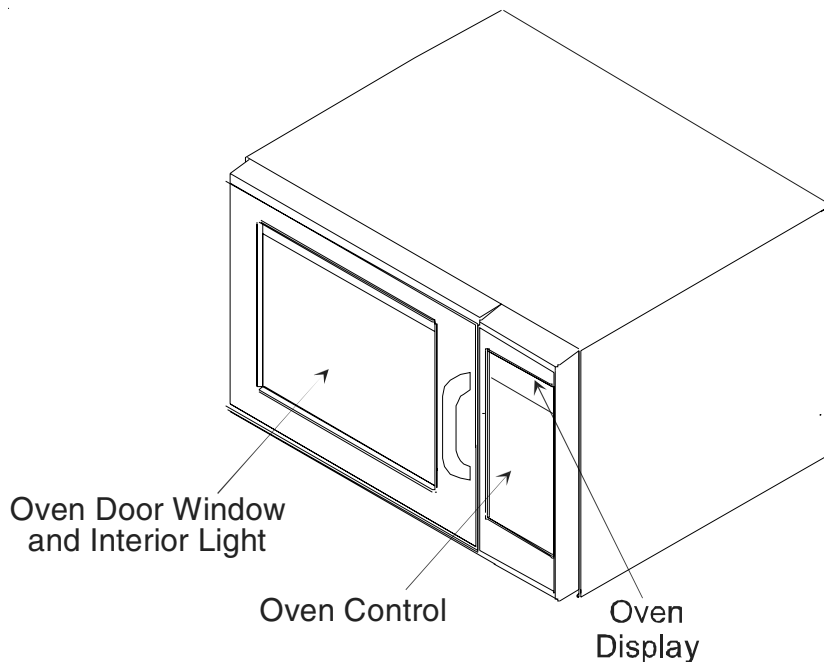

# Using Electronic Oven Control (some models only)



## Interrupting Operation

Open oven door or press STOP/RESET pad to interrupt operation. Display continues to show countdown time. Close door and press START/+30 SEC pad to resume oven operation.



## Canceling Mistakes

If oven is not cooking, press STOP/RESET pad to clear display. If oven is cooking, press STOP/RESET pad once to stop oven, then again to clear display. If oven door is open and time shows in display, close oven door and press STOP/RESET pad to clear display.

## Do I have stage programming?

Stage programming is a hidden feature—it is not shown with a pad on the oven. Stage cooking is a feature that is present when programming. See the Programmed Pads section on this page for details.



## QTY 2X Pad (some models)

To double the cooking time temporarily when cooking more than one serving. The maximum cooking time is 60 minutes 00 seconds except for full power. Full power (100%) maximum cooking time is 20 minutes 00 seconds.

- Open oven door and place food in oven. Close door.
  - :0 displays. Light will turn on.
- Press QTY 2X pad.
  - DOUBLE** displays
- Press desired preprogrammed pad or pad sequence. (example: pad 5)
  - PROG-05** displays
- After 1 second, oven begins cooking. Displayed cooking time is the total of original cooking time doubled.



## Defrost Pad

Defrosts food by dividing total defrost time into periods of alternating defrost and stand times by cycling on and off:

- Open oven door and place food in oven. Close door.
- Press DEFROST pad.
  - DEFROST indicator lights and :0 shows in the display.
- Press the number pad(s) to enter the desired defrosting time.
- Press START/+30 SEC pad.
- Oven begins to cycle.
  - The display counts down the time to show you how much defrosting time is left in the DEFROST mode.

**NOTE:** Oven beeps during the defrosting cycle to signal that the food needs to be turned or rearranged.

- Open door and rearrange food. Close door.
- Press START/+30 SEC pad to continue defrost cycle.

**NOTE:** If you don't open door to rearrange food, defrost cycle continues.

## Manual Time Entry

To cook food using a specific entered time and power level.

**NOTE:** To use Time Entry, you must press POWER LEVEL Pad first.

- Open oven door and place food in oven. Close door.
  - :0 displays. Light will turn on.
- Press POWER LEVEL pad.
  - Press POWER LEVEL pad to change power level if desired (some models).
  - Power level (example: **100%**) displays.
    - 100% indicates 100% microwave power, 80% indicates 80%, 60% indicates 60%, and 40% indicates 40% microwave power. By continuing to press the Power level pad, the power level will cycle through each level continuously.
- Enter cooking time by using the numbered pads.
- Press START/+30 SEC pad to begin cooking cycle.
  - At end of cooking cycle, oven beeps and shuts off.



## Programmed Pads

To cook food using pads preprogrammed with cooking sequences.

- Open oven door and place food in oven. Close door.
  - :0 displays. Light will turn on.
- Press desired pad.
  - For single pad entry, press only one pad.
  - For double pad entry, press same pad twice.
  - If pad has not been programmed, **NO DATA** displays.
- Oven begins to cook.
  - Total cooking time displays.
- At end of cooking cycle oven beeps and shuts off.

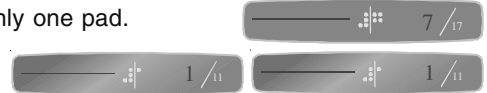

## Factory Settings

Pad	Time	Pad	Time
1	10 sec.	6	1 min. 30 sec.
2	20 sec.	7	2 min.
3	30 sec.	8	3 min.
4	45 sec.	9	4 min.
5	1 min.	0	5 min.

# Programming Electronic Oven Control (some models only)

## Programming Pads

Oven is shipped from factory with pads 1-10 preprogrammed. To re-program pads 1-10 or program pads 11-19, use the following procedures.

1. Door can be in either open or closed position with :0 showing in display.
2. Press PROGRAM pad.
  - **PROGRAM** appears in display.
3. Press desired number pad to be programmed.
  - If pad 4 is being programmed, **PROG- 04** will appear in display.
  - To program pads 11-20, press number pad twice rapidly. (ex. To program pad 15, press pad 5 twice rapidly.)
4. Press POWER LEVEL pad to select desired power level.
  - Press POWER LEVEL pad to change power level if desired (some models).
  - **POWER LEVEL** displays.
    - 100% indicates 100% (full) microwave power, 80% indicates 80%, 60% indicates 60%, and 40% indicates 40% microwave power. By continuing to press the Power level pad, the power level will cycle through each level continuously.
5. Press desired number pad(s) to program desired cooking time.
6. Press START/+30 SEC pad to save programming for Stage 1.

- If Stage 2 or Stage 3 is desired for programming, repeat steps 4 through 5.
- If Stage 2 or Stage 3 is not desired press STOP/RESET pad, to end programming sequence.

**NOTE:** If door is closed or STOP/RESET pad is pressed before programming is complete, changes are discarded and microwave exits programming mode.

PROGRAMPOWER LEVELSTART/+30 SECSTOP/RESET

## ? The display shows PROGRAM.

When PROGRAM pad is pressed, the display will show PROGRAM.



# Electronic Dial Operation (some models only)

## Electronic Dial option is available on some models only.

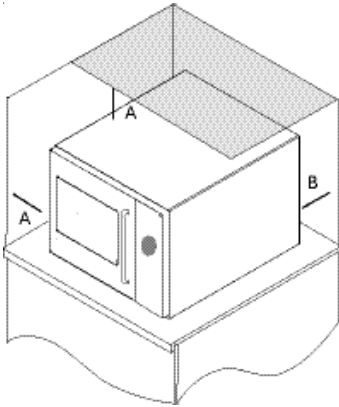

### Oven Clearances

A—Allow at least 4" (10.2 cm) of clearance around top and sides of oven. Proper air flow around oven cools electrical components. With restricted air flow, oven may not operate properly and life of electrical parts is reduced.

B—Allow at least 4" (10.2 cm) between air discharge on back of oven and back wall.

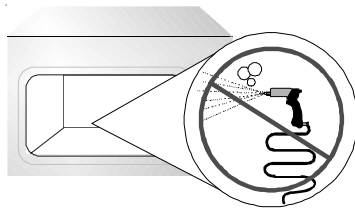

DO NOT power spray

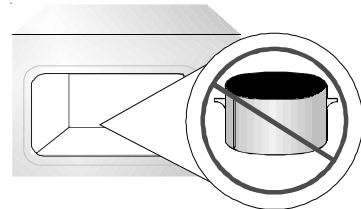

No metal pans

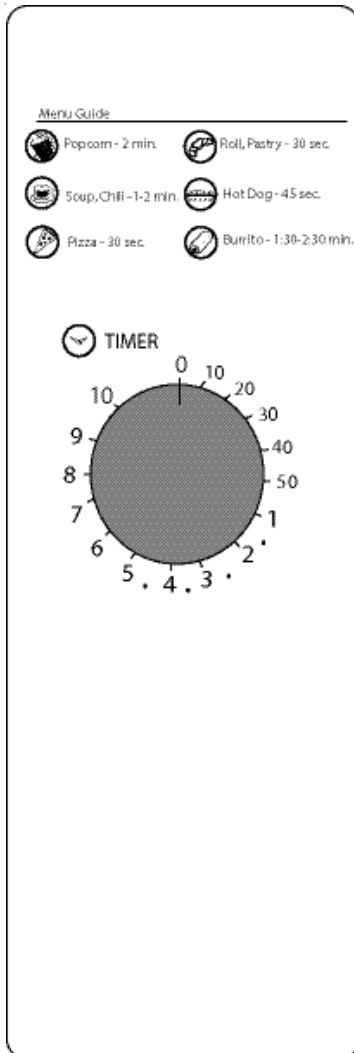

## So...how do I use it?

### Heating

1. Open oven door, place food in oven, and close oven door.
  - Door must be opened and closed before time will be accepted.
2. Turn time entry knob until desired time is illuminated.
  - Cooking time can be set up to 10 minutes.
  - Knob must be turned within 1 minute of opening and closing door, otherwise time entry will be disabled.
3. Oven begins operation immediately and time counts down.
4. When cooking time elapsed, microwave energy stops and oven signal sounds.

### Interrupting Operation

Open oven door to interrupt operation or turn time entry knob counterclockwise to "0". If time was changed to "0", time will need to be reset. If door was opened during operation, time will need to be reset.

### Changing Time and Power/Canceling Mistakes

Cooking time can be changed at any time while the oven is operating. Turn knob to desired new setting. To set cooking time to zero, turn time entry knob counterclockwise to "0". To add cooking time, turn knob clockwise until desired time is illuminated.

# Care and Cleaning

PART	CARE AND CLEANING RECOMMENDATION
Interior, Exterior, and Door	<p>Clean microwave oven with mild detergent in warm water using soft sponge or cloth. Wring sponge or cloth to remove excess water before wiping equipment. If desired, boil a cup of water in microwave oven to loosen soil before cleaning.</p> <p><b>Important:</b></p> <ul style="list-style-type: none"> <li>Do not use abrasive cleansers or cleaners containing ammonia or citrus. These could damage finish.</li> <li>Never pour water into microwave oven bottom.</li> <li>Do not use water pressure type cleaning systems.</li> </ul>
Discharge Air Vents	<p>Check monthly for a buildup of particles along intake screen on back of oven. Clean screen with damp cloth to ensure proper airflow. Dry thoroughly.</p>
Control Panel	<p>Open oven door to deactivate oven timer. Clean with mild detergent in warm water using soft sponge or cloth.</p>

## Before Calling for Service



### WARNING

To avoid electrical shock which can cause severe personal injury or death, do not remove outer case at any time. Only an authorized Amana servicer should remove outer case.

Problem	Possible Cause
Oven does not operate.	<p>Confirm oven is plugged into dedicated circuit.</p> <p>Confirm oven is on grounded and polarized circuit. (Contact electrician to confirm)</p> <p>Check fuse or circuit breaker.</p> <p>Check that the door is firmly closed.</p>
If oven does not accept entries when pad is pressed.	<p>Make sure oven is on.</p> <p>Open and close oven door. Press pad again.</p>
If oven malfunctions or shows: <b>E20</b> <b>E30</b>	<p>Oven control is equipped with a self-diagnostic system. Self-diagnostic system alerts you if there is an error or problem. When electronic control signals a problem, follow steps listed below.</p> <ol style="list-style-type: none"> <li>Record number shown.</li> <li>Unplug oven, wait for 1 minute, and plug in oven. <ul style="list-style-type: none"> <li>Disconnecting electrical supply may eliminate service code. If failure continues, contact an authorized Amana servicer or call Amana toll free at 1-866-426-2621 inside the U.S.A. or Canada, or 1-319-622-2808 outside the U.S.A or Canada.</li> </ul> </li> </ol>
If oven shows <b>E 10</b> in display:	<p>An attempt has been made to program the oven for more time than allowed.</p> <ol style="list-style-type: none"> <li>Press STOP/RESET pad.</li> </ol> <p>NOTE: Maximum cooking time is 60 minutes except when cooking with full power (100%). In case of full power (100%), maximum cooking time is 20 minutes.</p>
Oven operates but does not heat food.	<p>Place one cup of water in oven.</p> <p>Run for one minute at full power (100%).</p> <p>If temperature does not rise, oven is not operating correctly. Contact an authorized Amana servicer or call Amana toll free at 1-866-426-2621 inside the U.S.A. or Canada, or 1-319-622-2808 outside the U.S.A or Canada.</p>