

# Owner's Manual

HEAVY DUTY COMMERCIAL COMPACT MICROWAVE OVEN  
[0.6 Cubic Foot (17 Liter)]

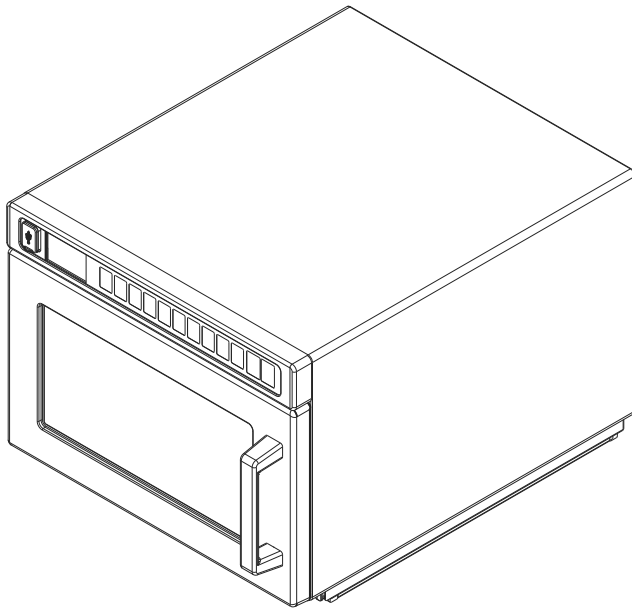

**STYLE 1**

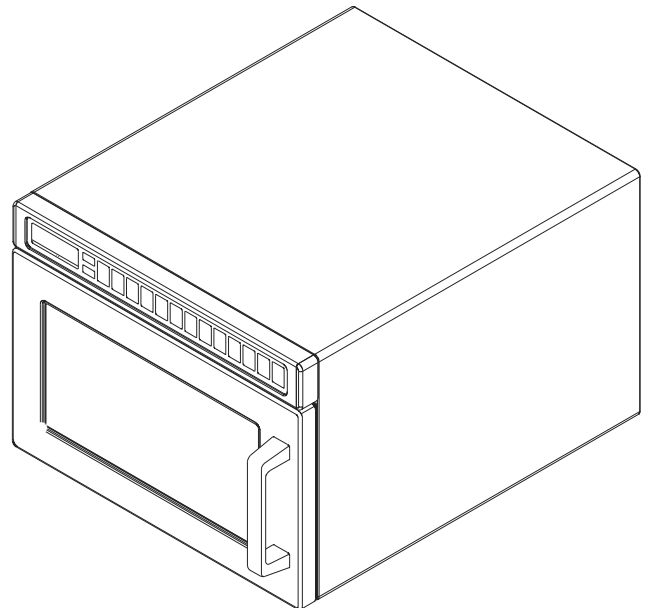

**STYLES 2 & 3**

**Keep these instructions for future reference. If the equipment changes ownership, be sure this manual accompanies equipment. Please refer to the SAFETY INSTRUCTIONS for important safety information prior to using this oven**

## TABLE OF CONTENTS

<b>Model Identification</b> .....	<b>2</b>
<b>Online Oven Resources</b> .....	<b>2</b>
<b>Important Safety Instructions</b> .....	<b>3-4</b>
<b>Grounding and Installation</b> .....	<b>5</b>
<b>Style 1</b>	
Control Panel and Features.....	6
Cooking & Programming Features .....	7
Operation .....	8-9
Programming Display Screens .....	10
Programming .....	11-12
USB Flash Drive .....	13
User Options.....	14
<b>Styles 2 &amp; 3</b>	
Control Panel and Features.....	15
Displays and Operation .....	16-17
Operation and Programming .....	17
User Options.....	18
<b>Cooking Instructions</b> .....	<b>19</b>
<b>Care and Cleaning</b> .....	<b>20-21</b>
<b>Before Calling for Service</b> .....	<b>22</b>

# Model Identification

---

When contacting ACP, provide product information. Product information is located on oven serial plate. Record the following information:

Model Number: \_\_\_\_\_  
Manufacturing Number: \_\_\_\_\_  
Serial or S/N Number: \_\_\_\_\_  
Date of purchase: \_\_\_\_\_  
Dealer's name and address: \_\_\_\_\_  
\_\_\_\_\_  
\_\_\_\_\_

Keep a copy of sales receipt for future reference or in case warranty service is required.

Any questions or to locate an authorized ACP servicer, call ACP ComServ Service Support.

- **Inside** the U.S.A. or Canada, call toll-free at 866-426-2621.
- **Outside** the U.S.A. and Canada, call 319-368-8195.
- **Email:** [commercialservice@acpsolutions.com](mailto:commercialservice@acpsolutions.com)

Warranty service must be performed by an authorized ACP servicer. ACP also recommends contacting an authorized ACP servicer, or ACP ComServ Service Support if service is required after warranty expires.

Before using your oven, please take the time to read the Safety Instructions which shipped with the oven.

Information herein is subject to change without notice. Errors are subject to correction.  
For the most recent product literature, please visit [acpsolutions.com/product-literature/](http://acpsolutions.com/product-literature/)



## Online Oven Resources

### ACP PROGRAMMING APPLICATION



Download and install the ACP Programming Application to create, edit, and customize menu and display settings for your oven, using a desktop computer or tablet.  
To download the latest and greatest version of the ACP Programming Application please visit [acpsolutions.com/oven-programming/](http://acpsolutions.com/oven-programming/)

# IMPORTANT SAFETY INSTRUCTIONS

## **RECOGNIZE THIS SYMBOL AS A SAFETY MESSAGE**

### **WARNING**

When using electrical equipment, basic safety precautions should be followed to reduce the risk of burns, electrical shock, fire, or injury to persons including the following.

1. READ all instructions before using equipment.
2. READ AND FOLLOW the specific "PRECAUTIONS TO AVOID POSSIBLE EXPOSURE TO EXCESSIVE MICROWAVE ENERGY" on this page.
3. This equipment **MUST BE GROUNDED**. Connect only to properly GROUNDED outlet. See "GROUNDING / EARTHING INSTRUCTIONS".
4. Install or locate this equipment **ONLY** in accordance with the installation instructions in this manual.
5. Liquids or other foods, must **NOT** be HEATED in sealed containers since they are liable to explode.
6. Eggs in their shell and whole hard-boiled eggs should **NOT** be HEATED in microwave ovens since they may explode even after microwave heating has ended.
7. Use this equipment **ONLY** for its intended use as described in this manual. **DO NOT** use corrosive chemicals or vapors in this equipment. This type of oven is specifically designed to heat, cook, or dry food. It is not designed for industrial or laboratory use.
8. This appliance is **NOT** intended for use by persons (including children) with reduced physical, sensory or mental capabilities, or lack of experience and knowledge, unless they have been given supervision or instruction concerning use of the appliance by a person responsible for their safety
9. **CHILDREN SHOULD BE SUPERVISED** to ensure that they **DO NOT** play with the appliance
10. Failure to maintain the oven in a clean condition could lead to deterioration of the surface that could adversely affect the life of the appliance and possibly result in a hazardous situation;
11. See door cleaning instructions on page 20-page 21 of this product safety manual.
12. **DO NOT** heat baby bottles in oven. Baby food jars shall be open when heated and contents stirred or shaken before consumption, in order to avoid burns.
13. **DO NOT** operate this equipment if it has a damaged cord or plug, if it is not working properly, or if it has been damaged or dropped.
14. This equipment, including power cord, must be serviced **ONLY** by qualified service personnel. Special tools are required to service equipment. Contact nearest authorized service facility for examination, repair, or adjustment.
15. **DO NOT** cover or block louvers or other openings on equipment.
16. **DO NOT** store this equipment outdoors. **DO NOT** use this product near water – for example, near a kitchen sink, in a wet basement, a swimming pool, or a similar location.
17. **DO NOT** immerse cord or plug in water.
18. Keep cord **AWAY** from HEATED surfaces.
19. **DO NOT** let cord hang over edge of table or counter.
20. For commercial use only.

### **PRECAUTIONS TO AVOID POSSIBLE EXPOSURE TO EXCESSIVE MICROWAVE ENERGY**

- A. **DO NOT** attempt to operate this oven with the door open since open door operation can result in harmful exposure to microwave energy. It is important not to defeat or tamper with the safety interlocks.
- B. **DO NOT** place any object between the oven front face and the door too allow soil or cleaner residue to accumulate on sealing surfaces.
- C. **DO NOT** operate the oven if it is damaged. It is particularly important that the oven door close properly and that there is no damage to the:
  1. door (bent)
  2. hinges and latches (broken or loosened)
  3. door seals and sealing surfaces.
- D. The oven should not be adjusted or repaired by anyone except properly qualified service personnel.

## **SAVE THESE INSTRUCTIONS**

## **WARNING**

To avoid risk of fire in the oven cavity:

- A. DO NOT overcook food. Carefully attend oven when paper, plastic, or other combustible materials are placed inside the oven, due to the possibility of ignition.
- B. Remove wire twist-ties from paper or plastic bags before placing bag in oven.
- C. If materials inside the oven ignite, keep oven door CLOSED, turn oven off and disconnect the power cord, or shut off power at the fuse or circuit breaker panel.
- D. DO NOT use the cavity for storage. DO NOT leave paper products, cooking utensils, or food in the cavity when not in use.

## **WARNING**

Liquids such as water, coffee, or tea are able to be overheated beyond the boiling point without appearing to be boiling due to surface tension of the liquid. Visible bubbling or boiling when the container is removed from the microwave oven is not always present. **THIS COULD RESULT IN VERY HOT LIQUIDS SUDDENLY BOILING OVER WHEN A SPOON OR OTHER UTENSIL IS INSERTED INTO THE LIQUID.** To reduce the risk of injury to persons:

- i. DO NOT overheat the liquid.
- ii. Stir the liquid both before and halfway through heating it.
- iii. DO NOT use straight-sided containers with narrow necks.
- iv. After heating, allow the container to stand in the microwave oven for a short time before removing the container.
- v. Use extreme care when inserting a spoon or other utensil into the container.

## **CAUTION**

To avoid personal injury or property damage, observe the following:

- 1. DO NOT deep fat fry in oven. Fat could overheat and be hazardous to handle.
- 2. DO NOT cook or reheat eggs in shell or with an unbroken yolk using microwave energy. Pressure may build up and erupt. Pierce yolk with fork or knife before cooking.
- 3. Pierce skin of potatoes, tomatoes, and similar foods before cooking with microwave energy. When skin is pierced, steam escapes evenly.
- 4. DO NOT operate equipment without load or food in oven cavity.
- 5. Use only popcorn in packages designed and labeled for microwave use. Popping time varies depending on oven wattage. DO NOT continue to heat after popping has stopped. Popcorn will scorch or burn. DO NOT leave oven unattended.
- 6. DO NOT use regular cooking thermometers in oven. Most cooking thermometers contain mercury and may cause an electrical arc, malfunction, or damage to oven.
- 7. DO NOT use metal utensils in oven.
- 8. DO NOT use aluminum foil in oven
- 9. Never use paper, plastic, or other combustible materials that are not intended for cooking.
- 10. When cooking with paper, plastic, or other combustible materials, follow manufacturer's recommendations on product use.
- 11. DO NOT use paper towels which contain nylon or other synthetic fibers. Heated synthetics could melt and cause paper to ignite.
- 12. DO NOT heat sealed containers or plastic bags in oven. Food or liquid could expand quickly and cause container or bag to break. Pierce or open container or bag before heating.
- 13. To avoid pacemaker malfunction, consult physician or pacemaker manufacturer about effects of microwave energy on pacemaker.
- 14. An authorized servicer MUST inspect equipment annually. Record all inspections and repairs for future use.

**SAVE THESE INSTRUCTIONS**

# Grounding and Installation

## Grounding/Earthing Instructions



**Oven MUST be grounded.** Grounding reduces risk of electric shock by providing an escape wire for the electric current if an electrical short occurs. This oven is equipped with a cord having a grounding wire with a grounding plug. The plug must be plugged into an outlet

that is properly installed and grounded.

Consult a qualified electrician or servicer if grounding instructions are not completely understood, or if doubt exists as to whether the oven is properly grounded.

### Do not use an extension cord.

If the product power cord is too short, have a qualified electrician install a three-slot receptacle. This oven should be plugged into a separate circuit with the electrical rating as provided in product specifications (available at [www.acpsolutions.com](http://www.acpsolutions.com)) and the oven's serial plate / rating label. When the oven is on a circuit with other equipment, an increase in cooking times may be required and fuses can be blown.

## EXTERNAL EQUIPOTENTIAL EARTHING TERMINAL (*export only*)

Equipment has secondary earthing terminal. Terminal provides external earthing connection used in addition to earthing prong on plug. Located on outside of oven back, terminal is marked with symbol shown at right



## Installation

### Unpacking Oven

- Inspect oven for damage such as dents in door or inside oven cavity.
- Report any dents or breakage to source of purchase immediately.  
**Do not attempt to use oven if damaged.**
- Remove all packing materials from oven interior.
- If oven has been stored in extremely cold area, wait a few hours before connecting power.

### Radio Interference

- Microwave operation may cause interference to radio, television. Reduce or eliminate interference by doing the following:
- Clean door and sealing surfaces of oven according to instructions in "Care and Cleaning" section.

### Oven Placement

- Do not install oven next to or above source of heat, such as pizza oven or deep fat fryer. This could cause oven to operate improperly and could shorten life of electrical parts.
- Do not block or obstruct oven filters. Allow access for cleaning.
- Install oven on level counter-top surface.

### OVEN CLEARANCES

- Allow at least 2" (5.1 cm) of clearance around top of oven. Proper air flow around oven cools electrical components. With restricted air flow, oven may not operate properly and life of electrical parts is reduced.
- General market models:** There is not an installation clearance requirement for the back of the oven.  
**HDC21RB2, MCHDC21, HDC21DQ only:** Allow at least 1" (2.54 cm) of clearance around back of oven.
- Allow at least 1" (2.54 cm) of clearance around sides of oven.
- Install oven so oven bottom is at least 3 feet (91.5 cm) above floor.

**WARNING**

To avoid risk of electrical shock or death, this oven must be grounded and plug must not be altered.

**WARNING**

**Excessive Weight Hazard**

Use two or more people to move and install oven. Failure to do so can result in back or other injury

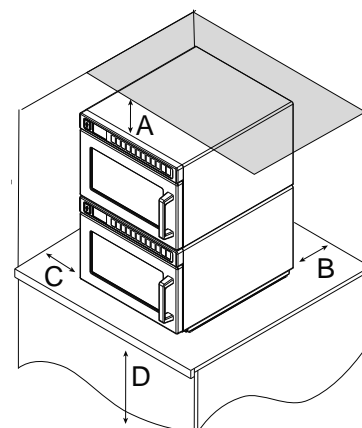
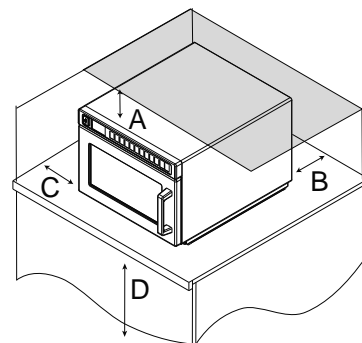

# STYLE 1 Control Panel and Features

**Note:** There are three styles of controls shown Style 1, Style 2, and Style 3. Choose the control that matches unit. Control panel coloring may vary by model

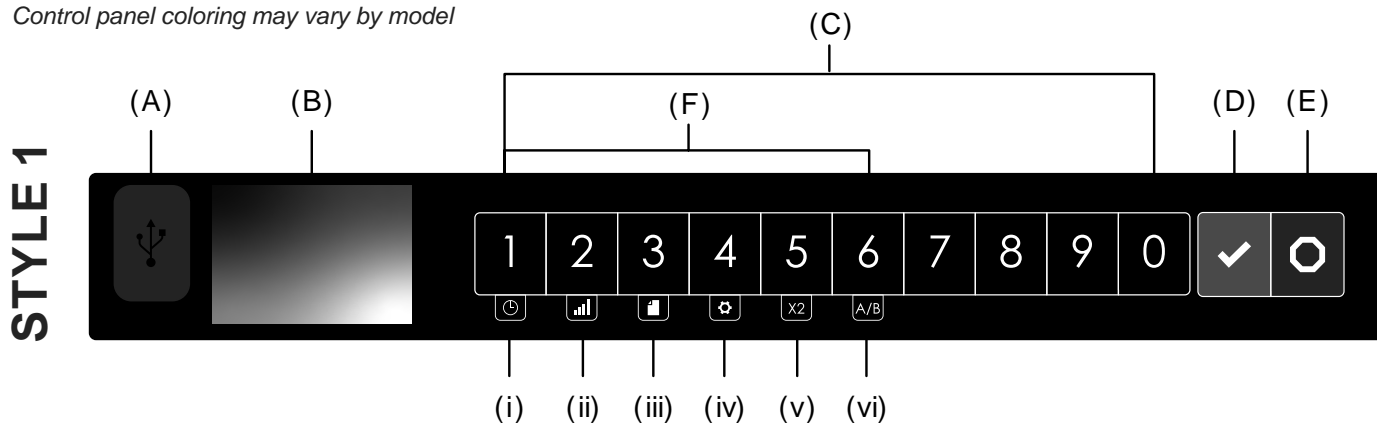

## Control Panel Features

- (A) **USB PORT**  
Standard USB flash drive compatible. Allows for import/export of programmed settings and user options, and to update firmware.
- (B) **DISPLAY**  
2.8" Color LCD Display
- (C) **NUMBER KEYPADS**  
Used to operate preset cooking programs; enter settings; navigate through display; and/or activate secondary keypad functions.
- (D) **START/OK KEYPAD**  
Begins cooking in Manual Time Entry Mode. Restarts an interrupted cooking cycle. Used to save settings and entries. Toggles through pages in Programming and User Option Modes.
- (E) **STOP/RESET KEYPAD**  
Interrupts operation, and/or exits modes and menus
- (F) **SECONDARY FUNCTION KEYPADS**  
To activate, press and hold corresponding number keypad for 0.75 seconds.  
**Note:** Press and hold time can be set between 0.75 – 2 seconds by factory option.
- (i) **Manual Time Entry Mode** (keypad "1")  
Allows the operator to heat without changing the preset program keypads.
- (ii) **Power Level** (keypad "2")  
Use to set microwave power level between 0% to 100% in 10% increments (1 = 10% power, 2=20%, 3=30%, etc.) while in Manual Time Entry Mode. Used to edit COOK FACTOR while in Programming Mode.
- (iii) **Programming Mode** (keypad "3")  
Edit preset programs and/or create new programs for customized cooking.
- (iv) **User Options** (keypad "4")  
Allows the user to customize various oven settings.
- (v) **X2 - Double Quantity Cooking** (keypad "5")  
Increases a preset cook time by a percentage of the original cook time, also know as a COOK FACTOR. Used for cooking multiple servings of foods.
- (vi) **Menu A/B** (keypad "6")  
Toggles menu selection between two sets of programmed cook settings. "Menu A/B" function only available when factory option ALLOW AB MENU is enabled

## General Display Screens

### READY SCREEN

Indicates oven is ready to operate. The operator may press keypads to begin preset programs or to activate secondary keypad functions.

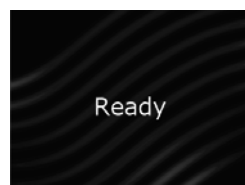

- Menu A/B disabled
- Quantity X2 disabled

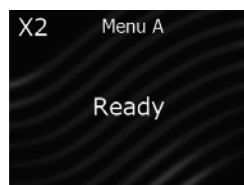

- Menu A open
- Quantity X2 enabled

### STANDBY SCREEN



### DOOR OPEN SCREEN

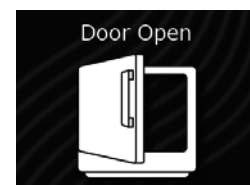

# STYLE 1 Cooking & Programming Features

## Programming Features

### STAGE COOKING

Allows operator to use up to four different cooking cycles or stages consecutively without repeated input from the operator. For example, stage cooking could be set to defrost food initially, then cook it, and then keep the food warm until serving time.

### PRESET PROGRAM KEYPADS

Oven can store between 10 to 200 cooking programs in memory. Available quantity varies based on "Digit Entry" User Option, and "Menu A/B" factory setting

**Note:** To change "Digit Entry" options, see "User Options" section in this manual. "Menu A/B" only available when factory option ALLOW AB MENU is enabled

DIGIT ENTRY USER OPTION	AVAILABLE COOKING PROGRAMS	
	IF "MENU A/B" IS DISABLED	IF "MENU A/B" IS ENABLED
<b>1</b> <i>Single Digit</i>	10 programs (0-9) <b>(10 total cooking programs)</b>	2 menu sections (A or B) ↳ 10 programs per menu (0-9) and (0-9) <b>(20 total cooking programs)</b>
<b>01</b> <i>Double Digit</i>	100 programs (00-99) <b>(100 total cooking programs)</b>	2 menu sections (A or B) ↳ 50 programs per menu (00-49) and (00-49) <b>(100 total cooking programs)</b>
<b>1</b> <i>Folders</i>	10 folders (0-9) ↳ 10 programs per folder (0-9) <b>(100 total cooking programs)</b>	2 menu sections (A or B) ↳ 10 folders per menu (0-9) and (0-9) ↳ 10 programs per folder (0-9) and (0-9) <b>(200 total cooking programs)</b>

### QUANTITY PROMPT (*select models*)

**Note:** Only available when factory option ALLOW QUANTITY PROMPT is enabled **and** "Quantity Prompt" is enabled in "User Options"

Allows operator to select preset program keypad(s) for a menu item, followed by the quantity of items to be heated. Cook times and settings can be customized for quantities 1-9.

## Methods of Cooking & Programming

### COOKING WITH PRESET PROGRAM KEYPADS

Allows operator to quickly activate saved cooking sequences using 1-2 keypad strokes

### MANUAL TIME ENTRY COOKING

Allows operator to heat without changing the preset program keypads

### MANUAL KEYPAD PROGRAMMING

Allows operator to use keypads to edit preset programs and/or create new programs for customized cooking.

### USB PROGRAMMING UPLOADS

Allows operator to load program settings and user options using a standard USB flash drive

### ACP PROGRAMMING APPLICATION

Allows operator to create and edit program settings and user options on a computer.

For detailed instructions, please visit: [www.acpsolutions.com/oven-programming](http://www.acpsolutions.com/oven-programming)



## Interrupting Operation

Open oven door or press STOP/RESET keypad to interrupt operation. Display continues to show countdown time. Close door and press START/OK keypad to resume oven operation.



## Canceling Mistakes

If oven is not cooking, press STOP/RESET keypad to clear display.  
 If oven is cooking, press STOP/RESET keypad once to stop oven, then again to clear display.  
 If oven door is open and time shows in display, close oven door and press STOP/RESET keypad to clear display.

## FACTORY PRESET PROGRAMS

### Menu A

KEYPAD	TIME	POWER
1	10 sec.	100%
2	20 sec.	
3	30 sec.	
4	45 sec.	
5	1:00 min.	
6	1:30 min.	
7	2:00 min.	
8	3:00 min.	
9	4:00 min.	
0	5:00 min.	

Factory setting may vary by model

## Operating Preset Program Keypads

From the factory, this oven comes preprogrammed with several cooking sequences in memory. To heat using a preset program, press number keypad(s). Oven will start to heat automatically.

- Open oven door, place food in oven, and close oven door.
  - READY screen is displayed
  - If keypad is not pressed within 60 seconds, open and close oven door again.
- Press desired number keypad(s)
  - Single Digit Keypad Cooking:** press a single keypad (0-9)
  - Double Digit Keypad Cooking:** press the two keypads, in order, of the double digit number for the desired cooking sequence (00-99)
  - Folders:** press one keypad to open folder (0-9), followed by keypad for desired cooking sequence (0-9)

*Note: To change Digit Entry option see User Options section in this manual*
- Oven operates and time counts down.
  - Display shows the program name and counts down cooking time.
  - If additional cooking time is required, press preset keypads before or after cooking cycle ends.
- At the end of the cooking cycle, the oven beeps. Carefully remove food from oven.

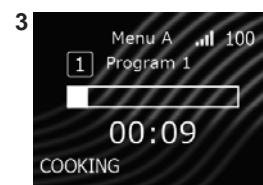
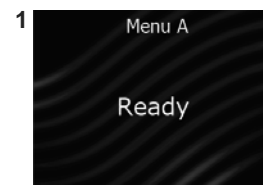

**X2 - DOUBLE QUANTITY COOKING (optional)**  
 Press and hold number keypad "5"/ X2 to toggle double quantity feature ON.
 

- "X2" appears at top center of screen when enabled.

 Press desired number keypad(s).
 

- Display shows the program name and counts down cooking time for two quantities.



**MENU A/B (select models)**  
 Press and hold number keypad "6" to toggle between A and B menus.

## Quantity Prompt (select models)

- Press desired number keypad(s)
  - ENTER QUANTITY screen is displayed
- Enter desired quantity using keypad 1-9
  - Display shows the program name and counts down cooking time. Quantity is displayed in top left corner.

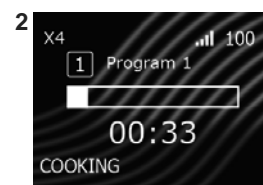
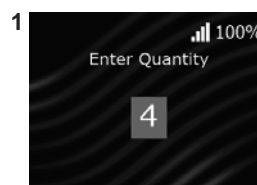





## Manual Time Entry Mode

Allows operator to heat without changing the preset program keypads.  
From READY or DOOR OPEN screen:

1. Open oven door, place food in oven, and close door
  - READY screen is displayed. Fan and light operate
  - If keypad is not pressed within 60 seconds, open and close oven door again
2. Press and hold number keypad “1”/ TIME ENTRY
  - MANUAL COOK screen is displayed
3. Press number keypads to enter desired cook time
4. Press and hold number keypad “2”/ POWER LEVEL to change power level.
  - Press number keypads to enter % microwave power (“1”=10%, “2”=20%,etc.)  
For 100% power level, press and hold number keypad “2”/ POWER LEVEL
5. Press START/OK keypad to begin cooking
  - Oven operates and display counts down cooking time
6. At the end of the cooking cycle, the oven beeps. Carefully remove food from oven.

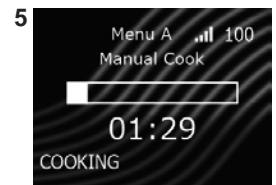
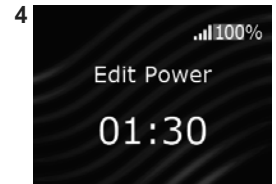
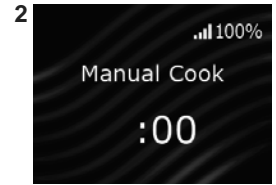

## Manual Time Entry with Multiple Stages

Stage cooking allows consecutive cooking cycles (stages) without interruption.  
Up to four different cooking cycles can be entered.

1. Follow “Manual Time Entry Mode” steps 1-4 above to enter settings for stage one.
2. **To enter additional cooking stages:** Press and hold number keypad “1”/ TIME ENTRY
  - MANUAL COOK STAGE entry screen is displayed
3. **To enter cook time for Stage Two:** Press number keypad “2”
  - Press number keypad(s) to enter cook time
  - Press START/OK keypad
4. **To enter power level for Stage Two:** Press number keypad “6”
  - Press number keypad(s) to enter % microwave power (“1”=10%, “2”=20%,etc.)  
For 100% power level, press and hold number keypad “2”/ POWER LEVEL
  - Press START/OK keypad
5. **To enter additional cooking stages:** Repeat steps 3-4 for each additional stage, substituting corresponding number keypads for each stage.  
*Example: For stage three, press number keypad “3” to edit cook time, and press number keypad “7” to edit power level.*
6. Press START/OK keypad to begin cooking

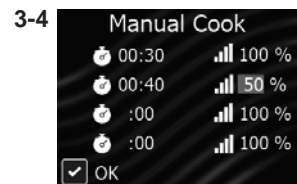

# STYLE 1 Programming Display Screens

## Programming Mode Screen

Indicates oven is in programming mode. The operator may press keypads to open program and/or folder locations.

**Note:** Screens may vary based on "Digit Entry" User Option, and "Menu A/B" factory setting

### (A) PROGRAM/FOLDER LOCATIONS

Numbers represent programmed cooking sequences and available memory locations. Unused locations are labeled "- Available." First available location is highlighted. Operator may press keypads to view and edit locations.

### (B) MENU A/B DISTINCTION (*select models*)

Displays active menu section. Operator may press and hold number keypad "6" to toggle between A and B menus.

### (C) MULTIPLE PAGES

Radio button icons indicate page number. Display automatically toggles to the next page every 2 seconds. Operator may press START/OK keypad to manually toggle between pages.

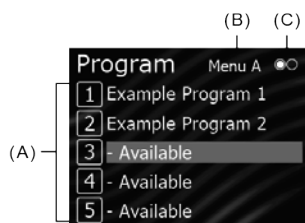

- Single Digit Entry
- Menu A shown
- Page 1 of 2 shown
- "3" is first available location

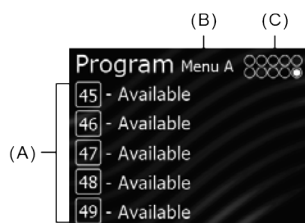

- Double Digit Entry
- Menu A shown
- Page 10 of 10 shown

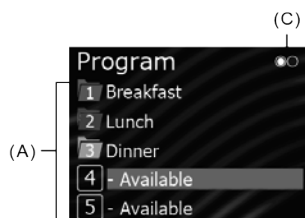

- Folder Digit Entry
- Menu A/B disabled
- Page 1 of 2 shown
- "4" is first available location

## Program Entry Screen

Displays while a program or folder location is open. Stored location is represented by number at top right corner of screen

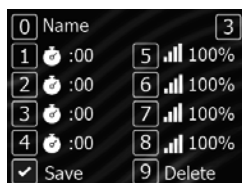

- Single Digit Entry
- Location "3"

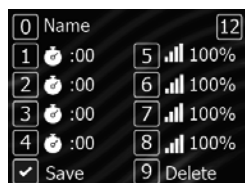

- Double Digit Entry
- Location "12"

### "Program Entry" Keypad Functions

KEYPAD	FUNCTION
1	Edit cook time - Stage 1
2	Edit cook time - Stage 2
3	Edit cook time - Stage 3
4	Edit cook time - Stage 4
5	Edit power level - Stage 1
6	Edit power level - Stage 2
7	Edit power level - Stage 3
8	Edit power level - Stage 4
9	Delete Program
0	Edit Program Name
START	Save
STOP	Exit

## Edit Name Screen

Displays while editing name of program or folder. Operator may press number keypads to enter a name. To cycle through available characters, press the same keypad within 1 second.

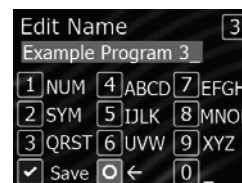

### "Edit Name" Keypad Functions

KEYPAD	TEXT FUNCTION
1	1234567890
2	.,&!?'()/~@#\$\$%^*~+
3	QRSTqrst
4	ABCDabcd
5	IJKIjklk
6	UVWuvvw
7	EFGHefgh
8	MNOPmnop
9	XYZxyz
0	(space)
START	(save and exit)
STOP	(backspace)

## 3

### Manual Programming Mode

Allows operator to edit preset programs and/or create new programs for customized cooking.

**Note:** Manual Programming must be enabled in User Options

From READY or DOOR OPEN screen:

- Press and hold number keypad “3”/ PROGRAM
  - Oven will display list of preset program and available locations
  - The first available location will be highlighted. If no locations are available, the first preset program on the first page will be highlighted.
  - Display automatically toggles to the next page of program locations every 2 seconds. Select the START pad to manually toggle to next page.
- Press number keypad(s) to open the desired program location
  - PROGRAM ENTRY screen is displayed.
- To edit name:** Press number keypad “0”
  - EDIT NAME screen is displayed
  - Press number keypads to enter program name.
  - Press START/OK keypad to save and return to program entry screen.
- To edit cook time for Stage One:** Press number keypad “1”
  - Press number keypads to enter cook time
  - Press START/OK keypad to save and return to program entry screen
- To edit power level for Stage One:** Press number keypad “5”
  - Press number keypads to enter % microwave power (“1”=10%, “2”=20%,etc.)  
For 100% power level, press and hold number keypad “2”/ POWER LEVEL
  - Press START/OK keypad to save and return to program entry screen
- To save and exit programming mode:** Press START/OK keypad

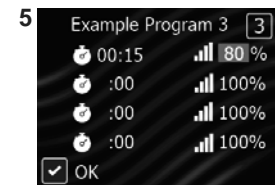
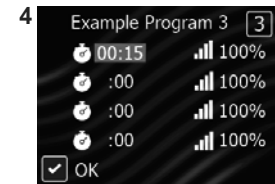
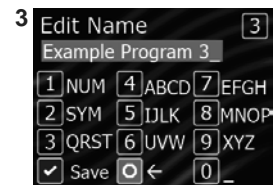
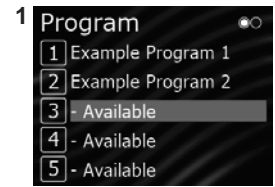

### Manually Programming Multiple Stages

Stage cooking allows consecutive cooking cycles (stages) without interruption. Up to four different cooking cycles can be programmed

- Follow “Manual Programming Mode” steps 1-5 above.
- Repeat steps 4-5 for each additional stage, substituting corresponding number keypads for each stage.
 

**Example:** For stage two, press number keypad “2” to edit cook time, and press number keypad “6” to edit power level.
- To save and exit programming mode:** Press START/OK keypad



## Quantity X2 Programming

This feature allows a preset percentage of original cook time, called a *cook factor*, to be added to a cook sequence. Default cook factor is 80% unless otherwise stated.

### EDIT THE COOK FACTOR

From READY or DOOR OPEN screen:

1. Press and hold number keypad “3”/ PROGRAM
2. Press number keypad(s) to open the desired program location
  - PROGRAM ENTRY screen is displayed
3. Press and hold number keypad “2” / POWER LEVEL
  - EDIT COOK FACTOR screen is displayed
  - Press number keypads to enter cook factor between 10 - 100%
  - Press START/OK keypad to save and return to program entry screen

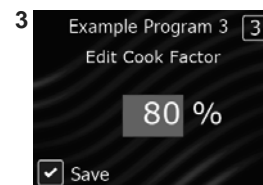

## Folders Programming (optional)

**Note:** Folders must first be enabled in User Options> DIGIT ENTRY.

### NAVIGATE FOLDERS

- **To open folder:** Press number keypad to open the desired folder
- **To exit folder:** Press STOP/RESET keypad

### CREATE FOLDERS

**Note:** Desired keypad location must be empty “- Available” before creating a folder.

From READY or DOOR OPEN screen:

1. Press and hold number keypad “3”/ PROGRAM
  - Oven will display list of preset program and available locations
  - The first available location will be highlighted. If no locations are available, the first preset program on the first page will be highlighted.
  - Display automatically toggles to the next page of program locations every 2 seconds. Select the START pad to manually toggle to next page.
2. Press an “- Available” keypad from 0-9.
  - PROGRAM ENTRY screen is displayed
3. **To edit name:** Press number “0” keypad. Press number keypads to enter name. Press START/OK keypad to save name.
4. **To save folder:** Press START/OK keypad.

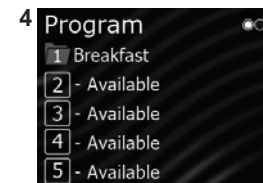
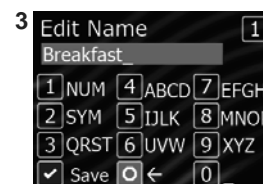
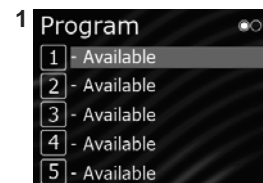

### DELETE FOLDERS

From READY or DOOR OPEN screen:

1. Press and hold number keypad “3”/ PROGRAM to enter programming mode.
2. Press and hold the number keypad corresponding to folder to delete it.
  - Contents of a deleted folder will be moved to the top level

## Export Menu via USB Flash Drive

**Note:** Before beginning, "PIN Code" must be enabled in User Options

From READY or DOOR OPEN screen:

1. Insert flash drive into the USB port
2. Press and hold keypad number "4"/ USER OPTIONS
  - PIN Code prompt appears
3. Press keypads 1-3-5-7-9 to enter SERVICE MODE
4. Press corresponding number keypad to select "Export to USB"
  - EXPORTING... screen appears. Oven beeps once export is complete
  - Settings, menu items, and oven usage data will be loaded on USB Flash Drive
5. Press STOP/RESET keypad to exit SERVICE MODE. Remove USB Flash Drive

## Import Menu via USB Flash Drive

**Note:** Menu file must be .xml format; must be the only .xml file on the flash drive. Menu file must be saved at the top level (root directory) of the flash drive, and cannot be located inside any folders.

From READY or DOOR OPEN screen:

1. Insert flash drive into the USB port
2. Press and hold keypad number "4"/ USER OPTIONS
  - If prompted, enter the PIN Code and press START/OK keypad
3. Press START/OK keypad to scroll through pages of user options until "Load File" appears
4. Press corresponding number keypad to select "Load File"
 

**Caution:** Uploading a new file will overwrite existing items on oven. To ensure items are not lost, first backup files by exporting to USB drive.

  - IMPORTING... screen appears.
  - IMPORT COMPLETE screen displays once import is complete
  - Settings and menu items will now be loaded on oven and ready to use
5. Press STOP/RESET keypad to exit USER OPTIONS. Remove USB Flash Drive



## ACP Programming Application

For larger, and more complex menus, it may be more manageable to create and edit menus using the ACP Programming Application.

For detailed instructions, please visit:

[www.acpsolutions.com/oven-programming/](http://www.acpsolutions.com/oven-programming/)

## Open Menu in ACP Programming Application

**Note:** For more details, please see ACP Programming Application User Guide online

1. Insert flash drive into USB port on computer.
2. Open ACP Programming Application.
3. Select "File," then "Open." Navigate to flash drive. Select the menu file (.xml format) and open

## ENABLE/DISABLE PIN CODE

From READY or DOOR OPEN screen:

1. Press and hold keypad number "4"/ USER OPTIONS
  - If prompted, enter the PIN Code and press START/OK keypad
2. Press START/OK keypad to scroll through pages of user options until "PIN Code" appears.
3. Press corresponding number keypad to open "PIN Code" options
4. To change the setting, press corresponding number keypad
5. Press STOP/RESET keypad to exit User Options Menu

## 7

## Updating Firmware

**Note:** Firmware files must be loaded on USB flash drive. Must be saved at the root directory of the flash drive, and cannot be located inside any folders.

1. From READY screen, Press and hold keypad number "7".
  - PIN Code prompt appears
2. Press keypads 1-3-5-7-9 to enter SERVICE MODE
3. Press and hold keypad number "7".
  - Firmware update screen appears
4. Insert flash drive into the USB port
5. Press press START/OK keypad to begin update

### Troubleshooting:

If firmware fails to load: press and hold the STOP/RESET keypad while plugging in the oven.

# STYLE 1 User Options

There are several options you can change to customize the operation of the oven for your business. Options are shown below. The **factory setting is shown in bold type**.

## 4 Access and Modify User Options

From READY or DOOR OPEN screen

1. Press and hold keypad number “4”/ USER OPTIONS.
  - If prompted, enter the PIN Code and press START/OK keypad
    - USER OPTIONS screen is displayed
2. Press the START/OK keypad to scroll through pages of user options
3. To access an individual user option, press the corresponding number keypad
  - To change the setting, press corresponding number keypad
  - To return to User Options Menu, press START or STOP/RESET
4. Press STOP/RESET keypad to exit User Options Menu

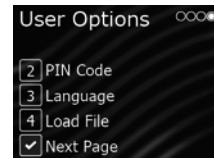
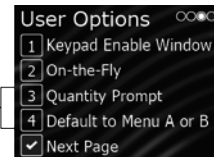
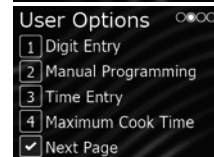
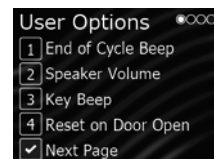

STANDARD DEFAULT PER MODEL (FACTORY SETTINGS IN BOLD)

Factory setting may vary by model

SETTING	DISPLAYED OPTIONS	DESCRIPTION
End of Cycle Beep	<b>3 Seconds</b> Continuous Burst	<b>3 second continuous beep</b> Continuous beep until door is opened 5 beep bursts until door is open
Speaker Volume	Low <b>Medium</b> High	Sets volume to low <b>Sets volume to medium</b> Sets volume to high
Key Beep	<b>On</b> Off	<b>Allows beep when keypad is pressed</b> Prevents beep when keypad is pressed
Reset on Door Open	End Cook Cycle <b>Pause Cook Cycle</b>	Cancels heating time count down after door is opened during cycle. <b>Allows oven to resume heating time countdown after door is opened during cycle</b>
Digit Entry	<b>Single Digit</b> Double Digit Folders	<b>Allows 10 (0-9) preprogrammed items</b> Allows 100 (00-99) preprogrammed items Allows 10 folders (0-9), each with 10 preprogrammed items
Manual Programming	<b>On</b> Off	<b>Allows use of manual time entry and preprogrammed keypads</b> Allows use of preprogrammed keypads only
Time Entry	<b>On</b> Off	<b>Manual time entry/cooking allowed</b> Manual time entry/cooking not allowed
Maximum Cook Time	<b>10 minutes</b> 60 minutes	<b>Allows 10 minutes of heating time</b> Allows 60 minutes of heating time
Keypad Enable Window	15 seconds 30 seconds <b>1 minute</b> 2 minutes	15 seconds after oven door is opened, keyboard disabled 30 seconds after oven door is opened, keyboard disabled <b>1 minute after oven door is opened, keyboard disabled</b> 2 minutes after oven door is opened, keyboard disabled
On-the-Fly	<b>On</b> Off	<b>Allows pushing additional keypads to add or change time in the middle of a cook cycle</b> Disables pushing any additional keypads during a cook cycle
Quantity Prompt*	On <b>Off</b>	Prompts the user for portion quantity multiplier (1-9) upon selecting a preset program <b>Allows user to cook individual portions and/or use X2 quantity multiplier feature</b>
Default to Menu A or B*	<b>Menu A</b> Menu B	<b>Menu A displayed by default</b> Menu B displayed by default
PIN Code	<b>Off</b> On Set PIN Code	<b>PIN Code not required to access User Options</b> PIN Code required to access User Options PIN Code required. Create new 4 digit PIN Code
Language	Bengali, Chinese (Mandarin), Danish, Dutch, <b>English</b> , Filipino, French, German, Greek, Hindi, Italian, Japanese, Korean, Laotian, Norwegian, Polish, Portuguese, Romanian, Russian, Spanish, Swedish, Thai, Ukrainian, Vietnamese	
Load File	N/A	Detects USB flash drive and imports .xml format menu file

\* Available on select models only (only displayed in User Options menu if factory option is enabled)

STYLE 2

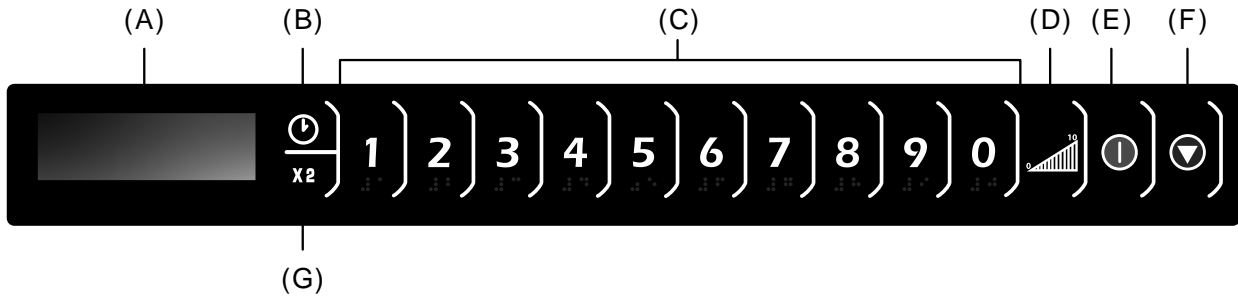

STYLE 3

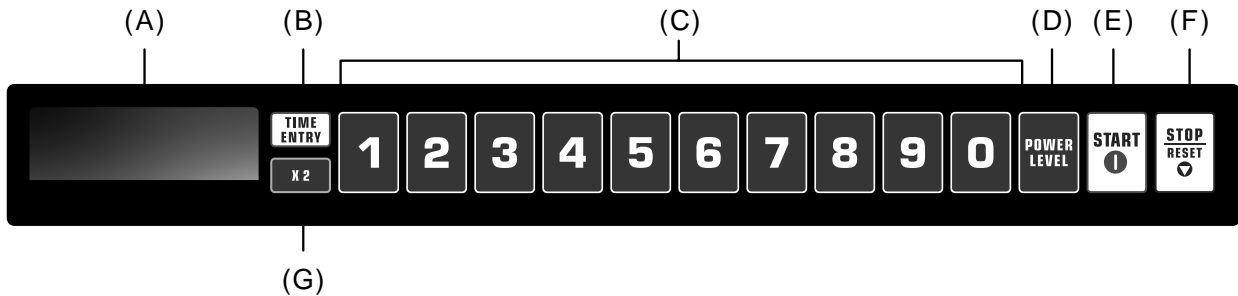

## Control Panel Features

- (A) **DISPLAY (*select models*)**  
Some items in display can be seen but will not glow.
- (B) **TIME ENTRY KEYPAD**  
Use to enter cooking time for either manual entry or programming.
- (C) **NUMBER KEYPADS**  
Use to begin cooking programs or enter times and power levels for “Manual Time Entry” cooking
- (D) **POWER LEVEL KEYPAD**  
Use to set microwave power level between 0% to 100% in 10% increments (1 = 10% power, 2=20%, 3=30%, etc.). The power level can be decreased for foods that require slower more even cooking. If cooking time is set and START keypad pressed, oven cooks at 100% power. When programming, to reset power level to 100%, press POWER LEVEL keypad.
- (E) **START KEYPAD**  
Begins Manual Time Entry cooking or restarts an interrupted cooking cycle. When programming, use to save time and power level, and to advance to next user option.
- (F) **STOP/ RESET KEYPAD**  
Use to exit programming mode and stop cooking during cooking cycle.
- (G) **QUANTITY X2 KEYPAD**  
Increases a preset cook time by a percentage of the original cook time, also know as a cook factor. Used for cooking multiple servings of foods.

## Programming Features

### STAGE COOKING

Allows operator to use up to four different cooking cycles or stages consecutively without repeated input from the operator. For example, stage cooking could be set to defrost food initially, then cook it, and then keep the food warm until serving time.

### USER OPTIONS

Allows the user to customize various oven settings. See “User Options” section of manual for details.

### MANUAL TIME ENTRY

Allows operator to heat without changing the preset program keypads.

### PRESET PROGRAM KEYPADS (DIGIT ENTRY)

The oven can of store either 10 or 100 cooking programs in memory.

#### A. **Single Digit Keypad Cooking**

From the factory, the oven is programmed to store 10 cooking programs. Each keypad begins a cooking program.

#### B. **Double Digit Keypad Cooking**

The oven control can be changed to store up to 100 cooking programs. Each entry will be assigned a double digit number, for example 01, 05, or 20. When using the double keypad programming, two keypads must be pressed to start the cooking cycle. To set the control to 100 cooking programs, see the “User Options” section of this manual.

## Cooking Displays

STYLE 2	STYLE 3	DESCRIPTION
READY	READY	Displays when oven control will accept entries
00:00	00:00	Displays cooking time. If stage cooking is programmed, total cooking time is displayed
% MW POWER	COOK LEVEL	Displays while oven is operating to show the percent microwave power level. <ul style="list-style-type: none"> <li>• <b>Style 2:</b> The % MW Power is displayed about as a number 10-90 in intervals of 10. If no number is displayed, the oven is cooking at full power.</li> <li>• <b>Style 3:</b> The cooking level is displayed above as a number 1 through 9. (1=10%, 2=20%, 3=30%, etc.) If no number is displayed, the oven is cooking at full power.</li> </ul>
COOKING	POWER	Displays while the oven is generating microwave energy during a cooking cycle.

## Programming Displays

STYLE 2	STYLE 3	DESCRIPTION
PROGRAM	PROGRAM	Displays when entering programming mode.
PD-	P:0	Displays when oven enters programming mode for single digit keypad memory only.
P--	P:	Displays when oven enters programming mode for double digit keypad memory. 2 keypads must be pressed to enter a program.
OPTIONS	OP:--	Displays when oven is in user option mode. User options can then be set or specified.
CF:0-	CF:	Displays with a numerical cooking factor when the X2 keypad is pressed. Cooking Factor is the percentage by which cooking time increases when using X2 keypad to cook multiple portions. (1=10%, 2=20%, 3=30%, etc.)
STAGE-	P:--1	Number (1 through 4) indicates the stage that is being programmed. <ul style="list-style-type: none"> <li>• <b>Style 2:</b> The stage # is displayed above cooking time.</li> <li>• <b>Style 3:</b> The stage # displays briefly when programming a specific cooking stage.</li> </ul>

## Interrupting Operation

While the oven is operating, press STOP/RESET keypad to interrupt operation. Display shows remaining cooking time. Close door and press START key to resume oven operation.

## Canceling Mistakes

If oven is not cooking, press STOP/RESET keypad to clear display. If oven is cooking, press STOP/RESET keypad once to stop oven, then again to clear display. If oven door is open and time shows in display, close oven door and press STOP/RESET keypad to clear display.

## Factory Preset Programs

All preprogrammed keypads arrive set at full power (100%).

KEYPAD	TIME	KEYPAD	TIME
1	10 sec.	6	1:30 min.
2	20 sec.	7	2:00 min.
3	30 sec.	8	3:00 min.
4	45 sec.	9	4:00 min.
5	1:00 min.	0	5:00 min.

**Note:** Factory setting may vary by model

## Operating Preset Program Keypads

From the factory, this oven comes preprogrammed with several cooking sequences in memory.

**Note:** To change single or double keypad entry option see "User Options" section in this manual.

1. Open oven door and place food in oven. Close door.
  - Display shows "READY"
2. Select the keypad(s) for the desired preprogrammed cooking sequence.
  - **Single Digit Keypad Cooking:** press a keypad (0-9)
  - **Double Digit Keypad Cooking:** press the two keypads, in order, of the double digit number for the desired cooking sequence.(00-99)
3. Oven begins cooking and displays remaining cooking time.
4. If additional cooking time is required, press preset program keypad(s) before or after cooking cycle ends.
5. At the end of the cooking cycle, the oven beeps. Carefully remove food from oven.



## Manual Time Entry

Allows operator to heat without changing the preset program keypads.

1. Open oven door and place food in oven. Close door.
  - Display shows "READY"
2. Press the TIME ENTRY keypad
  - Display shows "00:00" and "READY"
3. Press number keypads to enter the desired cook time.
  - If keypad is not pressed within 60 seconds, open and close oven door again.
4. Press POWER LEVEL keypad to select power level. Press a number keypad to adjust the power level, or press POWER LEVEL keypad again to reset to 100%.
  - **Style 2:** Display shows "% MW POWER" and current power level if other than 100 percent power.
  - **Style 3:** Display shows "COOK LEVEL" and current power level if other than 100 percent power.
5. **To enter additional cooking stages:** Repeat steps 2-4 for each additional cooking stage.
  - Up to four different stages can be programmed.
6. Press START keypad to begin cooking

## Quantity X2 Keypad

To increase cooking time when cooking more than one serving.

1. Open oven door and place food in oven. Close door.
  - Display shows "READY"
2. Press X2 keypad.
  - Amount of time added is a percentage of the original preset cooking time.
  - The percentage can be changed. See Programming section in this manual.
3. Press desired preprogrammed keypad.
4. Oven begins cooking and displays remaining cooking time.

## Programming Mode

Allows operator to assign cook times, power levels, and stage cooking to the number keypads.

1. Open oven door and press and hold number keypad "1" for 5 seconds. The oven beeps.
  - **Style 2:** Display shows "PROGRAM"
  - **Style 3:** Display shows "P:0"

**Note:** If STOP/RESET keypad is pressed before programming is complete, changes are discarded and microwave exits programming mode.
2. Select the keypad(s) to change or review the program cooking sequence.
  - **Single Digit Keypad Cooking:** press a keypad (0-9)
  - **Double Digit Keypad Cooking:** press the two keypads, in order, of the double digit number for the desired cooking sequence.(00-99)
3. Press number keypads to enter the desired cook time.
4. Press POWER LEVEL keypad to select power level. Press a number keypad to adjust the power level, or press POWER LEVEL keypad again to reset to 100%.
  - **Style 2:** Display shows "% MW POWER" and current power level if other than 100 percent power.
  - **Style 3:** Display shows "COOK LEVEL" and current power level if other than 100 percent power.
5. **To add additional cooking stages:** Press TIME ENTRY keypad. Then repeat steps 3-4 for each additional cooking stage.
  - Up to four different stages can be programmed.
6. **To save the cooking program:** Press START keypad
7. **To exit programming mode:** Press STOP/RESET keypad or close oven door.

## Quantity X2 Programming

This feature allows a preset percentage of original cook time, called a cook factor, to be added to a cook sequence.

TO EDIT THE COOK FACTOR:

1. Open oven door and press and hold number keypad "1" for 5 seconds. The oven beeps.
2. Select the keypad(s) to reprogram.
3. Press the X2 keypad.
4. Press a number keypad to change the cook factor.
 

*Examples:*

  - Pad 5 would change the cooking factor to 50%.
  - Pad 3 would change the cooking factor to 30%.
5. Press START keypad to save changes.

## Changing User Options

This allows the user to customize various oven settings. Options such as single or double digit keypad programming, beep volume, and maximum cooking time can be changed to suit individual preferences.

1. Open oven door and press and hold number keypad “2” for 5 seconds. The oven beeps.
  - **Style 2:** Display shows “OPTIONS”
  - **Style 3:** Display shows “OP:”

**Note:** If STOP/RESET keypad is pressed before programming is complete, changes are discarded and microwave exits programming mode.
2. Press any number keypad to enter related options as noted in chart below.
3. To change, repeat pressing the number keypad until desired setting is reached.
  - Each time the keypad is pressed, option will change.
  - Match code displayed with code for desired option.
4. Press START keypad to save the selected setting.
5. To exit User Option Mode, press STOP/RESET keypad and close door.

KEYPAD	DISPLAY	OPTIONS (FACTORY SETTINGS IN BOLD)
1 End of Cycle Beep	OP:10 OP:11 OP:12	<b>3 second continuous beep</b> Continuous beep until door is opened 5 beep bursts until door is open
2 Speaker Volume	OP:20 OP:21 <b>OP:22</b> OP:23	Eliminates beep Sets volume to low <b>Sets volume to medium</b> Sets volume to high
3 Key Beep	OP:30 <b>OP:31</b>	Prevents beep when keypad is pressed <b>Allows beep when keypad is pressed</b>
4 Keyboard Enable Window	OP:40 OP:41 <b>OP:42</b> OP:43	15 seconds after oven door is opened, keyboard disabled 30 seconds after oven door is opened, keyboard disabled <b>1 minute after oven door is opened, keyboard disabled</b> 2 minutes after oven door is opened, keyboard disabled
5 Add Time During Heating	OP:50 <b>OP:51</b>	Prevents adding heating time while oven is heating <b>Allows heating time to be changed while oven is heating when a memory keypad is pressed</b>
6* Reset Door Open	OP:60 <b>OP:61</b>	Allows oven to resume heating time countdown after door is opened during cycle <b>Cancels heating time count down after door is opened during cycle.</b>
7* Maximum Heating Time	OP:70 <b>OP:71</b>	Allows 60 minutes of heating time <b>Allows 10 minutes of heating time</b>
8 Manual Operation	OP:80 <b>OP:81</b>	Allows use of preprogrammed keypads only <b>Allows use of manual time entry and preprogrammed keypads</b>
9 Double Digit Operation	<b>OP:90</b> OP:91	<b>Allows 10 (0-9) preprogrammed keypads (Single Keypad Cooking)</b> Allows 100 (00-99) preprogrammed keypads (Double Keypad Cooking)
0 Clean Filter Message	OP:00 <b>OP:01</b> OP:02 OP:03	Do not display message <b>Display message for 24 hours every 7 days</b> Display message for 24 hours every 30 days Display message for 24 hours every 90 days

\*Factory setting may vary by model

# Cooking Instructions

---

## Steaming Tips:

### 1. Cooking Vessels

a. Always heat or cook food items in covered containers to accomplish:

- Retention of steam for efficient cooking and to keep foods moist
- Even cooking results and temperatures
- A cleaner oven interior and prevention of food splatters

b. Ceramic, paper, china, styrofoam, glass and plastic are suitable materials for use in microwave ovens.

A high temperature resistant amber pan is recommended for ALL items, especially those high in fat or sugar content, as these ingredients get hot very quickly.

### 2. Food Temperature

a. To reach a mandatory serving temperature, frozen foods require a longer cook time than refrigerated items.

b. Refrigerated items:

- Items stored at 40°F (4°C) in the refrigerator should be covered while heated; except breads, pastries or any products with a breaded coating, which should be heated uncovered to avoid softening.

c. Room temperature items:

- Foods held at room temperature, such as canned items or vegetables, will require less time to heat than refrigerated items.

d. Conventionally prepared foods should be slightly undercooked to prevent overcooking when rethermed by microwave steaming.

e. After a steaming cycle has been completed, internal food temperatures continue to slightly rise due to the presence of steam.

### 3. Structure of Food

a. Food items that are high in fat, sugar, salt and moisture attract and quickly absorb microwave energy, allowing for a shorter cook time.

b. Items high in protein or fiber require a longer cook time, due to a slower absorption of microwave energy.

### 4. Quantity

a. As the mass of food increases, so will the necessary cook time.

Refer to and comply with all USDA/FDA Food Code guidelines when cooking or heating food items.

# Care and Cleaning

Microwave energy is attracted to any food source in the oven. Food splatters or spills can affect heating performance, and can also cause oven damage. To prevent damage to oven, keep the microwave oven clean and remove any food debris. Follow the recommendations below for proper maintenance of oven.

**WARNING:** NOT FOLLOWING APPROVED OVEN CLEANING INSTRUCTIONS MAY VOID YOUR OVEN WARRANTY

**⚠** Do NOT use abrasive cleaners or cleaners containing ammonia, citrus, phosphates, chlorine, sodium or potassium hydroxide (lye). The use of caustic cleaning products or those containing ammonia, citrus, phosphates, chlorine, sodium or potassium hydroxide (lye) can damage critical oven parts.

Use of unapproved cleaning agents will void the terms of the warranty.

**⚠** Never pour water into microwave oven bottom.

**⚠** Do NOT use water pressure type cleaning systems.

**⚠** Do NOT operate oven without the antenna shield and air filter in place.

**⚠** Never turn on or operate oven during cleaning procedure. Always unplug oven before cleaning.

## **⚠ WARNING**

To avoid electrical shock which can cause severe personal injury or death, unplug power cord or open circuit breaker to oven before cleaning.

Wear protective gloves and protective glasses when cleaning the oven.

Failure to maintain the oven in a clean condition could lead to deterioration of the surface that could adversely affect the life of the appliance and possibly result in a hazardous situation.

## Daily Care and Cleaning

### INTERIOR, EXTERIOR, AND DOOR

1. Unplug Oven 
2. Remove any food debris
3. Clean microwave oven with mild detergent in warm water using soft sponge or cloth. Wring sponge or cloth to remove excess water before wiping equipment.
4. If desired, boil a cup of water in microwave oven to loosen soil before cleaning.



### CONTROL PANEL

5. Open oven door to deactivate oven timer.
6. Clean with mild detergent in warm water using soft sponge or cloth. Wring sponge or cloth to remove excess water before wiping equipment.

### ANTENNA/SPLATTER SHIELD

The antenna shield (or splatter/grease shield) is a vital part of the oven's design.

Clean the shield in place to prevent food splatter/debris from building up on the oven ceiling.

7. Unplug Oven 
8. Clean antenna shield with mild detergent in warm water using soft sponge or cloth. Wring sponge or cloth to remove excess water before wiping equipment.
9. FOR STUBBORN DEBRIS, it may be necessary to remove antenna shield for deeper cleaning.
  - a. Unplug Oven  to stop antenna from rotating
  - b. Remove antenna shield
    - Press the front 2 tabs and pull down
    - Remove the shield by inclining at a 45 degree angle
  - c. Clean shield in warm water with mild detergent. Rinse with water.
  - d. Dry thoroughly
  - e. Reinstall shield
    - Position shield with "This Side Up" facing up and legible
    - Insert shield into cavity at an angle
    - Insert the back 2 pins, then push the front up into position
  - f. Check for proper installation
    - After assembly, the 4 pins need to be inserted through the holes.
    - Using finger, pull downward on shield to assure all pins are engaged in cavity holes and shield is securely installed.
  - g. Reconnect power to oven.

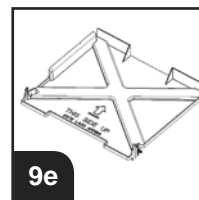
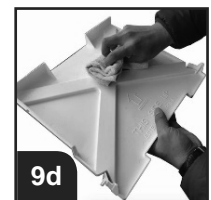
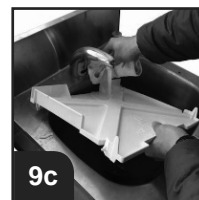
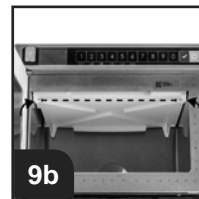

# Care and Cleaning (continued)

---

See previous page for detailed Daily Care and Cleaning recommendations.

---

## Weekly Care and Cleaning

### AIR FILTERS

Filter is located below oven door. Clean air intake filter weekly for proper airflow.

**⚠ IMPORTANT:** To avoid overheating and oven damage, clean air filter regularly.

**⚠ CAUTION:** Do NOT operate oven without filter in place.

1. Unplug Oven. 
2. Grasp filter tabs and pull forward. Filter will release from retaining clips.
3. Wash filter in hot water and mild detergent. Rinse and dry thoroughly.
4. To reinstall, place bottom of filter in clips and push top of filter into position.



Remove air filter to clean

---

## Monthly Care and Cleaning

### DISCHARGE AIR VENTS

Check monthly for a buildup of cooking vapors along intake and discharge louvers on bottom and back of oven. Clean air vents with damp cloth to ensure proper airflow. Dry thoroughly.



Discharge Air Vents

# Before Calling for Service

Record all inspections and repair for future reference.

## ⚠ WARNING

To avoid electrical shock which can cause severe personal injury or death, do not remove outer case at any time. Only an authorized servicer should remove outer case.

SYMPTOM	POSSIBLE CAUSE
Oven fan runs and light remains on after cook cycle has completed	Fan cools oven components. It is normal for fan to run 60 seconds
Oven fan runs while oven is not cooking	Normal operation
Oven does not operate	Confirm oven is plugged in. Check fuse or circuit breaker. Confirm oven is plugged into dedicated circuit. Confirm oven is on grounded and polarized circuit. Contact electrician to confirm.
If oven does not accept entries when keypad is pressed	Open and close oven door. Press keypad again.
If oven malfunctions	Unplug oven, wait for 1 minute, and plug in oven.
Oven operates intermittently	Check air filters and discharge area for obstructions
Oven operates, but does not heat food	Place one cup cool water in oven. Heat for one minute. If water temperature does not rise, oven is operating incorrectly and a service should be called.
"Clean Filter" displays	This is normal and will appear for 24 hours.
Frozen oven display	Oven display needs to reset. Unplug oven. Wait 5 seconds. Plug back in.
"INVALID ENTRY" alert	Cook time is zero or unset. Enter correct cook time.
"Exceeds Maximum Cook Time" alert	Total cook time exceeds the maximum allowable. Check cook times per stage. Check User Option>Maximum Cook Time

**Amana® Commercial HDC**  
Contact:



**866-426-2621**

**MenuMaster® MDC/DEC**  
Contact:



**866-811-8559**

email: [commercialservice@acpsolutions.com](mailto:commercialservice@acpsolutions.com)

For full product documentation visit:  
[www.acpsolutions.com](http://www.acpsolutions.com)