

Commercial Microwave—Technical Information

230V, 50 Hz Models

RMS510TS2	P2006703M	RMS510DS2	P2006704M
RMS510TSUA	P2006707M	RMS510DSUA	P2006708M
RMS510TSCA	P2006709M	RMS510TSIA	P2006710M
RMS510TSAA	P2006711M		

Due to possibility of personal injury or property damage, always contact an authorized technician for servicing or repair of this unit.

Refer to Owner's Manual for installation and operating instructions



WARNING

To avoid the risk of electrical shock, personal injury or death, disconnect power to oven and discharge capacitor before servicing, unless testing requires power.





Model	Region	Control	Consumption	Power Source	Plug Type
RMS510TS2	EMEA, SEA, LATAM	Touch	1500 W, 7.3 A	230v, 50hz, 16A	CEE 7/7 "Schuko"
RMS510DS2	EMEA, SEA, LATAM	Dial	1500 W, 7.3 A	230v, 50hz, 16A	CEE 7/7 "Schuko"
RMS510TSUA	EMEA, UK, LATAM	Touch	1500 W, 7.3 A	230v, 50hz, 13A	BS1363/A
RMS510DSUA	EMEA, UK, LATAM	Dial	1500 W, 7.3 A	230v, 50hz, 13A	BS1363/A
RMS510TSAA	Australia	Touch	1500 W, 7.3 A	230v, 50hz, 10A	Type 1
RMS510TSCA	China	Touch	1500 W, 7.3 A	230v, 50hz, 16A	China
RMS510TSIA	India	Touch	1500 W, 7.3 A	230v, 50hz, 16A	BS546

Models	RMS510D / RMS510T*
Power Output	
Nominal microwave energy (IEC705)	1000 Watts
Minimum temperature rise (ΔT)	10° F / 5° C
Operating Frequency	2450 MHz
Dimensions	
Cabinet	
Width	508mm (20")
Height	311mm (12 1/4")
Depth	419mm (16 1/2")
Oven Interior	
Width	330.2mm (13")
Height	197mm (7 3/4")
Depth	330.2mm (13")
Weight	
Crated	14.5 kg. (39 lbs.)
Uncrated	17.7 kg. (32 lbs.)

Component Testing Procedures

WARNING

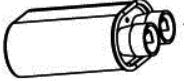
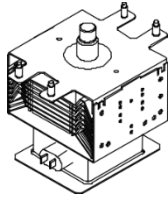
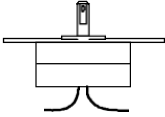
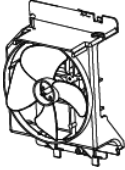

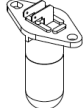
To avoid risk of electrical shock, personal injury or death, disconnect power to oven and discharge capacitor before servicing, unless testing requires power.

Illustration	Component	Test	Results
	Thermal Cutout	Disconnect all wires from TCO. Measure resistance across terminals. Cavity TCO..... Magnetron TCO.....	Open at 203° F (95° C) Closes at 185° F (85° C) Open at 293° F (145° C) Closes at 275° F (135° C)
	Diode/Rectifier	Discharge Capacitor Remove diode lead from capacitor and connect ohmmeter. Reverse leads for second test.	Infinite resistance should be measured in one direction and 50KΩ or more in the opposite direction. NOTE: Test meter must contain a battery of 6 volts minimum.
	Capacitor	Discharge Capacitor Remove wires from capacitor terminals and connect ohmmeter, set on highest resistance scale to terminals. Also check between each terminal and capacitor case.	Check 1.20uf value for + or - 3% Between Terminals: Meter should momentarily deflect towards zero then return to over 5 MΩ. If no deflection occurs, or if continuous deflection occurs, replace capacitor. Terminal to Case: Infinite resistance.
	Magnetron	Discharge Capacitor Remove wires from magnetron and connect ohmmeter to terminals. Also check between each terminal and ground.	2M248(J)A -B2 Between Terminals: Less than 1 Ω. Each terminal to ground measures Infinite resistance. NOTE: This test is not conclusive. If oven does not heat and all other components test good replace the magnetron and retest.
	Stirrer Motor	Remove all wires from terminals. Measure resistance from: terminal to terminal.....	230vac 50hz 29.1rpm Bidirectional Approximately 4 KΩ.
	Blower Motor	Remove all wires from motor. Measure resistance from terminal to terminal.....	Approximately 50 Ω. 230vac 50hz 2800rpm
	Fuse block / Filter assembly 20A Fuse	Power In terminals..... Power Out terminals..... Continuity Test	230 VAC 230 VAC Rated 20A 250vac
	LED Lamp	Power across terminals	230vac = light 48 lumens

Component Testing Procedures

⚠ WARNING

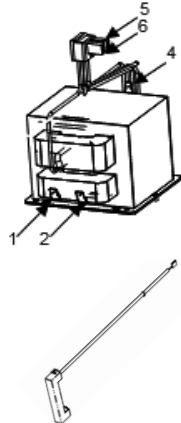
To avoid risk of electrical shock, personal injury or death, disconnect power to oven and discharge capacitor before servicing, unless testing requires power.

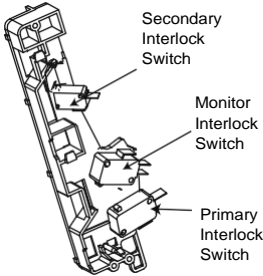
Illustration	Component	Test	Results
	Transformer	Discharge Capacitors Remove all wires from terminals. Measure resistance from: Terminal 1 to Terminal 2..... Wire 5 to Wire 6 Terminal 4 to Ground screw on transformer... Terminal 4 to any other terminal.....	2.0 Ω. Less than 1 Ω. 127Ω. Infinite resistance
	HV Fuse (Terminal 4)	Resistance	Continuity Rated 700ma 5KV
	Interlock switch assembly	With door open measure resistance from: Terminal C to NO Secondary..... Terminal C to NC Monitor Terminal C to NO Primary / Logic..... With door closed measure resistance from: Terminal C to NO Secondary..... Terminal C to NC Monitor Terminal C to NO Primary / Logic.....	Infinite Continuity Infinite Continuity Infinite Continuity
Wire Harness		Disconnect wires to switch.	Continuity.

Service Mode

To Check Magnetron Hours or Door Cycles:

- 1) Open door and Press/Hold Pad #3 for 5 seconds or until "SErV" is Displayed
- 2) Press Pad #1 to display Magnetron Hours in 100's.
- 3) Press Pad #3 to display Door Cycles in 100's

Power Output Wattage Testing Procedure



WARNING

To avoid risk of electrical shock, personal injury or death, disconnect power to oven and discharge capacitor before servicing, unless testing requires power.

All Amana and Menumaster microwave oven power outputs are rated using the IEC705 standards. Using the IEC705 test method requires precision measurements and equipment that is not practical to be performed in the field. Using the test shown below will indicate if the oven performance is satisfactory.

Test equipment required:

- 1000 ml test container and thermometer.
- Digital watch / watch with a second hand for use on ovens with electromechanical timers.

Important Notes:

- Low line voltage will cause low temperature rise / power output.
- Ovens must be on a dedicated circuit, properly grounded, and polarized. Other equipment on the same circuit may cause a low temperature rise / power output.
- This test and results are not a true IEC705 test procedure and are only intended to provide servicers with an easy means of determining if the microwave oven cooking output is correct.

Procedure

1. Fill the test container to the 1000 ml line with cool tap water.

NOTE: Water temperature should be approximately 60° F / 16° C.

2. Using the thermometer, stir water for five to ten seconds; measure, and record the temperature (T1).
3. Place test container of water in the center of oven cavity and close door.
4. Heat the water for a 33-second full power cycle.

NOTE: Use a digital watch or a watch with a second hand for ovens with electromechanical timers.

5. At end of the cycle, remove test container. Using the thermometer, stir water for five to ten seconds and record temperature (T2).
6. Subtract the starting water temperature (T1), from the ending water temperature (T2) to obtain the temperature rise (ΔT).
7. If the temperature rise (ΔT) meets or exceeds the minimum, the test is complete. If the temperature rise (ΔT) fails to meet the minimum temperature rise, test the line voltage to verify it is correct. Then repeat steps 1 - 6 making sure to change the water. If the temperature rise (ΔT) fails to meet the minimum temperature rise again the oven will require service.

Minimum Temperature Rise at Thirty -Three (33) Seconds Run Time

ΔT (°F)	Cooking Power Output	ΔT (°F)	Cooking Power Output	ΔT (°C)	Cooking Power Output	ΔT (°C)	Cooking Power Output
10	1000	20	2000	5	1000	11.....	2000
11	1100	21	2100	5.5	1100	11.5.....	2100
12	1200	22	2200	6.5	1200	12.....	2200
14	1400	24	2400	7.5	1400	13.....	2400
17	1700	25	2500	9.5	1700	13.5.....	2500
18	1800	27	2700	10	1800	15.....	2700
19	1900	30	3000	10.5	1900	16.5.....	3000

Wiring and Schematic Diagrams



WARNING

To avoid risk of electrical shock, personal injury or death, disconnect power to oven and discharge capacitor before servicing, unless testing requires power.

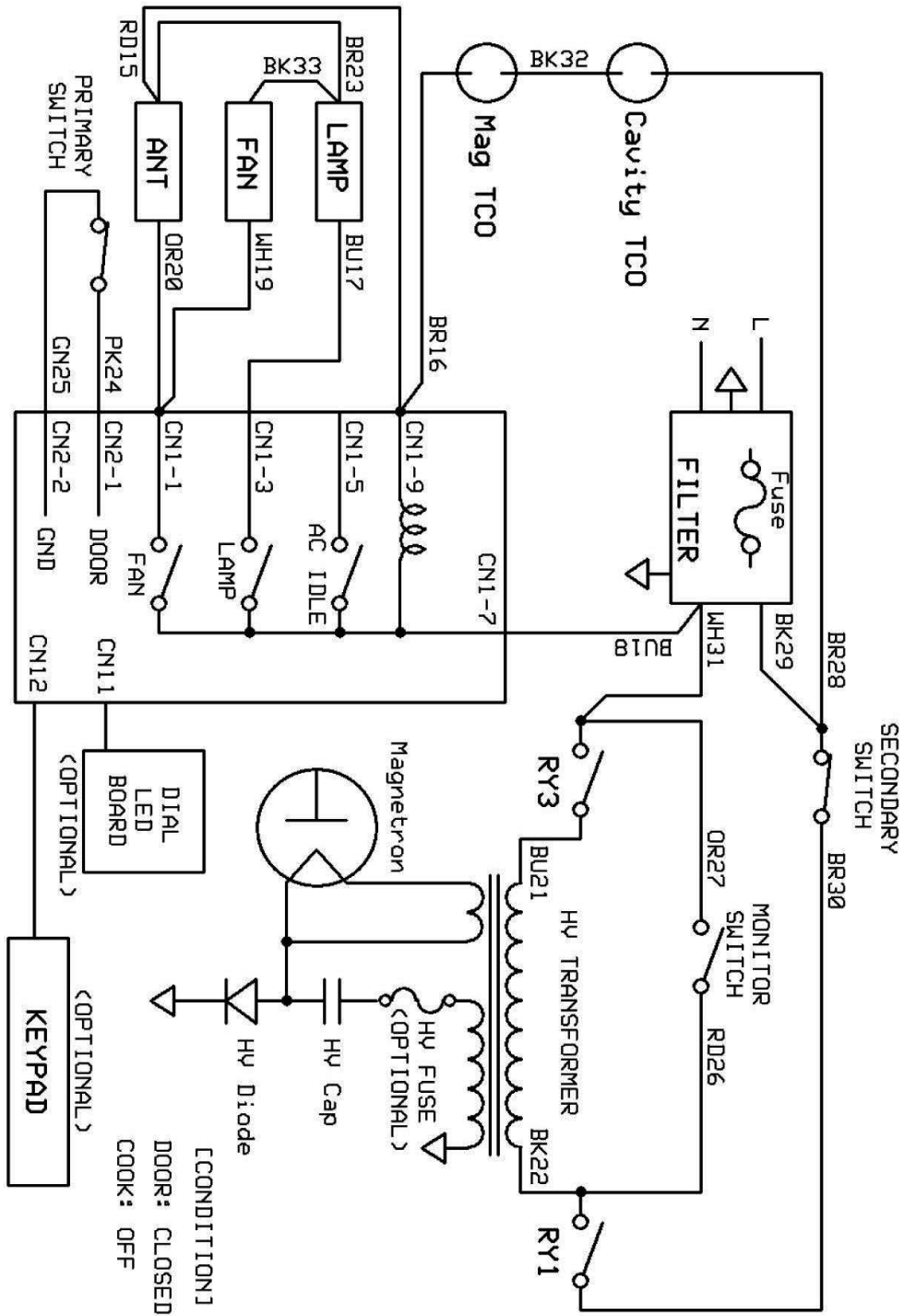

Electronic Control Operation

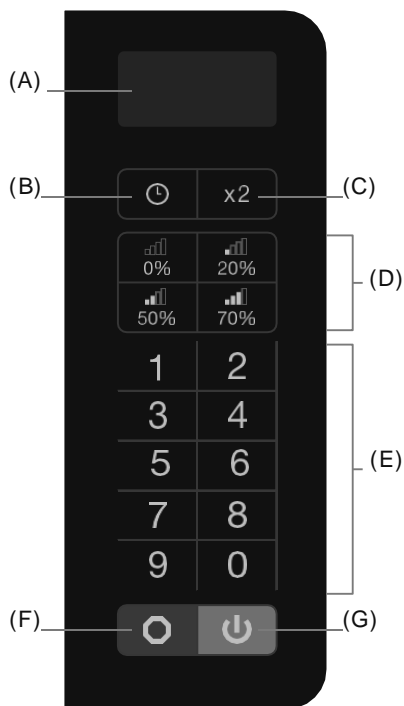

Note: Control panel coloring may vary by model

Control Panel Features

- (A) **LED DISPLAY**
- (B) **TIME ENTRY KEY**
- (C) **X2 KEY**
- (D) **POWER LEVEL KEYS**
- (E) **NUMBER KEYS / PRESET PROGRAM KEYS**
- (F) **STOP/RESET KEY**
- (G) **START KEY**

So...how do I use it?

Interrupting Operation (Pause Mode)

While the oven is operating, press STOP/RESET key to interrupt operation. Display shows remaining cooking time. Close door and press START key to resume oven operation.

Canceling Mistakes

If oven is not cooking, press STOP/RESET key to clear display. If oven is cooking, press STOP/RESET key once to stop oven, then again to clear display. If oven door is open and time shows in display, close oven door and press STOP/RESET key to clear display.

Manual Time Entry Mode

Time entry mode allows the user to manually enter a cook time and power level.

1. Open oven door and place food in oven. Close door.
2. Press the TIME ENTRY key . "00:00" is displayed.
3. Press Number Keys to enter the desired cook time.
4. Press POWER LEVEL key , , or to select power level. LED will display the related power. If the same key is pressed twice, the power will change to PL10 (Power Level 10 or full power). If no power chosen, PL10 is default.
5. Press START key to begin cooking. Oven begins cooking and the LED displays cooking time.
6. At the end of the cooking cycle, the oven beeps and LED displays "End".

Operating Preset Program Keys

From the factory, this oven can store up to 10 preprogrammed cooking sequences in memory, for one key touch operation.

1. Open oven door and place food in oven. Close door.
2. Press a Number Key to run the Preset Program associated with that key. Oven begins cooking and the LED displays cooking time.
3. At the end of the cooking cycle, the oven beeps and LED displays "End".

FACTORY PRESET PROGRAM SETTINGS

NUMBER KEY	TIME	POWER
1	10 sec.	100%
2	20 sec.	
3	30 sec.	
4	45 sec.	
5	1:00 min.	
6	1:30 min.	
7	2:00 min.	
8	3:00 min.	
9	4:00 min.	
0	5:00 min.	

*Note: Factory setting may vary by model

The switching operation of this microwave oven can cause voltage fluctuations on the supply line. The operation of this oven under unfavorable voltage supply conditions can have adverse effects. This device is intended for the connection to a power supply system with a maximum permissible system impedance Z_{max} of 0.2 Ohms at the interface point of the user's supply. The user has to ensure that this device is connected only to a power supply system which fulfills the requirement above. If necessary, the user can ask the public power supply company for the system impedance at the interface point.





Electronic Control Operation

Programming Mode

This mode allows the user to assign cook times, power levels, and stage cooking to the Number Keys.

1. Open oven door and press and hold Number Key "1" for 5 seconds. The oven beeps and LED displays "ProG".

Note: If STOP/RESET key  is pressed before programming is complete, changes are discarded and microwave exits programming mode.



2. Press a Number Key to change or review a Preset Program setting.
3. Press Number Keys to enter the new desired cook time.
4. Press POWER LEVEL key , ,  or  to select power level. LED will display the related power. If the same key is pressed twice, the power will change to PL10 (Power Level 10 or full power). If no power chosen, PL10 is default.
5. Press START key  to save the cooking program. LED displays "ProG".

Note: If the program chosen exceeds the maximum time allowed by User Option 7, then the oven will beep three times and return to "ProG" to indicate the program is unacceptable.

6. Close the door to exit Programming Mode.

Programming Multiple Cooking Stages

This allows food items to be cooked using a combination of various power levels and times. A maximum of four stages can be set.

1. From Programming Mode or Manual Time Entry Mode, set time and power level for the first stage.
2. Press TIME ENTRY key  to set the next stage. LED displays "S-2", "S-3" or "S-4" to indicate second, third, or fourth stage. Set time and power for the stage.
3. Repeat step 2 for any subsequent stages.
4. Press START key  to save the cooking program or begin cooking.

X2 - Double Quantity Cooking

The X2 pad allows two quantities of the same food item to be cooked at once



Note: X2 function may be used only with Preset Program Number Keys.

1. Open oven door and place food in oven. Close door.
2. Press X2 key , LED displays "doub".
3. Press desired Preset Program Number Key(s). LED displays the cooking time for two quantities. The oven will start cooking per the quantity preset cooking time.
4. At the end of the cooking cycle, the oven beeps and LED displays "End".

Example: If number "5" key is programmed to cook for 1:00, when first pressing X2 key and then pressing number "5" key, the oven will automatically set the cook time to 1:48. (1:00 cook cycle x 80% "X2" cook factor = 1:48)

PROGRAMMING EXAMPLE:





To save a cook setting of 1 minute and 25 seconds at 70% power on Number Key "3".

1. Open oven door and press Number Key "1" for 5 seconds. LED displays "ProG".
2. Press Number Key "3".
3. Press Number Keys "1", "2" and "5" to input the cooking time. LED displays 1:25.
4. Press 70% POWER LEVEL key  to input 70% power level. LED displays "PL7".
5. Press START key  to save.
6. To use this program press "3". The oven will start operating for 1:25 at 70% power.

MULTIPLE STAGE

PROGRAMMING EXAMPLE:

To save a cook setting of two stages on Number Key "3". Stage 1: 1 minute 25 seconds at 70% power; Stage 2: 5 minutes 40 seconds at 50% power.

1. Open oven door and press Number Key "1" for 5 seconds. LED displays "ProG".
2. Press Number Key "3".
3. Press Number Keys "1", "2" and "5" to input the cooking time. LED displays 1:25.
4. Press 70% POWER LEVEL key  to input 70% power level. LED displays "PL7". The first stage is finished.
5. Press TIME ENTRY key , LED displays "S-2".
6. Press Number Keys "5", "4", "0" button, LED displays "5:40"
7. Press 50% POWER LEVEL key  to input 50% power. LED displays "PL5". The second stage is finished.
8. Press START key  to save.
9. To use this program press "3". The oven will start operating for 7:05 (1:25 at 70% power + 5:40 at 50% power).

Electronic Control Operation

On-the-Fly Cooking



On-the-Fly Cooking allows the user to start another cook cycle while the oven is operating or paused.

Note: User Option OP:51 must be enabled for use of On-the-Fly cooking.

1. While the oven is cooking or while in Pause Mode, press a Number Key to automatically start the Preset Program associated with that key.
2. Oven begins cooking and the LED displays cooking time.
3. At the end of the cooking cycle, the oven beeps and LED displays "End".

User Option Mode

This allows the user to customize various oven settings.

1. Open oven door and press Number Key "2" for 5 seconds. Oven beeps and LED displays "OP: - -".
2. Press any Number Key to enter related options as noted in chart below.
3. To change, repeat pressing the Number Key until desired setting is reached.
4. Press START key  to save the selected setting. LED displays "OP: - -" to indicate selection was saved and another option change can be made.
5. To exit User Option Mode, press STOP/RESET key  and closed door.

Note: If START key  is not pressed as the last step, the selected option will not be saved.

CHANGING USER OPTION

EXAMPLE:

To set the key beep volume to high.

1. Open oven door and press Number Key "2" for 5 seconds. LED displays "OP: - -".
2. Press Number Key "2". "OP:22" displays.
3. To change, repeat pressing "2". LED displays "OP:20", "OP:21", "OP:22", "OP:23" etc. Stop pressing once "OP:23" displays.
4. Press START key  to save the selected setting. LED displays "OP: - -" to indicate selection was saved and another option change can be made.

NUMBER KEY	DISPLAY	OPTIONS (FACTORY SETTINGS IN BOLD)
1 End of Cycle Beep	OP:10 OP:11 OP:12	3 second beep Continuous beep until door is opened 5 beep bursts until door is opened
2 Key Beep Volume	OP:20 OP:21 OP:22 OP:23	Eliminates beep Sets volume to low Sets volume to medium Sets volume to high
3 Key Beep	OP:30 OP:31	Prevents beep when pad is pressed Allows beep when pad is pressed
4 Active Display	OP:40 OP:41 OP:42 OP:43	15 seconds after oven door is opened, keyboard disabled 30 seconds after oven door is opened, keyboard disabled 1 minute after oven door is opened, keyboard disabled 2 minutes after oven door is opened, keyboard disabled
5 On-the-Fly Cooking	OP:50 OP:51	Prevents different pre-programmed pads to be activated during cooking Allows different pre-programmed pads to be activated during cooking
6 Reset Door Open	OP:60 OP:61	Allows oven to resume heating time countdown after door is opened during cycle Cancels heating time count down after door is opened during cycle.
7 Maximum Heating Time	OP:70 OP:71	Allows 30 minutes of heating time Allows 10 minutes of heating time
8 Manual Operation	OP:80 OP:81	Allows use of preprogrammed pads only Allows use of manual time entry and preprogrammed pads
9 Double Digit Operation	OP:90 OP:91	Allows 10 (0-9) preprogrammed pads Allows 20 (00-99) preprogrammed pads

*Note: Factory setting may vary by model