

Fry Warmer

MODELS FW-12, FW-15, FW-12T, FW-15T, FW-15DTO

Service Manual

Serial Numbers 120182 and Higher



Fresh ideas in foodservice equipment

BKI LIMITED WARRANTY

2812 Grandview Dr. • Simpsonville, SC 29680 • USA
(864) 963-3471 • Toll Free: (800) 927-6887 • Fax: (864) 963-5316

WHAT IS COVERED	<p>This warranty covers defects in material and workmanship under normal use, and applies only to the original purchaser providing that:</p> <ul style="list-style-type: none">☐ The equipment has not been accidentally or intentionally damaged, altered or misused;☐ The equipment is properly installed, adjusted, operated and maintained in accordance with national and local codes, and in accordance with the installation and operating instructions provided with this product.☐ The serial number rating plate affixed to the equipment has not been defaced or removed.
WHO IS COVERED	<p>This warranty is extended to the original purchaser and applies only to equipment purchased for use in the U.S.A.</p>
COVERAGE PERIOD	<ul style="list-style-type: none">☐ Warranty claims must be received in writing by BKI within one (1) year from date of installation or within one (1) year and three (3) months from data of shipment from the factory, whichever comes first.☐ COB Models: One (1) Year limited parts and labor.☐ COM Models: Two (2) Year limited parts and labor. COM convection ovens also have a two (2) year door warranty.☐ CO1 Models: Two (2) Year limited parts and labor. Five (5) Year limited door warranty.☐ BevLes Products: Two (2) Year limited parts and labor.☐ Warranty period begins the date of dealer invoice to customer or ninety (90) days after shipment date from BKI, whichever comes first.
WARRANTY COVERAGE	<p>This warranty covers on-site labor, parts and reasonable travel time and travel expenses of the authorized service representative up to (100) miles round trip and (2) hours travel time and performed during regular, weekday business hours.</p>
EXCEPTIONS	<p>Any exceptions must be pre-approved in advance and in writing by BKI. The extended door warranty on convection ovens years 3 through 5 is a parts only warranty and does not include labor, travel, mileage or any other charges.</p>
EXCLUSIONS	<ul style="list-style-type: none">☐ Negligence or acts of God,☐ Thermostat calibrations after (30) days from equipment installation date,☐ Air and gas adjustments,☐ Light bulbs,☐ Glass doors and door adjustments,☐ Fuses,☐ Adjustments to burner flames and cleaning of pilot burners,☐ Tightening of screws or fasteners,☐ Failures caused by erratic voltages or gas suppliers,☐ Unauthorized repair by anyone other than a BKI Factory Authorized Service Center,☐ Damage in shipment,☐ Alteration, misuse or improper installation,☐ Thermostats and safety valves with broken capillary tubes,☐ Freight - other than normal UPS charges,☐ Ordinary wear and tear,☐ Failure to follow installation and/or operating instructions,☐ Events beyond control of the company.
INSTALLATION	<p>Leveling, as well as proper installation and check out of all new equipment - per appropriate installation and use materials - is the responsibility of the dealer or installer, not the manufacturer.</p>
REPLACEMENT PARTS	<p>BKI genuine Factory OEM parts receive a (90) day materials warranty effective from the date of installation by a BKI Factory Authorized Service Center.</p>

Table of Contents

Table of Contents	1
Introduction	2
Safety Precautions.....	2
Safety Signs and Messages.....	2
Safe Work Practices.....	2
Safety Labels	4
Installation	5
Instructions For Shipping Damage	5
Electrical Information And Grounding.....	5
Installation Instructions	5
FW-12 & FW-12T (Side Breather).....	5
FW-15 (Side Breather)	6
FW-15 (Bottom Breather).....	7
FW-15T/FW-15DTO (Bottom Breather).....	9
Maintenance	10
Scheduled Maintenance	10
Cleaning	10
Troubleshooting.....	11
Repair	11
Lamp Replacement	11
Replacement Parts	12
Components	12
FW-12/FW-15 CUF (Side Breather).....	12
FW-12/FW-15 PASS THRU (Side Breather).....	14
FW-15 CUF (Bottom Breather)	16
FW-15 PASS THRU (Bottom Breather).....	18
FW-12T (Side Breather).....	20
FW-15T (Bottom Breather).....	21
FW-15DTO (Bottom Breather)	22
Accessories	24
Wiring Diagrams	25
FW-12/FW-15 (Side Breather).....	25
FW-12/FW-15 (Bottom Breather)	26
FW-15 (220V England).....	27
FW-12T/FW-15T.....	28
FW-15DTO (Bottom Breather).....	30
Notes	32

Introduction

Congratulations! You have chosen a **Fry Warmer** that will give you many years of fine service from the original manufacturer, **BKI**.

The **BKI** name and trademark on this unit assures you of the finest in design and engineering — that it has been built with care and dedication — using the best materials available. Attention to the operating instructions regarding proper installation, operation, and maintenance will result in long lasting dependability to insure the highest profitable return on your investment.

NOTICE

PLEASE READ THIS ENTIRE MANUAL BEFORE OPERATING THE UNIT. If you have any questions, please contact your **BKI** Distributor. If they are unable to answer your questions, contact the **BKI** Technical Service Department, toll free: 1-800-927-6887. Outside the U.S., call 1-864-963-3471.

This unit must be sealed to the counter after it is installed to conform to NSF Standard 4, Item 4.28. (Dow Corning RTV #732 Multi purpose Sealant.)

Safety Precautions

Always follow recommended safety precautions listed in this manual. Below is the safety alert symbol. When you see this symbol on your equipment, be alert to the potential for personal injury or property damage.



Safety Signs and Messages

The following Safety signs and messages are placed in this manual to provide instructions and identify specific areas where potential hazards exist and special precautions should be taken. Know and understand the meaning of these instructions, signs, and messages. Damage to the equipment, death or serious injury to you or other persons may result if these messages are not followed.

DANGER

This message indicates an imminently hazardous situation that, if not avoided, will result in death or serious injury.

WARNING

This message indicates a potentially hazardous situation, which, if not avoided, could result in death or serious injury.

CAUTION

This message indicates a potentially hazardous situation, which, if not avoided, may result in minor or moderate injury. It may also be used to alert against unsafe practices.

NOTICE

This message is used when special information, instructions or identification are required relating to procedures, equipment, tools, capacities and other special data.

Safe Work Practices

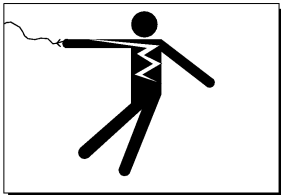

Beware of High Voltage

This equipment uses high voltage. Serious injury can occur if you or any untrained or unauthorized person installs, services, or repairs this equipment. Always Use an Authorized Service agent to Service Your Equipment.

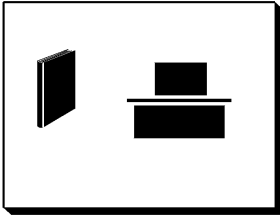

Keep this manual with the Equipment

This manual is an important part of your equipment. Always keep it near for easy access. If you need to replace this manual, contact:

BKI

Technical Services Department
 2812 Grandview Drive
 Simpsonville, S.C. 29680
 Or call toll free: 1-800-927-6887
 Outside the U.S., call 864-963-3471



Protect Children

Keep children away from this equipment. Children may not understand that this equipment is dangerous for them and others.

NEVER allow children to play near or operate your equipment.

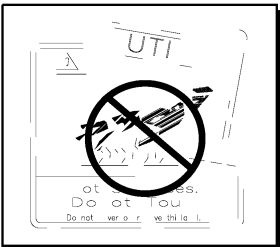

Keep Safety Labels Clean and in Good Condition

Do not remove or cover any safety labels on your equipment. Keep all safety labels clean and in good condition. Replace any damaged or missing safety labels. Refer to the Safety Labels section for illustration and location of safety labels on this unit. If you need a new safety label, obtain the number of the specific label illustrated on page 4, then contact:

BKI

Technical Services Department
 2812 Grandview Drive
 Simpsonville, S.C. 29680
 Or call toll free: 1-800-927-6887
 Outside the U.S., call 864-963-3471

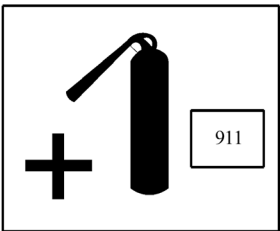

Be Prepared for Emergencies

Be prepared for fires, injuries, or other emergencies.

Keep a first aid kit and a fire extinguisher near the equipment. You must use a 40-pound Type BC fire extinguisher and keep it within 25 feet of your equipment.

Keep emergency numbers for doctors, ambulance services, hospitals, and the fire department near your telephone.

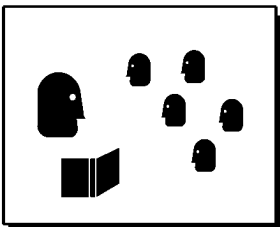

Know your responsibilities as an Employer

- Make certain your employees know how to operate the equipment.
- Make certain your employees are aware of the safety precautions on the equipment and in this manual.
- Make certain that you have thoroughly trained your employees about operating the equipment safely.
- Make certain the equipment is in proper working condition. If you make unauthorized modifications to the equipment, you will reduce the function and safety of the equipment.

Safety Labels

N0200



N0444



N0202



N0158



Installation

⚠ WARNING

Serious injury, equipment damage or death could result if attempting to install this unit yourself. Ensure that an authorized BKI service agent install the oven.

Instructions For Shipping Damage

You are responsible for filing all freight claims with the delivering truck line. Inspect all cartons and crates for damage when they arrive. If there is damage noted to shipping crates or cartons, or, if a shortage is found, note this on the bill of lading (all copies) before signing.

If damage is detected when the equipment is uncrated, immediately call the delivering truck line and follow up the call with a written report indicating concealed damage to your equipment. Ask for an immediate inspection of your concealed damage item. Crating material **MUST** be retained to show the inspector from the truck line.

Electrical Information And Grounding

⚠ WARNING

Electrocution, equipment failure or property damage could result if an unlicensed electrician performs the electrical installation. Ensure that a licensed electrician perform the electrical installation in accordance with local codes, or in the absence of local codes, with the National Electrical Code, ANSI NFPA 70-20XX.

⚠ CAUTION

The FW-15DTO has 2 power supply cords. Ensure that each cord is connected to a separate power supply circuit. Always unplug both power cords before servicing, moving or testing the unit.

BKI Fry Warmers are wired for use in accordance with all applicable local, state, and federal codes. For specific electrical requirements and connections refer to the wiring diagram attached to the unit or provided in the Service Manual.

Installation Instructions

NOTICE

If a side or back panel is removed on the chute, the other two sides must be sealed with NSF approved silicone. Seal all inside seams greater than 1/32".

FW-12 & FW-12T (Side Breather)

Countertop Adapter (FW-12 only)

1. Obtain a suitable countertop location for the unit that will provide a clearance of 4" from the side louvers.
2. Position the adapter (WN31206400) on the countertop.
3. Using a 1/8" drill bit, drill holes in the countertop used to secure the adapter to the countertop.
4. Using a 2" hole saw, drill a hole in the countertop (directly under the hole in the adapter) used for the power cord to pass through.
5. Secure adapter to countertop with # 8 sheet metal screws.
6. Seal adapter to the countertop to conform to NSF Standard 4, Item 4.28. (Dow Corning RTV #732 Multi purpose Sealant.)
7. Feed power cord (supplied), up through holes in countertop and adapter.

8. Connect wires of power cord to power entry terminal block according to the wiring diagram attached to the unit or provided in the Service Manual.
9. Position main unit on the adapter and secure using #8 sheet metal screws.
10. Fit pan insert to main unit by lifting the open side of pan insert over the two tabs on main unit and lower the pan insert into the opening in the adapter.

Countertop Cutout (FW-12 & FW-12T)

1. Obtain a suitable countertop location for the unit that will provide a clearance of 4" from the side louvers.
2. Cut a 12" x 20" hole in the countertop to fit the pan insert.
3. Using a 1/8" drill bit, drill holes in the countertop used to secure the main unit to the countertop.
4. Using a 2" hole saw, drill a hole in the countertop (under where the main unit will be secured) for the power cord to pass through.
5. Feed power cord (supplied), up through hole in countertop.
6. Connect wires of power cord to power entry terminal block according to the wiring diagram attached to the unit or provided in the Service Manual.
7. Position main unit on the countertop and secure using #8 sheet metal screws.
8. Seal main unit to the countertop after it is installed to conform to NSF Standard 4, Item 4.28. (Dow Corning RTV #732 Multi purpose Sealant.)
9. Fit pan insert to main unit by lifting the open side of pan insert over the two tabs on main unit and lower the pan insert into the opening in the countertop.

FW-15 (Side Breather)

Countertop Adapter (WN31206500)

1. Obtain a suitable countertop location for the unit that will provide a clearance of 4" from the side louvers.
2. Position the adapter (WN31206500) on the countertop.
3. Using a 1/8" drill bit, drill holes in the countertop used to secure the adapter to the countertop.
4. Using a 2" hole saw, drill a hole in the countertop (directly under the hole in the adapter) used for the power cord to pass through.
5. Secure adapter to countertop with # 8 sheet metal screws.
6. Seal adapter to the countertop to conform to NSF Standard 4, Item 4.28. (Dow Corning RTV #732 Multi purpose Sealant.)
7. Feed power cord (supplied), up through holes in countertop and adapter.
8. Connect wires of power cord to power entry terminal block according to the wiring diagram attached to the unit or provided in the Service Manual.
9. Position main unit on the adapter and secure using #8 sheet metal screws.
10. Fit pan insert to main unit by lifting the open side of pan insert over the two tabs on main unit and lower the pan insert into the opening in the adapter.

Countertop Cutout

1. Obtain a suitable countertop location for the unit that will provide a clearance of 4" from the side louvers.
2. Cut a 16" x 18" hole in the countertop to fit the pan insert.
3. Using a 1/8" drill bit, drill holes in the countertop used to secure the main unit to the countertop.
4. Using a 2" hole saw, drill a hole in the countertop (under where the main unit will be secured) for the power cord to pass through.
5. Feed power cord (supplied), up through hole in countertop.
6. Connect wires of power cord to power entry terminal block according to the wiring diagram attached to the unit or provided in the Service Manual.
7. Position main unit on the countertop and secure using #8 sheet metal screws.
8. Seal main unit to the countertop to conform to NSF Standard 4, Item 4.28. (Dow Corning RTV #732 Multi purpose Sealant.)
9. Fit pan insert to main unit by lifting the open side of pan insert over the two tabs on main unit and lower the pan insert into the opening in the countertop.

FW-15 (Bottom Breather)

Countertop Collar Weldment With Liner Pan (WB31216000)

1. Obtain a suitable countertop location for the unit.
2. Cut holes in the countertop for the countertop collar weldment with liner pan (WB31216000) according to illustration below:

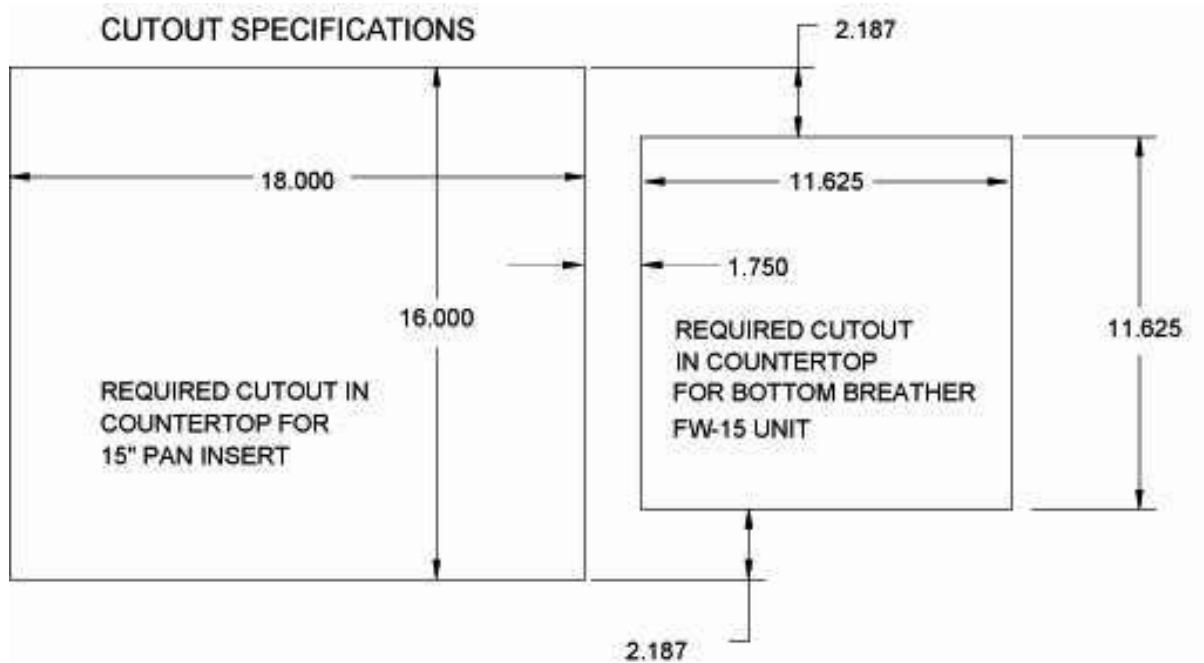

3. Using a 1/8" drill bit, drill holes in the countertop used to secure WB31216000 to the countertop.

4. Secure WB31216000 to countertop with # 8 sheet metal screws.
5. Seal WB31216000 to the countertop to conform to NSF Standard 4, Item 4.28. (Dow Corning RTV #732 Multi purpose Sealant.)
6. Feed power cord (supplied), up through holes in WB31216000.
7. Connect wires of power cord to power entry terminal block according to the wiring diagram attached to the unit or provided in the Service Manual.
8. Position main unit on WB31216000.
9. Fit pan insert to main unit by lifting the open side of pan insert over the two tabs on main unit and lower the pan insert into the opening in the WB31216000.

Countertop Collar Weldment Without Liner Pan (WB31211900)

1. Obtain a suitable countertop location for the unit.
2. Cut a hole in the countertop for the countertop collar weldment without liner pan (WB31211900) according to illustration below:

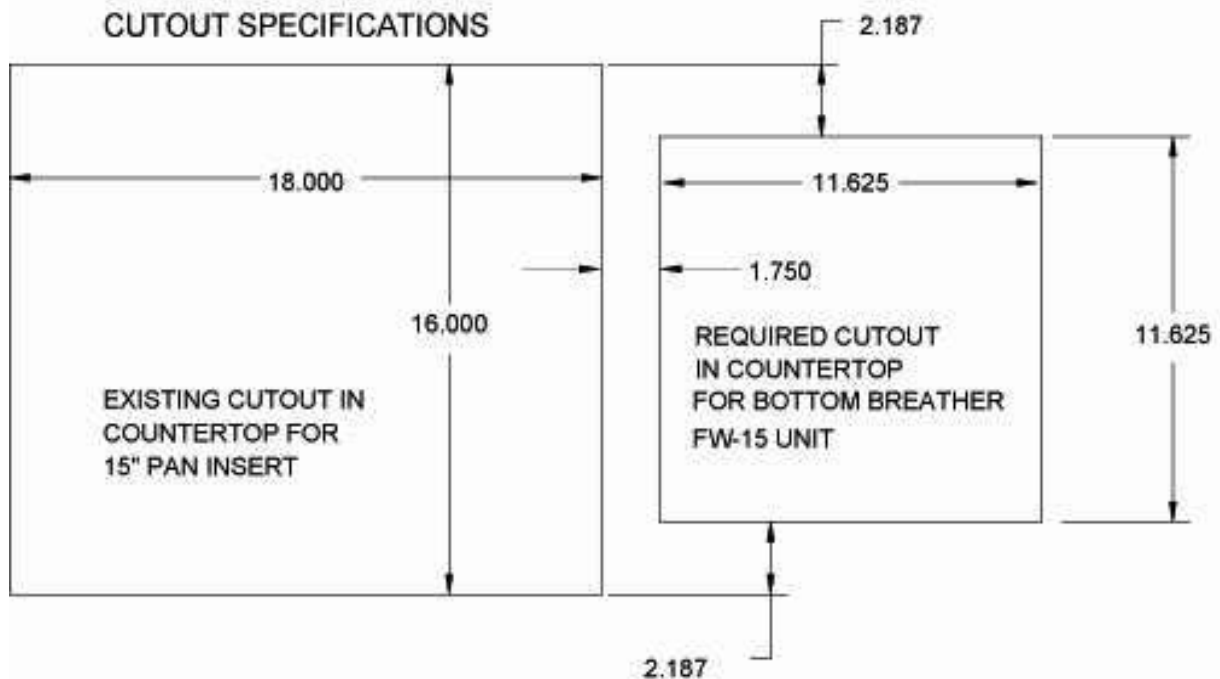

3. Using a 1/8" drill bit, drill holes in the countertop used to secure WB31211900 to the countertop.
4. Secure WB31211900 to countertop with # 8 sheet metal screws.
5. Seal WB31211900 to the countertop to conform to NSF Standard 4, Item 4.28. (Dow Corning RTV #732 Multi purpose Sealant.)
6. Feed power cord (supplied), up through holes in WB31211900.
7. Connect wires of power cord to power entry terminal block according to the wiring diagram attached to the unit or provided in the Service Manual.

8. Position main unit on WB31211900.
9. Fit pan insert to main unit by lifting the open side of pan insert over the two tabs on main unit and lower the pan insert into the opening in the countertop.

FW-15T/FW-15DTO (Bottom Breather)

Countertop Collar Weldment With Liner Pan (WB31217700)

1. Obtain a suitable countertop location for the unit.
2. Cut holes in the countertop for the countertop collar weldment with liner pan (WB31217700) according to illustration below:

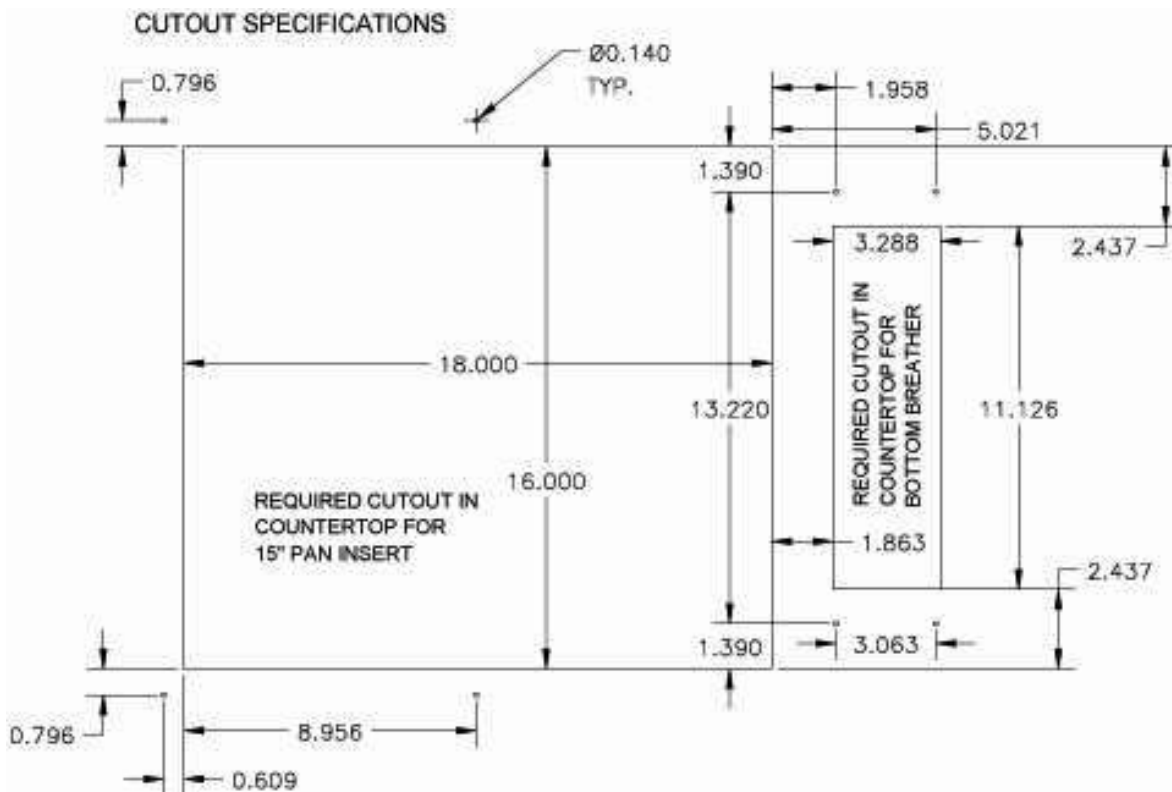

3. Using a 1/8" drill bit, drill holes in the countertop used to secure WB31217700 to the countertop.
4. Secure WB31217700 to countertop with # 8 sheet metal screws.
5. Seal WB31217700 to the countertop to conform to NSF Standard 4, Item 4.28. (Dow Corning RTV #732 Multi purpose Sealant.)
6. Feed power cord (supplied), up through holes in WB31217700.
7. Connect wires of power cord to power entry terminal block according to the wiring diagram attached to the unit or provided in the Service Manual.
8. Position main unit on WB31217700.
9. Fit pan insert to main unit by lifting the open side of pan insert over the two tabs on main unit and lower the pan insert into the opening in the WB31217700.

Maintenance

⚠ CAUTION

Failure to comply with the maintenance below could result in a serious accident.

⚠ WARNING

Electrocution, equipment failure or property damage could result if an unlicensed electrician performs electrical repair. Ensure that a licensed electrician perform electrical repair.

Scheduled Maintenance

Cleaning

This unit should be cleaned at the end of each working day. Use the following procedure:

⚠ DANGER

Failure to remove power from this unit may cause severe electrical shock. This unit may have more than one disconnect switch.

⚠ CAUTION

Never use abrasive cleaners that may damage the finish.

Never steam clean the interior.

Avoid getting excess water in the interior of the unit.

Do not clean the heater/blower assembly by applying compressed air.

Do not leave this unit on and unattended after business hours.

1. Turn the unit off and allow it to cool down to room temperature.
2. Remove any food.
3. Remove the pan and tray, and clean around the slotted holes at the air discharge on the chute. Clean the pan and tray.
4. Clean the air intakes using a mild soap and water solution. When cleaning an FW-15 (Bottom Breather), tilt unit up and clean the dust off the screen attached to the base.
5. Sponge the inside and outside of the unit with a mild soap and water solution, being sure to clean all areas. Avoid getting water in the interior of the unit.
6. Wipe the parts and unit dry with a soft, clean cloth and replace the pan and tray.

Troubleshooting

Refer to the table below for troubleshooting information.

Problem	Cause	Possible Solution
Warmer chute is not holding heat	Ceramic heating element failure	Contact an authorized BKI service agent for corrective action.
Noisy fan	Fan blade is dirty or fan bearings are failing	Contact an authorized BKI service agent for corrective action.
FW-15/FW-15T/FW-15DTO (Bottom Breather)		
Warmer chute is not heating and perforated pan is not heating	No power to unit.	Make sure that the circuit breaker and switch at the power supply are supplying power to the unit. If problem persists, contact licensed electrician.
Warmer chute is heating and the perforated pan is not heating	Fan has overheated and cut off	Wipe the dust from the air intake louvers to allow proper airflow and prevent fan overheating. Turn the power switch off. Wait 60 seconds. Turn the power switch back on.
	Or Heating coil has failed	Contact an authorized BKI service agent for corrective action.
FW-12/FW-12T/FW-15 (Side Breather)		
Warmer chute is not heating and perforated pan is not heating	No power to unit or main switch is off.	Make sure that the circuit breaker and switch at the power supply are supplying power to the unit. If problem persists, contact licensed electrician.
Warmer chute is heating and the perforated pan is not heating	Fan has overheated and cut off or fan has failed	Check to see if dust or any other object is blocking the air intake. Remove blockage if necessary. If problem persists contact an authorized BKI service agent for corrective action.
	Or Heating coil has failed	Contact an authorized BKI service agent for corrective action.

Repair

NOTICE

Before replacing any parts, make sure the power has been turned off and the unit has cooled down.

Lamp Replacement

NOTICE

Only use PTFE-coated lamp to prevent glass contamination.

1. Make sure power to the unit is OFF and the unit has cooled down.
2. Carefully remove the faulty lamp.
3. Replace with the new lamp.

Replacement Parts

Use the information in this section to identify replacement parts. To order replacement parts, call your local BKI sales and service representative. Before calling, please note the serial number on the rating tag affixed to the unit.

Components

FW-12/FW-15 CUF (Side Breather)

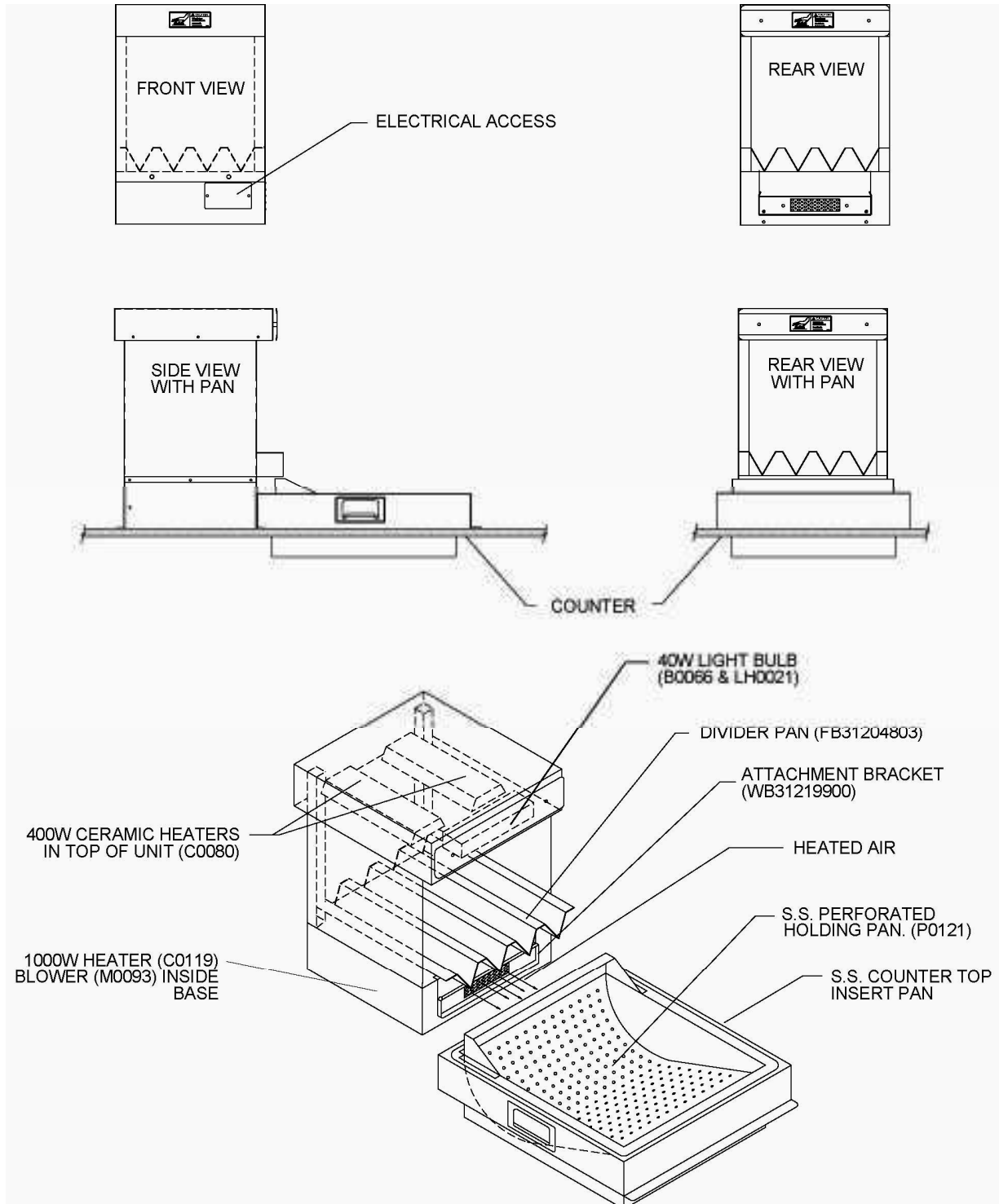

PART #	QTY	DESCRIPTION
B0066	1	BULB, 40A15 130V PTFE COATED
C0119	1	CALROD, 120V 1000W 140C C/U SWITCH
C0080	2	CALROD, 120V 400W CERAMIC
CS0024	1	CORD SET, 12/3 SJTO 8' 30"LEAD
FB31204803	1	DIVIDER PAN FW CUF
WB31219900	1	GREASE DEFL.RET.BRKT.WELD FW
LH0021	1	LAMPHOLDER, #62602 HI TEMP
M0093	1	MOTOR BLOWER ASSY 120V
P0129	1	PAN INSERT 12" FW
P0121	1	PAN INSERT 15" FW
S0356	1	SWITCH, ROCKER 16A 250V

FW-12/FW-15 PASS THRU (Side Breather)

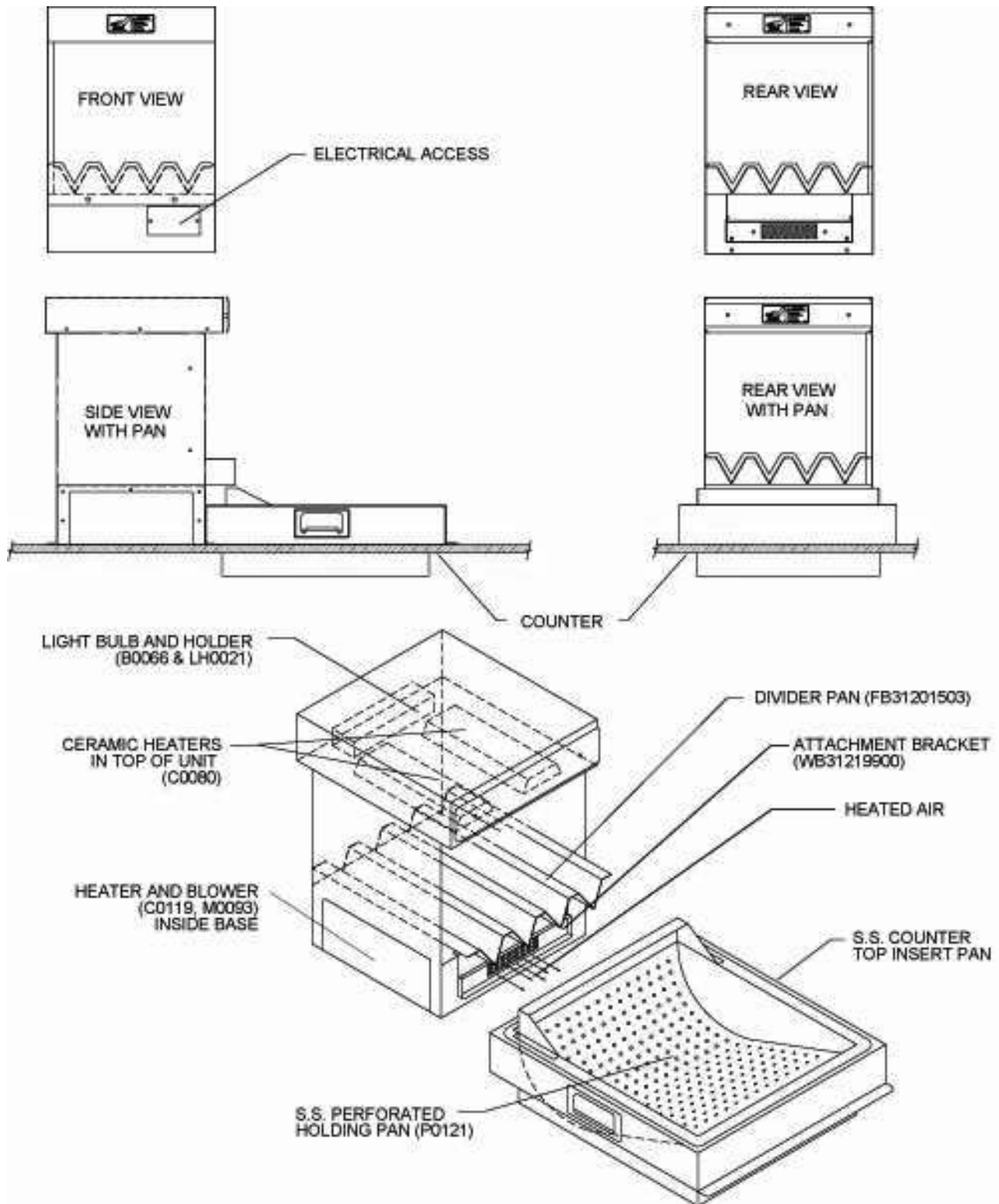

PART #	QTY	DESCRIPTION
B0555*	1	BULB, 150W 240V HALOGEN COATED (220V England)
B0066	1	BULB, 40A15 130V PTFE COATED
C0119	1	CALROD, 120V 1000W 140C C/U SWITCH
C0080	2	CALROD, 120V 400W CERAMIC
C0127*	1	CALROD, 220V 1000W 140C C/U SWITCH (220V England)
C0057*	2	CERAMIC HTR 400W FULL SIZE 220/240V (220V England)
CS0024	1	CORD SET, 12/3 SJTO 8' 30"LEAD
FB31201503	1	DIVIDER PAN, FW15
WB31219900	1	GREASE DEFL.RET.BRKT.WELD FW
LH0021	1	LAMPHOLDER, #62602 HI TEMP
M0093	1	MOTOR BLOWER ASSY 120V
M0091*	1	MOTOR, BLOWER ASSY (220V England)
P0129	1	PAN INSERT 12" FW
P0121	1	PAN INSERT 15" FW
S0356	1	SWITCH, ROCKER 16A 250V

* - These parts are only associated with the 220V England model

FW-15 CUF (Bottom Breather)

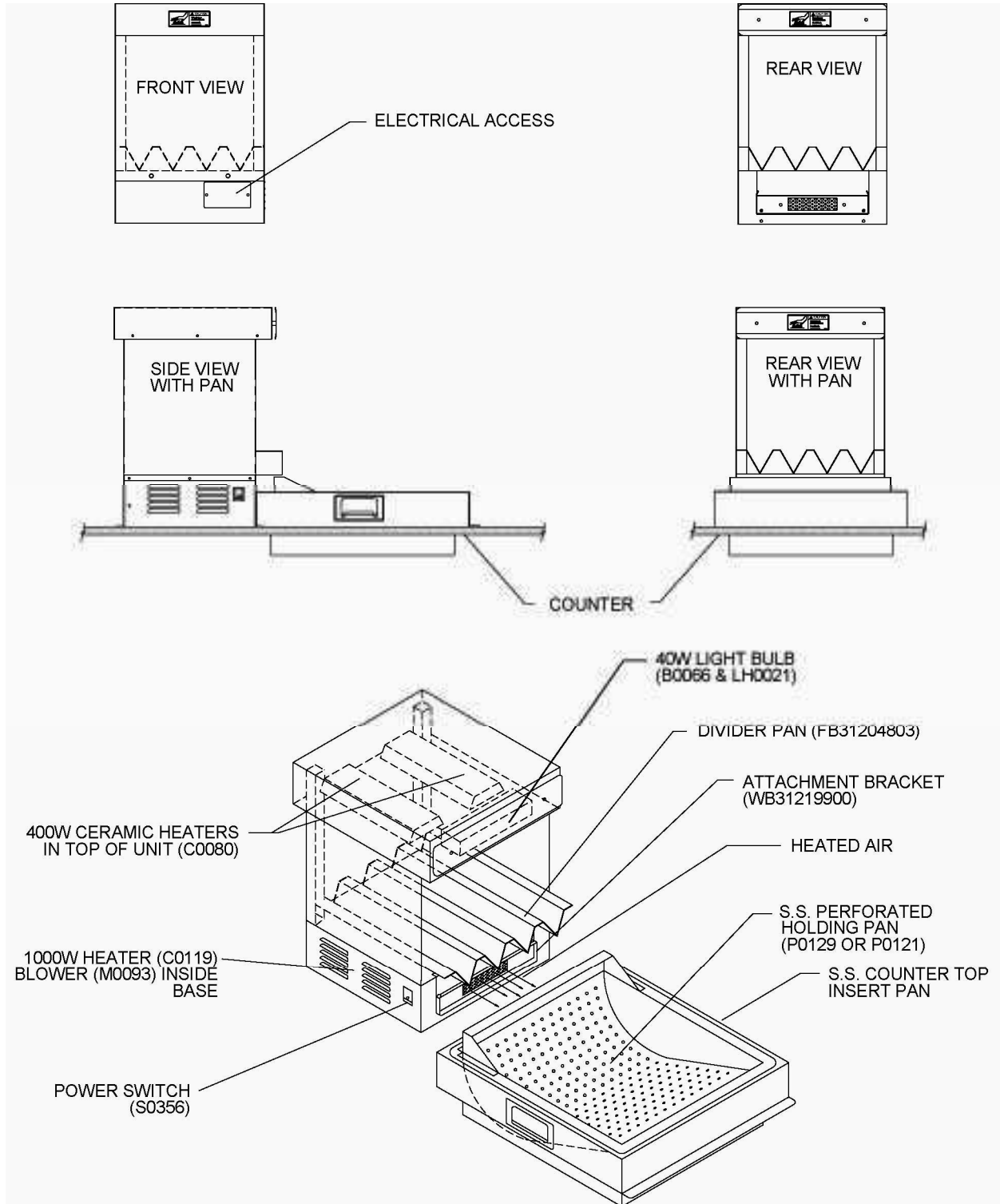

PART #	QTY	DESCRIPTION
B0066	1	BULB, 40A15 130V PTFE COATED
C0119	1	CALROD, 120V 1000W 140C C/U SWITCH
C0080	2	CALROD, 120V 400W CERAMIC
CS0024	1	CORD SET, 12/3 SJTO 8' 30"LEAD
FB31204803	1	DIVIDER PAN FW CUF
WB31219900	1	GREASE DEFL.RET.BRKT.WELD FW
LH0021	1	LAMPHOLDER, #62602 HI TEMP
M0093	1	MOTOR BLOWER ASSY 120V
P0121	1	PAN INSERT 15" FW

FW-15 PASS THRU (Bottom Breather)

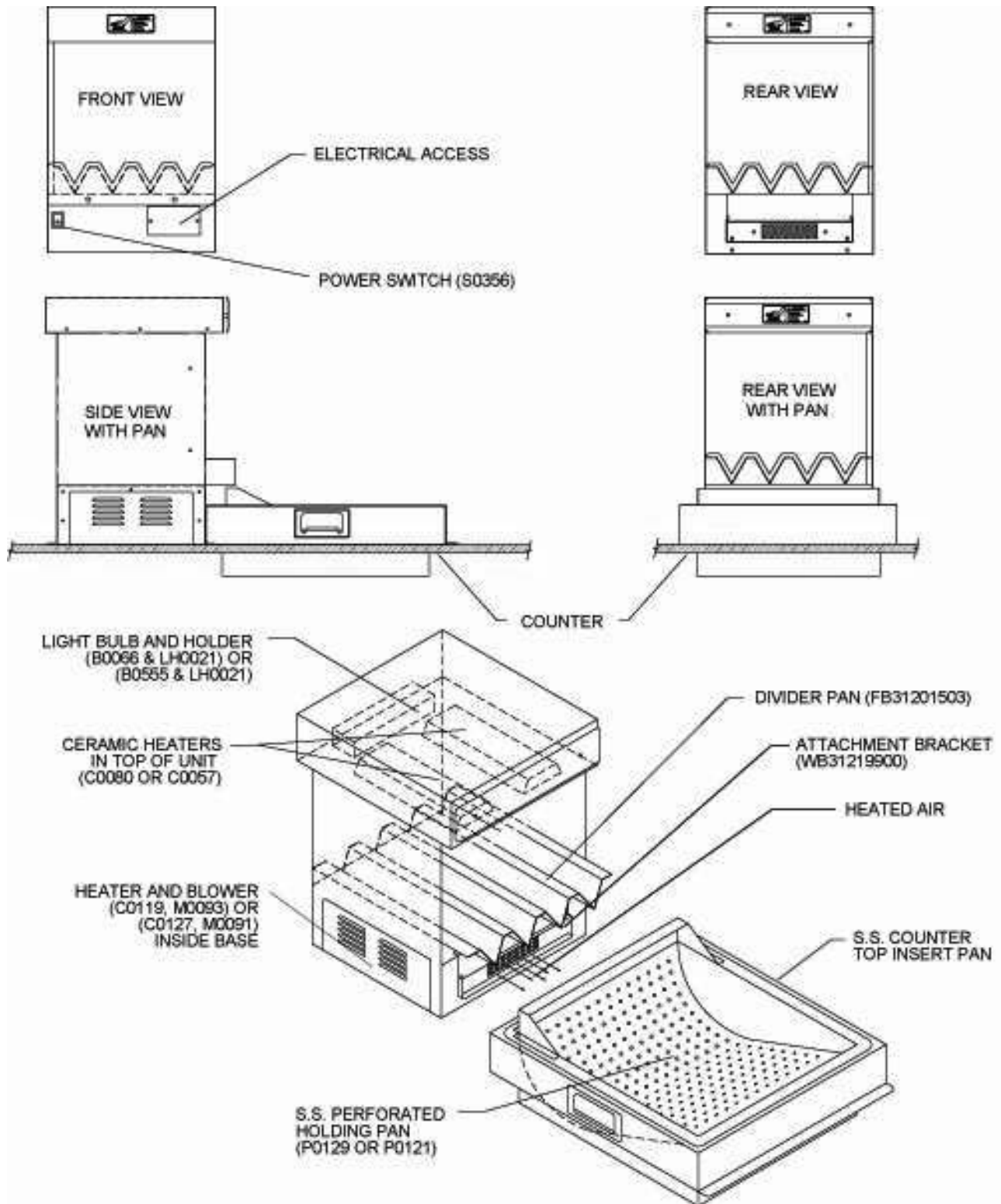

PART #	QTY	DESCRIPTION
B0066	1	BULB, 40A15 130V PTFE COATED
C0119	1	CALROD, 120V 1000W 140C C/U SWITCH
C0080	2	CALROD, 120V 400W CERAMIC
CS0024	1	CORD SET, 12/3 SJTO 8' 30"LEAD
FB31201503	1	DIVIDER PAN, FW15
WB31219900	1	GREASE DEFL.RET.BRKT.WELD FW
LH0021	1	LAMPHOLDER, #62602 HI TEMP
M0093	1	MOTOR BLOWER ASSY 120V
P0121	1	PAN INSERT 15" FW

FW-12T (Side Breather)

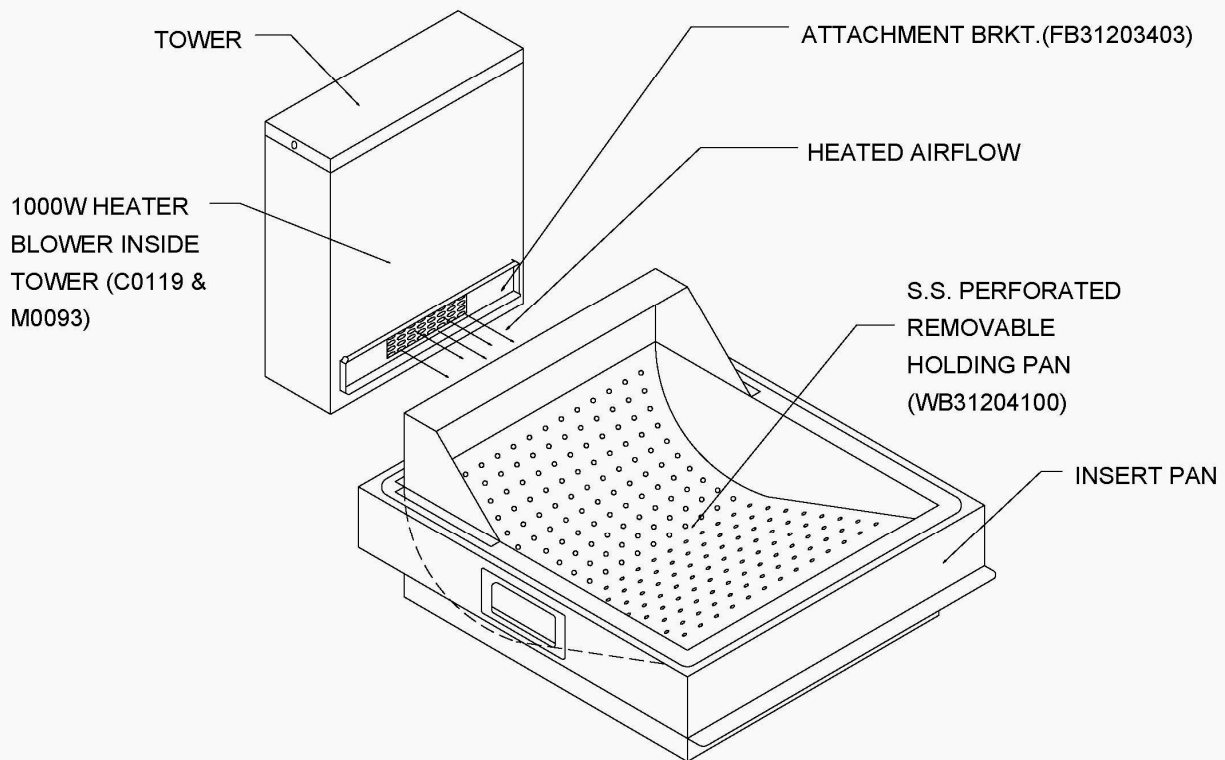
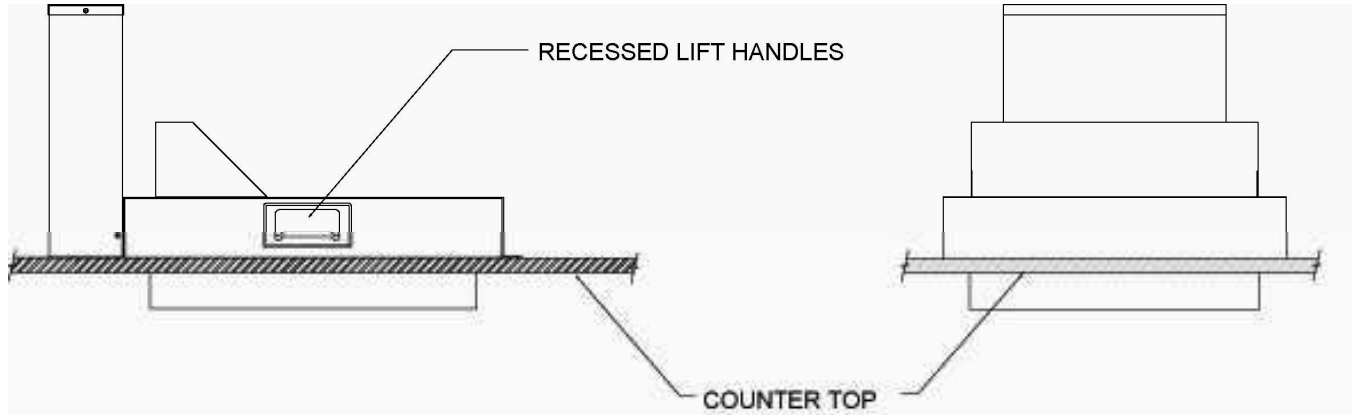

PART #	QTY	DESCRIPTION
WB31204100	1	BLOWER PAN FW-12 WELD
C0119	1	CALROD, 120V 1000W 140C C/U SWITCH
CS0005	1	CORD SET, 115V 7'6"
M0093	1	MOTOR BLOWER ASSY 120V
FB31203403	1	PAN RETAINING BRKT FW

FW-15T (Bottom Breather)

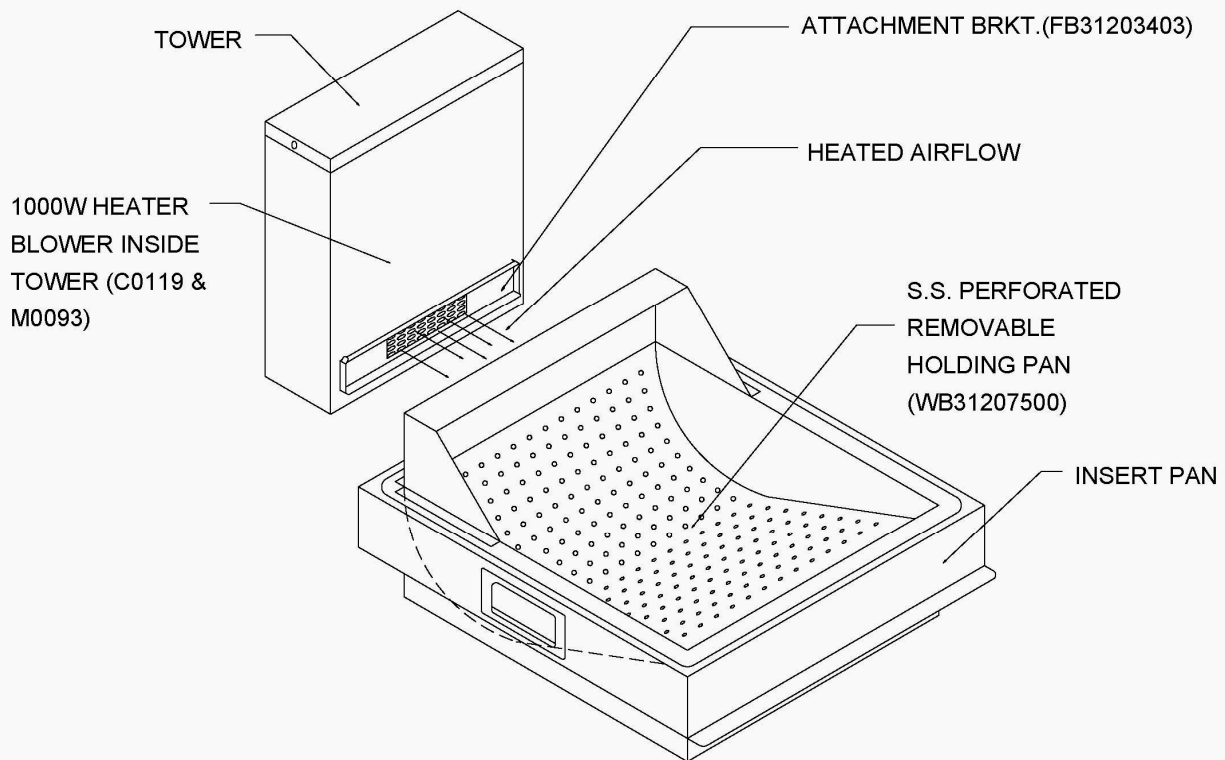
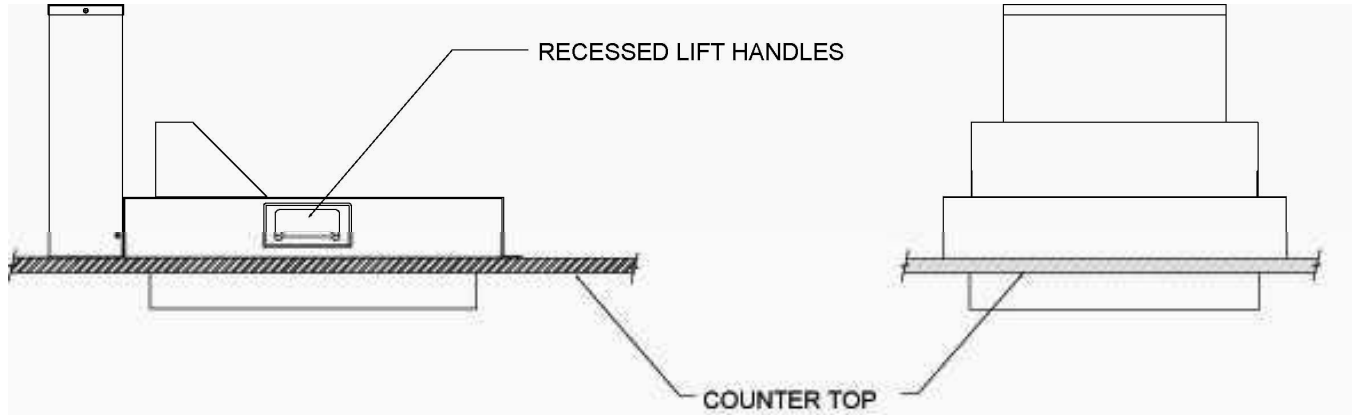

PART #	QTY	DESCRIPTION
C0119	1	CALROD, 120V 1000W 140C C/U SWITCH
CS0005	1	CORD SET, 115V 7'6"
M0093	1	MOTOR BLOWER ASSY 120V
FB31203403	1	PAN RETAINING BRKT FW
WB31207500	1	PER PAN INSERT W/4" SHIELD FW15

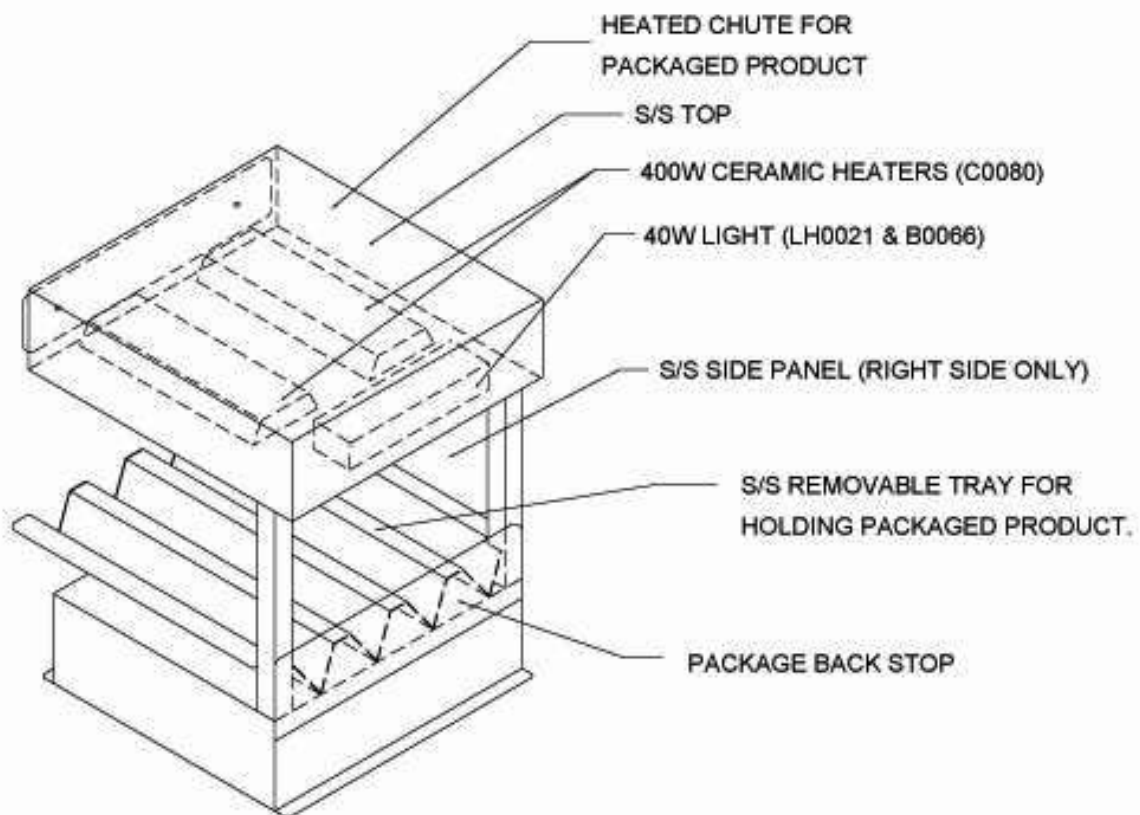
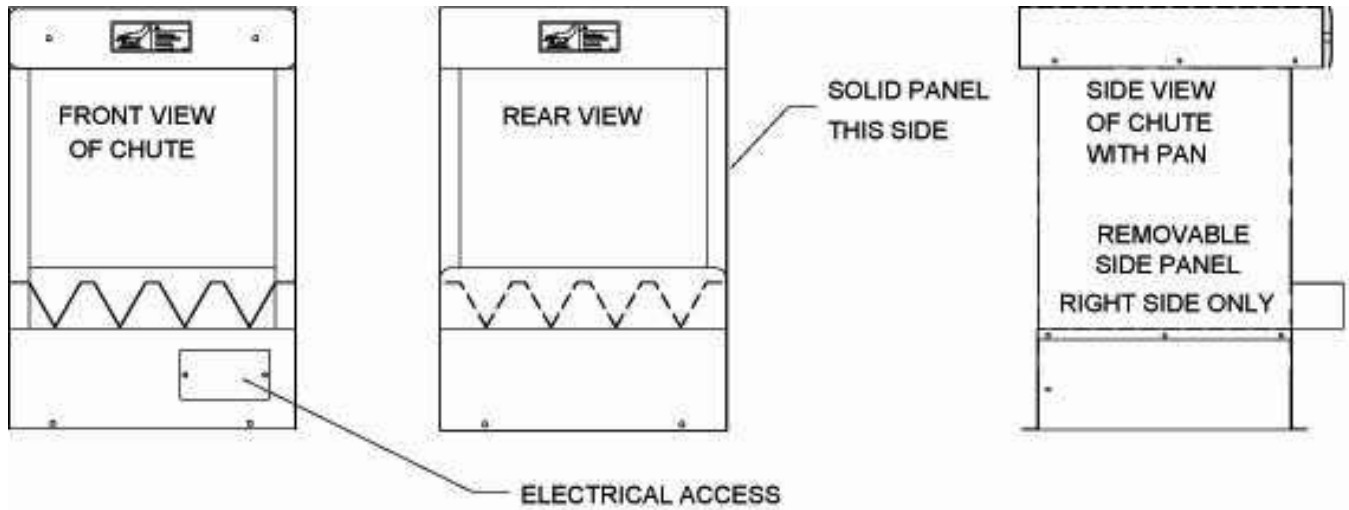

FW-15DTO (Bottom Breather)

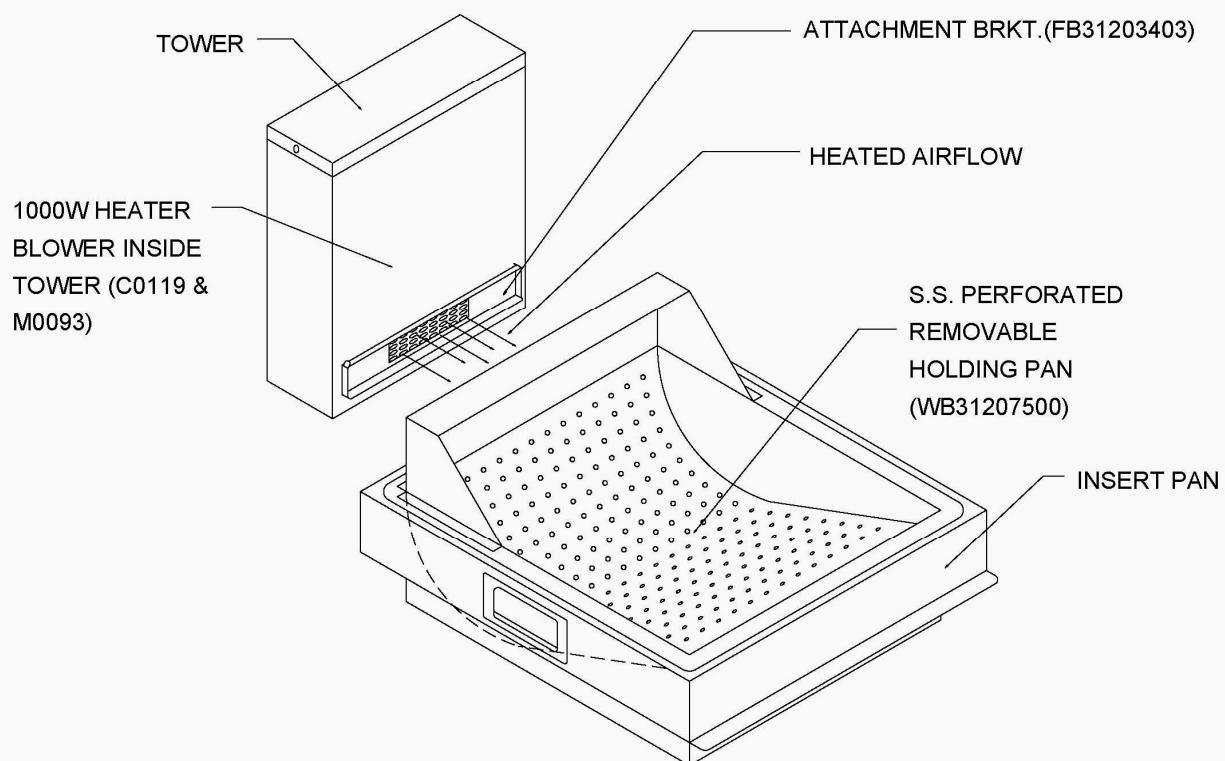
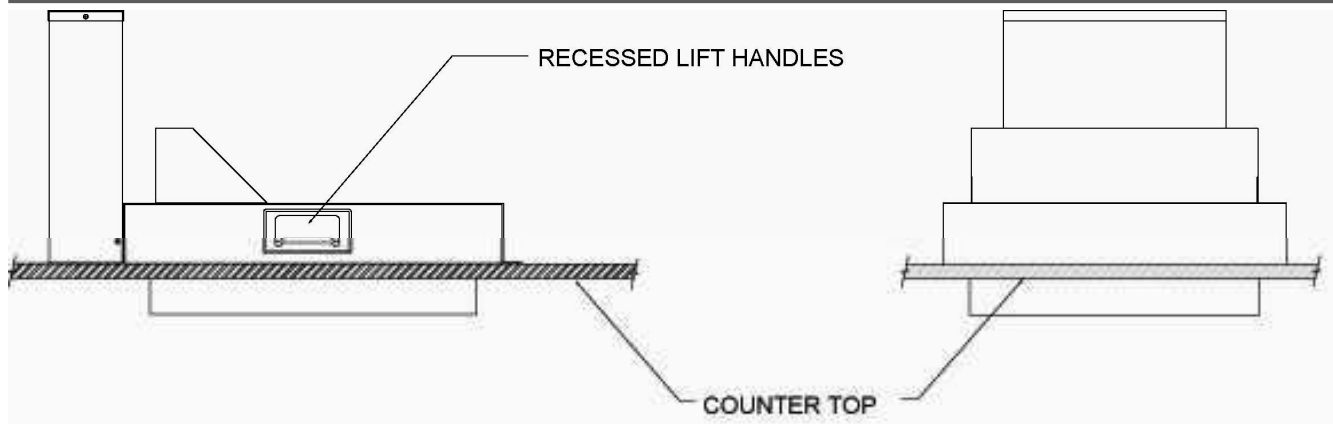

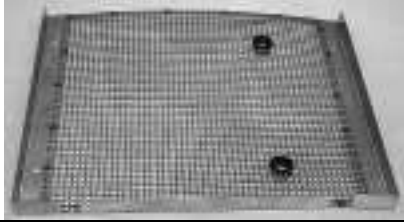

PART #	QTY	DESCRIPTION
B0066	1	BULB, 40A15 130V PTFE COATED
C0119	1	CALROD, 120V 1000W 140C C/U SWITCH
C0080	2	CALROD, 120V 400W CERAMIC
CS0005	2	CORD SET, 115V 7'6"
FB31204803	1	DIVIDER PAN FW CUF
LH0021	1	LAMPHOLDER, #62602 HI TEMP
M0093	1	MOTOR BLOWER ASSY 120V
FB31203403	1	PAN RETAINING BRKT FW
WB31207500	1	PER PAN INSERT W/4" SHIELD FW15

Accessories

PART #	DESCRIPTION	PICTURE
WB31216000	COUNTER TOP COLLAR WELDMENT WITH LINER PAN ATTACHED, BOTTOM BREATHER FW	
WB31211900	COUNTER TOP COLLAR WELDMENT WITHOUT LINER PAN ATTACHED, BOTTOM BREATHER FW	
WB31217700	COUNTER TOP COLLAR WELDMENT FW TOWER W/PAN LINER, BOTTOM BREATHER	
AN3121460S	FW HEATER MOTOR ASSY (BAY MOTOR)	
WN31206400	TABLE TOP ADAPTER FW-12	
WN31206500	TABLE TOP ADAPTER FW-15	

Wiring Diagrams

FW-12/FW-15 (Side Breather)

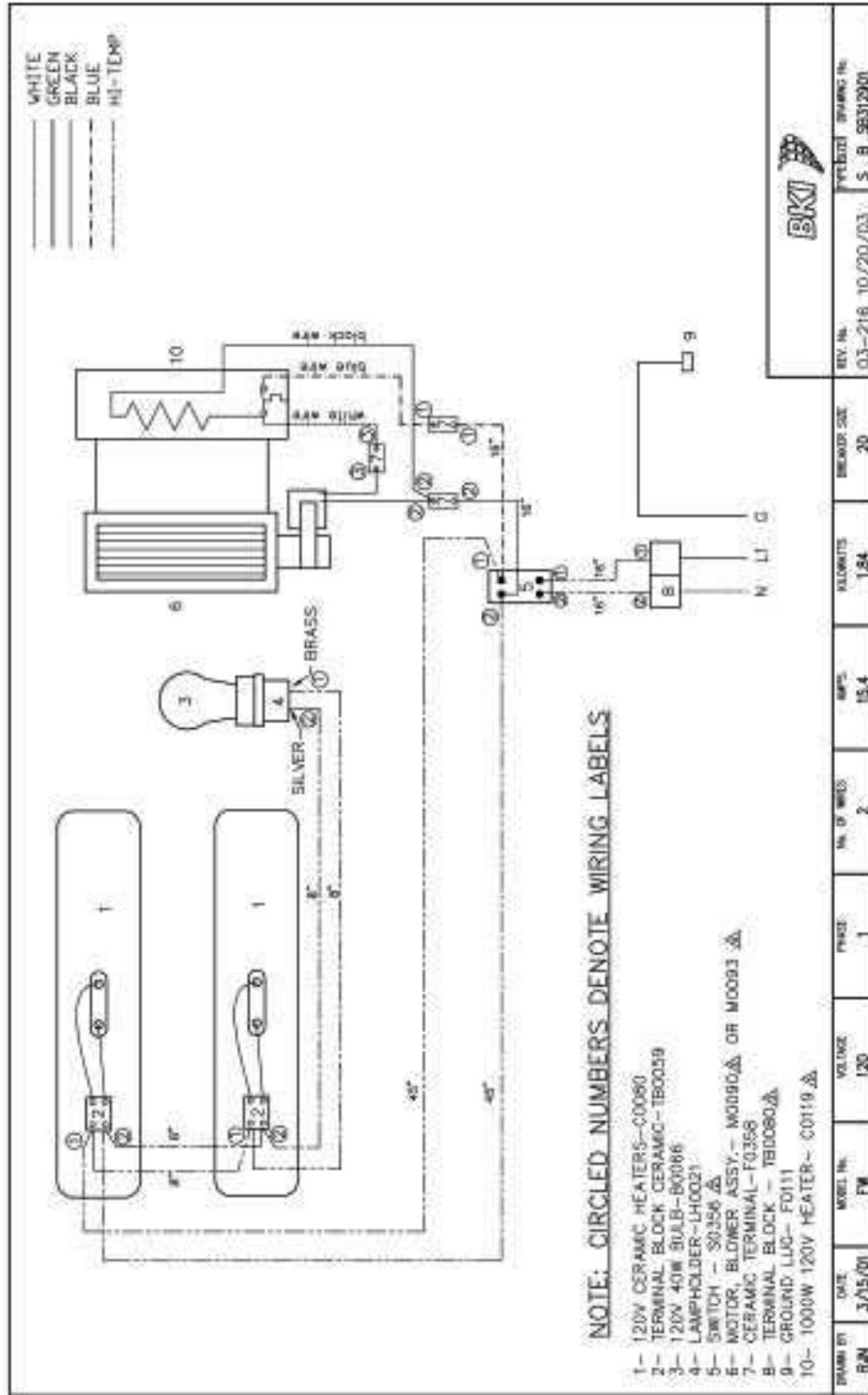

FW-12/FW-15 (Bottom Breather)

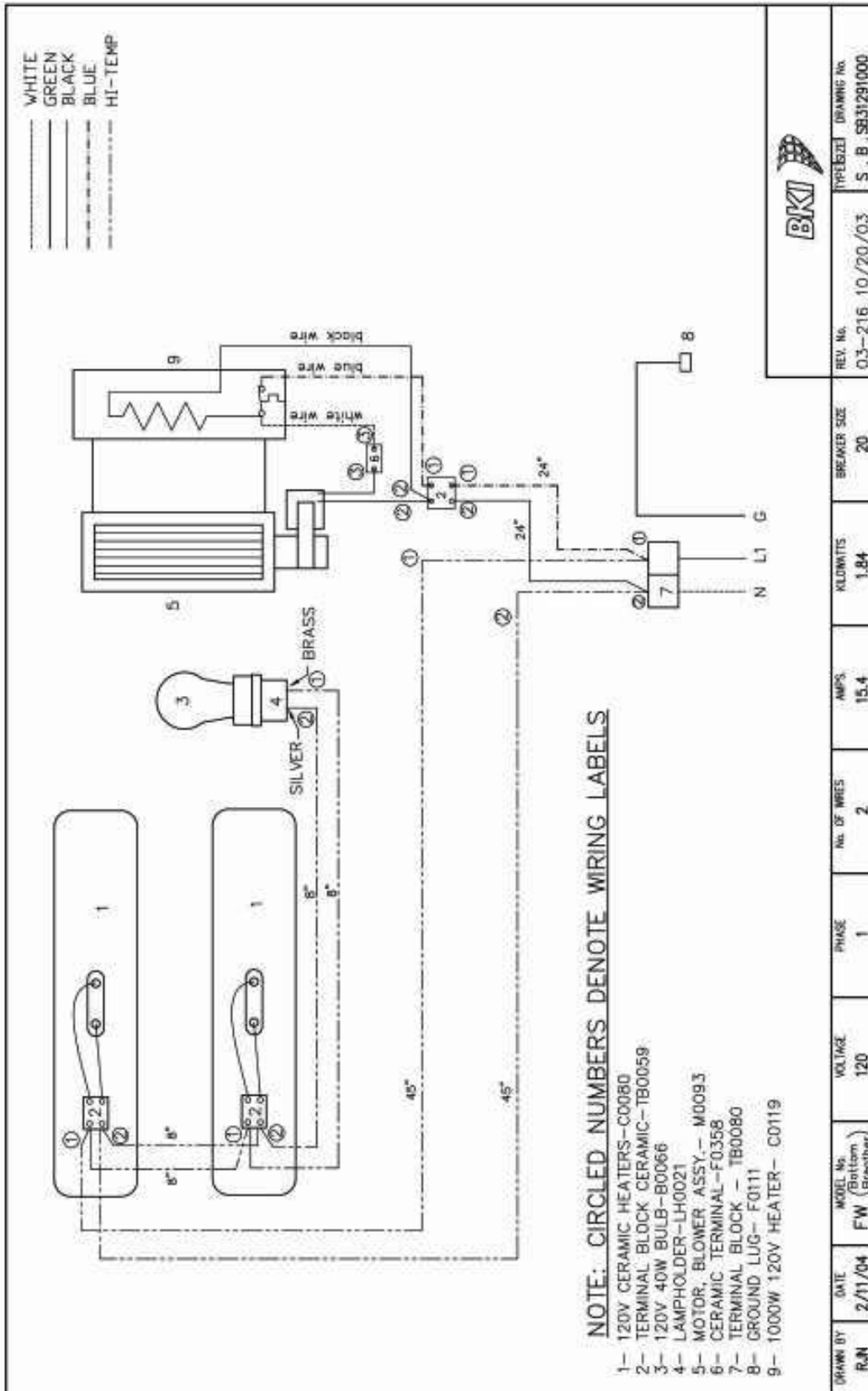

FW-15 (220V England)

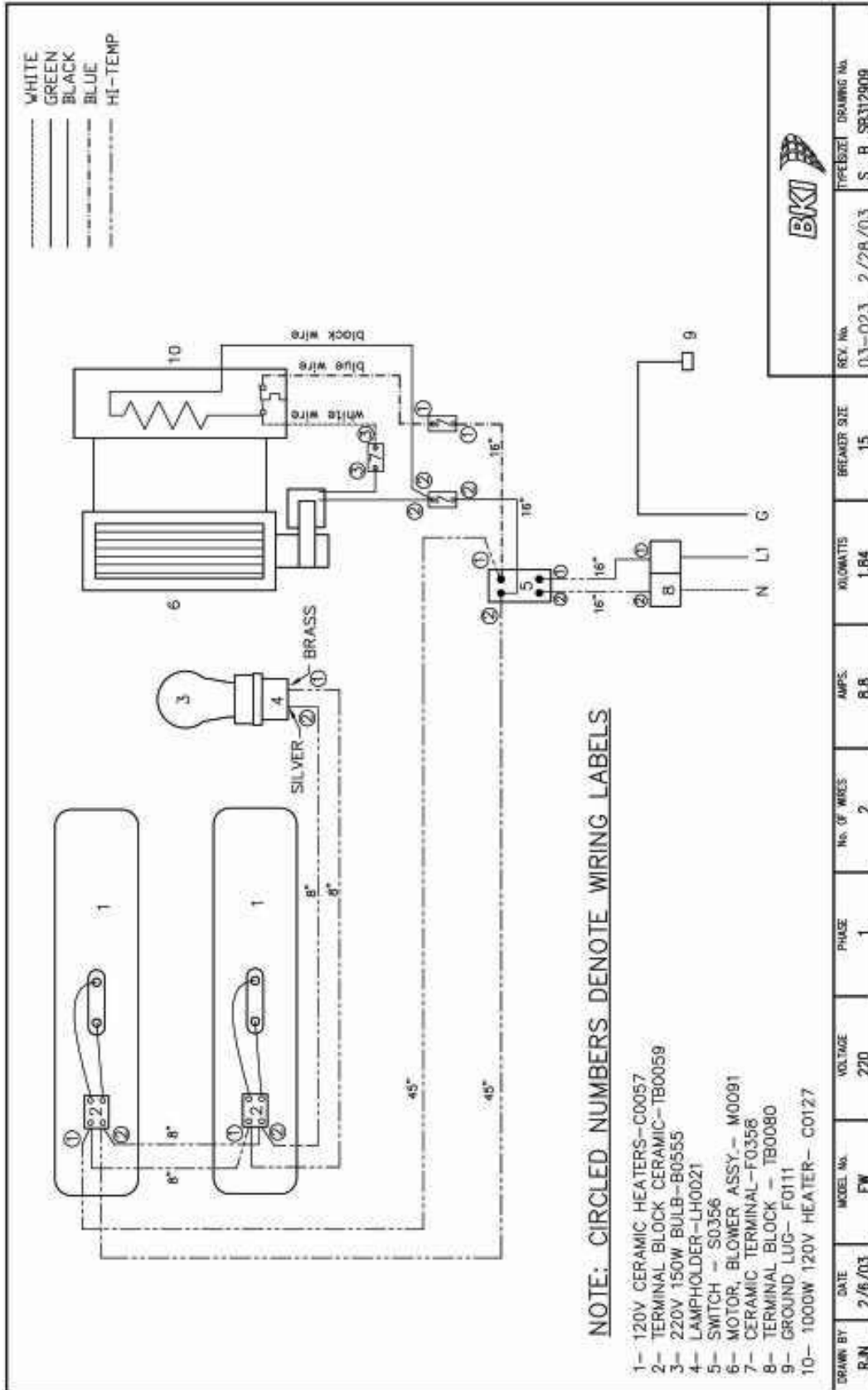

FW-12T/FW-15T

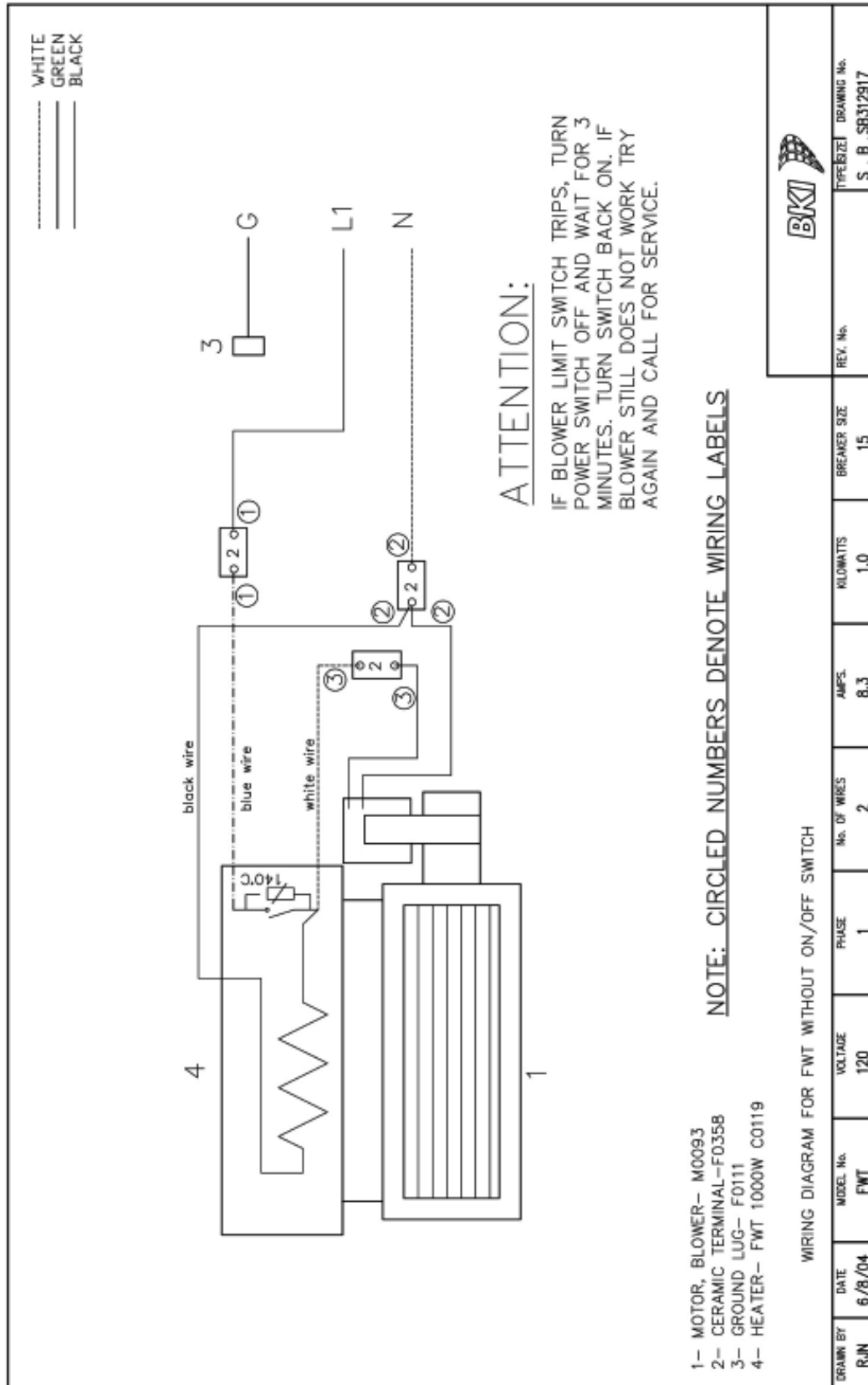

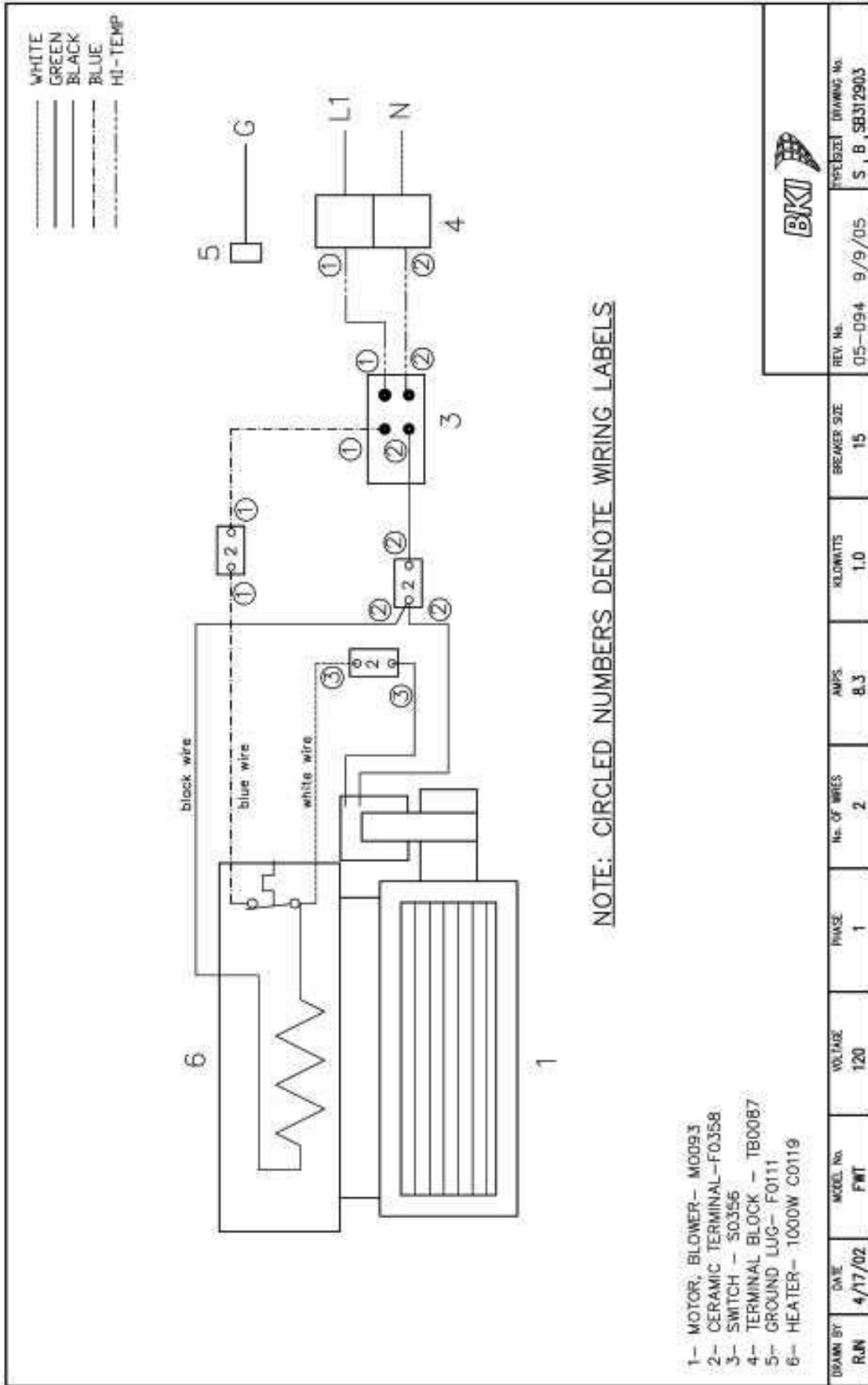

REV. NO.	05-094	9/9/05	TYPE/SIZE	DRAWING NO.
BREAKER SIZE	15			S B SB312903
KILOWATTS	1.0			
AMPS	8.3			
NO. OF WIRES	2			
PHASE	1			
VOLTAGE	120			
MODEL NO.	FWT			
DATE	4/17/02			
DRAWN BY	RUN			

FW-15DTO (Bottom Breather)

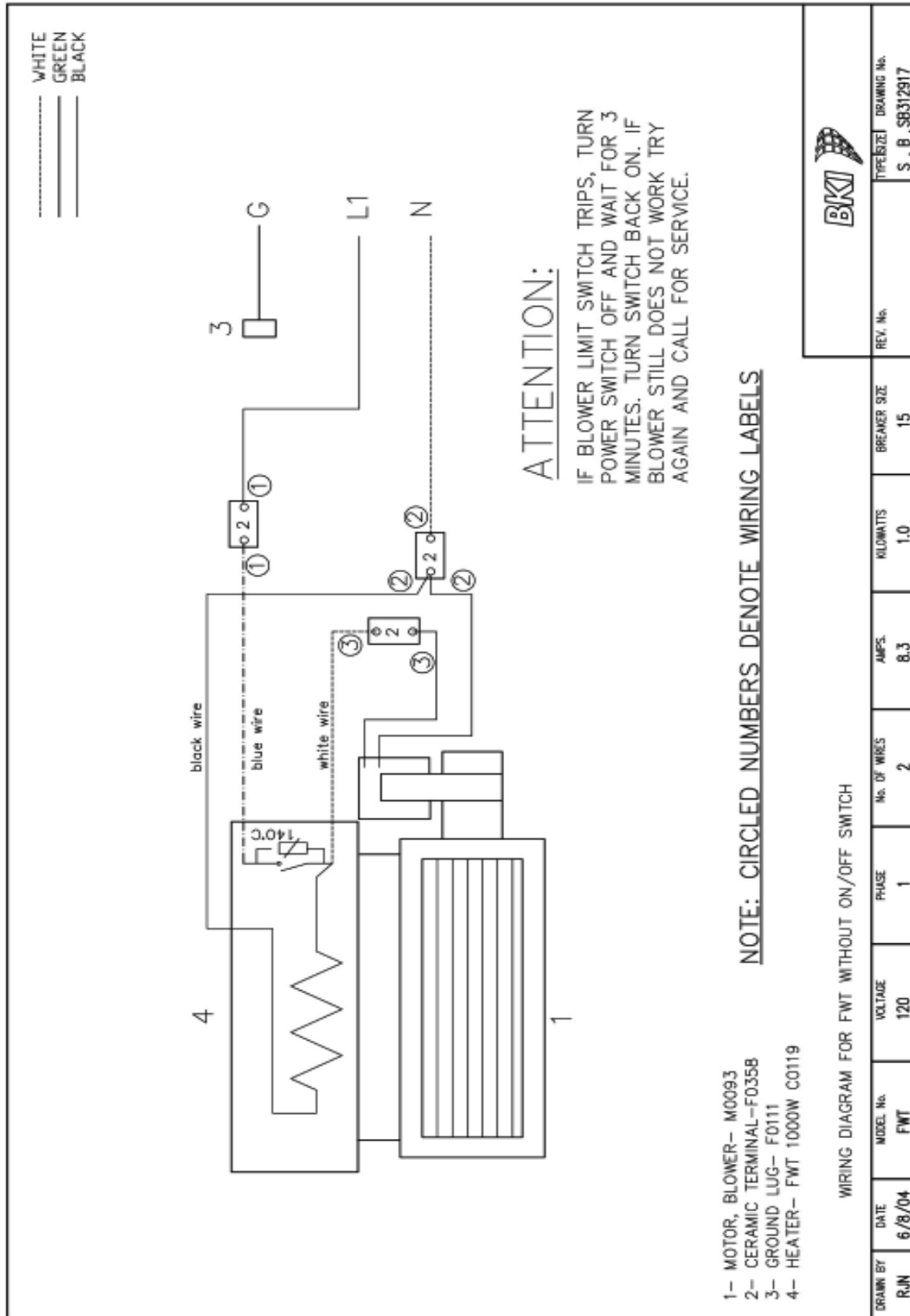

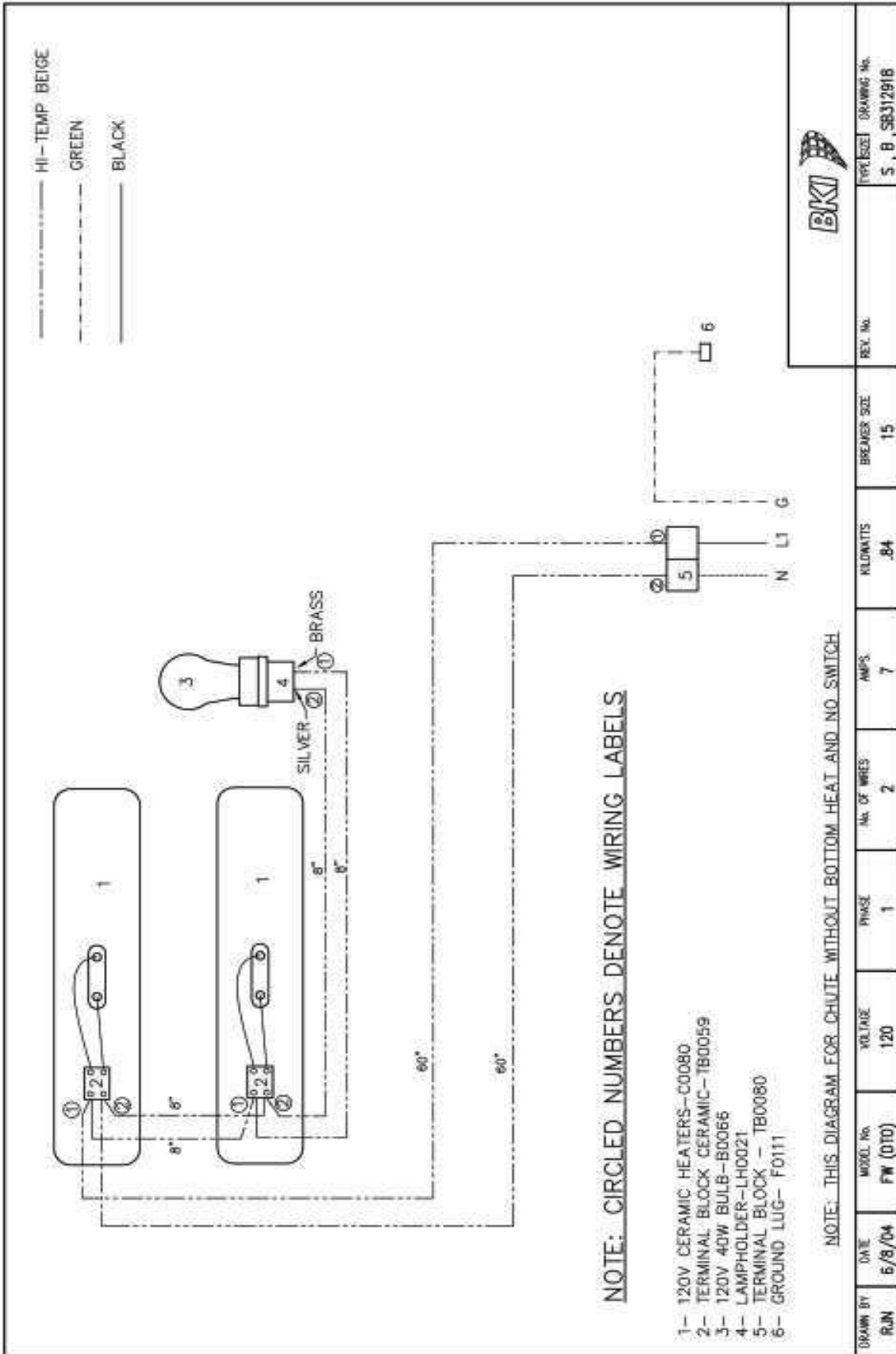

Notes



2812 Grandview Dr., Simpsonville, S.C. 29680, USA
<http://www.bkideas.com>

Made and printed in the U.S.A
LI0224/0407

CS-TM-025.01

Revised 3/26/13

REVISION HISTORY

<u>REVISION</u>	<u>DATE</u>	<u>REVISED BY</u>	<u>DESCRIPTION</u>
01	03/26/13	KW	Initial Release-Supersedes all previous releases