

# Universal Warmer

MODEL UW-17  
Service Manual



*Fresh ideas in foodservice equipment*

## BKI LIMITED WARRANTY

2812 Grandview Dr. • Simpsonville, SC 29680 • USA  
(864) 963-3471 • Toll Free: (800) 927-6887 • Fax: (864) 963-5316

WHAT IS COVERED	<p>This warranty covers defects in material and workmanship under normal use, and applies only to the original purchaser providing that:</p> <ul style="list-style-type: none"><li>☐ The equipment has not been accidentally or intentionally damaged, altered or misused;</li><li>☐ The equipment is properly installed, adjusted, operated and maintained in accordance with national and local codes, and in accordance with the installation and operating instructions provided with this product.</li><li>☐ The serial number rating plate affixed to the equipment has not been defaced or removed.</li></ul>
WHO IS COVERED	<p>This warranty is extended to the original purchaser and applies only to equipment purchased for use in the U.S.A.</p>
COVERAGE PERIOD	<ul style="list-style-type: none"><li>☐ Warranty claims must be received in writing by BKI within one (1) year from date of installation or within one (1) year and three (3) months from data of shipment from the factory, whichever comes first.</li><li>☐ COB Models: One (1) Year limited parts and labor.</li><li>☐ COM Models: Two (2) Year limited parts and labor. COM convection ovens also have a two (2) year door warranty.</li><li>☐ CO1 Models: Two (2) Year limited parts and labor. Five (5) Year limited door warranty.</li><li>☐ BevLes Products: Two (2) Year limited parts and labor.</li><li>☐ Warranty period begins the date of dealer invoice to customer or ninety (90) days after shipment date from BKI, whichever comes first.</li></ul>
WARRANTY COVERAGE	<p>This warranty covers on-site labor, parts and reasonable travel time and travel expenses of the authorized service representative up to (100) miles round trip and (2) hours travel time and performed during regular, weekday business hours.</p>
EXCEPTIONS	<p>Any exceptions must be pre-approved in advance and in writing by BKI. The extended door warranty on convection ovens years 3 through 5 is a parts only warranty and does not include labor, travel, mileage or any other charges.</p>
EXCLUSIONS	<ul style="list-style-type: none"><li>☐ Negligence or acts of God,</li><li>☐ Thermostat calibrations after (30) days from equipment installation date,</li><li>☐ Air and gas adjustments,</li><li>☐ Light bulbs,</li><li>☐ Glass doors and door adjustments,</li><li>☐ Fuses,</li><li>☐ Adjustments to burner flames and cleaning of pilot burners,</li><li>☐ Tightening of screws or fasteners,</li><li>☐ Failures caused by erratic voltages or gas suppliers,</li><li>☐ Unauthorized repair by anyone other than a BKI Factory Authorized Service Center,</li><li>☐ Damage in shipment,</li><li>☐ Alteration, misuse or improper installation,</li><li>☐ Thermostats and safety valves with broken capillary tubes,</li><li>☐ Freight - other than normal UPS charges,</li><li>☐ Ordinary wear and tear,</li><li>☐ Failure to follow installation and/or operating instructions,</li><li>☐ Events beyond control of the company.</li></ul>
INSTALLATION	<p>Leveling, as well as proper installation and check out of all new equipment - per appropriate installation and use materials - is the responsibility of the dealer or installer, not the manufacturer.</p>
REPLACEMENT PARTS	<p>BKI genuine Factory OEM parts receive a (90) day materials warranty effective from the date of installation by a BKI Factory Authorized Service Center.</p>

---

# Table of Contents

<b>Table of Contents</b> .....	<b>1</b>
<b>Introduction</b> .....	<b>2</b>
Safety Precautions.....	2
Safety Signs and Messages.....	2
Safe Work Practices.....	2
Safety Labels .....	4
<b>Installation</b> .....	<b>5</b>
Instructions For Shipping Damage .....	5
Electrical Information And Grounding.....	5
Installation Instructions .....	5
UW-17 .....	5
<b>Operation</b> .....	<b>6</b>
Unit Startup and Preheating .....	6
Operational Guidelines .....	6
Unit Shutdown .....	6
<b>Maintenance</b> .....	<b>7</b>
Scheduled Maintenance .....	7
Cleaning .....	7
Troubleshooting.....	10
<b>Replacement Parts</b> .....	<b>11</b>
Components .....	11
UW-17 .....	11
Accessories .....	12
<b>Wiring Diagrams</b> .....	<b>13</b>
UW-17.....	13
<b>Notes</b> .....	<b>14</b>

## Introduction

Congratulations! You have chosen a **Universal Warmer** that will give you many years of fine service from the original manufacturer, **BKI**.

The **BKI** name and trademark on this unit assures you of the finest in design and engineering — that it has been built with care and dedication — using the best materials available. Attention to the operating instructions regarding proper installation, operation, and maintenance will result in long lasting dependability to insure the highest profitable return on your investment.

### NOTICE

PLEASE READ THIS ENTIRE MANUAL BEFORE OPERATING THE UNIT. If you have any questions, please contact your **BKI** Distributor. If they are unable to answer your questions, contact the **BKI** Technical Service Department, toll free: 1-800-927-6887. Outside the U.S., call 1-864-963-3471.

This unit must be sealed to the counter after it is installed to conform to NSF Standard 4, Item 4.28. (Dow Corning RTV #732 Multi purpose Sealant.)

### Safety Precautions

Always follow recommended safety precautions listed in this manual. Below is the safety alert symbol. When you see this symbol on your equipment, be alert to the potential for personal injury or property damage.



### Safety Signs and Messages

The following Safety signs and messages are placed in this manual to provide instructions and identify specific areas where potential hazards exist and special precautions should be taken. Know and understand the meaning of these instructions, signs, and messages. Damage to the equipment, death or serious injury to you or other persons may result if these messages are not followed.

#### **⚠ DANGER**

This message indicates an imminently hazardous situation that, if not avoided, will result in death or serious injury.

#### **⚠ WARNING**

This message indicates a potentially hazardous situation, which, if not avoided, could result in death or serious injury.

#### **⚠ CAUTION**

This message indicates a potentially hazardous situation, which, if not avoided, may result in minor or moderate injury. It may also be used to alert against unsafe practices.

#### **NOTICE**

This message is used when special information, instructions or identification are required relating to procedures, equipment, tools, capacities and other special data.

### Safe Work Practices

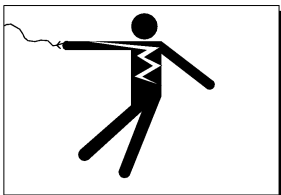

#### **Beware of High Voltage**

This equipment uses high voltage. Serious injury can occur if you or any untrained or unauthorized person installs, services, or repairs this equipment. Always Use an Authorized Service agent to Service Your Equipment.

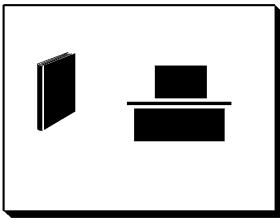

**Keep this manual with the Equipment**

This manual is an important part of your equipment. Always keep it near for easy access. If you need to replace this manual, contact:

**BKI**

Technical Services Department  
 2812 Grandview Drive  
 Simpsonville, S.C. 29680  
 Or call toll free: 1-800-927-6887  
 Outside the U.S., call 864-963-3471



**Protect Children**

Keep children away from this equipment. Children may not understand that this equipment is dangerous for them and others.

NEVER allow children to play near or operate your equipment.

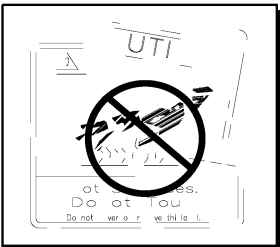

**Keep Safety Labels Clean and in Good Condition**

Do not remove or cover any safety labels on your equipment. Keep all safety labels clean and in good condition. Replace any damaged or missing safety labels. Refer to the Safety Labels section for illustration and location of safety labels on this unit. If you need a new safety label, obtain the number of the specific label illustrated on page 4, then contact:

**BKI**

Technical Services Department  
 2812 Grandview Drive  
 Simpsonville, S.C. 29680  
 Or call toll free: 1-800-927-6887  
 Outside the U.S., call 864-963-3471

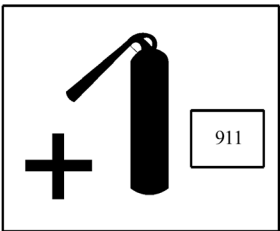

**Be Prepared for Emergencies**

Be prepared for fires, injuries, or other emergencies.

Keep a first aid kit and a fire extinguisher near the equipment. You must use a 40-pound Type BC fire extinguisher and keep it within 25 feet of your equipment.

Keep emergency numbers for doctors, ambulance services, hospitals, and the fire department near your telephone.

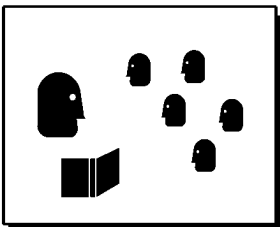

**Know your responsibilities as an Employer**

- Make certain your employees know how to operate the equipment.
- Make certain your employees are aware of the safety precautions on the equipment and in this manual.
- Make certain that you have thoroughly trained your employees about operating the equipment safely.
- Make certain the equipment is in proper working condition. If you make unauthorized modifications to the equipment, you will reduce the function and safety of the equipment.

### Safety Labels

N0158

<p> <b>WARNING</b> CONNECT ONLY TO APPROVED 3 PRONG GROUNDED CIRCUIT. FAILURE TO DO SO COULD RESULT IN SERIOUS INJURY.</p>	<p> <b>WARNING</b> CONNECT ONLY TO APPROVED 3 PRONG GROUNDED CIRCUIT. FAILURE TO DO SO COULD RESULT IN SERIOUS INJURY.</p>
<p><b>DO NOT COVER OR REMOVE THIS LABEL</b></p>	
<p>N0158</p>	

N0202

	<p> <b>DANGER</b></p> <p><b>HIGH VOLTAGE.</b> Turn power off before servicing. May have more than one disconnect switch. <small>Do not cover or remove label. N0202</small></p>
--	--



N0200

	<p> <b>CAUTION</b></p> <p>Hot surface can cause severe burns. Do not touch.</p> <p><small>Do not cover or remove label. N-0200</small></p>
--	---

## Installation



⚠ **WARNING** Serious injury, equipment damage or death could result if attempting to install this unit yourself. Ensure that an authorized BKI service agent install the oven.

### ***Instructions For Shipping Damage***

You are responsible for filing all freight claims with the delivering truck line. Inspect all cartons and crates for damage when they arrive. If there is damage noted to shipping crates or cartons, or, if a shortage is found, note this on the bill of lading (all copies) before signing.

If damage is detected when the equipment is uncrated, immediately call the delivering truck line and follow up the call with a written report indicating concealed damage to your equipment. Ask for an immediate inspection of your concealed damage item. Crating material **MUST** be retained to show the inspector from the truck line.

### ***Electrical Information And Grounding***



⚠ **WARNING** Electrocutation, equipment failure or property damage could result if an unlicensed electrician performs the electrical installation. Ensure that a licensed electrician perform the electrical installation in accordance with local codes, or in the absence of local codes, with the National Electrical Code, ANSI NFPA 70-20XX.

UW-17's are wired for use in accordance with all applicable local, state, and federal codes. For specific electrical requirements and connections refer to the wiring diagram attached to the unit.

### ***Installation Instructions***

#### **UW-17**

1. Obtain a suitable countertop location for the unit that will provide a clearance of 4" from the rear louvers.
2. Plug unit into 20 amp, 120 volt receptacle.

## Operation

### ***Unit Startup and Preheating***

1. Turn on power to the unit.
2. Allow the equipment to preheat for ten (10) minutes before loading it with product.

### ***Operational Guidelines***

- Foods should be a minimum of 195° F. before being placed in the warmer.
- Foods loaded in first should be served first as much as is practical.
- Check Federal and State Health and Sanitation Regulations for internal temperature required for holding cooked foods for sale. Maintaining these temperatures often tends to continue to cook certain products. Therefore, smaller amounts of bulk foods should be displayed at non-peak periods and the warmer refilled as needed.

**NOTICE**

This equipment is designed to hold foods for a short period of time only.

### ***Unit Shutdown***

1. Remove all food from the equipment.
2. Turn off power to the unit.
3. Allow the equipment to cool to room temperature.
4. Remove any residue and clean the equipment thoroughly.



---

## Maintenance

**⚠ CAUTION**

Failure to comply with the maintenance below could result in a serious accident.

**⚠ WARNING**

Electrocution, equipment failure or property damage could result if an unlicensed electrician performs electrical repair. Ensure that a licensed electrician perform electrical repair.

### *Scheduled Maintenance*

#### **Cleaning**

This unit should be cleaned at the end of each working day. Use the following procedure:

**⚠ DANGER**

Failure to remove power from this unit may cause severe electrical shock. This unit may have more than one disconnect switch.

**⚠ CAUTION**

Never use abrasive cleaners that may damage the finish.

Never steam clean the interior.

Avoid getting excess water in the interior of the unit.

Do not clean the heater/blower assembly by applying compressed air.

Do not leave this unit on and unattended after business hours.

1. Turn the unit off and allow it to cool down to room temperature.
2. Remove any food.
3. Remove the Pan Divider by lifting it out of the pan vertically.



4. Remove the Pan by picking up on the front then lifting entire pan vertically.



5. Use a nylon brush(a) to thoroughly clean grease and debris from holes in pan. Be sure to clean top and bottom of pan, pan divider, staging rack, and flat surface insert with hot soapy water. Rinse well and dry(b).



a.



b.

6. Slide Crumb Drawer out and remove from machine. Use a nylon brush to clean Crumb Tray. Rinse and dry.



7. When cleaning, use a small nylon brush to remove debris from Blower Grid.



8. After brushing grid, use a clean cloth to wipe the debris and oil from grid and machine.



**⚠ WARNING**

Do not spray any cleaning chemicals or any other liquid into blower grid. This could cause a risk of shock or prevent the machine from working properly.

9. Clean surface underneath crumb tray with a hot rag to remove any shortening/debris that may have spilled onto bottom well. After unit and components have been cleaned, reinstall crumb tray, pan, pan divider, staging rack, and flat surface insert.



### Troubleshooting

Refer to the table below for troubleshooting information.

<b>Problem</b>	<b>Cause</b>	<b>Possible Solution</b>
<b>Noisy fan</b>	Fan blade is dirty or fan bearings are failing	Contact an authorized BKI service agent for corrective action.
<b>Perforated pan is not heating</b>	No power to unit.	Make sure that the circuit breaker and switch at the power supply are supplying power to the unit. If problem persists, contact licensed electrician.
	Fan has overheated and cut off	Wipe the dust from the air intake louvers to allow proper airflow and prevent fan overheating. Turn the power switch off. Wait 60 seconds. Turn the power switch back on.
	Heating coil has failed	Contact an authorized BKI service agent for corrective action.

## Replacement Parts

Use the information in this section to identify replacement parts. To order replacement parts, call your local BKI sales and service representative. Before calling, please note the serial number on the rating tag affixed to the unit.

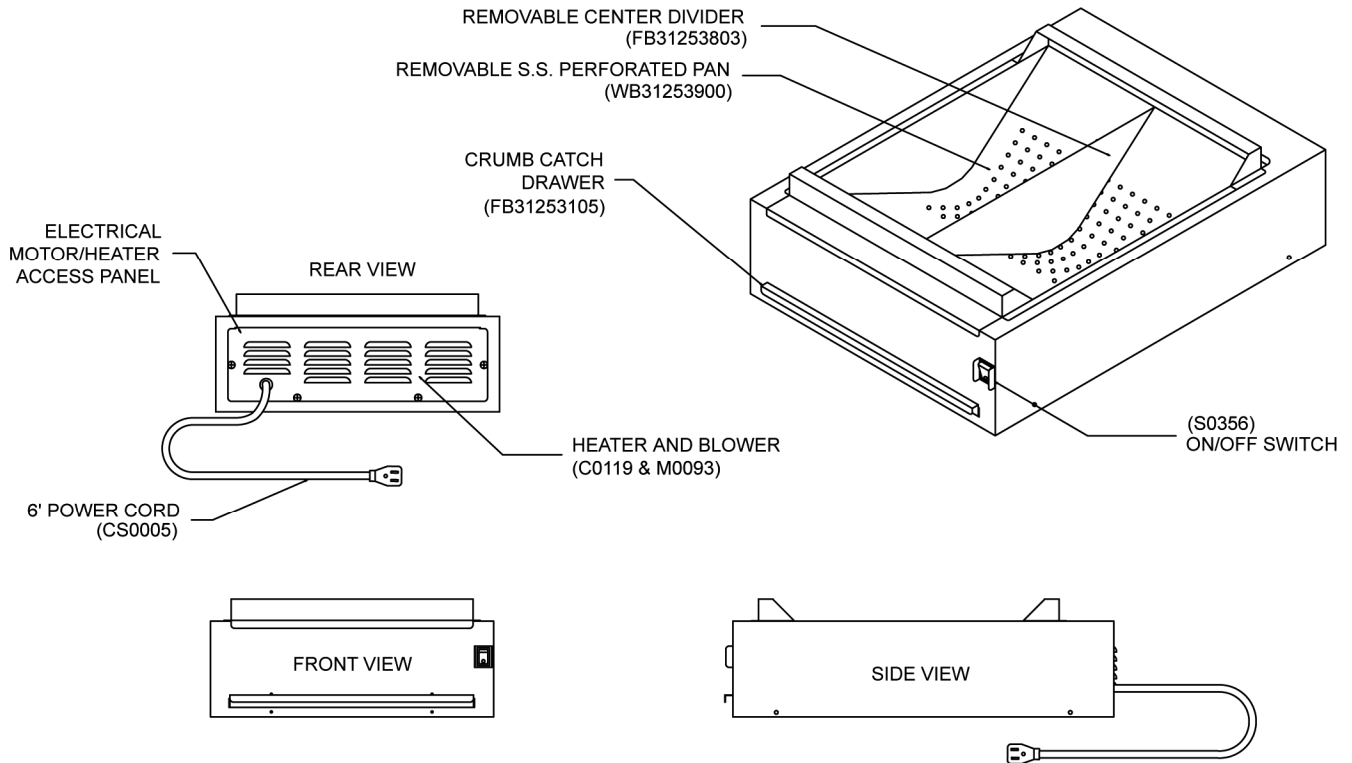

### Components

#### UW-17



PART #	QTY	DESCRIPTION
C0119	1	CALROD, 120V 1000W 140C C/U SWITCH
CS0005	1	CORD SET, 12/3 SJTO 8' 30"LEAD
M0093	1	MOTOR BLOWER ASSY 120V
S0356	1	SWITCH, ROCKER 16A 250V
WB31253900	1	PERFORATED PAN INSERT
FB31253105	1	CRUMB CATCH
FB31253803	1	PAN DIVIDER

**Accessories**

PART #	DESCRIPTION	PICTURE
WB31253900	PERFORATED PAN INSERT	
FB31253105	CRUMB CATCH	
FB31253803	PAN DIVIDER	

# Wiring Diagrams

## UW-17

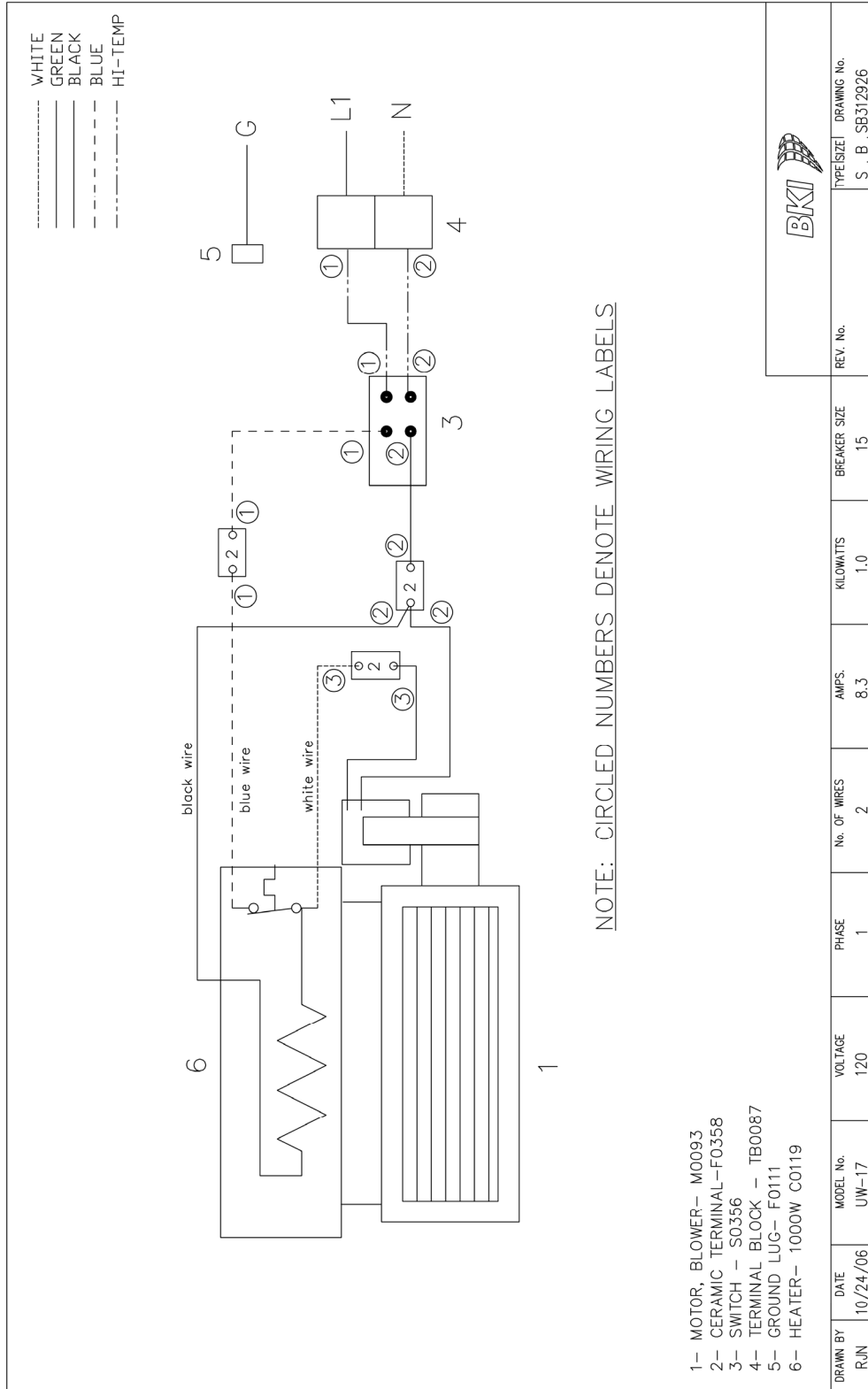

## **Notes**





2812 Grandview Dr., Simpsonville, S.C. 29680, USA  
<http://www.bkideas.com>

Made and printed in the U.S.A  
LI9998/012007

CS-TM-038.01

Revised 04/16/13

---

**REVISION HISTORY**

<b><u>REVISION</u></b>	<b><u>DATE</u></b>	<b><u>REVISED BY</u></b>	<b><u>DESCRIPTION</u></b>
01	04/16/13	KW	Initial Release-Supersedes all previous releases