



Half-Size Cook & Hold Oven Series

Series: GO

Operation Manual

Revised 2/22/2018
SS-OM-057.01



BKI LIMITED WARRANTY

2812 Grandview Dr. • Simpsonville, SC 29680 • USA
(864) 963-3471 • Toll Free: (800) 927-6887 • Fax: (864) 963-5316

WHAT IS COVERED	<p>This warranty covers defects in material and workmanship under normal use, and applies only to the original purchaser providing that:</p> <ul style="list-style-type: none"><input type="checkbox"/> The equipment has not been accidentally or intentionally damaged, altered or misused;<input type="checkbox"/> The equipment is properly installed, adjusted, operated and maintained in accordance with national and local codes, and in accordance with the installation and operating instructions provided with this product.<input type="checkbox"/> The serial number rating plate affixed to the equipment has not been defaced or removed.
WHO IS COVERED	<p>This warranty is extended to the original purchaser and applies only to equipment purchased for use in the U.S.A.</p>
COVERAGE PERIOD	<ul style="list-style-type: none"><input type="checkbox"/> Warranty claims must be received in writing by BKI within one (1) year from date of installation or within one (1) year and three (3) months from date of shipment from the factory, whichever comes first.<input type="checkbox"/> COB Models: One (1) Year limited parts and labor.<input type="checkbox"/> COM Models: Two (2) Year limited parts and labor. COM convection ovens also have a two (2) year door warranty.<input type="checkbox"/> CO1 Models: Two (2) Year limited parts and labor. Five (5) Year limited door warranty.<input type="checkbox"/> Warranty period begins the date of dealer invoice to customer or ninety (90) days after shipment date from BKI, whichever comes first.
WARRANTY COVERAGE	<p>This warranty covers on-site labor, parts and reasonable travel time and travel expenses of the authorized service representative up to (100) miles round trip and (2) hours travel time and performed during regular, weekday business hours.</p>
EXCEPTIONS	<p>Any exceptions must be pre-approved in advance and in writing by BKI. The extended door warranty on convection ovens years 3 through 5 is a parts only warranty and does not include labor, travel, mileage or any other charges.</p>
EXCLUSIONS	<ul style="list-style-type: none"><input type="checkbox"/> Negligence or acts of God,<input type="checkbox"/> Thermostat calibrations after (30) days from equipment installation date,<input type="checkbox"/> Air and gas adjustments,<input type="checkbox"/> Light bulbs,<input type="checkbox"/> Glass doors and door adjustments,<input type="checkbox"/> Fuses,<input type="checkbox"/> Adjustments to burner flames and cleaning of pilot burners,<input type="checkbox"/> Tightening of screws or fasteners,<input type="checkbox"/> Failures caused by erratic voltages or gas suppliers,<input type="checkbox"/> Unauthorized repair by anyone other than a BKI Factory Authorized Service Center,<input type="checkbox"/> Damage in shipment,<input type="checkbox"/> Alteration, misuse or improper installation,<input type="checkbox"/> Thermostats and safety valves with broken capillary tubes,<input type="checkbox"/> Freight - other than normal UPS charges,<input type="checkbox"/> Ordinary wear and tear,<input type="checkbox"/> Failure to follow installation and/or operating instructions,<input type="checkbox"/> Events beyond control of the company.
INSTALLATION	<p>Leveling, as well as proper installation and check out of all new equipment - per appropriate installation and use materials - is the responsibility of the dealer or installer, not the manufacturer.</p>
REPLACEMENT PARTS	<p>BKI genuine Factory OEM parts receive a (90) day materials warranty effective from the date of installation by a BKI Factory Authorized Service Center.</p>

Table of Contents

Table of Contents	1
Introduction	2
Safety Precautions.....	2
Safety Signs and Messages.....	2
Safe Work Practices.....	3
Safety Decals.....	4
Health and Sanitation Practices.....	4
Food Handling.....	5
Storage of Raw Meats.....	5
Coding Cooked Foods.....	5
Storage of Prepared Foods.....	5
Operation	6
Controls and Indicators.....	6
Hardware Controls.....	6
CP0066 Analog Controller.....	7
Configuring the CP0066 Controller.....	Error! Bookmark not defined.
CP0066 Recipe Editing.....	7
Cooking with the CP0066 Controller.....	7
CP0065 Color Touch Screen Controller.....	9
Configuring the CP0065 Controller.....	9
Changing Access Code.....	11
Importing Recipe & Configuration Files.....	11
Exporting Recipe, Configuration and History Files.....	11
Exporting Recipe, Configuration and History Files (continued).....	12
Setting the Clock.....	12
Viewing the Error and Event History File.....	12
Cooking with the CP0065 Controller.....	13
Optional Wood Smoker.....	15
Installation	16
Unpacking and Handling.....	16
GO-36 Stacking Instructions.....	16
Location and Clearance.....	17
Extraction.....	17
Wiring.....	17
General Guidelines.....	17
Maintenance	19
Scheduled Maintenance.....	19
Oven Cleaning (Daily).....	19
Troubleshooting.....	22
CP0065 Controller Warnings.....	22
Wiring Diagram	23
GO-36 & GO-36S.....	23
GO-36C & GO-36CS.....	24
Notes	25

BKI Worldwide, Inc. is a wholly owned subsidiary of Standex International Corporation.

Introduction

Thank you for your purchase of a BKI® GO-36 series cook and hold oven. It consists of a cooking cabinet, door assembly and control unit. The cooking cabinet contains rack supports that hold 4 racks and 1 drip pan. To seal the oven cavity, a door with a magnetized door latch is provided. The control unit contains heating elements for cooking as well as a time/temperature computer and manual switches for quick setup and operation. It also contains a fan for cooling and a blower for heat circulation.

The BKI name assures you of the finest in design and engineering -- that it has been built with care and dedication -- using the best materials available. Attention to the operating instructions regarding proper installation, operation, and maintenance will result in long lasting dependability to insure the highest profitable return on your investment.

NOTICE

PLEASE READ THIS ENTIRE MANUAL BEFORE OPERATING THE UNIT. If you have any questions, please contact your BKI Distributor. If they are unable to answer your questions, phone the applicable BKI Technical Services Department:

BKI North America: (864) 963-3471

Safety Precautions

Always follow recommended safety precautions listed in this manual. Below is the safety alert symbol. When you see this symbol on your equipment, be alert to the potential for personal injury or property damage.

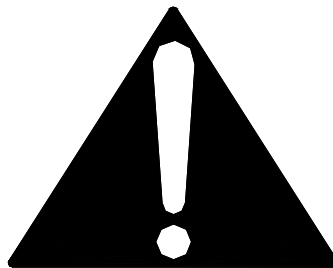

Safety Signs and Messages

The following Safety signs and messages are placed in this manual to provide instructions and identify specific areas where potential hazards exist and special precautions should be taken. Know and understand the meaning of these instructions, signs, and messages. Damage to the equipment, death or serious injury to you or other persons may result if these messages are not followed.

⚠ DANGER

This message indicates an imminently hazardous situation, which, if not avoided, will result in death or serious injury.

⚠ WARNING

This message indicates a potentially hazardous situation, which, if not avoided, could result in death or serious injury.

⚠ CAUTION

This message indicates a potentially hazardous situation, which, if not avoided, may result in minor or moderate injury. It may also be used to alert against unsafe practices.

NOTICE

This message is used when special information, instructions or identification are required relating to procedures, equipment, tools, capacities and other special data.

Safe Work Practices

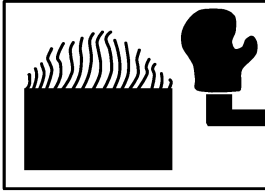

Wear Safe Clothing Appropriate To Your Job

Always wear your insulated mitts when handling hot racks or touch any hot metal surface. If you lose or damage your mitts, you can buy new ones at your local restaurant equipment supply store or from your local BKI Distributor.

Never wear loose clothing such as neckties or scarves while operating this equipment. Keep loose hair tied back or in a hair net while operating this equipment.

Always wear appropriate personal protection equipment during the cleaning process to guard against possible injury from hot cleaning solution.

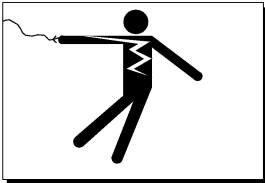

Beware of High Voltage

This equipment uses high voltage. Serious injury can occur if you or any untrained or unauthorized person installs, services, or repairs this equipment. Always use an Authorized Service agent to service your equipment.

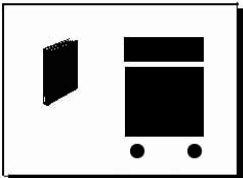

Keep this manual with the Equipment

This manual is an important part of your equipment. Always keep it near for easy access.

If you need to replace this manual, contact:

BKI North America: (864) 963-3471



Protect Children

Keep children away from this equipment. Children may not understand that this equipment is dangerous for them and others.

NEVER allow children to play near or operate your equipment.

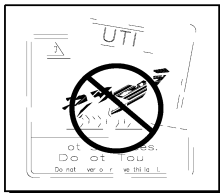

Keep Safety Labels Clean and in Good Condition

Do not remove or cover any safety labels on your equipment. Keep all safety labels clean and in good condition. Replace any damaged or missing safety labels. Refer to the Safety Labels section for illustration and location of safety labels on this unit.

If you need a new safety label, obtain the number of the specific label illustrated on page 4, then contact:

BKI North America: (864) 963-3471

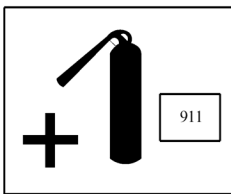

Be Prepared for Emergencies

Be prepared for fires, injuries, or other emergencies.

Keep a first aid kit and a fire extinguisher near the equipment. You must use a 40-pound Type BC fire extinguisher and keep it within 25 feet of your equipment.

Keep emergency numbers for doctors, ambulance services, hospitals, and the fire department near your telephone.

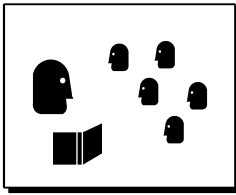

Know your responsibilities as an Employer

- Make certain your employees know how to operate the equipment.
- Make certain your employees are aware of the safety precautions on the equipment and in this manual.
- Make certain that you have thoroughly trained your employees about operating the equipment safely.
- Make certain the equipment is in proper working condition. If you make unauthorized modifications to the equipment, you will reduce the function and safety of the equipment.

Safety Decals

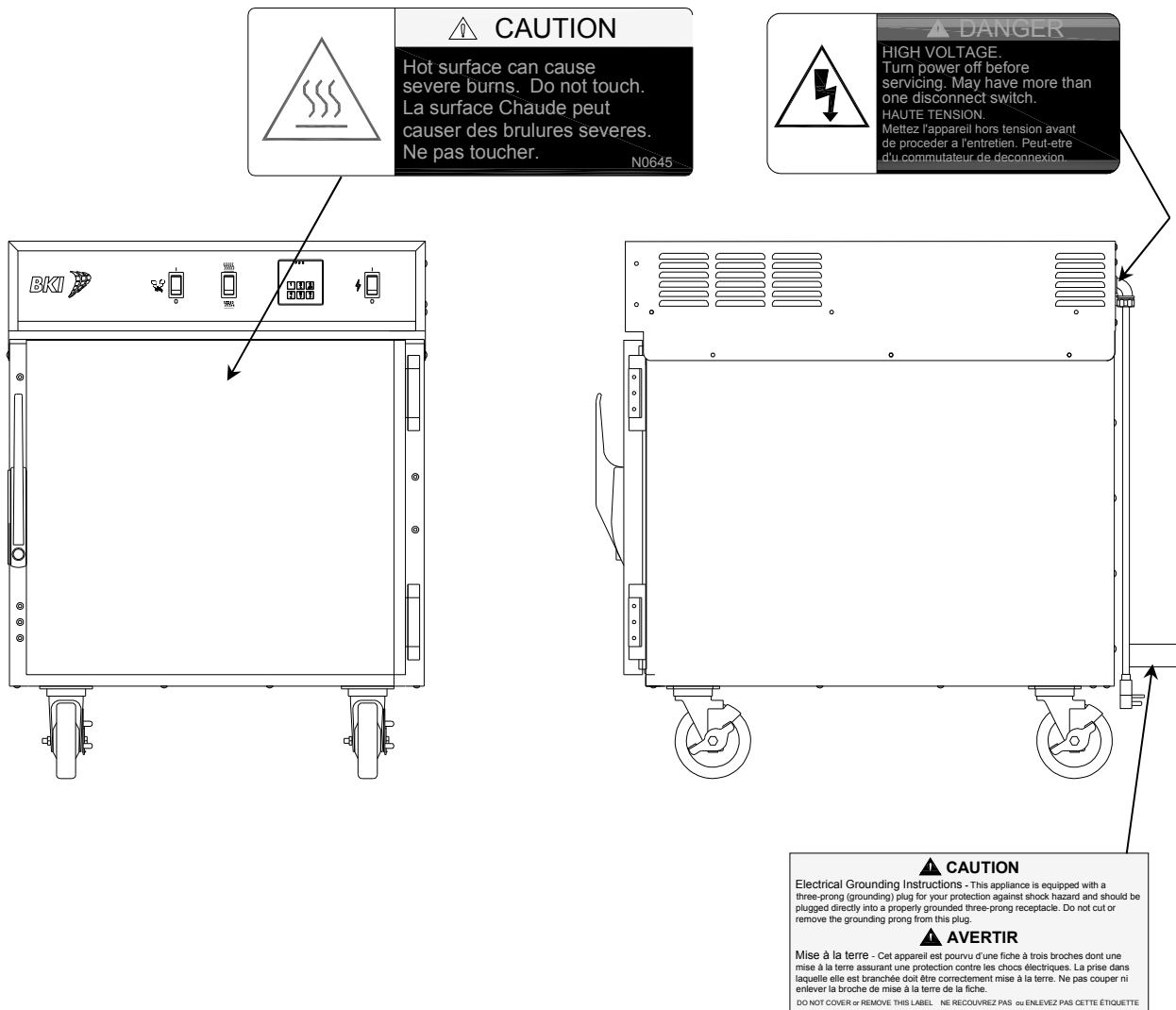

Health and Sanitation Practices

BKI® ovens are manufactured to comply with health regulations and are tested and certified to UL®, CUL®, and NSF® standards. You must operate the equipment properly using only quality products and use meat thermometers to insure meats are thoroughly cooked.

Food Handling

- Wash hands thoroughly in warm, soapy water after handling raw poultry or meats.
- Clean and sanitize all utensils and surfaces that have been in contact with raw products.
- **Never** place cooked meats on the same surfaces used to prepare raw meats, unless the area has been thoroughly cleaned and sanitized.

Storage of Raw Meats

- Designate an area or shelf strictly for the storage of all raw meats to be used in the oven.
- Raw product must always be stored at temperatures below 38° F. (3° C.).
- **Never** store or mix raw foods above cooked foods, as this is a health hazard. The drippings from raw foods contaminate cooked or processed foods.
- All chicken and chicken parts to be stored overnight must be thoroughly iced down and refrigerated.

Coding Cooked Foods

All products cooked during the day should be sold the same day.

NOTE: It is not the intent of the cooking program to have unsold merchandise at the end of the cooking day. Follow your company's procedures for the handling of any leftover product.

Storage of Prepared Foods

- Cold foods should be kept at or below 38° F. (3° C.).
- Hot foods must be maintained to meet local health codes, usually a minimum 145° F. (63° C.).

Operation

Controls and Indicators

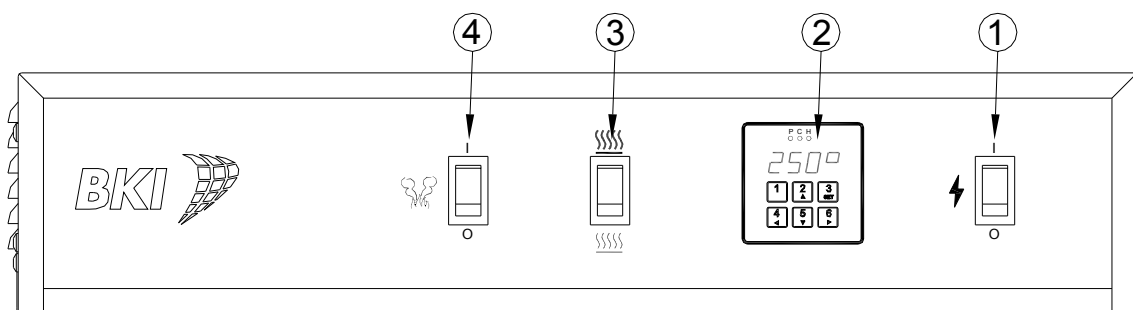

Hardware Controls

Item #	Description	Function
1	Main Power Switch	Turns power to the entire unit on or off. When placed in the on position [I], the controller is powered, the fans operate and the optional smoker can be operated. When placed in the off position [O], power is removed from the entire unit.
2	Cooking Controller	Used for operation and programming of the oven. The standard analog controller features 6 programmable recipes with preheat, cook and hold stages. The optional touch screen controller feature 15 programmable recipes with preheat, multiple cook and hold stages.
3	Power Level Selector Switch	Controls the heat output of the oven. In the high position (upper) the ovens heats at the maximum rate. In the low position (lower) the oven heats at a slower rate.
4	(Optional) Smoker Power Switch	When the main power switch is on, this switch turns power on [I] or off [O] to the optional wood smoke heater in the oven cavity.

CP0066 Analog Controller

CP0066 Recipe Editing

With the oven Main Power Switch in the On position, press and hold the [3_{SET}] button for two or three seconds until the controller chirps twice. Release the button and the controller will display **Edit**.

Select the recipe to edit by pressing one of the six buttons. The controller now displays the *Preheat Temperature* for that recipe and the indicator below the **P** above the display is illuminated. Set the desired *Preheat Temperature* as detailed below. If the *Preheat Temperature* is set below

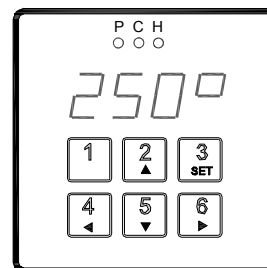

CP0066 Controller

Changing Recipe Values

Beginning with the right-most digit, press the [4◀] or [6▶] buttons to highlight the digit to be edited. Press the [2▲] or [5▼] buttons to increase or decrease that digit to the desired value.

Once all of the digits are set to the desired value press the [3_{SET}] button to save that values and advance to the next recipe item.

150F, the controller will display **OFF** and the Preheat stage is disabled.

Next the *Cook Temperature* is displayed and the indicator below the **C** above the display is illuminated. Set the desired *Cook Temperature* value and press the [3_{SET}] button to advance to the *Cook Time*. The *Cook Time* is displayed in hours and minutes.

After pressing the [3_{SET}] button to accept the *Cook Time*, the value for the *Hold Temperature* is displayed and the indicator below the **H** above the display is illuminated. Set the *Hold Temperature* to the desired value. If the *Hold Temperature* is set below 150F, the controller will display **OFF** and the Hold stage is disabled.

Press and hold the [3_{SET}] button for two or three seconds until the controller chirps twice. The recipe is now saved and the controller will return to operating mode.

Cooking with the CP0066 Controller

Move the Main Power Switch to the On position and the controller displays **OFF**. In this state the controller is ready to cook.

Cooking a Recipe with Preheat

To Preheat the oven press one of the six buttons. The oven will begin preheating and the indicator below the **P** above the display will illuminate. The display will cycle between **PreH** and **XXX°** (the recipe preheat temperature).

When the oven reaches the preheat temperature, the controller will sound an alarm for 5 seconds and the controller will display **rdY**.

Load the food product into the oven, close the oven door and touch the [3_{SET}] button to start the Cook stage. The oven will begin cooking and the indicator below the **C** above the display will illuminate. The display will cycle between **cX:XX** (the remaining cook time) and **XXX°** (the recipe cook temperature).

At the completion of the cook stage the control will sound an alarm and the display will flash **donE**. If there is no Hold programmed the controller will return to the ready state and display **OFF**.

If there is a Hold temperature programmed the controller will maintain the programmed hold temperature and a count-up timer will start. The controller display will cycle through **XXX°** (the recipe hold temperature), **X:XX** (the elapsed hold time) and **hold**.

After the food product has been removed from the oven press and hold the [3_{SET}] button for two or three seconds until the controller chirps twice. The controller will return to the ready state and display **OFF**.

NOTE: To stop a cook recipe at any point press and hold the [3_{SET}] button for two or three seconds until the controller chirps twice.

Cooking a Recipe without Preheat

Press one of the six buttons to select a recipe. The controller will display **rdY**.

Load the food product into the oven, close the oven door and touch the [3SET] button to start the Cook stage. The oven will begin cooking and the indicator below the **C** above the display will illuminate. The display will cycle between **cX:XX** (the remaining cook time) and **XXX°** (the recipe cook temperature).

At the completion of the cook stage the control will sound an alarm and the display will flash **donE**. If there is no Hold programmed the controller will return to the ready state and display **OFF**.





If there is a Hold temperature programmed the controller will maintain the programmed hold temperature and a count-up timer will start. The controller display will cycle through **XXX°** (the recipe hold temperature), **X:XX** (the elapsed hold time) and **hold**.



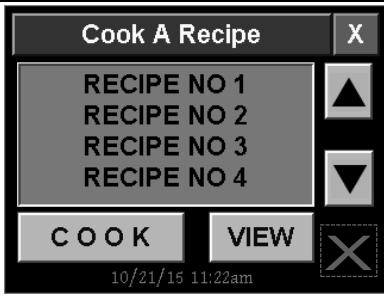

After the food product has been removed from the oven press and hold the [3SET] button for two or three seconds until the controller chirps twice. The controller will return to the ready state and display **OFF**.

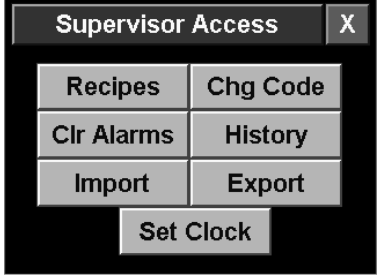



NOTE: To stop a cook recipe at any point press and hold the [3SET] button for two or three seconds until the controller chirps twice.



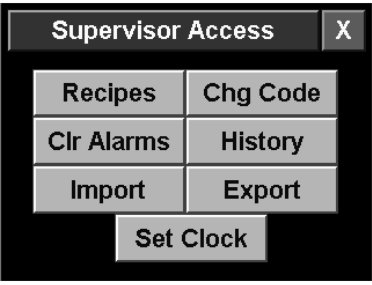

CP0065 Color Touch Screen Controller

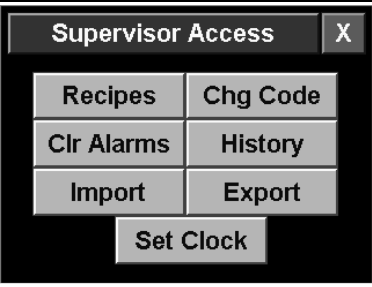
Configuring the CP0065 Controller

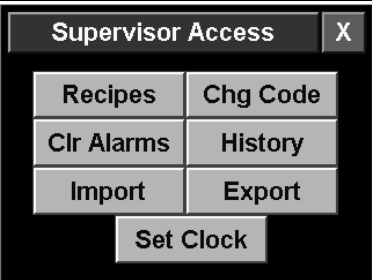

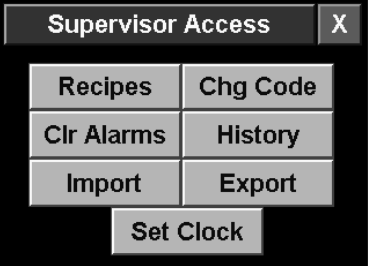

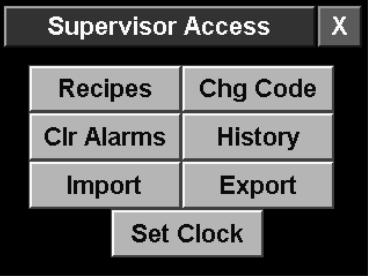
Configuration Access		
<p>Touch and hold the lower right portion of the screen until the control chirps twice.</p>		<p>The area on the control screen is black. The red graphic in this diagrams indicates the area to touch and hold.</p>
<p>Enter your access code. Touch [X] to exit and return to Main Recipe screen.</p>	 <p>[Delete] clears the last character. [Clear] clears all characters.</p>	<p>The default Supervisor access code is 1234. Use the default code the first time the Configuration is accessed. The access code can be changed after initial access to configuration (recommended). Write the new access code below and keep this manual where only supervisors have access to it.</p> <p>Access Code _____</p> <p>Use the screen keypad to enter the access code then touch [ENTER].</p>
<p>Supervisor level configuration screen is displayed. Touch [X] to exit and return to Main Recipe screen.</p>		<p>The supervisor has access to change Recipes, change the Access Code, Set the Clock, Import or Export recipes and configurations or view the control History. Touch the desired function button and follow the configuration instructions below.</p>
Recipe Editing		
<p>Touch and highlight the desired recipe. Touch [EDIT]. Touch [X] to exit and return to Supervisor Access screen.</p>		<p>There are 15 programmable recipes in the control. Touch [▲] or [▼] to scroll through the list. Touch and highlight the recipe name in the selection window. Touch [EDIT].</p>
<p>Touch and highlight the desired Recipe Item. Touch [EDIT]. Touch [X] to exit and return to Select Recipe screen.</p>		<p>Touch and highlight the Recipe Item to be edited in the selection window. Touch [EDIT]. Once all changes have been made you must touch [SAVE] to store the recipe revisions.</p>

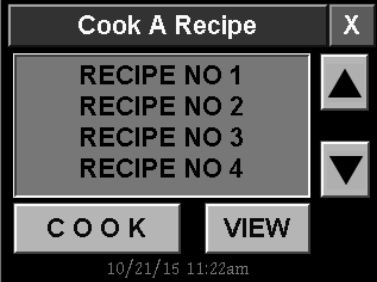

Recipe Editing (continued)		
<p>Edit Recipe Name. Touch [SAVE]. Touch [X] to exit and return to Select Item screen.</p>		<p>Edit the Recipe Name using the alpha-numeric keyboard. Recipe Names are limited to a maximum of 14 characters. Touch [SAVE] to save the new Recipe Name and return to the Select Item screen. [Clr] – Clears the editing box of all characters. [Rst] – Restores the original recipe name. [Space] – Adds a space character at the end. [Del] – Deletes the last character.</p>
<p>Edit Recipe Items. Touch [SAVE]. Touch [X] to exit and return to Select Item screen.</p>		<p>All Recipe Items (Preheat, Cook and Hold) are edited in this screen. Touch [<<] and [>>] to move between the Recipe Items. The value field active for editing has a red background. Touch the inactive field to make it active for editing. The Preheat and Hold items only have a temperature value. The time field for these items is greyed out and not selectable. Use the dial on the right of the screen or the [+] and [-] buttons to change the value. To turn the Cook Cycle 2, Cook Cycle 3 or Hold segments Off, set the temperature value below 150F. Touch [SAVE] to save the new values before moving to the next Recipe Item.</p>
<p>Return to the Select Item screen. Touch [SAVE] to save Recipe. Touch [X] to exit and return to Select Recipe screen.</p>		<p>After Recipe editing is complete, touch [X] on the Recipe Item screen above to return to the Select Item screen. You must touch [SAVE] to store the recipe revisions.</p>
<p>Touch and highlight another Recipe. Touch [EDIT]. or Touch [X] to exit and return to Supervisor Access screen.</p>		<p>Touch and highlight another Recipe name in the selection window. Touch [EDIT]. or Touch [X] to return to the Supervisor Access screen if you are done editing Recipes.</p>

Changing Access Code		
<p>Supervisor level configuration screen is displayed. Touch [X] to exit and return to Main Recipe screen.</p>		<p>Touch [Chg Code].</p>
<p>Enter new Access Code. Touch [ENTER]. Touch [X] to exit and return to Supervisor Access screen.</p>	 <p>[Delete] clears the last character. [Clear] clears all characters.</p>	<p>Use the screen keypad to enter the new 4 digit Access Code. Touch [ENTER]. Record the new Access Code in the area provided in the Configuration Access section of this manual. Once the new Access Code is entered the old code will not provide configuration access.</p>
Importing Recipe & Configuration Files		
<p>Supervisor level configuration screen is displayed. Touch [X] to exit and return to Main Recipe screen.</p>		<p>Supervisor Access gives the ability to Import Recipe and Configuration files from a USB flash drive. Touch [Import].</p>
<p>Insert USB Drive. Touch [Read Recipes] and/or [Read Config]. Touch [X] to exit and return to Supervisor Access screen.</p>		<p>Insert the USB flash drive into the USB port located on the back of the controller. The message line will change to read "Drive Inserted" and the [Read Recipes] and [Read Config] buttons will become active. Touch [Read Recipes] and/or [Read Config] to upload the files to the control. Remove the USB drive when finished and the control will return to the Supervisor Access screen.</p>
Exporting Recipe, Configuration and History Files		
<p>Supervisor level configuration screen is displayed. Touch [X] to exit and return to Main Recipe screen.</p>		<p>Supervisor Access gives the ability to Export Recipe, Configuration and History files to a USB flash drive. Touch [Export].</p>

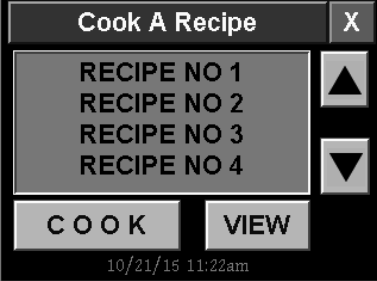
Exporting Recipe, Configuration and History Files (continued)		
<p>Supervisor level configuration screen is displayed. Touch [X] to exit and return to Main Recipe screen.</p>		<p>Insert the USB flash drive into the USB port located on the back of the controller. The message line will change to read "Drive Inserted" and the [Save Recipes], [Save Config] [Save History] buttons will become active. Touch [Save Recipes], [Save Config] and/or [Save History] to download the files to the USB drive. Remove the USB drive when finished and the control will return to the Supervisor Access screen.</p>
Setting the Clock		
<p>Supervisor level configuration screen is displayed. Touch [X] to exit and return to Main Recipe screen.</p>		<p>The control has a real time clock that will maintain the current date and time for up to 7 days with no power. This information is used for the error and event history log. Touch [Set Clock].</p>
<p>Touch value and change using [+] and [-] buttons. Touch [SAVE] to save and return to Supervisor Access screen.</p>		<p>Touch and highlight the value below the item to be changed. Use the [+] and [-] buttons to change the item to the desired value. To change the am/pm setting simply touch that value to toggle between am and pm. Touch [SAVE] to save the changes. The control will return to the Supervisor Access screen.</p>
Viewing the Error and Event History File		
<p>Supervisor level configuration screen is displayed. Touch [X] to exit and return to Main Recipe screen.</p>		<p>Supervisor Access gives the ability to view the controls History log. The log includes the total numbers of operating hours, the total number of cooking hours and all event and error messages. Touch [History].</p>
<p>Controller History screen is displayed. Touch [SAVE] to save and return to Supervisor Access screen.</p>		<p>Total: the total number of hours the control has been turned on. Cook: the total number of hours the control has been cooking (includes preheat). Touch [▲] or [▼] to scroll through the list of trackable events and errors. The date, time and a descriptive string are displayed for each event. A list of the errors and events follows in this manual.</p>

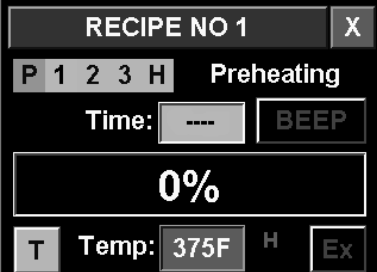
Cooking with the CP0065 Controller

View a Recipe		
<p>Touch and highlight desired recipe. Touch [VIEW].</p>		<p>There are up to 15 recipes programmed in the control. Touch [▲] or [▼] to scroll through the list. Touch and highlight the recipe name in the selection window. Touch [VIEW].</p>
<p>Touch [X] to return to the Main Recipe screen.</p>		<p>The summary screen for the recipe selected is displayed. The screen displays the Preheat temperature setting, the Cook time and temperature for each cook segment and the Hold temperature. Any stage labeled “off” is disabled in the recipe.</p>
Cooking a Recipe		
<p>Touch and highlight the desired recipe. Touch [COOK].</p>		<p>There are up to 15 recipes programmed in the control. Touch [▲] or [▼] to scroll through the list. Touch and highlight the recipe name in the selection window. Touch [COOK].</p>
<p>Touch [PREHEAT] or [COOK].</p>		<p>Touch [PREHEAT] to heat the oven to the programmed preheat temperature. Touch [COOK] to begin the first cook segment without preheating the oven. It is recommended to always preheat the oven before starting to cook. Touch [T] at any point to view the actual oven cavity temperature. The temperature will be displayed for 10 seconds.</p>
<p>Preheating screen is displayed. To exit the cook recipe touch and hold [X] until the control chirps twice.</p>		<p>The preheating screen for the recipe is displayed. The programmed preheat temperature is displayed at the bottom of the screen. Touch [T] at any point to view the actual oven cavity temperature. The oven cavity temperature will be displayed for 10 seconds.</p>

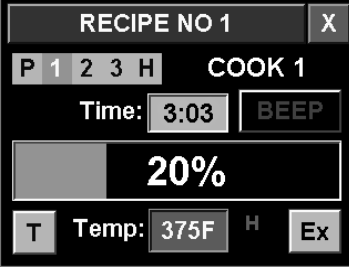
Cooking a Recipe (continued)		
<p>LOAD OVEN screen is displayed. To exit the cook recipe touch and hold [X] until the control chirps twice.</p>		<p>When the oven reaches the programmed preheat temperature the LOAD OVEN screen is displayed. The control will emit an audible alarm for 5 seconds and the screen background will alternate between green and blue. Before loading the oven touch the large [LOAD OVEN] button.</p>
<p>Load the oven. Touch the large [START COOK] button to begin cooking.</p>		<p>The START COOK screen is displayed. The screen background will alternate between green and blue until the large button is touched. To beginning cooking, close the oven door and touch the large [START COOK] button.</p>
<p>Main cooking screen is displayed. To exit the cook recipe touch and hold [X] until the control chirps twice.</p>		<p>The main cooking screen is displayed while the cook in in progress. The Time displayed is the time remaining in the active cook segment. The progress bar shows the progress through the sum of all of the programmed cook segment times. The Temperature display is the programmed temperature for the active cook segment. Touch [T] at any point to view the actual oven cavity temperature. The oven cavity temperature will be displayed for 10 seconds. Touching [Ex] will add the preset extra time (typically 5 minutes) to the active cook segment.</p>
<p>End of Cooking</p>	<p>End of Cooking without Hold On completion of the last cook segment the [BEEP] button will flash red and the control will emit a continuous audible alarm. To cancel the audible alarm, touch [BEEP]. If additional cooking is required, touch [Ex]. This will cook for the preset extra time (typically 5 minutes) at the temperature programmed for the last cook segment. If no additional cooking is required, remove all cooked product from the oven then touch and hold [X] until the control chirps and returns to the main recipe screen.</p>	<p>End of Cooking with Hold On completion of the last cook segment the [BEEP] button will flash red and the control will emit a continuous audible alarm. The control will automatically go into Hold and maintain the oven cavity at the programmed temperature. To cancel the audible alarm, touch [BEEP]. The control will stay in Hold. Measure the internal temperature of the cooked product. If additional cooking is required, touch [Ex]. This will cook for the preset extra time (typically 5 minutes) at the temperature programmed for the last cook segment. Once all cooked product has been removed from the oven, touch and hold [X] until the control chirps and returns to the main recipe screen.</p>

Optional Wood Smoker

The optional wood smoker gives the ability to cook products with an authentic smoked barbecue flavor. Any type of wood, hickory, mesquite, apple, etc., can be used in the smoker. It is recommended that wood chips, not chunks be used and that the wood chips be soaked in water prior to being used in the smoker.

The temperature of the wood smoker is preset at the factory. The wood should smolder, not burn in the wood smoker. Should the temperature need to be adjusted contact your local authorized BKI service agent.

Place the pre-soaked wood chips into the Wood Chip Tray and close the Cover. Do not overfill the Wood Chip Tray. The bottom rack will not slide completely into the oven if the Wood Chip Tray Cover does not fully close.

Set the loaded Wood Chip Tray onto the Smoker Heated Base. The vent slots in the Wood Chip Tray should be oriented toward the sides of the oven.

Preheat the oven and load the food product into the preheated oven. Start the cook stage on the controller then turn the Smoker Power Switch to the On position.

CAUTION Touching the wood smoker components could cause severe burns. Turn the oven Main Power Switch to the Off position and allow the oven and wood smoker to cool before handling the wood smoker components.

The amount of wood chips required depends on the product cook time and the size of the wood chips.

Smoke does not need to be generated during the entire cook cycle. After the surface temperature of the product being cooked reaches approximately 145°F [60°C] the product will not absorb the smoke flavor as readily. Smoke generated after this point will have little effect on the flavor of the cooked product.

Varying cooking time, cooking temperature and the amount of wood chips will effect the flavor of the cooked product. Experience with the Gourmet Oven and wood smoker will allow you to create the perfect smoked barbecue flavor in the products cooked in the oven.

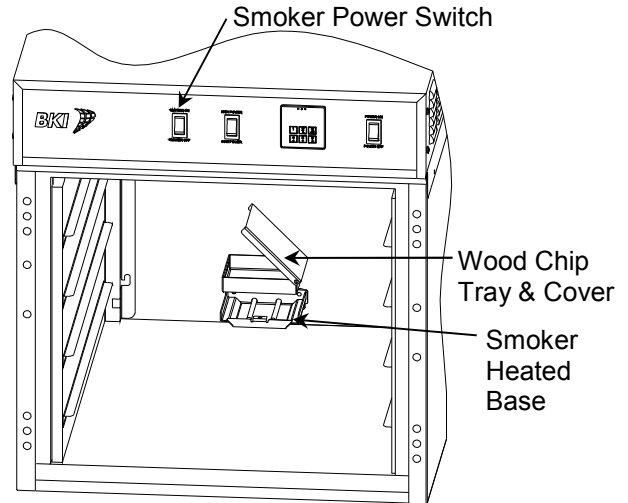

Optional Wood Smoker

Installation



WARNING

Serious injury, equipment damage or death could result if attempting to install this oven. Ensure that an authorized BKI service agent install the oven.

Unpacking and Handling

It is the owners' responsibility to file all freight claims with the delivering truck line. Inspect all cartons and crates for damage as soon as they arrive. If damage to cartons or crates is found, or if a shortage is found, note this on the bill of lading (all copies) prior to signing.

If damage is found when the equipment is opened, immediately call the delivering truck line and follow up the call with a written report indicating concealed damage to your shipment. Ask for an immediate inspection of your concealed damage item. Packaging material **MUST** be retained to show the inspector from the truck line.

Remove all packing from the interior and exterior of the oven.

GO-36 Stacking Instructions

Tools Required:

- 7/16 combination wrench
- 7/16 socket and ratchet
- (2) 2x4x30" pieces of wood

NOTE: Remove all plastic from stacking kit parts.

1. Remove racks and drip pans from inside both ovens.
Place two wood 2x4x30" pieces on the floor. Tilt unit back onto wood pieces being careful not to crush fuse holders or power cord.
2. Remove casters and place large aluminum base WB56210600 (lip goes downward) between the bottom of the oven and the casters. Install the caster hardware that was removed.
3. Carefully place unit upright.
4. Remove the heater control unit of the base unit (3 screws on each side). Place four (4) small stainless steel angles (FA56210702) at the outside corners of the gasket on the oven cabinet. Replace heater control unit.
5. Carefully place second unit on its back just as in step 2.
6. Remove casters and store. Place stacking kit piece AB56210500 (with louvers on sides) with notches toward the oven back. Install hardware removed from the casters to secure the stacking kit piece to the oven bottom. Install four (4) handles on sides of stacking kit piece using 1/4-20 x 1" bolts and lock washers.

NOTE: Be sure handles are secure.

7. Place unit upright.

NOTE: Lock the casters on the bottom unit.



CAUTION

Be careful not to pinch hands while installing the top unit.

8. Carefully lift the oven with the handles and place on top of other oven.
9. Seal the base and the stacking kit piece to the oven bottoms using silicone rubber RTV (S0018) approved for this use.
10. Replace racks and drip pans.

Location and Clearance

The oven must be mounted on a level surface capable of supporting the fully loaded oven. Refer to Chart 1 for the oven weight.

Adequate clearance must be provided around the oven for safety, proper operation and ventilation. Refer to Chart 1 for required minimum clearances. Note that these are minimum clearances. If the oven is to be permanently mounted near other immovable objects additional clearance must be provided for connection and service of the oven on both sides.

All ventilation slots must be kept free from obstruction.

Extraction

Extraction is not a specific requirement for this type of appliance. Certain conditions, e.g./ installation in a confined space, temperature controlled environment or use of the wood smoker option may require the need for extra ventilation or extraction. Consult your local ventilation/extraction air conditioning company or contact the technical services department at BKI.

Wiring



Electrocution, equipment failure or property damage could result if an unlicensed electrician performs the electrical installation. Ensure that a licensed electrician perform the electrical installation in accordance with applicable local and national codes.

General Guidelines

- In the absence of local codes refer to the latest edition of one of the following:
 - National Electrical Code, ANSI/NFPA 70-20XX (USA) which can be obtained from:

The National Fire Protection Association
Batterymarch Park
Quincy, MA 02269
 - I.E.E. Wiring Regulations (Europe)
- Verify that the power supply conforms to the electrical rating listed on the oven data plate.
- Ensure that the appliance is grounded (earthed).

Chart 1 Location & Clearance

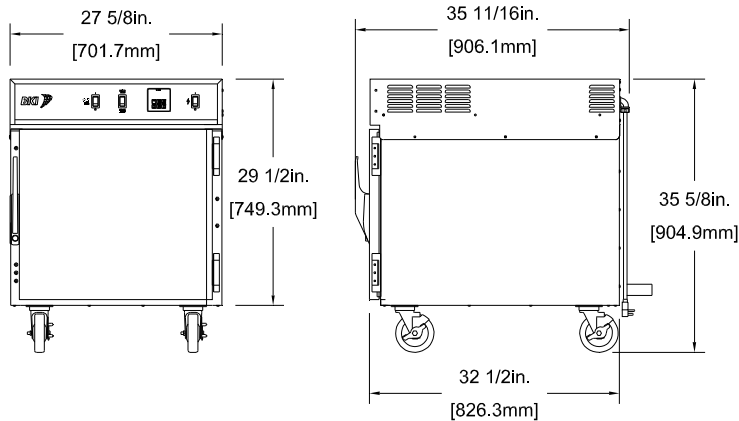
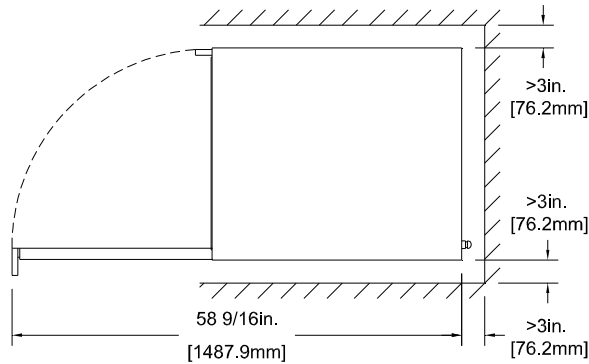

GO-36

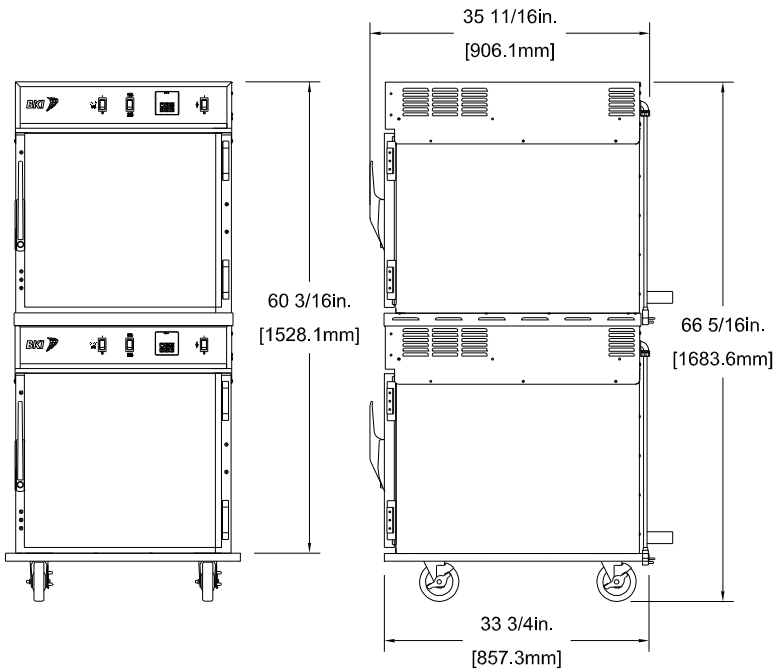

GO-36-2

Electrical Specifications

Model: GO-36

1Ph + Gnd, 60Hz

Volts	Amps	KW	Breaker
208	16.5	3.4	20
220	17.3	3.8	30
240	19.0	4.6	30

Model: GO-36S

1Ph + Gnd, 60Hz

Volts	Amps	KW	Breaker
208	17.7	3.7	30
220	18.8	4.1	30
240	20.4	4.9	30

Mechanical Specifications

Uncrated

Dimension	GO-36	GO-36-2
Height	33 3/4 in. [857.3mm]	64 1/2 in. [1638.2mm]
Width	27 5/8 in. [701.7 mm]	27 5/8 in. [701.7 mm]
Depth	36 in. [914.4 mm]	36 in. [914.4 mm]
Floor Space	6.9 sq. ft. [0.64 m ²]	6.9 sq. ft. [0.64 m ²]
Weight	320 lb. [145 kg]	620 lb. [282 kg]

Crated

Dimension	GO-36	GO-36/2
Height	42 in. [1067.7 mm]	72 in. [1828.8mm]
Width	38 in. [966.9 mm]	38 in. [966.9 mm]
Depth	40 in. [1016.0 mm]	40 in. [1016.0 mm]
Floor Space	10.6 sq. ft. [0.98 m ²]	10.6 sq. ft. [0.98 m ²]
Weight	355 lb. [161 kg]	650 lb. [295 kg]

Maintenance

⚠ CAUTION

Failure to comply with the maintenance below could result in a serious accident or equipment damage.

⚠ DANGER

Failure to remove power from this unit before performing maintenance may cause severe electrical shock. This unit may have more than one disconnect switch.

Scheduled Maintenance

Oven Cleaning (Daily)

The oven must be cleaned at the end of each business day. It is easier to clean while still warm. Cleaning is not only necessary for sanitary reasons, but will increase sales appeal and maximize operating efficiency.

⚠ DANGER

Failure to remove power from this unit may cause severe electrical shock. This unit may have more than one disconnect switch.

⚠ CAUTION

Always wear appropriate personal protection equipment (goggles, rubber glove & long sleeved garments) when cleaning the oven to guard against possible injury.

Using abrasive cleaners will damage the cabinet finish. Use only a mild soap and water solution or approved cleaner.

DO NOT USE OVEN CLEANER on this machine. Caustic cleaners will cause damage to the machine.

NEVER USE A WATER HOSE OR A STEAM CLEANER TO WASH THIS UNIT. Excess water can get into the interior of the cabinet and cause damage.

BKI® Approved Cleaning Solutions

ECOLAB Greasestrip Plus
Proctor & Gamble DCT Oven Cleaner
J. Wilson Marketing Combi Brite Cleaner

1. Place the Main Power Switch in the Off position and unplug the power cord.
2. Wearing your insulated gloves, remove all food pans from the unit.
3. Let the oven cool to room temperature.
4. Remove racks and drip pan from the unit and place them in a large sink to soak in hot cleaning solution (BKI® Cleaner).



5. Remove the rack supports by following the appropriate procedure below:

- a. Lift the left-side rack support up and off of its mounting studs.



- b. Once the rack support is off of its studs, tilt the top toward the center of the oven.



- c. Pull rack support out of oven and clean.



- d. Repeat these steps for the right-side rack support.

6. Clean the outside and inside of the oven with warm water, a sponge and approved cleaner which is authorized for use on food surface areas.
7. Wipe the unit dry with a soft cloth.
8. To reinstall rack supports follow the procedures below:

- a. Insert the left rack support into the oven against the back wall.



- b. Hook the rack support hangers on the corresponding mounting studs.



- c. Repeat these steps for the right side rack support.

9. Reinsert the racks and drip pan.

Troubleshooting

Refer to the table below for troubleshooting information.

Problem	Cause	Possible Solution
Unit will not turn on.	Oven power plug is disconnected.	Plug unit into mating receptacle.
	Problem with building power supply	Check circuit breaker at building power panel. If problem persists, contact BKI service agent for corrective action.
	Power supply cord has been damaged.	Contact an authorized BKI service agent for corrective action.
	Failed internal component.	Contact an authorized BKI service agent for corrective action.
Unit turns on (fans operate) but the controller does not power up.	Controller fuse is blown.	Contact an authorized BKI service agent for corrective action.
Oven does not heat at all.	Improper control settings.	Reset the control.
	Failed internal component.	Contact an authorized BKI service agent for corrective action.
Oven has very slow heat up or recovery. NOTE: This is normal when using the LOW POWER setting.	Improper power line voltage or failed internal component.	Contact an authorized BKI service agent for corrective action.
Oven will not come up to temperature.	Oven HIGH POWER/LOW POWER switch is in the LOW POWER position with the oven control set in the 300°-400° F range.	For these temperatures, operate oven on HIGH POWER.
	Failed internal component.	Contact an authorized BKI service agent for corrective action.

CP0065 Controller Warnings

CTRL TEMP WARNING CHECK FAN INLET

This warning message indicates the temperature in the oven's control compartment has risen to a temperature that would indicate a problem with the cooling fans on the right side of the oven. Verify that the fan's grill is not blocked and that the fans are operating when the oven is on. If the fans are not operating, call the authorized BKI service agency to service the oven.

CTRL TEMP WARNING CALL FOR SERVICE

This message is displayed when the temperature in the oven's control compartment rises to a temperature that will harm the oven's components. Use of the oven should be discontinued at the completion of the current cooking recipe. Call the authorized BKI service agency to service the oven.

Wiring Diagram

GO-36 & GO-36S

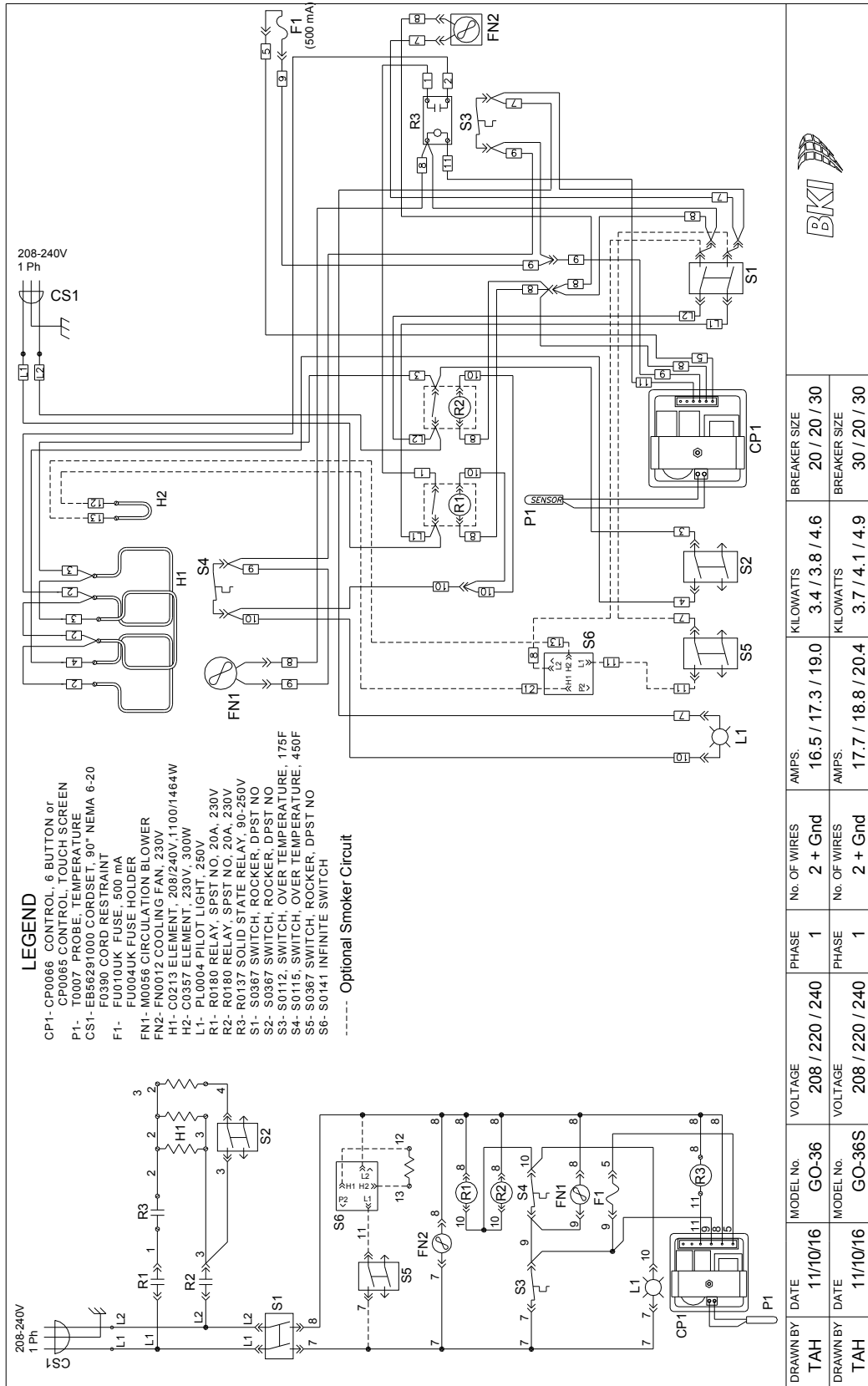

GO-36C & GO-36CS

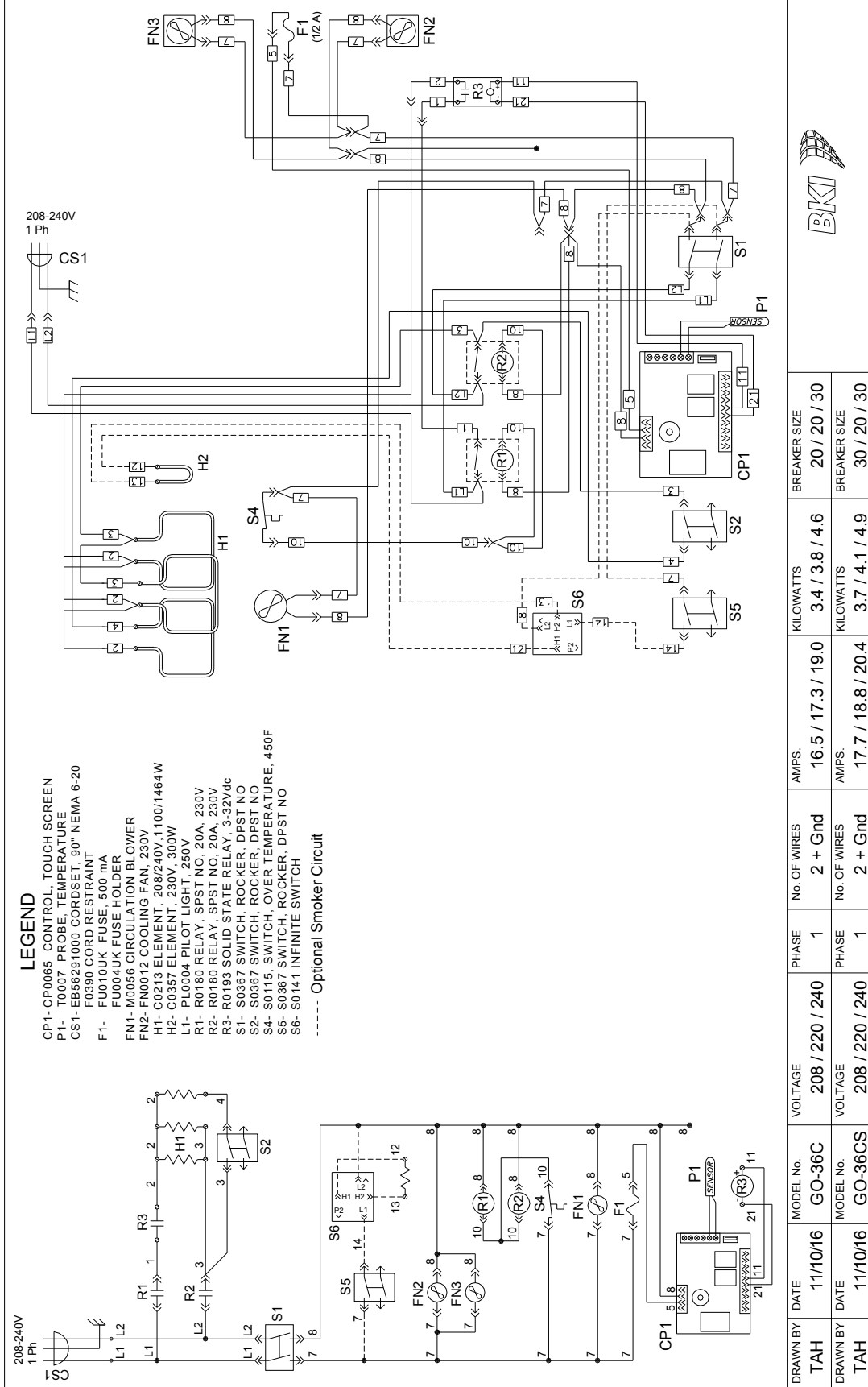

DRAWN BY	DATE	MODEL No.	VOLTAGE	PHASE	No. OF WIRES	AMPS.	KILOWATTS	BREAKER SIZE
TAH	11/10/16	GO-36C	208 / 220 / 240	1	2 + Gnd	16.5 / 17.3 / 19.0	3.4 / 3.8 / 4.6	20 / 20 / 30
DRAWN BY	DATE	MODEL No.	VOLTAGE					
TAH	11/10/16	GO-36CS	208 / 220 / 240	1	2 + Gnd	17.7 / 18.8 / 20.4	3.7 / 4.1 / 4.9	30 / 20 / 30

Notes



2812 Grandview Drive, Simpsonville, S.C. 29680, USA
<http://www.bkideas.com>

Made and printed in the U.S.A