

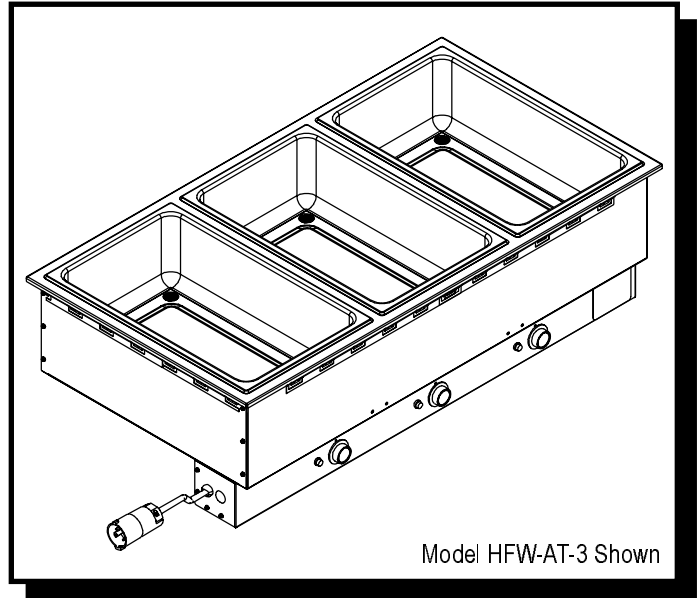

**INSTALLATION
AND
OPERATING
INSTRUCTIONS**



**Models: HFW-AT-2 thru 6 & HFW-AT-2D thru 6D
Hot Food Well w/Bottom Mounted Control**

INTENDED FOR OTHER THAN HOUSEHOLD USE

**RETAIN THIS MANUAL FOR FUTURE REFERENCE
TOASTER MUST BE KEPT CLEAR OF COMBUSTIBLES AT ALL TIMES**

! **FOR YOUR SAFETY:** Do not store or use gasoline or other flammable vapors and liquids in the vicinity of this or any other appliance. **!**

! **WARNING:** Improper installation, adjustment, alteration, service or maintenance can cause property damage, injury or death. Read the Installation, Operating and Maintenance Instructions thoroughly before installing or servicing this equipment. **!**

Initial heating of appliance may generate smoke or fumes and must be done in a well ventilated area. Overexposure to smoke or fumes may cause nausea or dizziness.

This equipment has been engineered to provide you with year-round dependable service when used according to the instructions in this manual and standard commercial kitchen practices.



P/N 67208 9/05

Phone: (214) 421-7366
Fax: (214) 565-0976
Toll Free: (800) 527-2100
Website: www.apwwyott.com
E-mail: info@apwwyott.com

APW WYOTT
729 Third Avenue
Dallas, TX 75226

IMMEDIATELY INSPECT FOR SHIPPING DAMAGE

All containers should be examined for damage before and during unloading. The freight carrier has assumed responsibility for its safe transit and delivery. If equipment is received damaged, either apparent or concealed, a claim must be made with the delivering carrier.

- A) Apparent damage or loss must be noted on the freight bill at the time of delivery. It must then be signed by the carrier representative (Driver). If this is not done, the carrier may refuse the claim. The carrier can supply the necessary forms.
- B) Concealed damage or loss if not apparent until after equipment is uncrated, a request for inspection must be made to the carrier within 15 days. The carrier should arrange an inspection. Be certain to hold all contents and packaging material.

Installation and start-up should be performed by a qualified installer who thoroughly read, understands and follows these instructions.

APW Wyott takes pride in the design and quality of our products. When used as intended and with proper care and maintenance, you will experience years of reliable operation from this equipment. To ensure best results, it is important that you read and follow the instructions in this manual carefully.



Installation and start-up should be performed by a qualified installer who thoroughly read, understands and follows these instruction.



If you have questions concerning the installation, operation, maintenance or service of this product, write Technical Service Department APW Wyott Foodservice Equipment Company, 729 Third Avenue, Dallas, TX 75226.



SAFETY PRECAUTIONS



Before installing and operating this equipment be sure everyone involved in its operation are fully trained and are aware of all precautions. Accidents and problems can result by a failure to follow fundamental rules and precautions.

The following words and symbols, found in this manual, alert you to hazards to the operator, service personnel or the equipment. The words are defined as follows:

 **DANGER:** This symbol warns of imminent hazard which will result in serious injury or death. 

 **WARNING:** This symbol refers to a potential hazard or unsafe practice, which could result in serious injury or death. 

 **CAUTION:** This symbol refers to a potential hazard or unsafe practice, which may result in minor or moderate injury or product or property damage. 

 **NOTICE:** This symbol refers to information that needs special attention or must be fully understood even though not dangerous. 

GENERAL INFORMATION

THIS MANUAL SHOULD BE RETAINED FOR FUTURE REFERENCE



CAUTION: These models are designed, built, and sold for commercial use. If these models are positioned so the general public can use the equipment make sure that cautions, warnings, and operating instructions are clearly posted near each unit so that anyone using the equipment will use it correctly and not injure themselves or harm the equipment.



WARNING: Check the data plate on this unit before installation. Connect the unit only to the voltage and frequency listed on the data plate. Connect only to 1 or 3 phase as listed on the data plate.



WARNING: Electrical and grounding connections must comply with the applicable portions of the national electrical code and/or other local electrical codes.



TABLE OF CONTENTS

SECTION	ITEM	PAGE
1	Specifications	4
2	Installation Instructions	5
3	General Operation Instructions	6
4	General Cleaning Instructions	6
5	General Troubleshooting	6
6	Warranty Procedure	6
7	Wiring Diagram	7
8	Parts List & Exploded View	8
9	Warranty	11

1. SPECIFICATIONS

MODEL	VOLTAGE/KW/AMPS	NEMA CONFIGURATION	HFW NO DRAIN	HFW-D WITH DRAIN	CORD ASS'Y
HFW-AT-2	120V - 1.7 KW - 14.2	5-20P	70107000	70107012	55310
HFW-AT-2	208V - 1.7 KW - 8.2	6-15P	70107070	70107072	85640
HFW-AT-2	240V - 1.7 KW - 7.0	6-15P	70107064	70107074	85640
HFW-AT-3	208V - 2.55 KW - 12.3	L6-20P	70107018	70107013	55952
HFW-AT-3	240V - 2.55 KW - 10.6	6-15P	70107065	70107075	85640
N/A	120V	N/A	N/A	N/A	N/A
HFW-AT-4	208V - 3.4 KW - 16.3	L6-30P	70107035	70107014	55950
HFW-AT-4	240V - 3.4 KW - 14.2	L6-20P	70107066	70107076	55952
N/A	120V	N/A	N/A	N/A	N/A
HFW-AT-5	208V - 4.25 KW - 20.4	L6-30P	70107054	70107015	55950
HFW-AT-5	240V - 4.25 KW - 17.4	L6-30P	70107067	70107077	55950
N/A	120V	N/A	N/A	N/A	N/A
HFW-AT-6	208V - 5.1 KW - 24.5	L6-50P	70107028	70107016	55951
HFW-AT-6	240V - 5.1 KW - 21.3	L6-30P	70107068	70107078	55950
N/A	120V	N/A	N/A	N/A	N/A

DIMENSIONS: MODELS HFW-AT-2 thru 6

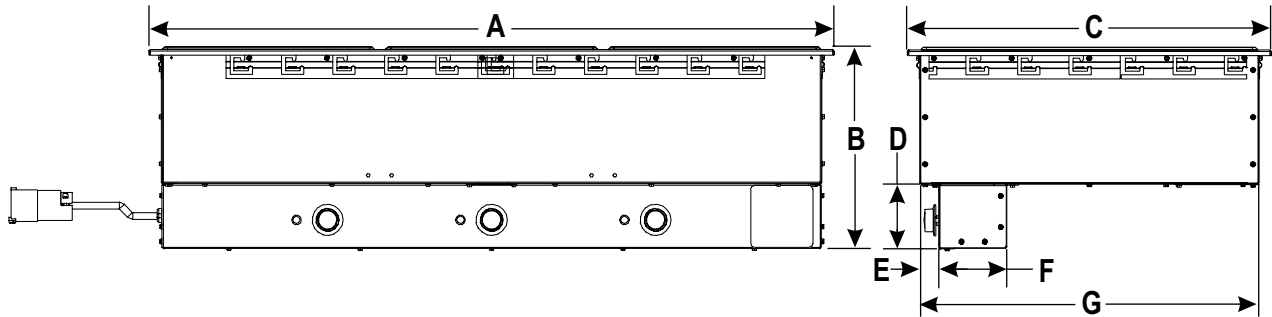

	A	B	C	D	E	F	G
HFW-AT-2	29.750	12.911	23.438	4.078	1.250	4.383	21.875
HFW-AT-3	44.125	12.911	23.438	4.078	1.250	4.383	21.875
HFW-AT-4	58.500	12.911	23.438	4.078	1.250	4.383	21.875
HFW-AT-5	72.875	12.911	23.438	4.078	1.250	4.383	21.875
HFW-AT-6	87.250	12.911	23.438	4.078	1.250	4.383	21.875

DIMENSIONS: MODELS HFW-AT-2D thru 6D

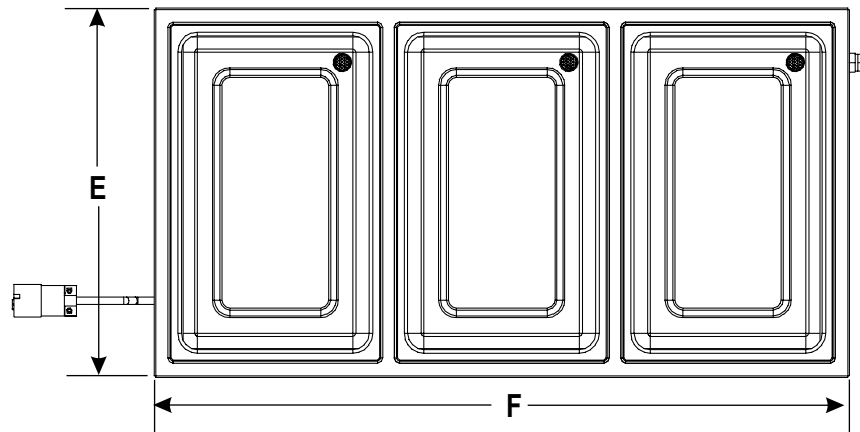
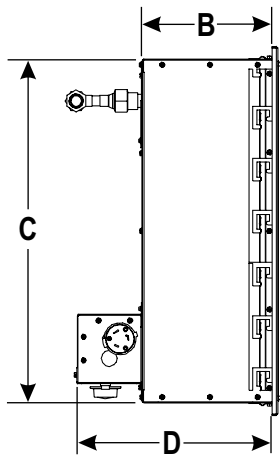
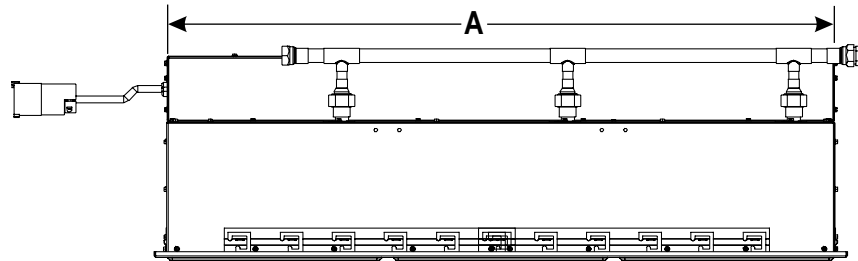

	A	B	C	D	E	F
HFW-AT-2D	28.078	8.305	21.875	12.421	23.438	29.750
HFW-AT-3D	42.444	8.305	21.875	12.421	23.438	44.125
HFW-AT-4D	56.763	8.305	21.875	12.421	23.438	58.500
HFW-AT-5D	71.198	8.305	21.875	12.421	23.438	72.875
HFW-AT-6D	85.578	8.305	21.875	12.421	23.438	87.250

2. INSTALLATION INSTRUCTIONS

1. Always clean equipment thoroughly before first use. (See general cleaning instructions.)
2. Check rating label for your model designation & electrical rating.
3. For best results, use stainless steel countertops.

3. GENERAL OPERATION INSTRUCTIONS

1. All foodservice equipment should be operated by trained personnel.
2. Do not allow your customers to come in contact with any surface labeled "**CAUTION HOT**".
3. Where applicable, **DO NOT** cook, warm or hold food directly in liner pans (well pan). Always use steam table pans/insets, etc.
4. Never hold food below 150F (66.6C).
5. Add hot water 120 - 140F (50 - 60C) to well pan.
 - HFW-AT-2 THRU 6 (12 X 20 pan) use: 3-3/4qts (15 cups) (3-1/2 liter)
6. Turn thermostat control to (10) setting. Preheat for approximately 30 minutes.
7. Place covered inset with preheated product into well.
8. Readjust control inset to "4" "6" setting depending on the amount and/or thickness of product.
9. Keep inset / steam table pan(s) covered to maintain ideal serving temperature.
10. Do not let **WELL RUN DRY**.

4. GENERAL CLEANING INSTRUCTIONS

1. **NEVER** clean any electrical unit by immersing it in water. Unplug unit off before surface cleaning.
2. Always clean equipment thoroughly before first use. Clean unit daily. Except where note on charts: use warm, soapy water. Mild Cleansers & PLASTIC scouring pads made be used to remove baked-on food & water scale.
3. Turn off electrical units before cleaning or service. All service should be preformed by an APW Wyott authorized service agency.
4. **DO NOT** use chlorides or chloride-based products in this unit. Chloride-based products and improper cleaning may cause corrosion and pitting
Failure to comply with these instructions may void unit warranty.

5. GENERAL TROUBLESHOOTING

ALWAYS ASK & CHECK:

1. Is the unit connected to a live power source?
2. Check the circuit breaker.
3. Is power switch on & pilot light glowing?
4. Check rating label. Are you operating unit on proper voltage?
If the above checks out, and you still have problems, call an APW Wyott authorized service agency.

6. WARRANTY PROCEDURE

If warranty service is needed on your APW Wyott equipment, follow these steps:

- Secure the model and serial number from the rating label on your appliance.
- Consult the enclosed directory, find the service agency nearest you, call the number listed or the 24-hour toll free service hot line, 1-800-733-2203. If there is not a service agency listed for your area, the parts distributor will provide service for your appliance.
- To order parts, consult the enclosed directory. The parts distributor is listed at the beginning of each state listing. The parts distributors have a complete stock of parts for your appliance.



24 Hour Toll Free Service Hot Line



Service Hotline
(800) 733-2203

7. WIRING DIAGRAM

CAP BULB THERMOSTAT CONFIGURATION

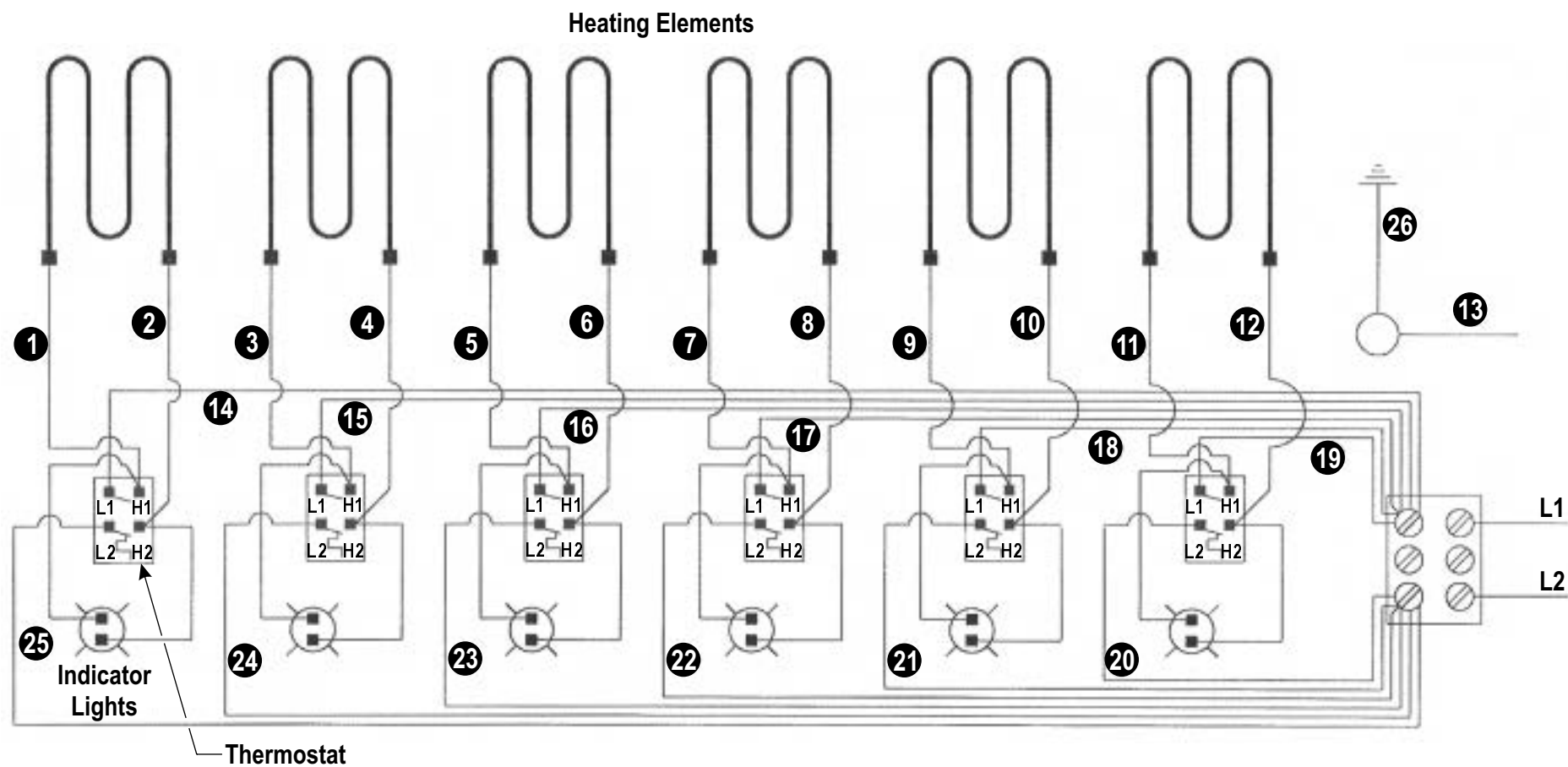

8. PARTS LIST & EXPLODED VIEW

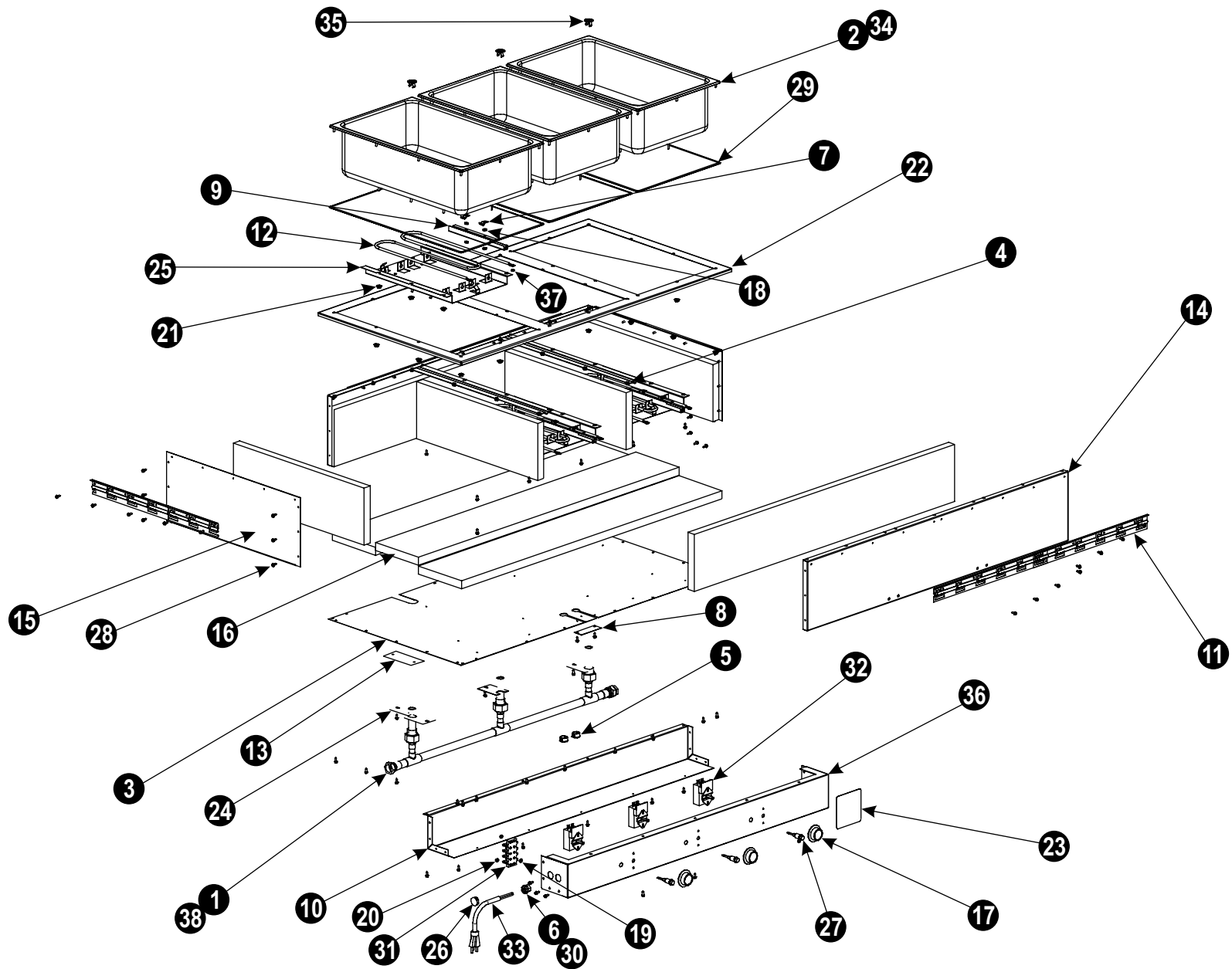

Item	Part No.	Description	Item	Part No.	Description
1	56186	2 Well Manifold Assy.	17	56505	Knob, Black Plain (1-10)
	56185	3 Well Manifold Assy.	18	89061	Nut, Hex 10-24
	56184	4 Well Manifold Assy.	19	88961	Nut, Hex 10-24, Green
	56183	5 Well Manifold Assy.	20	89054	Nut, KEPS 6-32
	56182	6 Well Manifold Assy.	21	89025	Nut, Speed 10-24 PAL Zinc
2	56037	600 Well Pan w/Drain Weld Assy.	22	56206	Plate, Base 2-Well
3	70107004	Bottom Cover, 2 Well		56351	Plate, Base 3-Well
	70107030	Bottom Cover, 3 Well		56377	Plate, Base 4-Well
	70107040	Bottom Cover, 4 Well		55023	Plate, Base 5-Well
	70107050	Bottom Cover, 5 Well		56166	Plate, Base 6-Well
	70107060	Bottom Cover, 6 Well	23	56542	Plate, Dial-Wells
4	56067	Brace, Well Runner	24	56388	Plate, Hole Cover (-3-4-5)
5	89184	Bushing, .875 Heyco 2126	25	56506	Plate, Reflector
6	89111	Bushing, Strain Relief SR-7W-2 (-2,-3)	26	89116	Plug, "DD" .875
	89114	Bushing, Strain Relief SR8P-2 (-2,-3,-4,-5,-6)		89119	Plug, IPW 1 (-6) 240V
7	89120	Clip, Jiffy	27	56536	S/A, Pilot Light w/Leads, Amber
8	70107026	Cover, Bottom Slot	28	89073	Screw, #8 x 1/2 Hex Tapit Sht Mtl Type AB
9	56039	Cover, Capillary	29	55789	Sealant, GS7500, 6.5 Ft. Lg.
10	70107003	Cover, Control 2-Well	30	94000129	Strain Relief, 10/3 AWG
	70107032	Cover, Control 3-Well	31	30201	Terminal Block, 600V, 50 Amp
	70107042	Cover, Control 4-Well	32	56527	Thermostat, 550° F, 36" Cap.
	70107052	Cover, Control 5-Well		56540	Thermostat, Model 550° F (-5) 240V
	70107062	Cover, Control 6-Well	33	55952	Twist Lock Cordset 12/3, 600V (-3-4)240V
11	55308	E-Z Lock, 6 Tab		55950	Twist Lock Cordset (-4, -5, -6)
12	54054	Element, 120V, 850W (-2)		55951	Twist Lock Cordset 10 GA, 600V (-6)
	54062	Element, 240V, 850W (-2,-3,-4,-5,-6)		55310	Cordset 14/3 600V .440 Dia HSJO 5-20P (-2) 120V
	54061	Element, 208V, 850W (-2,-3,-4,-5,-6)		85640	Cordset 14/3 600V .440 Dia HSJO 6-20P (-2-3) 208/240V
13	70107005	Hole Cover Housing (-2, -3)	34	54518	W/Assy, 600 Well Pan (-2-3-4-5-6)
14	56180	Housing, Front & Back (-2)	35	56655	W/Assy, Drain Strainer
	56177	Housing, Front & Back (-3)	36	70107002	W/Assy, Box, Control 2-Well
	56174	Housing, Front & Back (-4)		70107033	W/Assy, Box, Control 3-Well
	56171	Housing, Front & Back (-5)		70107043	W/Assy, Box, Control 4-Well
	56170	Housing, Front & Back (-6)		70107053	W/Assy, Box, Control 5-Well
15	56050	Housing, End		70107063	W/Assy, Box, Control 6-Well
16	60150	Insulation	37	89059	Washer #10 External Lock

9. APW WYOTT EQUIPMENT LIMITED WARRANTY

APW Wyott Foodservice Equipment Company warrants its equipment against defects in materials and workmanship, subject to the following conditions:

This warranty applies to the original owner only and is not assignable.

Should any product fail to function in its intended manner under normal use within the limits defined in this warranty, at the option of APW Wyott such product will be repaired or replaced by APW Wyott or its Authorized Service Agency. APW Wyott will only be responsible for charges incurred or service performed by its Authorized Service Agencies. The use of other than APW Wyott Authorized Service Agencies will void this warranty and APW Wyott will not be responsible for such work or any charges associated with same. The closest APW Wyott Authorized Service Agent must be used.

This warranty covers products shipped into the 48 contiguous United States, Hawaii, metropolitan areas of Alaska and Canada. There will be no labor coverage for equipment located on any island not connected by roadway to the mainland.

Warranty coverage on products used outside the 48 contiguous United States, Hawaii, and metropolitan areas of Alaska and Canada may vary. Contact the international APW Wyott distributor, dealer, or service agency for details.

Time Period

One year for parts and one year for labor, effective from the date of purchase by the original owner. The Authorized Service Agency may, at their option, require proof of purchase. Parts replaced under this warranty are warranted for the un-expired portion of the original product warranty only.

Exceptions

- ***Gas/Electric Cookline:** Models GCB, GCRB, GF, GGM, GGT, CHP-H, EF, EG, EHP. Three (3) Year Warranty on all component parts, except switches and thermostats. (2 additional years on parts only. No labor on second or third year.)
- ***Broiler Briquettes, Rock Grates, Cooking Grates, Burner Shields, Fireboxes:** 90 Day Material Only. No Labor
- ***Heat Strips:** Models FD, FDL, FDD, FDDL. Two (2) Year Warranty on element only. No labor second year.
- ***Glass Windows, Doors, Seals, Rubber Seals, Light Bulbs:** 90 Day Material Only. No Labor.

In all cases, parts covered by extended warranty will be shipped FOB the factory after the first year.

Portable Carry In Products

Equipment weighing over 70 pounds or permanently installed will be serviced on-site as per the terms of this warranty. Equipment weighing 70 pounds or under, and which is not permanently installed, i.e. with cord and plug, is considered portable and is subject to the following warranty handling limitations. If portable equipment fails to operate in its intended manner on the first day of connection, or use, at APW Wyott's option or its Authorized Service Agency, it will be serviced on site or replaced.

From day two through the conclusion of this warranty period, portable units must be taken to or sent prepaid to the APW Wyott Authorized Service Agency for in-warranty repairs. No mileage or travel charges are allowed on portable units after the first day of use. If the customer wants on-site service, they may receive same by paying the travel and mileage charges. Exceptions to this rule: (1) countertop warmers and cookers, which are covered under the Enhanced Warranty Program, and (2) toasters or rollergrills which have in store service.

Exclusions

The following conditions are not covered by warranty:

- *Equipment failure relating to improper installation, improper utility connection or supply and problems due to ventilation.
- *Equipment that has not been properly maintained, calibration of controls, adjustments, damage from improper cleaning and water damage to controls.
- *Equipment that has not been used in an appropriate manner, or has been subject to misuse or misapplication, neglect, abuse, accident, alteration, negligence, damage during transit, delivery or installation, fire, flood, riot or act of god.
- *Equipment that has the model number or serial number removed or altered.

If the equipment has been changed, altered, modified or repaired by other than an Authorized Service Agency during or after the warranty period, then the manufacturer shall not be liable for any damages to any person or to any property, which may result from the use of the equipment thereafter.

This warranty does not cover services performed at overtime or premium labor rates. Should service be required at times which normally involve overtime or premium labor rates, the owner shall be charged for the difference between normal service rates and such premium rates. APW Wyott does not assume any liability for extended delays in replacing or repairing any items beyond its control.

In all cases, the use of other than APW Wyott Authorized OEM Replacement Parts will void this warranty.

This equipment is intended for commercial use only. Warranty is void if equipment is installed in other than commercial application.

Water Quality Requirements

Water supply intended for a unit that has in excess of 3.0 grains of hardness per gallon (GPG) must be treated or softened before being used. Water containing over 3.0 GPG will decrease the efficiency and reduce the operation life of the unit.

Note: Product failure caused by liming or sediment buildup is not covered under warranty.

"THE FOREGOING WARRANTY IS IN LIEU OF ANY AND ALL OTHER WARRANTIES EXPRESSED OR IMPLIED INCLUDING ANY IMPLIED WARRANTY OF MERCHANTABILITY OR FITNESS FOR PARTICULAR PURPOSES AND CONSTITUTES THE ENTIRE LIABILITY OF APW WYOTT. IN NO EVENT DOES THE LIMITED WARRANTY EXTEND BEYOND THE TERMS STATED HEREIN."

9/05



Phone: (214) 421-7366
Fax: (214) 565-0976
Toll Free: (800) 527-2100
Website: www.apwwyott.com
E-mail: info@apwwyott.com

APW WYOTT
729 Third Avenue
Dallas, TX 75226