

BEVERAGE-AIR

SP/DP/UC/WT
SPD/WTRD/UCRD



PARTS

MANUAL

115V/60HZ & 220V/50HZ

ILLUSTRATIONS 29' BASE REFRIGERATORS
CABINET COMPONENTS

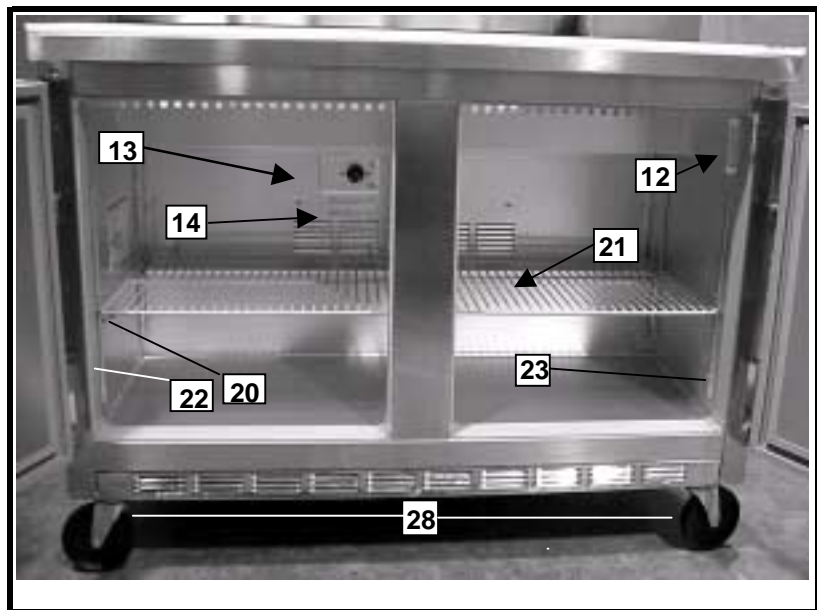
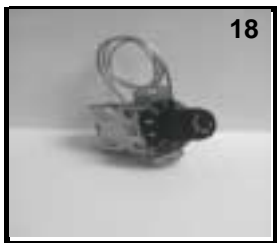
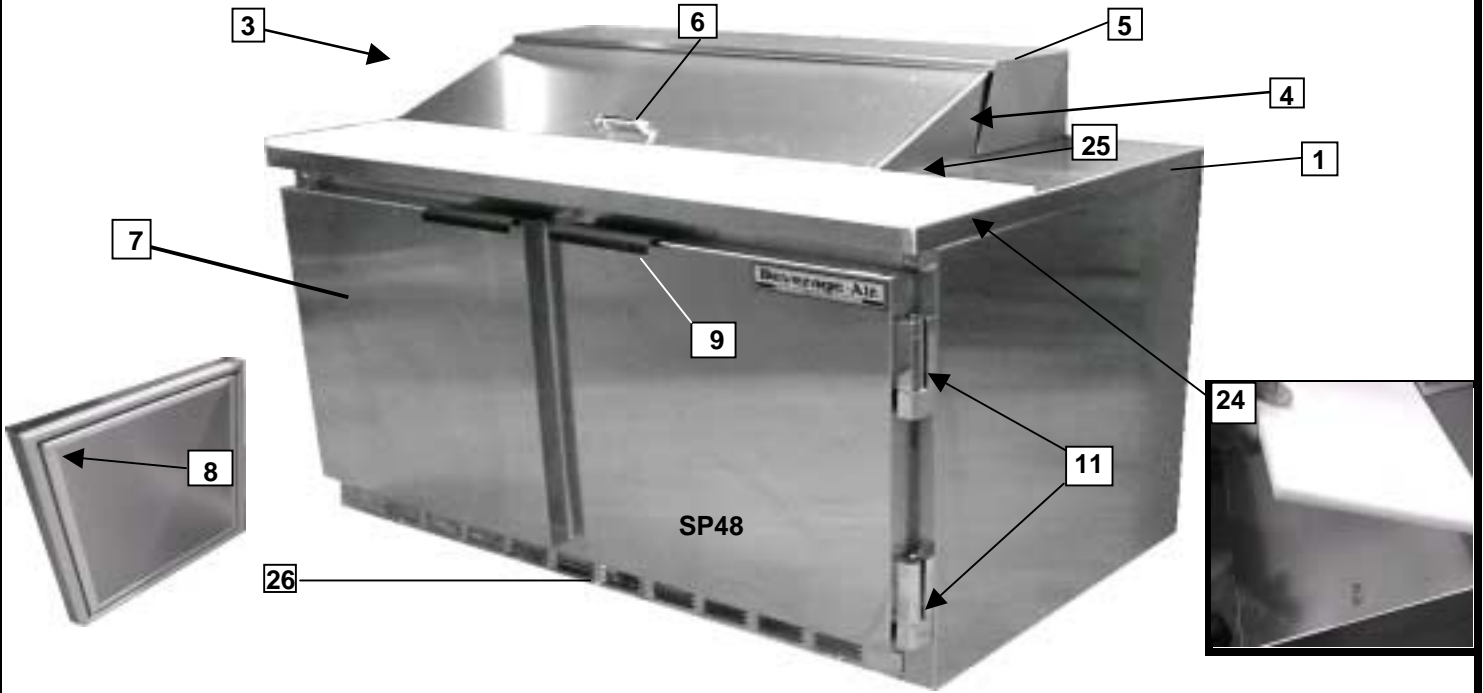
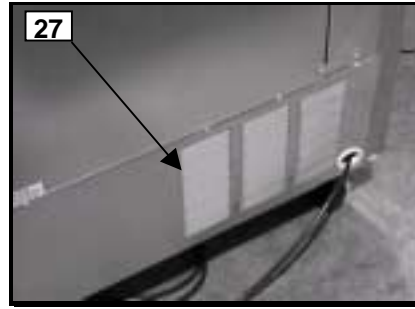
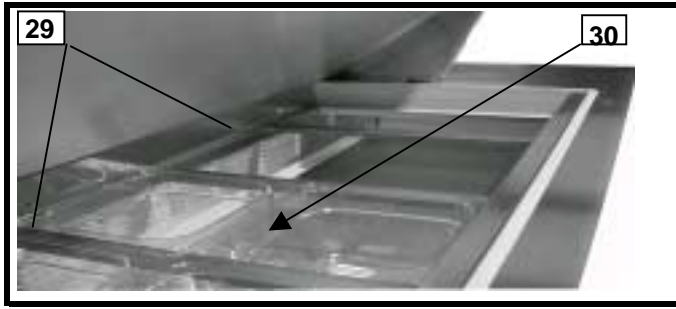

TOP ASSEMBLES

29" BASE REFRIGERATORS

| ITEM | MODEL | DESCRIPTION | PART NUMBER |
|-------------|--------------------------|--------------------------|---------------|
| 1 | SP27/SP27-16 | TOP ASSY. COMPLETE | 01B35-254C-01 |
| | SP27C | TOP ASSY. COMPLETE | 01B35-255C-01 |
| | SP27-12M | TOP ASSY. COMPLETE | 01B35-246C-01 |
| | SP48-08 | TOP ASSY. COMPLETE | 01B35-256D-01 |
| | SP48-08C | TOP ASSY. COMPLETE | 01B35-259D-01 |
| | SP48-10 | TOP ASSY. COMPLETE | 01B35-257D-01 |
| | SP48-10C | TOP ASSY. COMPLETE | 01B35-260D-01 |
| | SP48-12 | TOP ASSY. COMPLETE | 01B35-258D-01 |
| | SP48-12C | TOP ASSY. COMPLETE | 01B35-261D-01 |
| | SP48-12M | TOP ASSY. COMPLETE | 01B35-262D-01 |
| | SP48-18M | TOP ASSY. COMPLETE | 01B35-247D-01 |
| | SP60-08 | TOP ASSY. COMPLETE | 01B35-263D-01 |
| | SP60-12 | TOP ASSY. COMPLETE | 01B35-265D-01 |
| | SP60-12M | TOP ASSY. COMPLETE | 01B35-271D-01 |
| | SP60-16 | TOP ASSY. COMPLETE | 01B35-266D-01 |
| | SP60-18M | TOP ASSY. COMPLETE | 01B35-272D-01 |
| | SP60-24M | TOP ASSY. COMPLETE | 01B35-248D-01 |
| | SP72-08 | TOP ASSY. COMPLETE | 01B35-273D-01 |
| | SP72-08C | TOP ASSY. COMPLETE | 01B35-277D-01 |
| | SP72-10 | TOP ASSY. COMPLETE | 01B35-274D-01 |
| | SP72-10C | TOP ASSY. COMPLETE | 01B35-278D-01 |
| | SP72-12 | TOP ASSY. COMPLETE | 01B35-275D-01 |
| | SP72-12C | TOP ASSY. COMPLETE | 01B35-279D-01 |
| | SP72-12M | TOP ASSY. COMPLETE | 01B35-281D-01 |
| | SP72-18 | TOP ASSY. COMPLETE | 01B35-276D-01 |
| | SP72-18M | TOP ASSY. COMPLETE | 01B35-282D-01 |
| | SP72-18C | TOP ASSY. COMPLETE | 01B35-280D-01 |
| | SP72-24M | TOP ASSY. COMPLETE | 01B35-283D-01 |
| | SP72-30M | TOP ASSY. COMPLETE | 01B35-249D-01 |
| | UCR27A | TOP ASSY. COMPLETE | 01B35-250C-04 |
| | UCR48A | TOP ASSY. COMPLETE | 01B35-251C-04 |
| | UCR60A | TOP ASSY. COMPLETE | 01B35-252D-04 |
| | UCR72A | TOP ASSY. COMPLETE | 01B35-253D-04 |
| | WTR27A | TOP ASSY. COMPLETE | 01B35-284C-04 |
| WTR48A | TOP ASSY. COMPLETE | 01B35-285D-04 | |
| WTR60A | TOP ASSY. COMPLETE | 01B35-286D-04 | |
| WTR72A | TOP ASSY. COMPLETE | 01B35-287D-04 | |
| *2 | WTR27-A | SPLASH BOARD | 01B36-010B |
| | WTR48A | SPLASH BOARD | 01B36-011B |
| 3 | SP27/-16/16C/SPD27 | TOP COVER ASSY. | 01B36-082A-01 |
| | SP27-12M | TOP COVER ASSY. | 01B36-069C-01 |
| | SP48-08/08C | TOP COVER ASSY. | 01B36-084A-03 |
| | SP48-10/10C | TOP COVER ASSY. | 01B36-084A-02 |
| | SP48-12/12C | TOP COVER ASSY. | 01B36-084A-01 |
| | SP48-12M | TOP COVER ASSY. | 01B36-074A-02 |
| | SP48-18M | TOP COVER ASSY. | 01B36-074A-01 |
| | SP60-08 | TOP COVER ASSY. | 01B36-084A-03 |
| | SP60-12 | TOP COVER ASSY. | 01B36-085A-02 |
| | SP60-12M | TOP COVER ASSY. | 01B36-073A-01 |
| | SP60-16 | TOP COVER ASSY. | 01B36-085A-01 |
| | SP60-16 (AFTER #5006876) | (SINGLE) TOP COVER ASSY. | 01B36-113A-01 |
| | SP60-18M | TOP COVER ASSY. | 01B36-074A-01 |
| | SP60-24M | TOP COVER ASSY. | 01B36-075A-01 |
| SP72-08/08C | TOP COVER ASSY. | 01B36-085A-04 | |

* Indicates part not illustrated

1/28/2000

ILLUSTRATIONS 34" BASE REFRIGERATORS
CABINET COMPONENTS

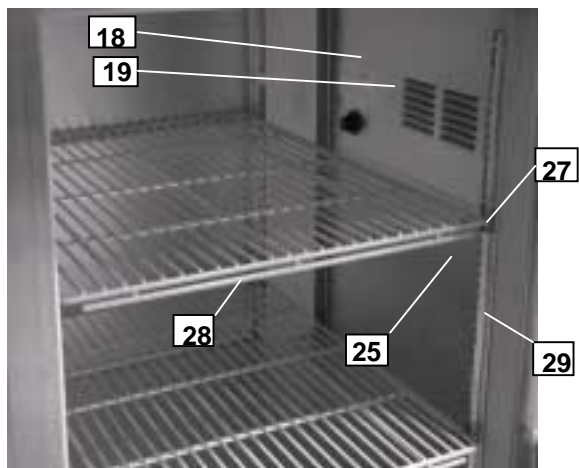
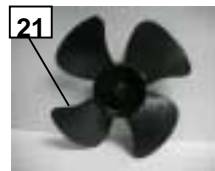
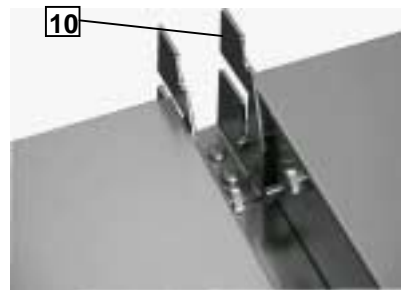
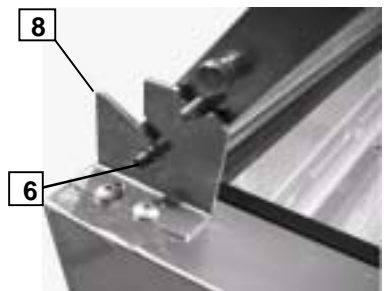
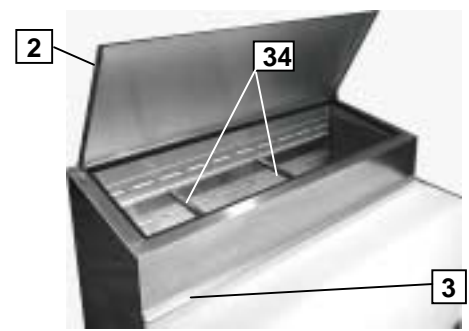

TOP ASSEMBLES
34" BASE REFRIGERATORS

| ITEM | MODEL | DESCRIPTION | PART NUMBER |
|---------|--------------------|-----------------------------|---------------|
| 1 | DP41 | TOP ASSY. COMPLETE | 03B01-170D-01 |
| | WTR41 | TOP ASSY. COMPLETE | 03B01-106D |
| | UCR41 | TOP ASSY. COMPLETE | 01B35-184C |
| | DP46 | TOP ASSY. COMPLETE | 03B01-179D-01 |
| | WTR46A | TOP ASSY. COMPLETE | 03B01-181D-02 |
| | UCR46A | TOP ASSY. COMPLETE | 01B35-290C-06 |
| | UCR48A | TOP ASSY. COMPLETE | 01B35-251C-04 |
| | WTR48A | TOP ASSY. COMPLETE | 04B02-176C-02 |
| | DP67 | TOP ASSY. COMPLETE | 03B01-172D-01 |
| | WTR67A | TOP ASSY. COMPLETE | 04B02-171C-01 |
| | UCR67A | TOP ASSY. COMPLETE | 01B35-190C |
| | DP93 | TOP ASSY. COMPLETE | 03B01-174D-01 |
| | WTR93A | TOP ASSY. COMPLETE | 03B01-108D |
| | UCR93A | TOP ASSY. COMPLETE | 01B35-196C |
| | DP119 | TOP ASSY. COMPLETE | 03B01-176D-01 |
| WTR119A | TOP ASSY. COMPLETE | 03B01-109D | |
| UCR119A | TOP ASSY. COMPLETE | 01B35-202C | |
| 2 | DP41 | LID ASSY. (1 NEEDED) | 03B04-018D-01 |
| | DP46 | LID ASSY.(1 NEEDED) | 03B04-024D-01 |
| | DP67 | LID ASSY. (SHORT) | 03B04-024D-02 |
| | | LID ASSY.(LONG) | 03B04-024D-03 |
| | DP93 | LID ASSY. (LONG) (2 NEEDED) | 03B04-024D-03 |
| | DP119 | LID ASSY. (LONG) (2 NEEDED) | 03B04-024D-03 |
| | | LID ASSY.(SHORT) (1 NEEDED) | 03B04-024D-04 |
| 3 | ALL | LID HANDLE | 401-201A |
| | *ALL | LID HANDLE SCREW | 603-340A |
| 4 | ALL DP | HINGE BRACKET PLATE(RH) | 03B03-019B |
| 5 | ALL DP | HINGE BRACKET PLATE(LH) | 03B03-020B |
| 6 | ALL DP | HINGE PIN | 604-196A |
| *7 | ALL DP | INSERT #10-32 LOW HEAD | 604-161A |
| 8 | ALL DP | TOP COVER HINGE (L.H.) | 03A07-022C-04 |
| 9 | ALL DP | TOP COVER HINGE (R.H.) | 03A07-021C-04 |
| 10 | DP67/93/119 | TOP COVER HINGE (CENTER) | 03A07-023C-04 |

DOOR ASSEMBLES
34" BASE REFRIGERATORS

| ITEM | MODEL | DESCRIPTION | PART NUMBER |
|------|----------------|-------------------------------|-------------|
| 11 | ALL DP/UC/WT-A | DOOR ASSEMBLY COMPLETE | 02B01-257C |
| 12 | ALL DP/UC/WT-A | DOOR GASKET (23-1/8X25-1/8) | 703-963D-05 |
| 13 | ALL DP/UC/WT-A | DOOR HANDLE | 401-506C |
| *14 | ALL DP/UC/WT-A | DOOR HANDLE SCREWS | 603-338A |
| 15 | ALL DP/UC/WT-A | DOOR HINGE (TOP/BOTTOM/LH&RH) | 401-657B |
| 16 | ALL DP/UC/WT-A | HINGE COVER | 401-244B |
| *17 | ALL DP/UC/WT-A | HINGE PIVOT CAM (NYLON) | 401-242B |

ILLUSTRATIONS FOR UNDER COUNTER & WORK TOP FREEZERS
CABINET COMPONENTS

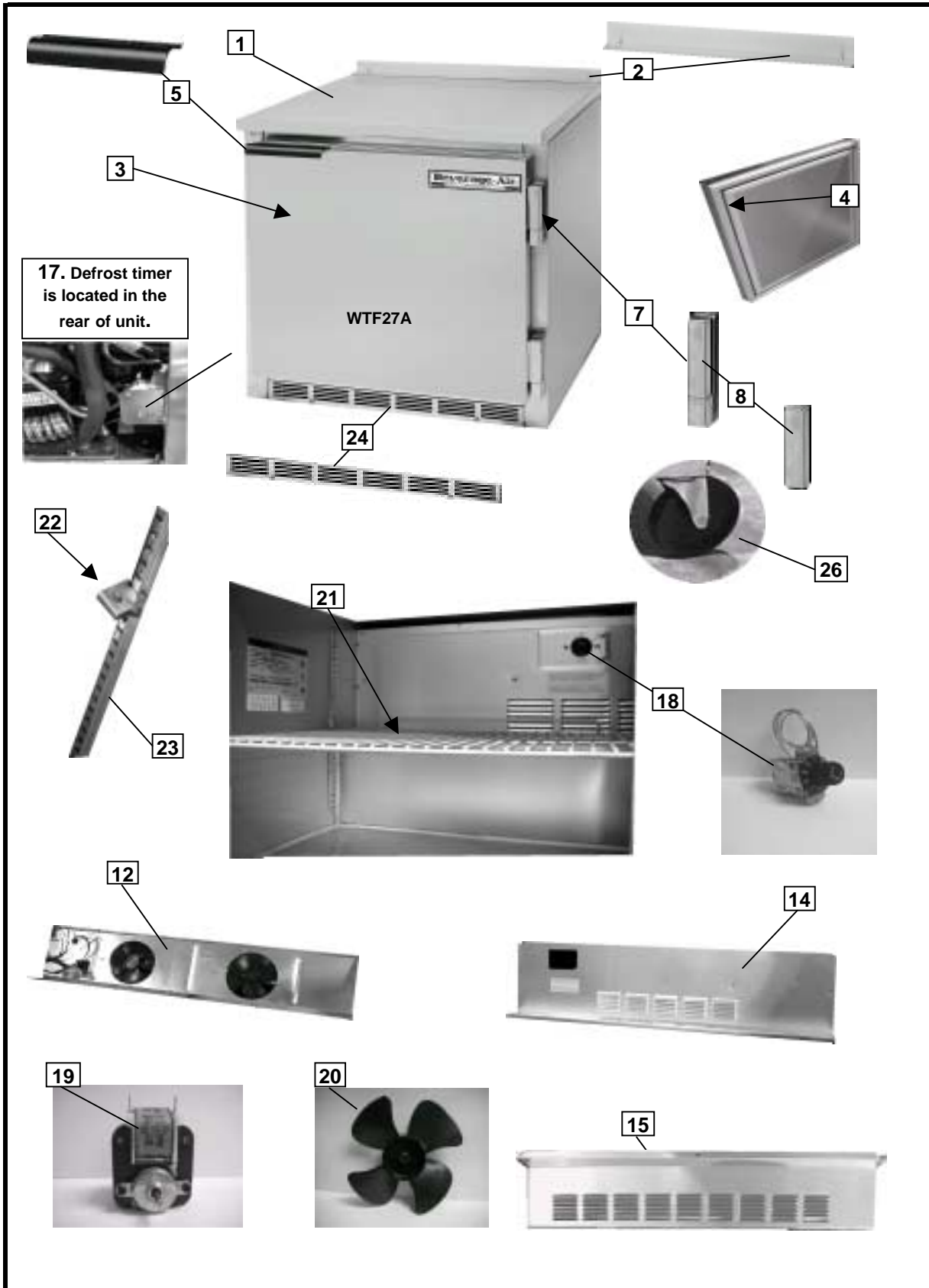

CABINET COMPONENTS UNDER COUNTER & WORK TOP FREEZERS

| ITEM | MODEL | DESCRIPTION | PART NUMBER |
|------|------------|--------------------|---------------|
| 1 | UCF/WTF27A | TOP ASSY. COMPLETE | 01B35-284C-04 |
| | UCF/WTF48A | TOP ASSY. COMPLETE | 01B35-285D-04 |
| | UCF/WTF67 | TOP ASSY. COMPLETE | 03B01-107D |
| 2 | UCF/WTF27A | SPLASH BOARD ASSY. | 01B36-010B |
| | UCF/WTF48A | SPLASH BOARD ASSY. | 01B36-011B |

DOOR ASSEMBLES UNDER COUNTER & WORK TOP FREEZERS

| ITEM | MODEL | DESCRIPTION | PART NUMBER |
|------|---------------|-------------------------------|-------------|
| 3 | UCF/WTF27A | D00R ASSEMBLY COMPLETE | 02B01-249C |
| | UCF/WTF48A | D00R ASSEMBLY COMPLETE | 02B01-253C |
| | UCF/WTF67 | D00R ASSEMBLY COMPLETE | 02B01-257C |
| 4 | UCF/WTF27A | DOOR GASKET (23-18X24-1/2) | 703-963D-02 |
| | UCF/WTF48A | DOOR GASKET (21-1/16X23-1/8) | 703-963D-03 |
| | UCF/WTF67 | DOOR GASKET (23-1/8X25-1/8) | 703-963D-05 |
| 5 | UCF/WTF27/48A | DOOR HANDLE | 401-506C |
| *6 | UCF/WTF27/48A | DOOR HANDLE SCREWS | 603-338A |
| 7 | UCF/WTF27/48A | DOOR HINGE (TOP/BOTTOM/LH&RH) | 401-657B |
| 8 | UCF/WTF27/48A | HINGE COVER | 401-244B |
| *9 | UCF/WTF27/48A | HINGE PIVOT CAM (NYLON) | 401-242B |
| *10 | UCF/WTF27/48A | THERMOMETER | 402-233B |
| *11 | UCF/WTF27A&67 | FACE HEATER | 504-247B |
| | UCF/WTF48A | FACE HEATER | 504-248B |

EVAPORATOR HOUSINGS UNDER COUNTER & WORK TOP FREEZERS

| ITEM | MODEL | DESCRIPTION | PART NUMBER |
|--|---------------|------------------------|---------------|
| 12 | UCF/WTF27/48A | EVAP. HOUSING ASSY. | 04B01-076D-02 |
| | UCF/WTF27/48A | EVAP HSG. ONLY | 04A02-356D-09 |
| *13 | UCF/WTF67 | EVAP.FAN MOUNT ASSY. | 04B04-036C |
| 14 | UCF/WTF67 | EVAP.FRT.COVER ASSY. | 04B04-043C |
| | UCF/WTF27/48A | EVAP.FRT.COVER ASSY. | 04B02-175D-04 |
| 15 | ALL UCF/WTF | EVAP. TOP COVER | 28D47-040D-10 |
| Note: UCF/WTF/27/48A units have the evaporator pans incorporated into the cabinet and are not replaceable. After serial number 5100521 | | | |
| *16 | UCF/WTF67 | PAN ASSY - EVAP | 04B02-171C-01 |
| 17 | UCF/WTF27/48A | DEFROST TIMER | 502-171A |
| | UCF/WTF67 | DEFROST TIMER | 502-233A |
| 18 | UCF/WTF27/48A | TEMP. CONTROL | 502-111A |
| | UCF/WTF67 | TEMP. CONTROL | 502-150A |
| 19 | ALL UCF/WTF | EVAPORATOR MOTOR | 501-105B |
| 20 | ALL UCF/WTF | EVAPORATOR MOTOR BLADE | 405-063A |

ILLUSTRATIONS SPD/UCRD/WTRD/UCR UNITS
CABINET COMPONENTS

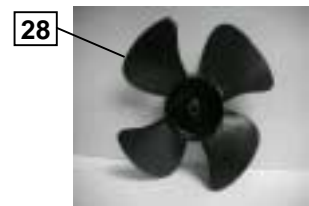
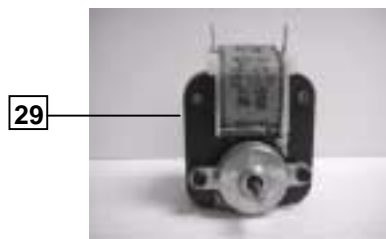
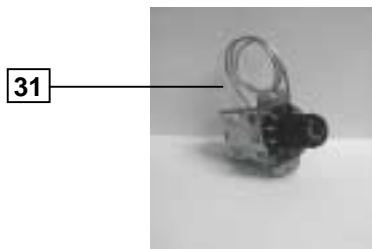
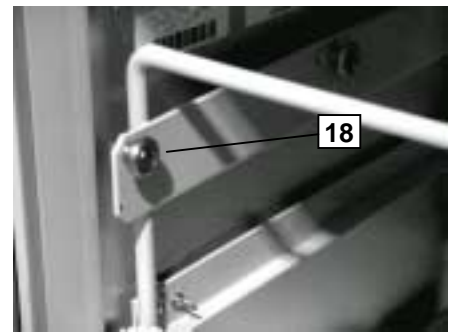
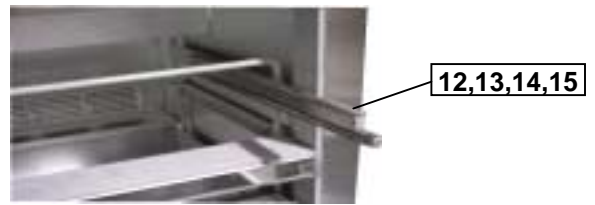
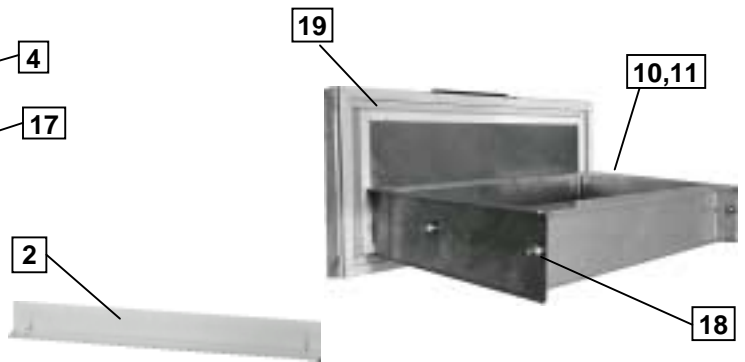
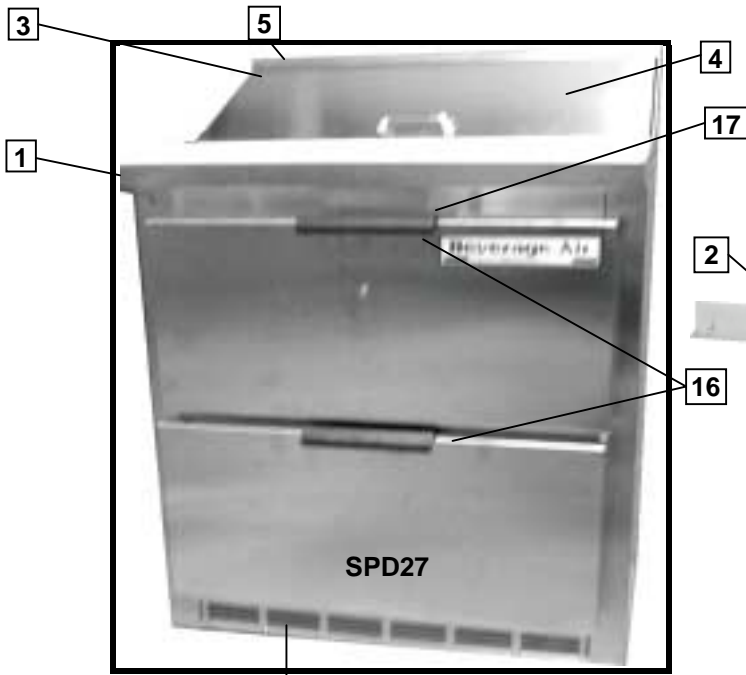
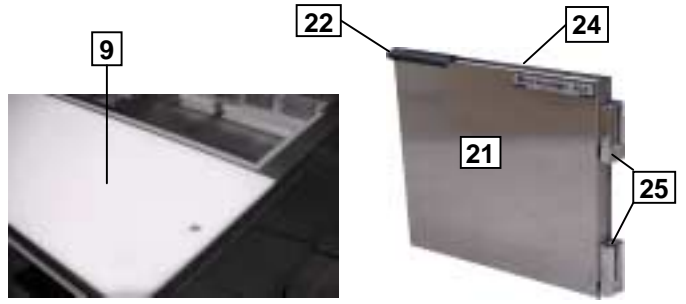

TOP ASSEMBLES
SPD/UCRD/WTRD27/UCR20/34

| ITEM | MODEL | DESCRIPTION | PART NUMBER |
|------|----------|---------------------------|---------------|
| 1 | SPD27 | TOP ASSY. COMPLETE | 01B35-254C-01 |
| | UCRD27-A | TOP ASSY. COMPLETE | 01B35-250C-04 |
| | WTRD27-A | TOP ASSY. COMPLETE | 01B35-284C-04 |
| | UCR20 | TOP ASSY. COMPLETE | 01B35-237C-06 |
| | UCR34 | TOP ASSY. COMPLETE | 01B35-214C |
| 2 | WTRD27-A | SPLASH BOARD | 01B36-010B |
| 3 | SPD27 | TOP COVER ASSY. | 01B36-082A-01 |
| 4 | SPD27 | TOP COVER (LID) | 01B40-002D-01 |
| 5 | SPD27 | SERVING BAR (LID HOUSING) | 01B36-093C-01 |
| 6 | SPD27 | PAN SUPPORTS (3 NEEDED) | 28D40-056C-05 |
| 7 | SPD27 | PAN 1/6 4 DEEP PLASTIC | 403-490C |
| 8 | | PAN 1/9 4 DEEP PLASTIC | 403-493C |
| 9 | SPD27 | CUTTING BOARD (10") | 705-290C-01 |

DRAWER ASSEMBLES
SPD/UCRD/WTRD27 ONLY

| ITEM | MODEL | DESCRIPTION | PART NUMBER |
|------|---------------------|--------------------------|---------------|
| 10 | SPD27/UCRD WTRD27-A | DRAWER ASSY -COMP TOP | 00B27-089D-02 |
| 11 | SPD27/UCRD WTRD27-A | DRAWER ASSY -COMP BOT | 00B27-088D-02 |
| 12 | SPD27/UCRD WTRD27-A | RAIL ASSY - SLIDE LH | 00B27-072C-01 |
| 13 | SPD27/UCRD WTRD27-A | RAIL ASSY - SLIDE RH | 00B27-072C-02 |
| 14 | SPD27/UCRD WTRD27-A | SLIDE RAIL ASSY-BOT LH | 00B27-086C-01 |
| 15 | SPD27/UCRD WTRD27-A | SLIDE RAIL ASSY-BOT RH | 00B27-086C-02 |
| 16 | SPD27/UCRD WTRD27-A | DRAWER HANDLE | 401-506C |
| 17 | SPD27/UCRD WTRD27-A | DRAWER HANDLE SCREWS | 603-408A |
| 18 | SPD27/UCRD WTRD27-A | DRAWER ROLLERS | 403-513A |
| 19 | SPD27/UCRD WTRD27-A | DRAWER GASKET | 703-963D-15 |
| 20 | SPD27/UCRD WTRD27-A | PAN SUPPORTS FOR DRAWERS | 00A27-057B-04 |

220V/50HZ SECTION COMPRESSORS

| ITEM | MODEL | DESCRIPTION | PART NUMBER |
|------|---|---|-------------|
| 1 | SP27/UCR WTR27-A DP/UCR/WTR46/67-A SPD/UCRD/WTRD27 UCR20 | COMPRESSOR 1/6HP 220-50 SIC AZ0370Y | 302-952B |
| | SP48/UCR48 WTR48-A DP/UCR/WTR93/119-A UCR34 | COMPRESSOR 1/5HP 220-50 SIC AZA0395YXC | 302-828B |
| | SP60/UCR60A WTR60A SP72/UCR72 WTR72A | COMPRESSOR 1/4HP 220-50 SIC AEA3430YXC | 302-648B |
| | UCF/WTF27/48-A | COMPRESSOR 1/4HP 220-50 TEC AE2380Z | 302-946B |

OVERLOADS

| ITEM | MODEL | DESCRIPTION | PART NUMBER |
|------|---|---------------------|-------------|
| 2 | SP27/UCR WTR27-A DP/UCR/WTR46/67-A SPD/UCRD/WTRD27 UCR20 | (TI) 4TM232NFBYY-53 | 302-971A |
| | SP48/UCR48 WTR48-A DP/UCR/WTR93/119-A UCR34 | (TI)4TM739JDBYY-51 | 302-941A |
| | SP60/UCR60A WTR60A SP72/UCR72 WTR72A | (TI) MRP 59 AMK-69 | 302-838A |
| | UCF/WTF27/48-A | (TI)MRP61AMN-69 | 313-002A |

RELAYS

| ITEM | MODEL | DESCRIPTION | PART NUMBER |
|------|---|-----------------|-------------|
| 3 | SP27/UCR WTR27-A DP/UCR/WTR46/67-A SPD/UCRD/WTRD27 UCR20 | (TI) 8EA203 | 302-972A |
| | SP48/UCR48 WTR48-A DP/UCR/WTR93/119-A UCR34 | (TI)8EA203 | 302-940A |
| | SP60/UCR60A WTR60A SP72/UCR72 WTR72A | (TEC)8200EMBE64 | 314-010A |
| | UCF/WTF27/48-A | (TEC)8200EMBJ49 | 314-001A |

START CAPACITORS

| ITEM | MODEL | DESCRIPTION | PART NUMBER |
|------|----------------|---------------------------|-------------|
| 4 | UCF/WTF27/48-A | START CAP (TEC)855S220C66 | 315-002A |
| | UCF/WTF27/48-A | CAP/RELAY ASSY | 317-002A |

EVAPORATOR FAN MOTORS

| ITEM | MODEL | DESCRIPTION | PART NUMBER |
|------|-------|-----------------|-------------|
| 5 | ALL | .40 AMPS 220-50 | 501-087B |

CONDENSER FAN MOTORS

| ITEM | MODEL | DESCRIPTION | PART NUMBER |
|------|-------|-------------------|-------------|
| 6 | ALL | 5 WATTS 230-50/60 | 501-055B |

Note* All other parts will be the same as standard units located in the first portion of this manual.

DOOR ASSEMBLES UCR20/34 ONLY

| ITEM | MODEL | DESCRIPTION | PART NUMBER |
|------|----------|---------------------------|-------------|
| 21 | UCR20 | DOOR ASSY.COMP. | 02B01-241C |
| | UCR34 | DOOR ASSY.COMP. | 02B01-245C |
| 22 | UCR20/34 | DOOR HANDLE | 401-506C |
| 23 | UCR20/34 | DOOR HANDLE SCREWS | 603-364A |
| 24 | UCR20 | DOOR GASKET | 703-963D-11 |
| | UCR34 | DOOR GASKET | 703-963D-01 |
| 25 | UCR20/34 | DOOR HINGE (TOP & BOTTOM) | 401-657B |

EVAPORATOR ASSEMBLES SPD/UCRD/WTRD27/UCR20/34

| ITEM | MODEL | DESCRIPTION | PART NUMBER |
|------|---------------------------------|---|---------------|
| 26 | SPD27/UCRD WTRD27-A | HSG ASSY-EVAP | 04B01-076D-02 |
| | UCR20 | HSG ASSY-EVAP | 04B01-056D |
| | UCR34 | HSG ASSY-EVAP | 04B01-066D-02 |
| 27 | SPD27/UCRD WTRD27-A | COVER ASSY - EVAP | 04B02-175D-02 |
| | UCR20 | EVAP.HSG.FRT.GRL.ASSY | 04B02-102C |
| | UCR34 | EVAP.FRT.GRILLE ASSY | 04B02-091C |
| 28 | SPD27/UCRD WTRD27-A UCR20/34 | EVAP. FAN BLADE | 405-063A |
| 29 | SPD27/UCRD WTRD27-A UCR20/34 | EVAP. FAN MOTOR | 501-105B |
| 30 | ALL | EVAP. MOTOR BRCKET | 42A37P011B |
| 31 | SPD27/UCRD WTRD27-A | TEMP. CONTROL | 502-269A |
| | UCR20 | TEMP. CONTROL | 502-205A |
| | UCR34 | TEMP. CONTROL | 502-236A |
| 32 | SPD27/UCRD WTRD27 | EVAPORATOR PANS ARE INCORPORATED INTO THE CABINET & ARE NOT REPLACEABLE AFTER SERIAL #5100521 | NA |
| | UCR20 | EVAP. DRAIN PAN | 04B02-101C |
| | UCR34 | EVAP. DRAIN PAN | 04B02-090C |
| 33 | ALL | THERMOMETER - HORIZ PUSH-IN | 402-223B |

SHELVES UCR20/34 ONLY

| ITEM | MODEL | DESCRIPTION | PART NUMBER |
|------|----------|------------------------------|-------------|
| 34 | UCR20 | SHELF 12.13X15.3812.13X15.38 | 403-419D |
| | UCR24 | SHELF 11X29.38 | 403-339D |
| 35 | UCR20/34 | SHELF CLIPS | 403-169A |
| 36 | UCR20/34 | PILASTER 27/48 15" | 403-154A |
| 37 | UCR20/34 | PILASTER 10" | 403-307A |
| 38 | ALL | CASTER KIT | 00C31-038A |

GRILLS SPD/UCRD/WTRD27/UCR20/34

| ITEM | MODEL | DESCRIPTION | PART NUMBER |
|------|---------------------|--------------------|---------------|
| 39 | SPD27/UCRD WTRD27-A | GRILLE ASSY -FRONT | 07B31-061B |
| | UCR20 | GRILLE ASSY -FRONT | 07B31-062C |
| | UCR34 | GRILLE ASSY -FRONT | 07B31-051C |
| 40 | SPD27/UCRD WTRD27-A | GRILLE - REAR | 28D37-090D-03 |
| | UCR20 | GRILLE - REAR | 28D37-054D |
| | UCR34 | GRILLE - REAR | 28D37-052D |

REFRIGERATION

SPD/UCRD/WTRD27UCR20/34

| ITEM | MODEL | DESCRIPTION | PART NUMBER |
|------|--------------------------------|---|---------------|
| 1 | SPD27/UCRD WTRD27 | REFRIGERATION ASSEMBLY | 19B36-086D-01 |
| | UCR20 | REFRIGERATION ASSEMBLY | 19C30-091C |
| | UCR34 | REFRIGERATION ASSEMBLY | 19C30-089C |
| 2 | SPD27/UCRD WTRD27 | CONDENSING UNIT | 15B33-045C |
| | UCR20 | CONDENSING UNIT | 15B33-063C |
| | UCR34 | CONDENSING UNIT | 15B33-061C |
| 3 | SPD27/UCRD WTRD27/UCR20 | COMPRESSOR (1/6HP) (AZA0370YXA) | 302-687B |
| | UCR34 | COMPRESSOR (1/5HP) (AZA0395YXA) | 302-676B |
| 4 | SPD27/UCRD WTRD27/UCR20 | OVERLOAD | 302-688A |
| | UCR34 | OVERLOAD | 302-918A |
| 5 | SPD27/UCRD WTRD27/UCR20 | RELAY | 302-702A |
| | UCR34 | RELAY | 302-677A |
| 6 | UCR34 | START CAPACITOR | 302-919A |
| 7 | ALL | DRYER | 303-143A |
| 8 | SPD27/UCRD WTRD27-A/UCR34 | CONDENSER COIL(5-5/16X7-7/8X3) | 305-144C |
| | UCR20 | CONDENSER COIL(5-1/8X8X2) | 305-204C |
| 9 | SPD27/UCRD WTRD27A UCR20/34 | CONDENSER FAN MOTOR (5 WATTS) | 501-019B |
| 10 | SPD27/UCRD WTRD27 | CONDENSER FAN BLADE(6.75") (3 PED ALUM) | 405-015A-- |
| | UCR20/34 | CONDENSER FAN BLADE | 405-058A |
| 11 | SPD27/UCRD WTRD27-A | EVAPORATOR COIL ASSY. | 19B31-021D |
| | UCR20 | EVAPORATOR COIL ASSY. | 20B30-088D |
| | UCR34 | EVAPORATOR COIL ASSY. | 20B30-083D |
| 12 | SPD27/UCRD WTRD27-A | EVAP COIL (20X4X3) | 305-175C |
| | UCR20 | EVAP COIL (10X4X3) | 305-202C |
| | UCR34 | EVAP COIL (20X4X3) | 305-209C |

* Indicates part not illustrated

03/27/2000

REFRIGERATION (CONTINUED)

SPD/UCRD/WTRD27

UCR20/34

| ITEM | MODEL | DESCRIPTION | PART NUMBER |
|------|---------------------------|--------------------------------|---------------|
| 13 | UCR20 | SUC/CAP ASSY | 20B35-077D |
| | UCR34 | SUC/CAP ASSY | 20B35-075D |
| 14 | SPD27/UCRD WTRD27-A/UCR34 | CAP TUBE .036ID X .087OD X 120 | 203-048A-- |
| | UCR20 | CAP TUBE .031ID X .081OD X 48 | 203-129A |
| 15 | SPD27/UCRD WTRD27-A | ACCUMULATOR | 303-071A |
| | UCR20/34 | ACCUMULATOR | 303-094A |
| 16 | SPD27/UCRD WTRD27-A | REFRIGERANT | 0.4375 |
| | UCR20 | REFRIGERANT | 0.3125 |
| | UCR34 | REFRIGERANT | 0.28125 |
| 17 | SPD27 | WIRING DIAGRAM | *IL-1792B |
| | UCRD/WTRD27-A | WIRING DIAGRAM | *IL-1811D |
| | UCR20/34 | WIRING DIAGRAM | *ILB-1351 |
| 18 | SPD27 | WIRE HARNESS | 504-762C |
| | UCRD/WTRD27A UCR20/34 | WIRE HARNESS | 504-430C |
| 19 | SPD27 | CONDENSATE PAN | 08B30-041D-01 |
| | UCRD/WTRD27-A | CONDENSATE PAN | 706-047C |
| | UCR20 | CONDENSATE PAN | 30D02-014C |
| | UCR34 | CONDENSATE PAN | 30D02-013C |

REFRIGERATION ASSEMBLY COMPONENTS
(REFRIGERATORS)

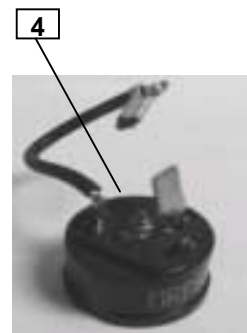
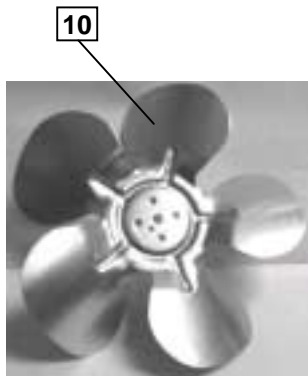
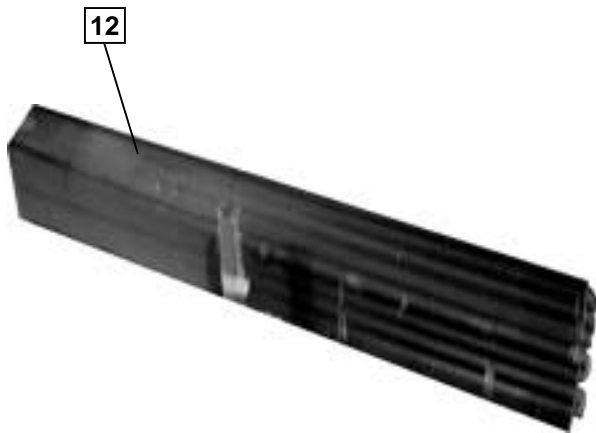

**SHELVES & GRILLS
UNDER COUNTER & WORK TOP FREEZERS**

| ITEM | MODEL | DESCRIPTION | PART NUMBER |
|------|---------------|-------------|---------------|
| 21 | UCF/WTF27A | 22.25X15.5 | 403-294D |
| | UCF/WTF48A | 20.88X14.5 | 403-293D |
| | UCF/WTF67 | 20.82X26 | 403-507D |
| 22 | ALL UCF/WTF | SHELF CLIPS | 403-169A |
| 23 | UCF/WTF27/48A | 15" | 403-154A |
| | UCF/WTF67 | 21" | 403-514B |
| 24 | UCF/WTF24/48A | FRONT GRILL | 07B31-061B |
| | UCF/WTF67 | FRONT GRILL | 28D37-033C |
| *25 | UCF/WTF27/48A | REAR GRILL | 28D37-088D-03 |
| 26 | UCF/WTF27/48A | CASTER KIT | 00C31-038A |
| | UCF/WTF67 | CASTER KIT | 29B02-015A |

REFRIGERATION UNDER COUNTER & WORK TOP FREEZERS

| ITEM | MODEL | DESCRIPTION | PART NUMBER |
|------|---------------|--------------------------------------|---------------|
| *1 | UCF/WTF27/48A | REFRIGERATION ASSEMBLY | 19B36-082D-01 |
| | UCF/WTF67 | REFRIGERATION ASSEMBLY | 19B36-059D |
| 2 | UCF/WTF27/48A | CONDENSING UNIT | 19B34-037D-01 |
| | UCF/WTF67 | CONDENSING UNIT | 15B01-052D |
| 3 | UCF/WTF27/48A | COMPRESSOR(1/4HP 115-60 AEA2380ZXA) | 302-924B |
| | UCF/WTF67 | COMPRESSOR(3/4HP 115-60 RS64CIE-CAA) | 302-881B |
| 4 | UCF/WTF27/48A | OVERLOAD (TI)MRP30AGK-69) | 313-003A |
| | UCF/WTF67 | OVERLOAD (071-0127-43) | 302-882A |
| 5 | UCF/WTF27/48A | RELAY (3ARR12-KPL226) | 314-002A |
| | UCF/WTF67 | RELAY (040-0001-38) | 302-883A |
| 6 | UCF/WTF27/48A | START CAP.(243-292 MFD @ 110V) | 302-993A |
| | UCF/WTF67 | START CAP.(81-90 MFD @ 320V) | 302-885A |
| | UCF/WTF67 | RUN CAP.(30MFD @ 440V) | 302-884A |
| | UCF/WTF67 | RUN CAP. ASSY.(514-1207-48) | 302-886A |
| 7 | ALL UCF/WTF | DRYER | 303-143A |
| 8 | UCF/WTF27/48A | CONDENSER COIL (6X8.13X3.5) | 305-362C |
| | UCF/WTF67 | CONDENSER COIL (11X10-7/8X4) | 305-160C |
| 9 | UCF/WTF27A | CONDENSER FAN MOTOR (5 WATTS) | 501-019B |
| | UCF/WTF48A&67 | CONDENSER FAN MOTOR (9 WATTS) | 501-148B |
| 10 | UCF/WTF27A | CONDENSER FAN BLADE | 405-015A-- |
| | UCF/WTF48A | CONDENSER FAN BLADE | 405-050A |
| | UCF/WTF67 | CONDENSER FAN BLADE | 405-066B |
| *11 | UCF/WTF27/48A | EVAP. COIL ASSY. | 19B31-008D-01 |
| | UCF/WTF67 | EVAP. COIL ASSY. | 20B30-102D |
| 12 | UCF/WTF27/48A | EVAP. COIL ONLY.(20X4X4) | 305-176C |
| | UCF/WTF67 | EVAP. COIL ONLY.(20X7X4) | 305-222C |
| *13 | UCF/WTF27/48A | SUCTION LINE AND CAP. ASSY. | 19B30-025D |
| | UCF/WTF67 | SUCTION LINE AND CAP. ASSY. | 20B35-093D |
| 14 | UCF/WTF27/48A | CAP. TUBE .036IDX.087ODX84 | 203-126A |
| | UCF/WTF67 | CAP. TUBE .042ID X .093OD X 68 | 203-109A |
| *15 | ALL | ACCUMULATOR | 303-071A |
| *16 | UCF/WTF27/48A | REFRIGERANT .37500 LBS | R404A |
| | UCF/WTF67 | REFRIGERANT .96900 LBS | R404A |
| *17 | UCF/WTF27/48A | WIRING DIAGRAM | *ILA-0886 |
| | UCF/WTF67 | WIRING DIAGRAM | *ILB-1488 |
| *18 | WTF27 | WIRING HARNESS | 504-787C |
| | WTF48 | WIRING HARNESS | 504-291C |
| | UCF/WTF67 | WIRING HARNESS | 504-291C |
| *19 | UCF/WTF27/48A | CONDENSATE PAN | 706-047C |
| | UCF/WTF67 | CONDENSATE PAN | 43B35-012C |
| 20 | UCF/WTF27/48A | DEFROST HEATER | 504-454B |
| | UCF/WTF67 | DEFROST HEATER | 504-465B |
| | ALL UCF/WTF | DEFROST LIMIT SWITCH | 502-089A |

REFRIGERATION ASSEMBLY COMPONENTS
(FREEZERS)

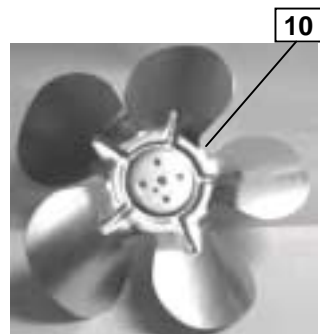
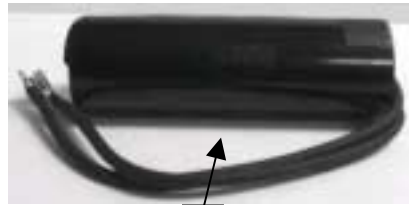
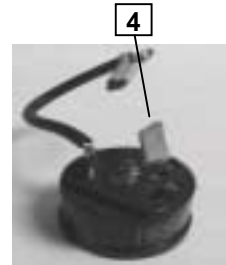
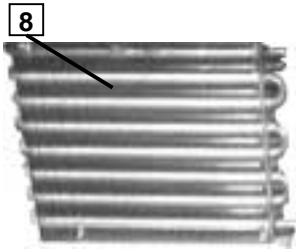
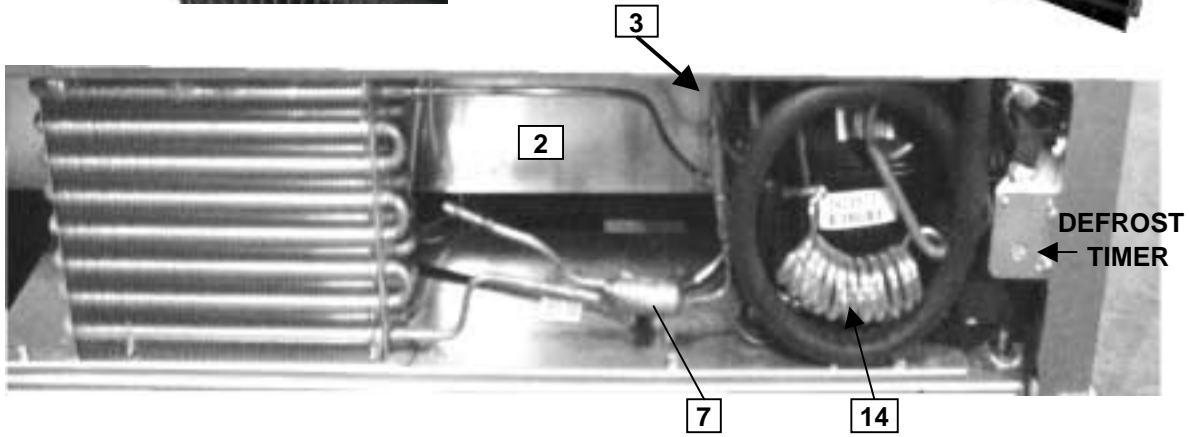
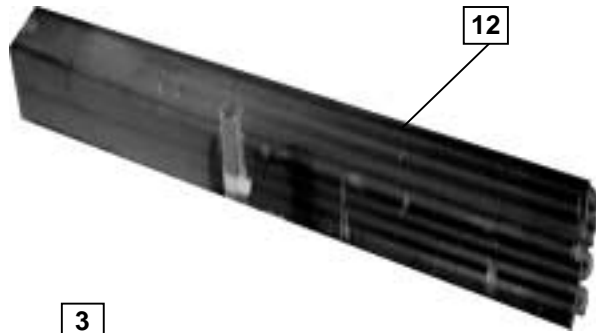

EVAPORATOR HOUSINGS 34" BASE REFRIGERATORS

| ITEM | MODEL | DESCRIPTION | PART NUMBER |
|------|------------------------------------|---------------------------|---------------|
| 18 | UCR/WTR27/48A | EVAP. HOUSING | 04B01-076D-02 |
| 19 | ALL DP | EVAP. FAN COVER | 04B04-050C |
| | UCR/WTR27A | EVAP. FAN COVER | 04B02-175D-02 |
| | UCR/WTR46/67/93/119A | EVAP. FAN COVER | 04B04-043C |
| | UCR/WTR48A | EVAP. FAN COVER | 04B02-176C-02 |
| *20 | ALL DP | EVAP. FAN MOUNT ASSY. | 04B04-055C-02 |
| | WTR46/67A | EVAP. FAN MOUNT ASSY. | 04B04-016C |
| | UCR/WTR93/119A | EVAP. FAN MOUNT ASSY. | 04B04-018C |
| 21 | UCR/UTR41/46/48/93/119-A ALL DP | EVAP.FAN BLADE (6" WHITE) | 405-062A |
| | UCR/WTR27A | EVAP.FAN BLADE (6"BLACK) | 405-063A |
| 22 | ALL DP/UCR/WTR | EVAP. MOTOR | 501-105B |
| *23 | ALL DP/UCR/WTR | EVAP. MOTOR BRACKET | 42A37-011B |
| 24 | ALL DP | TEMP. CONT | 502-140A |
| | UCR/WTR27A | TEMP. CONT | 502-269A |
| | UCR/WTR41-46/48/67/93/119A | TEMP. CONT | 502-290B |
| 25 | ALL DP | EVAP. DRAIN PAN ASSY. | 04B02-060C |
| | UCR/WTR41-46/67/93/119A | EVAP. DRAIN PAN ASSY. | 04B02-171C-01 |
| *26 | ALL DP | THERMOMETER | 401-236B |

SHELVES, CUTTING BOARDS & GRILLS 34" BASE REFRIGERATORS

| ITEM | MODEL | DESCRIPTION | PART NUMBER |
|------|--|------------------------|---------------|
| 27 | ALL DP/WT/UC-A | SHELF SUPPORT | 403-169A |
| 28 | ALL DP/WT/UC-A | SHELF (20.82X36) | 403-507D |
| 29 | ALL DP/WT/UC-A | PILASTER (21") | 403-514B |
| 30 | DP41 | CUTTING BOARD (19X41) | 705-285B |
| | DP46 | CUTTING BOARD (19X46) | 705-307C-01 |
| | DP67 | CUTTING BOARD (19X67) | 705-286B |
| | DP93 | CUTTING BOARD (19X93) | 705-287B |
| | DP119 | CUTTING BOARD (19X119) | 705-288B |
| 31 | DP41 | CUTTING BOARD RETAINER | 28D40-053B-05 |
| | DP46 | CUTTING BOARD RETAINER | 107-429C-01 |
| | DP67 | CUTTING BOARD RETAINER | 107-429C-02 |
| | DP93 | CUTTING BOARD RETAINER | 107-429C-03 |
| | DP119 | CUTTING BOARD RETAINER | 107-429C-04 |
| 32 | ALL DP/UCR/WTR | GRILL ASSY. (FRONT) | 28D37-033C |
| 33 | DP41/46/67/93/WTR/UCR41/46/ 67/93-A | CASTER ASSY. | 29B02-015A |
| | DP/WT119 | CASTER ASSY. | 29B02-016A |

PAN SUPPORTS 34" BASE REFRIGERATORS

| ITEM | UNIT | DESCRIPTION | PART NUMBER |
|------|-------|-------------------------|---------------|
| 34 | DP41 | PAN SUPPORTS (1 NEEDED) | 28D40-054B-05 |
| | DP46 | PAN SUPPORTS (2 NEEDED) | 28D40-054B-05 |
| | DP67 | PAN SUPPORTS (5 NEEDED) | 28D40-054B-05 |
| | DP93 | PAN SUPPORTS (3 NEEDED) | 28D40-054B-05 |
| | DP93 | PAN SUPPORTS (1 NEEDED) | 28D40-055B-05 |
| | DP119 | PAN SUPPORTS (4 NEEDED) | 28D40-054B-05 |

REFRIGERATION

34" BASE REFRIGERATORS

| ITEM | UNIT | DESCRIPTION | PART NUMBER |
|------|------------------------------|-----------------------------------|---------------|
| 1 | DP41/DP/UCR/WTR46/67-A | REFRIGERATION ASSEMBLY | 19B36-078D |
| | DP93/119/UC/WT93-A | REFRIGERATION ASSEMBLY | 19B36-079D-01 |
| | UCR/WTR41 | REFRIGERATION ASSEMBLY | 19B36-042D |
| | UCR/WTR119-A | REFRIGERATION ASSEMBLY | 19B36-062D-01 |
| 2 | DP41/DP/UCR/WTR46/67-A | CONDENSING UNIT | 15B01-038D |
| | DP/UCR/WTR41/93/119-A | CONDENSING UNIT | 15B01-036D |
| 3 | DP41/DP/UCR/WTR46/67-A | COMPRESSOR1/6 HP (AE3440YXA) | 302-803B |
| | DP/UCR/WTR41/93/119-A | COMPRESSOR1/5 HP (AE3430YXA) | 302-804B |
| 4 | DP41/DP/UCR/WTR46/67-A | OVERLOAD (TI)MRP26ALL-69 | 302-815A |
| | DP/UCR/WTR41/93/119-A | OVERLOAD (TI) MRT24AIK-69 | 302-911A |
| 5 | DP41/DP/UCR/WTR46/67-A | RELAY (TI) 966-042-176 | 302-646B |
| | DP/UCR/WTR41/93/119-A | RELAY (TI) 9660-042-182 | 302-350A |
| 6 | | START CAP. | NA |
| 7 | ALL | DRYER | 303-143A |
| 8 | DP41/DP/UCR/WTR46/67-A | COND. COIL (11X10-7/8X2) | 305-150C |
| | DP/UCR/WTR41/93/119-A | COND. COIL (11X10-7/8X3) | 305-151C |
| 9 | DP41/DP/UCR/WTR46/67-A | COND. FAN MOTOR (5WATT) 115/60 | 501-148B |
| 10 | DP/UCR/WTR41/93/119-A | COND. FAN BLADE (6.75") | 405-066B |
| 11 | DP41/DP/UCR/WTR46/67-A | EVAP. COIL ASSY. | 19B31-014C |
| | DP93/119/UC/WT93-A | EVAP. COIL ASSY | 19B31-015C |
| | UCR/WTR41 | EVAP. COIL ASSY | 20B30-100C |
| | UCR/WTR119-A | EVAP. COIL ASSY | 20B30-111C |
| 12 | DP41/46/67 UCR/WTR41/46/67-A | EVAP. COIL ONLY (20X6X3) | 305-172C |
| | DP93/119 UCR/WTR93/119-A | EVAP. COIL ONLY (20X7X4) | 305-173C |
| *13 | DP41/DP/UCR/WTR46/67-A | SUCTION LINE AND CAP. TUBE ASSY. | 19B30-038D |
| | DP93/119/UC/WT93-A | SUCTION LINE AND CAP. TUBE ASSY. | 19B30-039D |
| | UCR/WTR41 | SUCTION LINE AND CAP. TUBE ASSY. | 20B35-088D |
| | UCR/WTR119-A | SUCTION LINE AND CAP. TUBE ASSY. | 20B35-098D |
| *14 | DP41/46/67 UCR/WTR41/46/67-A | CAP. TUBE (.049ID X .099OD X 132) | 203-039A-- |
| | DP93/119 UCR/WTR93/119-A | CAP. TUBE (.054ID X .106OD X 120) | 203-124A |
| *15 | ALL | ACCUMULATOR | 303-071A |
| *16 | DP41/DP/UCR/WTR46/67-A | REFRIGERANT CHARGE | 0.4219 |
| | DP93/119/UC/WT93-A | REFRIGERANT CHARGE | 0.594 |
| | UCR/WTR41 | REFRIGERANT CHARGE | 0.4219 |
| | UCR/WTR119-A | REFRIGERANT CHARGE | 0.5938 |
| *17 | ALL | WIRING DIAGRAM | ILB-1351 |
| *18 | ALL | WIRE HARNESS | 504-430C |
| *19 | DP/UCR/WTR41/46/67 | CONDENSATE PAN ASSY. | 43B35-004C |
| | DP/UCR/WTR93/119 | CONDENSATE PAN | 43B35-005C |

REFRIGERATION ASSEMBLY COMPONENTS (REFRIGERATORS)

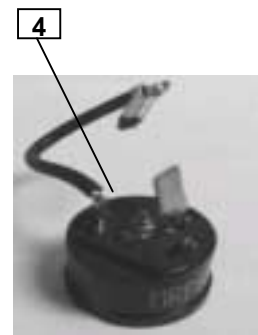
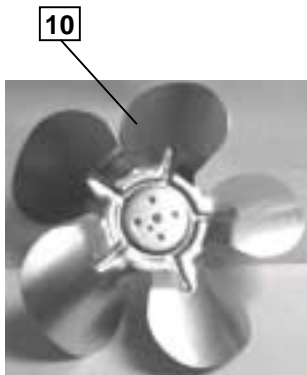
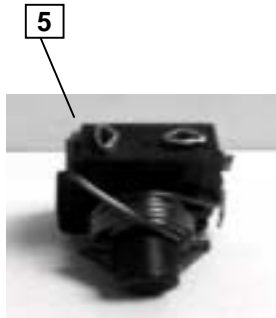
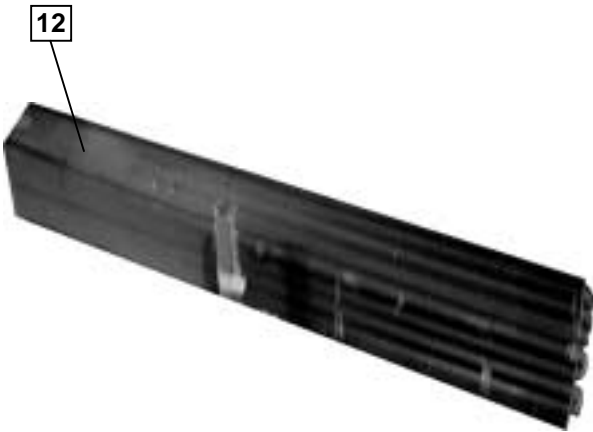
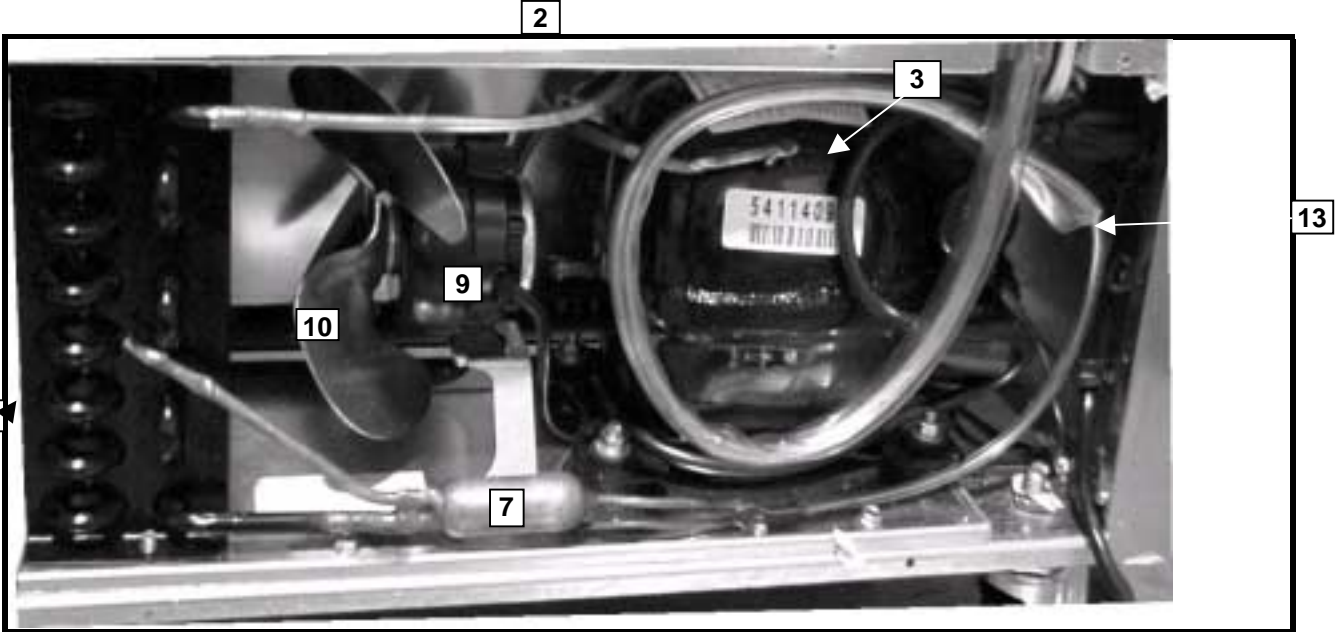

TOP ASSEMBLES
29" BASE REFRIGERATORS (CONTINUED)

| ITEM | MODEL | DESCRIPTION | PART NUMBER |
|----------|-------------------------------|-----------------------------------|---------------|
| 3 | SP72-10/10C | TOP COVER ASSY. | 01B36-085A-03 |
| | SP72-12 | TOP COVER ASSY. | 01B36-085A-02 |
| | SP72-12C | TOP COVER ASSY. | 01B36-084A-01 |
| | SP72-12M | TOP COVER ASSY. | 01B36-075A-03 |
| | SP72-18/18C/18M | TOP COVER ASSY. | 01B36-075A-02 |
| | SP72-24M | TOP COVER ASSY. | 01B36-075A-01 |
| | SP72-30M | TOP COVER ASSY. | 01B36-076A-01 |
| 4 | SP27/08/16/C/SPD27 | TOP COVER (LID) | 01B40-002D-01 |
| | SP2712M | TOP COVER (LID) | 01B40-001D-01 |
| | SP48-08/08C | TOP COVER (LID) | 01B40-002D-02 |
| | SP48-10/10C | TOP COVER (LID) | 01B40-002D-03 |
| | SP48-12/12C | TOP COVER (LID) | 01B40-002D-04 |
| | SP48-12M | TOP COVER (LID) | 01B40-001D-01 |
| | SP48-18M | TOP COVER (LID) | 01B40-001D-02 |
| | SP60-08 | TOP COVER (LID) | 01B40-002D-02 |
| | SP60-12 | TOP COVER (LID) | 01B40-002D-04 |
| | SP60-12M | TOP COVER (LID) | 01B40-001D-01 |
| | SP60-16 | TOP COVER (LID) (LH) | 01B38-048D |
| | SP60-16 | TOP COVER (LID) (RH) | 01B38-047D |
| | SP60-16 (AFTER #5006876) | (SINGLE) TOP COVER LID | 01B36-116D-01 |
| | SP60-18M | TOP COVER (LID) | 01B40-001D-03 |
| | SP60-24M | TOP COVER (LID) | 01B40-001D-04 |
| | SP72-08/08C | COVER ONLY (LID) | 01B40-002D-02 |
| | SP72-10/10C/12 | COVER ONLY (LID) | 01B40-002D-03 |
| | SP12C/12M/18C/18M | COVER ONLY (LID) | 01B40-002D-04 |
| | SP72-18 | COVER ONLY (LID) | 01B40-002D-04 |
| | SP72-18M/18C | COVER ONLY (LONG LID) | 01B40-002D-07 |
| | SP72-18M/18C | COVER ONLY (SHORT LID) | 01B40-002D-08 |
| | SP72-24M/30M | COVER ONLY (LONG LID) | 01B40-001D-04 |
| | SP72-30M | COVER ONLY (SHORT LID) | 01B40-001D-05 |
| All | LID STUD. (2 PER LID) | 604-094A | |
| 5 | SP27/27C/27-16 | SERVING BAR (LID HOUSING) | 01B36-093C-01 |
| | SP27-12M | SERVING BAR (LID HOUSING) | 01B36-077C-01 |
| | SP48-08/08C | SERVING BAR (LID HOUSING) | 01B36-098C-01 |
| | SP48-10/10C | SERVING BAR (LID HOUSING) | 01B36-094C-01 |
| | SP48-12/12C | SERVING BAR (LID HOUSING) | 01B36-098C-01 |
| | SP48-12M | SERVING BAR (LID HOUSING) | 01B36-100C-01 |
| | SP48-18M | SERVING BAR (LID HOUSING) | 01B36-078C-01 |
| | SP60-08 | SERVING BAR (LID HOUSING) | 01B36-098C-01 |
| | SP60-12 | SERVING BAR (LID HOUSING) | 01B36-095C-01 |
| | SP60-12M | SERVING BAR (LID HOUSING) | 01B36-077C-01 |
| | SP60-16 | SERVING BAR (LID HOUSING) | 01B36-096C-01 |
| | SP60-16(AFTER SERIAL#5006875) | (SINGLE)SERVING BAR (LID HOUSING) | 01B36-114D-01 |
| | SP60-18M | SERVING BAR (LID HOUSING) | 01B36-078C-01 |
| | SP60-24M | SERVING BAR (LID HOUSING) | 01B36-079D-01 |
| | SP72-08/08C | SERVING BAR (LID HOUSING) | 01B36-098C-01 |
| | SP72-10/10C | SERVING BAR (LID HOUSING) | 01B36-094C-01 |
| | SP72-12/12C | SERVING BAR (LID HOUSING) | 01B36-095C-01 |
| | SP72-18 | SERVING BAR (LID HOUSING) | 01B36-077D-01 |
| | SP72-18M/18C | SERVING BAR (LID HOUSING) | 01B36-097D-01 |
| | SP72-18C | SERVING BAR (LID HOUSING) | 01B36-078D-01 |
| SP72-24M | SERVING BAR (LID HOUSING) | 01B36-079D-01 | |
| SP72-30M | SERVING BAR (LID HOUSING) | 01B36-097D-01 | |
| 6 | ALL/ SP | TOP COVER HANDLE | 401-201A |
| | ALL/ SP | TOP COVER HANDLE SCREW | 603-340A |

* Indicates part not illustrated

1/28/2000

DOOR ASSEMBLES
29" BASE REFRIGERATORS

| ITEM | MODEL | DESCRIPTION | PART NUMBER |
|------|---------------|-------------------------------|-------------|
| 7 | SP/UC/WT27/60 | D00R ASSEMBLY COMPLETE | 02B01-249C |
| | SP/UC/WT48/72 | D00R ASSEMBLY COMPLETE | 02B01-253C |
| 8 | SP/UC/WT27/60 | DOOR GASKET (23-18X24-1/2) | 703-963D-02 |
| | SP/UC/WT48/72 | DOOR GASKET (21-1/16X23-1/8) | 703-963D-03 |
| 9 | ALL SP/UC/WT | DOOR HANDLE | 401-506C |
| *10 | ALL SP/UC/WT | DOOR HANDLE SCREWS | 603-338A |
| 11 | ALL SP/UC/WT | DOOR HINGE (TOP/BOTTOM/LH&RH) | 401-657B |
| * | ALL SP/UC/WT | HINGE COVER | 401-244B |
| * | ALL SP/UC/WT | HINGE PIVOT CAM (NYLON) | 401-242B |
| *12 | ALL SP/UC/WT | THERMOMETER | 402-233B |

EVAPORATOR HOUSINGS
29" BASE REFRIGERATORS

| ITEM | MODEL | DESCRIPTION | PART NUMBER |
|------|--------------------------|---------------------|---------------|
| 13 | SP27/48 & UCR/WTR27A/48A | EVAP. HOUSING ASSY. | 04B01-076D-02 |
| | SP60/72 & UCR/WTR60/72A | EVAP. HOUSING ASSY. | 04B01-077D-02 |
| 14 | SP27/48 & UCR/WTR27A/48A | EVAP. COVER ASSY. | 04B02-175D-02 |
| | SP60/72 & UCR/WTR60/72A | EVAP. COVER ASSY. | 04B02-177D-02 |
| 15 | SP27/48 & UCR/WTR27A/48A | EVAP. BLADE | 405-063A |
| 16 | SP60/72 & UCR/WTR60/72A | EVAP. MOTOR | 501-105B |
| *17 | SP27/48 & UCR/WTR27A/48A | EVAP. MOTOR BRACKET | 42A37-011B |
| 18 | ALL SP/UC/WT | TEMP. CONT | 502-290B |

Evaporator pans below will be used for units produced before serial number **#5100522**. Units produced after this serial number have the evaporator pans incorporated into the cabinet and are not replaceable.

| | | | |
|----|----------|-----------------------|---------------|
| 19 | ALL SP27 | EVAP. DRAIN PAN ASSY. | 04B02-164C-01 |
| | ALL SP48 | EVAP. DRAIN PAN ASSY. | 04B02-164C-02 |
| | ALLSP60 | EVAP. DRAIN PAN ASSY. | 04B02-164C-03 |
| | ALL SP72 | EVAP. DRAIN PAN ASSY. | 04B02-064C-04 |
| | ALL SP48 | EVAP. DRAIN PAN ASSY. | 04B02-164C-02 |
| | ALLSP60 | EVAP. DRAIN PAN ASSY. | 04B02-164C-03 |
| | ALL SP72 | EVAP. DRAIN PAN ASSY. | 04B02-064C-04 |

SHELVES, CUTTING BOARDS & GRILLS
29" BASE REFRIGERATORS

| ITEM | MODEL | DESCRIPTION | PART NUMBER |
|------|-------------------------------------|--------------------------|-------------|
| 20 | ALL SP | SHELF SUPPORT | 403-169A |
| 21 | SP/27 & UCR/WTR27A | SHELF | 403-628D |
| | SP48 & UCR/WTR48A | SHELF | 403-630D |
| | SP60 & UCR/WTR60A | SHELF | 403-631D |
| | SP72 & UCR/WTR72A | SHELF (CTR) | 403-629D |
| | SP72 & UCR/WTR72A | SHELF. (END) | 403-630D |
| 22 | SP/UCR/WTR | PILASTER (15") | 403-154A |
| *23 | SP/UCR/WTR | PILASTER SCREWS | 603-415A |
| 24 | ALL SP27 | CUTTING BOARD (10" WIDE) | 705-290C-01 |
| | SP48-08/08C/10/10C/12 | CUTTING BOARD (10" WIDE) | 705-290C-02 |
| | SP48-12C/12M/18M | CUTTING BOARD (17" WIDE) | 705-265C |
| | ALL SP60 | CUTTING BOARD (10" WIDE) | 705-290C-03 |
| | SP72-08/08C/10/12/12M/18/18M/24/30M | CUTTING BOARD (10" WIDE) | 705-290C-04 |
| | SP72-18C | CUTTING BOARD (17" WIDE) | 705-267C |
| 25 | SP27 | CUTTING BOARD RETAINER | 107-430C-01 |
| | SP48 | CUTTING BOARD RETAINER | 107-430C-02 |
| | SP60 | CUTTING BOARD RETAINER | 107-430C-03 |
| | SP72 | CUTTING BOARD RETAINER | 107-430C-04 |

SHELVES, CUTTING BOARDS & GRILLS
29" BASE REFRIGERATORS (CONTINUED)

| ITEM | MODEL | DESCRIPTION | PART NUMBER |
|------|-------------------|---------------------|---------------|
| 26 | SP27 & UCR/WTR27A | GRILL ASSY. (FRONT) | 07B31-061B |
| | SP48 & UCR/WTR48A | GRILL ASSY. (FRONT) | 07B31-057B |
| | SP60 & UCR/WTR60A | GRILL ASSY. (FRONT) | 07B31-059B |
| | SP72 & UCR/WTR72A | GRILL ASSY. (FRONT) | 07B31-055B |
| 27 | SP27 & UCR/WTR27A | GRILL ASSY. (REAR) | 28D37-090D-03 |
| | SP48 & UCR/WTR48A | GRILL ASSY. (REAR) | 28D37-091D-03 |
| | SP60 & UCR/WTR60A | GRILL ASSY. (REAR) | 28D37-092D-03 |
| | SP72 & UCR/WTR72A | GRILL ASSY. (REAR) | 28D37-093D-03 |
| 28 | ALL SP | CASTER KIT | 00C31-038A |

PAN SUPPORTS

29" BASE REFRIGERATORS

| ITEM | UNIT | DESCRIPTION | PART NUMBER |
|------|-----------------------------|-----------------------|---------------|
| 29 | SP27/27C/SPD27/SP72-12M | PAN SUPPORTS 3 NEEDED | 28D40-056C-05 |
| | SP27-16 | PAN SUPPORTS 5 NEEDED | 28D40-056C-05 |
| | SP27-12M/SP60-12M | PAN SUPPORTS 3 NEEDED | 28D40-051C-05 |
| | SP48-18M/SP60-12M/SP72-18M | PAN SUPPORTS 5 NEEDED | 28D40-051C-05 |
| | SP60-24M/SP72-24M | PAN SUPPORTS 6 NEEDED | 28D40-051C-05 |
| | SP72-30M | PAN SUPPORTS 8 NEEDED | 28D40-051C-05 |
| | SP48-12/SP60-12/SP72-12/12C | PAN SUPPORTS 5 NEEDED | 28D40-060C-05 |
| | SP60-10/SP72-10/10C | PAN SUPPORTS 3 NEEDED | 28D40-060C-05 |
| | SP48-10/SP72-10/10C | PAN SUPPORTS 4 NEEDED | 28D40-060C-05 |
| | SP60-16/SP72-18/18C | PAN SUPPORTS 7 NEEDED | 28D40-060C-05 |

PANS

29" BASE REFRIGERATORS

| ITEM | UNIT | DESCRIPTION | PART NUMBER |
|------|------------------------------|------------------------------|---------------------------|
| 30 | SP27 & 27C | PANS 1/6 4" DEEP (6 NEEDED) | 403-490C |
| | | PANS 1/9 4" DEEP (2 NEEDED) | 403-493C |
| | SP48-08C & SP60-08C | PANS 1/6 4" DEEP (8 NEEDED) | 403-490C |
| | | PANS 1/6 4" DEEP (10 NEEDED) | 403-490C |
| | SP48-18M | PANS 1/6" DEEP(6 NEEDED) | 403-490C |
| | | PANS 1/2" DEEP (2 NEEDED) | 403-495C |
| | SP60-12C | PANS 1/6" DEEP (12 NEEDED) | 403-490C |
| | | SP60-18M | PANS 1/6" DEEP (6 NEEDED) |
| | PANS 1/2" DEEP (2 NEEDED) | | 403-495C |
| | PANS FULL 4" DEEP (1 NEEDED) | | 403-497C |
| | SP60-24M | PANS 1/4" DEEP (4 NEEDED) | 403-490C |
| | | PANS 1/2" DEEP (2 NEEDED) | 403-495C |
| | SP72-12M | PANS 1/6 4" DEEP (6 NEEDED) | 403-490C |
| | | PANS 1/2" DEEP (2 NEEDED) | 403-495C |
| | SP72-18M | PANS 1/6 4" DEEP (6 NEEDED) | 403-490C |
| | | PANS 1/2" DEEP (2 NEEDED) | 403-495C |
| | | PANS FULL 4" DEEP (1 NEEDED) | 403-497C |
| | SP72-24M | PANS 1/6 4" DEEP (12 NEEDED) | 403-490C |
| | | PANS 1/2" DEEP (2 NEEDED) | 403-495C |
| | | PANS FULL 4" DEEP (1 NEEDED) | 403-497C |
| | SP72-30M | PANS 1/4" DEEP (18 NEEDED) | 403-490C |
| | | PANS 1/2" DEEP (2 NEEDED) | 403-495C |
| | | PANS FULL 4" DEEP (1 NEEDED) | 403-497C |

REFRIGERATION 29" BASE REFRIGERATORS

| ITEM | UNIT | DESCRIPTION | PART NUMBER |
|------|---|--|------------------------------|
| 1 | SP27/UCR27A/WTR27A | REFRIGERATION ASSEMBLY | 19B36-086D-01 |
| | SP48/UCR48A/WTR48A | REFRIGERATION ASSEMBLY | 19B36-087D-01 |
| | SP60/UCR60A/WTR60A SP72/UCR72A/WTR72A | REFRIGERATION ASSEMBLY | 19B36-088D-01 |
| 2 | SP27/UCR27A/WTR27A | CONDENSING UNIT | 15B33-045C |
| | SP48/UCR48A/WTR48A | CONDENSING UNIT | 15B33-043C |
| | SP60/UCR60A/WTR60A SP72/UCR72A/WTR72A | CONDENSING UNIT | 15B33-051C |
| 3 | SP27/UCR27A/WTR27A | 1/6 HP (AZA0370YXA) | 302-687B |
| | SP48/UCR48A/WTR48A | 1/5 HP (AZA0395YXA) | 302-687B |
| | SP60/UCR60A/WTR60A SP72/UCR72A/WTR72A | 1/4 HP (AEA3430YXA) | 302-803B |
| 4 | SP27/UCR27A/WTR27A | COMP.OVERLOAD (TI) MRP57ALK-69 | 302-688A |
| | SP48/UCR48A/WTR48A | COMP. OVERLOAD (TI) MRP40AJN-69 | 302-918A |
| | SP60/UCR60A/WTR60A SP72/UCR72A/WTR72A | COMP. OVERLOAD (TI) MRP26ALL-69 | 302-815A |
| 5 | SP27/UCR27A/WTR27A | COMP. RELAY (TI) 9660-042-152 | 302-702A |
| | SP48/UCR48A/WTR48A | COMP. RELAY (TI) 9660-071-161 | 302-677A |
| | SP60/UCR60A/WTR60A SP72/UCR72A/WTR72A | COMP. RELAY (TI) 9660-042-176 | 302-646A |
| 6 | SP27/UCR27A/WTR27A | COMP. START CAPACITOR | NA |
| | SP48/UCR48A/WTR48A | COMP. START CAPACITOR.(161-193MFD) | 302-919A |
| | SP60/UCR60A/WTR60A SP72/UCR72A/WTR72A | COMP. START CAPACITOR | NA |
| 7 | ALL SP/UC/WT | DRYER | 303-126A |
| 8 | SP27/48 & UCR/WTR27A/48A | COND. COIL (5-5/16X7-7/8X3) | 305-144C |
| | SP60/72 & UCR/WTR60A/72A | COND. COIL (5-5/16x7-7/8x4) | 305-155C |
| 9 | ALL SP/UC/WT | COND. FAN MOTOR (5WATT) 115/60 | 501-019B |
| 10 | ALL SP/UC/WT | COND. FAN BLADE (6.75") | 405-015A-- |
| 11 | SP27/UCR27A/WTR27A | EVAP. COIL ASSY. | 19B31-021D |
| | SP48/UCR48A/WTR48A | EVAP. COIL ASSY | 19B31-022D |
| | SP60/UCR60A/WTR60A SP72/UCR72A/WTR72A | EVAP. COIL ASSY. | 19B31-023D |
| 12 | SP27/UCR27A/WTR27A | EVAP. COIL ONLY (20X4X3) | 305-175C |
| | SP48/UCR48A/WTR48A | EVAP. COIL ONLY (20X4X4) | 305-176C |
| | SP60/UCR60A/WTR60A SP72/UCR72A/WTR72A | EVAP. COIL ONLY 30X4X4 | 305-154C |
| 13 | SP27/48 & UCR/WTR27A | SUCTION LINE AND CAP. TUBE ASSY. | 19B30-044D |
| | SP60/72 & UCR/WTR60/72A | SUCTION LINE AND CAP. TUBE ASSY. | 19B30-045D |
| 14 | SP27/48 & UCR/WTR27A | CAP. TUBE (.036IDX.087ODX120") | 203-048A-- |
| | SP60/72 & UCR/WTR60/72A | CAP. TUBE (.036IDX.087ODX84) | 203-126A |
| 15 | ALL SP/UC/WT | ACCUMULATOR | 303-071A |
| 16 | SP27/UCR27A/WTR27A | REFRIGERANT 0.4375 LBS | R134A |
| | SP48/UCR48A/WTR48A | REFRIGERANT 0.453 LBS | R134A |
| | SP60/UCR60A/WTR60A SP72/UCR72A/WTR72A | REFRIGERANT 0.4375 LBS | R134A |
| 17 | ALL SP | WIRING DIAGRAM | IL-1792B |
| 18 | SP27/48 | WIRE HARNESS | 504-762C |
| | UCR/WTR27/48A | WIRE HARNESS | 504-430C |
| | SP60/72 | WIRE HARNESS | 504-764C |
| | UCR/WTR 60/72A | WIRE HARNESS | 504-298C |
| 19 | ALL SP | CONDENSATE PAN ASSY. | 08B30-041D-01 |
| | ALL UCR/WTR | CONDENSATE PAN | 706-047C |
| | SP72(BEFORE #5308510) SP72(AFTER #5308510) | CONDENSATE PAN W/O HEATER CONDENSATE PAN HEATER | 28D24-040C-04 504-763B-01 |

* Indicates part not illustrated

1/28/2000

REFRIGERATION ASSEMBLY COMPONENTS
(REFRIGERATORS)

