

BEVERAGE-AIR

**PARTS
MANUAL**

FOR

EF/ER/PF/PR/PRF/PRI/PRT/PFI
PW/PWT/PWD



ALL PURPOSE COLD ®

TOP MOUNT REACH -IN/PASS -THRU
DUAL TEMP REFRIGERATORS, FREEZERS
AND WARMING CABINETS

115V/60HZ

220V/60HZ

220V/50HZ

PART	PAGE
Accumulators	10
Ballast	5
Cabinet Face Heaters	4
Cabinet Heating Elements(Warming Units)	5
Capillary Tubes	10-11
Casters & Leg Kits	3
Compressor Capacitor Relay Assemblies	15
Compressor Overloads	13-14
Compressor Relays	12-13
Compressor Run Capacitors	14
Compressor Start Capicitors	14
Compressors	12
Condenser Fan Shrouds	21
Condenser Coils	18
Condenser Fan Blades	17
Condenser Fan Motors	16
Condensate Drain Pans	19
Condensing Units	11
Defrost Heaters	21
Defrost Timers	4
Distributors	10
Door Assemblies Complete	2
Door Brakers	2
Door Gaskets	2
Door Handles	2
Door Hinges	2
Door Lock Strike Plate	2
Door Locks	2
Door Sweep(Roll in/Roll Through)	2
Drain Line Heaters	4
Dryers	20
Edge-mount Hinge Switch	4
Evaporator Coil Assemblies	8-9
Evaporator Coils	9
Evaporator Drain Pans	3-4
Evaporator Fan Blades	3
Evaporator Fan Motors	3
Evaporator Housings	3
Evaporator Lid Gaskets	4
Expansion Valves	10
High Temp. Lights	3
High Temp. Limit Switch	5
Humidity Control Assy.(Warming units)	4
Humidity Controls(Warming units)	3
Instrument Panels	3
Lamps	5
Light Shields	5
Power Kill Switch(Warming Units)	5
Refrigeration Assemblies	8
Shelving	5
Strike Plate for light switch	2
Suction Line Assemblies	9-10
Temperature Controls	4
Temperature indicators	3
Terminal Boards	4
Top Grilles	3
Vacuum Vents	2

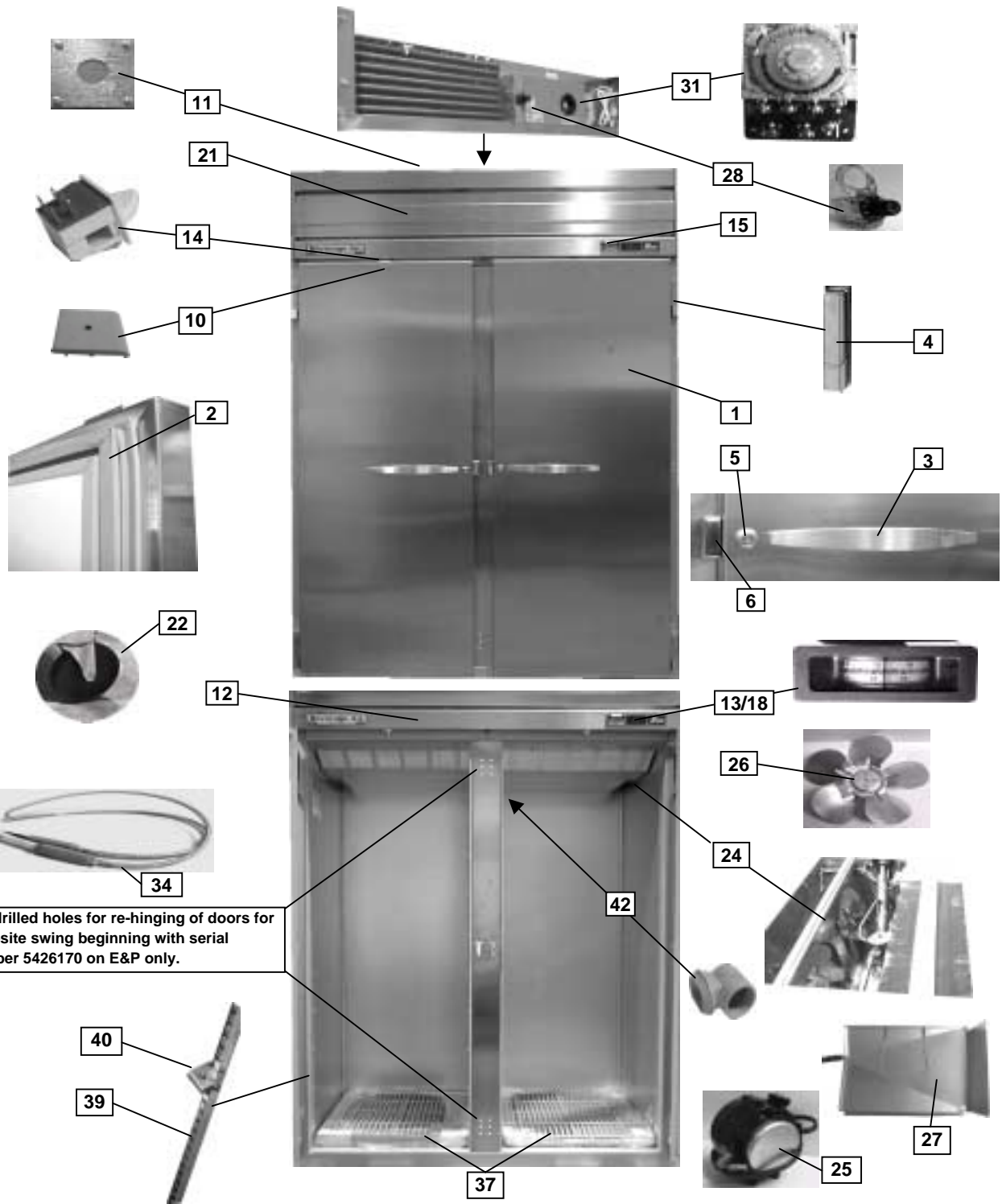

Pre-drilled holes for re-hinging of doors for opposite swing beginning with serial number 5426170 on E&P only.

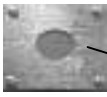

11

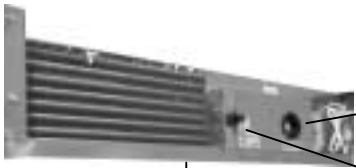

31

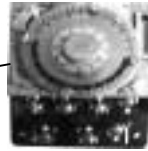

28



14



15



10



4



2

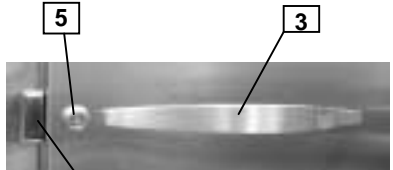

3



22



13/18



34



26

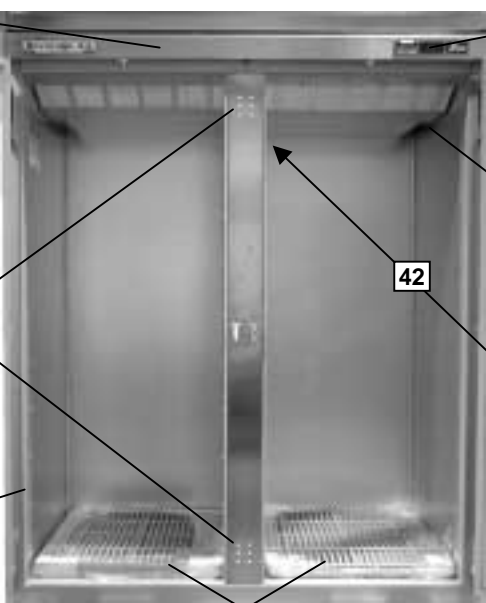

12



24



42

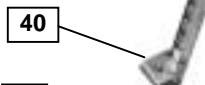

40



27



39



25

37

REACH IN REFRIGERATORS/FREEZERS/ROOL-IN/ROOL-THRU AND WARMING UNITS

DOORS

ITEM	MODEL	DESCRIPTION	PART NUMBER
1	ER/PR/EF/PF24/48/74	DOOR ASSY - RH SS/AL (FULL)	40B32-718D
	ER/PR/EF/PF24/48/74	DOOR ASSY - LH SS/LH (FULL)	40B48-025D-02
	ER/PR/EF/PF24/48/74	DOOR ASSY - RH (FULL GLASS)	40B32-794D
	ER/PR/EF/PF48/74	DOOR ASSY - LH (FULL GLASS)	40B48-027D-01
	ER/PR/EF/PF24/48/74 PRF12-12/24-24	DOOR ASSY - RH TOP SS/AL (HALF)	40B32-687D
	ER/PR/EF/PF24/48/74 PRF24-24	DOOR ASSY - RH BOT SS/AL (HALF)	40B32-705D
	ER/PR/EF/PF24/48/74 PRF12-12/48-24	DOOR ASSY - RH TOP(HALF GLASS)	40B32-795D
	ER/PR/EF/PF24/48/74	DOOR ASSY - RH BOT (HALF GLASS)	40B48-029D-02
	PRF12-12	DOOR ASSY - RH BOT SS/AL (HALF)	40B32-971D
	PRF24-24	DOOR ASSY - LH TOP SS/AL (HALF)	40B32-678D
	PRF24-24	DOOR ASSY - LH BOT SS/SS (HALF)	40B32-690D
	PRF48-24	DOOR ASSY - LH TOP (HALF)	40B48-028D-01
	PRF48-24	DOOR ASSY - LH BOT SS/AL (HALF)	40B32-696D
	PRT/PR/PFI 1 PRI 2	DOOR ASSY - RH SS/SS	40B32-720D
	PRT/PR/PFI 2	DOOR ASSY - LH SS/SS	40B48-026D-01
	PW/PWD24	DOOR ASSY - RH SS/SS	40B32-856D
	PW/PWD48	DOOR ASSY - RH SS/AL	40B32-859D
	PW/PWD48	DOOR ASSY - LH SS/AL	40B48-025D-04
	PWI 1/ PWI 2	DOOR ASSY - RH SS/AL	40B32-836D
	PWI 2	DOOR ASSY - LH SS/AL	40B48-026D-04
2	ER/PR/EF/PF24/48/74 PW/PWD24	DOOR GASKET (FULL DOOR)	712-012D-02
	ER/PR/EF/PF24/48/74 PRF12-12/24-24	DOOR GASKET (HALF DOOR)	712-012D-01
	PRT/PR/PFI 1 PRI 2 PWI 1 PWI 2	DOOR GASKET (FULL DOOR)	703-963D-10
3	ALL	DOOR HANDLE	401-502C
4	ALL	DOOR HINGE	401-657B
5	ALL SOLID DOORS	DOOR LOCK	401-510A
ITEM	MODEL	DESCRIPTION	PART NUMBER
6	ALL SOLID DOORS	DOOR LOCK STRIKE PLATE	401-604B
*7	ER/PR/EF/PF24/48/74	*DOOR BRKR - TOP & BOTTOM (FULL & HALF GLASS)	40A33-161B
*8	ER/PR/EF/PF24/48/74	*DOOR BRKR - (L&R) (FULL GLASS ONLY)	40A33-193B
	ER/PR/EF/PF24/48/74	*DOOR BRKR - (L&R) (HALF GLASS ONLY)	40A33-192B
*9	PRT/PR/PFI 1 PRI 2 PWI 1 PWI 2	* DOOR WIPER SWEEP(BOTTOM)	703-671B
10	ALL	STRIKE PLATE -LIGHT SWITCH	60D32-019B
11	ALL	VACUUM VENT	59D42-016A

NOTE: DOOR BREAKERS ON SOLID DOORS ARE NOT REPLACEABLE.

All E-series units with solid doors (full & half) are pre-drilled for field re-hinging as of serial number 5426170.
Glass door units can not be re-hinged in the field due to wiring for door frame glass heaters.

REACH IN REFRIGERATORS/FREEZERS/ROOL-IN/ROOL-THRU AND WARMING UNITS

INSTRUMENT PANELS

ITEM	MODEL	DESCRIPTION	PART NUMBER
12	ER/EF24	INST PANEL ASSY - SS	50B36-078D-01
	PR/PF24	INST PANEL ASSY - SS	50B36-078D-02
	ER/EF48	INST PANEL ASSY - SS	50B36-079D-01
	PR/PF48	INST PANEL ASSY - SS	50B36-079D-02
	EF/ER74	INST PANEL ASSY - SS	50B36-080D-01
	PF/PR74	INST PANEL ASSY - SS	50B36-080D-02
	PRF12-12	INST PANEL ASSY - SS	50B36-078D-07
	PRF24-24	INST PANEL ASSY - SS	50B36-019C
	PRF48-24	INST PANEL ASSY - SS	50B36-020C
	PRT 1	FRONT INST PANEL ASSY - SS	50B36-028C
	PRT 1	*REAR INST. PANNEL ASSY. - SS	50B36-030C
	PRT 2 / PFI 2	INST PANEL ASSY - SS	50B36-029C
	PFI 1	INST PANEL ASSY - SS	50B36-028C
	PW/PWD24	INST PANEL ASSY	50B36-035C
	PW/PWD48	INST PANEL ASSY	50B36-036C
	PWI 1	INST PANEL ASSY	50B36-065D
	PWI 2	INST PANEL ASSY	50B36-066D
	PWD24	*REAR INST. PANNEL ASSY. - SS	50B36-078D-09
PWD48	*REAR INST. PANNEL ASSY. - SS	50B36-079D-07	
13	ER/EF24	THERMOMETER -(DRUM)	402-218B
14	ALL	ROCKER SWITCH	502-198A
15	ALL	POWER LIGHT GREEN	503-056A
*16	ALL	*INSTRUMENT MOUNTING PLATE	806-075B
*17	ALL	*.250 RETAINER RING	604-143A
*18	PR/PF24/48/74 PRF12-12 PRF24 24 PRF48-24 PWD24/48	* DIGITAL TEMP INDICATOR ASSY	62B03-003B
	PRT 1 PRT 2 PFI 1 & 2	* DIGITAL TEMP INDICATOR ASSY	50B29-001B
*19	ALL PWD	*HIGH TEMP LIGHT	503-057A
*20	ALL PWD	* HUMIDITY CONTROL KNOB	502-131A

GRILLS

ITEM	MODEL	DESCRIPTION	PART NUMBER
21	ER/PR/EF/PF24 PRF12-12 PW/PWD24	TOP GRILLE ASSY - SS	44B31-219C
	ER/PR/EF/PF48 PRF24-24 PW/PWD48	TOP GRILLE ASSY - SS	44B31-221C
	ER/PR/EF/PF74 PRF48-24	TOP GRILLE ASSY - SS	44B31-223C
	PRT 1 PWI 1	TOP GRILLE ASSY - SS	44B31-103C
	PRT 2 PFI 2 PWI 2	TOP GRILLE ASSY - SS	44B31-104C
22	ER/EF24/48/74	5IN CASTER KIT EF/ER	61C01-001A
*23	PR/PF24/48/74	* 6" LEG PKG ASSY. (SATIN NICKEL)	59B36-011A

**REACH IN REFRIGERATORS/FREEZERS/ROLL-IN / ROLL-THROUGH
AND WARMING UNITS
INTERIOR PARTS**

ITEM	MODEL	DESCRIPTION	PART NUMBER	
24	ER/PR24-1AS PRF24-24 REF.	EVAPORATOR HOUSING 115V/60HZ	42B31-090B	
	EF/PF24-1AS PRF24-24 FREEZER PRF48-24 FREEZER	EVAPORATOR HOUSING 115V/60HZ	42B31-091B	
	ER/PR48-1AS	EVAPORATOR HOUSING 115V/60HZ	42B31-083C	
	EF/PF48-1AS	EVAPORATOR HOUSING 115V/60HZ	42B31-081C	
	ER/PR74-1AS	EVAPORATOR HOUSING 115V/60HZ	42B31-097C	
	EF/PF74-5AS	EVAPORATOR HOUSING 115V/60HZ	42B31-096C	
	PRF12-12 REF.	EVAPORATOR HOUSING 115V/60HZ	42B31-127D	
	PRF12-12 FREEZER	EVAPORATOR HOUSING 115V/60HZ	42B31-130D	
	PRF48-24 REF.	EVAPORATOR HOUSING 115V/60HZ	42B31-037C	
	PRT/PRI 1	EVAPORATOR HOUSING 115V/60HZ	42B31-090B	
	PRT/PRI 2	EVAPORATOR HOUSING 115V/60HZ	42B31-034B	
	PWD24 PWI 1 PWT1	EVAPORATOR HOUSING 115V/60HZ	42B31-132C	
	PWD48	EVAPORATOR HOUSING 115V/60HZ	42B31-133C	
	ER/PR24-4	EVAPORATOR HOUSING 220V/50HZ	42B31-092B	
	ER/PR48-4	EVAPORATOR HOUSING 220V/50HZ	42B31-084C	
	ER74-5	EVAPORATOR HOUSING 208-230V/60HZ	42B31-097C	
ER74-4	EVAPORATOR HOUSING 220V/50HZ	42B31-098C		
25	ER/PR24-1AS PRF24-24 REF. PRT/PRI 1	EVAPORATOR FAN MOTOR (5 WATTS 115-60)	501-019B	
	EF/PF24-1AS PRF24-24 FREEZER PRF48-24 FREEZER PR/ER/PF/EF48/74 PRT/PRI 2 ER/EF74-5 PR/PF74-5	EVAPORATOR FAN MOTOR (9 WATTS 115-60)	501-148B	
	PRF12-12 REF PRF 12-12 FREEZER PRF48-24 REF. PRF48-12 FREEZER	EVAPORATOR FAN MOTOR (.65 AMPS 120-60)	501-076B	
	PWD24/48 PWI 1 PWT1	EVAPORATOR FAN MOTOR (4 WATTS)	501-090B	
	ER/PR24-4	EVAPORATOR FAN MOTOR (5 WATTS 230-50/60)	501-055B	
	ER/PR/48/74-4	EVAPORATOR FAN MOTOR (9 W 230-50/60)	501-149B	
	26	ALL ER/EF/PR/PF/PRT PRI/PW/PRF24-24 PRF48-24	EVAPORATOR FAN BLADE	405-033A
		PRF12-12 REF. PRF12-12 FREEZER	EVAPORATOR FAN BLADE	405-062A
27	ER/EF/PR/PF24 PRF24-24 PRF48-24(REF.SIDE) PRT/PRI 1	EVAPORATOR DRAIN PAN	43B32-232B	
	ER/EF/PR/PF48	EVAPORATOR DRAIN PAN	43B32-234B	

(*) INDICATES PARTS NOT ILLUSTRATED

07/24/2000

**REACH IN REFRIGERATORS/FREEZERS/ROLL-IN / ROLL-THROUGH
AND WARMING UNITS
INTERIOR PARTS (CONTINUED)**

ITEM	MODEL	DESCRIPTION	PART NUMBER
27	ER/EF/PR/PF74 PRT/PRI 2	EVAPORATOR DRAIN PAN	43B32-236B
	PRF12-12	EVAPORATOR DRAIN PAN (2)	43B32-134B
	PRF48-24(FREEZER)	EVAPORATOR DRAIN PAN	43B32-020B
28	ER/PR24/48/74 PRF12-12 COOLER PRF24-24 COOLER PRF48-24 COOLER PRI1 PRI2 PRT1 PRT2	TEMPERATURE CONTROL	502-290B
	EF/PF24/48/74 PRF12-12 FREEZER PRF24-24 FREEZER PRF48-24 FREEZER	TEMPERATURE CONTROL	502-147A
	PW24/48 PWD24/48 PWI1 PWI2 PWT2	TEMPERATURE CONTROL	502-130A
29	PW24/48	* HUMIDITY CONTROL ASS'Y	51B30-008B
30	ALL PW UNITS	*HIGH TEMP. LIMIT SWITCH	502-133A
31	ALL FREEZERS (115V)	DEFROST TIMER	502-115A
	ALL FREEZERS (220V)	DEFROST TIMER	502-108A
32	ALL FREEZERS	*TERMINAL BOARD ASSY (FREEZER)	505-094A
	ALL COOLERS	* TERMINAL BOARD ASSY (REFRIG)	505-095A
*33	ER/PR/EF/PF24 PRF24-24/PW24	*EVAPORATOR LID HOUSING GASKET	703-584C
	ER/PR/EF/PF48 PRF48-24 PW48	*EVAPORATOR LID HOUSING GASKET	703-585C
	ER/PR/EF/PF74	*EVAPORATOR LID HOUSING GASKET	703-586C
	PRT2/PRI2/PWI2/PWT2	*EVAPORATOR LID HOUSING GASKET	703-663C
	PRI1/PWI1/PWT1	*EVAPORATOR LID HOUSING GASKET	703-662C
34	PRF12-12	DRAIN TUBE HEATER	504-539B
*35	PR/ER/PF/PRD/EF24/4 8 & 74 PRF24-24 PRF48-24	*CABINET FACE HEATER	504-256B
	PRF12-12	*CABINET FACE HEATER	504-276B
*36	PRF12-12	*EDGEMOUNT HINGE SWITCH	502-137A

(*) INDICATES PARTS NOT ILLUSTRATED

07/24/2000

REACH IN REFRIGERATORS/FREEZERS/ROLL-IN/ROLL-THRU AND WARMING UNITS

SHELVING

ITEM	MODEL	DESCRIPTION	PART NUMBER
37	ER/EF/PR/PF24/48/74	SHELF 20.82X26	403-507D
	PRF12-12		
	PRF24-24		
	PRF48-24		
	PW24/48		
38	ER/EF/PR/PF48/74 PRF48-24	SHELF - CTR 5X10.875	403-212D
39	ER/PR/EF/PF24/48/74 PRF24-24 PRF48-24	PILASTER 56"	401-273A
	PRF12-12	PILASTER-26-1/2	403-336A
	ALL/PW	PILASTER STD	59D35-041C
40	ALL ER/EF/PR/PF/PRT PRI PRF12-12/PRF24-24 PRF48-24	SHELF CLIP	403-168A
	PW24	SHELF CLIP	403-077A-A

LIGHTING

ITEM	MODEL	DESCRIPTION	PART NUMBER
*41	ER/EF/PR/PF/PRF/PRT/PRI &PRD WITH SOLID DOORS	* LAMP (INC) 40W (40T10)	503-071A
	ER/EF/PR/PF WITH GLASS DOORS	*LAMP (FLO) 75W (F60T12/D/HO)	503-084A
42	ER/EF/PR/PF/PRF/PRT/PRI &PRD WITH SOLID DOORS	LIGHT SOCKET (SINGLE)	503-048A--
	ER/EF/PR/PF WITH GLASS DOORS	* LAMP HOLDER-PLUNGER	503-172A
	ER/EF/PR/PF WITH GLASS DOORS	*LAMP HOLDER-STATIONARY	503-173A
*43	ER/EF/PR/PF WITH GLASS DOORS	* BALLAST (1,2) 60W 115/120-60	503-094A
*44	ER/EF/PR/PF WITH GLASS DOORS	*SHIELD - LAMP W / END CAPS 60"	703-478A
	ER/EF/PR/PF/PRF/PRT/PRI &PRD WITH SOLID DOORS	* INTERIOR LIGHT SHIELD (FOR INCANDESCENT LIGHT)	28D25-001A

WARMING CABINET HEATERS & SWITCHES

ITEM	MODEL	DESCRIPTION	PART NUMBER
*45	PW24/48	CABINET HEATING ELEMENT - 800WT 115V	504-362C
	PW11-1S	CABINET HEATING ELEMENT 115	504-715C-01
	PW12-5S		
	PWT1-1S		
	PWT2-5S		
*46	PW24/48	* HI-LIMIT SWITCH 240V	502-133A
	PW11-1S		
	PW12-5S		
	PWT2-5S		
*47	PW24/48	*POWER / KILL- SWITCH	502-136A
	PW11-1S		
	PW12-5S		
	PWT2-5S		

(*) INDICATES PARTS NOT ILLUSTRATED

07/24/2000

ILLUSTRATIONS FOR REFRIGERATION ASSEMBLY

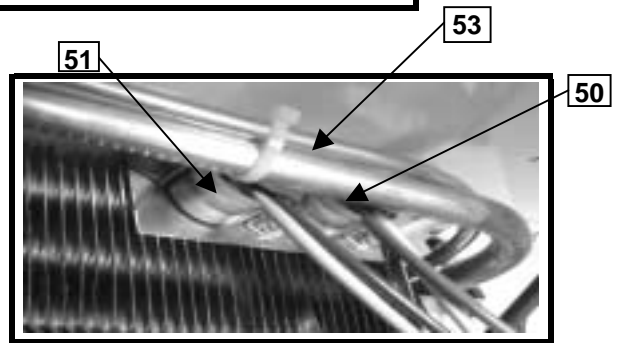
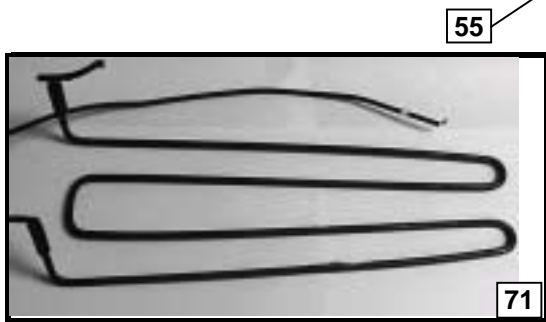
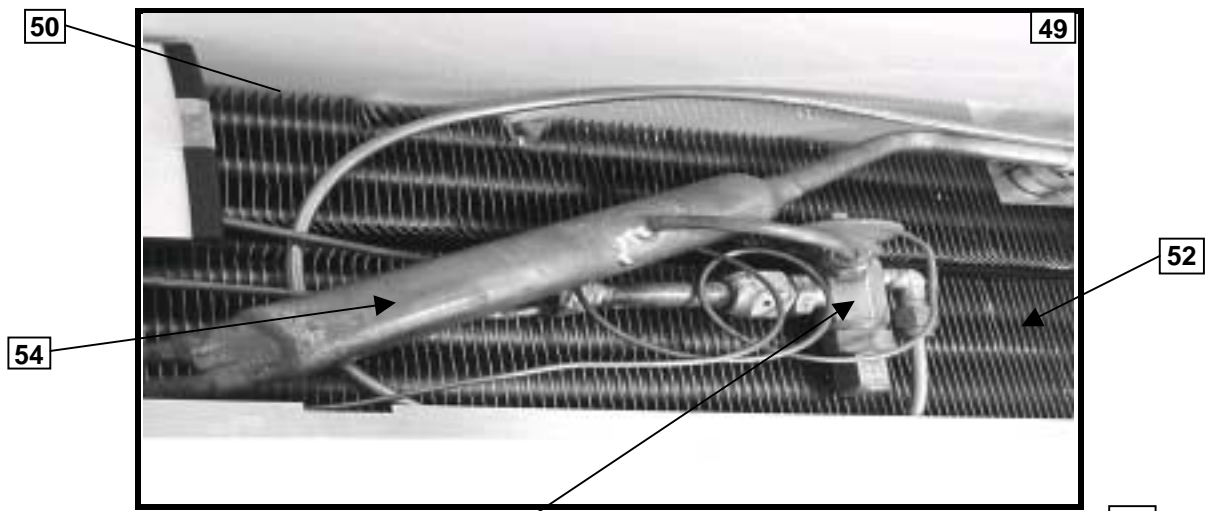
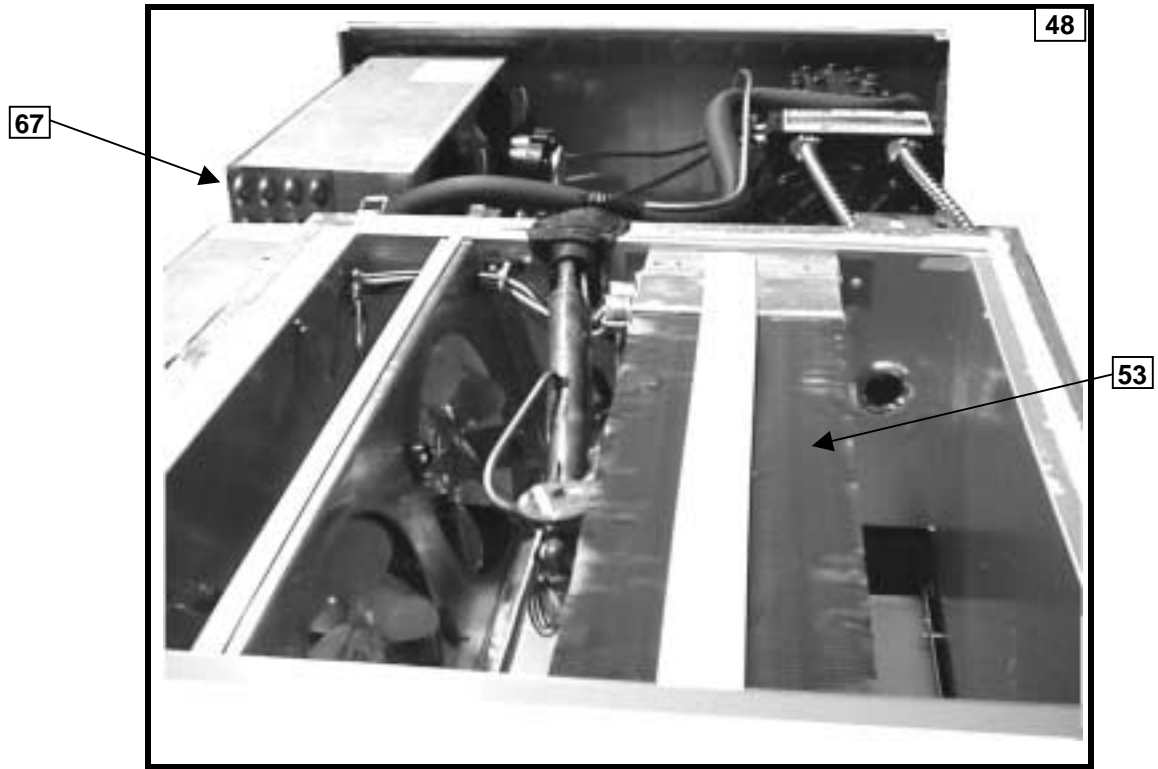

ILLUSTRATIONS FOR REFRIGERATION ASSEMBLY

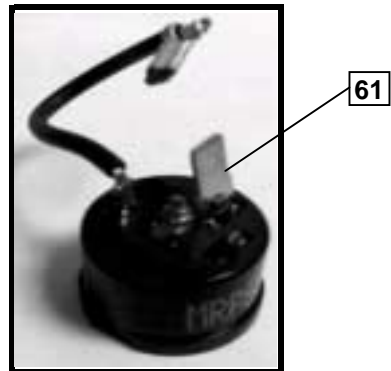
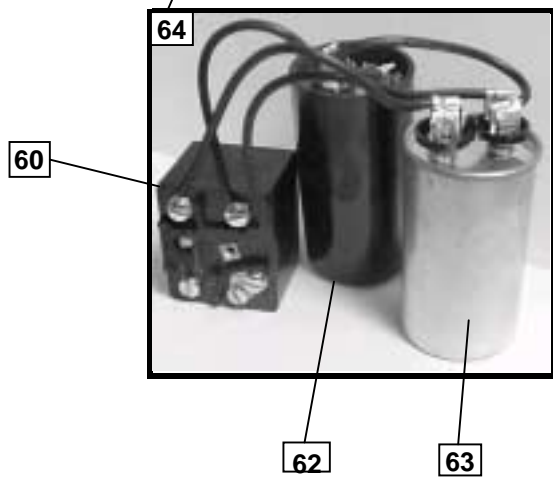
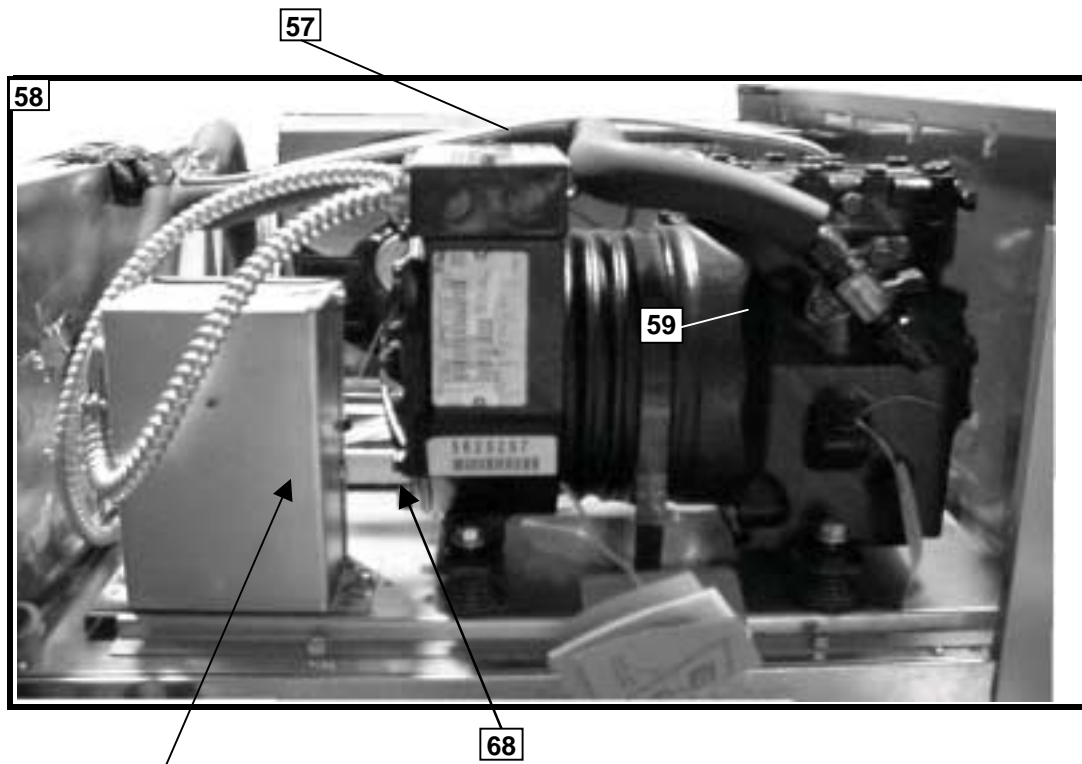
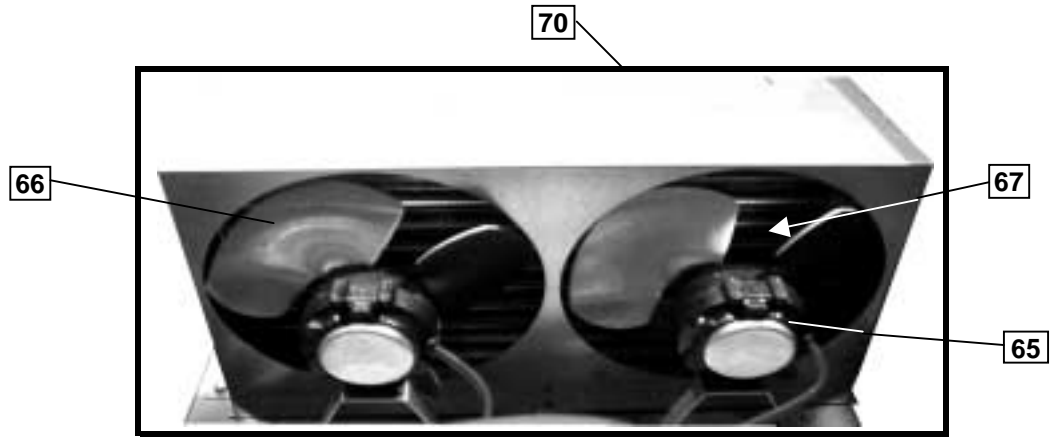

**REACH IN REFRIGERATORS/FREEZERS/ROLL-IN/ROLL-THRU
UNITS
REFRIGERATION
REFRIGERATION SYSTEMS**

ITEM	MODEL	DESCRIPTION	PART NUMBER
48	ER/PR/PRD24-1AS/1AG PRI1-1AS PRT1-1AS PRF24-24(COOLER)	REFRIGERATION SYSTEM ASSEMBLY 115V/60HZ	49B36-293D
	ER/PR24-4AS & 4AG PRI1-4AS	REFRIGERATION SYSTEM ASSEMBLY 220V/50HZ	49B36-295D
	ER/PR/PRD48-1AS & 1AG PRF48-24-1AS COOLER	REFRIGERATION SYSTEM ASSEMBLY 115V/60HZ	49B36-283D
	ER/PR48-4AS & 4AG	REFRIGERATION SYSTEM ASSEMBLY 220V/50HZ	49B36-284D
	ER/PR/PRD48-5AS & 5AG	REFRIGERATION SYSTEM ASSEMBLY 208/230V/60HZ	49B36-285D
	ER/PR/PRD74-1AS & 1AHS PRI2-1AS PRT2-1AS	REFRIGERATION SYSTEM ASSEMBLY 115V/60HZ	49B36-286D
	ER/PR/PRD74-1BG & 1BHG	REFRIGERATION SYSTEM ASSEMBLY 115V/60HZ	49B36-393D-01
	ER/PR74-4AS	REFRIGERATION SYSTEM ASSEMBLY 220V/50HZ	49B36-288D
	ER/PR74-5AS	REFRIGERATION SYSTEM ASSEMBLY 208/230V/60HZ	49B36-287D
	ER/PR74-5BG	REFRIGERATION SYSTEM ASSEMBLY 208/230V/60HZ	49B36-393D-02
	EF/PF24-1AS PRF24-24(FREEZER)	REFRIGERATION SYSTEM ASSEMBLY 115V/60HZ	49B36-384D-01
	EF/PF24-1BG	REFRIGERATION SYSTEM ASSEMBLY 115V/60HZ	49B36-390D-01
	EF/PF24-4AS PRF48-24-1AS FREEZER	REFRIGERATION SYSTEM ASSEMBLY 220V/50HZ	49B36-384D-02
	EF/PF24-4BG	REFRIGERATION SYSTEM ASSEMBLY 220V/50HZ	49B36-390D-03
	EF/PF24-5AS	REFRIGERATION SYSTEM ASSEMBLY 208/230V/60HZ	49B36-384D-03
	EF/PF24-5BG	REFRIGERATION SYSTEM ASSEMBLY 208/230V/60HZ	49B36-390D-02
	EF/PF48-1AS	REFRIGERATION SYSTEM ASSEMBLY 115V/60HZ	49B36-385D-01
	EF/PF48-4AS	REFRIGERATION SYSTEM ASSEMBLY 220V/50HZ	49B36-385D-03
	EF/PF48-4BG	REFRIGERATION SYSTEM ASSEMBLY 220V/50HZ	49B36-391D-02
	EF/PF48-5AS	REFRIGERATION SYSTEM ASSEMBLY 208/230V/60HZ	49B36-385D-02
EF/PF48-5BG	REFRIGERATION SYSTEM ASSEMBLY 208/230V/60HZ	49B36-391D-01	
EF/PF74-5AS	REFRIGERATION SYSTEM ASSEMBLY 208/230/60HZ	49B36-386D-01	
EF/PF74-5BG	REFRIGERATION SYSTEM ASSEMBLY 208V/60HZ	49B36-392D-01	
49	ER/PR/PRD24 PRT1-1AS PRF24-24(COOLER)	EVAPORATOR. COIL. ASSY.	49B31-198C-01
	ER/PR/PRD48 PRF48-24(COOLER) PRF48-24(COOLER) & (REMOTE)	EVAPORATOR. COIL. ASSY.	49B31-166C
	ER/PR/PRD74 PRI2-1AS PRT2-1AS	EVAPORATOR. COIL. ASSY.	49B31-170C
	ER/PR/PRD74-1BG & 1BHG	EVAPORATOR. COIL. ASSY.	49B31-171C
	PRF12-12	EVAPORATOR. COIL. ASSY.(COOLER)	49B31-096D

* INDICATES PARTS NOT ILLUSTRATED

07/24/2000

**REACH IN REFRIGERATORS/FREEZERS/ROLL-IN/ROLL-THRU
UNITS
REFRIGERATION SYSTEMS (CONTINUED)**

ITEM	MODEL	DESCRIPTION	PART NUMBER
49	PRF12-12	EVAPORATOR. COIL. ASSY.(FREEZER)	49B31-097D
	EF/PF24-1AS/5AS PRF24-24(FREEZER)	EVAPORATOR. COIL. ASSY.	49B31-179D
	EF/PF24-1BG/5BG PRF48-24(FREEZER)	EVAPORATOR. COIL. ASSY.	49B31-192C-01
	EF/PF24-4AS	EVAPORATOR. COIL. ASSY.	49B31-202D-01
	EF/PF24-4BG	EVAPORATOR. COIL. ASSY.	49B31-192C-02
	EF/PF48-1AS/5AS	EVAPORATOR. COIL. ASSY.	49B31-177C-01
	EF/PF48-4AS	EVAPORATOR. COIL. ASSY.	49B31-177C-02
	EF/PF48-4BG	EVAPORATOR. COIL. ASSY.	49B31-193C-02
	EF/PF48-5BG	EVAPORATOR. COIL. ASSY.	49B31-193C-01
	EF/PF74-5AS	EVAPORATOR. COIL. ASSY.	49B31-178C-01
	EF/PF74-5BG	EVAPORATOR. COIL. ASSY.	49B31-194C-01
	ER/PR24 (REMOTE)	EVAPORATOR. COIL. ASSY.	49B31-149C
	ER/PR48 (REMOTE)	EVAPORATOR. COIL. ASSY.	49B31-148C
	ER/PR74 (REMOTE)	EVAPORATOR. COIL. ASSY.	49B31-146D
	EF/PF24 (REMOTE)	EVAPORATOR. COIL. ASSY.	49B31-210D-01
	EF/PF48 (REMOTE)	EVAPORATOR. COIL. ASSY.	49B31-208D-01
	EF/PF74 (REMOTE)	EVAPORATOR. COIL. ASSY.	49B31-209D-01
50	ALL EF/PF	THERMOSTAT - DEFROST	502-069A
51	ALL EF/PF	THERMOSTAT - FAN	502-070A
52	ER/PR/PRD24 PRT1-1AS PRF24-24(COOLER) & (REMOTE)	EVAPORATOR COIL (9X7X4)	305-132C
	ER/PR/PRD48 PRF48-24(COOLER) & (REMOTE)	EVAPORATOR COIL (21X7X4)	305-129C
	ER/PR/PRD74 PRI2-1AS/PRT2-1AS & (REMOTE)	EVAPORATOR COIL (35X7X4)	305-171C
	EF/PF24 PRF24-24(FREEZER) PRF48-24(FREEZER) & (REMOTE)	EVAPORATOR COIL (9X7-9/32X6)	305-177C
	EF/PF48 & (REMOTE)	EVAPORATOR COIL (21X7-9/32X6)	305-128C
	EF/PF74 ALL & (REMOTE)	EVAPORATOR COIL (35X7-9/32X6)	305-163C
53	ER/PR/PRD24 PRT1-1AS	SUCTION LINE & CAPILLARY TUBE ASSY.	49B30-193C
	ER/PR/PRD48	SUCTION LINE & CAPILLARY TUBE ASSY.	49B30-188C
	ER/PR/PRD74 PRI2-1AS PRT2-1AS	SUCTION LINE & CAPILLARY TUBE ASSY.	49B30-191C
	ER/PR/PRD74-1BG & 1BHG	SUCTION LINE & CAPILLARY TUBE ASSY.	49B30-098C
	PRF12-12	SUCTION LINE & CAPILLARY TUBE ASSY.(COOLER)	49B30-147D
	PRF12-12	SUCTION LINE & CAPILLARY TUBE ASSY.(FREEZER)	49B30-148D
	PRF24-24	SUCTION LINE & CAPILLARY TUBE ASSY.(COOLER)	49B30-193C

* INDICATES PARTS NOT ILLUSTRATED

07/24/2000

**REACH IN REFRIGERATORS/FREEZERS/ROLL-IN/ROLL-THRU
UNITS
REFRIGERATION SYSTEMS (CONTINUED)**

ITEM	MODEL	DESCRIPTION	PART NUMBER
53	PRF24-24	SUCTION LINE & CAPILLARY TUBE ASSY.(FREEZER)	49B30-227C
	PRF48-24	SUCTION LINE & CAPILLARY TUBE ASSY.(COOLER)	49B30-188C
	PRF48-24	SUCTION LINE & CAPILLARY TUBE ASSY.(FREEZER)	49B30-227C
	EF/PF24-1AS/5AS/4AS	SUCTION/LIQUID LINE ASSY.	49B30-227C
	EF/PF24-1BG/5BG	SUCTION/LIQUID LINE ASSY.	49B30-149C
	EF/PF24-4AS	SUCTION/LIQUID LINE ASSY.	49B30-233C
	EF/PF48-1AS/5AS	SUCTION LINE ASSY	49B30-119C
	EF/PF48-4AS		
	EF/PF48-4BG		
	EF/PF48-5BG		
	EF/PF74-5AS		
	EF/PF74-5BG		
	ER/PR24 (REMOTE)	SUCTION/LIQUID LINE ACCY.	49B30-116C
	ER/PR48 (REMOTE)		
	ER/PR74 (REMOTE)	SUCTION/LIQUID LINE ACCY.	49B30-113C
	EF/PF24 (REMOTE)	SUCTION/LIQUID LINE ACCY.	49B30-112C
EF/PF48 (REMOTE)			
EF/PF74 (REMOTE)			
54	ER/PR/PRD24/48/74 PRT1-1AS PRF12-12(COOLER) PRF24-24(COOLER) PRF48-24(COOLER) &(REMOTE)	ACCUMULATOR	303-012A
	EF/PF24 PRF24-24(FREEZER) PRF48-24(FREEZER)	ACCUMULATOR	303-090A
	EF/PF48/74-5AS & EF74 (REMOTE)	ACCUMULATOR	303-067A
	EF/PF48 (REMOTE)	ACCUMULATOR	303-097A
55	EF/PF48-1AS/4AS/5AS	EXP VALVE FSE-1/2 ZP35	303-131A
	EF/PF48/74-4BG/5BG	EXP VALVE FSE-1/2 ZP35	303-135A
	ER/PR24/48 (REMOTE)	EXP VALVE FJ-1/4-C	303-121A
	ER/PR74 (REMOTE)	EXP VALVE FJ-1/2-C	303-122A
	EF/PF24 (REMOTE)	EXP VALVE	303-134A
	EF/PF48 (REMOTE)	EXP VALVE FSE-1/2 ZP35	303-131A
	EF/PF74 (REMOTE)	EXP VALVE FSE-1/2-ZP-35	303-135A
56	EF/PF48-1AS/5AS	DISTRIBUTOR	303-097A
	EF/PF48-4AS		
	EF/PF48-4BG		
	EF/PF48-5BG		
	EF/PF74-5AS		
	EF/PF74-5BG		
	EF/PF48 (REMOTE)		
	EF/PF74 (REMOTE)		
57	ER/PR/PRD24 PRT1-1AS PRF12-12 (FREEZER)	CAP TUBE .049ID X .099OD X 100	203-127A

**REACH IN REFRIGERATORS/FREEZERS/ROLL-IN/ROLL-THRU
UNITS
REFRIGERATION SYSTEMS (CONTINUED)**

ITEM	MODEL	DESCRIPTION	PART NUMBER
57	ER/PR/PRD48 PRF24-24 (FREEZER) PRF48-24 (COOLER) PRF48-24 (FREEZER) EF/PF24-1AS/5AS/4AS	CAP TUBE .049ID X .099OD X 84	203-132A
	ER/PR/PRD74-1BG & 1BHGPT12-1AS PRT2-1AS	CAP TUBE .054ID X .106OD X 108	203-043A--
	ER/PR/PRD74- 1BG&1BHG	CAP TUBE .062ID X .112OD X 60	203-125A
	PRF12-12 (COOLER)	CAP TUBE .042ID X .093OD X 120	203-056A-A
	PRF12-12 (FREEZER)	CAP TUBE .042ID X .092OD X 96	203-131A
	58	ER/PR/PRD24-1AS/1AG PRI1-1AS PRT1-1AS PRF24-24(COOLER)	CONDENSING UNIT ASSY. 115V-60HZ
ER/PR24-4AS & 4AG PRI1-4AS		CONDENSING UNIT ASSY. 220V-50HZ	49B34-290D-03
ER/PR/PRD48-1AS & 1AG PRF48-24-1AS COOLER		CONDENSING UNIT ASSY. 115V-60HZ	49B34-243D
ER/PR48-4AS & 4AG		CONDENSING UNIT ASSY. 220V-50HZ	49B34-287D-01
ER/PR/PRD48-5AS & 5AG		CONDENSING UNIT ASSY. 208/230V-60HZ	49B34-287D-02
ER/PR/PRD74-1AS & 1AHS PRI2-1AS PRT2-1AS		CONDENSING UNIT ASSY. 115V-60HZ	49B34-247D
ER/PR/PRD74-1BG & 1BHG		CONDENSING UNIT ASSY. 115V-60HZ	49B34-285D-01
ER/PR74-4AS		CONDENSING UNIT ASSY. 220V-50HZ	49B34-286D-02
ER/PR74-5AS		CONDENSING UNIT ASSY. 208/230V-60HZ	49B34-286D-01
ER/PR74-5BG		CONDENSING UNIT ASSY. 208/230V-60HZ	49B34-285D-02
EF/PF24-1AS PRF24-24(FREEZER)		CONDENSING UNIT ASSY. 115V-60HZ	49B34-274D-01
EF/PF24-1BG EF/PF48-24(FREEZER)		CONDENSING UNIT ASSY. 115V-60HZ	49B34-281D-01
EF/PF24-4AS		CONDENSING UNIT ASSY. 220V-50HZ	49B34-274D-02
EF/PF24-4BG		CONDENSING UNIT ASSY. 220V-50HZ	49B34-281D-03
EF/PF24-5AS		CONDENSING UNIT ASSY. 208/230V-60HZ	49B34-274D-03
EF/PF24-5BG		CONDENSING UNIT ASSY. 208/230V-60HZ	49B34-281D-02
EF/PF48-1AS		CONDENSING UNIT ASSY. 115V/60HZ	49B34-272D-01
EF/PF48-4AS		CONDENSING UNIT ASSY. 220V/50HZ	49B34-272D-03
EF/PF48-4BG		CONDENSING UNIT ASSY. 220V/50HZ	49B34-282D-02
EF/PF48-5AS		CONDENSING UNIT ASSY. 208/230V/60HZ	49B34-272D-02
EF/PF48-5BG		CONDENSING UNIT ASSY. 208/230V/60HZ	49B34-282D-01
EF/PF74-5AS		CONDENSING UNIT ASSY. 208/230V/60HZ	49B34-273D-01
EF/PF74-5BG		CONDENSING UNIT ASSY. 208/230V	49B34-283D-01

* INDICATES PARTS NOT ILLUSTRATED

07/24/2000

REACH IN REFRIGERATORS/FREEZERS/ROLL-IN/ROLL-THRU UNITS COMPRESSORS

ITEM	MODEL	DESCRIPTION	PART NUMBER
59	ER/PR/PRD24-1AS/1AG PRI1-1AS PRT1-1AS PRF24-24(COOLER)	COMPRESSOR 1/4HP 115V/60HZ (tec) AEA3430YXA	302-803B
	ER/PR24-4AS & 4AG PRI1-4AS	COMPRESSOR 1/4HP 220V/50HZ (tec) AEA3430YXC	302-648B
	ER/PR/PRD48-1AS & 1AG PRF48-24- 1AS(COOLER)	COMPRESSOR 1/3HP 115V/60HZ (tec) AE3440YXA	302-804B
	ER/PR48-4AS & 4AG	COMPRESSOR 1/3HP 220V/50HZ (tec) AEA3440YXC	302-875B
	ER/PR/PRD48-5AS & 5AG	COMPRESSOR 1/3HP 208/230V/60HZ (tech) AEA4440YXD	302-708B
	ER/PR/PRD74-1AS & 1AHS PRI2-1AS PRT2-1AS	COMPRESSOR 1/2HP 115V/60HZ (tech) AKA4476YXA	302-626B
	ER/PR/PRD74-1BG & 1BHG	COMPRESSOR 3/4HP 115V/60HZ (tech) AKA9451ZXA	302-917B
	ER/PR74-4AS	COMPRESSOR 1/2HP 220V/50HZ (tech) AKA4476YXC	302-824B
	ER/PR74-5AS	COMPRESSOR 1/2HP 208/230V/60HZ (tech) AKA4476YXD	302-861B
	ER/PR74-5BG	COMPRESSOR 3/4HP 230V/60HZ (tech) AKA9451ZXD	302-920B
	EF/PF24-1AS PRF24-24(FREEZER)	COMPRESSOR 1/2HP 115V/60HZ TEC AJA2425ZXA	302-928B
	EF/PF24-1BG EF/PF48-1AS PRF48-24- 1AS(FREEZER)	COMPRESSOR 3/4HP 115V/60HZ (cop) KAMB007ECAA-221	302-912B
	EF/PF24-4AS	COMPRESSOR 1/2HP 220V/50HZ (tech) AJA2425ZXC	302-937B
	EF/PF24-4BG EF/PF/24-5BG EF/PF48-4AS EF/PF48-5AS	COMPRESSOR 3/4HP 208/230V/50/60HZ (cop) KAMB007ECAV	302-956B
	EF/PF24-5AS	COMPRESSOR 1/2HP 208/230V/60HZ(tec)-AJA2425ZXD	302-948B
	EF/PF48-4BG EF/PF48-5BG EF/PF74-5AS	COMPRESSOR 1HP 220V/50/60HZ (cop) KAKB-011E-CAV	302-927B
EF/PF74-5BG	COMPRESSOR 1.5HP 208/230V (cop) KATD015ECAV	302-926B	

RELAYS

ITEM	MODEL	DESCRIPTION	PART NUMBER
60	ER/PR/PRD24-1AS/1AG PRI1-1AS PRT1-1AS PRF24-24(COOLER)	COMPRESSOR RELAY (TI) 9660-042-176	302-646A
	ER/PR24-4AS & 4AG PRI1-4AS	COMPRESSOR RELAY (TEC)8200EMBE64	314-010A
	ER/PR/PRD48-1AS & 1AG PRF48-24- 1AS(COOLER)	COMPRESSOR RELAY (TI) 9660 042 182	302-350A
	ER/PR48-4AS & 4AG	COMPRESSOR RELAY (TI) 9660-042-149	302-399A

* INDICATES PARTS NOT ILLUSTRATED

07/24/2000

**REACH IN REFRIGERATORS/FREEZERS/ROLL-IN/ROLL-THRU
UNITS
RELAYS (CONTINUED)**

ITEM	MODEL	DESCRIPTION	PART NUMBER
60	ER/PR/PRD48-5AS & 5AG	COMPRESSOR RELAY (GE) 3ARR12-PL24	302-915A
	ER/PR/PRD74-1AS & 1AHS PRI2-1AS PRT2-1AS	COMPRESSOR RELAY (GE) 3ARR2-KCR181S	302-290A
	ER/PR/PRD74-1BG & 1BHG	COMPRESSOR RELAY (GE)3ARR3-B3TP4	302-341A
	ER/PR74-4AS	COMPRESSOR RELAY	302-933A
	ER/PR74-5AS	COMPRESSOR RELAY (GE)3ARR2-KCR119S	302-935A
	ER/PR74-5BG	COMPRESSOR RELAY (TEC) 820ARR3C29	302-427A
	EF/PF24-1AS PRF24-24(FREEZER)	COMPRESSOR RELAY(GE)3ARR3-A2M6	302-982A
	EF/PF24-1BG EF/PF48-1AS PRF48-24-1AS(FREEZER)	COMPRESSOR RELAY(GE) 3ARR3CT5P5	302-483A
	EF/PF24-4AS	COMPRESSOR RELAY (GE)3ARR3-A6AB6	314-005A
	EF/PF24-4BG EF/PF/24-5BG EF/PF48-4AS EF/PF48-5AS	COMPRESSOR RELAY(GE) 3ARR3CT-3E5	302-582A
	EF/PF24-5AS	COMPRESSOR RELAY(GE) 3ARR3CT24E5	314-012A
	EF/PF48-4BG EF/PF48-5BG EF/PF74-5AS	COMPRESSOR RELAY (GE) 3ARR3CT24E5	314-016A
	EF/PF74-5BG	COMPRESSOR RELAY(GE) 3ARR3CT6O5	302-541A

OVERLOADS

ITEM	MODEL	DESCRIPTION	PART NUMBER
61	ER/PR/PRD24-1AS/1AG PRI1-1AS PRT1-1AS PRF24-24(COOLER)	COMPRESSOR OVERLOAD (TI)MRP26ALL-69	302-815A
	ER/PR24-4AS & 4AG PRI1-4AS	COMPRESSOR OVERLOAD (TI) MRP 59 AMK-69	302-838A
	ER/PR/PRD48-1AS & 1AG PRF48-24-1AS(COOLER)	COMPRESSOR OVERLOAD (TI)MRT24AIK-69	302-911A
	ER/PR48-4AS & 4AG	COMPRESSOR OVERLOAD (TI)MRP40AMK-69	302-942A
	ER/PR/PRD48-5AS & 5AG	COMPRESSOR OVERLOAD (TI) MRP28AMN-69	302-914A
	ER/PR/PRD74-1AS & 1AHS PRI2-1AS PRT2-1AS	COMPRESSOR OVERLOAD	302-439A
	ER/PR/PRD74-1BG & 1BHG	COMPRESSOR OVERLOAD (TI)MRA5718-114	302-997A
	ER/PR74-4AS	COMPRESSOR OVERLOAD (TI) MRA8962-114	302-356A
	ER/PR74-5AS	COMPRESSOR OVERLOAD (TI) MRA 3786-114	302-464A
	ER/PR74-5BG	COMPRESSOR OVERLOAD (TI) MRA5715-114	302-555A
EF/PF24-1AS PRF24-24(FREEZER)	COMPRESSOR OVERLOAD (TI)CRA4765-134	302-981A	

**REACH IN REFRIGERATORS/FREEZERS/ROLL-IN/ROLL-THRU
UNITS
OVERLOADS (CONTINUED)**

ITEM	MODEL	DESCRIPTION	PART NUMBER
61	EF/PF24-1BG EF/PF48-1AS PRF48-24- 1AS(FREEZER)	COMPRESSOR OVERLOAD (COPE) 071-0092-40	302-484A
	EF/PF24-4AS	COMPRESSOR OVERLOAD (TI)MRA5729-114	313-006A
	EF/PF24-4BG EF/PF/24-5BG EF/PF48-4AS EF/PF48-5AS	COMPRESSOR OVERLOAD (TI) CST18AKN-18	302-473A
	EF/PF24-5AS	COMPRESSOR OVERLOAD (TI)MRA5733-114	313-017A
	EF/PF48-4BG EF/PF48-5BG EF/PF74-5AS	COMPRESSOR OVERLOAD (COP) 071-0092-42	302-979A
	EF/PF74-5BG	COMPRESSOR OVERLOAD (COPE) 071-0099-04	302-539A

START CAPACITORS

ITEM	MODEL	DESCRIPTION	PART NUMBER	
62	EF/PF24-4AS	START CAPACITOR (TEC)855S330C83	315-005A	
	EF/PF24-4BG EF/PF/24-5BG EF/PF48-4AS EF/PF48-5AS	START CAPACITOR 014-0008-51	302-329A	
	EF/PF24-5AS	START CAPACITOR (TEC)855S330C82	315-009A	
	EF/PF48-4BG EF/PF48-5BG EF/PF74-5AS	START CAPACITOR 014-0008-51	302-329A	
	EF/PF74-5BG	START CAPACITOR	302-532A	

RUN CAPACITORS

ITEM	MODEL	DESCRIPTION	PART NUMBER
63	ER/PR/PRD74-1BG & 1BHG	RUN CAPACITOR 85PR370F51	302-554A
	ER/PR74-5BG	RUN CAPACITOR TEC 85PR370E36	302-557A
	EF/PF24-1AS PRF24-24(FREEZER)	RUN CAPACITOR 85PR370E36 15 MFD 370V	302-983A
	EF/PF24-1BG EF/PF48-1AS PRF48-24- 1AS(FREEZER)	RUN CAPACITOR (COP)014-0037-03 (40 MFD@330V)	302-978A
	EF/PF74-5BG	RUN CAPACITOR (COP) 014-0037-23(25 MFD@480V)	302-542A
	EF/PF48-4BG EF/PF48-5BG EF/PF74-5AS	RUN CAPACITOR (COP) 014-0037-18 (40 MFD@440V)	302-980A

**REACH IN REFRIGERATORS/FREEZERS/ROLL-IN/ROLL-THRU
UNITS
CAPACITOR AND RELAY ASSEMBLES**

ITEM	MODEL	DESCRIPTION	PART NUMBER
64	ER/PR/PRD24-1AS/1AG PRI1-1AS PRT1-1AS PRF24-24(COOLER)	NA	NA
	ER/PR24-4AS & 4AG PRI1-4AS	NA	NA
	ER/PR/PRD48-1AS & 1AG PRF48-24- 1AS(COOLER)	NA	NA
	ER/PR48-4AS & 4AG	NA	NA
	ER/PR/PRD48-5AS & 5AG	CAPACITOR & RELAY ASSY. (TEC) AE1355-001B	302-922A
	ER/PR/PRD74-1AS & 1AHS PRI2-1AS PRT2-1AS	CAPACITOR & RELAY ASSY.(TEC) AE1227-021	302-718A
	ER/PR/PRD74-1BG & 1BHG	CAPACITOR & RELAY ASSY. AE1197-028	302-998A
	ER/PR74-4AS	CAPACITOR & RELAY ASSY. (TEC)AE1227-037	302-934A
	ER/PR74-5AS	CAPACITOR & RELAY ASSY. AE1227-039	302-936A
	ER/PR74-5BG	CAPACITOR & RELAY ASSY. (TEC) AE1197-029	302-556A
	EF/PF24-1AS PRF24-24(FREEZER)	CAPACITOR & RELAY ASSY.	302-977A
	EF/PF24-1BG EF/PF48-1AS PRF48-24- 1AS(FREEZER)	CAPACITOR & RELAY ASSY.	302-977A
	EF/PF24-4AS	CAPACITOR & RELAY ASSY. AE1170-047	317-006A
	EF/PF24-4BG EF/PF/24-5BG EF/PF48-4AS EF/PF48-5AS	CAPACITOR & RELAY ASSY.(RBM) 128306-1643EK	302-474A
	EF/PF24-5AS	CAPACITOR & RELAY ASSY. (TEC)AE1170-049	317-013A
	EF/PF48-4BG EF/PF48-5BG EF/PF74-5AS	CAPACITOR & RELAY ASSY. 514-1211-75	317-017A
	EF/PF74-5BG	CAPACITOR & RELAY ASSY. 514-1211-76	317-018A

* INDICATES PARTS NOT ILLUSTRATED

07/24/2000

**REACH IN REFRIGERATORS/FREEZERS/ROLL-IN/ROLL-THRU
UNITS
CONDENSER FAN MOTORS**

ITEM	MODEL	DESCRIPTION	PART NUMBER
65	ER/PR/PRD24-1AS/1AG PRI1-1AS PRT1-1AS PRF24-24(COOLER)	CONDENSER FAN MOTOR 5 WATTS 115V/60HZ	501-019B
	ER/PR24-4AS & 4AG PRI1-4AS	CONDENSER FAN MOTOR 5 WATTS 230V/50/60HZ	501-055B
	ER/PR/PRD48-1AS & 1AG PRF48-24- 1AS(COOLER) ER/PR/PRD74- 1BG&1BHG EF/PF24- 1AS PRF24-24(FREEZER) EF/PF24-1BG EF/PF48-1AS PRF48-24- 1AS(FREEZER)	CONDENSER FAN MOTOR 9 WATTS 115V/60HZ	501-148B
	ER/PR48-4AS/4AG & 4BG ER/PR/PRD48-5AS & 5AG ER/PR/PRD74-1AS & 1AHS PRI2-1AS PRT2-1AS ER/PR74-4AS ER/PR74-5AS EF/PF24-4AS EF/PF24-4AS	CONDENSER FAN MOTOR 9 W 230V-50/60HZ	501-149B
	EF/PF24-5AS/5BG EF/PF48-5AS/5BG EF/PF74-5ASEF PF74-5BG	FAN MOTOR 9 WATTS 208-60	501-043B
	ER/PR74-5BG	FAN MOTOR 25W 230V/50/60HZ	501-058B

**REACH IN REFRIGERATORS/FREEZERS/ROLL-IN/ROLL-THRU
UNITS
CONDENSER FAN BLADES**

ITEM	MODEL	DESCRIPTION	PART NUMBER
66	ER/PR/PRD24-1AS/1AG PRI1-1AS PRT1-1AS PRF24-24(COOLER) ER/PR24-4AS & 4AG PRI1-4AS ER/PR/PRD48-5AS &5AG ER/PR48-4AS & 4AG	CONDENSER FAN BLADE 7.75"	405-012A--
	ER/PR/PRD48-1AS & 1AG PRF48-24- 1AS(COOLER) ER/PR/PRD74- 1BG&1BHG EF/PF24- 1AS PRF24-24(FREEZER) EF/PF24-1BG EF/PF48- 1AS/4AS/4BG/5AS EF/PF48-5BG PRF48-24- 1AS(FREEZER) EF/PF74- 5AS/5BG	CONDENSER FAN BLADE 8.75"	405-034A
	ER/PR/PRD74-1AS & 1AHS PR12-1AS PRT2-1AS ER/PR74-4AS ER/PR74-5AS EF/PF24-1AS PRF24-24(FREEZER) ER/PF24-1BG/5BG EF/PF48-24- 1AS(FREEZER) EF/PF24-4AS/4BG/5AS	CONDENSER FAN BLADE 10" (5 PED ALUM)	405-066B
	ER/PR/PRD74- 1BG&1BHG ER/PR74-5BG	CONDENSER FAN BLADE 10" (4 PED)	405-036A

**REACH IN REFRIGERATORS/FREEZERS/ROLL-IN/ROLL-THRU
UNITS
CONDENSER COILS**

ITEM	MODEL	DESCRIPTION	PART NUMBER
67	ER/PR/PRD24-1AS/1AG PRI1-1AS PRT1-1AS PRF24-24(COOLER) ER/PR24-4AS & 4AG PRI1-4AS	CONDENSER COIL 7-7/8X10-1/2X1-1/4	305-134B
	ER/PR/PRD48-1AS & 1AG PRF48-24-1AS (COOLER) ER/PR48-4AS & 4AG ER/PR/PRD48-5AS & 5AG	CONDENSER COIL 11X10X3	305-130C
	ER/PR/PRD74-1AS & 1AHS PRI2-1AS PRT2-1AS ER/PR74-4AS ER/PR74-5AS	CONDENSER COIL 11X10-7/8X4	305-160C
	ER/PR/PRD74-1BG & 1BHGER/PR74-5BG	CONDENSER COIL 13-1/4X10-7/8X4	305-159C
	EF/PF24-1AS PRF24-24(FREEZER) EF/PF24-1BG EF/PF48-24-1AS(FREEZER) EF/PF24-4AS EF/PF24-4BG EF/PF24-5AS EF/PF24-5BG EF/PF48-1AS	CONDENSER COIL 7-3/4X10X3	305-156C
	EF/PF48-4AS EF/PF48-4BG EF/PF48-5AS EF/PF48-5BG EF/PF74-5AS	CONDENSER COIL 19X10X4	305-127C
	EF/PF74-5BG	CONDENSER COIL 23X11X4	305-162C

**REACH IN REFRIGERATORS/FREEZERS/ROLL-IN/ROLL-THRU
UNITS
CONDENSATE PANS**

ITEM	MODEL	DESCRIPTION	PART NUMBER
68	ER/PR/PRD24-1AS/1AG PRI1-1AS PRT1-1AS PRF24-24(COOLER) PRI1-4AS ER/PR24-4AS & 4AG	CONDENSATE PAN	43B35-009C
	ER/PR/PRD48-1AS & 1AG PRF48- 24-1AS COOLER ER/PR48-4AS & 4AG ER/PR/PRD48-5AS & 5AG	CONDENSATE PAN	43B35-007C
	ER/PR/PRD74-1AS & 1AHS PRI2-1AS PRT2-1AS ER/PR/PRD74-1BG & 1BHG ER/PR74-4AS ER/PR74-5AS ER/PR74-5BG	CONDENSATE PAN	43B35-006C
	EF/PF24-1AS PRF24-24(FREEZER) EF/PF24-4AS PRF48-24-1AS FREEZER EF/PF24-5AS	CONDENSATE PAN	43B35-016C
	EF/PF24-1BG EF/PF24-4BG EF/PF24-5BG	CONDENSATE PAN	43B35-015C
	EF/PF48-1AS EF/PF48-4AS EF/PF48-5AS EF/PF74-5AS EF/PF74-5BG	CONDENSATE PAN	43B35-017C
	EF/PF48-4BG	CONDENSATE PAN	43B35-013C
	EF/PF48-5BG	CONDENSATE PAN	43B35-013C

**REACH IN REFRIGERATORS/FREEZERS/ROLL-IN/ROLL-THRU
UNITS
DRYERS**

ITEM	MODEL	DESCRIPTION	PART NUMBER
	ER/PR/PRD24-1AS/1AG PRI1-1AS PRT1-1AS PRF24-24(COOLER) ER/PR24-4AS & 4AG PRI1-4AS ER/PR/PRD48-1AS & 1AG PRF48-24-1AS COOLER ER/PR48-4AS & 4AG ER/PR/PRD48-5AS & 5AG	DRYER (R-12/134/404)	303-126A
*69	ER/PR/PRD74-1AS & 1AHS PRI2-1AS PRT2-1AS ER/PR74-4AS ER/PR74-5AS	DRYER (R-134A & R-12)	303-127A
	ER/PR/PRD74-1BG & 1BHG EF/PF24-1AS PRF24-24(FREEZER) EF/PF24-1BG EF/PF48-24(FREEZER) EF/PF24-4AS EF/PF24-4BG EF/PF24-5AS EF/PF24-5BG EF/PF48-1AS EF/PF48-4AS EF/PF48-4BG EF/PF48-5AS EF/PF48-5BG EF/PF74-5AS EF/PF74-5BG	DRYER (R-134/404/502)	303-129A

**REACH IN REFRIGERATORS/FREEZERS/ROLL-IN/ROLL-THRU
UNITS
CONDENSER FAN SHROUDS**

ITEM	MODEL	DESCRIPTION	PART NUMBER
70	ER/PR/PRD24-1AS/1AG PRI1-1AS PRT1-1AS PRF24-24(COOLER) ER/PR24-4AS & 4AG PRI1-4AS	CONDENSER FAN SHROUD	49A36-026C
	ER/PR/PRD48-1AS & 1AG PRF48-24-1AS COOLER ER/PR48-4AS & 4AG ER/PR/PRD48-5AS & 5AG	CONDENSER FAN SHROUD	49A36-023C
	ER/PR/PRD74-1AS & 1AHS PRI2-1AS PRT2-1AS ER/PR/PRD74-1BG & 1BHG ER/PR74-4AS ER/PR74-5AS ER/PR74-5BG	CONDENSER FAN SHROUD	49A36-024C
	EF/PF24-1AS PRF24-24(FREEZER) EF/PF24-1BG EF/PF48-24(FREEZER) EF/PF24-4AS EF/PF24-4BG EF/PF24-5AS EF/PF24-5BG	CONDENSER FAN SHROUD	NA
	EF/PF48-1AS EF/PF48-4AS EF/PF48-4BG EF/PF48-5AS EF/PF48-5BG EF/PF74-5AS	CONDENSER FAN SHROUD	49A36-019C
	EF/PF74-5BG	CONDENSER FAN SHROUD	49A36-027C

DEFROST HEATERS

ITEM	MODEL	DESCRIPTION	PART NUMBER
71	EF/PF24-1AS/5AS PRF24-24(FREEZER) PRF48-24(FREEZER) EF/PF24-1BG/5BG EF/PF24-4AS EF/PF24-4BG & (REMOTE)	HEATER - DEFROST 115V	504-516B
	EF/PF48-1AS/5AS/5BG	HEATER - DEFROST 115V	504-517B
	EF/PF48-4AS/4BG & (REMOTE)	HEATER - DEFROST 220V	504-518B
	EF/PF74-5AS/5BG & (REMOTE)	HEATER - DEFROST 115V	504-520B

* INDICATES PARTS NOT ILLUSTRATED

07/24/2000