

# **BEVERAGE-AIR**

**PARTS  
MANUAL**

**FOR**

**EF/ER/PF/PR/PRF/PRI/PRT/PFI  
PW/PWT/PWD**



**ALL PURPOSE COLD ®**

**TOP MOUNT REACH -IN/PASS -THRU  
DUAL TEMP REFRIGERATORS, FREEZERS  
AND WARMING CABINETS**

**115V/60HZ**

**220V/60HZ**

**220V/50HZ**

| PART                                    | PAGE  |
|---|-------|
| Accumulators                            | 10    |
| Ballast                                 | 5     |
| Cabinet Face Heaters                    | 4     |
| Cabinet Heating Elements(Warming Units) | 5     |
| Capillary Tubes                         | 10-11 |
| Casters & Leg Kits                      | 3     |
| Compressor Capacitor Relay Assemblies   | 15    |
| Compressor Overloads                    | 13-14 |
| Compressor Relays                       | 12-13 |
| Compressor Run Capacitors               | 14    |
| Compressor Start Capicitors             | 14    |
| Compressors                             | 12    |
| Condenser Fan Shrouds                   | 21    |
| Condenser Coils                         | 18    |
| Condenser Fan Blades                    | 17    |
| Condenser Fan Motors                    | 16    |
| Condensate Drain Pans                   | 19    |
| Condensing Units                        | 11    |
| Defrost Heaters                         | 21    |
| Defrost Timers                          | 4     |
| Distributors                            | 10    |
| Door Assemblies Complete                | 2     |
| Door Brakers                            | 2     |
| Door Gaskets                            | 2     |
| Door Handles                            | 2     |
| Door Hinges                             | 2     |
| Door Lock Strike Plate                  | 2     |
| Door Locks                              | 2     |
| Door Sweep(Roll in/Roll Through)        | 2     |
| Drain Line Heaters                      | 4     |
| Dryers                                  | 20    |
| Edge-mount Hinge Switch                 | 4     |
| Evaporator Coil Assemblies              | 8-9   |
| Evaporator Coils                        | 9     |
| Evaporator Drain Pans                   | 3-4   |
| Evaporator Fan Blades                   | 3     |
| Evaporator Fan Motors                   | 3     |
| Evaporator Housings                     | 3     |
| Evaporator Lid Gaskets                  | 4     |
| Expansion Valves                        | 10    |
| High Temp. Lights                       | 3     |
| High Temp. Limit Switch                 | 5     |
| Humidity Control Assy.(Warming units)   | 4     |
| Humidity Controls(Warming units)        | 3     |
| Instrument Panels                       | 3     |
| Lamps                                   | 5     |
| Light Shields                           | 5     |
| Power Kill Switch(Warming Units)        | 5     |
| Refrigeration Assemblies                | 8     |
| Shelving                                | 5     |
| Strike Plate for light switch           | 2     |
| Suction Line Assemblies                 | 9-10  |
| Temperature Controls                    | 4     |
| Temperature indicators                  | 3     |
| Terminal Boards                         | 4     |
| Top Grilles                             | 3     |
| Vacuum Vents                            | 2     |

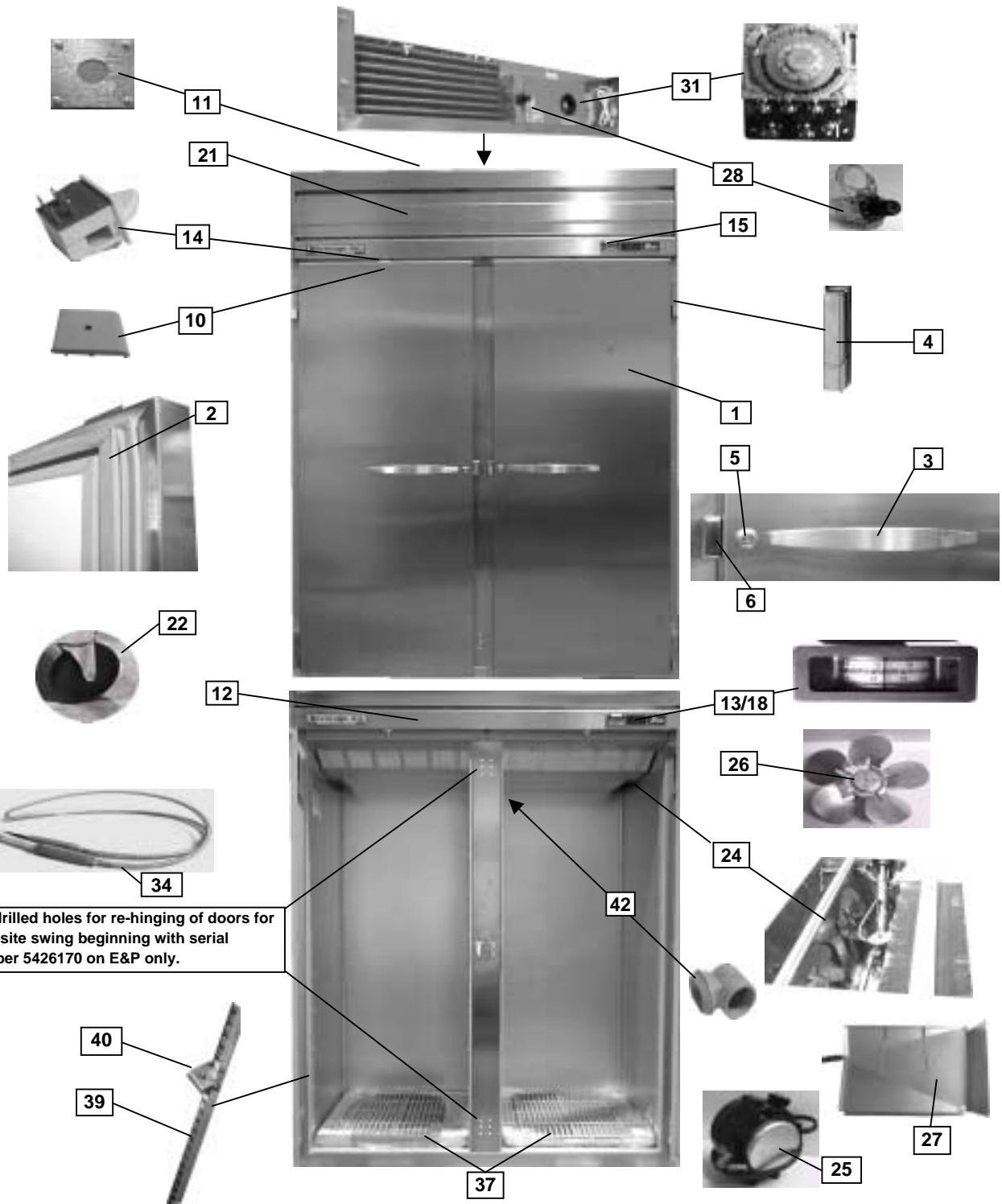

Pre-drilled holes for re-hinging of doors for opposite swing beginning with serial number 5426170 on E&P only.

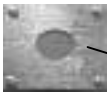

11

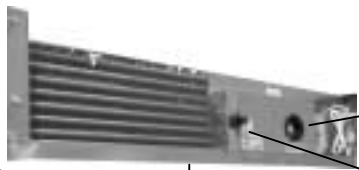

31

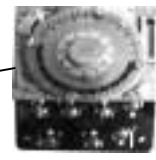

28



14



15



10

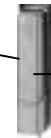

4



2

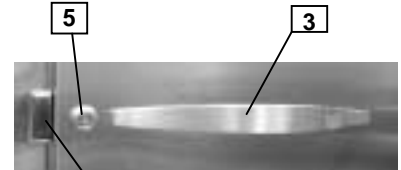

3



22

5

6

12

13/18



34



26

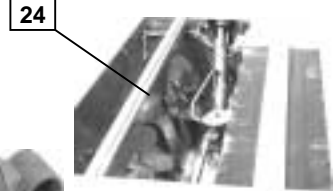

24

42

Pre-drilled holes for re-hinging of doors for opposite swing beginning with serial number 5426170 on E&P only.

40

39

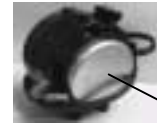

25



27

37

# REACH IN REFRIGERATORS/FREEZERS/ROOL-IN/ROOL-THRU AND WARMING UNITS

## DOORS

| ITEM | MODEL                                   | DESCRIPTION                                   | PART NUMBER   |
|------|---|---|---------------|
| 1    | ER/PR/EF/PF24/48/74                     | DOOR ASSY - RH SS/AL (FULL)                   | 40B32-718D    |
|      | ER/PR/EF/PF24/48/74                     | DOOR ASSY - LH SS/LH (FULL)                   | 40B48-025D-02 |
|      | ER/PR/EF/PF24/48/74                     | DOOR ASSY - RH (FULL GLASS)                   | 40B32-794D    |
|      | ER/PR/EF/PF48/74                        | DOOR ASSY - LH (FULL GLASS)                   | 40B48-027D-01 |
|      | ER/PR/EF/PF24/48/74<br>PRF12-12/24-24   | DOOR ASSY - RH TOP SS/AL (HALF)               | 40B32-687D    |
|      | ER/PR/EF/PF24/48/74<br>PRF24-24         | DOOR ASSY - RH BOT SS/AL (HALF)               | 40B32-705D    |
|      | ER/PR/EF/PF24/48/74<br>PRF12-12/48-24   | DOOR ASSY - RH TOP(HALF GLASS)                | 40B32-795D    |
|      | ER/PR/EF/PF24/48/74                     | DOOR ASSY - RH BOT (HALF GLASS)               | 40B48-029D-02 |
|      | PRF12-12                                | DOOR ASSY - RH BOT SS/AL (HALF)               | 40B32-971D    |
|      | PRF24-24                                | DOOR ASSY - LH TOP SS/AL (HALF)               | 40B32-678D    |
|      | PRF24-24                                | DOOR ASSY - LH BOT SS/SS (HALF)               | 40B32-690D    |
|      | PRF48-24                                | DOOR ASSY - LH TOP (HALF)                     | 40B48-028D-01 |
|      | PRF48-24                                | DOOR ASSY - LH BOT SS/AL (HALF)               | 40B32-696D    |
|      | PRT/PR/PFI 1<br>PRI 2                   | DOOR ASSY - RH SS/SS                          | 40B32-720D    |
|      | PRT/PR/PFI 2                            | DOOR ASSY - LH SS/SS                          | 40B48-026D-01 |
|      | PW/PWD24                                | DOOR ASSY - RH SS/SS                          | 40B32-856D    |
|      | PW/PWD48                                | DOOR ASSY - RH SS/AL                          | 40B32-859D    |
|      | PW/PWD48                                | DOOR ASSY - LH SS/AL                          | 40B48-025D-04 |
|      | PWI 1/ PWI 2                            | DOOR ASSY - RH SS/AL                          | 40B32-836D    |
|      | PWI 2                                   | DOOR ASSY - LH SS/AL                          | 40B48-026D-04 |
| 2    | ER/PR/EF/PF24/48/74<br>PW/PWD24         | DOOR GASKET (FULL DOOR)                       | 712-012D-02   |
|      | ER/PR/EF/PF24/48/74<br>PRF12-12/24-24   | DOOR GASKET (HALF DOOR)                       | 712-012D-01   |
|      | PRT/PR/PFI 1<br>PRI 2<br>PWI 1<br>PWI 2 | DOOR GASKET (FULL DOOR)                       | 703-963D-10   |
| 3    | ALL                                     | DOOR HANDLE                                   | 401-502C      |
| 4    | ALL                                     | DOOR HINGE                                    | 401-657B      |
| 5    | ALL SOLID DOORS                         | DOOR LOCK                                     | 401-510A      |
| ITEM | MODEL                                   | DESCRIPTION                                   | PART NUMBER   |
| 6    | ALL SOLID DOORS                         | DOOR LOCK STRIKE PLATE                        | 401-604B      |
| *7   | ER/PR/EF/PF24/48/74                     | *DOOR BRKR - TOP & BOTTOM (FULL & HALF GLASS) | 40A33-161B    |
| *8   | ER/PR/EF/PF24/48/74                     | *DOOR BRKR - (L&R) (FULL GLASS ONLY)          | 40A33-193B    |
|      | ER/PR/EF/PF24/48/74                     | *DOOR BRKR - (L&R) (HALF GLASS ONLY)          | 40A33-192B    |
| *9   | PRT/PR/PFI 1<br>PRI 2<br>PWI 1<br>PWI 2 | * DOOR WIPER SWEEP(BOTTOM)                    | 703-671B      |
| 10   | ALL                                     | STRIKE PLATE -LIGHT SWITCH                    | 60D32-019B    |
| 11   | ALL                                     | VACUUM VENT                                   | 59D42-016A    |

**NOTE: DOOR BREAKERS ON SOLID DOORS ARE NOT REPLACEABLE.**

All E-series units with solid doors (full & half) are pre-drilled for field re-hinging as of serial number 5426170.  
Glass door units can not be re-hinged in the field due to wiring for door frame glass heaters.

# REACH IN REFRIGERATORS/FREEZERS/ROOL-IN/ROOL-THRU AND WARMING UNITS

## INSTRUMENT PANELS

| ITEM  | MODEL  | DESCRIPTION                   | PART NUMBER                |
|-------|--|-------------------------------|----------------------------|
| 12    | ER/EF24  | INST PANEL ASSY - SS          | 50B36-078D-01              |
|       | PR/PF24  | INST PANEL ASSY - SS          | 50B36-078D-02              |
|       | ER/EF48  | INST PANEL ASSY - SS          | 50B36-079D-01              |
|       | PR/PF48  | INST PANEL ASSY - SS          | 50B36-079D-02              |
|       | EF/ER74  | INST PANEL ASSY - SS          | 50B36-080D-01              |
|       | PF/PR74  | INST PANEL ASSY - SS          | 50B36-080D-02              |
|       | PRF12-12   | INST PANEL ASSY - SS          | 50B36-078D-07              |
|       | PRF24-24   | INST PANEL ASSY - SS          | 50B36-019C                 |
|       | PRF48-24   | INST PANEL ASSY - SS          | 50B36-020C                 |
|       | PRT 1  | FRONT INST PANEL ASSY - SS    | 50B36-028C                 |
|       | PRT 1  | *REAR INST. PANNEL ASSY. - SS | 50B36-030C                 |
|       | PRT 2 / PFI 2  | INST PANEL ASSY - SS          | 50B36-029C                 |
|       | PFI 1  | INST PANEL ASSY - SS          | 50B36-028C                 |
|       | PW/PWD24   | INST PANEL ASSY               | 50B36-035C                 |
|       | PW/PWD48   | INST PANEL ASSY               | 50B36-036C                 |
|       | PWI 1  | INST PANEL ASSY               | 50B36-065D                 |
|       | PWI 2  | INST PANEL ASSY               | 50B36-066D                 |
|       | PWD24  | *REAR INST. PANNEL ASSY. - SS | 50B36-078D-09              |
| PWD48 | *REAR INST. PANNEL ASSY. - SS                              | 50B36-079D-07                 |                            |
| 13    | ER/EF24  | THERMOMETER -(DRUM)           | 402-218B                   |
| 14    | ALL  | ROCKER SWITCH                 | <a href="#">502-198A</a>   |
| 15    | ALL  | POWER LIGHT GREEN             | <a href="#">503-056A</a>   |
| *16   | ALL  | *INSTRUMENT MOUNTING PLATE    | <a href="#">806-075B</a>   |
| *17   | ALL  | *.250 RETAINER RING           | <a href="#">604-143A</a>   |
| *18   | PR/PF24/48/74<br>PRF12-12 PRF24<br>24 PRF48-24<br>PWD24/48 | * DIGITAL TEMP INDICATOR ASSY | <a href="#">62B03-003B</a> |
|       | PRT 1<br>PRT 2<br>PFI 1 & 2                                | * DIGITAL TEMP INDICATOR ASSY | 50B29-001B                 |
| *19   | ALL PWD  | *HIGH TEMP LIGHT              | <a href="#">503-057A</a>   |
| *20   | ALL PWD  | * HUMIDITY CONTROL KNOB       | 502-131A                   |

## GRILLS

| ITEM | MODEL                                 | DESCRIPTION                       | PART NUMBER                |
|------|---------------------------------------|-----------------------------------|----------------------------|
| 21   | ER/PR/EF/PF24<br>PRF12-12<br>PW/PWD24 | TOP GRILLE ASSY - SS              | <a href="#">44B31-219C</a> |
|      | ER/PR/EF/PF48<br>PRF24-24<br>PW/PWD48 | TOP GRILLE ASSY - SS              | <a href="#">44B31-221C</a> |
|      | ER/PR/EF/PF74<br>PRF48-24             | TOP GRILLE ASSY - SS              | <a href="#">44B31-223C</a> |
|      | PRT 1<br>PWI 1                        | TOP GRILLE ASSY - SS              | <a href="#">44B31-103C</a> |
|      | PRT 2<br>PFI 2<br>PWI 2               | TOP GRILLE ASSY - SS              | <a href="#">44B31-104C</a> |
| 22   | ER/EF24/48/74                         | 5IN CASTER KIT EF/ER              | <a href="#">61C01-001A</a> |
| *23  | PR/PF24/48/74                         | * 6" LEG PKG ASSY. (SATIN NICKEL) | 59B36-011A                 |

**REACH IN REFRIGERATORS/FREEZERS/ROLL-IN / ROLL-THROUGH  
AND WARMING UNITS  
INTERIOR PARTS**

| ITEM   | MODEL  | DESCRIPTION  | PART NUMBER          |          |
|--------|--|--|----------------------|----------|
| 24     | ER/PR24-1AS<br>PRF24-24 REF.   | EVAPORATOR HOUSING 115V/60HZ                       | 42B31-090B           |          |
|        | EF/PF24-1AS<br>PRF24-24 FREEZER<br>PRF48-24 FREEZER  | EVAPORATOR HOUSING 115V/60HZ                       | 42B31-091B           |          |
|        | ER/PR48-1AS  | EVAPORATOR HOUSING 115V/60HZ                       | 42B31-083C           |          |
|        | EF/PF48-1AS  | EVAPORATOR HOUSING 115V/60HZ                       | 42B31-081C           |          |
|        | ER/PR74-1AS  | EVAPORATOR HOUSING 115V/60HZ                       | 42B31-097C           |          |
|        | EF/PF74-5AS  | EVAPORATOR HOUSING 115V/60HZ                       | 42B31-096C           |          |
|        | PRF12-12 REF.  | EVAPORATOR HOUSING 115V/60HZ                       | 42B31-127D           |          |
|        | PRF12-12 FREEZER   | EVAPORATOR HOUSING 115V/60HZ                       | 42B31-130D           |          |
|        | PRF48-24 REF.  | EVAPORATOR HOUSING 115V/60HZ                       | 42B31-037C           |          |
|        | PRT/PRI 1  | EVAPORATOR HOUSING 115V/60HZ                       | 42B31-090B           |          |
|        | PRT/PRI 2  | EVAPORATOR HOUSING 115V/60HZ                       | 42B31-034B           |          |
|        | PWD24<br>PWI 1<br>PWT1   | EVAPORATOR HOUSING 115V/60HZ                       | 42B31-132C           |          |
|        | PWD48  | EVAPORATOR HOUSING 115V/60HZ                       | 42B31-133C           |          |
|        | ER/PR24-4  | EVAPORATOR HOUSING 220V/50HZ                       | 42B31-092B           |          |
|        | ER/PR48-4  | EVAPORATOR HOUSING 220V/50HZ                       | 42B31-084C           |          |
|        | ER74-5   | EVAPORATOR HOUSING 208-230V/60HZ                   | 42B31-097C           |          |
| ER74-4 | EVAPORATOR HOUSING 220V/50HZ   | 42B31-098C   |                      |          |
| 25     | ER/PR24-1AS<br>PRF24-24 REF.<br>PRT/PRI 1  | EVAPORATOR FAN MOTOR ( 5 WATTS 115-60)             | 501-019B             |          |
|        | EF/PF24-1AS<br>PRF24-24 FREEZER<br>PRF48-24 FREEZER<br>PR/ER/PF/EF48/74<br>PRT/PRI 2<br>ER/EF74-5<br>PR/PF74-5 | EVAPORATOR FAN MOTOR ( 9 WATTS 115-60)             | 501-148B             |          |
|        | PRF12-12 REF<br>PRF 12-12 FREEZER<br>PRF48-24 REF.<br>PRF48-12 FREEZER   | EVAPORATOR FAN MOTOR (.65 AMPS 120-60)             | 501-076B             |          |
|        | PWD24/48<br>PWI 1<br>PWT1  | EVAPORATOR FAN MOTOR ( 4 WATTS)                    | 501-090B             |          |
|        | ER/PR24-4  | EVAPORATOR FAN MOTOR ( 5 WATTS 230-50/60)          | 501-055B             |          |
|        | ER/PR/48/74-4  | EVAPORATOR FAN MOTOR ( 9 W 230-50/60)              | 501-149B             |          |
|        | 26   | ALL ER/EF/PR/PF/PRT<br>PRI/PW/PRF24-24<br>PRF48-24 | EVAPORATOR FAN BLADE | 405-033A |
|        |  | PRF12-12 REF.<br>PRF12-12 FREEZER                  | EVAPORATOR FAN BLADE | 405-062A |
| 27     | ER/EF/PR/PF24<br>PRF24-24<br>PRF48-24( REF.SIDE)<br>PRT/PRI 1  | EVAPORATOR DRAIN PAN                               | 43B32-232B           |          |
|        | ER/EF/PR/PF48  | EVAPORATOR DRAIN PAN                               | 43B32-234B           |          |

(\* ) INDICATES PARTS NOT ILLUSTRATED

07/24/2000

**REACH IN REFRIGERATORS/FREEZERS/ROLL-IN / ROLL-THROUGH  
AND WARMING UNITS  
INTERIOR PARTS (CONTINUED)**

| ITEM | MODEL  | DESCRIPTION                    | PART NUMBER |
|------|--|--------------------------------|-------------|
| 27   | ER/EF/PR/PF74<br>PRT/PRI 2   | EVAPORATOR DRAIN PAN           | 43B32-236B  |
|      | PRF12-12   | EVAPORATOR DRAIN PAN (2)       | 43B32-134B  |
|      | PRF48-24(FREEZER)  | EVAPORATOR DRAIN PAN           | 43B32-020B  |
| 28   | ER/PR24/48/74<br>PRF12-12 COOLER<br>PRF24-24 COOLER<br>PRF48-24 COOLER<br>PRI1<br>PRI2<br>PRT1<br>PRT2 | TEMPERATURE CONTROL            | 502-290B    |
|      | EF/PF24/48/74<br>PRF12-12 FREEZER<br>PRF24-24 FREEZER<br>PRF48-24 FREEZER                              | TEMPERATURE CONTROL            | 502-147A    |
|      | PW24/48<br>PWD24/48<br>PWI1<br>PWI2<br>PWT2  | TEMPERATURE CONTROL            | 502-130A    |
| 29   | PW24/48  | * HUMIDITY CONTROL ASS'Y       | 51B30-008B  |
| 30   | ALL PW UNITS   | *HIGH TEMP. LIMIT SWITCH       | 502-133A    |
| 31   | ALL FREEZERS (115V)  | DEFROST TIMER                  | 502-115A    |
|      | ALL FREEZERS (220V)  | DEFROST TIMER                  | 502-108A    |
| 32   | ALL FREEZERS   | *TERMINAL BOARD ASSY (FREEZER) | 505-094A    |
|      | ALL COOLERS  | * TERMINAL BOARD ASSY (REFRIG) | 505-095A    |
| *33  | ER/PR/EF/PF24<br>PRF24-24/PW24   | *EVAPORATOR LID HOUSING GASKET | 703-584C    |
|      | ER/PR/EF/PF48<br>PRF48-24<br>PW48  | *EVAPORATOR LID HOUSING GASKET | 703-585C    |
|      | ER/PR/EF/PF74  | *EVAPORATOR LID HOUSING GASKET | 703-586C    |
|      | PRT2/PRI2/PWI2/PWT2  | *EVAPORATOR LID HOUSING GASKET | 703-663C    |
|      | PRI1/PWI1/PWT1   | *EVAPORATOR LID HOUSING GASKET | 703-662C    |
| 34   | PRF12-12   | DRAIN TUBE HEATER              | 504-539B    |
| *35  | PR/ER/PF/PRD/EF24/4<br>8 & 74<br>PRF24-24<br>PRF48-24  | *CABINET FACE HEATER           | 504-256B    |
|      | PRF12-12   | *CABINET FACE HEATER           | 504-276B    |
| *36  | PRF12-12   | *EDGEMOUNT HINGE SWITCH        | 502-137A    |

(\*) INDICATES PARTS NOT ILLUSTRATED

07/24/2000

# REACH IN REFRIGERATORS/FREEZERS/ROLL-IN/ROLL-THRU AND WARMING UNITS

## SHELVING

| ITEM | MODEL                   | DESCRIPTION          | PART NUMBER |
|------|-------------------------|----------------------|-------------|
| 37   | ER/EF/PR/PF24/48/74     | SHELF 20.82X26       | 403-507D    |
|      | PRF12-12                |                      |             |
|      | PRF24-24                |                      |             |
|      | PRF48-24                |                      |             |
| 38   | ER/EF/PR/PF48/74        | SHELF - CTR 5X10.875 | 403-212D    |
|      | PRF48-24                |                      |             |
| 39   | ER/PR/EF/PF24/48/74     | PILASTER 56"         | 401-273A    |
|      | PRF24-24                |                      |             |
|      | PRF48-24                |                      |             |
| 40   | PRF12-12                | PILASTER-26-1/2      | 403-336A    |
|      | ALL/PW                  | PILASTER STD         | 59D35-041C  |
|      | ALL ER/EF/PR/PF/PRT PRI | SHELF CLIP           | 403-168A    |
|      | PRF12-12/PRF24-24       |                      |             |
|      | PRF48-24                |                      |             |
|      | PW24                    | SHELF CLIP           | 403-077A-A  |

## LIGHTING

| ITEM | MODEL   | DESCRIPTION   | PART NUMBER |
|------|---|---|-------------|
| *41  | ER/EF/PR/PF/PRF/PRT/PRI<br>&PRD WITH SOLID DOORS    | * LAMP (INC) 40W (40T10)                            | 503-071A    |
|      | ER/EF/PR/PF<br>WITH GLASS DOORS                     | *LAMP (FLO) 75W (F60T12/D/HO)                       | 503-084A    |
| 42   | ER/EF/PR/PF/PRF/PRT/PRI<br>&PRD<br>WITH SOLID DOORS | LIGHT SOCKET (SINGLE)                               | 503-048A--  |
|      | ER/EF/PR/PF<br>WITH GLASS DOORS                     | * LAMP HOLDER-PLUNGER                               | 503-172A    |
|      | ER/EF/PR/PF<br>WITH GLASS DOORS                     | *LAMP HOLDER-STATIONARY                             | 503-173A    |
| *43  | ER/EF/PR/PF<br>WITH GLASS DOORS                     | * BALLAST (1,2) 60W 115/120-60                      | 503-094A    |
| *44  | ER/EF/PR/PF<br>WITH GLASS DOORS                     | *SHIELD - LAMP W / END CAPS 60"                     | 703-478A    |
|      | ER/EF/PR/PF/PRF/PRT/PRI<br>&PRD<br>WITH SOLID DOORS | * INTERIOR LIGHT SHIELD (FOR<br>INCANDESCENT LIGHT) | 28D25-001A  |

## WARMING CABINET HEATERS & SWITCHES

| ITEM | MODEL   | DESCRIPTION                          | PART NUMBER |
|------|---------|--------------------------------------|-------------|
| *45  | PW24/48 | CABINET HEATING ELEMENT - 800WT 115V | 504-362C    |
|      | PW11-1S | CABINET HEATING ELEMENT 115          | 504-715C-01 |
|      | PW12-5S |                                      |             |
|      | PWT1-1S |                                      |             |
|      | PWT2-5S |                                      |             |
| *46  | PW24/48 | * HI-LIMIT SWITCH 240V               | 502-133A    |
|      | PW11-1S |                                      |             |
|      | PW12-5S |                                      |             |
|      | PWT2-5S |                                      |             |
| *47  | PW24/48 | *POWER / KILL- SWITCH                | 502-136A    |
|      | PW11-1S |                                      |             |
|      | PW12-5S |                                      |             |
|      | PWT2-5S |                                      |             |

(\*) INDICATES PARTS NOT ILLUSTRATED

07/24/2000



# ILLUSTRATIONS FOR REFRIGERATION ASSEMBLY

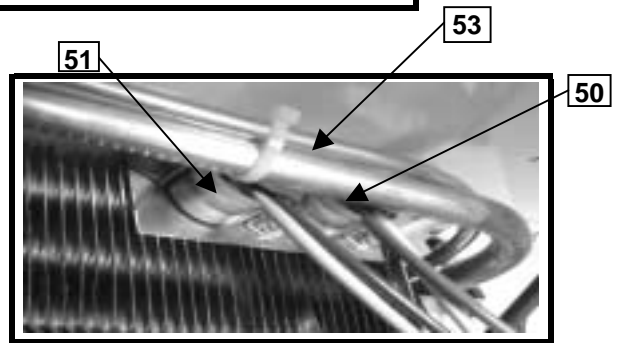
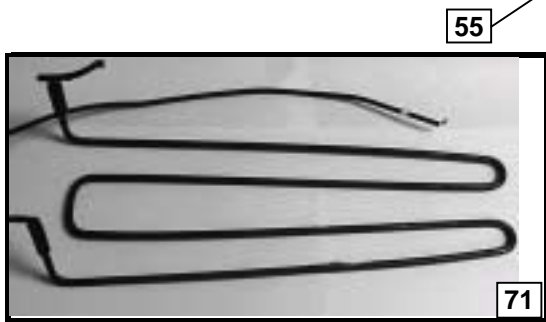
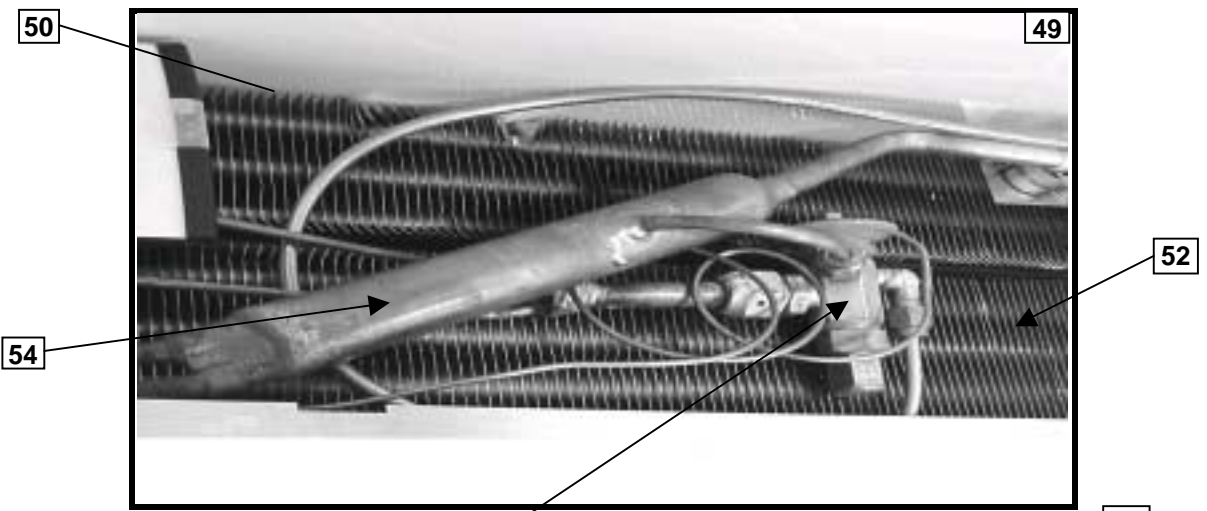
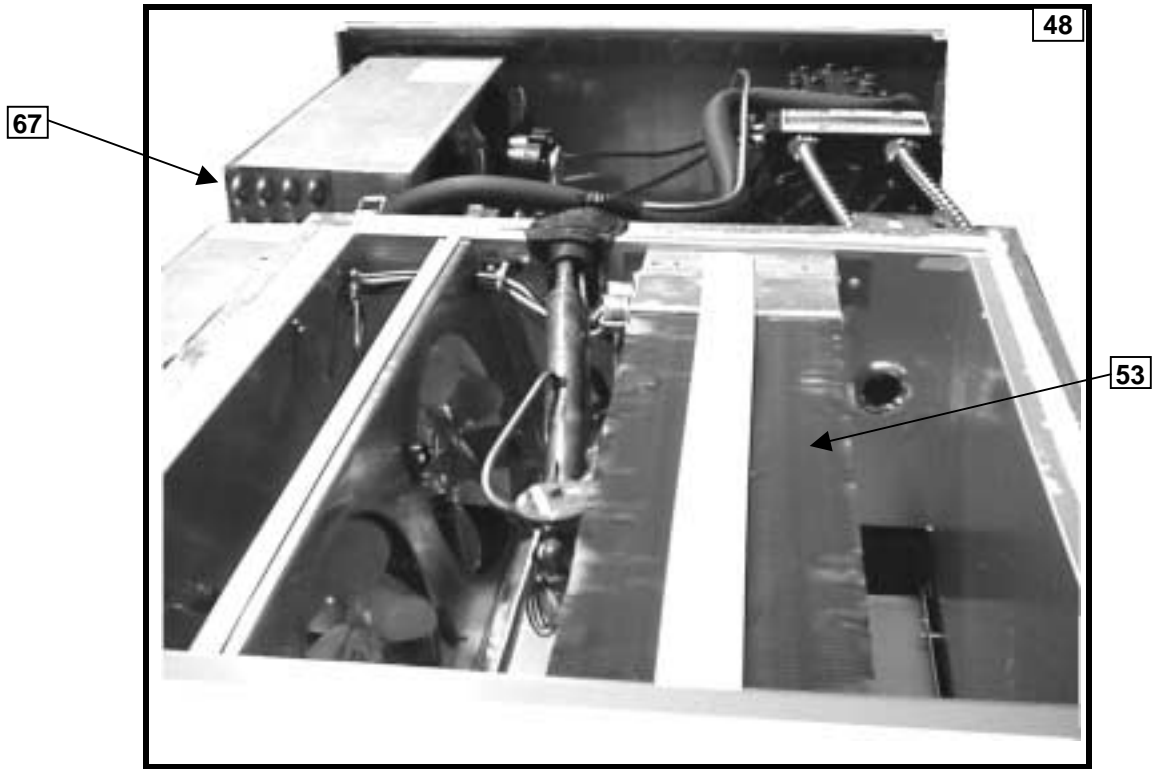

# ILLUSTRATIONS FOR REFRIGERATION ASSEMBLY

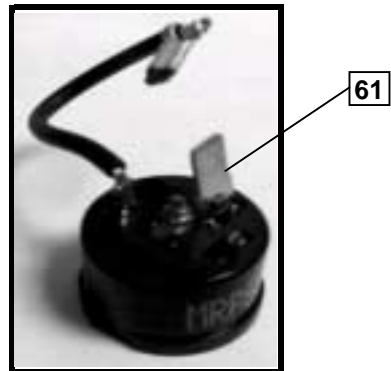
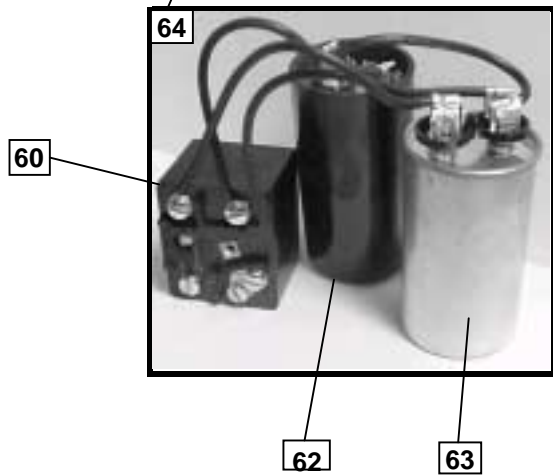
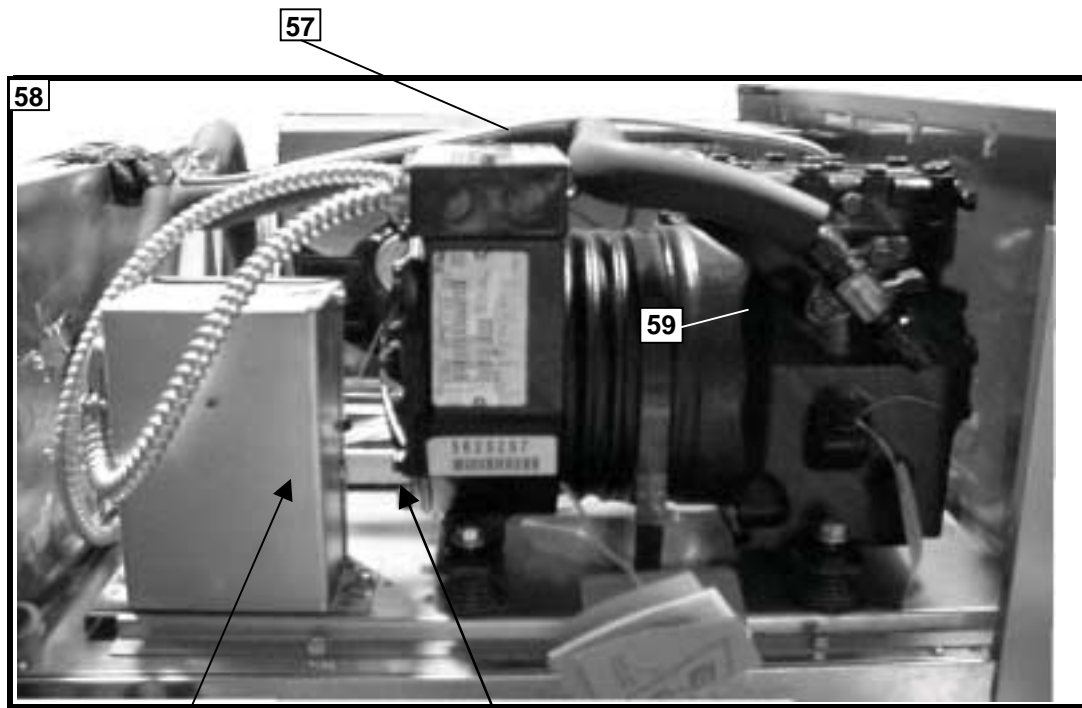
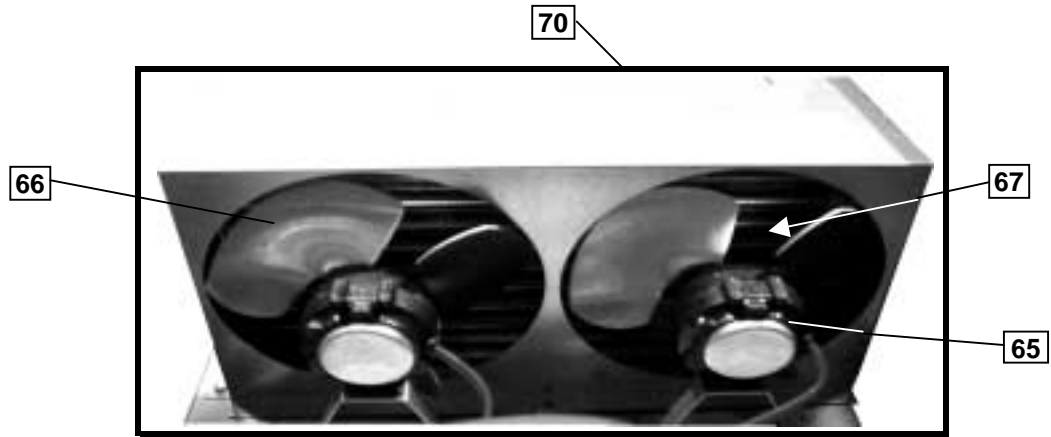

**REACH IN REFRIGERATORS/FREEZERS/ROLL-IN/ROLL-THRU  
UNITS  
REFRIGERATION  
REFRIGERATION SYSTEMS**

| ITEM        | MODEL   | DESCRIPTION                                 | PART NUMBER   |
|-------------|---|---|---------------|
| 48          | ER/PR/PRD24-1AS/1AG<br>PRI1-1AS<br>PRT1-1AS<br>PRF24-24(COOLER)   | REFRIGERATION SYSTEM ASSEMBLY 115V/60HZ     | 49B36-293D    |
|             | ER/PR24-4AS & 4AG<br>PRI1-4AS                                     | REFRIGERATION SYSTEM ASSEMBLY 220V/50HZ     | 49B36-295D    |
|             | ER/PR/PRD48-1AS &<br>1AG<br>PRF48-24-1AS COOLER                   | REFRIGERATION SYSTEM ASSEMBLY 115V/60HZ     | 49B36-283D    |
|             | ER/PR48-4AS & 4AG   | REFRIGERATION SYSTEM ASSEMBLY 220V/50HZ     | 49B36-284D    |
|             | ER/PR/PRD48-5AS &<br>5AG  | REFRIGERATION SYSTEM ASSEMBLY 208/230V/60HZ | 49B36-285D    |
|             | ER/PR/PRD74-1AS &<br>1AHS PRI2-1AS<br>PRT2-1AS                    | REFRIGERATION SYSTEM ASSEMBLY 115V/60HZ     | 49B36-286D    |
|             | ER/PR/PRD74-1BG &<br>1BHG   | REFRIGERATION SYSTEM ASSEMBLY 115V/60HZ     | 49B36-393D-01 |
|             | ER/PR74-4AS   | REFRIGERATION SYSTEM ASSEMBLY 220V/50HZ     | 49B36-288D    |
|             | ER/PR74-5AS   | REFRIGERATION SYSTEM ASSEMBLY 208/230V/60HZ | 49B36-287D    |
|             | ER/PR74-5BG   | REFRIGERATION SYSTEM ASSEMBLY 208/230V/60HZ | 49B36-393D-02 |
|             | EF/PF24-1AS<br>PRF24-24(FREEZER)                                  | REFRIGERATION SYSTEM ASSEMBLY 115V/60HZ     | 49B36-384D-01 |
|             | EF/PF24-1BG   | REFRIGERATION SYSTEM ASSEMBLY 115V/60HZ     | 49B36-390D-01 |
|             | EF/PF24-4AS<br>PRF48-24-1AS<br>FREEZER                            | REFRIGERATION SYSTEM ASSEMBLY 220V/50HZ     | 49B36-384D-02 |
|             | EF/PF24-4BG   | REFRIGERATION SYSTEM ASSEMBLY 220V/50HZ     | 49B36-390D-03 |
|             | EF/PF24-5AS   | REFRIGERATION SYSTEM ASSEMBLY 208/230V/60HZ | 49B36-384D-03 |
|             | EF/PF24-5BG   | REFRIGERATION SYSTEM ASSEMBLY 208/230V/60HZ | 49B36-390D-02 |
|             | EF/PF48-1AS   | REFRIGERATION SYSTEM ASSEMBLY 115V/60HZ     | 49B36-385D-01 |
|             | EF/PF48-4AS   | REFRIGERATION SYSTEM ASSEMBLY 220V/50HZ     | 49B36-385D-03 |
|             | EF/PF48-4BG   | REFRIGERATION SYSTEM ASSEMBLY 220V/50HZ     | 49B36-391D-02 |
|             | EF/PF48-5AS   | REFRIGERATION SYSTEM ASSEMBLY 208/230V/60HZ | 49B36-385D-02 |
| EF/PF48-5BG | REFRIGERATION SYSTEM ASSEMBLY 208/230V/60HZ                       | 49B36-391D-01                               |               |
| EF/PF74-5AS | REFRIGERATION SYSTEM ASSEMBLY 208/230/60HZ                        | 49B36-386D-01                               |               |
| EF/PF74-5BG | REFRIGERATION SYSTEM ASSEMBLY 208V/60HZ                           | 49B36-392D-01                               |               |
| 49          | ER/PR/PRD24<br>PRT1-1AS<br>PRF24-24(COOLER)                       | EVAPORATOR. COIL. ASSY.                     | 49B31-198C-01 |
|             | ER/PR/PRD48<br>PRF48-24(COOLER)<br>PRF48-24(COOLER)<br>& (REMOTE) | EVAPORATOR. COIL. ASSY.                     | 49B31-166C    |
|             | ER/PR/PRD74<br>PRI2-1AS<br>PRT2-1AS                               | EVAPORATOR. COIL. ASSY.                     | 49B31-170C    |
|             | ER/PR/PRD74-1BG<br>& 1BHG   | EVAPORATOR. COIL. ASSY.                     | 49B31-171C    |
|             | PRF12-12  | EVAPORATOR. COIL. ASSY.(COOLER)             | 49B31-096D    |

\* INDICATES PARTS NOT ILLUSTRATED

07/24/2000

**REACH IN REFRIGERATORS/FREEZERS/ROLL-IN/ROLL-THRU  
UNITS  
REFRIGERATION SYSTEMS (CONTINUED)**

| ITEM | MODEL   | DESCRIPTION                                  | PART NUMBER   |
|------|---|--|---------------|
| 49   | PRF12-12  | EVAPORATOR. COIL. ASSY.(FREEZER)             | 49B31-097D    |
|      | EF/PF24-1AS/5AS<br>PRF24-24(FREEZER)                            | EVAPORATOR. COIL. ASSY.                      | 49B31-179D    |
|      | EF/PF24-1BG/5BG<br>PRF48-24(FREEZER)                            | EVAPORATOR. COIL. ASSY.                      | 49B31-192C-01 |
|      | EF/PF24-4AS   | EVAPORATOR. COIL. ASSY.                      | 49B31-202D-01 |
|      | EF/PF24-4BG   | EVAPORATOR. COIL. ASSY.                      | 49B31-192C-02 |
|      | EF/PF48-1AS/5AS   | EVAPORATOR. COIL. ASSY.                      | 49B31-177C-01 |
|      | EF/PF48-4AS   | EVAPORATOR. COIL. ASSY.                      | 49B31-177C-02 |
|      | EF/PF48-4BG   | EVAPORATOR. COIL. ASSY.                      | 49B31-193C-02 |
|      | EF/PF48-5BG   | EVAPORATOR. COIL. ASSY.                      | 49B31-193C-01 |
|      | EF/PF74-5AS   | EVAPORATOR. COIL. ASSY.                      | 49B31-178C-01 |
|      | EF/PF74-5BG   | EVAPORATOR. COIL. ASSY.                      | 49B31-194C-01 |
|      | ER/PR24 (REMOTE)  | EVAPORATOR. COIL. ASSY.                      | 49B31-149C    |
|      | ER/PR48 (REMOTE)  | EVAPORATOR. COIL. ASSY.                      | 49B31-148C    |
|      | ER/PR74 (REMOTE)  | EVAPORATOR. COIL. ASSY.                      | 49B31-146D    |
|      | EF/PF24 (REMOTE)  | EVAPORATOR. COIL. ASSY.                      | 49B31-210D-01 |
|      | EF/PF48 (REMOTE)  | EVAPORATOR. COIL. ASSY.                      | 49B31-208D-01 |
|      | EF/PF74 (REMOTE)  | EVAPORATOR. COIL. ASSY.                      | 49B31-209D-01 |
| 50   | ALL EF/PF   | THERMOSTAT - DEFROST                         | 502-069A      |
| 51   | ALL EF/PF   | THERMOSTAT - FAN                             | 502-070A      |
| 52   | ER/PR/PRD24<br>PRT1-1AS<br>PRF24-24(COOLER)<br>& (REMOTE)       | EVAPORATOR COIL (9X7X4)                      | 305-132C      |
|      | ER/PR/PRD48<br>PRF48-24(COOLER)<br>& (REMOTE)                   | EVAPORATOR COIL (21X7X4)                     | 305-129C      |
|      | ER/PR/PRD74<br>PRI2-1AS/PRT2-1AS<br>& (REMOTE)                  | EVAPORATOR COIL (35X7X4)                     | 305-171C      |
|      | EF/PF24<br>PRF24-24(FREEZER)<br>PRF48-24(FREEZER)<br>& (REMOTE) | EVAPORATOR COIL (9X7-9/32X6)                 | 305-177C      |
|      | EF/PF48<br>& (REMOTE)   | EVAPORATOR COIL (21X7-9/32X6)                | 305-128C      |
|      | EF/PF74 ALL<br>& (REMOTE)                                       | EVAPORATOR COIL (35X7-9/32X6)                | 305-163C      |
| 53   | ER/PR/PRD24<br>PRT1-1AS   | SUCTION LINE & CAPILLARY TUBE ASSY.          | 49B30-193C    |
|      | ER/PR/PRD48   | SUCTION LINE & CAPILLARY TUBE ASSY.          | 49B30-188C    |
|      | ER/PR/PRD74<br>PRI2-1AS<br>PRT2-1AS                             | SUCTION LINE & CAPILLARY TUBE ASSY.          | 49B30-191C    |
|      | ER/PR/PRD74-1BG<br>& 1BHG                                       | SUCTION LINE & CAPILLARY TUBE ASSY.          | 49B30-098C    |
|      | PRF12-12  | SUCTION LINE & CAPILLARY TUBE ASSY.(COOLER)  | 49B30-147D    |
|      | PRF12-12  | SUCTION LINE & CAPILLARY TUBE ASSY.(FREEZER) | 49B30-148D    |
|      | PRF24-24  | SUCTION LINE & CAPILLARY TUBE ASSY.(COOLER)  | 49B30-193C    |

\* INDICATES PARTS NOT ILLUSTRATED

07/24/2000

**REACH IN REFRIGERATORS/FREEZERS/ROLL-IN/ROLL-THRU  
UNITS  
REFRIGERATION SYSTEMS (CONTINUED)**

| ITEM             | MODEL  | DESCRIPTION                                  | PART NUMBER       |
|------------------|--|--|-------------------|
| 53               | PRF24-24   | SUCTION LINE & CAPILLARY TUBE ASSY.(FREEZER) | 49B30-227C        |
|                  | PRF48-24   | SUCTION LINE & CAPILLARY TUBE ASSY.(COOLER)  | 49B30-188C        |
|                  | PRF48-24   | SUCTION LINE & CAPILLARY TUBE ASSY.(FREEZER) | 49B30-227C        |
|                  | EF/PF24-1AS/5AS/4AS  | SUCTION/LIQUID LINE ASSY.                    | 49B30-227C        |
|                  | EF/PF24-1BG/5BG  | SUCTION/LIQUID LINE ASSY.                    | 49B30-149C        |
|                  | EF/PF24-4AS  | SUCTION/LIQUID LINE ASSY.                    | 49B30-233C        |
|                  | EF/PF48-1AS/5AS  | <b>SUCTION LINE ASSY</b>                     | <b>49B30-119C</b> |
|                  | EF/PF48-4AS  |  |                   |
|                  | EF/PF48-4BG  |  |                   |
|                  | EF/PF48-5BG  |  |                   |
|                  | EF/PF74-5AS  |  |                   |
|                  | EF/PF74-5BG  |  |                   |
|                  | ER/PR24 (REMOTE)   | SUCTION/LIQUID LINE ACCY.                    | 49B30-116C        |
|                  | ER/PR48 (REMOTE)   |  |                   |
|                  | ER/PR74 (REMOTE)   | SUCTION/LIQUID LINE ACCY.                    | 49B30-113C        |
|                  | EF/PF24 (REMOTE)   | SUCTION/LIQUID LINE ACCY.                    | 49B30-112C        |
| EF/PF48 (REMOTE) |  |  |                   |
| EF/PF74 (REMOTE) |  |  |                   |
| 54               | ER/PR/PRD24/48/74<br>PRT1-1AS<br>PRF12-12(COOLER)<br>PRF24-24(COOLER)<br>PRF48-24(COOLER)<br>&(REMOTE) | ACCUMULATOR                                  | 303-012A          |
|                  | EF/PF24<br>PRF24-24(FREEZER)<br>PRF48-24(FREEZER)  | ACCUMULATOR                                  | 303-090A          |
|                  | EF/PF48/74-5AS<br>& EF74 (REMOTE)  | ACCUMULATOR                                  | 303-067A          |
|                  | EF/PF48 (REMOTE)   | ACCUMULATOR                                  | 303-097A          |
| 55               | EF/PF48-1AS/4AS/5AS  | EXP VALVE FSE-1/2 ZP35                       | 303-131A          |
|                  | EF/PF48/74-4BG/5BG   | EXP VALVE FSE-1/2 ZP35                       | 303-135A          |
|                  | ER/PR24/48 (REMOTE)  | EXP VALVE FJ-1/4-C                           | 303-121A          |
|                  | ER/PR74 (REMOTE)   | EXP VALVE FJ-1/2-C                           | 303-122A          |
|                  | EF/PF24 (REMOTE)   | EXP VALVE                                    | 303-134A          |
|                  | EF/PF48 (REMOTE)   | EXP VALVE FSE-1/2 ZP35                       | 303-131A          |
|                  | EF/PF74 (REMOTE)   | EXP VALVE FSE-1/2-ZP-35                      | 303-135A          |
| 56               | EF/PF48-1AS/5AS  | <b>DISTRIBUTOR</b>                           | <b>303-097A</b>   |
|                  | EF/PF48-4AS  |  |                   |
|                  | EF/PF48-4BG  |  |                   |
|                  | EF/PF48-5BG  |  |                   |
|                  | EF/PF74-5AS  |  |                   |
|                  | EF/PF74-5BG  |  |                   |
|                  | EF/PF48 (REMOTE)   |  |                   |
|                  | EF/PF74 (REMOTE)   |  |                   |
| 57               | ER/PR/PRD24<br>PRT1-1AS<br>PRF12-12 (FREEZER)  | CAP TUBE .049ID X .099OD X 100               | 203-127A          |

**REACH IN REFRIGERATORS/FREEZERS/ROLL-IN/ROLL-THRU  
UNITS  
REFRIGERATION SYSTEMS (CONTINUED)**

| ITEM  | MODEL   | DESCRIPTION   | PART NUMBER                     |
|---|---|---|---------------------------------|
| 57  | ER/PR/PRD48<br>PRF24-24 (FREEZER)<br>PRF48-24 (COOLER)<br>PRF48-24 (FREEZER)<br>EF/PF24-1AS/5AS/4AS | CAP TUBE .049ID X .099OD X 84                                   | 203-132A                        |
|   | ER/PR/PRD74-1BG &<br>1BHGPT12-1AS<br>PRT2-1AS   | CAP TUBE .054ID X .106OD X 108                                  | 203-043A--                      |
|   | ER/PR/PRD74-<br>1BG&1BHG  | CAP TUBE .062ID X .112OD X 60                                   | 203-125A                        |
|   | PRF12-12 (COOLER)   | CAP TUBE .042ID X .093OD X 120                                  | 203-056A-A                      |
|   | PRF12-12 (FREEZER)  | CAP TUBE .042ID X .092OD X 96                                   | 203-131A                        |
|   | 58  | ER/PR/PRD24-1AS/1AG<br>PRI1-1AS<br>PRT1-1AS<br>PRF24-24(COOLER) | CONDENSING UNIT ASSY. 115V-60HZ |
| ER/PR24-4AS & 4AG<br>PRI1-4AS                   |   | CONDENSING UNIT ASSY. 220V-50HZ                                 | 49B34-290D-03                   |
| ER/PR/PRD48-1AS &<br>1AG<br>PRF48-24-1AS COOLER |   | CONDENSING UNIT ASSY. 115V-60HZ                                 | 49B34-243D                      |
| ER/PR48-4AS & 4AG                               |   | CONDENSING UNIT ASSY. 220V-50HZ                                 | 49B34-287D-01                   |
| ER/PR/PRD48-5AS &<br>5AG                        |   | CONDENSING UNIT ASSY. 208/230V-60HZ                             | 49B34-287D-02                   |
| ER/PR/PRD74-1AS &<br>1AHS PRI2-1AS<br>PRT2-1AS  |   | CONDENSING UNIT ASSY. 115V-60HZ                                 | 49B34-247D                      |
| ER/PR/PRD74-1BG &<br>1BHG                       |   | CONDENSING UNIT ASSY. 115V-60HZ                                 | 49B34-285D-01                   |
| ER/PR74-4AS                                     |   | CONDENSING UNIT ASSY. 220V-50HZ                                 | 49B34-286D-02                   |
| ER/PR74-5AS                                     |   | CONDENSING UNIT ASSY. 208/230V-60HZ                             | 49B34-286D-01                   |
| ER/PR74-5BG                                     |   | CONDENSING UNIT ASSY. 208/230V-60HZ                             | 49B34-285D-02                   |
| EF/PF24-1AS<br>PRF24-24(FREEZER)                |   | CONDENSING UNIT ASSY. 115V-60HZ                                 | 49B34-274D-01                   |
| EF/PF24-1BG<br>EF/PF48-24(FREEZER)              |   | CONDENSING UNIT ASSY. 115V-60HZ                                 | 49B34-281D-01                   |
| EF/PF24-4AS                                     |   | CONDENSING UNIT ASSY. 220V-50HZ                                 | 49B34-274D-02                   |
| EF/PF24-4BG                                     |   | CONDENSING UNIT ASSY. 220V-50HZ                                 | 49B34-281D-03                   |
| EF/PF24-5AS                                     |   | CONDENSING UNIT ASSY. 208/230V-60HZ                             | 49B34-274D-03                   |
| EF/PF24-5BG                                     |   | CONDENSING UNIT ASSY. 208/230V-60HZ                             | 49B34-281D-02                   |
| EF/PF48-1AS                                     |   | CONDENSING UNIT ASSY. 115V/60HZ                                 | 49B34-272D-01                   |
| EF/PF48-4AS                                     |   | CONDENSING UNIT ASSY. 220V/50HZ                                 | 49B34-272D-03                   |
| EF/PF48-4BG                                     |   | CONDENSING UNIT ASSY. 220V/50HZ                                 | 49B34-282D-02                   |
| EF/PF48-5AS                                     |   | CONDENSING UNIT ASSY. 208/230V/60HZ                             | 49B34-272D-02                   |
| EF/PF48-5BG                                     |   | CONDENSING UNIT ASSY. 208/230V/60HZ                             | 49B34-282D-01                   |
| EF/PF74-5AS                                     |   | CONDENSING UNIT ASSY. 208/230V/60HZ                             | 49B34-273D-01                   |
| EF/PF74-5BG                                     |   | CONDENSING UNIT ASSY. 208/230V                                  | 49B34-283D-01                   |

\* INDICATES PARTS NOT ILLUSTRATED

07/24/2000

# REACH IN REFRIGERATORS/FREEZERS/ROLL-IN/ROLL-THRU UNITS COMPRESSORS

| ITEM        | MODEL   | DESCRIPTION  | PART NUMBER |
|-------------|---|--|-------------|
| 59          | ER/PR/PRD24-1AS/1AG<br>PRI1-1AS<br>PRT1-1AS<br>PRF24-24(COOLER) | COMPRESSOR 1/4HP 115V/60HZ (tec) AEA3430YXA            | 302-803B    |
|             | ER/PR24-4AS & 4AG<br>PRI1-4AS                                   | COMPRESSOR 1/4HP 220V/50HZ (tec) AEA3430YXC            | 302-648B    |
|             | ER/PR/PRD48-1AS &<br>1AG<br>PRF48-24-<br>1AS(COOLER)            | COMPRESSOR 1/3HP 115V/60HZ (tec) AE3440YXA             | 302-804B    |
|             | ER/PR48-4AS & 4AG   | COMPRESSOR 1/3HP 220V/50HZ (tec) AEA3440YXC            | 302-875B    |
|             | ER/PR/PRD48-5AS &<br>5AG  | COMPRESSOR 1/3HP 208/230V/60HZ (tech) AEA4440YXD       | 302-708B    |
|             | ER/PR/PRD74-1AS &<br>1AHS PRI2-1AS<br>PRT2-1AS                  | COMPRESSOR 1/2HP 115V/60HZ (tech) AKA4476YXA           | 302-626B    |
|             | ER/PR/PRD74-1BG &<br>1BHG                                       | COMPRESSOR 3/4HP 115V/60HZ (tech) AKA9451ZXA           | 302-917B    |
|             | ER/PR74-4AS   | COMPRESSOR 1/2HP 220V/50HZ (tech) AKA4476YXC           | 302-824B    |
|             | ER/PR74-5AS   | COMPRESSOR 1/2HP 208/230V/60HZ (tech) AKA4476YXD       | 302-861B    |
|             | ER/PR74-5BG   | COMPRESSOR 3/4HP 230V/60HZ (tech) AKA9451ZXD           | 302-920B    |
|             | EF/PF24-1AS<br>PRF24-24(FREEZER)                                | COMPRESSOR 1/2HP 115V/60HZ TEC AJA2425ZXA              | 302-928B    |
|             | EF/PF24-1BG<br>EF/PF48-1AS<br>PRF48-24-<br>1AS(FREEZER)         | COMPRESSOR 3/4HP 115V/60HZ (cop) KAMB007ECAA-221       | 302-912B    |
|             | EF/PF24-4AS   | COMPRESSOR 1/2HP 220V/50HZ (tech) AJA2425ZXC           | 302-937B    |
|             | EF/PF24-4BG<br>EF/PF/24-5BG<br>EF/PF48-4AS<br>EF/PF48-5AS       | COMPRESSOR 3/4HP 208/230V/50/60HZ (cop)<br>KAMB007ECAV | 302-956B    |
|             | EF/PF24-5AS   | COMPRESSOR 1/2HP 208/230V/60HZ(tec)-AJA2425ZXD         | 302-948B    |
|             | EF/PF48-4BG<br>EF/PF48-5BG<br>EF/PF74-5AS                       | COMPRESSOR 1HP 220V/50/60HZ (cop) KAKB-011E-CAV        | 302-927B    |
| EF/PF74-5BG | COMPRESSOR 1.5HP 208/230V (cop) KATD015ECAV                     | 302-926B   |             |

## RELAYS

| ITEM | MODEL   | DESCRIPTION                        | PART NUMBER |
|------|---|------------------------------------|-------------|
| 60   | ER/PR/PRD24-1AS/1AG<br>PRI1-1AS<br>PRT1-1AS<br>PRF24-24(COOLER) | COMPRESSOR RELAY (TI) 9660-042-176 | 302-646A    |
|      | ER/PR24-4AS & 4AG<br>PRI1-4AS                                   | COMPRESSOR RELAY (TEC)8200EMBE64   | 314-010A    |
|      | ER/PR/PRD48-1AS &<br>1AG<br>PRF48-24-<br>1AS(COOLER)            | COMPRESSOR RELAY (TI) 9660 042 182 | 302-350A    |
|      | ER/PR48-4AS & 4AG   | COMPRESSOR RELAY (TI) 9660-042-149 | 302-399A    |

\* INDICATES PARTS NOT ILLUSTRATED

07/24/2000

**REACH IN REFRIGERATORS/FREEZERS/ROLL-IN/ROLL-THRU  
UNITS  
RELAYS (CONTINUED)**

| ITEM | MODEL  | DESCRIPTION                         | PART NUMBER |
|------|--|-------------------------------------|-------------|
| 60   | ER/PR/PRD48-5AS & 5AG                            | COMPRESSOR RELAY (GE) 3ARR12-PL24   | 302-915A    |
|      | ER/PR/PRD74-1AS & 1AHS PRI2-1AS PRT2-1AS         | COMPRESSOR RELAY (GE) 3ARR2-KCR181S | 302-290A    |
|      | ER/PR/PRD74-1BG & 1BHG                           | COMPRESSOR RELAY (GE)3ARR3-B3TP4    | 302-341A    |
|      | ER/PR74-4AS                                      | COMPRESSOR RELAY                    | 302-933A    |
|      | ER/PR74-5AS                                      | COMPRESSOR RELAY (GE)3ARR2-KCR119S  | 302-935A    |
|      | ER/PR74-5BG                                      | COMPRESSOR RELAY (TEC) 820ARR3C29   | 302-427A    |
|      | EF/PF24-1AS PRF24-24(FREEZER)                    | COMPRESSOR RELAY(GE)3ARR3-A2M6      | 302-982A    |
|      | EF/PF24-1BG EF/PF48-1AS PRF48-24-1AS(FREEZER)    | COMPRESSOR RELAY(GE) 3ARR3CT5P5     | 302-483A    |
|      | EF/PF24-4AS                                      | COMPRESSOR RELAY (GE)3ARR3-A6AB6    | 314-005A    |
|      | EF/PF24-4BG EF/PF/24-5BG EF/PF48-4AS EF/PF48-5AS | COMPRESSOR RELAY(GE) 3ARR3CT-3E5    | 302-582A    |
|      | EF/PF24-5AS                                      | COMPRESSOR RELAY(GE) 3ARR3CT24E5    | 314-012A    |
|      | EF/PF48-4BG EF/PF48-5BG EF/PF74-5AS              | COMPRESSOR RELAY (GE) 3ARR3CT24E5   | 314-016A    |
|      | EF/PF74-5BG                                      | COMPRESSOR RELAY(GE) 3ARR3CT6O5     | 302-541A    |

**OVERLOADS**

| ITEM | MODEL  | DESCRIPTION                            | PART NUMBER |
|------|--|--|-------------|
| 61   | ER/PR/PRD24-1AS/1AG PRI1-1AS PRT1-1AS PRF24-24(COOLER) | COMPRESSOR OVERLOAD (TI)MRP26ALL-69    | 302-815A    |
|      | ER/PR24-4AS & 4AG PRI1-4AS                             | COMPRESSOR OVERLOAD (TI) MRP 59 AMK-69 | 302-838A    |
|      | ER/PR/PRD48-1AS & 1AG PRF48-24-1AS(COOLER)             | COMPRESSOR OVERLOAD (TI)MRT24AIK-69    | 302-911A    |
|      | ER/PR48-4AS & 4AG                                      | COMPRESSOR OVERLOAD (TI)MRP40AMK-69    | 302-942A    |
|      | ER/PR/PRD48-5AS & 5AG                                  | COMPRESSOR OVERLOAD (TI) MRP28AMN-69   | 302-914A    |
|      | ER/PR/PRD74-1AS & 1AHS PRI2-1AS PRT2-1AS               | COMPRESSOR OVERLOAD                    | 302-439A    |
|      | ER/PR/PRD74-1BG & 1BHG                                 | COMPRESSOR OVERLOAD (TI)MRA5718-114    | 302-997A    |
|      | ER/PR74-4AS  | COMPRESSOR OVERLOAD (TI) MRA8962-114   | 302-356A    |
|      | ER/PR74-5AS  | COMPRESSOR OVERLOAD (TI) MRA 3786-114  | 302-464A    |
|      | ER/PR74-5BG EF/PF24-1AS PRF24-24(FREEZER)              | COMPRESSOR OVERLOAD (TI)MRA5715-114    | 302-555A    |
|      | COMPRESSOR OVERLOAD (TI)CRA4765-134                    | 302-981A                               |             |



**REACH IN REFRIGERATORS/FREEZERS/ROLL-IN/ROLL-THRU  
UNITS  
OVERLOADS (CONTINUED)**

| ITEM | MODEL   | DESCRIPTION                            | PART NUMBER |
|------|---|--|-------------|
| 61   | EF/PF24-1BG<br>EF/PF48-1AS<br>PRF48-24-<br>1AS(FREEZER)   | COMPRESSOR OVERLOAD (COPE) 071-0092-40 | 302-484A    |
|      | EF/PF24-4AS   | COMPRESSOR OVERLOAD (TI)MRA5729-114    | 313-006A    |
|      | EF/PF24-4BG<br>EF/PF/24-5BG<br>EF/PF48-4AS<br>EF/PF48-5AS | COMPRESSOR OVERLOAD (TI) CST18AKN-18   | 302-473A    |
|      | EF/PF24-5AS   | COMPRESSOR OVERLOAD (TI)MRA5733-114    | 313-017A    |
|      | EF/PF48-4BG<br>EF/PF48-5BG<br>EF/PF74-5AS                 | COMPRESSOR OVERLOAD (COP) 071-0092-42  | 302-979A    |
|      | EF/PF74-5BG   | COMPRESSOR OVERLOAD (COPE) 071-0099-04 | 302-539A    |
|      |   |  |             |

**START CAPACITORS**

| ITEM | MODEL   | DESCRIPTION                     | PART NUMBER |  |
|------|---|---------------------------------|-------------|--|
| 62   | EF/PF24-4AS   | START CAPACITOR (TEC)855S330C83 | 315-005A    |  |
|      | EF/PF24-4BG<br>EF/PF/24-5BG<br>EF/PF48-4AS<br>EF/PF48-5AS | START CAPACITOR 014-0008-51     | 302-329A    |  |
|      | EF/PF24-5AS   | START CAPACITOR (TEC)855S330C82 | 315-009A    |  |
|      | EF/PF48-4BG<br>EF/PF48-5BG<br>EF/PF74-5AS                 | START CAPACITOR 014-0008-51     | 302-329A    |  |
|      | EF/PF74-5BG   | START CAPACITOR                 | 302-532A    |  |
|      |   |                                 |             |  |
|      |   |                                 |             |  |

**RUN CAPACITORS**

| ITEM | MODEL   | DESCRIPTION                                   | PART NUMBER |
|------|---|---|-------------|
| 63   | ER/PR/PRD74-1BG<br>& 1BHG                               | RUN CAPACITOR 85PR370F51                      | 302-554A    |
|      | ER/PR74-5BG   | RUN CAPACITOR TEC 85PR370E36                  | 302-557A    |
|      | EF/PF24-1AS<br>PRF24-24(FREEZER)                        | RUN CAPACITOR 85PR370E36 15 MFD 370V          | 302-983A    |
|      | EF/PF24-1BG<br>EF/PF48-1AS<br>PRF48-24-<br>1AS(FREEZER) | RUN CAPACITOR (COP)014-0037-03 (40 MFD@330V)  | 302-978A    |
|      | EF/PF74-5BG   | RUN CAPACITOR (COP) 014-0037-23(25 MFD@480V)  | 302-542A    |
|      | EF/PF48-4BG<br>EF/PF48-5BG<br>EF/PF74-5AS               | RUN CAPACITOR (COP) 014-0037-18 (40 MFD@440V) | 302-980A    |
|      |   |   |             |

**REACH IN REFRIGERATORS/FREEZERS/ROLL-IN/ROLL-THRU  
UNITS  
CAPACITOR AND RELAY ASSEMBLES**

| ITEM | MODEL   | DESCRIPTION                                | PART NUMBER |
|------|---|--|-------------|
| 64   | ER/PR/PRD24-1AS/1AG<br>PRI1-1AS<br>PRT1-1AS<br>PRF24-24(COOLER) | NA   | NA          |
|      | ER/PR24-4AS & 4AG<br>PRI1-4AS                                   | NA   | NA          |
|      | ER/PR/PRD48-1AS &<br>1AG<br>PRF48-24-<br>1AS(COOLER)            | NA   | NA          |
|      | ER/PR48-4AS & 4AG   | NA   | NA          |
|      | ER/PR/PRD48-5AS &<br>5AG  | CAPACITOR & RELAY ASSY. (TEC) AE1355-001B  | 302-922A    |
|      | ER/PR/PRD74-1AS &<br>1AHS PRI2-1AS<br>PRT2-1AS                  | CAPACITOR & RELAY ASSY.(TEC) AE1227-021    | 302-718A    |
|      | ER/PR/PRD74-1BG &<br>1BHG                                       | CAPACITOR & RELAY ASSY. AE1197-028         | 302-998A    |
|      | ER/PR74-4AS   | CAPACITOR & RELAY ASSY. (TEC)AE1227-037    | 302-934A    |
|      | ER/PR74-5AS   | CAPACITOR & RELAY ASSY. AE1227-039         | 302-936A    |
|      | ER/PR74-5BG   | CAPACITOR & RELAY ASSY. (TEC) AE1197-029   | 302-556A    |
|      | EF/PF24-1AS<br>PRF24-24(FREEZER)                                | CAPACITOR & RELAY ASSY.                    | 302-977A    |
|      | EF/PF24-1BG<br>EF/PF48-1AS<br>PRF48-24-<br>1AS(FREEZER)         | CAPACITOR & RELAY ASSY.                    | 302-977A    |
|      | EF/PF24-4AS   | CAPACITOR & RELAY ASSY. AE1170-047         | 317-006A    |
|      | EF/PF24-4BG<br>EF/PF/24-5BG<br>EF/PF48-4AS<br>EF/PF48-5AS       | CAPACITOR & RELAY ASSY.(RBM) 128306-1643EK | 302-474A    |
|      | EF/PF24-5AS   | CAPACITOR & RELAY ASSY. (TEC)AE1170-049    | 317-013A    |
|      | EF/PF48-4BG<br>EF/PF48-5BG<br>EF/PF74-5AS                       | CAPACITOR & RELAY ASSY. 514-1211-75        | 317-017A    |
|      | EF/PF74-5BG   | CAPACITOR & RELAY ASSY. 514-1211-76        | 317-018A    |

\* INDICATES PARTS NOT ILLUSTRATED

07/24/2000

**REACH IN REFRIGERATORS/FREEZERS/ROLL-IN/ROLL-THRU  
UNITS  
CONDENSER FAN MOTORS**

| ITEM      | MODEL  | DESCRIPTION                              | PART NUMBER |
|-----------|--|--|-------------|
| <b>65</b> | ER/PR/PRD24-1AS/1AG<br>PRI1-1AS<br>PRT1-1AS<br>PRF24-24(COOLER)  | CONDENSER FAN MOTOR 5 WATTS 115V/60HZ    | 501-019B    |
|           | ER/PR24-4AS & 4AG<br>PRI1-4AS  | CONDENSER FAN MOTOR 5 WATTS 230V/50/60HZ | 501-055B    |
|           | ER/PR/PRD48-1AS &<br>1AG<br>PRF48-24-<br>1AS(COOLER)<br>ER/PR/PRD74-<br>1BG&1BHG EF/PF24-<br>1AS<br>PRF24-24(FREEZER)<br>EF/PF24-1BG<br>EF/PF48-1AS<br>PRF48-24-<br>1AS(FREEZER) | CONDENSER FAN MOTOR 9 WATTS 115V/60HZ    | 501-148B    |
|           | ER/PR48-4AS/4AG &<br>4BG<br>ER/PR/PRD48-5AS &<br>5AG<br>ER/PR/PRD74-1AS &<br>1AHS PRI2-1AS<br>PRT2-1AS<br>ER/PR74-4AS<br>ER/PR74-5AS<br>EF/PF24-4AS<br>EF/PF24-4AS               | CONDENSER FAN MOTOR 9 W 230V-50/60HZ     | 501-149B    |
|           | EF/PF24-5AS/5BG<br>EF/PF48-5AS/5BG<br>EF/PF74-5ASEF<br>PF74-5BG  | FAN MOTOR 9 WATTS 208-60                 | 501-043B    |
|           | ER/PR74-5BG  | FAN MOTOR 25W 230V/50/60HZ               | 501-058B    |

**REACH IN REFRIGERATORS/FREEZERS/ROLL-IN/ROLL-THRU  
UNITS  
CONDENSER FAN BLADES**

| ITEM      | MODEL   | DESCRIPTION                          | PART NUMBER |
|-----------|---|--------------------------------------|-------------|
| <b>66</b> | ER/PR/PRD24-1AS/1AG<br>PRI1-1AS<br>PRT1-1AS<br>PRF24-24(COOLER)<br>ER/PR24-4AS & 4AG<br>PRI1-4AS<br>ER/PR/PRD48-5AS<br>&5AG ER/PR48-4AS &<br>4AG  | CONDENSER FAN BLADE 7.75"            | 405-012A--  |
|           | ER/PR/PRD48-1AS &<br>1AG<br>PRF48-24-<br>1AS(COOLER)<br>ER/PR/PRD74-<br>1BG&1BHG EF/PF24-<br>1AS<br>PRF24-24(FREEZER)<br>EF/PF24-1BG<br>EF/PF48-<br>1AS/4AS/4BG/5AS<br>EF/PF48-5BG<br>PRF48-24-<br>1AS(FREEZER) EF/PF74-<br>5AS/5BG | CONDENSER FAN BLADE 8.75"            | 405-034A    |
|           | ER/PR/PRD74-1AS &<br>1AHS PR12-1AS<br>PRT2-1AS<br>ER/PR74-4AS<br>ER/PR74-5AS<br>EF/PF24-1AS<br>PRF24-24(FREEZER)<br>ER/PF24-1BG/5BG<br>EF/PF48-24-<br>1AS(FREEZER)<br>EF/PF24-4AS/4BG/5AS   | CONDENSER FAN BLADE 10" (5 PED ALUM) | 405-066B    |
|           | ER/PR/PRD74-<br>1BG&1BHG<br>ER/PR74-5BG   | CONDENSER FAN BLADE 10" (4 PED )     | 405-036A    |

**REACH IN REFRIGERATORS/FREEZERS/ROLL-IN/ROLL-THRU  
UNITS  
CONDENSER COILS**

| ITEM | MODEL   | DESCRIPTION                       | PART NUMBER |
|------|---|-----------------------------------|-------------|
| 67   | ER/PR/PRD24-1AS/1AG<br>PRI1-1AS<br>PRT1-1AS<br>PRF24-24(COOLER)<br>ER/PR24-4AS & 4AG<br>PRI1-4AS  | CONDENSER COIL 7-7/8X10-1/2X1-1/4 | 305-134B    |
|      | ER/PR/PRD48-1AS & 1AG<br>PRF48-24-1AS (COOLER)<br>ER/PR48-4AS & 4AG<br>ER/PR/PRD48-5AS & 5AG  | CONDENSER COIL 11X10X3            | 305-130C    |
|      | ER/PR/PRD74-1AS & 1AHS PRI2-1AS<br>PRT2-1AS<br>ER/PR74-4AS<br>ER/PR74-5AS   | CONDENSER COIL 11X10-7/8X4        | 305-160C    |
|      | ER/PR/PRD74-1BG & 1BHGER/PR74-5BG   | CONDENSER COIL 13-1/4X10-7/8X4    | 305-159C    |
|      | EF/PF24-1AS<br>PRF24-24(FREEZER)<br>EF/PF24-1BG<br>EF/PF48-24-1AS(FREEZER)<br>EF/PF24-4AS<br>EF/PF24-4BG<br>EF/PF24-5AS<br>EF/PF24-5BG<br>EF/PF48-1AS | CONDENSER COIL 7-3/4X10X3         | 305-156C    |
|      | EF/PF48-4AS<br>EF/PF48-4BG<br>EF/PF48-5AS<br>EF/PF48-5BG<br>EF/PF74-5AS   | CONDENSER COIL 19X10X4            | 305-127C    |
|      | EF/PF74-5BG   | CONDENSER COIL 23X11X4            | 305-162C    |

**REACH IN REFRIGERATORS/FREEZERS/ROLL-IN/ROLL-THRU  
UNITS  
CONDENSATE PANS**

| ITEM      | MODEL   | DESCRIPTION    | PART NUMBER |
|-----------|---|----------------|-------------|
| <b>68</b> | ER/PR/PRD24-1AS/1AG<br>PRI1-1AS<br>PRT1-1AS<br>PRF24-24(COOLER)<br>PRI1-4AS<br>ER/PR24-4AS & 4AG                      | CONDENSATE PAN | 43B35-009C  |
|           | ER/PR/PRD48-1AS &<br>1AG PRF48-<br>24-1AS COOLER<br>ER/PR48-4AS & 4AG<br>ER/PR/PRD48-5AS &<br>5AG                     | CONDENSATE PAN | 43B35-007C  |
|           | ER/PR/PRD74-1AS &<br>1AHS PRI2-1AS<br>PRT2-1AS<br>ER/PR/PRD74-1BG &<br>1BHG ER/PR74-4AS<br>ER/PR74-5AS<br>ER/PR74-5BG | CONDENSATE PAN | 43B35-006C  |
|           | EF/PF24-1AS<br>PRF24-24(FREEZER)<br>EF/PF24-4AS<br>PRF48-24-1AS<br>FREEZER EF/PF24-5AS                                | CONDENSATE PAN | 43B35-016C  |
|           | EF/PF24-1BG<br>EF/PF24-4BG<br>EF/PF24-5BG   | CONDENSATE PAN | 43B35-015C  |
|           | EF/PF48-1AS<br>EF/PF48-4AS<br>EF/PF48-5AS<br>EF/PF74-5AS<br>EF/PF74-5BG   | CONDENSATE PAN | 43B35-017C  |
|           | EF/PF48-4BG   | CONDENSATE PAN | 43B35-013C  |
|           | EF/PF48-5BG   | CONDENSATE PAN | 43B35-013C  |

**REACH IN REFRIGERATORS/FREEZERS/ROLL-IN/ROLL-THRU  
UNITS  
DRYERS**

| ITEM       | MODEL  | DESCRIPTION           | PART NUMBER |
|------------|--|-----------------------|-------------|
|            | ER/PR/PRD24-1AS/1AG<br>PRI1-1AS<br>PRT1-1AS<br>PRF24-24(COOLER)<br>ER/PR24-4AS & 4AG<br>PRI1-4AS<br><br>ER/PR/PRD48-1AS &<br>1AG<br>PRF48-24-1AS COOLER<br>ER/PR48-4AS & 4AG<br>ER/PR/PRD48-5AS &<br>5AG   | DRYER (R-12/134/404)  | 303-126A    |
| <b>*69</b> | ER/PR/PRD74-1AS &<br>1AHS PRI2-1AS<br>PRT2-1AS<br>ER/PR74-4AS<br>ER/PR74-5AS   | DRYER (R-134A & R-12) | 303-127A    |
|            | ER/PR/PRD74-1BG &<br>1BHG<br>EF/PF24-1AS<br>PRF24-24(FREEZER)<br><br>EF/PF24-1BG<br>EF/PF48-24(FREEZER)<br>EF/PF24-4AS<br>EF/PF24-4BG<br>EF/PF24-5AS<br>EF/PF24-5BG<br>EF/PF48-1AS<br>EF/PF48-4AS<br>EF/PF48-4BG<br>EF/PF48-5AS<br>EF/PF48-5BG<br>EF/PF74-5AS<br>EF/PF74-5BG | DRYER (R-134/404/502) | 303-129A    |

**REACH IN REFRIGERATORS/FREEZERS/ROLL-IN/ROLL-THRU  
UNITS  
CONDENSER FAN SHROUDS**

| ITEM      | MODEL  | DESCRIPTION          | PART NUMBER |
|-----------|--|----------------------|-------------|
| <b>70</b> | ER/PR/PRD24-1AS/1AG<br>PRI1-1AS<br>PRT1-1AS<br>PRF24-24(COOLER)<br>ER/PR24-4AS & 4AG<br>PRI1-4AS                                       | CONDENSER FAN SHROUD | 49A36-026C  |
|           | ER/PR/PRD48-1AS &<br>1AG<br>PRF48-24-1AS COOLER<br>ER/PR48-4AS & 4AG<br>ER/PR/PRD48-5AS &<br>5AG                                       | CONDENSER FAN SHROUD | 49A36-023C  |
|           | ER/PR/PRD74-1AS &<br>1AHS PRI2-1AS<br>PRT2-1AS<br>ER/PR/PRD74-1BG &<br>1BHG<br>ER/PR74-4AS<br>ER/PR74-5AS<br>ER/PR74-5BG               | CONDENSER FAN SHROUD | 49A36-024C  |
|           | EF/PF24-1AS<br>PRF24-24(FREEZER)<br><br>EF/PF24-1BG<br>EF/PF48-24(FREEZER)<br>EF/PF24-4AS<br>EF/PF24-4BG<br>EF/PF24-5AS<br>EF/PF24-5BG | CONDENSER FAN SHROUD | NA          |
|           | EF/PF48-1AS<br>EF/PF48-4AS<br>EF/PF48-4BG<br>EF/PF48-5AS<br>EF/PF48-5BG<br>EF/PF74-5AS   | CONDENSER FAN SHROUD | 49A36-019C  |
|           | EF/PF74-5BG  | CONDENSER FAN SHROUD | 49A36-027C  |

**DEFROST HEATERS**

| ITEM      | MODEL  | DESCRIPTION           | PART NUMBER |
|-----------|--|-----------------------|-------------|
| <b>71</b> | EF/PF24-1AS/5AS<br>PRF24-24(FREEZER)<br>PRF48-24(FREEZER)<br>EF/PF24-1BG/5BG<br>EF/PF24-4AS<br>EF/PF24-4BG<br>& (REMOTE) | HEATER - DEFROST 115V | 504-516B    |
|           | EF/PF48-1AS/5AS/5BG  | HEATER - DEFROST 115V | 504-517B    |
|           | EF/PF48-4AS/4BG<br>& (REMOTE)  | HEATER - DEFROST 220V | 504-518B    |
|           | EF/PF74-5AS/5BG<br>& (REMOTE)  | HEATER - DEFROST 115V | 504-520B    |

\* INDICATES PARTS NOT ILLUSTRATED

07/24/2000