

# ***BEVERAGE-AIR***

**SP/DP/UC/WT**  
**SPD/WTRD/UCRD**



***PARTS***

***MANUAL***

**115V/60HZ & 220V/50HZ**

ILLUSTRATIONS 29' BASE REFRIGERATORS  
CABINET COMPONENTS

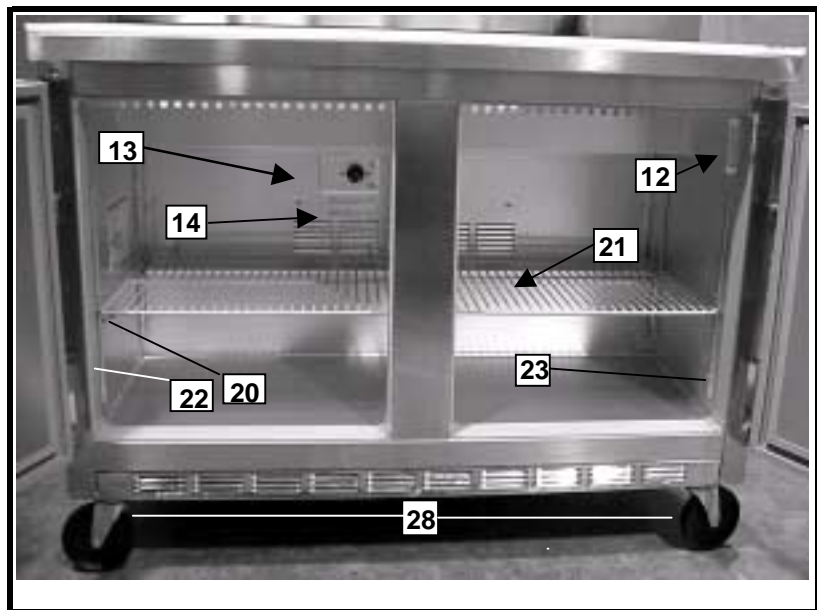
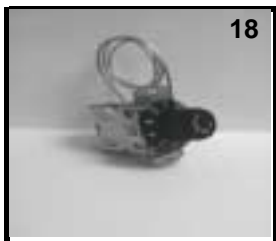
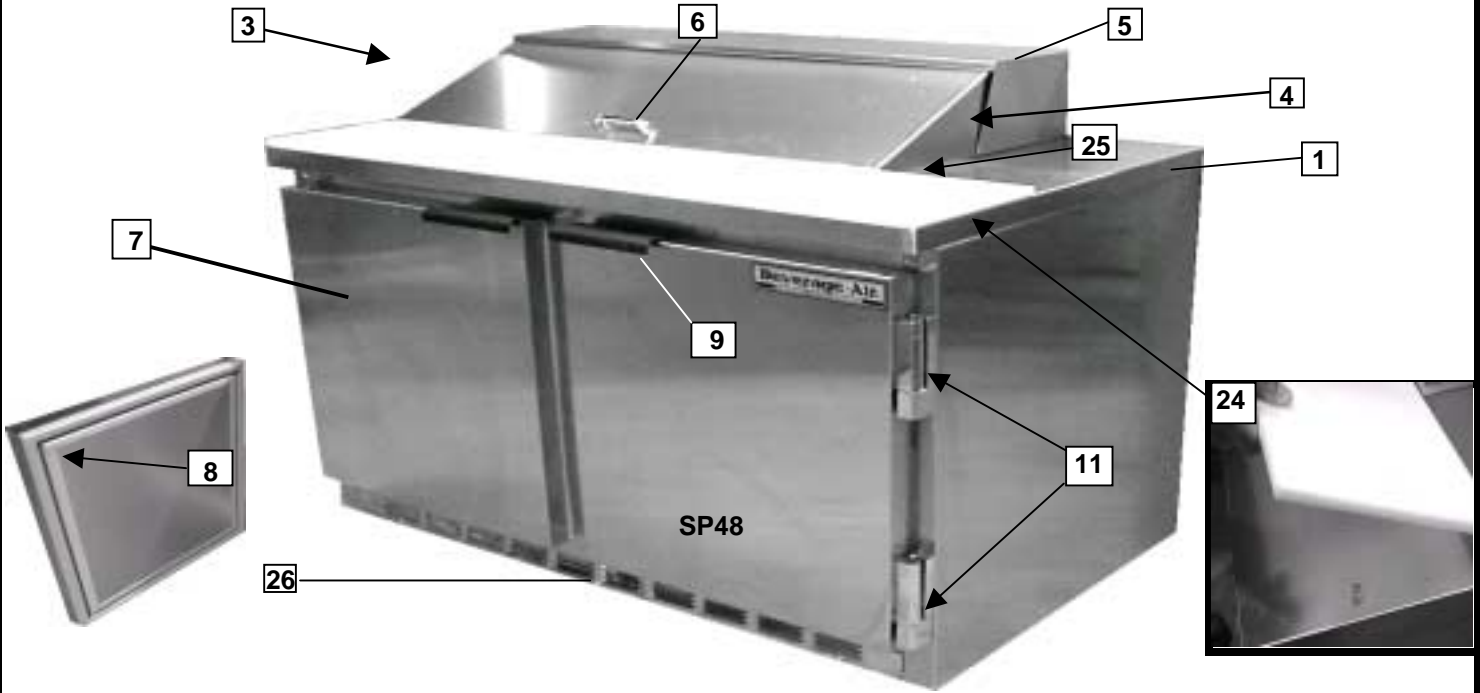
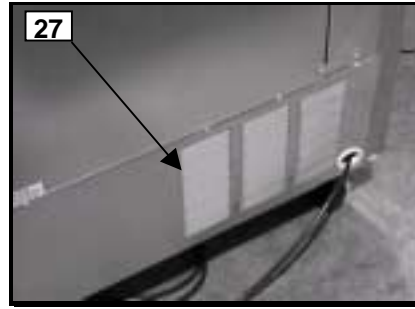
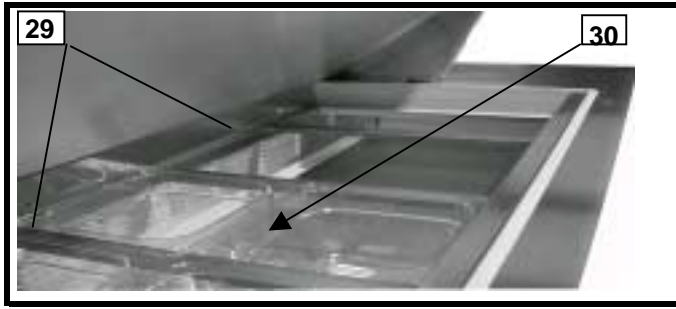

# TOP ASSEMBLES

## 29" BASE REFRIGERATORS

| ITEM        | MODEL                    | DESCRIPTION              | PART NUMBER   |
|-------------|--------------------------|--------------------------|---------------|
| 1           | SP27/SP27-16             | TOP ASSY. COMPLETE       | 01B35-254C-01 |
|             | SP27C                    | TOP ASSY. COMPLETE       | 01B35-255C-01 |
|             | SP27-12M                 | TOP ASSY. COMPLETE       | 01B35-246C-01 |
|             | SP48-08                  | TOP ASSY. COMPLETE       | 01B35-256D-01 |
|             | SP48-08C                 | TOP ASSY. COMPLETE       | 01B35-259D-01 |
|             | SP48-10                  | TOP ASSY. COMPLETE       | 01B35-257D-01 |
|             | SP48-10C                 | TOP ASSY. COMPLETE       | 01B35-260D-01 |
|             | SP48-12                  | TOP ASSY. COMPLETE       | 01B35-258D-01 |
|             | SP48-12C                 | TOP ASSY. COMPLETE       | 01B35-261D-01 |
|             | SP48-12M                 | TOP ASSY. COMPLETE       | 01B35-262D-01 |
|             | SP48-18M                 | TOP ASSY. COMPLETE       | 01B35-247D-01 |
|             | SP60-08                  | TOP ASSY. COMPLETE       | 01B35-263D-01 |
|             | SP60-12                  | TOP ASSY. COMPLETE       | 01B35-265D-01 |
|             | SP60-12M                 | TOP ASSY. COMPLETE       | 01B35-271D-01 |
|             | SP60-16                  | TOP ASSY. COMPLETE       | 01B35-266D-01 |
|             | SP60-18M                 | TOP ASSY. COMPLETE       | 01B35-272D-01 |
|             | SP60-24M                 | TOP ASSY. COMPLETE       | 01B35-248D-01 |
|             | SP72-08                  | TOP ASSY. COMPLETE       | 01B35-273D-01 |
|             | SP72-08C                 | TOP ASSY. COMPLETE       | 01B35-277D-01 |
|             | SP72-10                  | TOP ASSY. COMPLETE       | 01B35-274D-01 |
|             | SP72-10C                 | TOP ASSY. COMPLETE       | 01B35-278D-01 |
|             | SP72-12                  | TOP ASSY. COMPLETE       | 01B35-275D-01 |
|             | SP72-12C                 | TOP ASSY. COMPLETE       | 01B35-279D-01 |
|             | SP72-12M                 | TOP ASSY. COMPLETE       | 01B35-281D-01 |
|             | SP72-18                  | TOP ASSY. COMPLETE       | 01B35-276D-01 |
|             | SP72-18M                 | TOP ASSY. COMPLETE       | 01B35-282D-01 |
|             | SP72-18C                 | TOP ASSY. COMPLETE       | 01B35-280D-01 |
|             | SP72-24M                 | TOP ASSY. COMPLETE       | 01B35-283D-01 |
|             | SP72-30M                 | TOP ASSY. COMPLETE       | 01B35-249D-01 |
|             | UCR27A                   | TOP ASSY. COMPLETE       | 01B35-250C-04 |
|             | UCR48A                   | TOP ASSY. COMPLETE       | 01B35-251C-04 |
|             | UCR60A                   | TOP ASSY. COMPLETE       | 01B35-252D-04 |
|             | UCR72A                   | TOP ASSY. COMPLETE       | 01B35-253D-04 |
| WTR27A      | TOP ASSY. COMPLETE       | 01B35-284C-04            |               |
| WTR48A      | TOP ASSY. COMPLETE       | 01B35-285D-04            |               |
| WTR60A      | TOP ASSY. COMPLETE       | 01B35-286D-04            |               |
| WTR72A      | TOP ASSY. COMPLETE       | 01B35-287D-04            |               |
| *2          | WTR27-A                  | SPLASH BOARD             | 01B36-010B    |
|             | WTR48A                   | SPLASH BOARD             | 01B36-011B    |
| 3           | SP27/-16/16C/SPD27       | TOP COVER ASSY.          | 01B36-082A-01 |
|             | SP27-12M                 | TOP COVER ASSY.          | 01B36-069C-01 |
|             | SP48-08/08C              | TOP COVER ASSY.          | 01B36-084A-03 |
|             | SP48-10/10C              | TOP COVER ASSY.          | 01B36-084A-02 |
|             | SP48-12/12C              | TOP COVER ASSY.          | 01B36-084A-01 |
|             | SP48-12M                 | TOP COVER ASSY.          | 01B36-074A-02 |
|             | SP48-18M                 | TOP COVER ASSY.          | 01B36-074A-01 |
|             | SP60-08                  | TOP COVER ASSY.          | 01B36-084A-03 |
|             | SP60-12                  | TOP COVER ASSY.          | 01B36-085A-02 |
|             | SP60-12M                 | TOP COVER ASSY.          | 01B36-073A-01 |
|             | SP60-16                  | TOP COVER ASSY.          | 01B36-085A-01 |
|             | SP60-16 (AFTER #5006876) | (SINGLE) TOP COVER ASSY. | 01B36-113A-01 |
|             | SP60-18M                 | TOP COVER ASSY.          | 01B36-074A-01 |
|             | SP60-24M                 | TOP COVER ASSY.          | 01B36-075A-01 |
| SP72-08/08C | TOP COVER ASSY.          | 01B36-085A-04            |               |

\* Indicates part not illustrated

1/28/2000

ILLUSTRATIONS 34" BASE REFRIGERATORS  
CABINET COMPONENTS

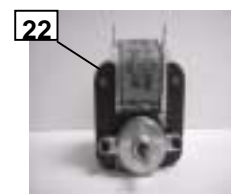
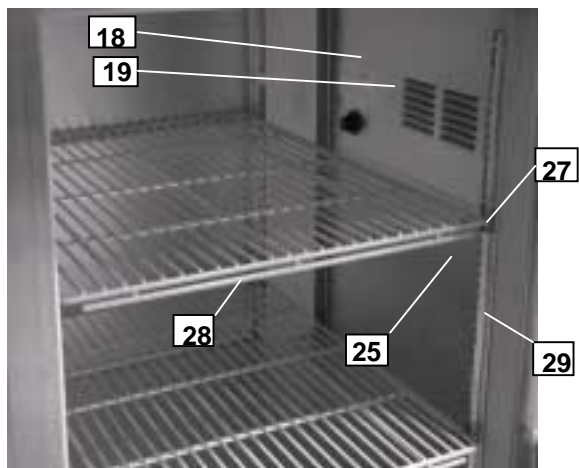
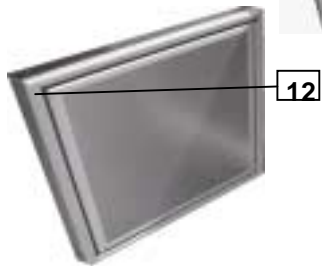
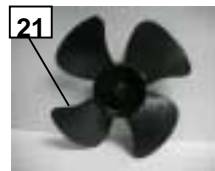
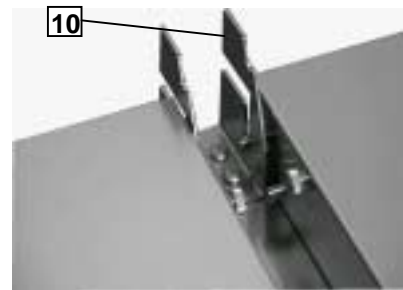
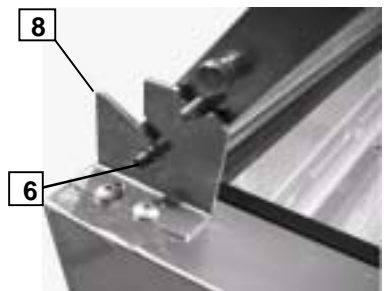
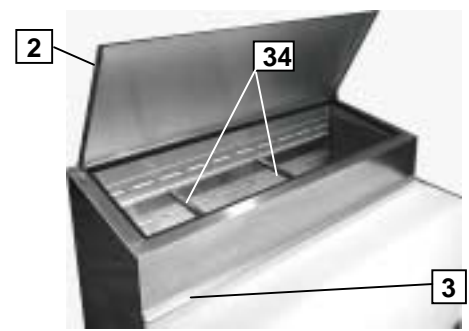

**TOP ASSEMBLES**  
**34" BASE REFRIGERATORS**

| ITEM    | MODEL              | DESCRIPTION                 | PART NUMBER   |
|---------|--------------------|-----------------------------|---------------|
| 1       | DP41               | TOP ASSY. COMPLETE          | 03B01-170D-01 |
|         | WTR41              | TOP ASSY. COMPLETE          | 03B01-106D    |
|         | UCR41              | TOP ASSY. COMPLETE          | 01B35-184C    |
|         | DP46               | TOP ASSY. COMPLETE          | 03B01-179D-01 |
|         | WTR46A             | TOP ASSY. COMPLETE          | 03B01-181D-02 |
|         | UCR46A             | TOP ASSY. COMPLETE          | 01B35-290C-06 |
|         | UCR48A             | TOP ASSY. COMPLETE          | 01B35-251C-04 |
|         | WTR48A             | TOP ASSY. COMPLETE          | 04B02-176C-02 |
|         | DP67               | TOP ASSY. COMPLETE          | 03B01-172D-01 |
|         | WTR67A             | TOP ASSY. COMPLETE          | 04B02-171C-01 |
|         | UCR67A             | TOP ASSY. COMPLETE          | 01B35-190C    |
|         | DP93               | TOP ASSY. COMPLETE          | 03B01-174D-01 |
|         | WTR93A             | TOP ASSY. COMPLETE          | 03B01-108D    |
|         | UCR93A             | TOP ASSY. COMPLETE          | 01B35-196C    |
|         | DP119              | TOP ASSY. COMPLETE          | 03B01-176D-01 |
| WTR119A | TOP ASSY. COMPLETE | 03B01-109D                  |               |
| UCR119A | TOP ASSY. COMPLETE | 01B35-202C                  |               |
| 2       | DP41               | LID ASSY. (1 NEEDED)        | 03B04-018D-01 |
|         | DP46               | LID ASSY.(1 NEEDED)         | 03B04-024D-01 |
|         | DP67               | LID ASSY. (SHORT)           | 03B04-024D-02 |
|         |                    | LID ASSY.(LONG)             | 03B04-024D-03 |
|         | DP93               | LID ASSY. (LONG) (2 NEEDED) | 03B04-024D-03 |
|         | DP119              | LID ASSY. (LONG) (2 NEEDED) | 03B04-024D-03 |
|         |                    | LID ASSY.(SHORT) (1 NEEDED) | 03B04-024D-04 |
| 3       | ALL                | LID HANDLE                  | 401-201A      |
|         | *ALL               | LID HANDLE SCREW            | 603-340A      |
| 4       | ALL DP             | HINGE BRACKET PLATE( RH)    | 03B03-019B    |
| 5       | ALL DP             | HINGE BRACKET PLATE( LH)    | 03B03-020B    |
| 6       | ALL DP             | HINGE PIN                   | 604-196A      |
| *7      | ALL DP             | INSERT #10-32 LOW HEAD      | 604-161A      |
| 8       | ALL DP             | TOP COVER HINGE (L.H.)      | 03A07-022C-04 |
| 9       | ALL DP             | TOP COVER HINGE (R.H.)      | 03A07-021C-04 |
| 10      | DP67/93/119        | TOP COVER HINGE (CENTER)    | 03A07-023C-04 |

**DOOR ASSEMBLES**  
**34" BASE REFRIGERATORS**

| ITEM | MODEL          | DESCRIPTION                   | PART NUMBER |
|------|----------------|-------------------------------|-------------|
| 11   | ALL DP/UC/WT-A | DOOR ASSEMBLY COMPLETE        | 02B01-257C  |
| 12   | ALL DP/UC/WT-A | DOOR GASKET (23-1/8X25-1/8)   | 703-963D-05 |
| 13   | ALL DP/UC/WT-A | DOOR HANDLE                   | 401-506C    |
| *14  | ALL DP/UC/WT-A | DOOR HANDLE SCREWS            | 603-338A    |
| 15   | ALL DP/UC/WT-A | DOOR HINGE (TOP/BOTTOM/LH&RH) | 401-657B    |
| 16   | ALL DP/UC/WT-A | HINGE COVER                   | 401-244B    |
| *17  | ALL DP/UC/WT-A | HINGE PIVOT CAM (NYLON)       | 401-242B    |

ILLUSTRATIONS FOR UNDER COUNTER & WORK TOP FREEZERS  
CABINET COMPONENTS

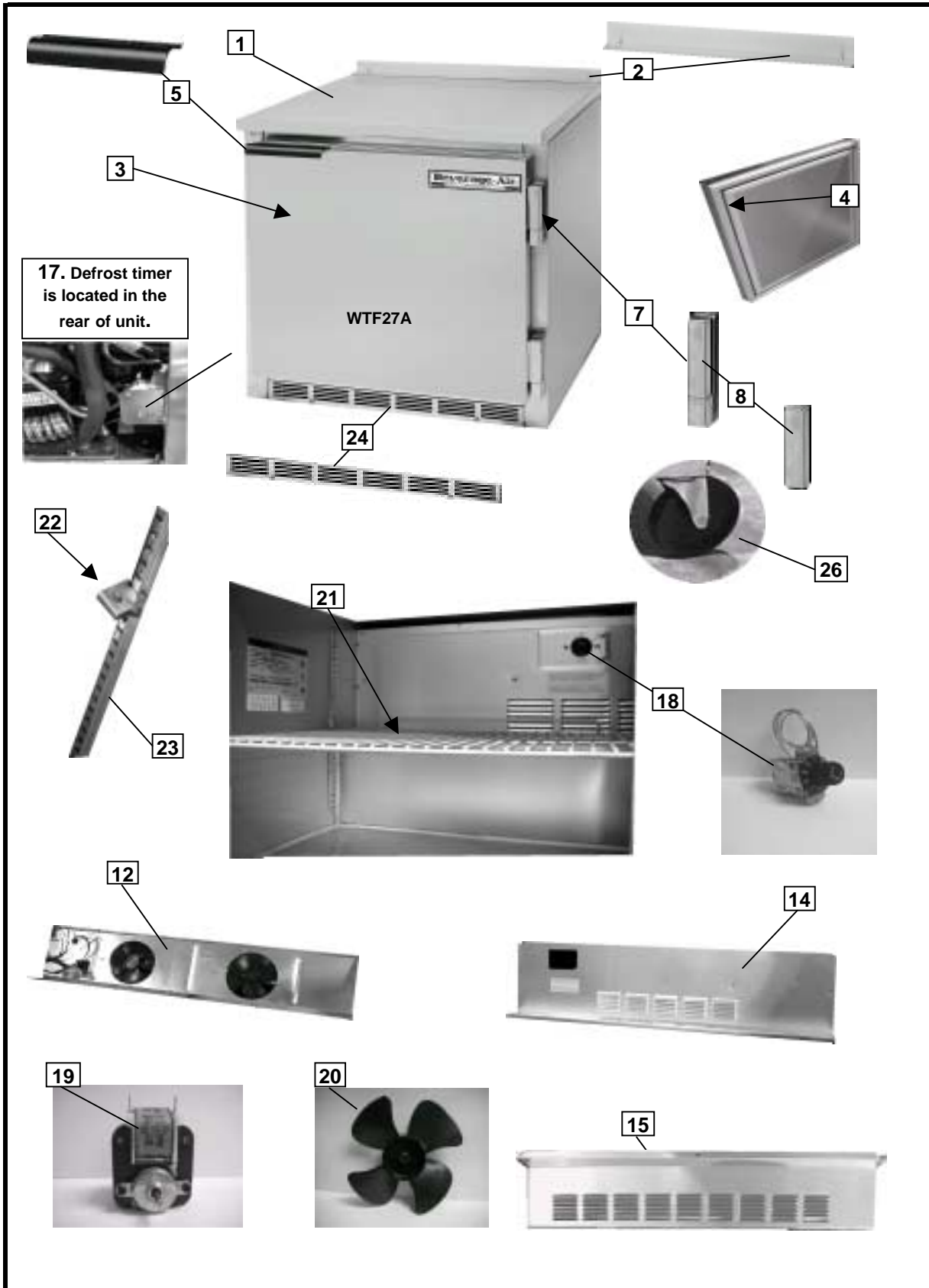

## CABINET COMPONENTS UNDER COUNTER & WORK TOP FREEZERS

| ITEM | MODEL      | DESCRIPTION        | PART NUMBER   |
|------|------------|--------------------|---------------|
| 1    | UCF/WTF27A | TOP ASSY. COMPLETE | 01B35-284C-04 |
|      | UCF/WTF48A | TOP ASSY. COMPLETE | 01B35-285D-04 |
|      | UCF/WTF67  | TOP ASSY. COMPLETE | 03B01-107D    |
| 2    | UCF/WTF27A | SPLASH BOARD ASSY. | 01B36-010B    |
|      | UCF/WTF48A | SPLASH BOARD ASSY. | 01B36-011B    |

## DOOR ASSEMBLES UNDER COUNTER & WORK TOP FREEZERS

| ITEM | MODEL         | DESCRIPTION                   | PART NUMBER |
|------|---------------|-------------------------------|-------------|
| 3    | UCF/WTF27A    | D00R ASSEMBLY COMPLETE        | 02B01-249C  |
|      | UCF/WTF48A    | D00R ASSEMBLY COMPLETE        | 02B01-253C  |
|      | UCF/WTF67     | D00R ASSEMBLY COMPLETE        | 02B01-257C  |
| 4    | UCF/WTF27A    | DOOR GASKET (23-18X24-1/2)    | 703-963D-02 |
|      | UCF/WTF48A    | DOOR GASKET (21-1/16X23-1/8)  | 703-963D-03 |
|      | UCF/WTF67     | DOOR GASKET (23-1/8X25-1/8)   | 703-963D-05 |
| 5    | UCF/WTF27/48A | DOOR HANDLE                   | 401-506C    |
| *6   | UCF/WTF27/48A | DOOR HANDLE SCREWS            | 603-338A    |
| 7    | UCF/WTF27/48A | DOOR HINGE (TOP/BOTTOM/LH&RH) | 401-657B    |
| 8    | UCF/WTF27/48A | HINGE COVER                   | 401-244B    |
| *9   | UCF/WTF27/48A | HINGE PIVOT CAM (NYLON)       | 401-242B    |
| *10  | UCF/WTF27/48A | THERMOMETER                   | 402-233B    |
| *11  | UCF/WTF27A&67 | FACE HEATER                   | 504-247B    |
|      | UCF/WTF48A    | FACE HEATER                   | 504-248B    |

## EVAPORATOR HOUSINGS UNDER COUNTER & WORK TOP FREEZERS

| ITEM   | MODEL         | DESCRIPTION            | PART NUMBER   |
|--|---------------|------------------------|---------------|
| 12   | UCF/WTF27/48A | EVAP. HOUSING ASSY.    | 04B01-076D-02 |
|  | UCF/WTF27/48A | EVAP HSG. ONLY         | 04A02-356D-09 |
| *13  | UCF/WTF67     | EVAP.FAN MOUNT ASSY.   | 04B04-036C    |
| 14   | UCF/WTF67     | EVAP.FRT.COVER ASSY.   | 04B04-043C    |
|  | UCF/WTF27/48A | EVAP.FRT.COVER ASSY.   | 04B02-175D-04 |
| 15   | ALL UCF/WTF   | EVAP. TOP COVER        | 28D47-040D-10 |
| Note: UCF/WTF/27/48A units have the evaporator pans incorporated into the cabinet and are not replaceable. After serial number 5100521 |               |                        |               |
| *16  | UCF/WTF67     | PAN ASSY - EVAP        | 04B02-171C-01 |
| 17   | UCF/WTF27/48A | DEFROST TIMER          | 502-171A      |
|  | UCF/WTF67     | DEFROST TIMER          | 502-233A      |
| 18   | UCF/WTF27/48A | TEMP. CONTROL          | 502-111A      |
|  | UCF/WTF67     | TEMP. CONTROL          | 502-150A      |
| 19   | ALL UCF/WTF   | EVAPORATOR MOTOR       | 501-105B      |
| 20   | ALL UCF/WTF   | EVAPORATOR MOTOR BLADE | 405-063A      |



ILLUSTRATIONS SPD/UCRD/WTRD/UCR UNITS  
CABINET COMPONENTS

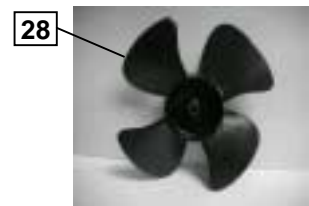
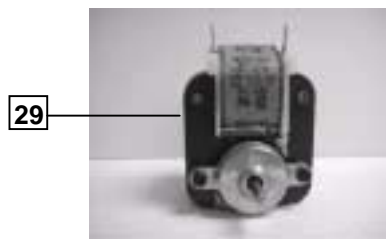
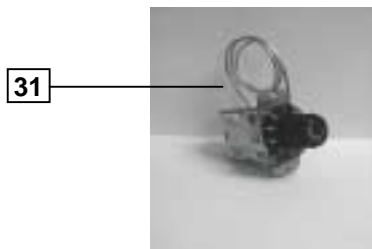
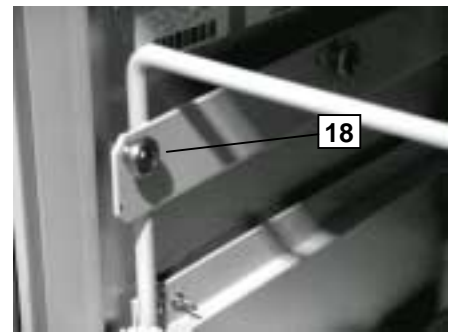
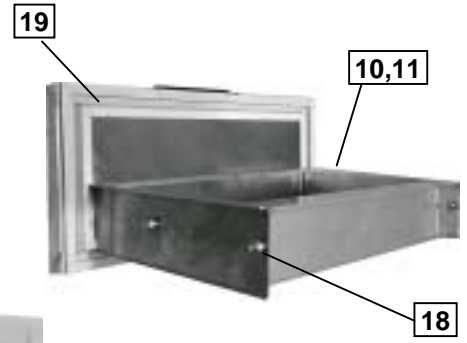
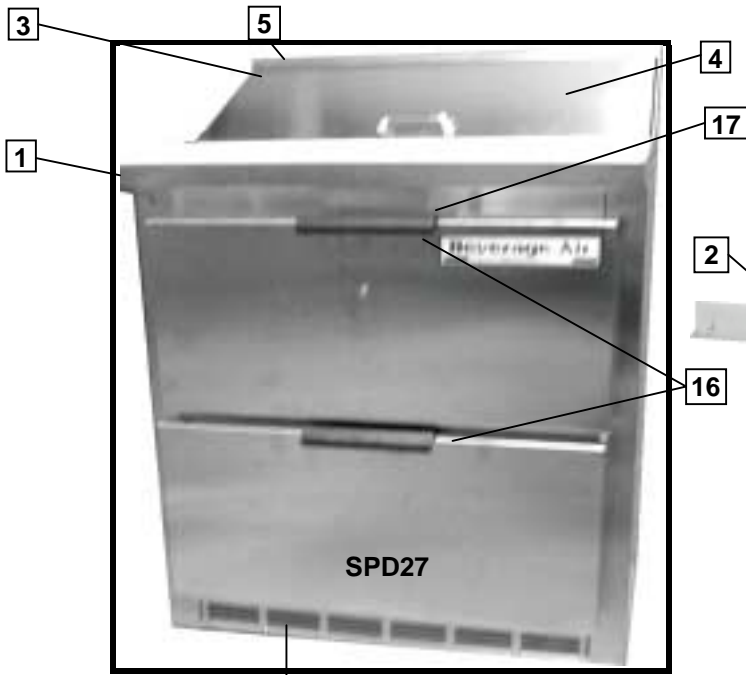
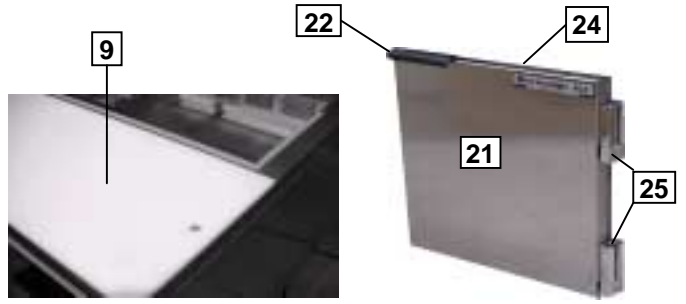
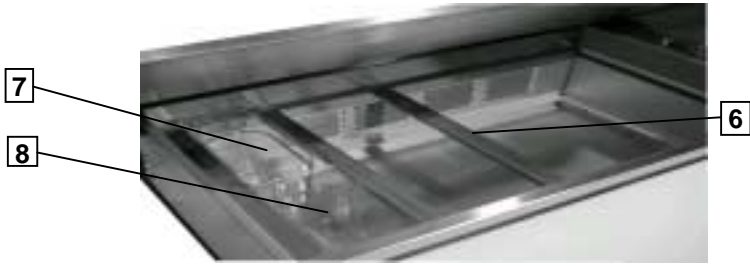



**TOP ASSEMBLES**  
**SPD/UCRD/WTRD27/UCR20/34**

| ITEM | MODEL    | DESCRIPTION               | PART NUMBER   |
|------|----------|---------------------------|---------------|
| 1    | SPD27    | TOP ASSY. COMPLETE        | 01B35-254C-01 |
|      | UCRD27-A | TOP ASSY. COMPLETE        | 01B35-250C-04 |
|      | WTRD27-A | TOP ASSY. COMPLETE        | 01B35-284C-04 |
|      | UCR20    | TOP ASSY. COMPLETE        | 01B35-237C-06 |
|      | UCR34    | TOP ASSY. COMPLETE        | 01B35-214C    |
| 2    | WTRD27-A | SPLASH BOARD              | 01B36-010B    |
| 3    | SPD27    | TOP COVER ASSY.           | 01B36-082A-01 |
| 4    | SPD27    | TOP COVER (LID)           | 01B40-002D-01 |
| 5    | SPD27    | SERVING BAR (LID HOUSING) | 01B36-093C-01 |
| 6    | SPD27    | PAN SUPPORTS (3 NEEDED)   | 28D40-056C-05 |
| 7    | SPD27    | PAN 1/6 4 DEEP PLASTIC    | 403-490C      |
| 8    |          | PAN 1/9 4 DEEP PLASTIC    | 403-493C      |
| 9    | SPD27    | CUTTING BOARD (10")       | 705-290C-01   |

**DRAWER ASSEMBLES**  
**SPD/UCRD/WTRD27 ONLY**

| ITEM | MODEL               | DESCRIPTION              | PART NUMBER   |
|------|---------------------|--------------------------|---------------|
| 10   | SPD27/UCRD WTRD27-A | DRAWER ASSY -COMP TOP    | 00B27-089D-02 |
| 11   | SPD27/UCRD WTRD27-A | DRAWER ASSY -COMP BOT    | 00B27-088D-02 |
| 12   | SPD27/UCRD WTRD27-A | RAIL ASSY - SLIDE LH     | 00B27-072C-01 |
| 13   | SPD27/UCRD WTRD27-A | RAIL ASSY - SLIDE RH     | 00B27-072C-02 |
| 14   | SPD27/UCRD WTRD27-A | SLIDE RAIL ASSY-BOT LH   | 00B27-086C-01 |
| 15   | SPD27/UCRD WTRD27-A | SLIDE RAIL ASSY-BOT RH   | 00B27-086C-02 |
| 16   | SPD27/UCRD WTRD27-A | DRAWER HANDLE            | 401-506C      |
| 17   | SPD27/UCRD WTRD27-A | DRAWER HANDLE SCREWS     | 603-408A      |
| 18   | SPD27/UCRD WTRD27-A | DRAWER ROLLERS           | 403-513A      |
| 19   | SPD27/UCRD WTRD27-A | DRAWER GASKET            | 703-963D-15   |
| 20   | SPD27/UCRD WTRD27-A | PAN SUPPORTS FOR DRAWERS | 00A27-057B-04 |

## 220V/50HZ SECTION COMPRESSORS

| ITEM | MODEL   | DESCRIPTION                               | PART NUMBER |
|------|---|---|-------------|
| 1    | SP27/UCR WTR27-A<br>DP/UCR/WTR46/67-A<br>SPD/UCRD/WTRD27<br>UCR20 | COMPRESSOR 1/6HP 220-50 SIC<br>AZ0370Y    | 302-952B    |
|      | SP48/UCR48 WTR48-A<br>DP/UCR/WTR93/119-A<br>UCR34                 | COMPRESSOR 1/5HP 220-50 SIC<br>AZAO395YXC | 302-828B    |
|      | SP60/UCR60A WTR60A<br>SP72/UCR72 WTR72A                           | COMPRESSOR 1/4HP 220-50 SIC<br>AEA3430YXC | 302-648B    |
|      | UCF/WTF27/48-A  | COMPRESSOR 1/4HP 220-50 TEC<br>AE2380Z    | 302-946B    |

### OVERLOADS

| ITEM | MODEL   | DESCRIPTION         | PART NUMBER |
|------|---|---------------------|-------------|
| 2    | SP27/UCR WTR27-A<br>DP/UCR/WTR46/67-A<br>SPD/UCRD/WTRD27<br>UCR20 | (TI) 4TM232NFBYY-53 | 302-971A    |
|      | SP48/UCR48 WTR48-A<br>DP/UCR/WTR93/119-A<br>UCR34                 | (TI)4TM739JDBYY-51  | 302-941A    |
|      | SP60/UCR60A WTR60A<br>SP72/UCR72 WTR72A                           | (TI) MRP 59 AMK-69  | 302-838A    |
|      | UCF/WTF27/48-A  | (TI)MRP61AMN-69     | 313-002A    |

### RELAYS

| ITEM | MODEL   | DESCRIPTION     | PART NUMBER |
|------|---|-----------------|-------------|
| 3    | SP27/UCR WTR27-A<br>DP/UCR/WTR46/67-A<br>SPD/UCRD/WTRD27<br>UCR20 | (TI) 8EA203     | 302-972A    |
|      | SP48/UCR48 WTR48-A<br>DP/UCR/WTR93/119-A<br>UCR34                 | (TI)8EA203      | 302-940A    |
|      | SP60/UCR60A WTR60A<br>SP72/UCR72 WTR72A                           | (TEC)8200EMBE64 | 314-010A    |
|      | UCF/WTF27/48-A  | (TEC)8200EMBJ49 | 314-001A    |

### START CAPACITORS

| ITEM | MODEL          | DESCRIPTION               | PART NUMBER |
|------|----------------|---------------------------|-------------|
| 4    | UCF/WTF27/48-A | START CAP (TEC)855S220C66 | 315-002A    |
|      | UCF/WTF27/48-A | CAP/RELAY ASSY            | 317-002A    |

### EVAPORATOR FAN MOTORS

| ITEM | MODEL | DESCRIPTION     | PART NUMBER |
|------|-------|-----------------|-------------|
| 5    | ALL   | .40 AMPS 220-50 | 501-087B    |

### CONDENSER FAN MOTORS

| ITEM | MODEL | DESCRIPTION       | PART NUMBER |
|------|-------|-------------------|-------------|
| 6    | ALL   | 5 WATTS 230-50/60 | 501-055B    |

Note\* All other parts will be the same as standard units located in the first portion of this manual.

## DOOR ASSEMBLES UCR20/34 ONLY

| ITEM | MODEL    | DESCRIPTION               | PART NUMBER |
|------|----------|---------------------------|-------------|
| 21   | UCR20    | DOOR ASSY.COMP.           | 02B01-241C  |
|      | UCR34    | DOOR ASSY.COMP.           | 02B01-245C  |
| 22   | UCR20/34 | DOOR HANDLE               | 401-506C    |
| 23   | UCR20/34 | DOOR HANDLE SCREWS        | 603-364A    |
| 24   | UCR20    | DOOR GASKET               | 703-963D-11 |
|      | UCR34    | DOOR GASKET               | 703-963D-01 |
| 25   | UCR20/34 | DOOR HINGE (TOP & BOTTOM) | 401-657B    |

## EVAPORATOR ASSEMBLES SPD/UCRD/WTRD27/UCR20/34

| ITEM | MODEL                           | DESCRIPTION   | PART NUMBER   |
|------|---------------------------------|---|---------------|
| 26   | SPD27/UCRD WTRD27-A             | HSG ASSY-EVAP   | 04B01-076D-02 |
|      | UCR20                           | HSG ASSY-EVAP   | 04B01-056D    |
|      | UCR34                           | HSG ASSY-EVAP   | 04B01-066D-02 |
| 27   | SPD27/UCRD WTRD27-A             | COVER ASSY - EVAP   | 04B02-175D-02 |
|      | UCR20                           | EVAP.HSG.FRT.GRL.ASSY   | 04B02-102C    |
|      | UCR34                           | EVAP.FRT.GRILLE ASSY  | 04B02-091C    |
| 28   | SPD27/UCRD WTRD27-A<br>UCR20/34 | EVAP. FAN BLADE   | 405-063A      |
| 29   | SPD27/UCRD WTRD27-A<br>UCR20/34 | EVAP. FAN MOTOR   | 501-105B      |
| 30   | ALL                             | EVAP. MOTOR BRCKET  | 42A37P011B    |
| 31   | SPD27/UCRD WTRD27-A             | TEMP. CONTROL   | 502-269A      |
|      | UCR20                           | TEMP. CONTROL   | 502-205A      |
|      | UCR34                           | TEMP. CONTROL   | 502-236A      |
| 32   | SPD27/UCRD WTRD27               | EVAPORATOR PANS ARE INCORPORATED INTO THE CABINET & ARE NOT REPLACEABLE AFTER SERIAL #5100521 | NA            |
|      | UCR20                           | EVAP. DRAIN PAN   | 04B02-101C    |
|      | UCR34                           | EVAP. DRAIN PAN   | 04B02-090C    |
| 33   | ALL                             | THERMOMETER - HORIZ PUSH-IN   | 402-223B      |

## SHELVES UCR20/34 ONLY

| ITEM | MODEL    | DESCRIPTION                  | PART NUMBER |
|------|----------|------------------------------|-------------|
| 34   | UCR20    | SHELF 12.13X15.3812.13X15.38 | 403-419D    |
|      | UCR24    | SHELF 11X29.38               | 403-339D    |
| 35   | UCR20/34 | SHELF CLIPS                  | 403-169A    |
| 36   | UCR20/34 | PILASTER 27/48 15"           | 403-154A    |
| 37   | UCR20/34 | PILASTER 10"                 | 403-307A    |
| 38   | ALL      | CASTER KIT                   | 00C31-038A  |

## GRILLS SPD/UCRD/WTRD27/UCR20/34

| ITEM | MODEL               | DESCRIPTION        | PART NUMBER   |
|------|---------------------|--------------------|---------------|
| 39   | SPD27/UCRD WTRD27-A | GRILLE ASSY -FRONT | 07B31-061B    |
|      | UCR20               | GRILLE ASSY -FRONT | 07B31-062C    |
|      | UCR34               | GRILLE ASSY -FRONT | 07B31-051C    |
| 40   | SPD27/UCRD WTRD27-A | GRILLE - REAR      | 28D37-090D-03 |
|      | UCR20               | GRILLE - REAR      | 28D37-054D    |
|      | UCR34               | GRILLE - REAR      | 28D37-052D    |

# REFRIGERATION

## SPD/UCRD/WTRD27UCR20/34

| ITEM | MODEL                          | DESCRIPTION                               | PART NUMBER   |
|------|--------------------------------|---|---------------|
| 1    | SPD27/UCRD WTRD27              | REFRIGERATION ASSEMBLY                    | 19B36-086D-01 |
|      | UCR20                          | REFRIGERATION ASSEMBLY                    | 19C30-091C    |
|      | UCR34                          | REFRIGERATION ASSEMBLY                    | 19C30-089C    |
| 2    | SPD27/UCRD WTRD27              | CONDENSING UNIT                           | 15B33-045C    |
|      | UCR20                          | CONDENSING UNIT                           | 15B33-063C    |
|      | UCR34                          | CONDENSING UNIT                           | 15B33-061C    |
| 3    | SPD27/UCRD WTRD27/UCR20        | COMPRESSOR (1/6HP) (AZA0370YXA)           | 302-687B      |
|      | UCR34                          | COMPRESSOR (1/5HP) (AZA0395YXA)           | 302-676B      |
| 4    | SPD27/UCRD WTRD27/UCR20        | OVERLOAD                                  | 302-688A      |
|      | UCR34                          | OVERLOAD                                  | 302-918A      |
| 5    | SPD27/UCRD WTRD27/UCR20        | RELAY                                     | 302-702A      |
|      | UCR34                          | RELAY                                     | 302-677A      |
| 6    | UCR34                          | START CAPACITOR                           | 302-919A      |
| 7    | ALL                            | DRYER                                     | 303-143A      |
| 8    | SPD27/UCRD WTRD27-A/UCR34      | CONDENSER COIL(5-5/16X7-7/8X3)            | 305-144C      |
|      | UCR20                          | CONDENSER COIL(5-1/8X8X2)                 | 305-204C      |
| 9    | SPD27/UCRD WTRD27A<br>UCR20/34 | CONDENSER FAN MOTOR ( 5 WATTS )           | 501-019B      |
| 10   | SPD27/UCRD WTRD27              | CONDENSER FAN BLADE( 6.75" ) (3 PED ALUM) | 405-015A--    |
|      | UCR20/34                       | CONDENSER FAN BLADE                       | 405-058A      |
| 11   | SPD27/UCRD WTRD27-A            | EVAPORATOR COIL ASSY.                     | 19B31-021D    |
|      | UCR20                          | EVAPORATOR COIL ASSY.                     | 20B30-088D    |
|      | UCR34                          | EVAPORATOR COIL ASSY.                     | 20B30-083D    |
| 12   | SPD27/UCRD WTRD27-A            | EVAP COIL (20X4X3)                        | 305-175C      |
|      | UCR20                          | EVAP COIL (10X4X3)                        | 305-202C      |
|      | UCR34                          | EVAP COIL (20X4X3)                        | 305-209C      |

\* Indicates part not illustrated

03/27/2000

# REFRIGERATION (CONTINUED)

## SPD/UCRD/WTRD27

### UCR20/34

| ITEM | MODEL                     | DESCRIPTION                    | PART NUMBER   |
|------|---------------------------|--------------------------------|---------------|
| 13   | UCR20                     | SUC/CAP ASSY                   | 20B35-077D    |
|      | UCR34                     | SUC/CAP ASSY                   | 20B35-075D    |
| 14   | SPD27/UCRD WTRD27-A/UCR34 | CAP TUBE .036ID X .087OD X 120 | 203-048A--    |
|      | UCR20                     | CAP TUBE .031ID X .081OD X 48  | 203-129A      |
| 15   | SPD27/UCRD WTRD27-A       | ACCUMULATOR                    | 303-071A      |
|      | UCR20/34                  | ACCUMULATOR                    | 303-094A      |
| 16   | SPD27/UCRD WTRD27-A       | REFRIGERANT                    | 0.4375        |
|      | UCR20                     | REFRIGERANT                    | 0.3125        |
|      | UCR34                     | REFRIGERANT                    | 0.28125       |
| 17   | SPD27                     | WIRING DIAGRAM                 | *IL-1792B     |
|      | UCRD/WTRD27-A             | WIRING DIAGRAM                 | *IL-1811D     |
|      | UCR20/34                  | WIRING DIAGRAM                 | *ILB-1351     |
| 18   | SPD27                     | WIRE HARNESS                   | 504-762C      |
|      | UCRD/WTRD27A UCR20/34     | WIRE HARNESS                   | 504-430C      |
| 19   | SPD27                     | CONDENSATE PAN                 | 08B30-041D-01 |
|      | UCRD/WTRD27-A             | CONDENSATE PAN                 | 706-047C      |
|      | UCR20                     | CONDENSATE PAN                 | 30D02-014C    |
|      | UCR34                     | CONDENSATE PAN                 | 30D02-013C    |

REFRIGERATION ASSEMBLY COMPONENTS  
(REFRIGERATORS)

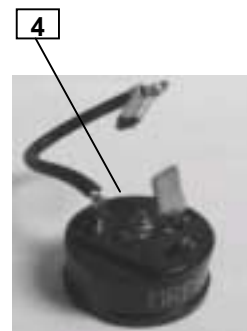
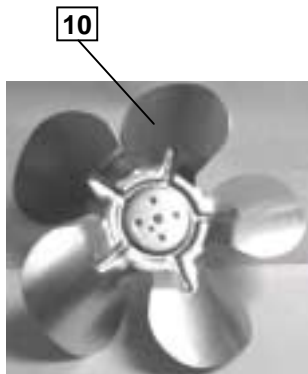
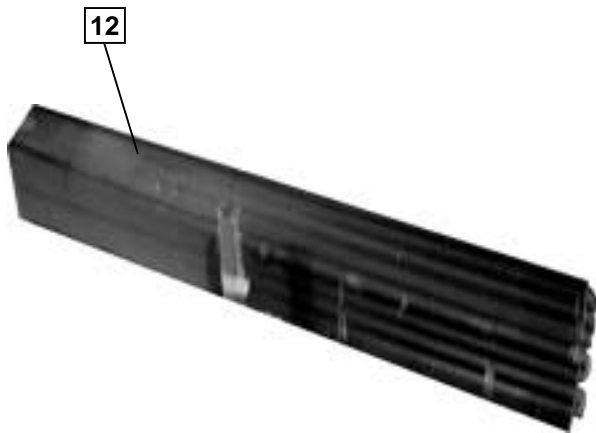



**SHELVES & GRILLS  
UNDER COUNTER & WORK TOP FREEZERS**

| ITEM | MODEL         | DESCRIPTION | PART NUMBER   |
|------|---------------|-------------|---------------|
| 21   | UCF/WTF27A    | 22.25X15.5  | 403-294D      |
|      | UCF/WTF48A    | 20.88X14.5  | 403-293D      |
|      | UCF/WTF67     | 20.82X26    | 403-507D      |
| 22   | ALL UCF/WTF   | SHELF CLIPS | 403-169A      |
| 23   | UCF/WTF27/48A | 15"         | 403-154A      |
|      | UCF/WTF67     | 21"         | 403-514B      |
| 24   | UCF/WTF24/48A | FRONT GRILL | 07B31-061B    |
|      | UCF/WTF67     | FRONT GRILL | 28D37-033C    |
| *25  | UCF/WTF27/48A | REAR GRILL  | 28D37-088D-03 |
| 26   | UCF/WTF27/48A | CASTER KIT  | 00C31-038A    |
|      | UCF/WTF67     | CASTER KIT  | 29B02-015A    |

## REFRIGERATION UNDER COUNTER & WORK TOP FREEZERS

| ITEM | MODEL         | DESCRIPTION                          | PART NUMBER   |
|------|---------------|--------------------------------------|---------------|
| *1   | UCF/WTF27/48A | REFRIGERATION ASSEMBLY               | 19B36-082D-01 |
|      | UCF/WTF67     | REFRIGERATION ASSEMBLY               | 19B36-059D    |
| 2    | UCF/WTF27/48A | CONDENSING UNIT                      | 19B34-037D-01 |
|      | UCF/WTF67     | CONDENSING UNIT                      | 15B01-052D    |
| 3    | UCF/WTF27/48A | COMPRESSOR(1/4HP 115-60 AEA2380ZXA)  | 302-924B      |
|      | UCF/WTF67     | COMPRESSOR(3/4HP 115-60 RS64CIE-CAA) | 302-881B      |
| 4    | UCF/WTF27/48A | OVERLOAD (TI)MRP30AGK-69)            | 313-003A      |
|      | UCF/WTF67     | OVERLOAD (071-0127-43)               | 302-882A      |
| 5    | UCF/WTF27/48A | RELAY (3ARR12-KPL226 )               | 314-002A      |
|      | UCF/WTF67     | RELAY (040-0001-38)                  | 302-883A      |
| 6    | UCF/WTF27/48A | START CAP.(243-292 MFD @ 110V)       | 302-993A      |
|      | UCF/WTF67     | START CAP.(81-90 MFD @ 320V)         | 302-885A      |
|      | UCF/WTF67     | RUN CAP.(30MFD @ 440V)               | 302-884A      |
|      | UCF/WTF67     | RUN CAP. ASSY.(514-1207-48)          | 302-886A      |
| 7    | ALL UCF/WTF   | DRYER                                | 303-143A      |
| 8    | UCF/WTF27/48A | CONDENSER COIL (6X8.13X3.5)          | 305-362C      |
|      | UCF/WTF67     | CONDENSER COIL (11X10-7/8X4)         | 305-160C      |
| 9    | UCF/WTF27A    | CONDENSER FAN MOTOR (5 WATTS)        | 501-019B      |
|      | UCF/WTF48A&67 | CONDENSER FAN MOTOR (9 WATTS )       | 501-148B      |
| 10   | UCF/WTF27A    | CONDENSER FAN BLADE                  | 405-015A--    |
|      | UCF/WTF48A    | CONDENSER FAN BLADE                  | 405-050A      |
|      | UCF/WTF67     | CONDENSER FAN BLADE                  | 405-066B      |
| *11  | UCF/WTF27/48A | EVAP. COIL ASSY.                     | 19B31-008D-01 |
|      | UCF/WTF67     | EVAP. COIL ASSY.                     | 20B30-102D    |
| 12   | UCF/WTF27/48A | EVAP. COIL ONLY.(20X4X4 )            | 305-176C      |
|      | UCF/WTF67     | EVAP. COIL ONLY.( 20X7X4)            | 305-222C      |
| *13  | UCF/WTF27/48A | SUCTION LINE AND CAP. ASSY.          | 19B30-025D    |
|      | UCF/WTF67     | SUCTION LINE AND CAP. ASSY.          | 20B35-093D    |
| 14   | UCF/WTF27/48A | CAP. TUBE .036IDX.087ODX84           | 203-126A      |
|      | UCF/WTF67     | CAP. TUBE .042ID X .093OD X 68       | 203-109A      |
| *15  | ALL           | ACCUMULATOR                          | 303-071A      |
| *16  | UCF/WTF27/48A | REFRIGERANT .37500 LBS               | R404A         |
|      | UCF/WTF67     | REFRIGERANT .96900 LBS               | R404A         |
| *17  | UCF/WTF27/48A | WIRING DIAGRAM                       | *ILA-0886     |
|      | UCF/WTF67     | WIRING DIAGRAM                       | *ILB-1488     |
| *18  | WTF27         | WIRING HARNESS                       | 504-787C      |
|      | WTF48         | WIRING HARNESS                       | 504-291C      |
|      | UCF/WTF67     | WIRING HARNESS                       | 504-291C      |
| *19  | UCF/WTF27/48A | CONDENSATE PAN                       | 706-047C      |
|      | UCF/WTF67     | CONDENSATE PAN                       | 43B35-012C    |
| 20   | UCF/WTF27/48A | DEFROST HEATER                       | 504-454B      |
|      | UCF/WTF67     | DEFROST HEATER                       | 504-465B      |
|      | ALL UCF/WTF   | DEFROST LIMIT SWITCH                 | 502-089A      |

\*Indicates parts not illustrated

3/01/2000

REFRIGERATION ASSEMBLY COMPONENTS  
(FREEZERS)

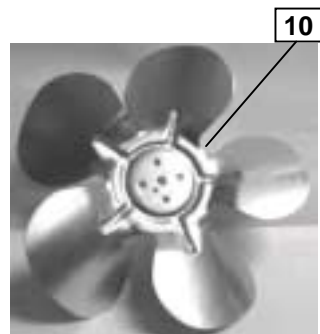
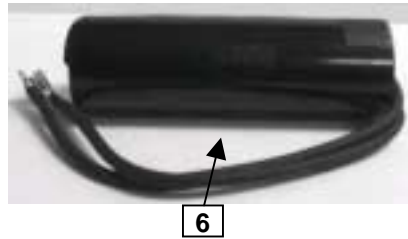
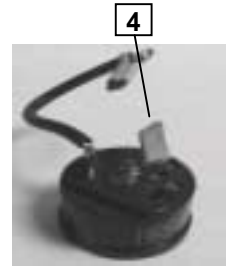
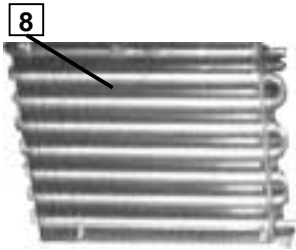
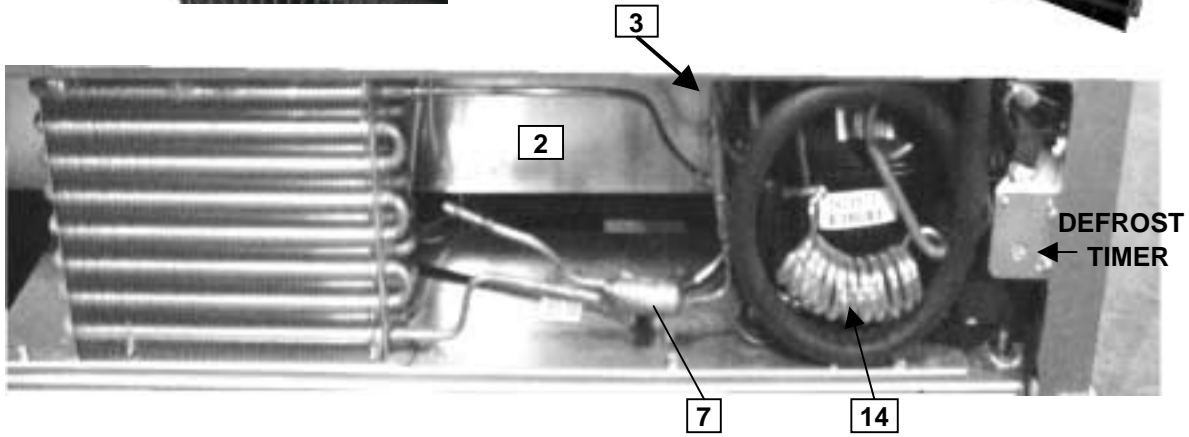
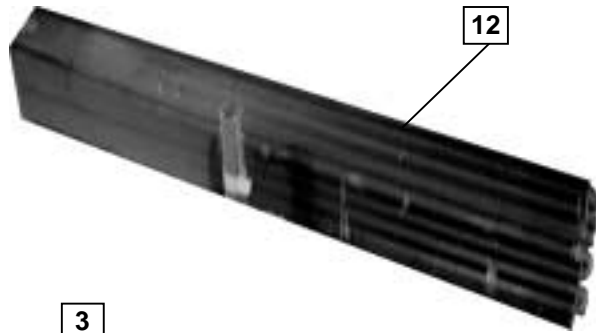

## EVAPORATOR HOUSINGS 34" BASE REFRIGERATORS

| ITEM | MODEL                              | DESCRIPTION               | PART NUMBER   |
|------|------------------------------------|---------------------------|---------------|
| 18   | UCR/WTR27/48A                      | EVAP. HOUSING             | 04B01-076D-02 |
| 19   | ALL DP                             | EVAP. FAN COVER           | 04B04-050C    |
|      | UCR/WTR27A                         | EVAP. FAN COVER           | 04B02-175D-02 |
|      | UCR/WTR46/67/93/119A               | EVAP. FAN COVER           | 04B04-043C    |
|      | UCR/WTR48A                         | EVAP. FAN COVER           | 04B02-176C-02 |
| *20  | ALL DP                             | EVAP. FAN MOUNT ASSY.     | 04B04-055C-02 |
|      | WTR46/67A                          | EVAP. FAN MOUNT ASSY.     | 04B04-016C    |
|      | UCR/WTR93/119A                     | EVAP. FAN MOUNT ASSY.     | 04B04-018C    |
| 21   | UCR/UTR41/46/48/93/119-A<br>ALL DP | EVAP.FAN BLADE (6" WHITE) | 405-062A      |
|      | UCR/WTR27A                         | EVAP.FAN BLADE (6"BLACK)  | 405-063A      |
| 22   | ALL DP/UCR/WTR                     | EVAP. MOTOR               | 501-105B      |
| *23  | ALL DP/UCR/WTR                     | EVAP. MOTOR BRACKET       | 42A37-011B    |
| 24   | ALL DP                             | TEMP. CONT                | 502-140A      |
|      | UCR/WTR27A                         | TEMP. CONT                | 502-269A      |
|      | UCR/WTR41-46/48/67/93/119A         | TEMP. CONT                | 502-290B      |
| 25   | ALL DP                             | EVAP. DRAIN PAN ASSY.     | 04B02-060C    |
|      | UCR/WTR41-46/67/93/119A            | EVAP. DRAIN PAN ASSY.     | 04B02-171C-01 |
| *26  | ALL DP                             | THERMOMETER               | 401-236B      |

## SHELVES, CUTTING BOARDS & GRILLS 34" BASE REFRIGERATORS

| ITEM | MODEL                                  | DESCRIPTION            | PART NUMBER   |
|------|--|------------------------|---------------|
| 27   | ALL DP/WT/UC-A                         | SHELF SUPPORT          | 403-169A      |
| 28   | ALL DP/WT/UC-A                         | SHELF (20.82X36)       | 403-507D      |
| 29   | ALL DP/WT/UC-A                         | PILASTER (21")         | 403-514B      |
| 30   | DP41                                   | CUTTING BOARD (19X41)  | 705-285B      |
|      | DP46                                   | CUTTING BOARD (19X46)  | 705-307C-01   |
|      | DP67                                   | CUTTING BOARD (19X67)  | 705-286B      |
|      | DP93                                   | CUTTING BOARD (19X93)  | 705-287B      |
|      | DP119                                  | CUTTING BOARD (19X119) | 705-288B      |
| 31   | DP41                                   | CUTTING BOARD RETAINER | 28D40-053B-05 |
|      | DP46                                   | CUTTING BOARD RETAINER | 107-429C-01   |
|      | DP67                                   | CUTTING BOARD RETAINER | 107-429C-02   |
|      | DP93                                   | CUTTING BOARD RETAINER | 107-429C-03   |
|      | DP119                                  | CUTTING BOARD RETAINER | 107-429C-04   |
| 32   | ALL DP/UCR/WTR                         | GRILL ASSY. (FRONT)    | 28D37-033C    |
| 33   | DP41/46/67/93/WTR/UCR41/46/<br>67/93-A | CASTER ASSY.           | 29B02-015A    |
|      | DP/WT119                               | CASTER ASSY.           | 29B02-016A    |

## PAN SUPPORTS 34" BASE REFRIGERATORS

| ITEM | UNIT  | DESCRIPTION             | PART NUMBER   |
|------|-------|-------------------------|---------------|
| 34   | DP41  | PAN SUPPORTS (1 NEEDED) | 28D40-054B-05 |
|      | DP46  | PAN SUPPORTS (2 NEEDED) | 28D40-054B-05 |
|      | DP67  | PAN SUPPORTS (5 NEEDED) | 28D40-054B-05 |
|      | DP93  | PAN SUPPORTS (3 NEEDED) | 28D40-054B-05 |
|      | DP93  | PAN SUPPORTS (1 NEEDED) | 28D40-055B-05 |
|      | DP119 | PAN SUPPORTS (4 NEEDED) | 28D40-054B-05 |

## REFRIGERATION

### 34" BASE REFRIGERATORS

| ITEM | UNIT                         | DESCRIPTION                       | PART NUMBER   |
|------|------------------------------|-----------------------------------|---------------|
| 1    | DP41/DP/UCR/WTR46/67-A       | REFRIGERATION ASSEMBLY            | 19B36-078D    |
|      | DP93/119/UC/WT93-A           | REFRIGERATION ASSEMBLY            | 19B36-079D-01 |
|      | UCR/WTR41                    | REFRIGERATION ASSEMBLY            | 19B36-042D    |
|      | UCR/WTR119-A                 | REFRIGERATION ASSEMBLY            | 19B36-062D-01 |
| 2    | DP41/DP/UCR/WTR46/67-A       | CONDENSING UNIT                   | 15B01-038D    |
|      | DP/UCR/WTR41/93/119-A        | CONDENSING UNIT                   | 15B01-036D    |
| 3    | DP41/DP/UCR/WTR46/67-A       | COMPRESSOR1/6 HP ( AE3440YXA)     | 302-803B      |
|      | DP/UCR/WTR41/93/119-A        | COMPRESSOR1/5 HP ( AE3430YXA)     | 302-804B      |
| 4    | DP41/DP/UCR/WTR46/67-A       | OVERLOAD (TI)MRP26ALL-69          | 302-815A      |
|      | DP/UCR/WTR41/93/119-A        | OVERLOAD (TI) MRT24AIK-69         | 302-911A      |
| 5    | DP41/DP/UCR/WTR46/67-A       | RELAY (TI) 966-042-176            | 302-646B      |
|      | DP/UCR/WTR41/93/119-A        | RELAY (TI) 9660-042-182           | 302-350A      |
| 6    |                              | START CAP.                        | NA            |
| 7    | ALL                          | DRYER                             | 303-143A      |
| 8    | DP41/DP/UCR/WTR46/67-A       | COND. COIL (11X10-7/8X2)          | 305-150C      |
|      | DP/UCR/WTR41/93/119-A        | COND. COIL (11X10-7/8X3)          | 305-151C      |
| 9    | DP41/DP/UCR/WTR46/67-A       | COND. FAN MOTOR (5WATT) 115/60    | 501-148B      |
| 10   | DP/UCR/WTR41/93/119-A        | COND. FAN BLADE (6.75" )          | 405-066B      |
| 11   | DP41/DP/UCR/WTR46/67-A       | EVAP. COIL ASSY.                  | 19B31-014C    |
|      | DP93/119/UC/WT93-A           | EVAP. COIL ASSY                   | 19B31-015C    |
|      | UCR/WTR41                    | EVAP. COIL ASSY                   | 20B30-100C    |
|      | UCR/WTR119-A                 | EVAP. COIL ASSY                   | 20B30-111C    |
| 12   | DP41/46/67 UCR/WTR41/46/67-A | EVAP. COIL ONLY (20X6X3)          | 305-172C      |
|      | DP93/119 UCR/WTR93/119-A     | EVAP. COIL ONLY (20X7X4)          | 305-173C      |
| *13  | DP41/DP/UCR/WTR46/67-A       | SUCTION LINE AND CAP. TUBE ASSY.  | 19B30-038D    |
|      | DP93/119/UC/WT93-A           | SUCTION LINE AND CAP. TUBE ASSY.  | 19B30-039D    |
|      | UCR/WTR41                    | SUCTION LINE AND CAP. TUBE ASSY.  | 20B35-088D    |
|      | UCR/WTR119-A                 | SUCTION LINE AND CAP. TUBE ASSY.  | 20B35-098D    |
| *14  | DP41/46/67 UCR/WTR41/46/67-A | CAP. TUBE (.049ID X .099OD X 132) | 203-039A--    |
|      | DP93/119 UCR/WTR93/119-A     | CAP. TUBE (.054ID X .106OD X 120) | 203-124A      |
| *15  | ALL                          | ACCUMULATOR                       | 303-071A      |
| *16  | DP41/DP/UCR/WTR46/67-A       | REFRIGERANT CHARGE                | 0.4219        |
|      | DP93/119/UC/WT93-A           | REFRIGERANT CHARGE                | 0.594         |
|      | UCR/WTR41                    | REFRIGERANT CHARGE                | 0.4219        |
|      | UCR/WTR119-A                 | REFRIGERANT CHARGE                | 0.5938        |
| *17  | ALL                          | WIRING DIAGRAM                    | ILB-1351      |
| *18  | ALL                          | WIRE HARNESS                      | 504-430C      |
| *19  | DP/UCR/WTR41/46/67           | CONDENSATE PAN ASSY.              | 43B35-004C    |
|      | DP/UCR/WTR93/119             | CONDENSATE PAN                    | 43B35-005C    |

# REFRIGERATION ASSEMBLY COMPONENTS (REFRIGERATORS)

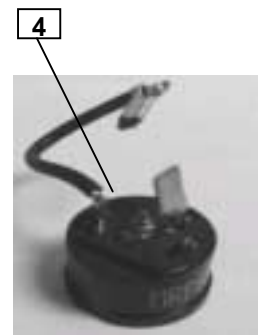
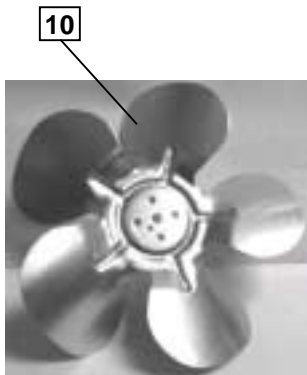
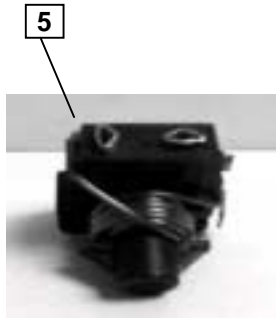
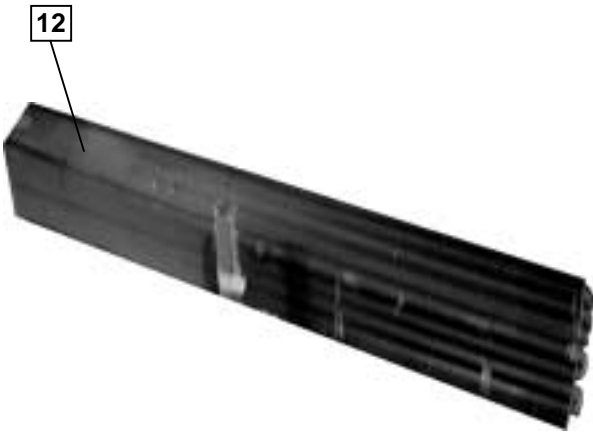
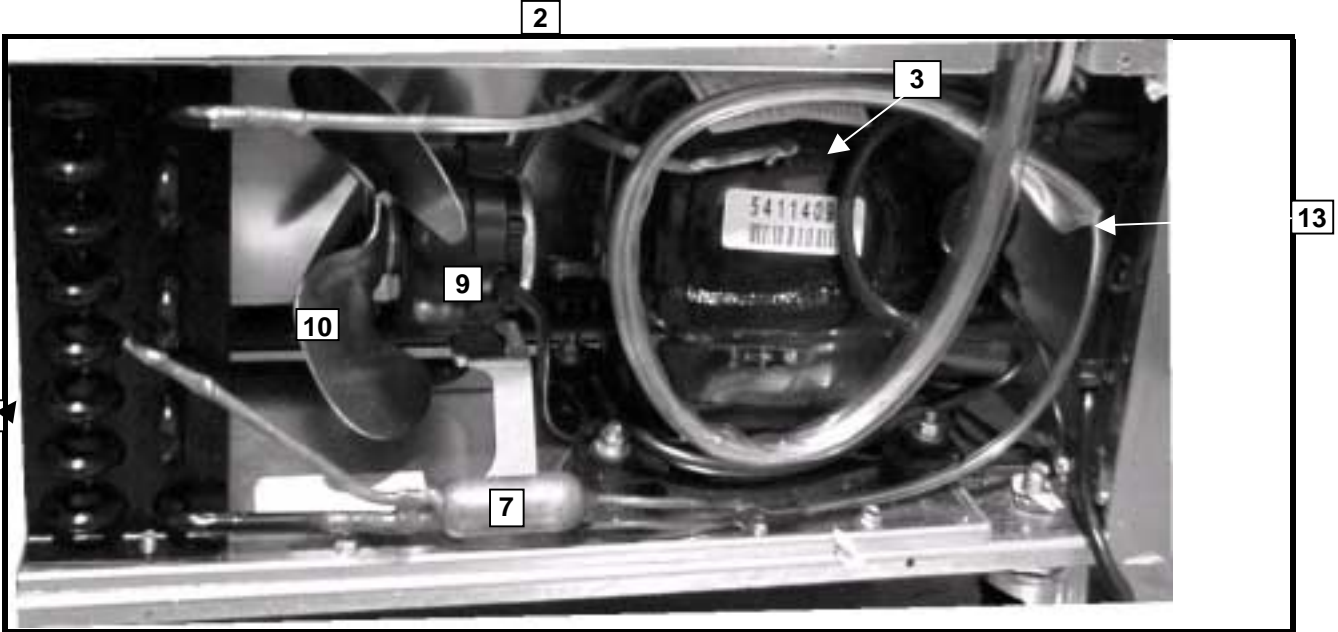



**TOP ASSEMBLES**  
**29" BASE REFRIGERATORS (CONTINUED)**

| ITEM     | MODEL                         | DESCRIPTION                       | PART NUMBER   |
|----------|-------------------------------|-----------------------------------|---------------|
| 3        | SP72-10/10C                   | TOP COVER ASSY.                   | 01B36-085A-03 |
|          | SP72-12                       | TOP COVER ASSY.                   | 01B36-085A-02 |
|          | SP72-12C                      | TOP COVER ASSY.                   | 01B36-084A-01 |
|          | SP72-12M                      | TOP COVER ASSY.                   | 01B36-075A-03 |
|          | SP72-18/18C/18M               | TOP COVER ASSY.                   | 01B36-075A-02 |
|          | SP72-24M                      | TOP COVER ASSY.                   | 01B36-075A-01 |
|          | SP72-30M                      | TOP COVER ASSY.                   | 01B36-076A-01 |
| 4        | SP27/08/16/C/SPD27            | TOP COVER (LID)                   | 01B40-002D-01 |
|          | SP2712M                       | TOP COVER (LID)                   | 01B40-001D-01 |
|          | SP48-08/08C                   | TOP COVER (LID)                   | 01B40-002D-02 |
|          | SP48-10/10C                   | TOP COVER (LID)                   | 01B40-002D-03 |
|          | SP48-12/12C                   | TOP COVER (LID)                   | 01B40-002D-04 |
|          | SP48-12M                      | TOP COVER (LID)                   | 01B40-001D-01 |
|          | SP48-18M                      | TOP COVER (LID)                   | 01B40-001D-02 |
|          | SP60-08                       | TOP COVER (LID)                   | 01B40-002D-02 |
|          | SP60-12                       | TOP COVER (LID)                   | 01B40-002D-04 |
|          | SP60-12M                      | TOP COVER (LID)                   | 01B40-001D-01 |
|          | SP60-16                       | TOP COVER (LID) (LH)              | 01B38-048D    |
|          | SP60-16                       | TOP COVER (LID) (RH)              | 01B38-047D    |
|          | SP60-16 (AFTER #5006876)      | (SINGLE) TOP COVER LID            | 01B36-116D-01 |
|          | SP60-18M                      | TOP COVER (LID)                   | 01B40-001D-03 |
|          | SP60-24M                      | TOP COVER (LID)                   | 01B40-001D-04 |
|          | SP72-08/08C                   | COVER ONLY (LID)                  | 01B40-002D-02 |
|          | SP72-10/10C/12                | COVER ONLY (LID)                  | 01B40-002D-03 |
|          | SP12C/12M/18C/18M             | COVER ONLY (LID)                  | 01B40-002D-04 |
|          | SP72-18                       | COVER ONLY (LID)                  | 01B40-002D-04 |
|          | SP72-18M/18C                  | COVER ONLY (LONG LID)             | 01B40-002D-07 |
|          | SP72-18M/18C                  | COVER ONLY (SHORT LID)            | 01B40-002D-08 |
|          | SP72-24M/30M                  | COVER ONLY (LONG LID)             | 01B40-001D-04 |
|          | SP72-30M                      | COVER ONLY (SHORT LID)            | 01B40-001D-05 |
| All      | LID STUD. (2 PER LID)         | 604-094A                          |               |
| 5        | SP27/27C/27-16                | SERVING BAR (LID HOUSING)         | 01B36-093C-01 |
|          | SP27-12M                      | SERVING BAR (LID HOUSING)         | 01B36-077C-01 |
|          | SP48-08/08C                   | SERVING BAR (LID HOUSING)         | 01B36-098C-01 |
|          | SP48-10/10C                   | SERVING BAR (LID HOUSING)         | 01B36-094C-01 |
|          | SP48-12/12C                   | SERVING BAR (LID HOUSING)         | 01B36-098C-01 |
|          | SP48-12M                      | SERVING BAR (LID HOUSING)         | 01B36-100C-01 |
|          | SP48-18M                      | SERVING BAR (LID HOUSING)         | 01B36-078C-01 |
|          | SP60-08                       | SERVING BAR (LID HOUSING)         | 01B36-098C-01 |
|          | SP60-12                       | SERVING BAR (LID HOUSING)         | 01B36-095C-01 |
|          | SP60-12M                      | SERVING BAR (LID HOUSING)         | 01B36-077C-01 |
|          | SP60-16                       | SERVING BAR (LID HOUSING)         | 01B36-096C-01 |
|          | SP60-16(AFTER SERIAL#5006875) | (SINGLE)SERVING BAR (LID HOUSING) | 01B36-114D-01 |
|          | SP60-18M                      | SERVING BAR (LID HOUSING)         | 01B36-078C-01 |
|          | SP60-24M                      | SERVING BAR (LID HOUSING)         | 01B36-079D-01 |
|          | SP72-08/08C                   | SERVING BAR (LID HOUSING)         | 01B36-098C-01 |
|          | SP72-10/10C                   | SERVING BAR (LID HOUSING)         | 01B36-094C-01 |
|          | SP72-12/12C                   | SERVING BAR (LID HOUSING)         | 01B36-095C-01 |
|          | SP72-18                       | SERVING BAR (LID HOUSING)         | 01B36-077D-01 |
|          | SP72-18M/18C                  | SERVING BAR (LID HOUSING)         | 01B36-097D-01 |
|          | SP72-18C                      | SERVING BAR (LID HOUSING)         | 01B36-078D-01 |
| SP72-24M | SERVING BAR (LID HOUSING)     | 01B36-079D-01                     |               |
| SP72-30M | SERVING BAR (LID HOUSING)     | 01B36-097D-01                     |               |
| 6        | ALL/ SP                       | TOP COVER HANDLE                  | 401-201A      |
|          | ALL/ SP                       | TOP COVER HANDLE SCREW            | 603-340A      |

\* Indicates part not illustrated

1/28/2000

**DOOR ASSEMBLES**  
**29" BASE REFRIGERATORS**

| ITEM | MODEL         | DESCRIPTION                   | PART NUMBER |
|------|---------------|-------------------------------|-------------|
| 7    | SP/UC/WT27/60 | D00R ASSEMBLY COMPLETE        | 02B01-249C  |
|      | SP/UC/WT48/72 | D00R ASSEMBLY COMPLETE        | 02B01-253C  |
| 8    | SP/UC/WT27/60 | DOOR GASKET (23-18X24-1/2)    | 703-963D-02 |
|      | SP/UC/WT48/72 | DOOR GASKET (21-1/16X23-1/8)  | 703-963D-03 |
| 9    | ALL SP/UC/WT  | DOOR HANDLE                   | 401-506C    |
| *10  | ALL SP/UC/WT  | DOOR HANDLE SCREWS            | 603-338A    |
| 11   | ALL SP/UC/WT  | DOOR HINGE (TOP/BOTTOM/LH&RH) | 401-657B    |
| *    | ALL SP/UC/WT  | HINGE COVER                   | 401-244B    |
| *    | ALL SP/UC/WT  | HINGE PIVOT CAM (NYLON)       | 401-242B    |
| *12  | ALL SP/UC/WT  | THERMOMETER                   | 402-233B    |

**EVAPORATOR HOUSINGS**  
**29" BASE REFRIGERATORS**

| ITEM | MODEL                    | DESCRIPTION         | PART NUMBER   |
|------|--------------------------|---------------------|---------------|
| 13   | SP27/48 & UCR/WTR27A/48A | EVAP. HOUSING ASSY. | 04B01-076D-02 |
|      | SP60/72 & UCR/WTR60/72A  | EVAP. HOUSING ASSY, | 04B01-077D-02 |
| 14   | SP27/48 & UCR/WTR27A/48A | EVAP. COVER ASSY.   | 04B02-175D-02 |
|      | SP60/72 & UCR/WTR60/72A  | EVAP. COVER ASSY.   | 04B02-177D-02 |
| 15   | SP27/48 & UCR/WTR27A/48A | EVAP. BLADE         | 405-063A      |
| 16   | SP60/72 & UCR/WTR60/72A  | EVAP. MOTOR         | 501-105B      |
| *17  | SP27/48 & UCR/WTR27A/48A | EVAP. MOTOR BRACKET | 42A37-011B    |
| 18   | ALL SP/UC/WT             | TEMP. CONT          | 502-290B      |

Evaporator pans below will be used for units produced before serial number **#5100522**. Units produced after this serial number have the evaporator pans incorporated into the cabinet and are not replaceable.

|    |          |                       |               |
|----|----------|-----------------------|---------------|
| 19 | ALL SP27 | EVAP. DRAIN PAN ASSY. | 04B02-164C-01 |
|    | ALL SP48 | EVAP. DRAIN PAN ASSY. | 04B02-164C-02 |
|    | ALLSP60  | EVAP. DRAIN PAN ASSY. | 04B02-164C-03 |
|    | ALL SP72 | EVAP. DRAIN PAN ASSY. | 04B02-064C-04 |
|    | ALL SP48 | EVAP. DRAIN PAN ASSY. | 04B02-164C-02 |
|    | ALLSP60  | EVAP. DRAIN PAN ASSY. | 04B02-164C-03 |
|    | ALL SP72 | EVAP. DRAIN PAN ASSY. | 04B02-064C-04 |

**SHELVES, CUTTING BOARDS & GRILLS**  
**29" BASE REFRIGERATORS**

| ITEM | MODEL                               | DESCRIPTION              | PART NUMBER |
|------|-------------------------------------|--------------------------|-------------|
| 20   | ALL SP                              | SHELF SUPPORT            | 403-169A    |
| 21   | SP/27 & UCR/WTR27A                  | SHELF                    | 403-628D    |
|      | SP48 & UCR/WTR48A                   | SHELF                    | 403-630D    |
|      | SP60 & UCR/WTR60A                   | SHELF                    | 403-631D    |
|      | SP72 & UCR/WTR72A                   | SHELF (CTR)              | 403-629D    |
|      | SP72 & UCR/WTR72A                   | SHELF. (END)             | 403-630D    |
| 22   | SP/UCR/WTR                          | PILASTER (15")           | 403-154A    |
| *23  | SP/UCR/WTR                          | PILASTER SCREWS          | 603-415A    |
| 24   | ALL SP27                            | CUTTING BOARD (10" WIDE) | 705-290C-01 |
|      | SP48-08/08C/10/10C/12               | CUTTING BOARD (10" WIDE) | 705-290C-02 |
|      | SP48-12C/12M/18M                    | CUTTING BOARD (17" WIDE) | 705-265C    |
|      | ALL SP60                            | CUTTING BOARD (10" WIDE) | 705-290C-03 |
|      | SP72-08/08C/10/12/12M/18/18M/24/30M | CUTTING BOARD (10" WIDE) | 705-290C-04 |
|      | SP72-18C                            | CUTTING BOARD (17" WIDE) | 705-267C    |
| 25   | SP27                                | CUTTING BOARD RETAINER   | 107-430C-01 |
|      | SP48                                | CUTTING BOARD RETAINER   | 107-430C-02 |
|      | SP60                                | CUTTING BOARD RETAINER   | 107-430C-03 |
|      | SP72                                | CUTTING BOARD RETAINER   | 107-430C-04 |

**SHELVES, CUTTING BOARDS & GRILLS**  
**29" BASE REFRIGERATORS (CONTINUED)**

| ITEM | MODEL             | DESCRIPTION         | PART NUMBER   |
|------|-------------------|---------------------|---------------|
| 26   | SP27 & UCR/WTR27A | GRILL ASSY. (FRONT) | 07B31-061B    |
|      | SP48 & UCR/WTR48A | GRILL ASSY. (FRONT) | 07B31-057B    |
|      | SP60 & UCR/WTR60A | GRILL ASSY. (FRONT) | 07B31-059B    |
|      | SP72 & UCR/WTR72A | GRILL ASSY. (FRONT) | 07B31-055B    |
| 27   | SP27 & UCR/WTR27A | GRILL ASSY. (REAR)  | 28D37-090D-03 |
|      | SP48 & UCR/WTR48A | GRILL ASSY. (REAR)  | 28D37-091D-03 |
|      | SP60 & UCR/WTR60A | GRILL ASSY. (REAR)  | 28D37-092D-03 |
|      | SP72 & UCR/WTR72A | GRILL ASSY. (REAR)  | 28D37-093D-03 |
| 28   | ALL SP            | CASTER KIT          | 00C31-038A    |

**PAN SUPPORTS**  
**29" BASE REFRIGERATORS**

| ITEM | UNIT                        | DESCRIPTION           | PART NUMBER   |
|------|-----------------------------|-----------------------|---------------|
| 29   | SP27/27C/SPD27/SP72-12M     | PAN SUPPORTS 3 NEEDED | 28D40-056C-05 |
|      | SP27-16                     | PAN SUPPORTS 5 NEEDED | 28D40-056C-05 |
|      | SP27-12M/SP60-12M           | PAN SUPPORTS 3 NEEDED | 28D40-051C-05 |
|      | SP48-18M/SP60-12M/SP72-18M  | PAN SUPPORTS 5 NEEDED | 28D40-051C-05 |
|      | SP60-24M/SP72-24M           | PAN SUPPORTS 6 NEEDED | 28D40-051C-05 |
|      | SP72-30M                    | PAN SUPPORTS 8 NEEDED | 28D40-051C-05 |
|      | SP48-12/SP60-12/SP72-12/12C | PAN SUPPORTS 5 NEEDED | 28D40-060C-05 |
|      | SP60-10/SP72-10/10C         | PAN SUPPORTS 3 NEEDED | 28D40-060C-05 |
|      | SP48-10/SP72-10/10C         | PAN SUPPORTS 4 NEEDED | 28D40-060C-05 |
|      | SP60-16/SP72-18/18C         | PAN SUPPORTS 7 NEEDED | 28D40-060C-05 |

**PANS**  
**29" BASE REFRIGERATORS**

| ITEM | UNIT                         | DESCRIPTION                  | PART NUMBER               |
|------|------------------------------|------------------------------|---------------------------|
| 30   | SP27 & 27C                   | PANS 1/6 4" DEEP (6 NEEDED)  | 403-490C                  |
|      |                              | PANS 1/9 4" DEEP (2 NEEDED)  | 403-493C                  |
|      | SP48-08C & SP60-08C          | PANS 1/6 4" DEEP (8 NEEDED)  | 403-490C                  |
|      |                              | PANS 1/6 4" DEEP (10 NEEDED) | 403-490C                  |
|      | SP48-18M                     | PANS 1/6" DEEP(6 NEEDED)     | 403-490C                  |
|      |                              | PANS 1/2" DEEP (2 NEEDED)    | 403-495C                  |
|      | SP60-12C                     | PANS 1/6" DEEP (12 NEEDED)   | 403-490C                  |
|      |                              | SP60-18M                     | PANS 1/6" DEEP (6 NEEDED) |
|      | PANS 1/2" DEEP (2 NEEDED)    |                              | 403-495C                  |
|      | PANS FULL 4" DEEP (1 NEEDED) |                              | 403-497C                  |
|      | SP60-24M                     | PANS 1/4" DEEP (4 NEEDED)    | 403-490C                  |
|      |                              | PANS 1/2" DEEP (2 NEEDED)    | 403-495C                  |
|      | SP72-12M                     | PANS 1/6 4" DEEP (6 NEEDED)  | 403-490C                  |
|      |                              | PANS 1/2" DEEP (2 NEEDED)    | 403-495C                  |
|      | SP72-18M                     | PANS 1/6 4" DEEP (6 NEEDED)  | 403-490C                  |
|      |                              | PANS 1/2" DEEP (2 NEEDED)    | 403-495C                  |
|      |                              | PANS FULL 4" DEEP (1 NEEDED) | 403-497C                  |
|      | SP72-24M                     | PANS 1/6 4" DEEP (12 NEEDED) | 403-490C                  |
|      |                              | PANS 1/2" DEEP (2 NEEDED)    | 403-495C                  |
|      |                              | PANS FULL 4" DEEP (1 NEEDED) | 403-497C                  |
|      | SP72-30M                     | PANS 1/4" DEEP (18 NEEDED)   | 403-490C                  |
|      |                              | PANS 1/2" DEEP (2 NEEDED)    | 403-495C                  |
|      |                              | PANS FULL 4" DEEP (1 NEEDED) | 403-497C                  |

## REFRIGERATION 29" BASE REFRIGERATORS

| ITEM | UNIT  | DESCRIPTION  | PART NUMBER                  |
|------|---|--|------------------------------|
| 1    | SP27/UCR27A/WTR27A                            | REFRIGERATION ASSEMBLY                             | 19B36-086D-01                |
|      | SP48/UCR48A/WTR48A                            | REFRIGERATION ASSEMBLY                             | 19B36-087D-01                |
|      | SP60/UCR60A/WTR60A<br>SP72/UCR72A/WTR72A      | REFRIGERATION ASSEMBLY                             | 19B36-088D-01                |
| 2    | SP27/UCR27A/WTR27A                            | CONDENSING UNIT                                    | 15B33-045C                   |
|      | SP48/UCR48A/WTR48A                            | CONDENSING UNIT                                    | 15B33-043C                   |
|      | SP60/UCR60A/WTR60A<br>SP72/UCR72A/WTR72A      | CONDENSING UNIT                                    | 15B33-051C                   |
| 3    | SP27/UCR27A/WTR27A                            | 1/6 HP ( AZA0370YXA)                               | 302-687B                     |
|      | SP48/UCR48A/WTR48A                            | 1/5 HP ( AZA0395YXA)                               | 302-687B                     |
|      | SP60/UCR60A/WTR60A<br>SP72/UCR72A/WTR72A      | 1/4 HP (AEA3430YXA)                                | 302-803B                     |
| 4    | SP27/UCR27A/WTR27A                            | COMP.OVERLOAD (TI) MRP57ALK-69                     | 302-688A                     |
|      | SP48/UCR48A/WTR48A                            | COMP. OVERLOAD (TI) MRP40AJN-69                    | 302-918A                     |
|      | SP60/UCR60A/WTR60A<br>SP72/UCR72A/WTR72A      | COMP. OVERLOAD (TI) MRP26ALL-69                    | 302-815A                     |
| 5    | SP27/UCR27A/WTR27A                            | COMP. RELAY (TI) 9660-042-152                      | 302-702A                     |
|      | SP48/UCR48A/WTR48A                            | COMP. RELAY (TI) 9660-071-161                      | 302-677A                     |
|      | SP60/UCR60A/WTR60A<br>SP72/UCR72A/WTR72A      | COMP. RELAY (TI) 9660-042-176                      | 302-646A                     |
| 6    | SP27/UCR27A/WTR27A                            | COMP. START CAPACITOR                              | NA                           |
|      | SP48/UCR48A/WTR48A                            | COMP. START CAPACITOR.(161-193MFD)                 | 302-919A                     |
|      | SP60/UCR60A/WTR60A<br>SP72/UCR72A/WTR72A      | COMP. START CAPACITOR                              | NA                           |
| 7    | ALL SP/UC/WT                                  | DRYER  | 303-126A                     |
| 8    | SP27/48 & UCR/WTR27A/48A                      | COND. COIL ( 5-5/16X7-7/8X3)                       | 305-144C                     |
|      | SP60/72 & UCR/WTR60A/72A                      | COND. COIL (5-5/16x7-7/8x4)                        | 305-155C                     |
| 9    | ALL SP/UC/WT                                  | COND. FAN MOTOR (5WATT) 115/60                     | 501-019B                     |
| 10   | ALL SP/UC/WT                                  | COND. FAN BLADE (6.75" )                           | 405-015A--                   |
| 11   | SP27/UCR27A/WTR27A                            | EVAP. COIL ASSY.                                   | 19B31-021D                   |
|      | SP48/UCR48A/WTR48A                            | EVAP. COIL ASSY                                    | 19B31-022D                   |
|      | SP60/UCR60A/WTR60A<br>SP72/UCR72A/WTR72A      | EVAP. COIL ASSY.                                   | 19B31-023D                   |
| 12   | SP27/UCR27A/WTR27A                            | EVAP. COIL ONLY (20X4X3)                           | 305-175C                     |
|      | SP48/UCR48A/WTR48A                            | EVAP. COIL ONLY (20X4X4)                           | 305-176C                     |
|      | SP60/UCR60A/WTR60A<br>SP72/UCR72A/WTR72A      | EVAP. COIL ONLY 30X4X4                             | 305-154C                     |
| 13   | SP27/48 & UCR/WTR27A                          | SUCTION LINE AND CAP. TUBE ASSY.                   | 19B30-044D                   |
|      | SP60/72 & UCR/WTR60/72A                       | SUCTION LINE AND CAP. TUBE ASSY.                   | 19B30-045D                   |
| 14   | SP27/48 & UCR/WTR27A                          | CAP. TUBE (.036IDX.087ODX120")                     | 203-048A--                   |
|      | SP60/72 & UCR/WTR60/72A                       | CAP. TUBE (.036IDX.087ODX84)                       | 203-126A                     |
| 15   | ALL SP/UC/WT                                  | ACCUMULATOR  | 303-071A                     |
| 16   | SP27/UCR27A/WTR27A                            | REFRIGERANT 0.4375 LBS                             | R134A                        |
|      | SP48/UCR48A/WTR48A                            | REFRIGERANT 0.453 LBS                              | R134A                        |
|      | SP60/UCR60A/WTR60A<br>SP72/UCR72A/WTR72A      | REFRIGERANT 0.4375 LBS                             | R134A                        |
| 17   | ALL SP  | WIRING DIAGRAM                                     | IL-1792B                     |
| 18   | SP27/48                                       | WIRE HARNESS                                       | 504-762C                     |
|      | UCR/WTR27/48A                                 | WIRE HARNESS                                       | 504-430C                     |
|      | SP60/72                                       | WIRE HARNESS                                       | 504-764C                     |
|      | UCR/WTR 60/72A                                | WIRE HARNESS                                       | 504-298C                     |
| 19   | ALL SP  | CONDENSATE PAN ASSY.                               | 08B30-041D-01                |
|      | ALL UCR/WTR                                   | CONDENSATE PAN                                     | 706-047C                     |
|      | SP72(BEFORE #5308510)<br>SP72(AFTER #5308510) | CONDENSATE PAN W/O HEATER<br>CONDENSATE PAN HEATER | 28D24-040C-04<br>504-763B-01 |

\* Indicates part not illustrated

1/28/2000

REFRIGERATION ASSEMBLY COMPONENTS  
(REFRIGERATORS)

