



# CRESCENDO



## INSTALLATION & OPERATING GUIDE

### BUNN-O-MATIC CORPORATION

POST OFFICE BOX 3227

SPRINGFIELD, ILLINOIS 62708-3227

PHONE: (217) 529-6601 FAX: (217) 529-6644

To ensure you have the latest revision of the Operating Manual, or to view the Illustrated Parts Catalog, Programming Manual, or Service Manual, please visit the Bunn-O-Matic website, at [www.bunn.com](http://www.bunn.com). This is absolutely FREE, and the quickest way to obtain the latest catalog and manual updates. For Technical Service, contact Bunn-O-Matic Corporation at 1-800-286-6070.



## BUNN-O-MATIC COMMERCIAL PRODUCT WARRANTY

Bunn-O-Matic Corp. ("BUNN") warrants the BUNN Crescendo as further described below for a warranty period of 1 year parts and labor.

These warranty periods run from the date of installation. BUNN warrants that the equipment manufactured by it will be commercially free of defects in material and workmanship existing at the time of manufacture and appearing within the applicable warranty period. This warranty does not apply to any equipment, component or part that was not manufactured by BUNN or that, in BUNN's judgment, has been affected by misuse, neglect, alteration, improper installation or operation, improper maintenance or repair, non periodic cleaning and descaling, equipment failures related to poor water quality, damage or casualty. This warranty is conditioned on the Buyer 1) giving BUNN prompt notice of any claim to be made under this warranty by telephone at (217) 529-6601 or by writing to Post Office Box 3227, Springfield, Illinois 62708-3227; 2) if requested by BUNN, shipping the defective equipment prepaid to an authorized BUNN service location; and 3) receiving prior authorization from BUNN that the defective equipment is under warranty. Additionally, the following is excluded from the warranty period:

Warranty Exclusions:

- Parts such as, but not limited to, hoppers and lids, drip trays, and plastic parts damaged due to improper handling or cleaning agents.
- Replacement of wear items such as, but not limited to, O-rings, gaskets, silicone tubes, hoses, and valve seats.
- Repairs made necessary due to poor water quality such as dispense valves, water inlet valves, scaling in the steam or hot water boilers. (Total Hardness recommended range of 4-7 gpg constant).
- Improper voltage. (See equipment operations manual for voltage specifications).
- Failure to use BUNN approved cleaning supplies constitutes improper maintenance.
- Failure to have required preventive maintenance performed by BUNN technician or authorized espresso service provider.
- Parts replaced under the terms of this warranty carry the remainder on the machine's parts warranty term, or 60 days, whichever is greater.

**THE FOREGOING WARRANTY IS EXCLUSIVE AND IS IN LIEU OF ANY OTHER WARRANTY, WRITTEN OR ORAL, EXPRESS OR IMPLIED, INCLUDING, BUT NOT LIMITED TO, ANY IMPLIED WARRANTY OF EITHER MERCHANTABILITY OR FITNESS FOR A PARTICULAR PURPOSE.** The agents, dealers or employees of BUNN are not authorized to make modifications to this warranty or to make additional warranties that are binding on BUNN. Accordingly, statements by such individuals, whether oral or written, do not constitute warranties and should not be relied upon. If BUNN determines in its sole discretion that the equipment does not conform to the warranty, BUNN, at its exclusive option while the equipment is under warranty, shall either 1) provide at no charge replacement parts and/or labor (during the applicable parts and labor warranty periods specified above) to repair the defective components, provided that this repair is done by a BUNN Authorized Service Representative; or 2) shall replace the equipment or refund the purchase price for the equipment.

**THE BUYER'S REMEDY AGAINST BUNN FOR THE BREACH OF ANY OBLIGATION ARISING OUT OF THE SALE OF THIS EQUIPMENT, WHETHER DERIVED FROM WARRANTY OR OTHERWISE, SHALL BE LIMITED, AT BUNN'S SOLE OPTION AS SPECIFIED HEREIN, TO REPAIR, REPLACEMENT OR REFUND.** In no event shall BUNN be liable for any other damage or loss, including, but not limited to, lost profits, lost sales, loss of use of equipment, claims of Buyer's customers, cost of capital, cost of down time, cost of substitute equipment, facilities or services, or any other special, incidental or consequential damages.

392, A Partner You Can Count On, Air Infusion, AutoPOD, AXIOM, BrewLOGIC, BrewMETER, Brew Better Not Bitter, BrewWISE, BrewWIZARD, BUNN Espresso, BUNN Family Gourmet, BUNN Gourmet, BUNN Pour-O-Matic, BUNN, BUNN with the stylized red line, BUNNlink, Bunn-O-Matic, Bunn-O-Matic, BUNNserve, BUNNSERVE with the stylized wrench design, Cool Froth, DBC, Dr. Brew stylized Dr. design, Dual, Easy Pour, EasyClear, EasyGard, FlavorGard, Gourmet Ice, Gourmet Juice, High Intensity, iMIX, Infusion Series, Intellisteam, My Café, Phase Brew, PowerLogic, Quality Beverage Equipment Worldwide, Respect Earth, Respect Earth with the stylized leaf and coffee cherry design, Safety-Fresh, vemycoffee.com, Scale-Pro, Silver Series, Single, Smart Funnel, Smart Hopper, SmartWAVE, Soft Heat, SplashGard, The Mark of Quality in Beverage Equipment Worldwide, ThermoFresh, Titan, trifacta, TRIFECTA (stylized logo), Velocity Brew, Air Brew, Beverage Bar Creator, Beverage Profit Calculator, Brew better, not bitter., Build-A-Drink, BUNNSource, Coffee At Its Best, Cyclonic Heating System, Daypart, Digital Brewer Control, Element, Milk Texturing Fusion, Nothing Brews Like a BUNN, Picture Prompted Cleaning, Pouring Profits, Signature Series, Sure Tamp, Tea At Its Best, The Horizontal Red Line, Ultra are either trademarks or registered trademarks of Bunn-O-Matic Corporation. The commercial trifacta® brewer housing configuration is a trademark of Bunn-O-Matic Corporation.

## USER NOTICES

The notices on this dispenser should be kept in good condition. Replace unreadable or damaged labels.



00986.0000



12368.0002

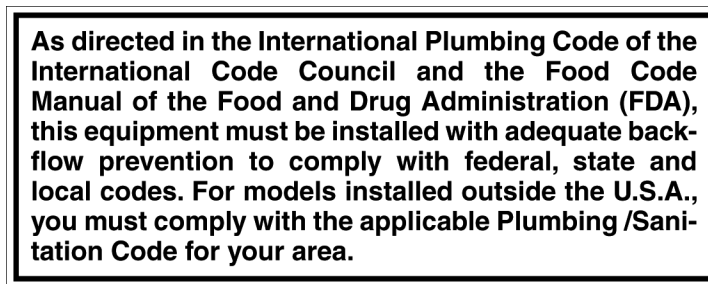

00656.0001

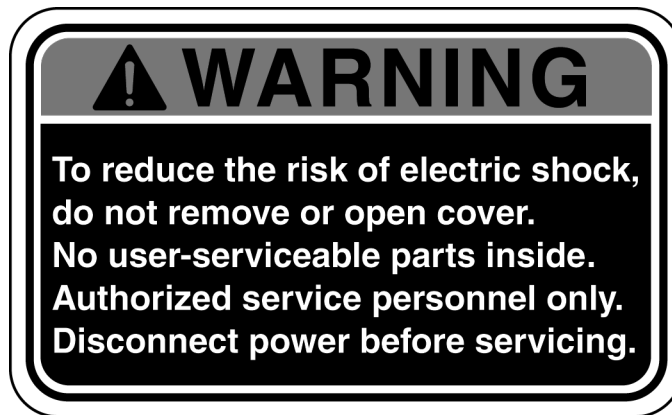

37881.0000



00824.0002

## **CE REQUIREMENTS**

- This appliance must be installed in locations where it can be overseen by trained personnel.
- For proper operation, this appliance must be installed where the temperature is between 5°C to 35°C.
- Appliance shall not be tilted more than 10° for safe operation.
- An electrician must provide electrical service as specified in conformance with all local and national codes.
- This appliance must not be cleaned by water jet.
- This appliance can be used by persons aged from 18 years and above if they have been given supervision or instruction concerning use of the appliance in a safe way and if they understand the hazards involved.
- Keep the appliance and its cord out of reach of children aged less than 18 years.
- Appliances can be used by persons 18 years and above with reduced physical, sensory or mental capabilities or lack of experience and knowledge if they have been given supervision or instruction concerning use of the appliance in a safe way and understand the hazards involved.
- Children under the age of 18 years should be supervised to ensure they do not play with the appliance.
- If the power cord is ever damaged, it must be replaced by the manufacturer or authorized service personnel with a special cord available from the manufacturer or its authorized service personnel in order to avoid a hazard.
- Machine must not be immersed for cleaning.
- Cleaning and user maintenance shall not be made by children unless they are older than 18 years and supervised.
- This appliance is intended to be used in household and similar applications such as:
  - staff kitchen areas in shops, offices and other working environments;
  - by clients in hotels, motels and other residential type environments;
  - bed and breakfast type environments.
- This appliance not intended to be used in applications such as:
  - farm houses;
- Access to the service areas permitted by Authorized Service personnel only.
- The A-Weighted sound pressure level is below 70 dBA.

## **NORTH AMERICAN REQUIREMENTS**

- This appliance must be installed in locations where it can be overseen by trained personnel.
- For proper operation, this appliance must be installed where the temperature is between 41°F to 95°F (5°C to 35°C).
- Appliance shall not be tilted more than 10° for safe operation.
- An electrician must provide electrical service as specified in conformance with all local and national codes.
- This appliance must not be cleaned by pressure washer.
- This appliance can be used by persons aged from 18 years and above if they have been given supervision or instruction concerning use of the appliance in a safe way and if they understand the hazards involved.
- Keep the appliance and its cord out of reach of children aged less than 18 years.
- Appliances can be used by persons 18 years and above with reduced physical, sensory or mental capabilities or lack of experience and knowledge if they have been given supervision or instruction concerning use of the appliance in a safe way and understand the hazards involved.
- Children under the age of 18 years should be supervised to ensure they do not play with the appliance.
- If the power cord is ever damaged, it must be replaced by the manufacturer or authorized service personnel with a special cord available from the manufacturer or its authorized service personnel in order to avoid a hazard.
- Machine must not be immersed for cleaning.
- Cleaning and user maintenance shall not be made by children unless they are older than 18 years and supervised.
- This appliance is intended for commercial use in applications such as:
  - staff kitchen areas in shops, offices and other working environments;
  - by clients in hotel and motel lobbies and other similar types of environments;
- Access to the service areas permitted by Authorized Service personnel only.

## INITIAL SET-UP

1. Remove drip tray and cover from the parts box. Assemble the cover to the drip tray, then slide under the front door of the machine, engaging the rear of the drip tray into the opening in the lower front of the machine..
2. Remove the espresso brew group from the parts box.
3. Slide tube onto elbow fitting on upper left side of espresso group head as shown in Figure 1.



Figure 1

P4375

4. Place groove on lower front of group head over mounting bar on espresso drive as shown in Figure 2.

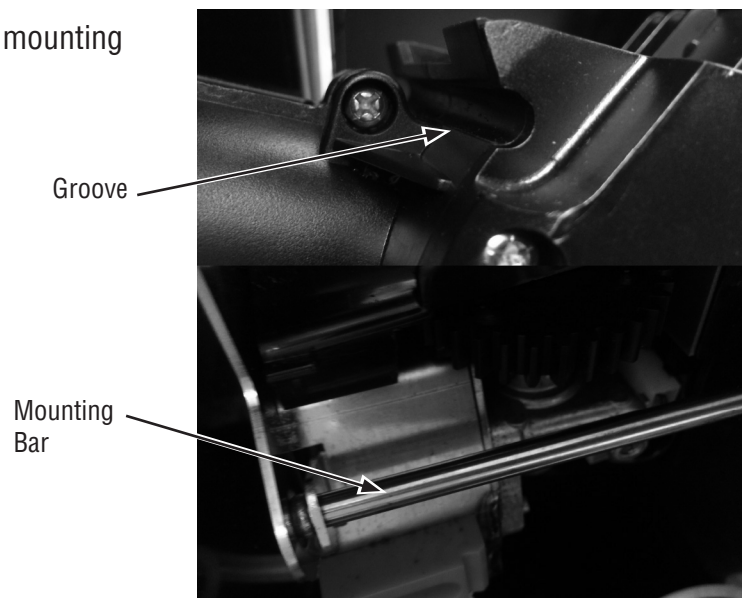

Figure 2

P4376

## INITIAL SET-UP - continued

6. Rotate the top of group head toward rear of machine until it snaps into place as shown in Figure 3.

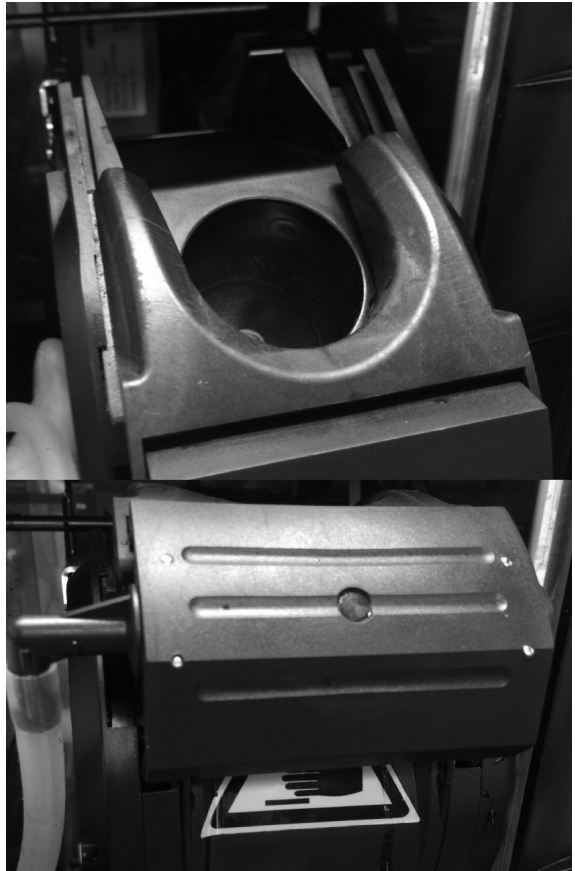

Figure 3

P4377

7. Slide red lock to the right until it snaps into place as shown in Figure 4.

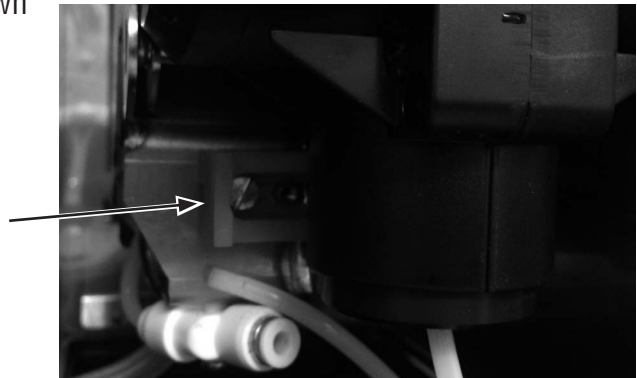

Figure 4

P4378

8. Install group head tube into quick connect fitting on bottom of espresso drive, insuring that the tube is fully inserted as shown in Figure 5.

Brew Tube  
Connection

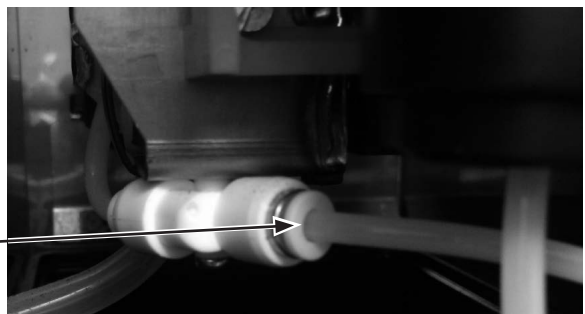

Figure 5

P4379

## INITIAL SET-UP - continued

9. Remove the bean hopper from the parts box. Align the bean hopper so that the collar on the bottom of the bean hopper will engage the opening in the grinder as shown in Figure 6.

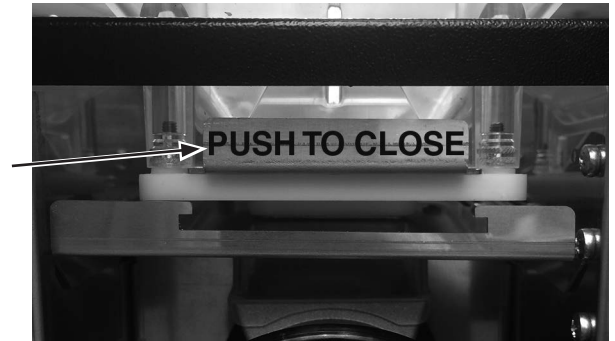

Figure 6

10. When the hopper is in place on the grinder, pull the hopper gate all the way forward to allow beans into the grinder, then lock hopper in place as shown in Figure 7.

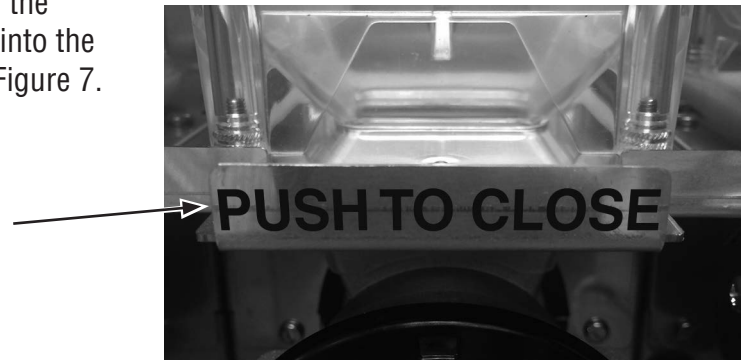

Figure 7

## CAPACITY

1. Brew chamber has a capacity rating of 5 gm minimum up to 15 gm maximum of espresso grind coffee.
2. Brewer has a peak capacity of 60 single (small) espresso shots per hour.

## ELECTRICAL REQUIREMENTS

**CAUTION** - The dispenser must be disconnected from the power source until specified in Electrical Hook-Up.

### Electrical Hook-Up

**CAUTION** - Improper electrical installation will damage electronic components.

1. An electrician must provide electrical service as specified.
2. Using a voltmeter, check the voltage and color coding of each conductor at the electrical source.
3. Connect the dispenser to the power source.
4. If plumbing is to be hooked up later be sure the dispenser is disconnected from the power source. If plumbing has been hooked up, the dispenser is ready for Initial Fill & Heat.



**120V  
Models**



**220-240 VOLT Models**

### 120 & 220-240 volt ac models

**Note:** This electrical service consists of 2 current carrying conductors (L1 and Neutral) and a separate conductor for chassis ground.

## PLUMBING REQUIREMENTS

This dispenser must be connected to a **cold water** system with operating pressure between 138 - .620 MPa (20 and 90 psi) from a 1/2" or larger supply line. A shut-off valve should be installed in the line before the dispenser. Install a regulator in the line when pressure is greater than .620 MPa (90 psi) to reduce it to .345 MPa (50 psi). The water inlet fitting is 3/4 British Parallel Pipe.

**NOTE** - Bunn-O-Matic recommends 6mm copper tubing for installations of less than 25 feet and 8mm for more than 25 feet from the water supply line. At least 18 inches of an FDA approved flexible beverage tubing, such as reinforced braided polyethylene or silicone, before the dispenser will facilitate movement to clean the counter top. Bunn-O-Matic does not recommend the use of a saddle valve to install the dispenser. The size and shape of the hole made in the supply line by this type of device may restrict water flow.

As directed in the International Plumbing Code of the International Code Council and the Food Code Manual of the Food and Drug Administration (FDA), this equipment must be installed with adequate backflow prevention to comply with federal, state and local codes. For models installed outside the U.S.A., you must comply with the applicable Plumbing /Sanitation Code for your area.

**NOTE** - If a backflow preventer is required by code, a shock arrestor should be installed between backflow preventer and dispenser. Installing the shock arrestor as close to the dispenser as possible will provide the best results.

**NOTE** - Water pipe connections and fixtures directly connected to a potable water supply shall be sized, installed and maintained in accordance with federal, state and local codes.

## PLUMBING HOOK-UP

**NOTE:** The plumbing connection is located on the back of the unit, using the water line included with some models, that connects to a 3/8" male flare.

1. Flush the water line and securely attach it to the valve threads on the rear of the dispenser.
2. Turn on the water supply.

## INITIAL FILL & HEAT

1. Turn on the water supply, connect power to the dispenser, and place the main power switch on the rear of the machine to the ON position.
2. Water will automatically flow into the soluble tank to the proper level, then shut off. This will take less than five minutes.
3. The screen on the front door will display FILL ESPRSO TANK. Press the button under START.
4. The screen will display MOVING BREW CHAMBER, ESP TANK FILLING, and the espresso tank will begin filling. This may take several minutes.
5. When water dispenses from the espresso nozzle into the drip tray, press YES under WATER DISPENSED? to stop the tank filling.
6. The tanks will then begin heating. When the tanks have completed heating, the display will read "READY TO BREW SELECT SIZE".

## PRESET TANK TEMPERATURE

The tank temperatures have been preset at the factory to 80°C (180°F) for the soluble tank, and 102°C (215°F) for the espresso tank. Bunn recommends that to provide the best quality beverage, the installer adjust the tank temperature to the powder product manufacturers recommended temperature for the hot powder product being used.

7. Fill the hopper(s) with the dry product to be dispensed.
8. Fill the bean hopper with the whole beans to be ground and brewed.

## LIQUID LEVEL CONTROL

The system automatically maintains the soluble hot water tank's level by energizing the refill solenoid when the water level drops below the liquid level probe. If the system has not successfully refilled, a refill error occurs. When a refill error occurs, the refill solenoid is de-energized. Once the cause of the refill error has been investigated and cured, the system can be reset by either cycling the power to the machine (at least five seconds) using the main power switch at the rear of the machine, or by entering one of the program modes (see Programming Modes.)



## Filling Soluble Hoppers

1. Remove packing material from on top of the powder hoppers.
2. Remove powder hoppers by lifting the front of the powder hopper until the peg on the bottom of the hopper clears the hole in the mounting plate (see Figure 1). Then pull the hopper forward to remove.

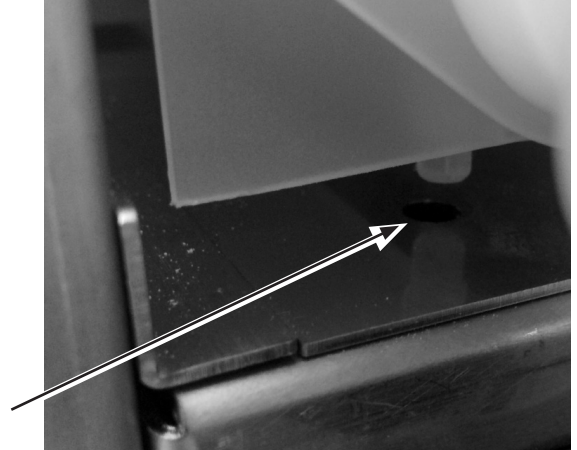

Figure 1

3. Set the hoppers on the counter, and push the slide gates on the front of the discharge chutes inward (see Figure 2) to close the gates.

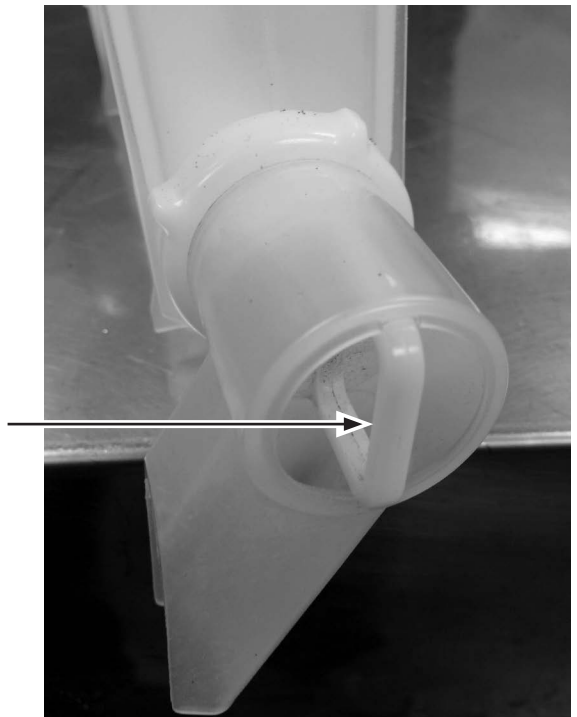

Figure 2

4. Remove hopper lids and fill the hoppers with appropriate soluble products. Default menu is milk product left hopper, chocolate is center hopper, and vanilla is right hopper. Replace hopper lids.
5. Reinstall hoppers back into machine, make sure peg on bottom of hopper drops into locating hole on hopper platform.
6. After hoppers are installed, discharge chutes must be rotated as shown in Figure 3.



Figure 3

## OPERATING CONTROLS AND INTERFACE

1. Cup Size Buttons: Momentarily pushed to select beverage size to dispense.
2. Dispense Buttons: Momentarily pushed to dispense selected beverage
3. LED indicators: Illuminates when the adjoining button has been selected.
4. Stop button: Pressing the stop button during dispensing will stop the dispense sequence.

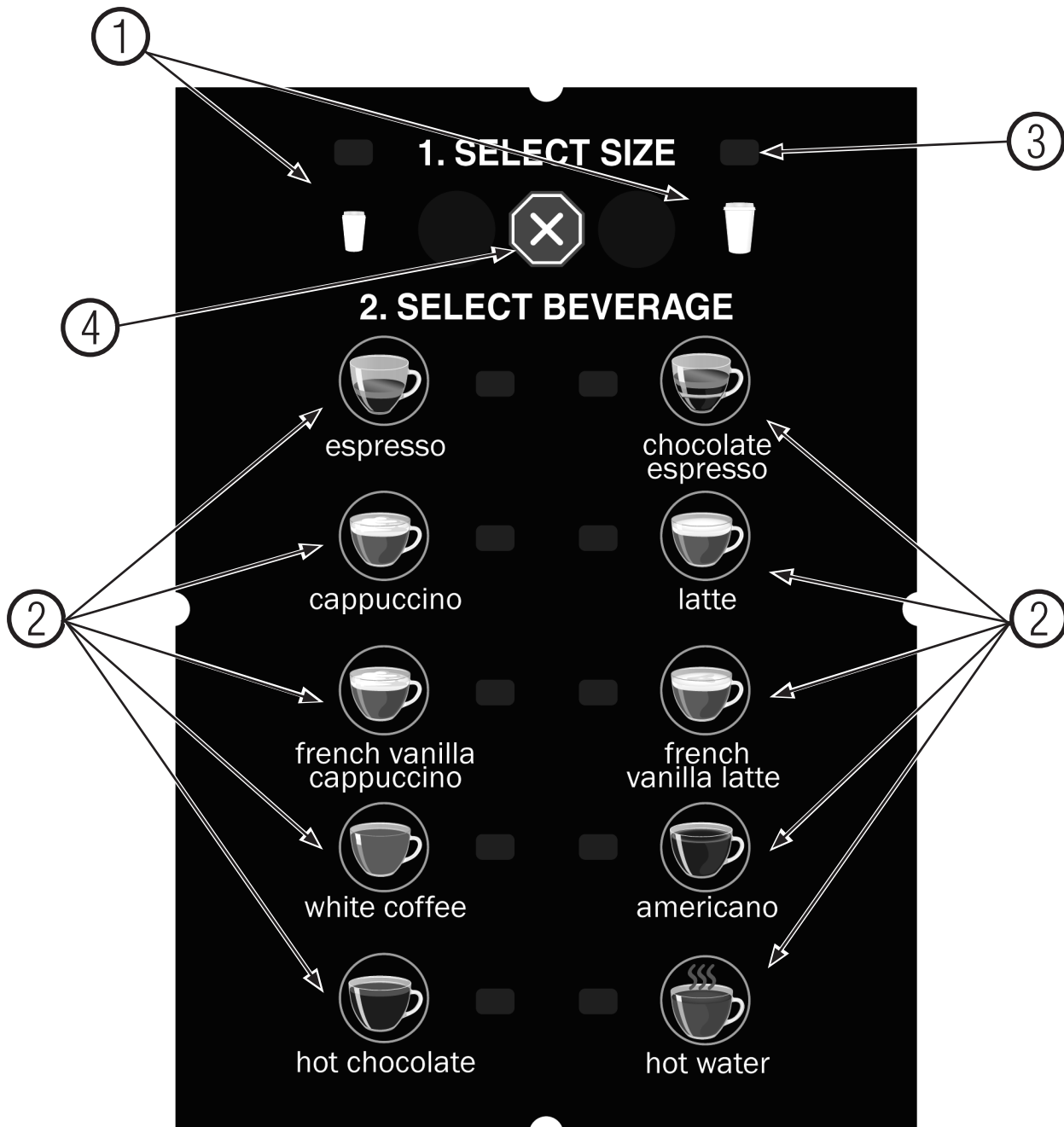

## OPERATING THE DISPENSER

**The NORMAL/PROGRAM/RINSE switch must be in the NORMAL position**

1. Place a cup on the drip tray beneath the dispense nozzle.
2. In the area marked "1" of the control panel:
  - a. Select desired beverage size, small or large cup. This selection is mandatory for dispensing.
3. In the area marked "2" of the control panel:
  - a. Press the button to dispense the desired beverage. Dispensing is portion controlled, and will automatically stop when the correct amount of beverage has been dispensed.

## MODIFYING THE TOUCH SWITCH FUNCTIONS

The function of the touch switch can be modified in four different ways:

1. Set for single cup size dispensing.
2. Move any default beverage from one switch location to another.
3. Disable a dispense switch.
4. Create a “custom” beverage in any switch location.

### SINGLE CUP SIZE DISPENSING

In this mode, a selection can be made to dispense one cup size beverage only. When the SINGLE cup size beverage mode is selected, the large and small cup size buttons are disabled. To dispense a beverage, press only the dispense button of the beverage desired. It is recommended that the touch switch graphic insert be replaced with a new graphic that does not show the large and small cup button in this mode. Reference PROGRAMMING SWITCHES diagram on page 30, and on the flow chart on page 33.

1. In the PROGRAM mode, use the LARGE cup size button, top far right, to navigate to the “RECIPE SET UP?” screen.
2. Press the button under “YES” (button “B”), and “USER SELECT MODE” screen will appear.
3. To change from a “MULTI”, small and large cup sizes, to a “SINGLE” cup size, press the button under “SINGLE”, (button “D”), and “SINGLE” will flash to verify the selection.
4. Press  to accept the selection and exit to the “PROGRAM MODE” screen.
5. When complete, return to the NORMAL\PROGRAM\RINSE switch to the NORMAL position.

### CHANGING DEFAULT BEVERAGE SWITCH LOCATION or DISABLING A DISPENSE SWITCH

Any default beverage can be moved to a different switch location, or any dispense switch can be disabled. It is recommended that the touch switch graphic insert be replaced with one that matches the beverage reassignments made in this mode. Reference PROGRAMMING SWITCHES diagram on page 30, and on the flow chart on page 34.

1. In the PROGRAM mode, use the LARGE cup size button, top far right, to navigate to the “RECIPE SETUP?” screen.
2. Press the button under “YES” (button “B”) and then the LARGE cup size button until the screen displays the “SETUP SW ## RECIPE” for the desired switch to be modified.
3. In the “SETUP SW ## RECIPE” screen, press the button under “YES” (button “B”) to modify that switch setup.
4. Press the button under (+), (button “B”) to scroll through the recipe names until the desired beverage is displayed. If “DISABLE” is selected as a recipe, this dispense switch will be disabled.
5. After the desired recipe name is displayed, press the LARGE cup size button to advance to the “SW # SMALL TM” screen. The amount of soluble product in the beverage can be adjusted by using the (-) (button “D”) or the (+) (button “B”) button to change the dispense time.
6. Press the LARGE cup size button to advance to the “SW # LARGE TM” screen. The amount of soluble product in the beverage can be adjusted by using the (-) (“D”) or the (+) (“B”) button to change the dispense time. Press  to exit this menu.
7. Return the NORMAL\PROGRAM\RINSE switch to the NORMAL position.

## MODIFYING THE TOUCH SWITCH FUNCTIONS - CONTINUED

### CREATING A “CUSTOM” BEVERAGE

In this mode, a “CUSTOM” beverage may be created in any dispense switch location. A CUSTOM beverage consists of product from one or two soluble hoppers, and may include a shot of espresso. Or, instead of a soluble component, “DILUTION” may be selected to pair with an espresso shot to create an AMERICANO type beverage. It is recommended that the touch switch graphic insert be replaced with one which matches the beverage reassignments made in this mode. Reference PROGRAMMING SWITCHES diagram on page 30, and on the flow chart on page 35.

1. In the PROGRAM mode, use the LARGE cup size button, top far right, to navigate to the “RECIPE SETUP?” screen.
2. Press the button under “YES” (button “B”) and “USER SELECT MODE” screen will appear.
3. Press the LARGE cup size button until the screen displays the “SETUP SW ## RECIPE” for the desired switch to be modified.
4. Press the button under (+), (button “B”) to scroll through the recipe names until “CUSTOM” is displayed.
5. Press the LARGE cup button to advance to the “SW # SMALL TM” screen. The amount of soluble dilution water in the beverage can be adjusted by using the (-) (“D”) or the (+) (“B”) button to change the dispense time. Note: This is the total soluble dilution water dispense time for either a single soluble component or both soluble components. It is also the dispense time if DILUTION is selected. The nominal flow rate is 22ml per second, (.74 oz/sec). So the dispense time can be estimated by dividing the volume of the soluble component or dilution water desired by the flow rate per second. This does not account for the actual soluble powder product.
6. Press the LARGE cup size button to advance to the “SW # LARGE TM” screen. The volume of soluble or dilution water can be adjusted as in step 5.
7. Press the LARGE cup size button to advance to the “ESPRESSO SHOT?” screen. The default selection of “YES” will be flashing. If an espresso shot is to be included in the recipe, press the LARGE cup button for yes. If an espresso shot is not to be included, press the button under “NO” (button “D”), then press the LARGE cup button to advance. The default espresso shots settings will be included in the recipe, a small shot for the small beverage, and large shot for the large beverage.
8. In the 1st POWDER/DIL” screen, use the (+) (“B”) button to scroll to the hopper, LEFT, CENTER, or RIGHT, that the soluble product is to be dispensed from. Select the soluble hopper for the first ingredient, or DILUTION for hot water only.
9. Press the LARGE cup button to move to the “2nd POWDER/DIL” screen. Use the (+) (“B”) button to select the next ingredient hopper, or “NONE” if only one soluble ingredient is to be used.
10. Press the LARGE cup button. If more than one soluble hopper has been selected, the “HOPPER ##### PORTION” screen will appear. In this screen, use the (+) (“B”) and (-) (“D”) button to set the percentage portion of the total soluble ingredients you wish this hopper to consist of. Selection value may be between 15 and 85%.
11. Press the LARGE cup button to advance to the “HOPPER ##### STR” screen. Use the (+) (“B”) and (-) (“D”) button to adjust the amount (strength) of the soluble ingredient to be dispensed.
12. Press the LARGE cup button. If a second soluble ingredient was selected, the “HOPPER ##### STR” screen will be displayed. Use the (+) (“B”) and (-) (“D”) button to adjust the amount (strength) of the soluble ingredient to be dispensed.
13. Press the LARGE cup button to go back to the switch selection screen, or  to exit the RECIPE SETUP? screens.

## CHANGE THE DISPLAY LANGUAGE

The display language can be changed in the PROGRAMMING MENU.

To access the “SELECT LANGUAGE” menu:

1. Open the door and place the NORMAL/PROGRAM/RINSE switch in the PROGRAM position. (Figure 1)
1. Press buttons 1-5-9-10 in sequence. (Figure 2)
2. Use the (-) or (+) buttons to scroll through the available languages. (Figure 3)
3. Press the  button to accept the new selection and exit to the programming menu.

## ENERGY SAVER MODE

In this mode, the machine will operate in a low power mode during off hours to save energy. The display backlight will be turned off, and the display message will toggle between “Energy Saver/Mode Enabled” and “Change to Normal/Mode to Clear”. The dispense buttons are disabled so that no beverage dispensing is allowed. The tank refill and powder (soluble) tank heater are disabled. The espresso tank temperature setting is reduced to 130°F (54°C).

To enable the Energy Saver mode:

1. In PROGRAM mode, press the LARGE cup button (button “A”), to navigate to the “LOCKS/DISABLES” menu.
2. Press the button under “YES” (button “B”) and then the LARGE cup size, (button “A”), until the screen displays “ENERGY SAVER?”.
3. In the default menu, “NO” will be flashing. Press the button under “YES” to enable the Energy Saver mode.
4. When “YES” is flashing on the display, press the button under “EXIT” to return to the main screen.
5. Place the NORMAL/PROGRAM/RINSE switch to the NORMAL position.

To place the unit in the ENERGY SAVER mode, open the door, and place the NORMAL/PROGRAM/RINSE switch in the RINSE position. After ten minutes with the switch in the RINSE position, the ENERGY SAVER mode will become active. If a rinse cycle has taken place, and the switch is left in the RINSE position, the ENERGY SAVER mode will become active ten minutes after the rinse cycle was completed. To exit the ENERGY SAVER mode, return the NORMAL/PROGRAM/RINSE switch to the NORMAL position.

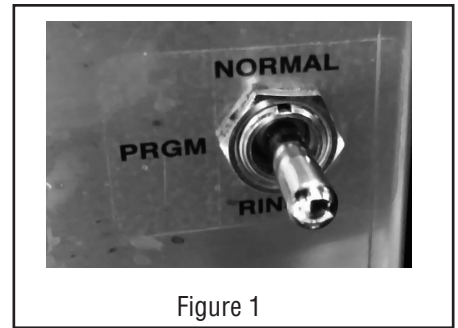

Figure 1



Figure 2

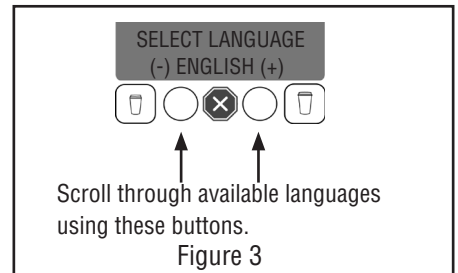

Figure 3

## THROUGH COUNTER OPTION

The machine can be setup to dispose of the used coffee grounds through an opening in the counter, into a waste bin, for higher waste capacity.

### Countertop and Machine Modifications for Through Counter Waste Option:

1. Use template (Bunn #54427.0000) to locate the cutout hole in the countertop.
2. Open the front door on Crescendo, and remove the grounds bin.
3. Remove the two screws that secure the grounds bin support panel, then remove the panel.
4. Remove screw holding the chassis bottom cover, then remove the cover.
5. Used coffee puck will now fall through the opening in the chassis.
6. Position the Crescendo so that the opening in the bottom of the machine coincides with the hole in the countertop.
7. To direct the brewing waste water through the counter, disconnect the drain tube from the fitting on the bottom of the espresso drive.
8. Connect a 5MM ID tube to the drain fitting, and direct the tube through the opening in the bottom of the chassis.

### Software Setup for Through Counter Option:

1. Power the machine.
2. In the PROGRAM mode, use the LARGE cup, (button "A"), to navigate to the "LOCKS/DISABLES" menu.
3. Press the button under "YES" (button "B") and then the LARGE cup size, (button "A"), until the screen displays the "PUCK BIN" screen.
4. In the default menu, "YES" will be flashing. Press the button under "NO" to disable the PUCK BIN mode.
5. When "NO" is flashing on the display, press the button under "EXIT" to return to the main screen.
6. Place the NORMAL/PROGRAM/RINSE switch to the NORMAL position.

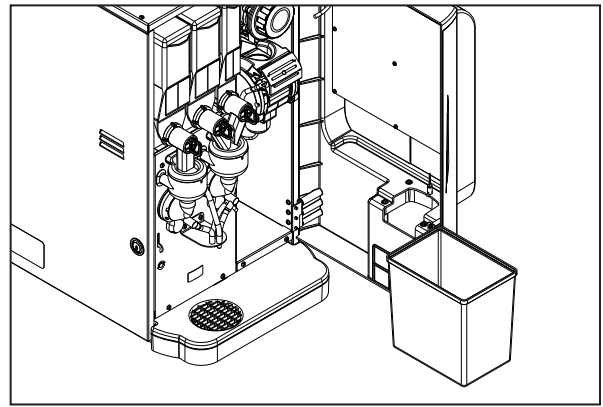

Remove the grounds bin

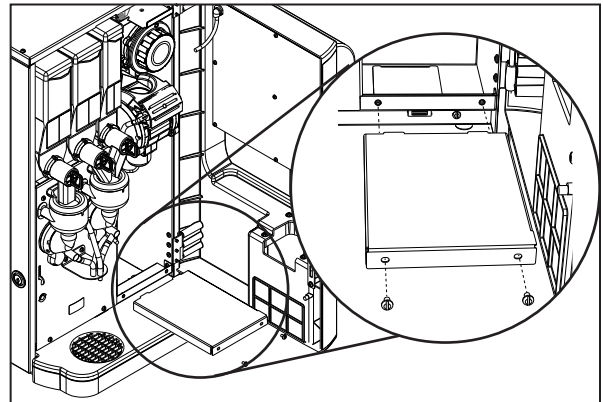

Remove grounds bin support panel

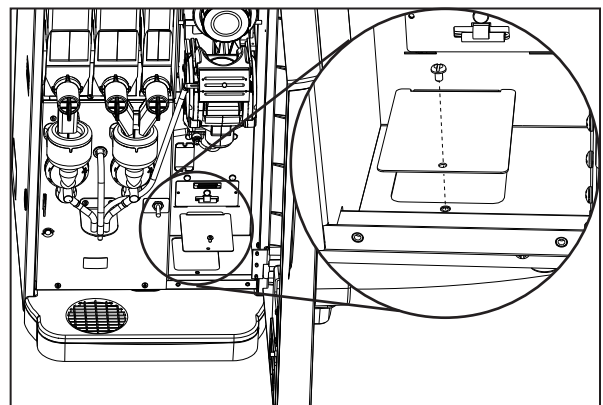

Remove the chassis bottom cover

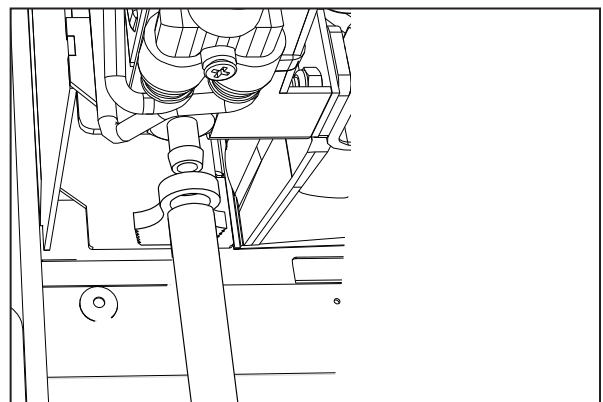

Connect a 5MM ID tube to the drain fitting

## GENERAL CLEANING

The use of a damp cloth rinsed in any mild, non-abrasive, liquid detergent is recommended for cleaning all surfaces on Bunn-O-Matic equipment.

### Exterior Surfaces:

- Do not use any abrasive materials.
- Use a soft, dry cloth to wipe down the exterior surfaces of the dispenser to maintain the luster of the stainless steel finish.
- Wash the stainless steel exterior surfaces of the dispenser with warm, soapy water. Rinse with warm, clear water. If the water is hard, wipe the dispenser dry with a soft cloth to prevent water spotting.
- Stainless steel polish may be used if it is sprayed on a cloth before the cloth is used to wipe down the exterior surfaces of the dispenser.

### DAILY: PARTS WASHING

1. Remove and wash the drip tray and drip tray cover in a mild detergent solution. Rinse thoroughly.
2. Wipe the lower front panel, door, and cabinet with a clean damp cloth.

### WEEKLY: PARTS WASHING

1. Remove the elbows and slide gates from all hoppers. Disconnect the elbows from the outlets of both mixing chambers.
2. Remove the powder mixing chambers, steam traps, frothers and mixing chamber bases.
3. Remove the dispense hoses from the dispense nozzle assembly.
4. Clean all parts removed in warm soapy water. Use Bunn P/N 26367.0000 or 49827.0000 cleaning brush provided to clean bores and orifices. Rinse in cold water.
5. Prepare one-gallon (3.8 liter) of sanitizing solution with at least 100 ppm of available chlorine in 120°F (48.9°C) water. Soak all cleaned parts in sanitizing solution for 5 minutes, then allow to air dry.
6. Rinse cleaning brush, dip in sanitizing solution, and brush the bore of both dispense nozzles  
**NOTE:** Repeat this procedure for each nozzle separately.
7. When reassembling parts, be sure to align arrow on frother disk with flat on whipper motor shaft, and rotate tab on whipper base clock wise to the vertical position to lock mixing chamber.



1 x 24h

# BUNN®

1. Rinse out Whipper Chambers by placing the RUN/PROGRAM/RINSE switch in the RINSE position, then press the button under RINSE followed by pressing any beverage dispense button.
2. Push the slide gates on the front of the hopper elbows inward to close. Remove hoppers, refill with product, and replace hoppers into dispenser.
3. Empty Drip Tray and wash in a solution of dish detergent.

1. Lave la cámara de batido colocando RUN/PROGRAM/RINSE en la posición de lavado RINSE, y apretar el botón bajo RINSE. Luego aprete cualquier botón dispensador de bebida.
2. Empuje la compuerta deslizante frente a los codos de la tolva hacia adentro para cerrar. Remueva las tolvas, rellene con producto y vuelva a colocar la tolva en el dispensador.
3. Vacie la bandeja de goteo y limpiela con un detergente liquido suave no abrasivo.



1 x 7d

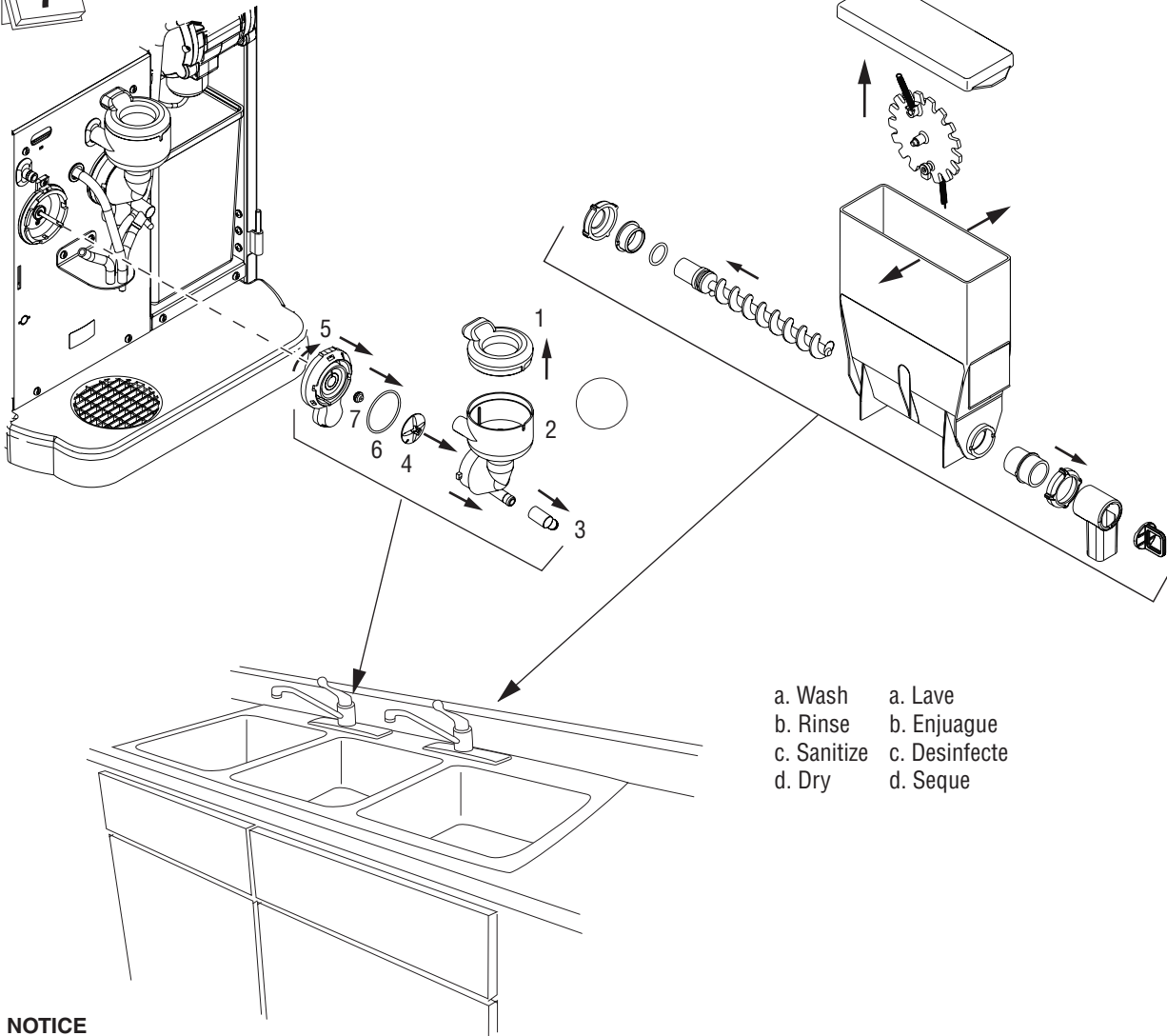

**NOTICE**

The cleaning instructions noted above are for non-dairy sugar based food products. When dispensing any other food product, the cleaning cycle for the whipping chamber assembly and ejector elbow must be performed daily.

**NOTA:**

Las instrucciones de limpieza descritas anteriormente excluyen productos lacteos azucarados. La limpieza de las camaras de mezcla y de los codos de salida de cada tolva deberá realizarse diariamente.

52564.0000A 12/15 © 2015 BUNN-O-MATIC CORPORATION



## CLEANING - continued

### Every 1000 cycles or weekly: ESPRESSO BREW CHAMBER

1. Remove espresso brew group head, and clean with a brush and warm water.

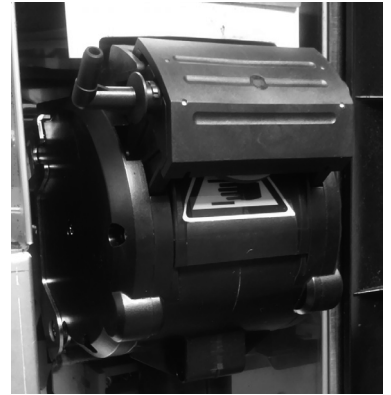

2. Remove Sieve Head & Cake Pusher.



3. Clean Sieve Head & Cake Pusher with lukewarm water only, paying special attention to the channels.



4. Insert cleaning brush into each side of the brewer-housing and under lukewarm water, turn the cogs.

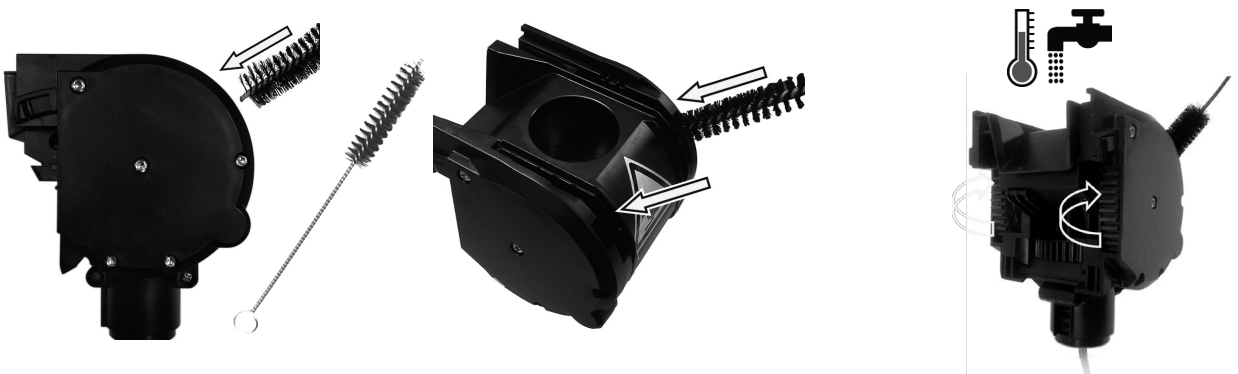

## CLEANING - continued

### Every 1000 cycles or weekly: ESPRESSO BREW CHAMBER

5. Re-assemble the brewer, making sure the gear wheels are aligned (open) for sieve head insertion.



6. Re-attach the water inlet hose and place the brewer back in the drive unit.



7. Reconnect outlet hose, slide the red retaining clip to the right until it snaps into lock position.



## CLEANING - continued

### RINSE CYCLE (Required Daily)

1. Open the door and place the NORMAL/PROGRAM/RINSE switch in the RINSE position.



2. Close door and place a minimum 400ml container under the dispense nozzles.



3. Press the button under RINSE on the screen.

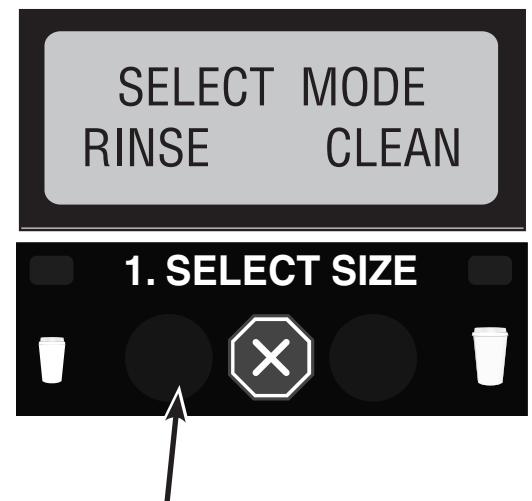

4. Press any beverage selection button.
5. The dispenser will automatically run hot water through both soluble mixing chambers, and flush the espresso brew chamber with hot water.
6. After rinse cycle is complete, discard the rinse water collected in the container.
7. Open the dispenser door, and place the NORMAL/PROGRAM/RINSE switch in the NORMAL position.

## CLEANING - continued

### CLEAN CYCLE - WEEKLY

1. Open the door and place the NORMAL/PROGRAM/RINSE switch in the RINSE position.



2. Press the button under CLEAN on the screen.

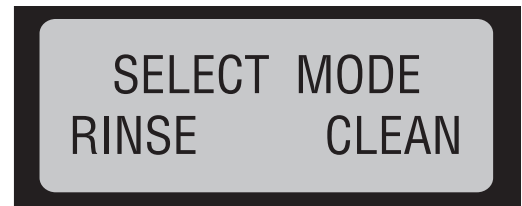

3. When the screen prompts ADD CLEANING TABLET, open the dispenser door, and drop a cleaning table into the opening of the espresso brew chamber as shown.



Add cleaning  
tablet here

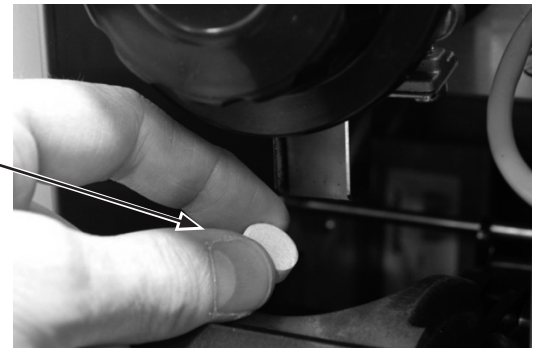

4. Close dispenser door and place a minimum 500ml container under the dispense nozzles.
5. Press the button under NEXT.



## CLEANING - CLEAN CYCLE continued

6. When screen displays PRESS DISPENSE TO START, press any beverage dispense button to begin cleaning cycle.

PRESS DISPENSE  
TO START

7. During the cleaning cycle, the screen will display CLEANING CYCLE IN PROGRESS/PRESS  TO STOP.

CLEANING CYCLE  
IN PROGRESS

PRESS ANY BUTTON  
TO STOP

8. When the cleaning cycle is complete, screen will display SELECT MODE/ RINSE\_\_ CLEAN.

SELECT MODE  
RINSE      CLEAN

9. Discard the waste water collected from the cleaning cycle.
10. Open the dispenser door, and place the NORMAL/PROGRAM/RINSE switch in the NORMAL position.

## Weekly: Parts Washing and Sanitizing



1. Remove elbows from all hoppers.



2. Remove elbows from right & left mixing chambers, twisting slightly to help release.



3. Rotate tab at bottom of mixing chamber bases counter clock wise to release base.



4. Remove mixing chambers by pulling straight out.



5. Remove right frother disk from shaft by pulling straight out.



6. Rotate tab on mixing chamber base further counter clock wise, and remove from shaft by pulling straight out.

**NOTE:** Insure O-ring and shaft seal are in place during re-assembly.

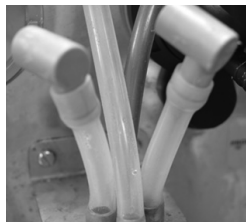

7. Remove dispense hoses from dispense nozzle assembly.

8. Clean all parts removed in warm soapy water. Use Bunn P/N 11685.0000 cleaning brush provided to clean bores and orifices. Rinse in cold water.

9. Prepare one-gallon (3.8 liter) of sanitizing solution with at least 100 ppm of available chlorine in 120°F (48.9°C) water. Soak all cleaned parts in sanitizing solution for 5 minutes, then allow to air dry.

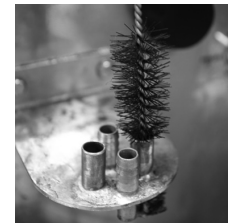

10. Rinse cleaning brush, dip in sanitizing solution, and brush the bore of both dispense nozzles.

**NOTE:** Repeat this procedure for each nozzle separately.

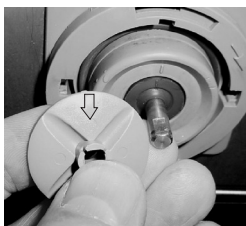

11. When reassembling parts, be sure to align arrow on frother disk with flat on whipper motor shaft, and rotate tab on whipper base clock wise to the vertical position to lock mixing chamber.

## LOCKS/DISABLES

1. Open the door and place the NORMAL/PROGRAM/RINSE switch in the PROGRAM position.



2. Use the Large Cup button to scroll to the LOCKS/DISABLES screen, and press the button under "YES".

LOCKS/DISABLES  
EXIT YES

3. In the DISPENSE LOCKOUT screen, pressing the button under YES will prevent the dispenser from operation if the tanks are not at the minimum ready temperature requirement. Pressing the button under NO will allow dispensing if the tank temperatures are below ready temperature requirement.

DISPENSE LOCKOUT  
NO EXIT YES

4. Press the Large Cup button to RINSE ALARM. Pressing the button under YES will enable the rinse alarm. The screen will display RINSE ALARM TIME. Use the buttons under (-) and (+) to modify the rinse alarm time. If the time set since the last rinse has been exceeded, a rinse required will be displayed on the front door screen.

RINSE ALARM  
NO EXIT YES

RINSE ALARM TIME  
(-) 12hours (+)

5. Press the Large Cup button to RINSE LOCKOUT. Pressing the button under YES will disable the dispenser once the RINSE ALARM TIME has expired. Running a rinse cycle will reset the timer, and enable the dispenser to resume normal operation.

RINSE LOCKOUT  
NO EXIT YES

6. Press the Large Cup button to LOW HPR LOCKOUT. Pressing the button under YES will prevent espresso shots from being prepared if the coffee bean hopper detects a low bean level condition. Filling the bean hopper above the low level will allow espresso brewing to resume.

LOW HPR LOCKOUT  
NO EXIT YES

## ADJUSTMENTS

### BEVERAGE DISPENSE TIME ADJUSTMENT:

1. Open the door and place the NORMAL/PROGRAM/RINSE switch in the PROGRAM position.
2. Use the Large Cup button to scroll to the SET BEVEREGE SZ screen, and press the button under “YES”.
3. Use the Large Cup button to access the beverage you wish to modify.
4. Under the beverage name, use the buttons under (-) and (+) to modify the dispense time for that beverage.
5. Press the LARGE CUP BUTTON after the time has been adjusted.
6. Place the NORMAL/PROGRAM/RINSE Switch in the NORMAL position, and press the center button to exit the program mode.

### HOPPER DISPENSE VOLUME ADJUSTMENT:

The powder throw for the powder products is pre-set from the factory. It can be checked and adjusted in the field using this adjustment procedure.

1. Open the door and place the NORMAL/PROGRAM/RINSE switch in the PROGRAM position.
2. Remove the mixing chamber below the left hopper outlet elbow.
3. Press the Large Cup button until “STRENGTH ADJ?” menu, and press the button under “YES”.
4. The display will read LEFT HOPPER STR, referring to the left or hopper 1.
5. Press the Large Cup button to TEST LEFT HOPPER menu.
6. Tare a small cup on the digital scale, then hold the cup under the hopper outlet elbow, and press the espresso button.
7. The hopper will dispense powder product into the cup for 10 seconds, then automatically stop.
8. Set the first dispense aside.
9. Repeat the process two more times, and average the three results to determine throw weight of the powder product.
10. To determine throw rate, divide average by 10 to determine the grams or ounces per second being dispensed.
11. To adjust hopper throw rate, press the Small Cup button and the screen will read LEFT HOPPER STR. Use the buttons under the (-) or (+) to decrease or increase the hopper speed, as required.
12. Press the Large Cup button to TEST LEFT HOPPER menu, and retest the adjustment.
13. After hopper 1 is checked and adjusted, use the Large Cup button to move to MDLE HOPPER TEST. Remove the right mixing chamber, and repeat steps 6 though 11 to test and adjust the middle, or second hopper.
14. Use the Small Cup button to move to “POWDER STRNGTH 2” screen to adjust speed for hopper 2, if required.
15. After hopper 2 is checked and adjusted, use the Large Cup button to move to TEST RT HOPPER. Repeat steps 6 though 11 to test and adjust the right, or third hopper.
16. Use the Up Arrow to move to RIGHT HOPPER STR screen to adjust speed for hopper 3, if required.
17. Reassemble the mixing chambers when the adjustments are complete.
18. Place the NORMAL/PROGRAM/RINSE Switch in the NORMAL position, and press  to exit the program mode.



## ADJUSTMENTS - continued

### GRINDER THROW WEIGHT ADJUSTMENT:

1. Open the door, and slide the espresso brew group lock to the left to unlock the brew group.
2. Tip the top of the brew group head towards the front of the machine to disengage from the espresso drive, then remove brew group from the drive.
3. Place the NORMAL/PROGRAM/RINSE switch in the PROGRAM position.
4. Press the Large Cup button to the STRENGTH ADJUST menu, then press the button under YES.
5. Press the Large Cup button to TEST SM GRINDTM.
6. Place a small container on a scale, and tare container.
7. Hold the container under the grinder chute, and press any beverage dispense button.
8. Grinder will run for the time set for a small (single shot) espresso, then stop.
9. Repeat several times, and average the weight.
10. To change the weight, press the Small Cup button to SM ESP GRIND TIME.
11. Use the buttons below the (-) and (+) button to increase or decrease the grind time.
12. Press the Large Cup button to TEST SM GRIND to test new grind time.
13. Press the Large Cup button to TEST LG GRIND to test the large (double shot) grind weight.
14. Press the Small Cup button to LF ESP GRIND TIME to adjust the grind time for a large (double shot) espresso, if required.
15. After the grind adjustments have been tested and adjusted, place the NORMAL/PROGRAM/RINSE Switch in the "RUN" position, and press  to exit the program mode.
16. Reinstall the espresso group head back onto the espresso drive.

### GRINDER PARTICLE SIZE ADJUSTMENT:

The particle size of the ground coffee can be adjusted for optimal brewing of the espresso.

1. Turn knob counterclockwise to increase the particle size of the ground coffee (see Figure 1.)
2. Turn the knob clockwise to decrease the particle size of the ground coffee. **CAUTION!** If there is ground coffee in the grinder, this adjustment should only be made while the grinder is running. Use STRENGTH ADJUST, TEST SM or LG GRIND functions to operate the grinder for adjusting to a finer grind.



Figure 1

## DOOR SAFETY INTERLOCK

The dispenser is equipped with a door interlock safety switch, which prevents the operator from being exposed to the moving parts of the espresso brewer if the door is open.

The switch may be overridden by a qualified service technician by inserting the service key, (BUNN PN 51953.0001) into the opening of the mixing chamber panel, then turning 90° as shown in Figure 2.

Service Key

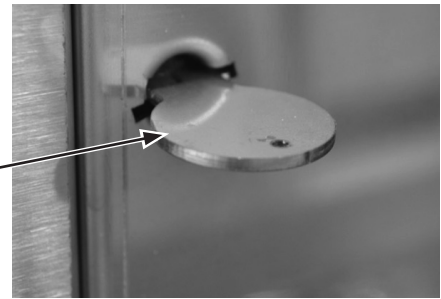

Figure 2

## DRAINING THE HOT WATER TANKS – to be performed by qualified service personnel only!

1. Open the door and place the NORMAL/PROGRAM/RINSE switch in the PROGRAM position.
2. Close the door and place a minimum two liter container under the dispense nozzles.
3. Press the Large Cup button until the screen reads DIAGNOSTICS.
4. Press, in sequence, buttons 3, 7, 4 and 1. See diagram below for button number designations.
5. The screen will display SYSTEM WET TEST. Press the button under YES.
6. Press the button under COOL ESP TANK.
7. Press the button under START in the COOL ESP TANK screen.
8. The pump will begin running, and hot water will dispense into the container. After 4 minutes, the pump will automatically stop.
9. In the ESP TANK COOL? screen, press the button under YES.

**NOTE: Dispenser must be disconnected from the power source in steps 10 through 24.**

10. Immediately disconnect the dispenser from the power source, and water supply.
11. Let the water in the soluble tank cool before draining.
12. Remove left side panel.
13. Pull the drain tube out of the dispenser and direct it into a drain or a container large enough to hold the volume of water in the tank, approx 6 liter (1.5 gallon).
14. Remove the plug from end of tube.
15. After the tank has drained, replace the plug in the end of the tube.
16. Remove the tube from the connector in the bottom of the espresso tank.
17. Swivel the tube towards the outside of the machine.
18. Empty the container used to capture the hot water from the tank, and place it on the right side of the machine.
19. Insert a 6mm OD tube into the bottom tank fitting, place the other end into the container.
20. Use a 4mm hex wrench to loosen the plug on the top of the espresso tank, until the tank begins to drain.
21. After the tank is drained, retighten the plug.
22. Remove the drain tube from the bottom tank fitting.
23. Rotate the fitting towards the inside of the tank. Compressing the release sleeve on the fitting, fully insert the pump tube.
24. Replace the left and right side panels.

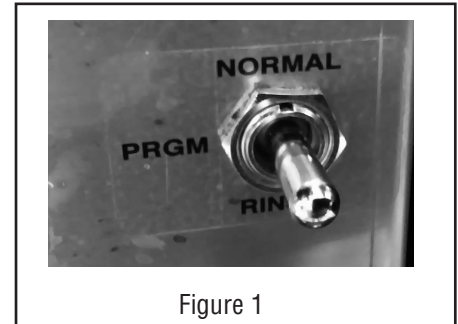

Figure 1



Figure 2

## PASSWORD PROTECTION

In the PROGRAMMING MENU, there are two levels of password protection available:

**PASSWORD 1** Protects all program menu settings.

**PASSWORD 2** Allows monitoring and changes to the tank temperature and strength adjust settings, but protects all other settings.

### PASSWORD 1

1. To enter PASSWORD 1: Open the door and place the NORMAL/PROGRAM/RINSE switch in the PROGRAM position. (Figure 1).
2. In the PROGRAMMING MENU the “ENTER PASSWORD 1” screen will display after the “APPLICATION/SW VERSION 00.##” screen (refer to “PROGRAM MENU” flow chart).
3. The unit is shipped from the factory with a default password setting of 0000.
4. To set PASSWORD 1: The “SET PASSWORD 1” screen will display after the “ENTER PASSWORD 1” screen. Use the (-) and (+) buttons to set any numerical password desired, from 0000 to 9999. Password is set one digit at a time.

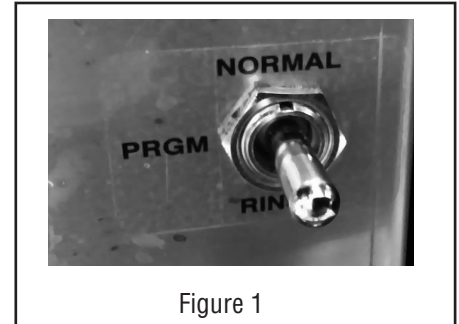

Figure 1

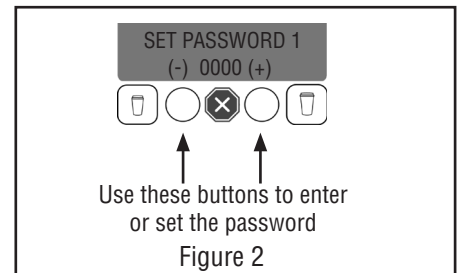

Figure 2

### PASSWORD 2

1. To enter PASSWORD 2: Open the door and place the NORMAL/PROGRAM/RINSE switch in the PROGRAM position.
2. In the PROGRAMMING MENU the “ENTER PASSWORD 2” screen will display after the “STRENGTH ADJUST” menu (refer to “PROGRAM MENU” flow chart).
3. The unit is shipped from the factory with a default password setting of 0000.
4. To set PASSWORD 2: The “SET PASSWORD 2” screen will display at the end of the “LOCKS/DISABLES” menu (refer to “PROGRAM MENU” flow chart). Use the (-) and (+) buttons to set any numerical password desired, from 0000 to 9999. Password is set one digit at a time.

# GLOSSARY

TANK TEMP XXX° (-) EXIT (+)	Adjust soluble tank temperature (190° F maximum)	AUGER DELAY (-) .50 sec (+)	Delays the start of the hopper motors after dispense valve opens. This prevents soluble powder from entering mixing chamber ahead of hot water.
READY TEMP XXX° (-) EXIT (+)	Adjust minimum soluble tank ready temperature for lockout (185° maximum)	WHIPPER DELAY (-) .00 sec (+)	This delays the start of the whipper motors after the dispense valve opens.
ESPRS TEMP XXX° (-) EXIT (+)	Set espresso tank temperature.	CAL HOT WATER PRESS DISPENSE	Pressing any dispense button opens the hot water valve for ten seconds. This allows the valve to be adjusted for the proper flow rate.
ESPRS READY XXX° (-) EXIT (+)	Set espresso tank ready temperature. Tank temp. must reach this to enable brewing if brew lockout is set.	CAL LFT PWDR VLV PRESS DISPENSE	Pressing any dispense button opens the left hot water valve for ten seconds. This allows the valve to be adjusted for the proper flow rate.
STRENGTH ADJUST EXIT YES	Takes you to the STRENGTH ADJUST sub-menu to adjust soluble hopper speeds and grinder times.	CAL RT PWDR VLV PRESS DISPENSE	Pressing any dispense button opens the right hot water valve for ten seconds. This allows the valve to be adjusted for the proper flow rate.
CALIBRATION EXIT YES	Takes you to the CALIBRATION sub-menu.	PUMP START DELAY (-) .# sec (+)	This delays the start of the espresso pump after the espresso valve opens.
SET BEVERAGE SZ EXIT YES	Takes you to the SET BEVERAGE SIZE sub-menu to adjust beverage size.	ESP THRESHOLD (-) ### (+)	This sets the current level at which the piston sees, to signal the motor to shut down in the wipe position.
SET ESPRS SHOTS EXIT YES	Takes you to the SET ESPRESSO SHOTS sub-menu to set up espresso shots.	PSTN HOME THRESHOLD (-) ### (+)	This sets the current level at which the piston sees, to signal the motor to shut down in the home position.
LOCKS/DISABLES EXIT YES	Takes you to the LOCK/DISABLES sub-menu.	CAL BEAN HOPPER EXIT YES	This calibrates the photo sensor on the bean hopper by detecting the ambient light with the hopper empty, then setting a threshold for signaling when the hopper is empty.
DIAGNOSTICS EXIT YES	Takes you to the DIAGNOSTICS menu to test components.	PRE-HEAT ESP GRP NO EXIT YES	This asks if you want to enable pre-heating of the espresso group, if espresso has not been brewed within "X" amount of time. For espresso shots only - not for specialty drinks.
FACTORY DEFAULTS NO YES	Takes you to the FACTORY DEFAULTS sub-menu to enable restoring factory defaults.	SET PRE-HEAT TIME (-) ###min (+)	Sets the amount of time (in minutes), that if exceeded, will automatically go into pre-heat routine, if an espresso shot is selected to be dispensed.
LEFT HOPPER STR (-) ## (+)	Use +/- buttons to increase or decrease powder hopper speed. This menu repeats for middle and right hopper.	ESPR TANK: ###F PWDR TANK: ###F	Live temperature display, or probe fault codes.
TEST LEFT HOPPER PRESS DISPENSE	Pressing any dispense button will run hopper for 10 seconds, at speed set in the menu above. This allows a catch test.		
SM ESP GRIND TIME (-) .#. sec (+)	Pressing any dispense button will run grinder for the small espresso programmed time. This allows a catch test. Menu repeats for large espresso grind time.		
TEST SM GRIND DISPENSE TO TEST	Pressing any dispense button will run grinder for the small espresso programmed time. This allows a catch test. Menu repeats for large espresso grind time.		
SELECT UNITS ENG EXIT METRIC	Allows applicable data to be displayed in English or Metric units.		
0 REFILL 155 (-) EXIT (+)	Sets threshold for refill probe on soluble water tank. Allows adjustment for different water conditions.		

## GLOSSARY - continued

SET DRAIN TIME (-) .# sec (+)	Set the amount of time after the hot water has completely pumped into the brew chamber, for the pre-heat cycle so that the drain valve is on to drain the chamber.	TEST SWITCHES UseSwitchToTest	Pressing any switch on the door will display the switch number on the LCD to confirm function. This is a momentary switch function.
SM COFFEE WHITE (-) ## sec (+)	Sets the dispense time (in seconds) for a small COFFEE WHITE beverage. Menu repeats for nine other beverages.	TEST REFILL EXIT YES	Pressing any switch on the door will activate the soluble tank refill valve. This is a momentary switch function.
LG COFFEE WHITE (-) ## sec (+)	Sets the dispense time (in seconds) for a large COFFEE WHITE beverage. Menu repeats for nine other beverages.	TEST LEFT AUGER DISPENSE TO TEST	Pressing any switch on the door will activate the left hopper auger motor. This is a momentary switch function.
SM ESP GRIND TIME (-) ## sec (+)	Sets grinder run time for small espresso. Repeat of menu in STRENGTH ADJUST sub menu. Menu repeats for large espresso.	TEST MDL AUGER DISPENSE TO TEST	Pressing any switch on the door will activate the middle hopper auger motor. This is a momentary switch function.
SM DRY TAMP % (-) ### (+)	Sets the percentage of full voltage to piston motor for tamping the dry puck. Menu repeats for large espresso.	TEST RIGHT AUGER DISPENSE TO TEST	Pressing any switch on the door will activate the right hopper auger motor. This is a momentary switch function.
SM PREINFUSION (-) ## sec (+)	Sets the espresso pump run time for pre-infusion of tamped coffee. Zero seconds for no pre-infusion. Menu repeats for large espresso.	TEST LEFT WHIPR DISPENSE TO TEST	Pressing any switch on the door will activate the left whipper motor. This is a momentary switch function.
SM DWELL TIME (-) ## sec (+)	Sets the dwell time (in seconds) between pre-infusion and the start of the espresso pump for final brewing. Menu repeats for large espresso.	TEST RT WHIPR DISPENSE TO TEST	Pressing any switch on the door will activate the right whipper motor. This is a momentary switch function.
SM BREW VOLUME (-) ### (+)	Sets the brew volume for a small espresso by flow count from flow meter. Menu repeats for large espresso.	TEST HOT WATER DISPENSE TO TEST	Pressing any switch on the door will activate the hot water valve. This is a momentary switch function.
DISPENSE LOCKOUT? NO EXIT YES	Enables locking out beverage dispensing if either tank is not at or above the ready temperature.	TEST LFT PWDR VLV DISPENSE TO TEST	Pressing any switch on the door will activate the left powder hot water valve. This is a momentary switch function.
RINSE ALARM? NO EXIT YES	Asks if you want to set an alarm, if a rinse cycle has not been run for "X" amount of time since the last rinse cycle.	TEST RT PWDR VLV DISPENSE TO TEST	Pressing any switch on the door will activate the right powder hot water valve. This is a momentary switch function.
RINSE ALARM TIME (-) 12 Hours (+)	Sets the number of hours since the last rinse cycle was run before signaling a rinse is needed.	TEST DRAIN VALVE DISPENSE TO TEST	Pressing any switch on the door will activate the drain valve in the brew group. This is a momentary switch function.
RINSE LOCKOUT? NO EXIT YES	Enabling prevents the dispensing of any beverage until a rinse cycle is completed.	TEST PUMP N VALV DISPENSE TO TEST	Pressing any switch on the door will activate the solenoid pump and espresso valve. This is a momentary switch function.
LOW HPR LOCKOUT? NO EXIT YES	Enabling prevents espresso brewing if a low bean hopper condition is detected.	TEST ESPRESSO VALV DISPENSE TO TEST	Pressing any switch on the door will activate the espresso valve. This is a momentary switch function.
		TEST SOLUBLE FAN DISPENSE TO TEST	Pressing any switch on the door will activate the soluble fan. This is a momentary switch function.
		PUCK BIN NOT PRESENT	Signals puck bin status.

## GLOSSARY - continued

TEST GRINDER DISPENSE TO TEST	Pressing any switch on the door will activate the coffee grinder motor. This is a momentary switch function. Note: Bean hopper must be in place.	RESET CUP COUNTS NO YES	Cup counts (all) can be reset.
TEST FLOW METER FLOW METER: 0	Pressing any switch on the door will activate the espresso pump and espresso water valve. Flow counts will increment on the LCD display This is a momentary switch function.	SELECT LANGUAGE (-) ENGLISH (+)	Allows user to scroll through available languages. Default is English.
TEST PISTON DOWN 140 UP	Pressing the button below the “DOWN” or “UP” on the LCD display will activate the appropriate piston action.	APPLICATION SW VERSION 00.##	Identifies current software version in main circuit board.
TEST SIEVE OPEN 0 CLOSE	Pressing the button below the “OPEN” or “CLOSE” on the LCD display will activate the appropriate sieve head action.	BOOTLOADER SW VERSION 00.##	Identifies bootloader software version.
PUCK BIN NO EXIT YES	Pressing the button below the “YES” will enable the puck bin counting functionality, whereas selecting “NO” sets up the machine for thru-counter operation.	PCAP MODULE (-) ENGLISH (+)	Identified current software version in PCAP module.
PUCK CAPACITY (-) ### (+)	Sets the amount of pucks the bin can hold before it needs to be emptied, and is only allowed to be set if the puck bin feature is currently enabled.	LCD MODULE 2 X 16	Identifies LCD module installed in this machine.
STATISTICS EXIT YES	Takes you to the statistics sub-menu so that you can look at cup counts.	ENTER PASSWORD 1 (-) 0000 (+)	Requires level 1 password to be entered to access remaining program menus.
ODOMETER #####	Total overall drinks dispensed by this machine in its life time, non-resettable.	SET PASSWORD 1 (-) 0000 (+)	Used to set level 1 password. Password may be any number from 0000 to 9999.
SM LIFETM COUNTS SELECT BEVERAGE	Drinks dispensed per beverage of the small cup counts size. Press and release a dispense button to see the number of times that recipe has been dispensed.	ENTER PASSWORD 2 (-) 0000 (+)	Requires level 2 password to be entered to access remaining program menus.
LG LIFETM COUNTS SELECT BEVERAGE	Drinks dispensed per beverage of the large cup counts size. Press and release a dispense button to see the number of times that recipe has been dispensed.	SET PASSWORD 2 (-) 0000 (+)	Used to set level 2 password. Password may be any number from 0000 to 9999.
SM RESETABLE CNTS SELECT BEVERAGE	Drinks dispensed per beverage of the small cup counts size. Press and release a dispense button to see the number of times that recipe has been dispensed. Count can be reset.	ENERGY SAVER? NO EXIT YES	Enables energy saver mode to save energy in off hours.
LG RESETABLE CNTS SELECT BEVERAGE	Drinks dispensed per beverage of the large cup counts size. Press and release a dispense button to see the number of times that recipe has been dispensed. Count can be reset.		

## PROGRAMMING THE DISPENSER

The following function screens are in order of appearance. Each screen will have instructions on how to access, and the procedures to program the various functions of the dispenser. To enable programming, place the “NORMAL/PROGRAM/RINSE” switch in the “PROGRAM” position.

### IMPORTANT PROGRAMMING NOTES - READ CAREFULLY

To exit the programming mode at any time, press and release the exit (center) pad located on the front switch panel. The display will return to the PROGRAM HOME SCREEN.

If none of the five programming switches are pressed within 90 seconds during the setup of the dispenser, the programming of the function screen that is being set will be exited and the display will return to the PROGRAM HOME SCREEN.

NOTE: To change the display language, see page 13 of this manual.

### PROGRAMMING SWITCHES

Using the menu-driven display (MAIN SCREEN) on the front of dispenser, the operator has the ability to alter or modify various functions of the dispenser. This allows for precise dispensing of various flavors of powdered products.

Programming of dispenser is achieved by entering a certain function, then, by use of programming switches, the operator can customize the dispensing process to their specifications.

To access the programming mode, and to scroll through different function screens, the programming switches shown are used. There are five switches that will be used for setup of the dispenser.

#### **NORMAL/PROGRAM/RINSE switch:**

**NORMAL:** Allows all dispenser functions. Must be in this position for dispensing.

**PROGRAM:** Allows access to program menus using touch pad and LCD screen.

**RINSE:** Pressing dispense button on front door will dispense dilution water and power whipper motor for ten seconds.

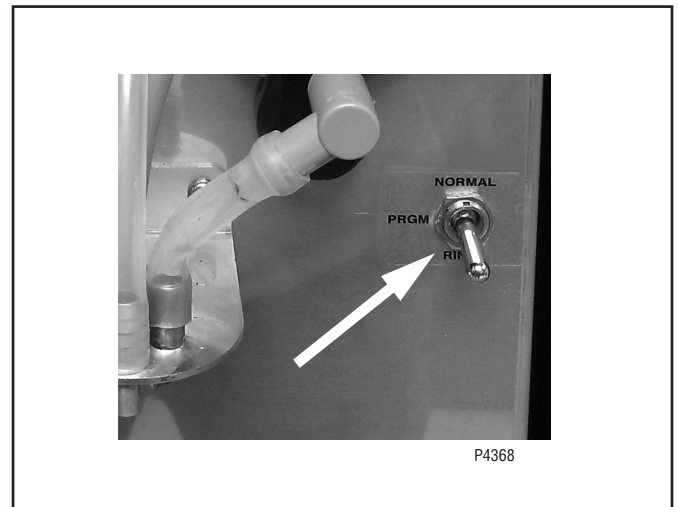
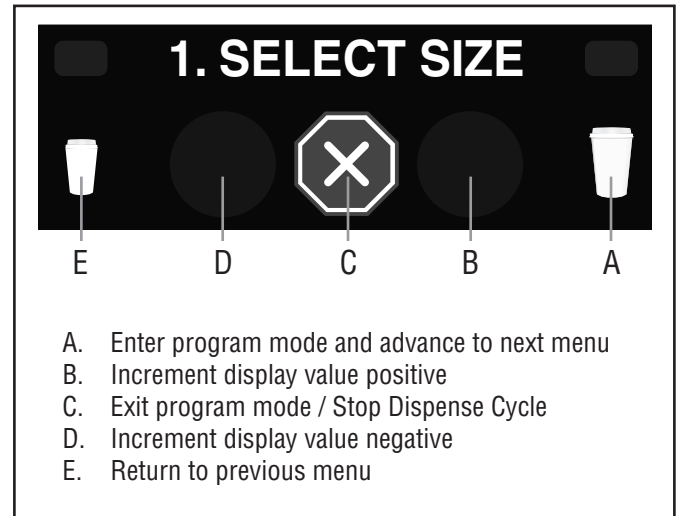

# PROGRAMMING MENU

To access the Programming Menu open the door and place the NORMAL/PROGRAM/RINSE switch in the PROGRAM position.

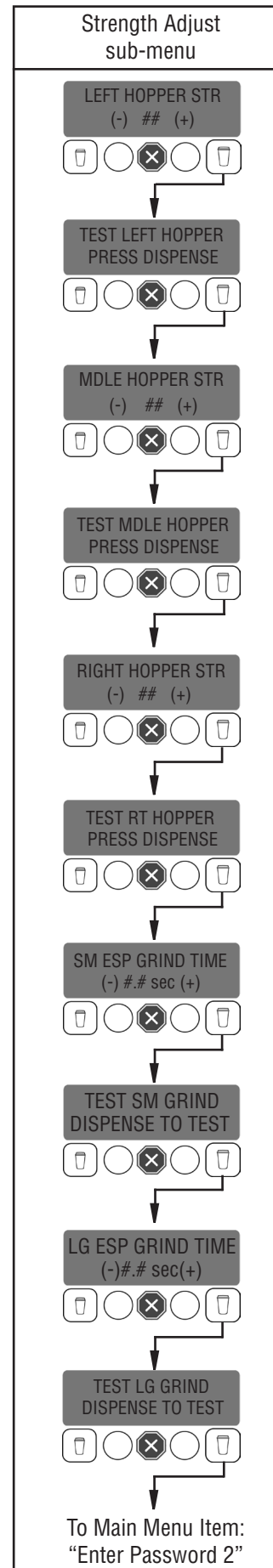
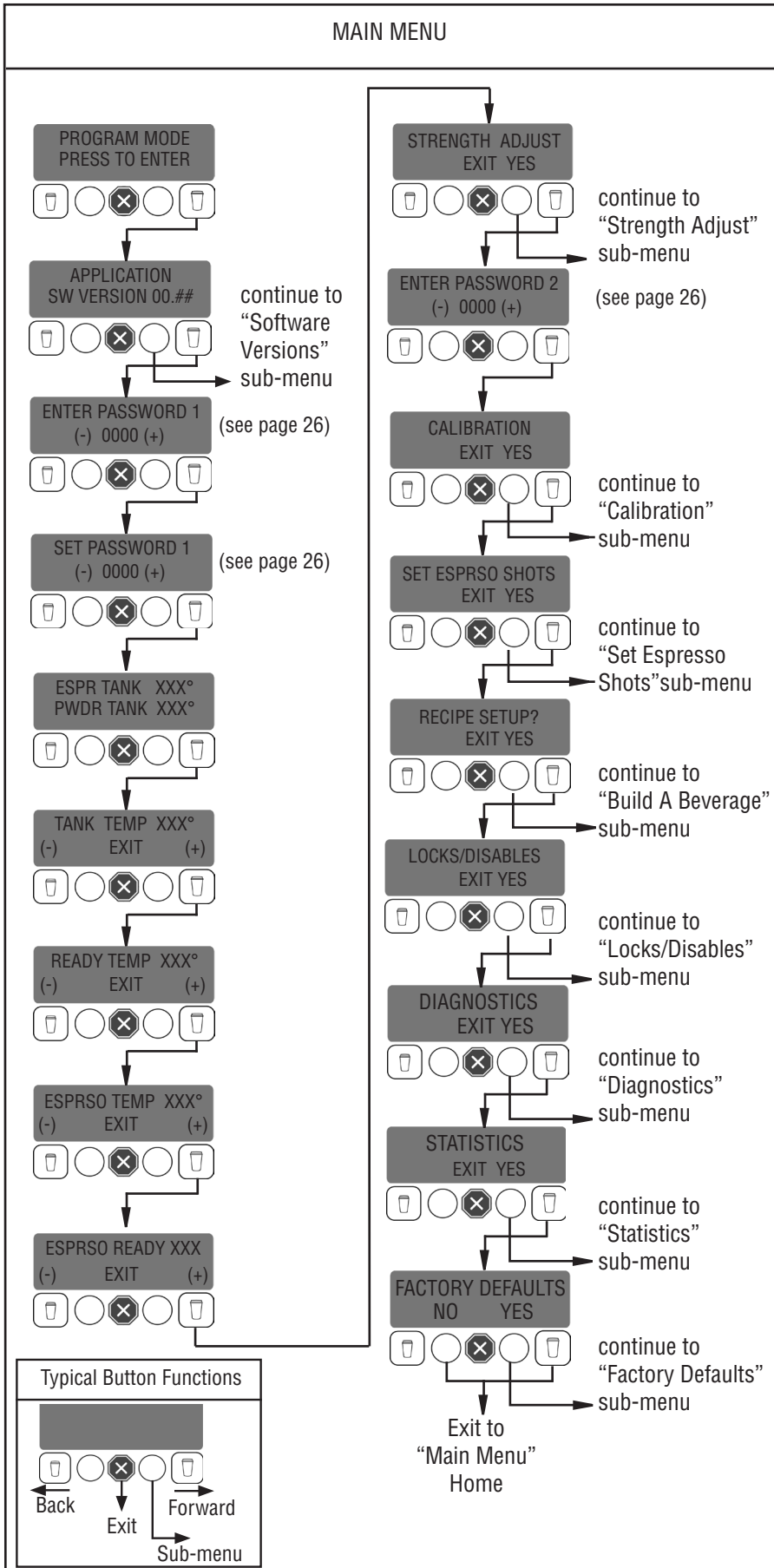



# PROGRAMMING MENU'S (cont.)

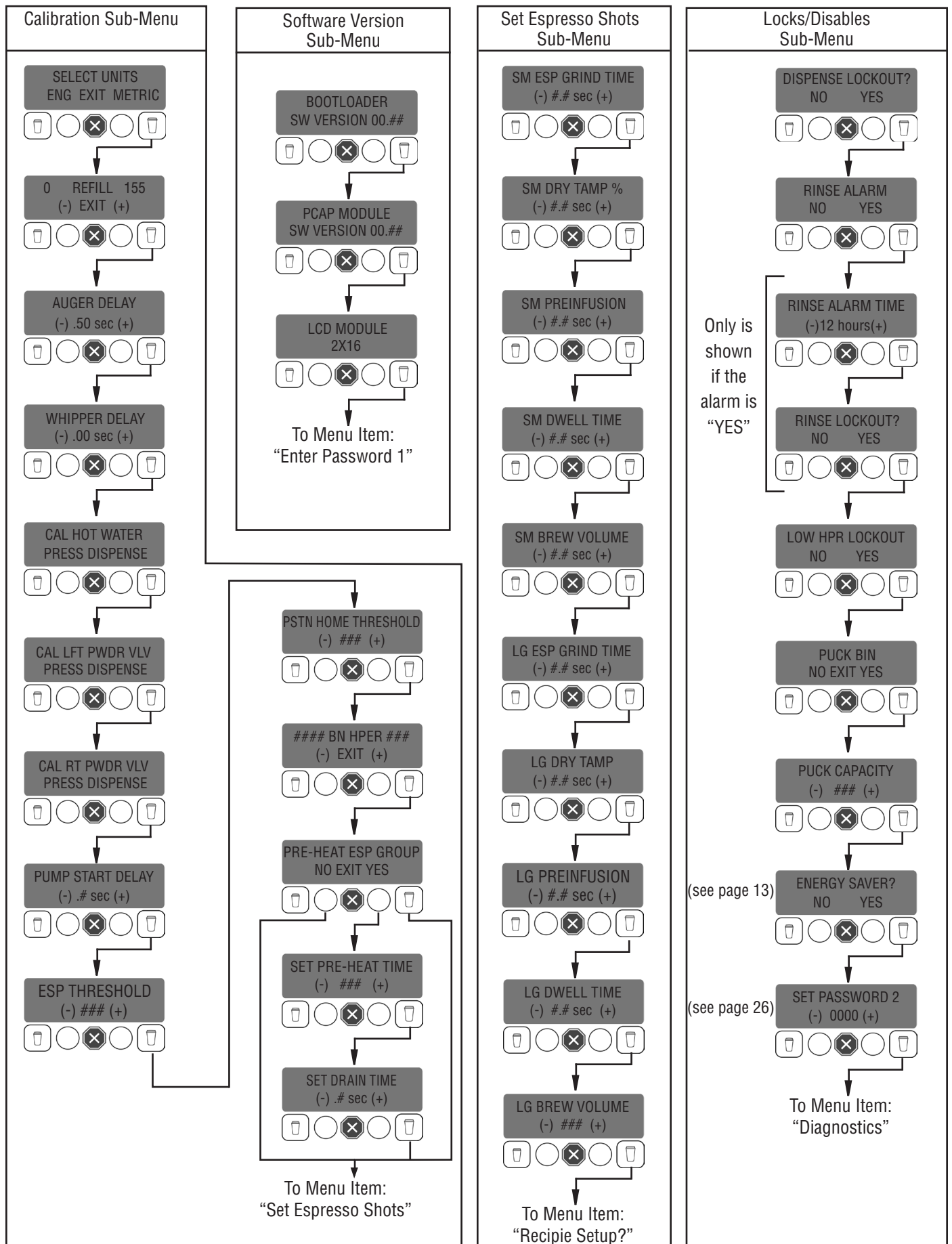

# PROGRAMMING MENU'S (cont.)

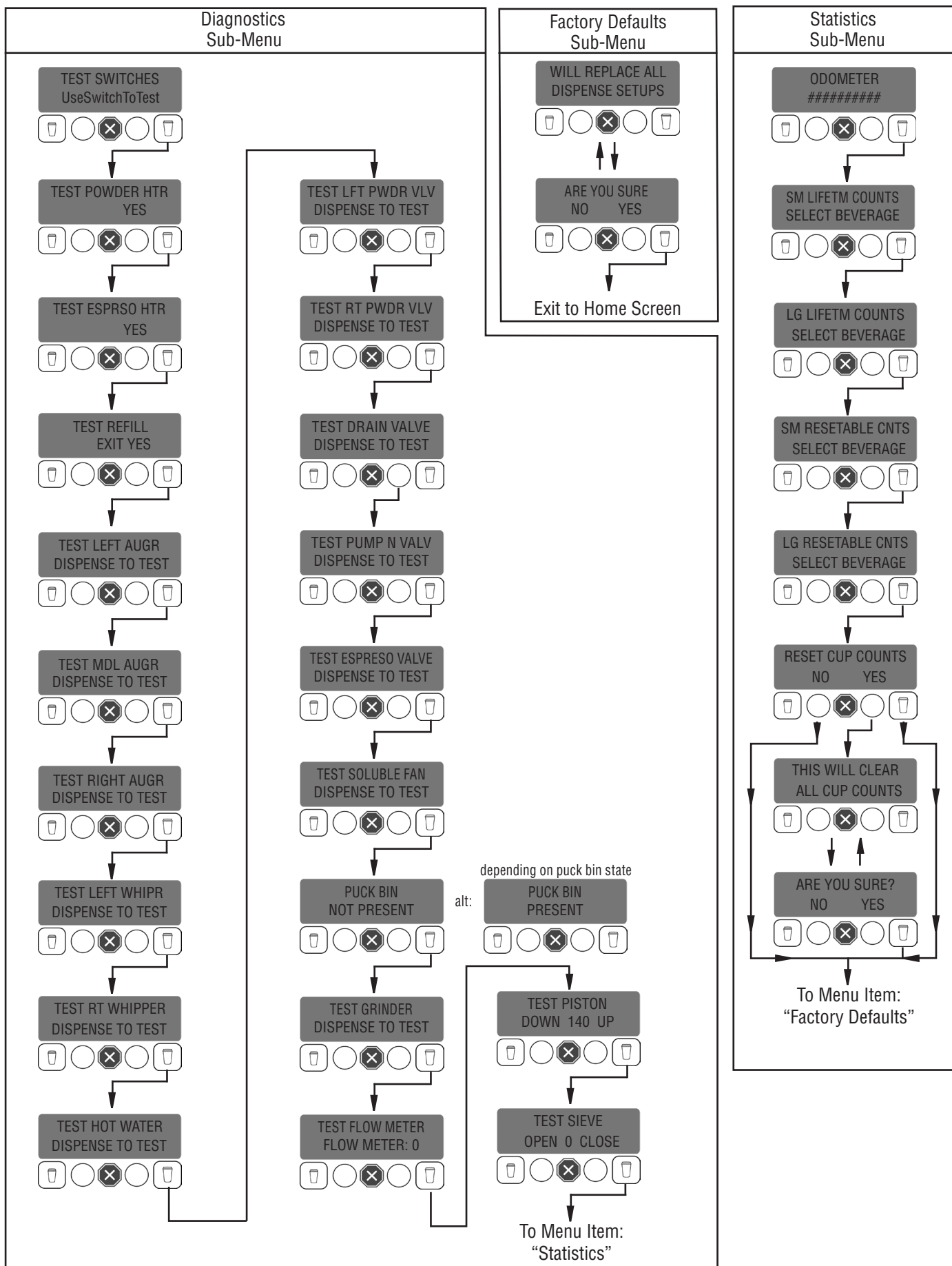

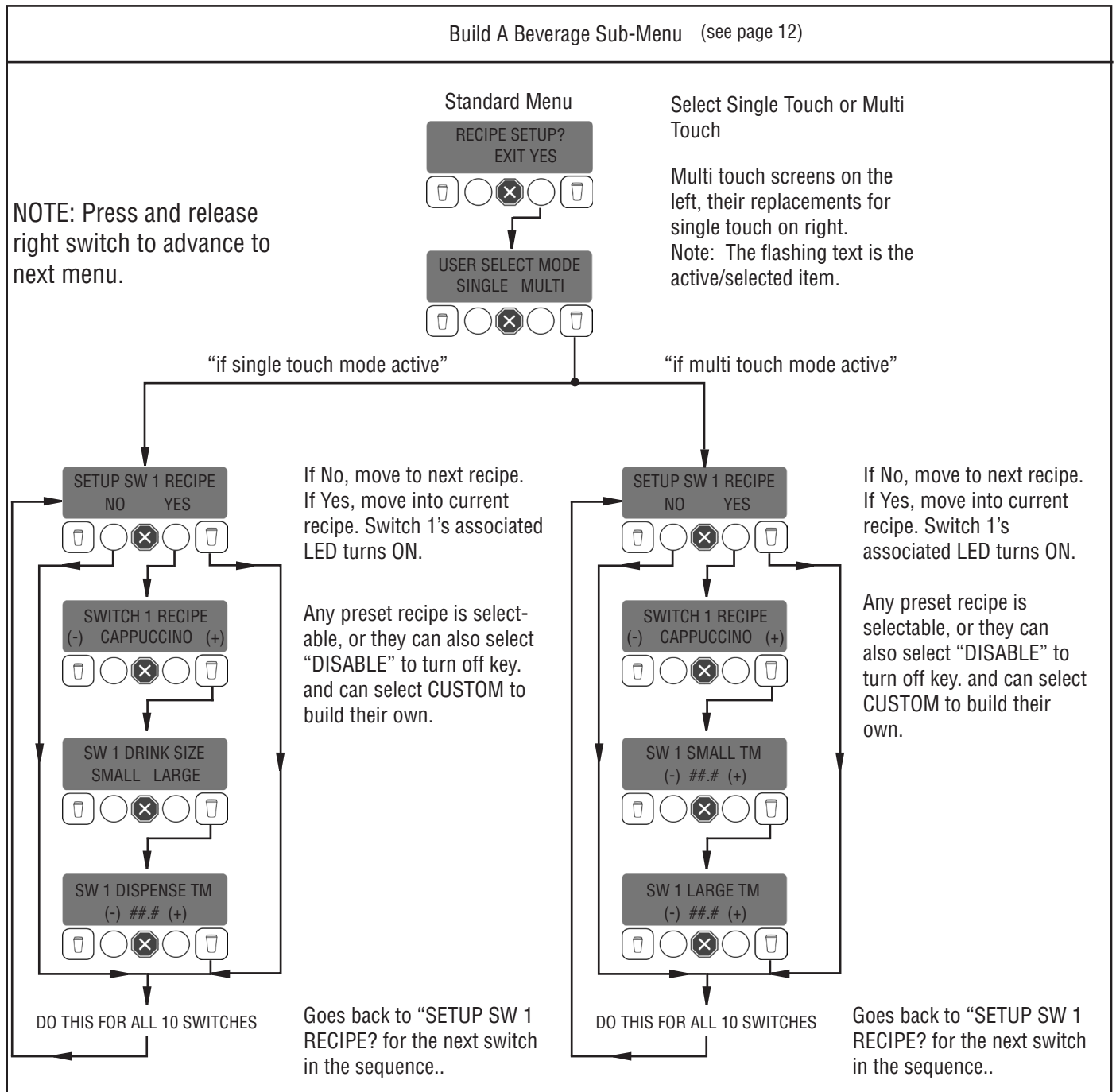

(continued on next page)

# PROGRAMMING MENU'S (cont.) - Build A Beverage - Custom Beverage

Build A Beverage Sub-Menu (continued) (see page 12)

## Build A Beverage



Select Single Touch or Multi Touch



Multi touch screens on the left, their replacements for single touch on right.

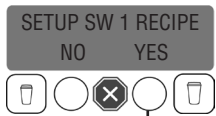

Optional way to skip past a lengthy setup process. Switch 1's associated LED turns on.



Recipe 1 thru 10 selectable can also select "Disable" to turn off key.



This picks the shot size for single touch as well as for the cup count.

NOTE: Press and release right switch to advance to next menu.

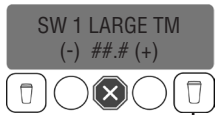

Dispense time cannot be set below minimum time (ie. 5.0 sec.)

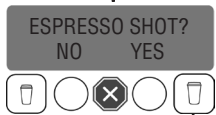

Does beverage need an espresso shot? If YES, it will use the corresponding size set for single touch or for the size button selected in Multi.

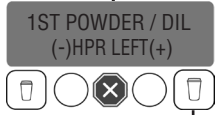

Options are for three hoppers or dilution. Cannot choose "NONE" here as if wanting an espresso, only can pick that from the "Switch # Recipe" screen. This option comes up as the first item from Left to Right of a Multi-ingredient drink when reloaded.

← Used for 1st ingredient selection

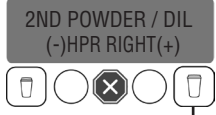

Items selected on the previous screen are not available on this one, however, the option for "None" is now available.

← Used for 2nd ingredient selection



This option is available if two items have been selected, the value must be between 15% and 85%. The second item will be 100% minus value of item one.

← Used for selecting portion of 1st ingredient selection

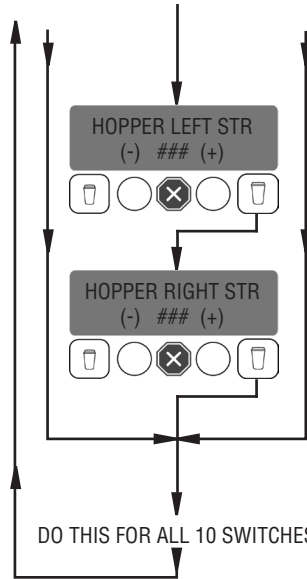

Note: 1st ingredient speed can be from 15 to 100 RPM, however, would not appear if dilution was selected.

Note: 2nd ingredient speed can be from 15 to 100 RPM, however, would not appear if dilution was selected.

Goes back to "Setup SW 1 Recipe?" for the next switch in the sequence

