



IMIX[®]-14



INSTALLATION & OPERATING GUIDE

BUNN-O-MATIC CORPORATION

POST OFFICE BOX 3227

SPRINGFIELD, ILLINOIS 62708-3227

PHONE: (217) 529-6601 FAX: (217) 529-6644

To ensure you have the latest revision of the Operating Manual, or to view the Illustrated Parts Catalog, Programming Manual, or Service Manual, please visit the Bunn-O-Matic website, at www.bunn.com. This is absolutely FREE, and the quickest way to obtain the latest catalog and manual updates. For Technical Service, contact Bunn-O-Matic Corporation at 1-800-286-6070.



BUNN-O-MATIC COMMERCIAL PRODUCT WARRANTY

Bunn-O-Matic Corp. ("BUNN") warrants equipment manufactured by it as follows:

- 1) Airpots, thermal carafes, decanters, GPR servers, iced tea/coffee dispensers, MCR/MCP/MCA single cup brewers, thermal servers and ThermoFresh® servers (mechanical and digital) 1 year parts and 1 year labor.
- 2) All other equipment - 2 years parts and 1 year labor plus added warranties as specified below:
 - a) Electronic circuit and/or control boards - parts and labor for 3 years.
 - b) Compressors on refrigeration equipment - 5 years parts and 1 year labor.
 - c) Grinding burrs on coffee grinding equipment to grind coffee to meet original factory screen sieve analysis - parts and labor for 4 years or 40,000 pounds of coffee, whichever comes first.

These warranty periods run from the date of installation BUNN warrants that the equipment manufactured by it will be commercially free of defects in material and workmanship existing at the time of manufacture and appearing within the applicable warranty period. This warranty does not apply to any equipment, component or part that was not manufactured by BUNN or that, in BUNN's judgment, has been affected by misuse, neglect, alteration, improper installation or operation, improper maintenance or repair, non periodic cleaning and descaling, equipment failures related to poor water quality, damage or casualty. In addition, the warranty does not apply to replacement of items subject to normal use including but not limited to user replaceable parts such as seals and gaskets. This warranty is conditioned on the Buyer 1) giving BUNN prompt notice of any claim to be made under this warranty by telephone at (217) 529-6601 or by writing to Post Office Box 3227, Springfield, Illinois 62708-3227; 2) if requested by BUNN, shipping the defective equipment prepaid to an authorized BUNN service location; and 3) receiving prior authorization from BUNN that the defective equipment is under warranty.

THE FOREGOING WARRANTY IS EXCLUSIVE AND IS IN LIEU OF ANY OTHER WARRANTY, WRITTEN OR ORAL, EXPRESS OR IMPLIED, INCLUDING, BUT NOT LIMITED TO, ANY IMPLIED WARRANTY OF EITHER MERCHANTABILITY OR FITNESS FOR A PARTICULAR PURPOSE. The agents, dealers or employees of BUNN are not authorized to make modifications to this warranty or to make additional warranties that are binding on BUNN. Accordingly, statements by such individuals, whether oral or written, do not constitute warranties and should not be relied upon.

If BUNN determines in its sole discretion that the equipment does not conform to the warranty, BUNN, at its exclusive option while the equipment is under warranty, shall either 1) provide at no charge replacement parts and/or labor (during the applicable parts and labor warranty periods specified above) to repair the defective components, provided that this repair is done by a BUNN Authorized Service Representative; or 2) shall replace the equipment or refund the purchase price for the equipment.

THE BUYER'S REMEDY AGAINST BUNN FOR THE BREACH OF ANY OBLIGATION ARISING OUT OF THE SALE OF THIS EQUIPMENT, WHETHER DERIVED FROM WARRANTY OR OTHERWISE, SHALL BE LIMITED, AT BUNN'S SOLE OPTION AS SPECIFIED HEREIN, TO REPAIR, REPLACEMENT OR REFUND.

In no event shall BUNN be liable for any other damage or loss, including, but not limited to, lost profits, lost sales, loss of use of equipment, claims of Buyer's customers, cost of capital, cost of down time, cost of substitute equipment, facilities or services, or any other special, incidental or consequential damages.

392, A Partner You Can Count On, Air Infusion, AutoPOD, AXIOM, BrewLOGIC, BrewMETER, Brew Better Not Bitter, BrewWISE, BrewWIZARD, BUNN Espresso, BUNN Family Gourmet, BUNN Gourmet, BUNN Pour-O-Matic, BUNN, BUNN with the stylized red line, BUNNlink, Bunn-O-Matic, Bunn-O-Matic, BUNNserve, BUNNSERVE with the stylized wrench design, Cool Froth, DBC, Dr. Brew stylized Dr. design, Dual, Easy Pour, EasyClear, EasyGard, FlavorGard, Gourmet Ice, Gourmet Juice, High Intensity, iMIX, Infusion Series, Intellisteam, My Café, Phase Brew, PowerLogic, Quality Beverage Equipment Worldwide, Respect Earth, Respect Earth with the stylized leaf and coffee cherry design, Safety-Fresh, savemycoffee.com, Scale-Pro, Silver Series, Single, Smart Funnel, Smart Hopper, SmartWAVE, Soft Heat, SplashGard, The Mark of Quality in Beverage Equipment Worldwide, ThermoFresh, Titan, trifacta, TRIFECTA (stylized logo), Velocity Brew, Air Brew, Beverage Bar Creator, Beverage Profit Calculator, Brew better, not bitter., Build-A-Drink, BUNNSource, Coffee At Its Best, Cyclonic Heating System, Daypart, Digital Brewer Control, Element, Milk Texturing Fusion, Nothing Brews Like a BUNN, Picture Prompted Cleaning, Pouring Profits, Signature Series, Sure Tamp, Tea At Its Best, The Horizontal Red Line, Ultra are either trademarks or registered trademarks of Bunn-O-Matic Corporation. The commercial trifacta® brewer housing configuration is a trademark of Bunn-O-Matic Corporation.

INTRODUCTION

This equipment dispenses hot beverages or soups on demand from powdered product. It is indoor use only on a sturdy counter or shelf.

USER NOTICES

The notices on this dispenser should be kept in good condition. Replace unreadable or damaged labels.



00986.0000



00824.0002

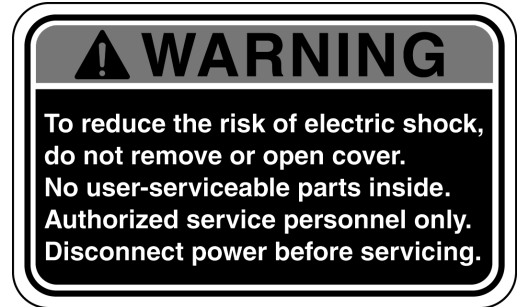

37881.0000

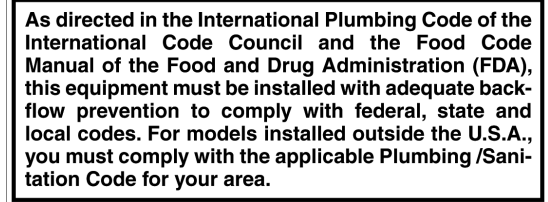

00656.0001



44998.0000

INITIAL SET-UP

1. Apply the four non-skid pads from the parts box to the bottom of the legs.
2. Remove the drip tray assembly, drip tray bracket, and splash panel assembly from the parts box.
3. Place a set of key holes in the drip tray bracket over the lower two screws in the panel below the hopper access door; push down gently and tighten screws.
4. Place the set of keyholes in the splash panel over the upper two screws and position so the screws are between the holes.

DOOR COVER INSTALLATION



1. Remove tape holding wiring harness to door inner panel.

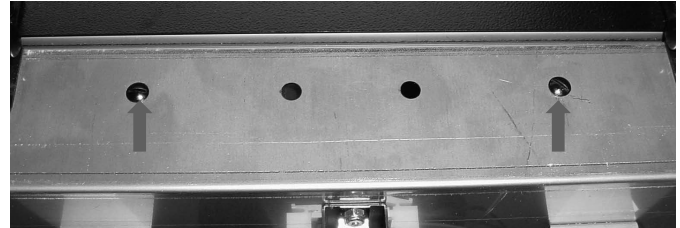

2. Remove six 8-32 black truss head screws from top and bottom of door inner panel, set aside and save.
3. Remove door cover from box in packaging, and carefully slip over inner metal door. Fasten door cover with six screws removed in step 2, four in the bottom, two in the top.

DOOR COVER INSTALLATION (Continued)

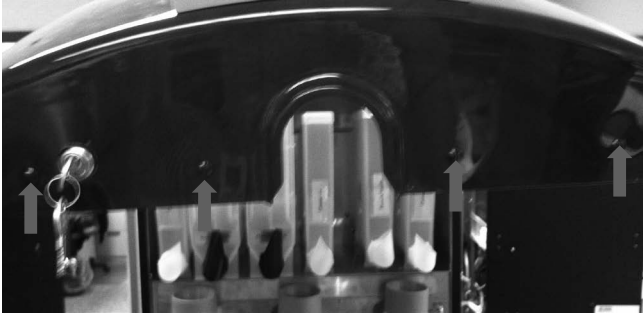

4. With door in raised position, remove four screws and remove inner access panel. Pull door inter-connect wiring through access hole.



5. Connect black four pin connectors. Connectors are keyed, and latch must engage hook.

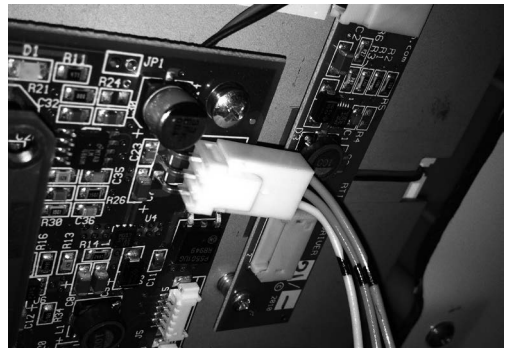

6. Connect three pin connector to rear of the display.

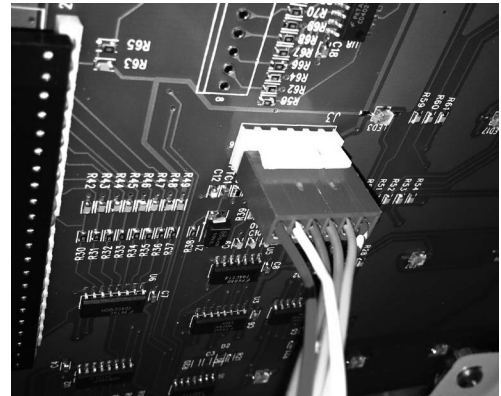

7. Connect six pin connector to the rear of lower circuit board.
8. Replace inner access panel and screws removed in step 4.

CE REQUIREMENTS

- This appliance must be installed in locations where it can be overseen by trained personnel.
- For proper operation, this appliance must be installed where the temperature is between 5°C to 35°C.
- Appliance shall not be tilted more than 10° for safe operation.
- An electrician must provide electrical service as specified in conformance with all local and national codes.
- This appliance must not be cleaned by water jet.
- This appliance can be used by persons aged from 18 years and above if they have been given supervision or instruction concerning use of the appliance in a safe way and if they understand the hazards involved.
- Keep the appliance and its cord out of reach of children aged less than 18 years.
- Appliances can be used by persons 18 years and above with reduced physical, sensory or mental capabilities or lack of experience and knowledge if they have been given supervision or instruction concerning use of the appliance in a safe way and understand the hazards involved.
- Children under the age of 18 years should be supervised to ensure they do not play with the appliance.
- If the power cord is ever damaged, it must be replaced by the manufacturer or authorized service personnel with a special cord available from the manufacturer or its authorized service personnel in order to avoid a hazard.
- Machine must not be immersed for cleaning.
- Cleaning and user maintenance shall not be made by children unless they are older than 18 years and supervised.
- This appliance is intended to be used in household and similar applications such as:
 - staff kitchen areas in shops, offices and other working environments;
 - by clients in hotels, motels and other residential type environments;
 - bed and breakfast type environments.
- This appliance not intended to be used in applications such as:
 - farm houses;
- Access to the service areas permitted by Authorized Service personnel only.
- The A-Weighted sound pressure level is below 70 dBA.

NORTH AMERICAN REQUIREMENTS

- This appliance must be installed in locations where it can be overseen by trained personnel.
- For proper operation, this appliance must be installed where the temperature is between 41°F to 95°F (5°C to 35°C).
- Appliance shall not be tilted more than 10° for safe operation.
- An electrician must provide electrical service as specified in conformance with all local and national codes.
- This appliance must not be cleaned by pressure washer.
- This appliance can be used by persons aged from 18 years and above if they have been given supervision or instruction concerning use of the appliance in a safe way and if they understand the hazards involved.
- Keep the appliance and its cord out of reach of children aged less than 18 years.
- Appliances can be used by persons 18 years and above with reduced physical, sensory or mental capabilities or lack of experience and knowledge if they have been given supervision or instruction concerning use of the appliance in a safe way and understand the hazards involved.
- Children under the age of 18 years should be supervised to ensure they do not play with the appliance.
- If the power cord is ever damaged, it must be replaced by the manufacturer or authorized service personnel with a special cord available from the manufacturer or its authorized service personnel in order to avoid a hazard.
- Machine must not be immersed for cleaning.
- Cleaning and user maintenance shall not be made by children unless they are older than 18 years and supervised.
- This appliance is intended for commercial use in applications such as:
 - staff kitchen areas in shops, offices and other working environments;
 - by clients in hotel and motel lobbies and other similar types of environments;
- Access to the service areas permitted by Authorized Service personnel only.

ELECTRICAL REQUIREMENTS

WARNING - If the power cord is ever damaged, it must be replaced by the manufacturer or its service agent with a special cord available from the manufacturer or its service agent in order to avoid a hazard.

CAUTION - The dispenser must be disconnected from the power source until specified in *Electrical Hook-Up*. The 120 volt version of this dispenser has an attached cordset. The mating connector must be a NEMA 5-15R.

Refer to the dispenser's dataplate for exact voltage requirements.

To access terminal block for high voltage models without a cord set, remove left side panel.

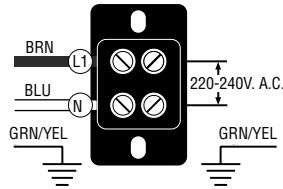

**220-240V AC
single phase models**

Note: This electrical service consists of 2 current carrying conductors (L1 and N) and a separate conductor for earth ground.

ELECTRICAL HOOK-UP

CAUTION – Improper electrical installation will damage electronic components.

1. An electrician must provide electrical service as specified.
2. Using a voltmeter, check the voltage and color coding of each conductor at the electrical source.
3. Place the ON/OFF/NIGHT switch in the “ON” position.
4. Connect the dispenser to the power source.
5. If plumbing is to be hooked-up later be sure the dispenser is disconnected from the power source. If plumbing has been hooked-up, the dispenser is ready for *Initial Fill & Heat*.

PLUMBING REQUIREMENTS

This dispenser must be connected to a cold water system with operating pressure between 20 and 90 psi from a 1/2" or larger supply line. A shut-off valve should be installed in the line before the dispenser. Install a regulator in the line when pressure is greater than 90 psi to reduce it to 50 psi. The water inlet fitting is 1/4" flare.

NOTE - Bunn-O-Matic recommends 1/4" copper tubing for installations of less than 25 feet and 3/8" for more than 25 feet from the 1/2" water supply line. At least 18 inches of an FDA approved flexible beverage tubing, such as reinforced braided polyethylene or silicone, before the dispenser will facilitate movement to clean the countertop. Bunn-O-Matic does not recommend the use of a saddle valve to install the dispenser. The size and shape of the hole made in the supply line by this type of device may restrict water flow.

NOTE - If a backflow preventer is required by code, a shock arrestor should be installed between backflow preventer and dispenser. Installing the shock arrestor as close to the dispenser as possible will provide the best results.

As directed in the International Plumbing Code of the International Code Council and the Food Code Manual of the Food and Drug Administration (FDA), this equipment must be installed with adequate backflow prevention to comply with federal, state and local codes. For models installed outside the U.S.A., you must comply with the applicable Plumbing /Sanitation Code for your area.

PLUMBING HOOK-UP

1. Flush the water line and securely attach it to the elbow fitting on the bottom of the dispenser.
2. Turn-on the water supply.

NOTE - Water pipe connections and fixtures directly connected to a potable water supply shall be sized, installed and maintained in accordance with federal, state and local codes.

INITIAL FILL & HEAT

1. Turn on the water supply and connect the dispenser to the power source.
2. Water will automatically flow into the tank to the proper level and then shut-off. This will take less than ten minutes.
3. When the tank is full of water, open the front door and place the ON/OFF/NIGHT switch in the “ON” (upper) position. A tank full of cold water will take approximately eighty minutes for the water to heat on 120 volt versions.
4. Fill the six hoppers with the dry product to be dispensed. From left to right:
 - 1 – French Vanilla flavoring
 - 2 – Cappuccino
 - 3 – Limited Time Offer
 - 4 – Hot Chocolate
 - 5 – Steamed Milk
 - 6 – Caramel flavoring

PRESET TANK TEMPERATURE

Tank temperatures have been preset at the factory to 180°F (82°C). Bunn recommends that to provide the best quality beverage, the installer adjust the tank temperature to the powder product manufacturer’s recommended temperature for the hot powder product being used.

LIQUID LEVEL CONTROL

The system automatically maintains the hot water tank’s level by energizing the refill solenoid when the water level drops below the liquid level probe. If the system has not successfully refilled in 10 minutes, a refill error occurs. When a refill error occurs, the refill solenoid is de-energized. Once the cause of the refill error has been investigated and cured, the system can be reset by either disconnecting (for at least 5 seconds) and then reconnecting the power to the machine, or by entering one of the program modes (see Programming Modes).

RINSE TIMER

The dispenser is shipped from the factory with the rinse timer disabled. To enable the rinse timer, refer to *Programming the Dispenser* and select yes in the “Rinse Alarm?” screen; set timer to the desired time and exit the programming mode.

When enabled, the rinse timer automatically keeps track of the time since the dispenser was last run through a rinse sequence. If the dispenser detects that a rinse sequence has not been run for the desired time, a message will appear on the LCD display. If the Lockout is set, after an additional 4 hours, a rinse cycle has still not been run, the LCD display will display a message, and the hopper drives will be disabled until a rinse sequence has been run.

LOW POWDER LOCKOUT

The dispenser has a low powder lockout for the steamer hopper. After a “low” powder condition is detected in the hopper, the dispenser will allow a fixed number of auger turns of the steamer hopper before the hopper is considered empty. When an empty hopper condition is reached, dispensing of any beverages containing steamer powder will be locked out. The threshold for detecting a low powder condition, and the number of auger turns after a low condition is detected, can be adjusted in the “CALIBRATION?” section of the programming menus.

RUNNING A RINSE SEQUENCE

1. Place the Normal/Program/Rinse switch in the “Rinse” position.
2. Place a large container under the dispense nozzle. Press any dispense switch. The unit will rinse for ten seconds, and then stop. Release the dispense switch.
3. After rinsing, return the Normal/Program/Rinse switch to the “Normal” position.

DISPENSER USE

1. Simply place a cup on the drip tray beneath the dispense nozzle.
2. Press and hold any dispense button for the desired beverage.
3. Release the dispense button when the cup is 2/3 full.

POWDER PRODUCT STRENGTH ADJUSTMENT

The strength of the individual powdered beverages can be adjusted by changing the hopper motor speed. See menus under “DRINK STRENGTH #” in the program menus to adjust the hopper dispense rate for each hopper.

DRAINING THE HOT WATER TANK

CAUTION - The dispenser must be disconnected from the power source throughout these steps

1. Disconnect the dispenser from the power source.
2. Open front door and place ON/OFF/NIGHT switch in the “OFF” (center) position and let the water in the tank cool before draining.
3. Shut off and disconnect the incoming water supply.
4. Remove the drip tray and access panels below the door.
5. Pull the clamped end of the silicone tube out of the dispenser and direct it into a drain or a container large enough to hold the volume of water in the tank, 7.2 gallons.
6. Make certain the shut off clamp is locked tightly on the tube, and then remove the snap type clamp and plug from end of tube.
7. Carefully release the shut off clamp to let the water drain from the tank.

NOTE - The dispenser must be refilled using the *INITIAL FILL & HEAT* steps before reconnecting to the power source.

PREVENTIVE MAINTENANCE

Bunn-O-Matic® Corporation recommends that preventive maintenance be performed at regular intervals. Maintenance should be performed by a qualified service technician. For Technical Service, contact Bunn-O-Matic® Corporation at 1-800-286-6070.

NOTE: Replacement parts or service caused by failure to perform required maintenance is not covered by warranty.

Touchscreen special cleaning instructions:

- Use a soft lint-free cloth. The 3M Microfiber Lens Cleaning Cloth is especially recommended for cleaning touch panels without requiring liquid cleaner.
- The cloth may be used dry, or lightly dampened with a mild cleaner or Ethanol.
- Be sure the cloth is only lightly dampened, not wet. Never apply cleaner directly to touch panel surface; if cleaner is spilled onto touch panel, soak it up immediately with absorbent cloth.
- Cleaner must be neither acid nor alkali (neutral pH).
- Wipe the surface gently; if there is a directional surface texture, wipe in the same direction as the texture.
- Never use acidic or alkaline cleaners, or organic chemicals such as: paint thinner, acetone, toluene, xylene, propyl or isopropyl alcohol, or kerosene.
- Suitable cleaning products are commercially available pre-packaged for use; one example of such a product is Klear Screen™ <http://www.nushield.com/products_main_klear.htm>, or commercially available off-the shelf retail brands such as Glass Plus® Glass and Surface Cleaner made by Reckitt-Benckiser <<http://www.glassplus.com/>>.
- Use of incorrect cleaners can result in optical impairment of touch panel and/or damage to functionality.

NOTE: Most products contain 1-3% Isopropyl Alcohol by volume, which is within acceptable limits for Resis-tive Touch Panel cleaning use.

CAUTION: Many products contain Ammonia, Phosphates, and/or Ethylene Glycol, which are NOT ACCEPT-ABLE; check product content label carefully.

CLEANING

The use of a damp cloth rinsed in any mild, non-abrasive, liquid detergent is recommended for cleaning all surfaces on Bunn-O-Matic equipment. Do **NOT** clean this equipment with a water jet device.



1 x 24h

BUNN®

1. Rinse out Whipper Chambers by placing the NORMAL/PROGRAM/RINSE switch in the "RINSE" position and activating DISPENSE switches.
2. Turn elbow up, remove Hoppers, refill with product and replace hoppers into dispenser.
3. Empty Drip Tray and wash in a solution of dish detergent.

1. Para limpiar las camaras de mezcla, coloque el interruptor en la posición NORMAL/PROGRAMA/ENJUAGUE ("NORMAL/PROGRAM/RINSE") y pulse el botón para espumar y distribuir la bebida ("DISPENSE").
2. Gire el codo hacia arriba, remueva las tolvas, llene las tolvas con producto y coloque las tolvas nuevamente en la maquina.
3. Vacie la bandeja de goteo y limpiela con un detergente liquido suave no abrasivo.

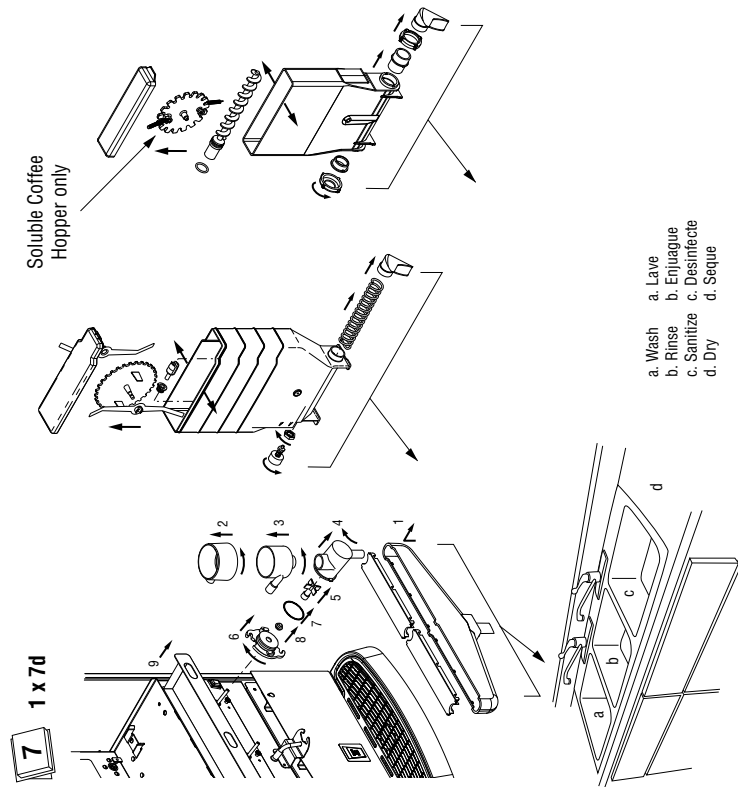

NOTICE:
The cleaning instructions noted above are for non-dairy sugar based food products. When dispensing any other food product, the cleaning cycle for the whipping chamber assembly and ejector elbow must be performed daily.

NOTA:
Las instrucciones de limpieza descritas anteriormente excluyen productos lacteos azucarados. La limpieza de las camaras de mezcla y de los codos de salida de cada tolva deberá realizarse diariamente.

44990.0000A 08/11 © 2011 BUNN-O-MATIC CORPORATION

PROGRAMMING THE DISPENSER

The following function screens are in order of appearance. Each screen will have instructions on how to access, and the procedures to program the various functions of the dispenser. To enable programming, place the NORMAL/PROGRAM/RINSE” switch in the “PROGRAM” position.

IMPORTANT PROGRAMMING NOTES - READ CAREFULLY

To exit the programming mode at any time, press and release the exit (center) switch located on the front touch screen. The display will return to the **PROGRAM HOME SCREEN**.

Open the front door to access the two mode switches:

1. **ON/OFF/NIGHT switch:**

ON: Enables all dispenser functions.

OFF: Disables all dispenser functions.

NIGHT: Disables all dispense switches. Tank refill and heating still functions.

2. **NORMAL/PROGRAM/RINSE switch:**

NORMAL: Allows all dispenser functions. Must be in this position for dispensing.

PROGRAM: Allows access to program menus using touch screen on the front door.

RINSE: Disables hopper motors. Pressing dispense button on the front door will dispense dilution water and power the whipper motors for 10 seconds.

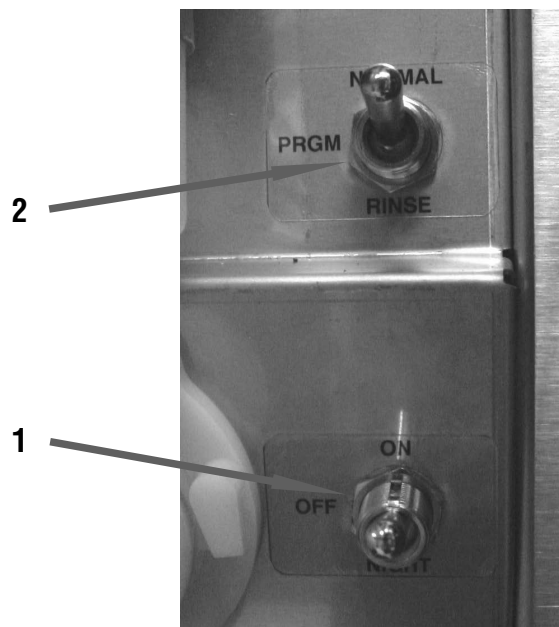

PROGRAMMING THE DISPENSER (Cont.)

BEVERAGES

The IMIX-14 unit has 15 dispense switches.

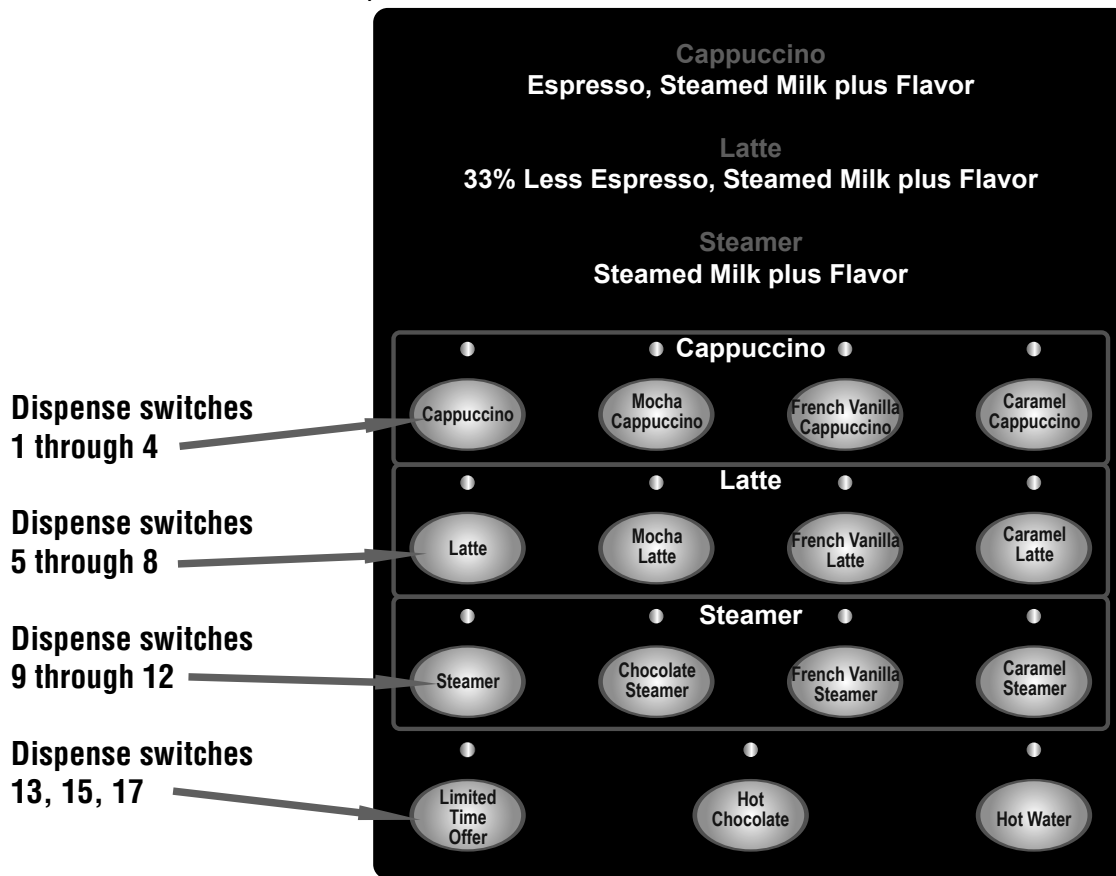

PROGRAMMING SWITCHES

Using the menu-driven display (Touch Screen) on the front of the dispenser, the operator has the ability to alter or modify various functions of the dispenser. This allows for precise dispensing of various flavors of products.

Programming of the dispenser is achieved by entering a certain function, then, by use of programming switches, the operator can customize the dispensing process to their specifications.

To access the programming mode, and to scroll through different function screens, the programming switches shown are used. There are five switches that will be used for setup of the dispenser.

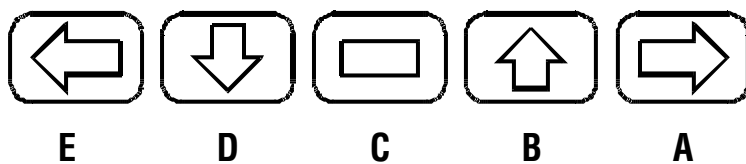

- A. Enter program mode and advance to next menu
- B. Increment display value positive
- C. Exit program mode
- D. Increment display value negative
- E. Return to previous menu

Using the menu-driven display (TOUCH SCREEN) on the front of dispenser, the operator has the ability to alter or modify various functions of the dispenser. This allows for precise dispensing of various flavors of products.

Programming of dispenser is achieved by entering a certain function, then, by use of programming switches, the operator can customize the dispensing process to their specifications.

To access the programming mode, and to scroll through different function screens, the programming switches shown are used. There are five switches that will be used for setup of the dispenser.

PROGRAMMING THE DISPENSER (Cont.)

GLOSSARY

Put "NORMAL/PROGRAM/RINSE" switch into "PROGRAM" position to access program menus.

TANK TEMP ###° (-) EXIT (+)	Adjust tank temperature (190° F maximum)	DISPENSE LOCKOUT NO EXIT YES	Enables lockout of dispensing if below minimum water temperature
READY TEMP ###° (-) EXIT (+)	Adjust minimum tank ready temper- ature for lockout (185° maximum)	RINSE ALARM ? NO EXIT YES	Enables rinse alarm
DRINK STRENGTH 1 (-) ## (+)	Adjust hopper motor speed for hopper 1. ## indicates hopper rpm	AUDIBLE ALARM? NO EXIT YES	Turns on audio alarm
ENTER PASSWORD (-) 0 (+)	If password is set, requires entering password to access remainder of menus	ENABLE SERVICE # NO EXIT YES	Enables service number to be displayed on door display
###° CAL ###° (-) tank temp (+)	Calibrate temperature probe	ENTER ASSET # ? NO EXIT YES	Enter asset number of machine
235 REFILL 155 (-) EXIT (+)	Set refill probe threshold	ENABLE SERVICE # NO EXIT YES	Enables service agent telephone num- ber to be displayed on door display
TEST POWDER #? PRESS DISPENSE	Runs auger motor (1 thru 6) at programmed speed for 10 seconds to check throw rate	TEST SWITCHES ? Use Switch To Test	Allows testing of dispense switches
TEST WATER #? PRESS DISPENSE	Opens water dispense valve (1 thru 4) for 20 seconds to test flow rate	TEST HEATER ? EXIT YES	Allows manually activating tank heater
AUGER DELAY (-) .## sec (+)	Set delay start of hopper after dilution valve opens in station selected	TEST REFILL ? EXIT YES	Allows manually activating refill valve
DILUTION DELAY (-) ### sec (+)	Set delay start of dilution water valve for single product beverages	TEST HOT WATER ? EXIT YES	Allows manually activating hot water valve
### POWDER 155 (-) EXIT (+)	Set low powder detect threshold	TEST AUGERS ? DISPENSE TO TEST	Allows manually activating hopper motors
SET TO EMPTY (-) 100 REVS (+)	Set number of Auger turns after low level detected until hopper empty	TEST WHIPPERS ? DISPENSE TO TEST	Allows manually activating whipper motors
SET PASSWORD ? NO EXIT YES	Allows password to be set to prevent altering setup functions	TEST DISP VALVES DISPENSE TO TEST	Allows manually activating dispense valves

PROGRAMMING THE DISPENSER (Cont.)

Press and release right switch (advance to next screen), "TANK TEMP ###°" appears on screen.

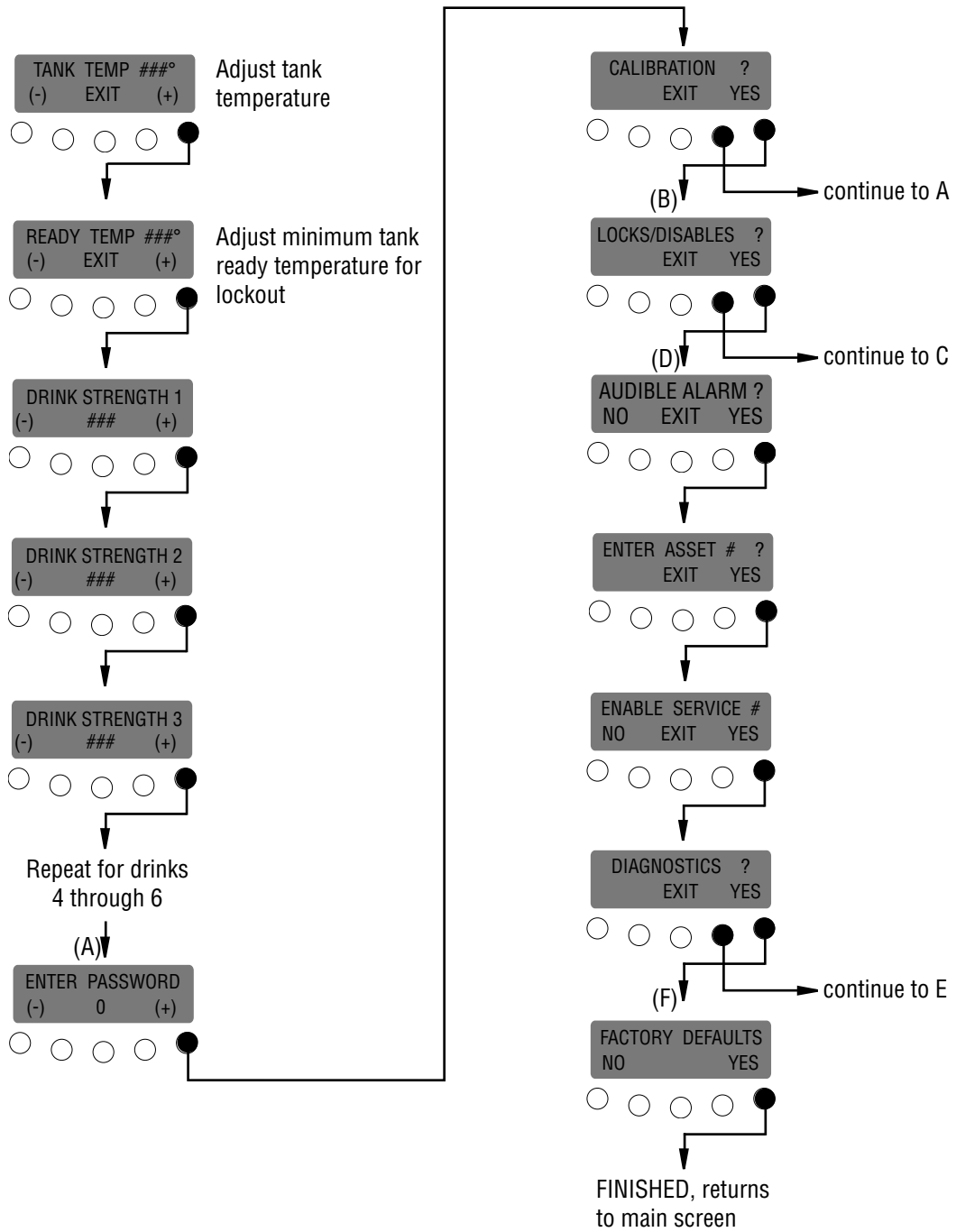

PROGRAMMING THE DISPENSER (Cont.)

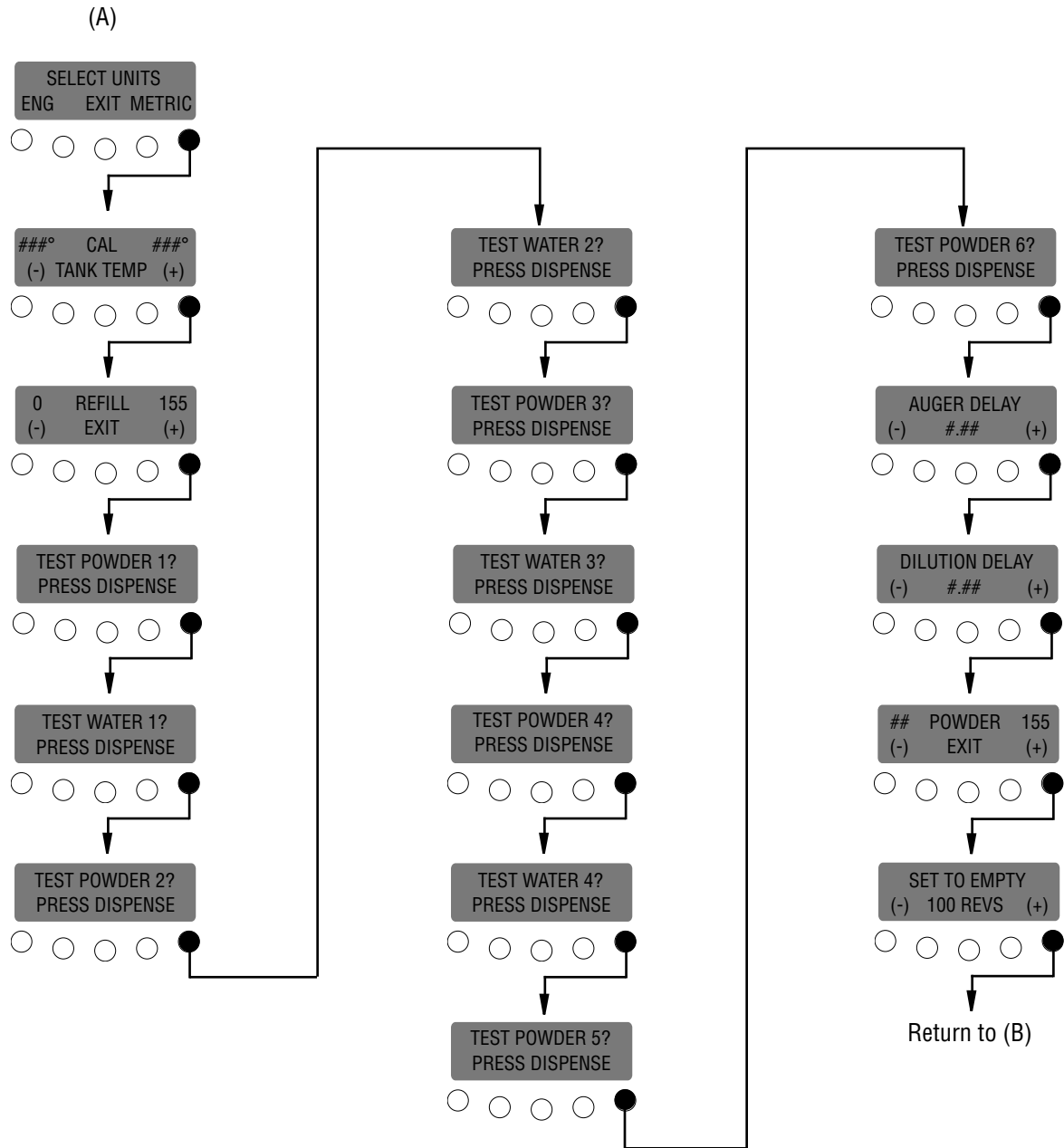

PROGRAMMING THE DISPENSER (Cont.)

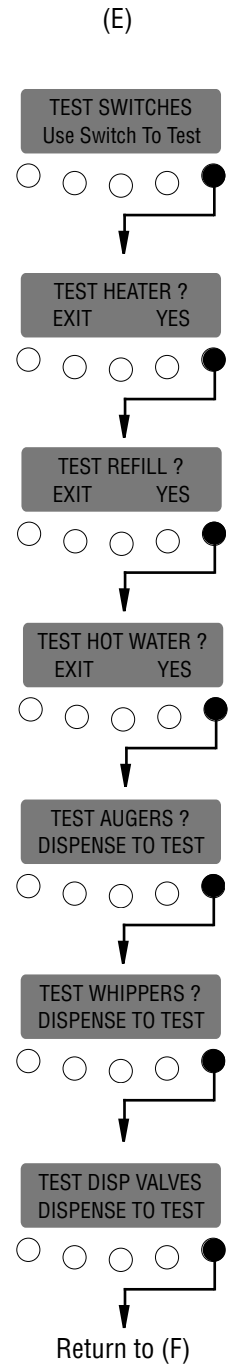
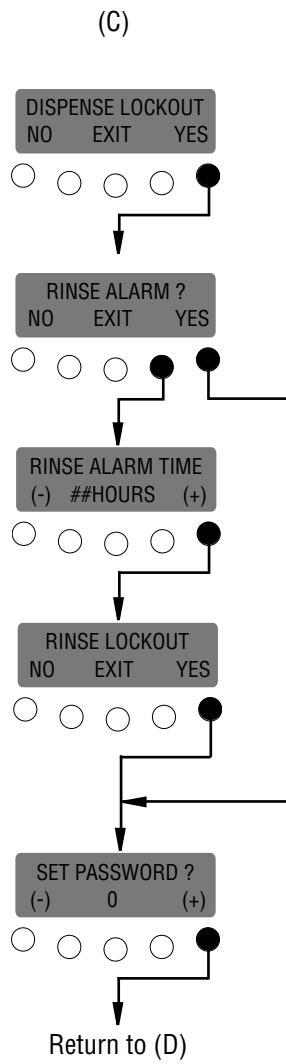

SCHEMATIC WIRING DIAGRAM IMIX-14

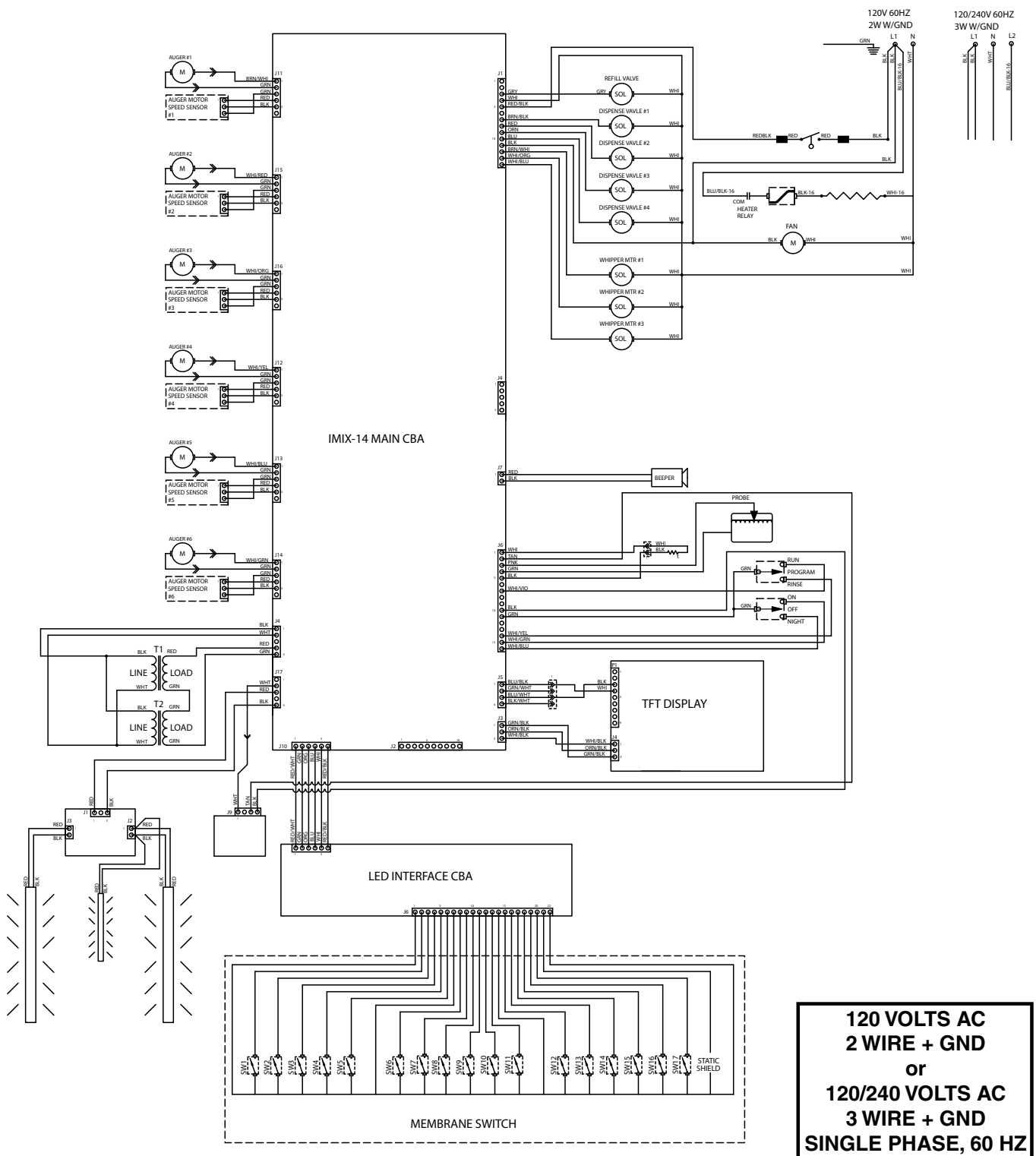

**120 VOLTS AC
2 WIRE + GND
or
120/240 VOLTS AC
3 WIRE + GND
SINGLE PHASE, 60 HZ**