

Operators Manual

Use and Care Instructions Dual Gas Steam Generator & Convection Steamer



Series: Gemini Model Nos. 24CGA6.2, 24CGA10.2

1333 East 179th Street
Cleveland, Ohio 44110

Phone: (216) 481-4900
Fax: (216) 481 3782

 **Cleveland**

Part No. **GEMINI-OPM B 7/02**

FOR THE USER

FOR YOUR SAFETY

Do not store or use gasoline or other flammable vapors or liquids in the vicinity of this or any other appliance.

WARNING

Disconnect power before servicing

WARNING:

Improper installation, adjustment, alterations, service or maintenance can cause property damage, injury or death. Read the installation, operating and maintenance instructions thoroughly before installing or servicing this equipment.

IMPORTANT

IT IS IMPORTANT TO POST INSTRUCTIONS WHICH ARE TO BE FOLLOWED IN THE EVENT THE USER SMELLS GAS. THESE INSTRUCTIONS SHOULD BE LOCATED IN A PROMINENT LOCATION, AND BE FULLY UNDERSTOOD BY ALL USERS OF THIS EQUIPMENT. THIS INFORMATION SHOULD BE OBTAINED FROM YOUR LOCAL GAS SUPPLIER.

ALL SERVICE MUST BE PERFORMED BY A QUALIFIED CLEVELAND RANGE AUTHORIZED TECHNICIAN.

RETAIN THIS MANUAL FOR YOUR REFERENCE

OPERATORS MANUAL
Gemini Dual Gas Steam Generator and Convection Steamer
Table of Contents

Chapter	Page
CHAPTER 1 INTRODUCTION	1
A. GAS LEAK INSTRUCTIONS	1
B. OPERATIONAL SAFETY	1
CHAPTER 2 GENERAL OPERATION	3
A. MAIN EXTERNAL POWER SWITCH	3
B. DOOR INTERLOCK SWITCH	3
C. POWER ON (AUTOMATIC FILL)	3
D. LIGHTING AND SHUTDOWN INSTRUCTIONS	4
E. INSPECTING THE COOKING COMPARTMENT	4
F. PREHEATING THE STEAMER	5
G. DESCALING REQUIRED LIGHT FEATURE	5
CHAPTER 3 CONTROL PANELS	6
A. DIAL TIMER CONTROL PANEL	6
1. Cooking Operations – Dial Timer Control Panel	6
2. Manual and Timed Mode	6
a. Manual Mode	6
b. Timed Mode	6
B. KEYPAD TIMER CONTROL PANEL	7
1. Cooking Operations – Keypad Timer Control Panel	7
2. Manual and Timed Modes	8
a. Manual Mode	9
b. Timed Mode and Use of the Timer	9
C. “INSTANT ON” CONTROL PANEL	10
1. Cooking Operations – “Instant ON” Control Panel	10
2. “Instant ON” Steamer Use	10
a. General Steamer Operation	10
b. Recommended Steamer Operation	10
CHAPTER 4 COOKING WITH THE STEAMER	11
A. OPERATING AND COOKING PROCEDURE – TIMED MODE	11
B. OPERATING AND COOKING PROCEDURE – MANUAL MODE	12
1. Using the Timer in Manual Mode	12
2. Manual Cooking Procedure	12
CHAPTER 5 SHUTDOWN AND CLEANING PROCEDURES	13
A. STEAM GENERATOR BLOWDOWN	13
1. Power Off (Automatic Blowdown)	13
2. Blowdown Frequency	14
3. Blowdown Procedure	14
B. SHUTDOWN AND CLEANING	14
CHAPTER 6 PREVENTATIVE MAINTENANCE AND TROUBLESHOOTING	16
A. MAINTENANCE	16
1. Maintenance Records	16
2. Daily Maintenance	16
3. Weekly Maintenance	16
4. Monthly/Weekly Maintenance Descale Steam Generator	17
B. OPERATOR’S TROUBLESHOOTING GUIDE	19

(Continued on Next Page)

(Table of Contents Continued)

Chapter	Page
CHAPTER 7 STEAM COOKING GUIDE	22
A. INTRODUCTION	22
B. SIZING UP PAN CAPACITY	23
1. Serving Sizes – How Much? How Many?	23
2. Reference Charts for Typical Pan Capacities	23
C. CONVECTION STEAMER – SUGGESTED TIMER SETTING GUIDELINES	24
D. STEAMING TIPS -LOBSTER -CRAB -SHRIMP	26
1. Live lobsters and Crabs	26
2. Lobster Tail 8 oz.	26
3. King Crab Legs	26
4. Shrimp	26

CHAPTER 1 INTRODUCTION

To use a Gemini gas steamer safely and effectively, each operator must read and understand this Chapter completely before starting operation. The owner(s) and operator(s) of the steamer should retain these instructions in an easily accessible location for future reference and training.

The owner(s) and operator(s) of the steamer must be aware that steam can cause serious injuries and equipment damage. Pay particular attention to the Operational Safety section of this chapter, and the WARNINGS and CAUTIONS displayed in this manual and on the equipment.

 WARNING
DO NOT ATTEMPT TO START OR OPERATE a Gemini steamer during a power outage. DEATH, INJURY, AND/OR EQUIPMENT DAMAGE could result from the improper installation of a steamer. Before starting a recently installed or repaired steamer, be sure it has been installed by qualified personnel according to the instructions found in the separate Installation and Maintenance Manual.

A. GAS LEAK INSTRUCTIONS

If the operator smells gas, or suspects there is a gas leak, he should immediately refer to the posted gas leak instructions. The posted instructions are provided by the local supplier and supersede any other instructions. Until the leak is stopped, observe the following precautions in addition to the posted instructions.

- Do not light or start any appliance.
- Do not touch any electrical switch.
- Do not use any phone in the building.
- Immediately call the gas supplier from a phone away from the building. Follow the gas supplier's instructions.
- If the gas supplier cannot be reached, call the fire department.

B. OPERATIONAL SAFETY

The safe and effective operation of any steamer depends upon proper installation, use, maintenance, and repair. Operational safety must encompass all of these factors. This Operational Safety section outlines the minimum safety policies that should be considered when using one or more Gemini steamers. It is assumed that any operational safety program must be tailored to the specific site and use of the equipment.

Burn hazards are present in any professional food service operation. When using the steamer, observe the following precautions.

- Remember at all times that steam can cause severe burns.
- When checking inside the steamer always open the door slowly and stand to the side and back away from the steamer. Water leaking from the door gasket can be a sign of a blocked drain. If the drain is blocked, hot water can accumulate inside the compartment and spill out when the door is opened.
- Open the door slightly to allow steam to vent before looking or reaching into cooking compartment.
- Do not reach into the cooking compartment until the steam has cleared.
- Do not reach into steamer or handle hot items without wearing heatproof gloves. Wet or damp gloves conduct heat, and may cause burns when touching hot items.

- Do not use anything but your hands to operate the ON/OFF levers/switches or any other control on the steamer.
- Do not block the vents on the side or rear of the unit or obstruct the flow of combustion and ventilation air to the steamer. Do not store articles on top of the unit.

The steamer requires a minimum of service if properly operated and maintained by trained personnel. The following steps will help keep the steamer in a safe, efficient operating condition.

1. Do not store or leave combustible materials near the steamer. Keep the area around and under the steamer free of combustible materials.
2. Non slip draining mats should be on the floor in front of the steamer to prevent slipping accidents from spilled water.
3. Train all personnel who will use the steamer. Make sure personnel know how to operate the steamer, clean the interior and exterior, drain the unit, and descale the steam generator.
4. This steamer may be equipped with a three-prong (grounding) plug for your protection against shock hazard and should be plugged directly into a properly grounded three-prong receptacle. Do not cut off or remove the grounding prong from the plug of a steamer equipped with an electrical cord.
5. Periodically inspect the flue of the steam generator for signs of sooting or blockage. Contact a Cleveland Range authorized service representatives to service the steamer if any improper operation of the burner system is suspected.
6. Operating personnel must be able to recognize problems, and report them so that corrective actions can be taken by trained personnel as outlined in the troubleshooting charts found in the back of this manual and in the separate Installation and Maintenance Manual.
7. Conduct regular steamer inspections. Check for water line leaks, door seal and drain leaks, clogged drain, steam generator scale buildup, and steamer control malfunctions.
8. Follow the instructions for steamer maintenance found in this manual and Chapter 3 of the Installation and Maintenance Manual.
9. Before each use of the steamer, inspect both compartments for drain and screen blockage. Inspect both door gasket assemblies, and all slide racks for proper installation and cleanliness.
10. Allow only Cleveland Range authorized service representatives to service the steamer.
11. Use only factory authorized repair parts.
12. Maintain written records of steamer maintenance and service. Each record should include at least:
 - The date of the service or maintenance.
 - A description of the service, maintenance or repair performed. Include part numbers if applicable.
 - Copies of purchase order(s) and invoice(s) for repair parts and service.
 - The name and signature of the person performing the maintenance or service.

CHAPTER 2 GENERAL OPERATION

A. MAIN EXTERNAL POWER SWITCH

Usually the steamers main power switch is left ON. If the main external power switch was left in the OFF position, turn it ON as follows.

1. Check that the water supply valves are open.
2. Turn the ON/OFF levers/switches counterclockwise to the OFF position.
3. The TIMED/MANUAL switch and timer settings are not important in this procedure. The control panel circuits are not powered while the ON/OFF levers/switch is set to OFF.
4. Refer to the main power switch in Figure 2-1, and turn on electric power to the steamer. The steam generators will immediately start blowdown cycles. The blowdown cycle lasts 3 minutes.

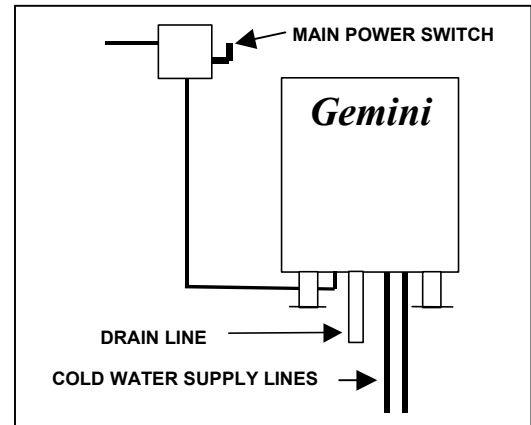

Figure 2-1 Main External Power Switch

B. DOOR INTERLOCK SWITCH

The steamer compartments of the Gemini Steamer are equipped with automatic steam cutoff switches, which turn OFF the production of steam to a cooking compartment whenever the door to that compartment is opened. **NOTE:** Even though the continued production of steam ends as soon as a door is opened, it may take up to a minute for residual steam in the system to clear from the steam lines and the cooking compartment. To avoid possible injury always wait until this residual steam has cleared before reaching into the cooking compartment.

C. POWER ON (AUTOMATIC FILL)

When each steamer compartment is turned ON, it automatically fills its steam generator with water. Use this procedure at the beginning of a shift to prepare the steamer for operation without starting steam generation. When ready to start steam cooking, begin either the Timed or Manual Operating Procedure.

1. Press the TIMED (top) end of the TIMED/MANUAL switch (for ON/OFF models set the selector switch to OFF..
2. Turn the ON/OFF lever/switch (see Figure 2-2 or 2-3), depending on model, clockwise to the ON position to energize the steamer control panel. The red indicator light on the control panel lights, the combustion blower turns ON to purge the generator and water fills the steam generator.

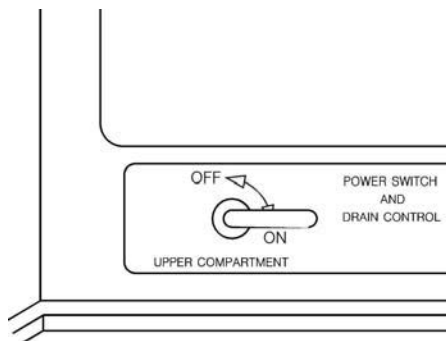

Figure 2-2 ON/OFF Lever
(Located below lower compartment)

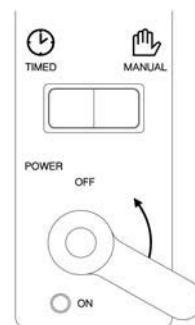

Figure 2-3 ON/OFF Switch
(Located on control panel)

NOTE: The ON/OFF lever/switch must be turned fully to the ON position to START the steamer.

3. When the generator is full, the steamer automatically stops water flow.
4. Once the water has reached the minimum operating level, the blower turns OFF and the pilot/standby burner lights to heat the water to the standby temperature.

D. LIGHTING AND SHUTDOWN INSTRUCTIONS

DO NOT TRY TO LIGHT THE BURNERS OR PILOT WITH A FLAME. THE PILOT AND BURNERS ARE SELF IGNITING.

The Gemini Steamer has an electronic ignition system, which automatically lights the pilot and burners, senses the flame and controls gas flow. This provides precise burner control, safety ignition, and shutdown.

 WARNING
DEATH, INJURY OR EQUIPMENT DAMAGE may result from an improperly adjusted gas control and ignition system. Do not alter any adjustments on this electronic control or gas valve. If adjustment is required, contact an authorized service center. Cleveland Range is in no way responsible for the operation or safety of this equipment if the controller, valve, or igniter probe are adjusted by anyone other than a Cleveland Range authorized service representative.

The following START-UP SUMMARY is for quick reference ONLY. For safe operation and use of this equipment, the operators should comply with all safety and operating instructions in this manual.

Lighting Instructions

1. Turn the ON/OFF lever/switch clockwise to the ON position.
 - Blower will start and boiler will fill with water (about 3 minutes).
 - Pilot will attempt to light for 90 seconds.
 - If no ignition occurs the system will automatically reset in 6-7 minutes.
2. System may be reset manually by turning the ON/OFF lever/switch counterclockwise to the OFF position for 5 minutes and then back to ON.
3. Turn ON a cooking compartment. (Not required for "Instant ON" models)
 - Blower will start and main burner will light.
4. Each compartment has its own control system, and must be started independently.

Shutdown Instructions

Turn the ON/OFF lever/switch counterclockwise to the OFF position. The burners and pilots will immediately be extinguished and the unit will begin the automatic 3-minute blowdown cycle and drain. NOTE: Each compartment has its own control system, and must be shut off independently.

E. INSPECTING THE COOKING COMPARTMENT

At the back of the cooking compartment, a drain screen covers the drain (Refer to Figure 2-4). The screen prevents large food particles from entering and blocking the drain line. Any blockage of the drain line or

screen can reduce drainage from the cooking compartment resulting in reduced cooking performance, equipment damage, and a hazard to the operator. A blocked or slow drain may cause:

- Hot water to collect in the compartment and spill out when the compartment door opens.
- Pressure fluctuations in the compartment, resulting in steam leaks around the door gasket, or compartment implosion.
- Reduced convection in the compartment, reducing cooking performance.

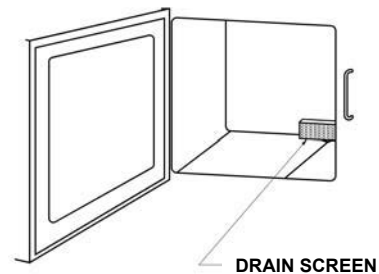

Figure 2-4 Compartment Drain Screen

⚠ CAUTION

Steam leaks around the door, cooking compartment flooding, reduced cooking performance, and compartment implosion can be caused by a blocked drain or drain screen. Inspect and clean the drain and drain screen before each use.

Before every steaming operation, inspect the cooking compartment and remove any food scraps or debris from the racks, walls, and floor of the compartment. Pay particular attention to the drain and drain screen.

1. **DO NOT USE** the steamer if water stands in the drain opening. Arrangements must be made immediately to clean the drain in accordance with the instructions found in the Preventative Maintenance and Troubleshooting section of this manual.
2. Remove any food or debris that is blocking the drain or screen.
3. Be sure the screen covers the drain. The screen prevents large pieces of food from entering and blocking the drain.

F. PREHEATING THE STEAMER

Preheating the steamers can help insure that the best productivity and consistent cooking is obtained. To preheat each steamer, run a cooking cycle of approximately 15 minutes with no food in the cooking compartments.

NOTE: If using a steamer with a timer, set only a 1 minute cooking time for the purpose of preheating, since the timer will only begin to countdown once the steamer has reached a cooking temperature.

- **BEFORE PREHEATING**, inspect and clean the compartment. After preheating, the compartment will be too hot to inspect and clean safely.

G. DESCALING REQUIRED LIGHT FEATURE

When the programmed number of hours have elapsed, the “DESCALE REQUIRED” light will turn on, indicating that descaling of the steam generator must be done (See Figure 2-5). More information on this feature and the descaling procedure can be found in the Maintenance section of this manual, Chapter 6, Part A (4), Monthly/Weekly Maintenance.

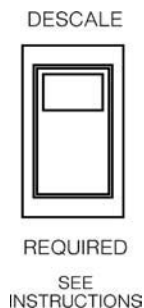

NOTE: Orientation of switches may vary depending on model.

Figure 2-5 Descaling Required Light

CHAPTER 3 CONTROL PANELS

The standard dial timer control panel (illustrated in Figure 3-1) has a mechanical timer. An optional electronic keypad timer, illustrated in Figure 3-2, an “Instant ON” Model (illustrated in Figure 3-3) and an ON/OFF control panel (not illustrated) are also available. The Electronic and mechanical timers use a temperature compensation circuit, which allows the timer to count down only while the cooking compartment is at cooking temperature. The “Instant ON” model has no operating controls other than the Power ON/OFF lever/switch, and begins heating to produce steam as soon as the ON/OFF lever/switch is set to the ON position. The ON/OFF Control Panel, which is not illustrated, operates exactly like the timed models in manual mode, except a selector switch is used to turn the steam to the cooking compartments ON and OFF. **NOTE:** The “Instant ON” option is only available on the Model 24CGA6.2.

A. DIAL TIMER CONTROL PANEL

1. Cooking Operations – Dial Timer Control Panel

For safe, efficient operation of the steamer, the operator must, at a minimum, comply with all cautions, warnings and instructions in the detailed operating procedures and be familiar with the control panel shown in Figure 3-1. The operator must be familiar with all the operating features explained in this manual before attempting to operate the steamer.

2. Manual and Timed Modes

The steamer has two operating modes: manual and timed. The TIMED/MANUAL rocker switch selects the operating mode. Pressing the MANUAL end of the switch selects the manual operating mode. Pressing the TIMED end of the switch selects the timed operating mode. Cooking procedures are slightly different for each mode.

a. Manual Mode

The manual mode provides continuous steaming. The operator starts and stops steaming operations manually. See the Operating and Cooking Procedure – Manual mode in Chapter 4, Part B for more information. A thermostat controlled pause light located on each control indicates that the cooking compartment has not yet reached cooking temperature.

b. Timed Mode

- The timer provides timed control of steaming operations. The timer starts and stops steaming operations.
- The mechanical timer control uses a temperature compensation circuit that effects only the timer. When operating, the timer **ONLY COUNTS DOWN WHILE THE COOKING COMPARTMENT IS AT COOKING TEMPERATURE**. This provides totally automatic control of the steaming operation and assures uniform cooking as the timer automatically compensates for food product defrosting and/or compartment heat up time. Whenever the steamer is not at cooking temperature, the timer pauses and the PAUSE light is illuminated.
- To use the timer, simply set the timer to the desired time. The steamer will begin cooking as soon as the timer is set. When the timer reaches zero the steaming functions will automatically end and a buzzer will sound for 3 seconds to alert the operator that cooking is complete.
- Note the mechanical timer will not function when the Timed/Manual switch is set to Manual, although the pause light will still illuminate to indicate that the cooking compartment is not yet at cooking temperature.

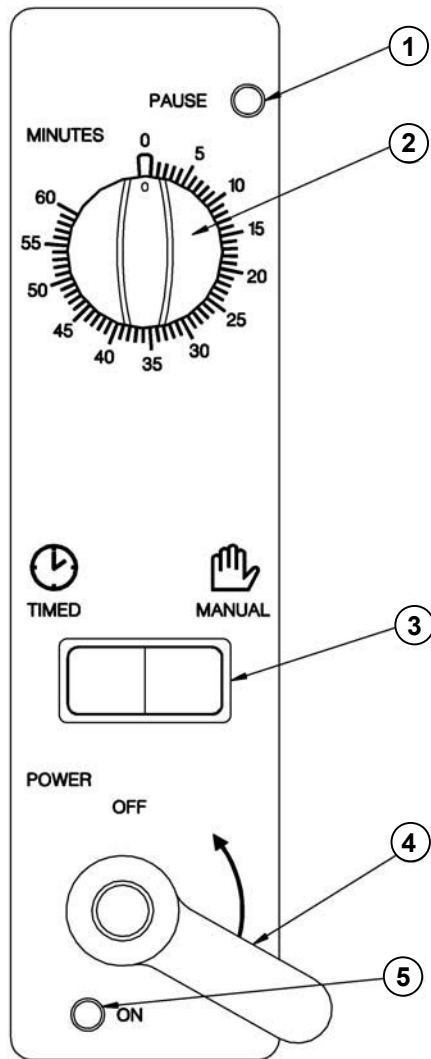

Note: Control panel for Gemini 10 Shown

- 1). **PAUSE Indicator Light**
This light is lit whenever the cooking compartment has not yet reached cooking temperature. Note: when in the timed mode the timer will not count down as long as this light is ON.
- 2). **TIMER**
This dial timer sets the operating time from 0 to 60 minutes. Turn the dial clockwise until it points to the required number of minutes. When it reaches 0, a buzzer sounds for 3 seconds.
- 3). **TIMED/MANUAL Switch**
The TIMED/MANUAL switch selects the manual or timed operating mode.
 - Pressing the MANUAL end of the switch selects the manual mode.
 - Pressing the TIMED end of the switch selects the timed mode.
- 4). **ON/OFF Switch (located on control panel for Gemini 10 only, located below the lower compartment on the Gemini 6)**
The ON/OFF switch controls the start-up of the individual generators. Each switch controls the power function of its individual generator and cooking compartment only.
 - Turning switch to the ON position fills the generator, turns the indicator light ON and energizes the control panel.
 - Turning switch to the OFF position starts the blow down cycle, de-energizes both the heating system and the control panel.
- 5). **Power on Indicator Light**
When the Red indicator light is on, power is on to the control panel.
- 6). **Descale Indicator Light Switch (not shown)**
When the Amber light in the switch lights, it is time to descale the steam generators. Pressing the switch turns off the light and resets the internal timer which tracks steam generator operation. (See Chapter 6, Part A).

FIGURE 3-1, DIAL TIMER CONTROL PANEL

B. KEYPAD TIMER CONTROL PANEL

1. Cooking Operations – Keypad Timer Control Panel

For safe, efficient operation of the steamer, the operator must, at a minimum, comply with all cautions, warnings and instructions in the detailed operating procedures and be familiar with the control panel shown in Figure 3-2. The operator must be familiar with all the operating features explained in this manual before attempting to operate the steamer.

⚠ CAUTION

Press keypad with fingertips only. Do not use kitchen utensils or anything sharp to operate the keypad.

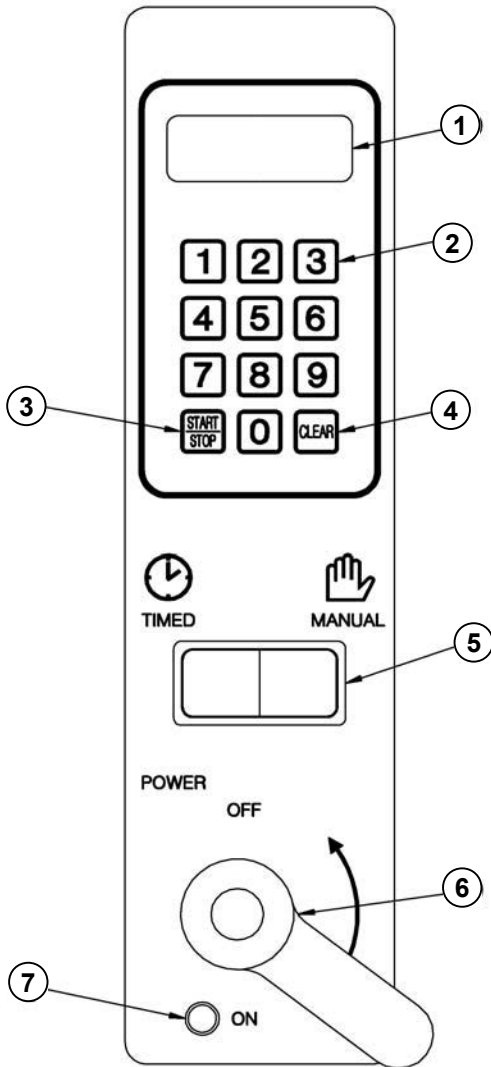

Note: Control panel for Gemini 10 Shown

1). **TIMER Display**

This four-digit display indicates the minutes and seconds remaining in the count down. The display reads from zero (00:00) to 99 minutes and 99 seconds (99:99). It reads pause (PAUS) when the count down is halted either by the START/STOP key or by the temperature compensating circuit.

2). **Number Pad Keys**

These keys set the number of minutes and seconds in the timer count down. Pressing the number keys 1 2 3 4 in this sequence, sets the timer for 12 minutes and 34 seconds (12:34).

3). **START/STOP Key**

This key starts and stops the timer. In TIMED mode the steaming functions are linked to the timer. In MANUAL mode, the steaming functions are independent of the timer.

4). **CLEAR Key**

This key resets the timer to zero (00:00) after it has been stopped. The timer must be zeroed by pressing this key before a new time can be set.

5). **TIMED/MANUAL Switch**

The TIMED/MANUAL switch selects the manual or timed operating mode.

- Pressing the MANUAL end of the switch selects the manual mode.
- Pressing the TIMED end of the switch selects the timed mode.

6). **ON/OFF Switch (located on control panel for Gemini 10 only, located below the lower compartment on the Gemini 6)**

The ON/OFF switch controls the start-up of the individual generators. Each switch controls the power function of its individual generator and cooking compartment only.

- Turning switch to the ON position fills generator, turns indicator light ON and energizes control panel.
- Turning switch to the OFF position starts the blow down cycle, de-energizes the heating system and the control panel.

7). **Power on Indicator Light**

When the Red indicator light is ON, power is ON to the control panel.

8). **Descalc Indicator Light Switch (not shown)**

When the Amber light in the switch lights, it is time to descale the steam generators. Pressing the switch turns off the light and resets the internal timer which tracks steam generator operation. (See Chapter 6, Part A)

FIGURE 3-2 KEYPAD TIMER CONTROL PANEL

2. **Manual and Timed Modes**

The steamer has two operating modes: manual and timed. The TIMED/MANUAL rocker switch selects the operating mode. Pressing the MANUAL end of the switch selects the manual-operating mode. Pressing the TIMED end of the switch selects the timed (automatic) operating mode.

a. Manual Mode

The manual mode provides continuous steaming. The operator starts and stops steaming operations manually. See the Operating and Cooking Procedure – Manual Mode in Chapter 4, Part B for more information.

b. Timed Mode and Use of the Timer

1). Timer Use and Temperature Compensation

- The keypad timer control starts and stops steaming operation, and monitors cooking time and compartment temperature for accurate, efficient, uniform steam cooking.
- The keypad control uses a temperature compensation circuit that effects only the timer. When operating, the timer **ONLY COUNTS DOWN WHILE THE COOKING COMPARTMENT IS AT COOKING TEMPERATURE**. This provides totally automatic control of the steaming operation and assures uniform cooking as the timer automatically compensates for food product defrosting and/or compartment heat up time. Whenever the steamer is not at cooking temperature, the timer pauses and the display shows "PAUS". Once temperature is reached, a digital display of the remaining time is displayed. When the timer counts down to zero a buzzer will sound, to indicate that cooking is complete and the steam generator will shut down.
- The timer will operate similarly when the steamer is being operated in the manual mode including counting down only when the steamer is at cooking temperature, except that the timer does not start or stop the steaming cycle.

2). Timer Operation

a) Setting the Timer

To set the cooking time, the timer must first be zeroed by pressing the clear key. The timer can be set only when the cooking time display is clear (00:00). The cooking time display contains four digits. The left two digits are minutes, and the right two digits are seconds. The display 12:34 is set for 12 minutes and 34 seconds. To set the cooking time:

- (1) Change the required cooking time to minutes and seconds.
- (2) Press the number keys for minutes, and then, for the seconds.
- (3) If the cooking time is 99 seconds or less, only press the number keys for seconds.

b) Starting/Stopping the Timer

Press the START/STOP key to start or stop the timer. When the START/STOP key is pressed, the steam generator begins heating the water to steam. Shortly, steam fills the cooking compartment.

- (1) The timer display reads "PAUS" until the cooking compartment reaches proper cooking temperature, or when the timer cycle is paused by pressing the START/STOP key again after the timer has started.
- (2) When the cooking compartment reaches proper cooking temperature, the timer display shows the count down.

NOTE: A timer setting of 10 minutes may in fact take 11 or 12 minutes for the timer to count down and the alarm to sound. This is normal. Heating the compartment and food to cooking temperature uses the additional time.

c) Shutting Off Buzzer AFTER Timer has Reached Zero

When the timer counts down to zero, the buzzer sounds continuously, the generator stops steaming, and steam flow to the cooking compartment gradually stops.

Press the START/STOP key to silence the buzzer. The cooking time display returns to the last time set. Either run this same setting again or clear and reset the timer.

CAUTION

Press keypad with fingertips only. Do not use kitchen utensils or anything sharp to operate the keypad.

C. "INSTANT ON" CONTROL PANEL

1. Cooking Operations – "Instant ON" Control Panel

For safe, efficient operation of the steamer, the operator must, at a minimum, comply with all cautions, warnings and instructions in the detailed operating procedures and be familiar with the control panel shown in Figure 3-3 and the ON/OFF lever shown in Figure 2-2 of Chapter 2, Part C. The operator must be familiar with all the operating features explained in this manual before attempting to operate the steamer.

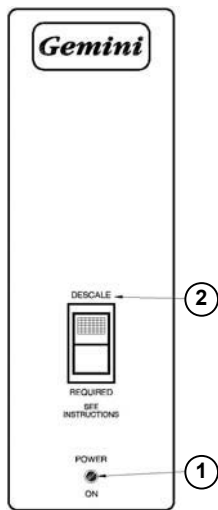

1). Power on Indicator Light

When the Red indicator light is on, power is on to the cooking compartment. The compartment will begin to fill with steam and stay steaming as long as the door is closed.

2). Descale Indicator Light Switch

When the Amber light in the switch lights, it is time to descale the steam generators. Pressing the switch turns off the light and resets the internal timer which tracks steam generator operation. (See Chapter 6, Part A)

Note: This option is only available on the Gemini 6

FIGURE 3-3, "INSTANT ON" CONTROL PANEL

2. "Instant ON" Steamer Use

a. General Steamer Operation

The "Instant ON" steamer has a single operating mode, which operates similar to the manual mode except that there is no switch with which to shut off the steam. As soon as the power is turned on for each compartment, the steamer begins to heat water to steam and continue to produce steam as long as power remains "ON" to the steamer. When power is on to a steaming compartment the production of steam can only be interrupted by opening the doors to that compartment (or by turning OFF power to that compartment, which will also drain the steamer, see STEAM GENERATOR BLOWDOWN in Chapter 5).

b. Recommended Steamer Operation

In order to obtain the most efficient and safe use of the "Instant ON" steamer use the following guidelines when using the steamer.

- Whenever it is necessary to open the door whether to add, check on or remove food open the door slightly and allow the steam to dissipate for about 1 minute before reaching inside the steamer.

- If the steamer is not going to be used for prolonged periods, open the door and leave it ajar. This will interrupt the production of steam without draining the steam generator.
- Do not turn off the main power to the generator, unless it is time for the scheduled blowdown of the steamer (See Section 5, Part A STEAM GENERATOR BLOWDOWN). This will cause delays in cooking, as the boiler will have to refill with water and reheat to the steaming temperature before actual cooking can start again.

CHAPTER 4 COOKING WITH THE STEAMER

WARNING

When checking inside the steamer always open the door slowly and stand to the side and back away from the steamer. Water leaking from the door gasket can be a sign of a blocked drain. If the drain is blocked, hot water can accumulate inside the compartment and spill out when the door is opened.

A. OPERATING AND COOKING PROCEDURE – TIMED MODE

WARNING

Even though the production of steam ends as soon as a door is opened, it may take up to a minute for residual steam in the system to clear from the steam lines and the cooking compartment. To avoid possible injury always wait until this residual steam has cleared before reaching into the cooking compartment.

In timed mode, the timer starts and stops the steaming operation.

1. Inspect and clean the drain and cooking compartment as required. Refer to INSPECT THE COOKING COMPARTMENT IN Chapter 2, Part E.
2. If necessary, preheat the cooking compartment. Refer to PREHEATING THE STEAMER, in Chapter 2, Part F.
3. Slide the pans of food into the slide racks inside the steamer. Do not place pans or anything else on the bottom of the compartment.

CAUTION

Some foods drip juices. Use a solid catch pan under perforated pans when steaming food that will drip juices. Failure to use a catch pan can cause a clogged drain.

- For best cooking results, use shallow, 2-1/2 inch deep, perforated pans without covers. These give the best heat transfer and shortest cooking time.
4. Close the steamer door.
 5. Check the control settings. At this point the settings should be:
 - The ON/OFF lever/switch is in the ON position.

- The TIMED/MANUAL switch is in the TIMED position.
6. Set the required cooking time. For KEYPAD MODELS press the START/STOP key to start the cooking cycle. Shortly after the door is closed, steam fills the cooking compartment.
 7. When the timer reaches zero, a buzzer will sound, the steam generator stops steaming, and steam flow to the cooking compartment gradually stops. The cooking cycle is complete.
 - For DIAL timers the buzzer will stop after 3 seconds.
 - For KEYPAD timers, press the START/STOP key to silence the alarm.

 WARNING
<p>SEVERE BURNS may result from exposure to steam.</p> <p>Do not open the steamer door before steam flow stops. Stand back when opening the compartment door. Open the door slightly to allow steam to vent before looking or reaching into cooking compartment. Do not reach into cooking compartment until the steam has cleared.</p> <p>Do not reach into steamer or handle hot items without wearing heatproof gloves. Wet or damp gloves conduct heat, and may cause burns when touching hot items.</p>

8. Carefully open the cooking compartment door, and remove the pans from the slide racks.
 - If the steamer will be used again in a few minutes shut the door to maintain the cooking compartment temperature.
 - If another use is not planned for more than half an hour, leave the cooking compartment door slightly open to reduce internal pressure while the steam condenses and the compartment cools.
 - If the steamer is not being used again during this shift, perform the Power OFF and Shut Down and Cleaning Procedures, found in Chapter 5.

B. OPERATING AND COOKING PROCEDURE – MANUAL MODE

Manual mode allows the operator to personally control the cooking functions. The operator starts and stops the steaming operations, and sets the cooking time including time for steam generator, compartment and food heat-up time. Use the manual-cooking mode for:

- A continuous supply of steam.
- Cooking times longer than the timer can measure.
- Maintaining the compartment temperature between cooking batches.

1. Using the Timer in Manual Mode

The KEYPAD timer may be used when the steamer is operating in the manual mode, but it will not start or stop the steaming cycle.

2. Manual Cooking Procedure

Follow this procedure when cooking with the steamer in manual mode.

- 1) Inspect and clean the drain and cooking compartment as required. Refer to INSPECT THE COOKING COMPARTMENT in Chapter 2, Part E.
- 2) In manual mode, the operator can bring the compartment to cooking temperature by either preheating or increasing the cooking time. If the operator chooses to preheat the cooking compartment manually, refer to Chapter 2, Part F, PREHEATING THE STEAMER.
- 3) Slide the pans of food into the slide racks inside the steamer. Do not place pans or anything else on the bottom of the compartment.

⚠ CAUTION

Some foods drip juices. Use a solid catch pan under perforated pans when steaming food that will drip juices. Failure to use a catch pan can cause a clogged drain.

- For best cooking results, use shallow, 2-1/2 inch deep, perforated pans without covers. These give the best heat transfer and shortest cooking time.
- 4) Close the steamer door. Select the manual mode by pressing the MANUAL end of the TIMED/MANUAL rocker switch. The steaming cycle starts as soon as the switch is pressed. Shortly after the door is closed, steam fills the cooking compartment.
- 5) If the KEYPAD timer is used to monitor cooking.
 - a) Set and start the timer. (Remember that when the KEYPAD timer is used in this way it will only count down time when the steamer is at cooking temperature.)
 - b) When the timer reaches zero, the buzzer will sound, and cooking is done. Remember, in manual mode, the timer does not stop the steaming functions.
- 6) To stop manual mode steaming, press the TIMED end of the TIMED/MANUAL rocker switch and verify that the timer is OFF (timer electronic models) or at zero (Dial timers). The generator stops steaming, and steam flow to the cooking compartment gradually stops.

⚠ WARNING

SEVERE BURNS may result from exposure to steam. Do not open the steamer door before steam flow stops. Stand back when opening the compartment door. Open the door slightly to allow steam to vent before looking or reaching into cooking compartment. Do not reach into cooking compartment until the steam has cleared. Do not reach into steamer or handle hot items without wearing heatproof gloves. Wet or damp gloves conduct heat, and may cause burns when touching hot items.

- 7) Carefully open the cooking compartment door, and remove the pans from the slide racks.
 - If the steamer will be used again in a few minutes shut the door to maintain the cooking compartment temperature.
 - If another use is not planned for more than half an hour, leave the cooking compartment door slightly open to reduce internal pressure while the steam is condensing and cooling.
 - If the steamer is not being used again during this shift, perform the Power OFF and Shut Down and Cleaning Procedures, found in Chapter 5

CHAPTER 5 SHUTDOWN AND CLEANING PROCEDURES

A. STEAM GENERATOR BLOWDOWN

1. Power Off (Automatic Blowdown)

Blowdown occurs automatically when each steamer compartment is turned OFF at its ON/OFF lever/switch. During blowdown, the steam generator drain valve is rinsed with fresh water, and the boiler

is drained. Blowdown at frequent intervals helps decrease mineral buildup in the steam generators, and reduces the frequency of descaling and other maintenance.

2. Blowdown Frequency

The supply water quality determines how often blowdown must be performed. The more the steamer is used and the higher the content of total dissolved solids and particulates in the feed water, the more frequently blowdown must be performed. A determination should be made at the time of installation whether additional blowdown frequency will be required as part of the daily maintenance based on the water quality analysis done as part of the installation. This information should be noted in the daily maintenance program developed for the equipment. After it has been determined whether the local water supply meets the minimum supply water quality standards, observe the following guidelines to establish proper blowdown scheduling.

- When using a supply water system that does not meet the minimum supply water quality standards, blowdown must be performed after every 4 hours of operation and at the end of each shift.
- For units using water that meets the minimum supply water quality standard, whether naturally or by using a water treatment system, blowdown must be performed at the end of each shift.

3. Blowdown Procedure

When each steamer is turned OFF, its blowdown cycle starts and runs automatically. The complete cycle takes approximately 3 minutes.

- (1) Turn the ON/OFF lever/switch counterclockwise to the OFF position to turn OFF the steamer. The red indicator light turns OFF and the drain valve is opened. Do not turn power OFF at the main external power switch during blowdown.
- (2) The drain valve begins to draw water from the steam generator.
- (3) The fill valve operates for 3 minutes to help flush any debris through the drain valve as the generator drains.
- (4) At the end of the 3-minute blowdown cycle, the fill valve closes.
- (5) When blowdown is complete, the steamer can be restarted, or the shut down procedure completed.
 - To restart the unit, refer to POWER ON (AUTOMATIC FILL) in Chapter 2, Part C.
 - To shut down the unit, refer to SHUT DOWN AND CLEANING, below.

NOTE: The ON/OFF lever/switch must be turned fully to the OFF position to properly START the automatic blowdown of the steamer.

B. SHUT DOWN AND CLEANING

This procedure should be performed at the end of each day or shift.



1. Refer to Power OFF (Automatic Blowdown), and turn off the steamer compartment. Allow 3 minutes for the complete blowdown cycle.

⚠ WARNING

SEVERE BURNS may result from exposure to steam.

Do not open the steamer door before steam flow stops. Stand back when opening the compartment door. Open the door slightly to allow steam to vent before looking or reaching into cooking compartment. Do not reach into cooking compartment until the steam has cleared.

Do not reach into steamer or handle hot items without wearing heatproof gloves. Wet or damp gloves conduct heat, and may cause burns when touching hot items.

2. Open the steamer door and allow steamer to cool.

⚠ WARNING

Inside of steamer stays hot for a long time. Be careful when cleaning inside steamer compartment.

3. Remove the slide racks. Wash and rinse racks separately or clean them in a dishwasher according to health requirements. Do not remove the drain screen.
4. Remove any spilled food from inside compartment and clear any residue from the drain screen. Clean the interior of the compartment thoroughly. Use a soft bristle brush to remove stubborn food particles. Do not use abrasive cleaning compounds or steel wool. Rinse inside of steamer compartment with clean water.

⚠ WARNING

Let rinse water drain through compartment drain opening. If water does not drain freely, drain lines must be cleaned before cooking again. Clogged or slow drains are dangerous because hot water can collect in compartment and spill out when opening compartment door.

5. Clean the door assembly.

- Remove the door gasket assembly (see Figure 5-1).
- Note the keyhole slots on the door and the retaining pins on the gasket assembly. Grasp the gasket assembly at the sides and lift up and towards you to remove the assembly.
- Clean all surfaces of the gasket assembly, as well as the inside of the door, by wiping with a damp cloth.
- Rotate the gasket assembly 180° and replace it by sliding the retaining pins into the keyhole slots. Either long edge of the gasket assembly can be positioned at the top. Periodic rotating of the door assembly will increase the door gasket life.

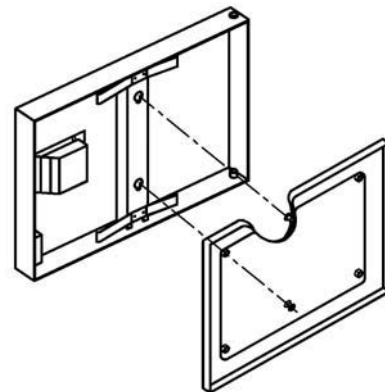

Figure 5-1 Door Gasket Assembly

6. Replace the cleaned slide racks.
7. Wipe the exterior with a damp cloth only. NEVER HOSE DOWN THE STEAMER. Electrical components inside the unit will not function correctly if wet or damp.
8. After cleaning, leave the steamer door open until the next steamer operation. This prevents compartment odor buildup and increases gasket life.

CHAPTER 6 PREVENTATIVE MAINTENANCE AND TROUBLESHOOTING

A. MAINTENANCE

Maintenance on the steamer must be performed on a regular basis to keep the unit running properly. By following the maintenance instructions in this chapter and in the separate Installation Manual, problems with the steamer will be kept to a minimum. As with any preventative maintenance schedule, the frequency of steamer maintenance may need to be increased, depending on equipment usage and water quality. If problems do occur, refer to the Troubleshooting Guide in this chapter. For more information on products and services, contact your sales representative.

1. Maintenance Records

Make a file solely for maintenance records. Keep a written record of daily, weekly, monthly, and yearly maintenance. These records will protect warranty coverage, help personnel to know when to perform various maintenance procedures, and assist service personnel.

2. Daily Maintenance

a. Blowdown Steam Generator

Blowdown each steam generator at least every four hours according to the steam generator blowdown instructions in Chapter 5.

b. Clean the Steamer

Clean interior and exterior of the steamer according to the shutdown instructions in Chapter 5.

3. Weekly Maintenance

Clean Drain

 CAUTION
--

<p>Steam leaks, pressure buildup in the cooking compartment and poor steaming performance can be caused by a blocked drain line or screen. Blocked or slow drains are dangerous because hot water can collect in the compartment and spill out when opening the compartment door.</p>

This steamer is equipped with a drain screen in the back of each cooking compartment. Never operate the steamer without the screens in place. The screen prevents large food particles from entering and blocking the drain line. Any blockage of the drain line can cause a pressure buildup in the compartment, resulting in steam leaks around the door gasket. Drain line blockage also adversely affects convection action of the steam in the compartment, which is necessary for optimum performance.

- a. Inspect the drain screen and drain line for blockage. Rotate the drain screen 90 degrees to inspect the drain opening. Clean the opening and restore the screen to its operating position.
- b. Clean drain with a USDA approved drain cleaner, once a week. Follow the instructions of the manufacturer of the cleaner.
- c. Flush drain with clean water.

4. Monthly/Weekly Maintenance

Descale Steam Generator

Steam generators should be descaled at least once a month, depending on scale buildup. Alternately, they can be descaled weekly with smaller amounts of solution, if this frequency better suits your maintenance schedule. If you have serious steam generator scale buildup, a water treatment system should be installed for the steamer or if this is not possible the frequency of descaling should be increased. This unit is equipped with a Descaling reminder light to assist in the scheduling of this maintenance. (Note: the descaling light has been factory set for an operating time of approximately 1 month, if weekly descaling has been chosen it will be necessary to have the descaling timer reset to reflect this schedule by a qualified service technician). When this light comes on arrangements should be made to descale the steam generator as soon as feasible. Cleveland Range, Inc. recommends the use of **DISSOLVE® Descaler Solution, Cleveland Range Part Nos. 106174**. No other system of steamer descaling should be used.

NOTE: Part No. 106174 is the Part No. for a case (6 1-gallon containers) of *DISSOLVE®* descaler. It is also available in 5-gallon containers as Part No. 1061741.

THESE INSTRUCTIONS ARE FOR USE WITH *DISSOLVE®* DESCALER SOLUTION Cleveland Range Part Nos. 106174 or 1061741 ONLY.

- **Health Hazard Data, Effects of Overexposure** – This product may cause a burning sensation to eyes or skin.
- **Emergency and First Aid Procedures** - In case of eye contact, immediately flush eyes with plenty of water. If irritation persists seek medical attention. In case of skin contact wash with soap and water. If inhaled, remove to fresh air and if burning persists, call a physician. If swallowed, drink 1 or 2 glasses of water and call a physician.
- **Spill or Leak Procedures** – Rinse with plenty of water to dilute. Sodium carbonate or calcium carbonate may be used to soak up liquid. Considered non-hazardous, spent material may be disposed of in a sewer system with water flush.

WARNING

The liquid solution in Cleveland Range Descaler Solution Part No. 106174 or 1061741 can be harmful if not handled properly. Follow these basic safety rules for handling and using this product.

Wear protective clothing when mixing or applying chemical cleaners.

Wear rubber gloves, and splash goggles.

Avoid breathing fumes. If liquid comes in contact with skin, wash with soap and water.

If chemical contacts eyes, flush with water. If irritation persists seek medical attention

If chemical is swallowed or ingested, drink 1 or 2 glasses of water and call a physician.

CAUTION

Do not use any other product or method of descaling other than the *DISSOLVE®* Descaler method using Part Nos. 106174 or 1061741.

Monthly/Weekly Maintenance (continued)

a. MODEL 24CGA6.2 and 24CGA10.2, ATMOSPHERIC STEAM GENERATOR DESCALING PROCEDURE (For *DISSOLVE*[®] Descaler Solution Part No. 106174 or 1061741)

Monthly Intervals

1. This procedure will take approximately 1 hour and 30 minutes to complete. This entire procedure should be read and fully understood before beginning the actual descaling operation.
2. Zero the timers or, for manual only models, set the selector switch to OFF.
3. Open both doors to the cooking compartments.
4. Set the TIMED/MANUAL switches to TIMED.
5. Set the ON/OFF levers/switches to the OFF position. (The unit will undergo a normal blowdown cycle, which should take approximately 3 minutes to complete).
6. When the unit has completed draining, turn the ON/OFF levers/switches to ON to refill the unit. Do not start the timer. Leave the doors open.

NOTE: DO NOT HEAT THE UNIT DURING DESCALING.

7. While the unit is filling with water, remove the descaling port caps located at the top of the unit (See Figure 6-1), and add 1 gallon of *DISSOLVE*[®] descaler solution to each port.
 - While adding liquid to the unit through the descaler inlets, pour it in slowly so as to avoid overflow.
8. After automatic fill has ended, turn OFF power at the external main power switch. See Figure 6-2. Add an additional 1-gallon of water to each port.
9. Replace the caps and let the unit stand for 1 hour.
10. At the end of 1 hour, set the ON/OFF levers/switches to the OFF position and turn the power ON at the external main power switch. After the 3-minute drain cycle, completes turn the unit back ON. After the filling has stopped, add 1½ gallons of water through each descale port, and then turn the unit OFF. This will start a blowdown cycle and drain any residue from the water level control assembly.
11. After the unit has drained completely, close the steamer doors and set the ON/OFF levers/switches to the ON position. The unit will fill with water.
12. Set the timers for 20 minutes, and turn them on (KEYPAD MODELS). The unit will come up to normal operating temperature.
13. At the end of 20 minutes of cooking, turn off the alarm (if necessary) and set the ON/OFF levers/switches to the OFF position. The unit will go through a 3-minute drain cycle.
14. This is the final blowdown to rinse the unit. The steamer is now ready for normal operation.
15. When done cleaning, reset the descale indicator light timer to zero by pressing the “DESCALE REQUIRED” lighted rocker switches, and resume normal operation.



Figure 6-1 Descaling Port

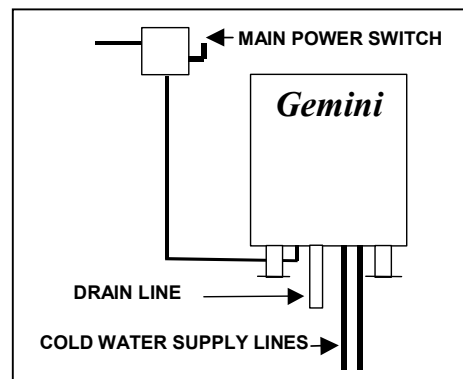

Figure 6-2 External Main Power Switch

Optional Weekly Cleaning Intervals

1. Follow same process as above, except add one quart of DISSOLVE® descaler (Part No. 106174) instead of one gallon of DISSOLVE® descaler to each generator.

B. OPERATORS TROUBLESHOOTING GUIDE

The Troubleshooting guide includes a list of symptoms that may be encountered during routine operation and maintenance. The first column on the left (PROBLEM) describes these symptoms. The second column lists the possible causes for the problem in column one. The third column lists possible remedies for the problems and causes in columns one and two. The causes and remedies are listed in the order they should be checked, with the least costly and easiest to repair listed first. The third column also refers to notes that are grouped at the end of the troubleshooting guide. Refer to these notes when instructed to do so.

Table 6-1 Troubleshooting Guide

PROBLEM	POSSIBLE CAUSE	REMEDY/REFERENCE
Power indicator light does not turn ON when ON/OFF lever/switch is in the ON position.	Power turned OFF at main external power switch.	Turn ON power at main external power switch.
	ON/OFF lever/switch not fully turned to the ON position.	Turn lever/switch to the full ON position.
	Inoperative controls or failed light.	See note #1
Power ON and steam generator does not fill.	Water supply to steamer shut OFF.	Open water supply valves.
	Water line strainer and/or external filter system is clogged	Clean water supply strainer and/or filter system.
	Inoperative Solenoids or controls.	See note # 1.
Control panel POWER indicator light ON and steamer does not make any steam in MANUAL or TIMED mode.	Water supply to steamer shut OFF.	Open water supply valves.
	Gas Supply turned OFF	Turn ON gas supply
	Door interlock switch not engaged or has failed.	Close door completely. If problem persists see note #1.
	Water line strainer and/or external filter system is clogged	Clean water supply strainer and/or filter system.
	Hi-limit switch has tripped.	See note #1.
	Inoperative controls or solenoid.	See note #1.
Abnormal amount of steam coming from drain.	Water supply to condenser turned OFF.	Open water supply valve.
	Hot water instead of cold water connected to condenser fitting.	See note #2.
	Condenser water line strainer is clogged.	Clean out condenser water supply strainer. See note #1.
	Condenser is clogged.	See note #1
	Water supply line to the condenser blocked, broken, or leaking.	Repair or replace water supply line. See note #3.
	Inoperative controls or solenoids.	Turn OFF electricity at main external power switch. See note #1.
Abnormal amount of steam coming from drain during blowdown cycle.	ON/OFF lever/switch is not turned fully to the OFF position.	Turn ON/OFF lever/switch to the full OFF position to start the proper blowdown operation.

(Continued on next page)

Table 6-1 Trouble Shooting Guide (Continued)

PROBLEM	POSSIBLE CAUSE	REMEDY/REFERENCE
Steam and/or water draining around compartment door. See Warning under note #7.	It is common for a small amount of water to condense around the door	This is normal operation of the unit. No action is necessary.
	Compartment drain clogged or covered.	Clean drain with USDA approved drain cleaner. If condition persists see note #1
	External drain not properly installed, should be free-air vented and pitched down.	See notes #2 and #3.
	Door gasket or door parts worn.	See note # 1.
	Steamer not level.	See note # 2.
	Condenser not operative.	See note #1.
Reduced steam flow into cooking compartment.	Steam generator scale buildup	Descal steam generator with Cleveland Range approved descaler.
	Gas inlet pressure is low.	The unit requires a minimum inlet pressure of 4.5 inches W.C. for Natural gas and 11.0 inches W.C. for propane gas to operate. See note #2.
	Inoperative or improperly adjusted controls	See note #1.
Power light is ON, but timer does not light. (Electronic Timer Models only)	Timer transformer has failed	See note #1
	Inoperative controls	See note #1
Steam flow does not stop when TIMER stops.	Operating in manual mode.	Switch to timed mode for timer to control steam flow.
	Inoperative controls inside cabinet.	Turn off electricity at main power switch. See note #1.
Water leaking from bottom of cabinet.	Broken or loose plumbing inside steamer cabinet.	Turn off electricity at main power switch and close water supply valve(s). See note #1.
Food takes too long to cook.	Pans too close to the bottom of cabinet.	Put pans in racks near top of cabinet.
	Compartment overloaded with too much food.	Put less food into pan. Use fewer pans.
	Not enough steam movement in compartment. Hot water connected to condenser line.	Make proper connections. See note #2.
	Steam generator scale buildup.	Descal steam generator with approved descaler.
	Food is frozen	Increase cooking times for frozen food
	Food is being cooked in covered solid pans.	Remove covering. Steam must have direct access to the food for cooking to take place.
	Suggested cooking times are usually listed for cooking at sea level.	Extend cooking times for altitudes above 2500 feet.
	Inoperative or improperly adjusted controls.	See note #1.

(Continued on next page)

Table 6-1 Trouble Shooting Guide (Continued)

PROBLEM	POSSIBLE CAUSE	REMEDY/REFERENCE
Compartment bottom dirty with food drippings.	Juices and/or food leaking from pans.	Put a solid pan under perforated pans to catch drippings, or put less food in pan.
Water leaking from water pipes or drain lines.	Plumbing needs repair.	See note #3.
Water coming from drain even when not cooking.	Condenser valve isn't closing properly.	See note #1.
Descale Required indicator is lit Note: Switch does not descale unit, it is just a reminder that steamer must be descaled every 4-6 weeks.	If unit is new, or has just been descaled	Press switch to reset desccale timer
	Unit needs descaling	Descale unit with Cleveland Range approved descaler. After descaling is completed, press switch to reset descale timer.
	Bad or improperly set descale timer	See note #1.

TROUBLESHOOTING NOTES

1. If problem is inside the steamer, call an authorized service representative. Cleveland Range, Inc. will not pay for warranty repairs by unauthorized repair centers.
2. Proper installation of the steamer is the responsibility of the owner or installer. A qualified installer or technician should be contacted to correct the installation. Refer to Cleveland Range, Inc. Warranty.
3. Repairs to external plumbing should be done by a Licensed Plumber.
4. Repairs to external wiring should be done by a Licensed Electrician.
5. For more information on products and services, contact your nearest Authorized Sales Representative. Call factory for a preventative maintenance program, descaling kits, descaling information, and water treatment systems: USA: (800) 338-2204, Canada: (800) 427-6668.
6. To evaluate whether a convection steamer is producing normal cooking performance, conduct the Egg Test as follows (Note: This test is not valid for SteamCubs or pressure steamers). A properly operating steamer will produce cooked eggs as follows.

Turn on the steamer so that steam is being produced. After steam has begun to enter the compartment, preheat the compartment by turning the timer on for ten minutes.

After the compartment is preheated:

- Place two fresh eggs in a perforated pan.
- Set timer for 10 minutes and turn on.
- After five minutes, open door and remove one of the eggs.
- Close the door right away and allow second egg to cook.
- Crack open first egg and it should be soft boiled.
- After timer goes off, open door, remove egg and crack open. It should be hard-boiled.

7. Whenever opening door, especially when water or steam is leaking around gasket heed the warning below.

 WARNING
<p>When checking inside the steamer always open the door slowly and stand to the side and back away from the steamer. Water leaking from the door gasket can be a sign of a blocked drain. If the drain is blocked, hot water can accumulate inside the compartment and spill out when the door is opened.</p>

CHAPTER 7 STEAM COOKING GUIDE

A. Introduction:

Steam Cooking is an excellent way to prepare countless foods. With large and small quantities you will find cooking to be efficient, economical, fast and convenient. Food can never burn-pans will never boil over-there is no heavy lifting of water in pots-no scouring of containers-no waiting for boiling to start. Steam cooking is efficient, economical and convenient. From the Steamer to the steam table, it saves money in labor/time, and, of course, the quality and consistency remains the same.

Seafood:

Steaming is an excellent method of cooking a variety of seafood. From the freezer directly into the steamer gives you, the operator, portion control on expensive seafood products. Steamed fish is tender, succulent, flaky and table ready in a matter of minutes.

Vegetables:

Steam cooking vegetables, either fresh or frozen, enhances color, improves flavor, and helps retain vitamins when recommended timer settings are followed. Steaming fresh vegetables on perforated pans gives best results.

Meat:

Steam provides an even, intense and penetrating heat, which, because of its nature, cooks meat with minimal shrinkage. The meat is tender, moist and flavorful. Stews, pot roasts, ham and corned beef are excellent steam cooked. Steam tenderizes stewing fowl. It produces excellent meat for sandwiches and salads, both moist and savory and is easily sliced.

Desserts:

Many kinds of cornstarch pudding and custard desserts are prepared by steaming. Fruit desserts such as steamed "Baked Apples" are another suggestion. Core the apple and arrange on a shallow pan. Fill the cored apple with cinnamon and sugar, then steam. If desired, browning under the broiler may finish the apples. Applesauce is another steam application, as are stewed pears or peaches. Dried fruit, properly marinated, turn out beautifully.

Additional Ideas:

There are many applications for steam cooking besides vegetables and seafood:

- Eggs can be soft cooked, coddled, hard cooked, poached, scrambled, and made into custard or pudding. 25 dozen eggs can be hard cooked in 12 minutes using three 12" x 20" x 2½" perforated pans in one compartment of the steamer.
- Momentary steam blanching of fruits, including citrus and pineapple, simplifies skin removal.
- Dumplings, steamed breads, muffins, hot cereal, pasta, noodle and rice can be prepared or reheated in the steamer.
- Beef and other meat, cooked by steaming, is moist, tender and flavorful. The meat drippings from the catch pan can be used to make gravy soups or clear stock, as a salt free broth.
- Turkey, chicken and other poultry are tender, juicy when steamed then combined into a casserole, added to BBQ sauce, or browned under the broiler. Chicken pieces can be breaded, steamed, then finished in the deep fryer. It is crisp, delicious, and juicy.
- Hot Dogs, sausages and other variety meats remain plump and juicy when steamed.
- Entrees such as lasagna, macaroni and cheese, or beef stew can be prepared from scratch. Frozen institutional packs can be reheated in the steamer. It is not necessary to cover.

B. SIZING UP PAN CAPACITY:

1. Serving Sizes – How Much? How Many?

How to estimate portion size and number of servings from a standard steam table pan.

- A 12" x 20" x 2½" (65mm-1/1GN) solid pan will hold 1-7/8 gallons or 240 fluid ounces (30 liters or 7200ml).

Table 7-1 Serving Size

240 Fluid Ounces Produces (7200ml)

<u>Portion Size</u>	<u>Number of Servings</u>	<u>Type of Product</u>
10 oz (300ml)	24	Stew, Casserole, Lasagna
8 oz (240ml)	30	Soup, Bisque
6 oz (180ml)	40	Soup, Bisque
4 oz (120ml)	60	Mashed Potatoes
2 oz (60ml)	120	Sauce
1 oz (30ml)	240	

- Number of servings of cooked vegetables from one 12" x 20" x 2½" perforated pan. (65mm-1/1GN)

Frozen Vegetables Yields:

10.0 lbs. (4.5kgs)	Approx. 50-3 oz (90ml) servings
7.5 lbs. (3.4kgs)	Approx. 35-3 oz (90ml) servings
5.0 lbs.	Approx. 25-3 oz (90ml) servings

2. Reference Charts for Typical Pan Capacities

Pan Capacity stated in terms of usable fluid ounces per straight side pan. When filled to overflowing, estimate a higher figure per pan.

Width x Length (inches)	12 x 20	12 x 13	12 x 10	12 x 6	10 x 6	6 x 6
Steam Table Pan Size	Full Size	2/3 Size	½ Size	1/3 Size	¼ Size	1/6 Size
<u>Pan Depth</u>	<u>Fluid Ounces</u>					
2 ½"	240	175	125	75	55	35
4"	420	294	208	125	95	55
6"	625	435	314	186	140	82

Pan Capacity stated in quarts per straight-sided pan. Capacity as stated is to overflowing.

<u>Pan Depth</u>	<u>Fluid Quarts</u>					
2 ½"	7 7/8	5 ¾	4 1/8	2 5/8	1 7/8	11/4
4"	13 ½	9 ½	6 ¾	4 1/8	3 1/8	1 7/8
6"	20	14	10 1/8	6 1/8	4 5/8	2¾

Can Size and Volume

<u>Can Size</u>	<u>Cup</u>	<u>Net Weight or Fluid Oz.</u>
No 2 ½	3 ½	27-29 oz
No 3	5 ¾	51 fluid oz.
No 10	12-13	6 ½ - 7 lb., 5 oz.

C. CONVECTION STEAMER – SUGGESTED TIMER SETTING GUIDELINES FOR TIMER CONTROLS WITH THE COMPENSATING THERMOSTAT (see Note)

Timer settings are approximate due to the differences in food quality, age, shape and the degree of doneness desired. It is not necessary to add water. Perforated pans are recommended. Starred items (*) must be cooked in solid pans. Items marked with two stars (**) require handling in two steps. First steam for approximately ½ the time shown, remove from steamer, separate thawed portion, or stir, and return to steamer for the time remaining. The compensating feature of the timer allows the cooking compartment to reach temperature before the preset time starts to count down. **Note:** Times may need to be increased slightly when using external timers to track cooking times.

VEGETABLES:	Fresh	Frozen		Fresh	Frozen
Artichoke	12		Spaghetti squash, halves	15-18	
Asparagus, spears	4	6	Tomatoes, whole, sliced*	1	
Beans, green, 2" cut	6	5	Turnips, whole	20-25	
French cut	4	5**	Zucchini, sliced	2-4	2-4
Whole	6	4			
Broccoli, spears	3	2-3	<u>SEAFOODS:</u> Steam all seafood on a perforated pan with catch pan		
Flowerets	2-3	1-2	Clams in shell	3-5	
Chopped		6-8	Cod filets, 5 oz.	3	4
Brussels sprouts	4-5	4	Portions		
Cabbage,	2		Crab legs, king		4-6
Whole to remove			Snow crab		2-4
Leaves for cabbage rolls			Crab, live, 4 oz.		
Carrots-baby whole	10	6	3/4 - 1 lb.	12	
Sliced,	7-8	3	Halibut, 6-8 oz.	4-6	6-8
Diced		2	Portions		
Cauliflower,			Lobster, whole, 1 lb.	7-9	
Flowerets	4-5	3-4	Lobster tails, 8 oz.		8-10
Whole	10		Defrosted, butterflied		4-6
Celery, Cut 1½"	3		Mussels in shell	2	
Diced	2	1	Oysters in shell	2-4	
Minced	1		Red snapper, 8 oz.	4-5	4-5
Corn, yellow, whole		2	Salmon steak, 8 oz.	6	7
On cob,	6	12**	Shrimp, 10 ct. per lb. IQF	3	4-6
Cobbettes	6	12**	5lb. Block, peeled &		
Eggplant, sliced,	1		Deveined 30 ct.		6-8
Mixed Vegetables		3-4	5lb. Block, green, (nested pan)		6-8
Mushrooms,			26-30 ct.		10**
Whole 1½"	3				
Sliced	1		<u>EGGS (Medium Sized):</u>		
Onions, diced, sliced	2-3	1	Hard cooked for egg		
Whole	4	2	Salad, potato salad	10-12	
Peas, green		2	Soft cooked	3	
Potatoes, whole 8 oz.	30-35		Coddled	6	
Peeled, quartered,	12-19		Poached in a cup	2-3	
Fresh peeled, diced	8-10		Scrambled*	6-7**	
Potatoes, sweet,	30-35				
Whole			<u>FRUITS:</u>		
Spinach leaf	2	21**	Blanch for peeling		
Chopped		21**	Fresh: Avocado	1	
Squash, acorn halves					
Butternut, quartered					
Squash whipped*		20**			

(Continued)

(continued from previous page)

FRUIT:	Fresh
Apple, cored	1
Grapefruit	1
Orange	1
Apricot	1
Pineapple, whole	2
Dried: add water to re-hydrate	
Apple	10
Apricot	10
Peach	10
Pear	10
Prune	10

MEATS & POULTRY:

Cook meats and poultry in nested pans, as juices can be used for gravy, sauces, beef stock and soups. The portion size, thickness, grades, should be considered when selecting a timer setting for doneness.

POULTRY:	Fresh	Frozen
Turkey, whole	6-8 min./lb.	6-8 min./lb.
Chicken, 5-8 oz.		
Breaded piece	18-20 min.	
halves, 1 1/4-1 1/2 lb. per half	20-24 min.	

PORK, SAUSAGE,

HOT DOGS:	Fresh	Frozen
Pork, Chop, 4 count/lb.	10 min.	
Italian sausage, 4 oz.	10 min.	
Ribs, 3lb. and down	20-26 min.	
Hot-dogs, 8 count/lb.	2 min.	

BEEF:	Fresh	Frozen
Cubes, 1 1/2"	6-7 min./lb.	6 min./lb.
Ground chuck for chili	4 min./lb.	4-6 min./lb.
Pot-roast, choice	8-12 min./lb.	
Rump roast, choice		
Boned, rolled, tied	12 min./lb.	
Meat loaf, 4lb. Loaf	5 min./lb.	
Liver, baby beef, 8oz.	2-4 min./lb.	2-4 min./lb.
Corned beef, 6-8lb. cut, add 1/2" water		
Pan	20-23 min./lb.	

STEAKS: : Fresh Frozen

Using a 3/4" to 1" steak, the steaming time listed below produces a "rare" steak. A "well done" steak is first steamed to the "rare" stage, then broiled or grilled for 1 1/2 minutes on each side. This "well done" steak shrinks less, is more tender and juicy; and, when served, is the same size as the "rare" steak.

STEAKS: :	Fresh
Sirloin Patties	
Chopped 8 oz	4 min.
Ribeye, 8 oz.	4 min.
Top butt steak 6 oz.	4 min.
8 oz.	6 min.
Filet Mignon, butterflied –	
4 oz.	3 min.
6 oz.	3-4 min.
8 oz.	4 min.
10 oz.	5 min.
16 oz.	8 min.
(Chateaubriand)	
Strip steak - 10-oz.	5 min.
12 oz.	7 min.
T-bone 12 oz.	5 min.
16 oz.	8 min.
18 oz.	8 min.
22 oz.	10 min.

PREPARED ENTREES: Fresh Frozen

PREPARED ENTREES:	Fresh	Frozen
Full Size Pans		
Cabbage rolls, stuffed*	25 min.	20 min.
Cover with tomato Sauce & serve		
Casserole dishes*		
Beef Stew	20-25 min	25-30 min.
Stroganoff	20-25 min.	25-30 min.
Lasagna* fresh	20-25 min	25-30 min.
Reheat ea. serving 4"	6-8 min.	12 min.

DEHYDRATED FOODS:

Potatoes* 2 1/2" random sliced
Plus 5 cups cold water /lb. 12 min.

RICE & BEANS:

Rice, long grain	
4 cups cold water/lb.	17 min.
Beans, pre-soaked overnight,	
1 lb. Beans = 1 1/4 qt. Water	45 min.
Beans* unsoaked,	
1 lb. Beans x 1 1/2 qt. water	2 1/2 Hours
Refried beans, 2-#10 cans	15-17 min.

PASTA:

Steam in nested pans. Place pasta on 2 1/2" perforated pan used as a liner in a solid 2 1/2" pan. Cover pasta with cold water.

Egg noodles, 1 1/2" wide	4-6 min. **
Lasagna noodles	10-12 min. **
Macaroni, shells, elbow	10-12 min. **
Rigatoni	10 min. **
Spaghetti, vermicelli	8 min. **
Spaghetti, regular	8 min. **

D. STEAMING TIPS - LOBSTER - CRAB - SHRIMP

1. Live Lobster and Crabs

- a. Live lobsters and crabs are steamed according to the time on the Suggested Timer Setting Guide.
- b. Steam them on a perforated pan with a catch pan (a solid pan) on a lower pan slide. Discard the juices and non-edible matter collected during steaming.

2. Lobster Tail 8 oz.

- a. To serve in a shell, cut the frozen lobster tail in half, lengthwise. Place the cut side up on a perforated pan. Steam 5-6 minutes or until the meat turns opaque white. Season and garnish to serve.
- b. To serve a butterfly lobster tail, thaw tail, cut top shell length-wise all the way to the tail fins. Spread shells apart and pull meat out. Close empty shell and lay meat on top of shell. Steam according to Suggested Timer Setting Guide.

For volume preparation:

20 to 25. 6-8 oz. Lobster tails can be steamed on one 12 x 20 x 1 perforated pan.

3. King Crab Legs

- a. Available as cooked and frozen. Steam just long enough to heat through.
- b. Served either whole or cut into 3 sections.
- c. Suggested Timer Settings 4 minutes
12 lb of sectioned legs per 12 x 20 x 2 ½ perforated pan
10 lb of whole legs per 12 x 20 x 2 ½ perforated pan

4. Shrimp

- a. Shrimp are available as:
 - Green shrimp in frozen 5 lb. blocks
 - Peeled, deveined and ready to cook
 - Peeled, deveined and cooked
- b. Shrimp is a very delicate seafood. When over cooked it becomes very rubbery, therefore, it is better to slightly under cook the shrimp rather than over cook it. Refer to Suggested Timer Setting Guide for cooking shrimp for various sizes.