



# Operators Manual

## Installation & Operation

### Direct Steam Table Top Mixers

**MODELS:**

MKDT-12-T, MKDT-20-T



MKDT-12-T



MKDT-20-T

*For a complete Service Manual  
refer to [www.clevelandrange.com](http://www.clevelandrange.com)*

 **Cleveland**

1333 East 179th St., Cleveland, Ohio, U.S.A. 44110

Enodis

Phone: (216) 481-4900 Fax: (216) 481-3782  
Visit our web site at [www.clevelandrange.com](http://www.clevelandrange.com)

# For your safety

## DANGER

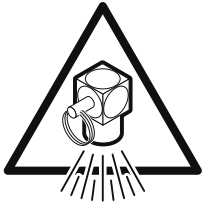

Keep clear of pressure relief discharge.



Keep hands away from moving parts and pinch points.

## IMPORTANT

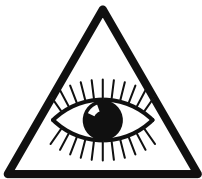

Inspect unit daily for proper operation.

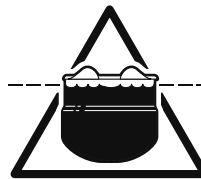

Do not fill kettle above recommended level marked on outside of kettle.

## CAUTION



Surfaces may be extremely hot! Use protective equipment.



Wear protective equipment when discharging hot product.



Do not lean on or place objects on kettle lip.



Stand clear of product discharge path when discharging hot product.

## SERVICING

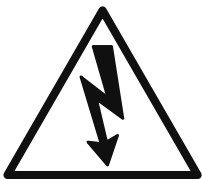

Shut off power at main fuse disconnect prior to servicing.

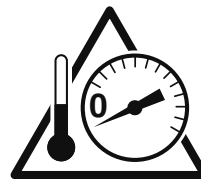

Ensure kettle is at room temperature and pressure gauge is showing zero or less prior to removing any fittings.

## GAS APPLIANCES

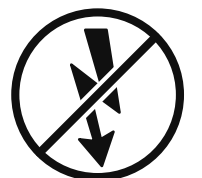

Do not attempt to operate this appliance during a power failure.



Keep appliance and area free and clear of combustibles.

# INSTALLATION

## GENERAL

Installation of the unit must be accomplished by qualified installation personnel working to all applicable local and national codes. Improper installation of product could cause injury or damage.

This unit is built to comply with applicable standards for manufacturers. Included among those approval agencies are: UL, NSF, ASME/Ntl.Bd., CSA, ETL, CE, and others. Many local codes exist, and it is the responsibility of the owner/installer to comply with these codes.

## INSPECTION

Before uncrating, visually inspect the unit for evidence of damage during shipping. If damage is noticed, do not unpack the unit, follow shipping damage instructions.

## SHIPPING DAMAGE INSTRUCTIONS

If shipping damage to the unit is discovered or suspected, observe the following guidelines in preparing a shipping damage claim.

1. Write down a description of the damage or the reason for suspecting damage as soon as it is discovered. This will help in filling out the claim forms later. If possible, take a polaroid picture.
2. As soon as damage is discovered or suspected, notify the carrier that delivered the shipment.
3. Arrange for the carrier's representative to examine the damage.
4. Fill out all carrier claims forms and have the examining carrier sign and date each form.

## INSTALLATION

The first installation step is to refer to the SPECIFICATION SHEET or SPECIFICATION DRAWING to determine the exact location of the kettle.

### CLEARANCE REQUIREMENTS TO COMBUSTIBLE AND NONCOMBUSTIBLE SURFACES:

	RIGHT	LEFT	BACK
MKDT-12-T	0"	0"	see below
MKDT-20-T	0"	0"	see below

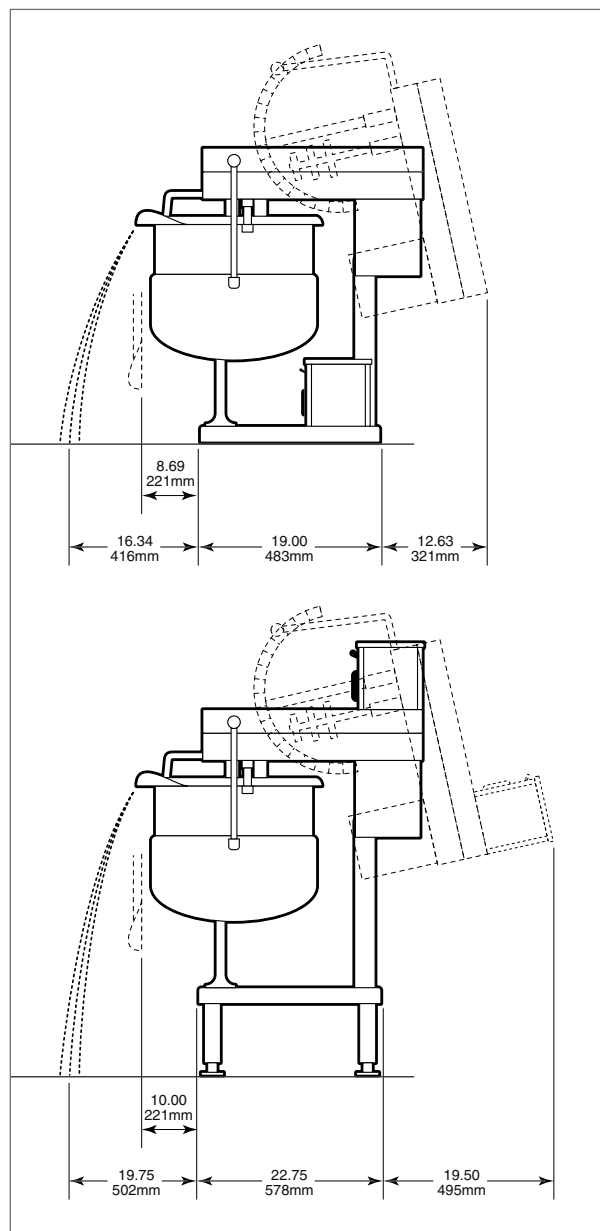

Clearance Requirements & Pour Path Drawing

# ASSEMBLY

## 12 Gallon Models

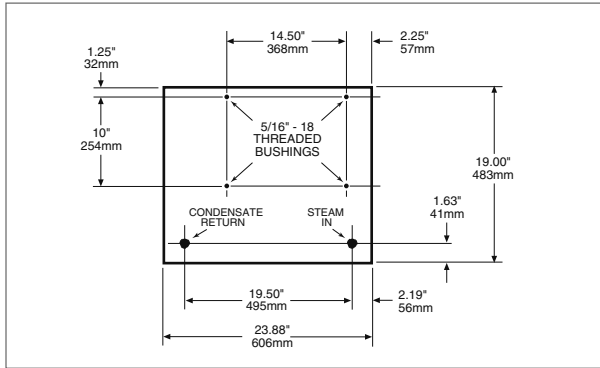

Base Mounting Diagram - Bottom view

1. Table-top models (12 gallon) must be positioned on a firm, level stand, or existing counter top, and bolted in place. These models are supplied with four threaded mounting bushings welded to the underside of the base.
2. Install service requirements as required (see below).
3. Once the kettle is secure and service utilities installed, screw tilt handle into the threaded hole provided at the right side of kettle.

## 20 Gallon Models

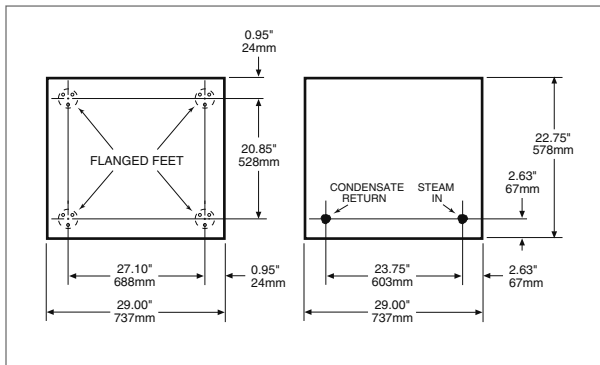

Base Mounting Diagram - Bottom views showing leg locations & utilities

1. Position on a firm, level surface, and bolt the four flange feet in place.
2. Install service requirements as required (see below).
3. Once the kettle is secure and service utilities installed, screw tilt handle into the threaded hole provided at the right side of kettle.

# RECOMMENDED PIPING SCHEMATICS

(all service connections shown supplied by others)

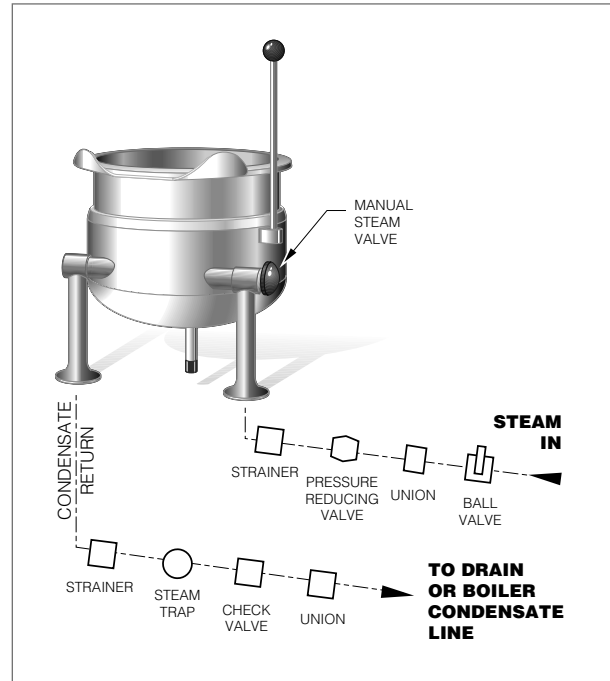

Recommended Piping Schematic

## STEAM

All steam plumbing to and from the kettle and steam boiler should be thoroughly cleaned and inspected for dirt and debris before final connection to the kettle are made.

Generally, kettles require 1/2" i.p.s. pipe, 10-45 psi steam pressure. If the steam supply pressure exceeds 45 psi, a pressure reducing valve is required. The steam inlet is at the right side of the kettle, as seen from the front.

## CONDENSATE

Maximum pressure rating on kettles is 50 psi. It is highly recommended that a pressure relief valve equal to or less than this pressure be installed on the incoming steam line close to the kettle.

A steam condensate trap must be plumbed to a drain, using minimum 1/2" NPT plumbing. The condensate line is limited to a maximum rise of 10 feet in order for the steam pressure to adequately force the condensate through the plumbing. Any higher rise requires a pump.

If the steam boiler to which this kettle is installed has a condensate return (closed loop system), a 1/2" steam strainer, a 1/2" steam trap, and a 1/2" check valve must be installed on the output (condensate) side of the kettle.

## **ELECTRICAL**

### ***ENSURE THE ELECTRICAL SUPPLY MATCHES THE KETTLE'S REQUIREMENTS AS STATED ON THE RATING LABEL.***

This kettle is built to comply with applicable standards of manufacturers. Included among these approval agencies are UL, NSF, ASME/Ntl. Bd., CSA, ETL, and others. Many local codes exist, and it is the responsibility of the owner and installer to comply with these codes.

The electrical supply must match the power requirements specified on the kettle's rating plate. The copper wiring must be adequate to carry the required current at the rated voltage. Refer to the Specification Sheet for all electrical specifications.

**Note:** Maximum voltage for LVD (low volt directive for Europe) to be 440 volts for CE marked appliances.

## **POTABLE WATER**

The water faucet (optional) with swing spout, requires 1/2 inch O.D. copper tube plumbing for hot or cold water supplies to the faucet (SPK - cold water connection only, DPK - hot and cold water connection).

## **INSTALLATION CHECKS**

Although the kettle has been thoroughly tested before leaving the factory, the installer is responsible for ensuring the proper operation of kettle once installed.

### **Final Installation Check**

- 1.** Partially fill the kettle with water.
- 2.** Slowly turn the steam control valve's knob to the open position.
- 3.** Release the safety valve, ensuring that the steam escapes freely. Stay clear of steam exhaust when releasing the safety valve.
- 4.** Observe that the water in the kettle comes to a boil.
- 5.** Close the steam supply valve.
- 6.** Drain off the water by tilting the kettle.

## **CLEANING**

After installation the kettle must be thoroughly cleaned and sanitized prior to cooking. See complete cleaning instructions in this manual.

# OPERATING INSTRUCTIONS

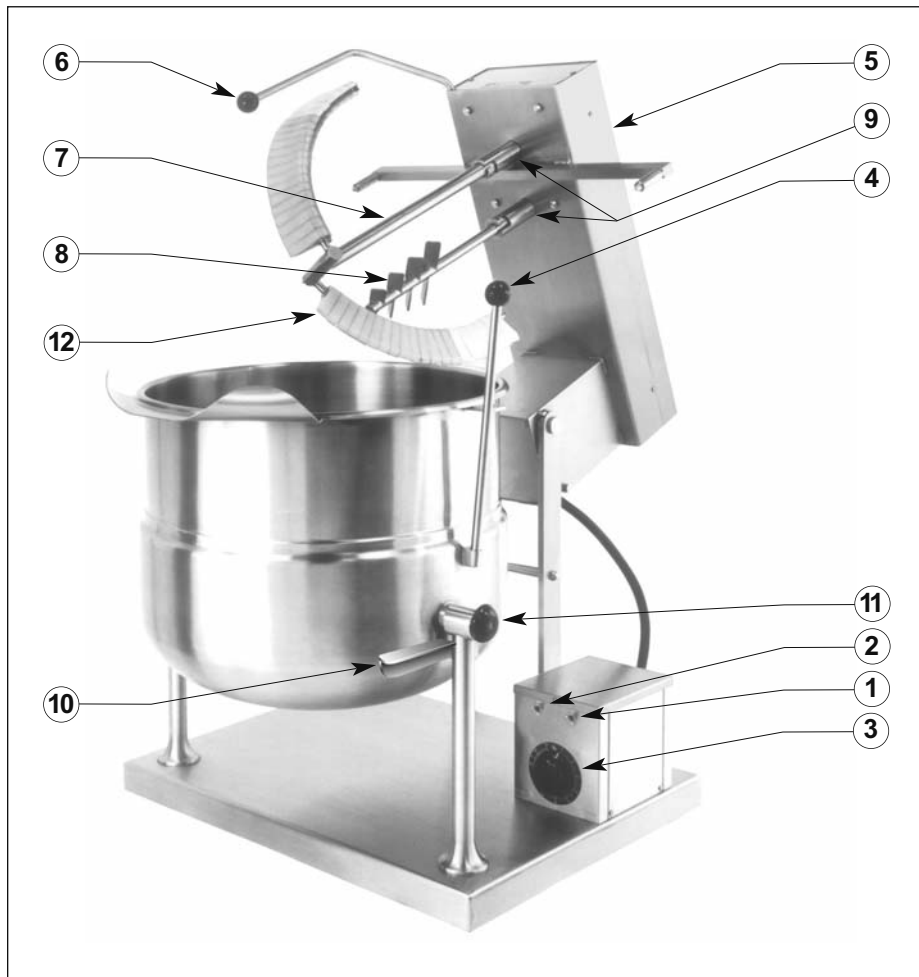

General Parts Drawing

ITEM #	DESCRIPTION	FUNCTION
1.	On-Off Toggle Switch	Controls electrical power to unit.
2.	Mixer Start Switch	Starts mixing action.
3.	Agitator Speed Control Knob	This control allows the operator to select agitator speed increments from Min. to Max.
4.	Kettle Tilt Handle	Used for tilting the kettle.
5.	Mixer Bridge	Encloses agitator motors.
6.	Mixer Bridge Tilt Handle	Used for tilting mixer bridge.
7.	Main Agitator Arm	Provides most of the product movement.
8.	Secondary Agitator Arm	Provides reverse agitation and product lift in kettle.
9.	Bayonet Mounts for Agitator Arms	Allows removal of main and secondary agitator arms without tools.
10.	Marine Lock	Prevents unit from accidental tilting.
11.	Steam Control Valve	Manually controls the amount of steam entering the steam jacket.
12.	Scraper Blades	

# **CLEVELAND STEAM COOKING EQUIPMENT IS INTENDED FOR COMMERCIAL USE ONLY BY PROFESSIONALLY TRAINED PERSONNEL.**

## **KETTLE OPERATION**

- 1.** Ensure that there is an adequate steam supply to the kettle.

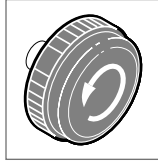

- 2.** Turn the Steam Control Valve (**11**) to the open position by turning the knob counter-clockwise, then allow the kettle to preheat.

**NOTE:** When cooking egg and milk products, the kettle should NOT be preheated, as products of this nature adhere to hot cooking surfaces. These types of foods should be placed in the kettle before heating is begun.

- 3.** Fill kettle with product to desired level.

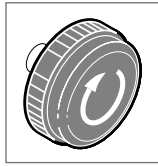

- 4.** When the product has reached the desired temperature, regulate the heat, as required, by turning the Steam Control Valve (**11**) clockwise for less steam, and therefore, a lower temperature.

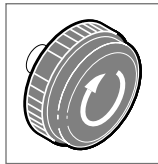

- 5.** When cooking is complete, close the Steam Control Valve (**11**) by turning the knob clockwise.

## **MIXER OPERATION**

- 1.** Turn Mixer Start Switch (**2**) to "ON".

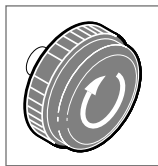

- 2.** Adjust Steam Control Valve (**11**) to desired setting.

## **FOR KETTLE/STEAMER COMBINATIONS:**

If the boiler in a steamer is supplying steam to a kettle, always heat the kettle first. After the kettle contents are heated, and the boiler's steam pressure returns to normal, the steamer may be used. Pressure steamer compartments should be sequentially started, and preheated before cooking.

**NOTE:** As with cleaning food soil from any cookware, an important part of kettle cleaning is to prevent food from drying on. For this reason, cleaning should be completed immediately after cooked foods are removed. Please read the "Care and Cleaning" instructions for detailed kettle washing procedures

## **Marine Lock**

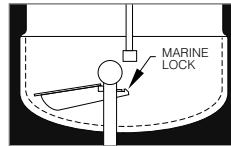

If your unit is equipped with a Marine Lock (**10**) to prevent accidental tilting, it must be inspected daily to insure it moves freely and automatically locks into place when kettle is returned to upright position.

Use the following procedure to tilt the kettle.

- 1.** Securely grasp the Kettle Tilt Handle (**4**).
- 2.** Push the Marine Lock (**10**) button down to unlock tilting mechanism.
- 3.** Pull the Kettle Tilt Handle (**4**) to tilt the kettle.
- 4.** When you return the kettle to its' original upright position the Marine Lock (**10**) will latch automatically.





# CLEANING INSTRUCTIONS



## CARE AND CLEANING

Cooking equipment must be cleaned regularly to maintain its fast, efficient cooking performance and to ensure its continued safe, reliable operation. The best time to clean is shortly after each use (allow unit to cool to a safe temperature).

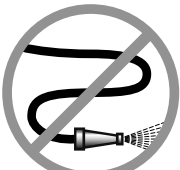
## WARNINGS

- ⇒  Do not use detergents or cleansers that are chloride based or contain quaternary salt.  
**Chloride Cleaners**
- ⇒  Do not use a metal bristle brush or scraper.  
**Wire Brush &**
- ⇒  Steel wool should never be used for cleaning the stainless steel.  
**Steel Pads**
- ⇒  Unit should never be cleaned with a high pressure spray hose.  
**High Pressure Spray Hose**
- ⇒  Do not leave water sitting in unit when not in use.  
**Stagnant Water**

## CLEANING INSTRUCTIONS

1. Turn unit off.
2. Remove drain screen (if applicable). Thoroughly wash and rinse the screen either in a sink or a dishwasher.
3. Prepare a warm water and mild detergent solution in the unit.
4. Remove food soil using a nylon brush.
5. Loosen food which is stuck by allowing it to soak at a low temperature setting.
6. Drain unit.
7. Rinse interior thoroughly.
8. If the unit is equipped with a **Tangent Draw-Off Valve**, clean as follows:
  - a) Disassemble the draw-off valve first by turning the valve knob counter-clockwise, then turning the large hex nut counter-clockwise until the valve stem is free of the valve body.
  - b) In a sink, wash and rinse the inside of the valve body using a nylon brush.
  - c) Use a nylon brush to clean tangent draw-off tube.
  - d) Rinse with fresh water.
  - e) Reassemble the draw-off valve by reversing the procedure for disassembly. The valve's hex nut should be hand tight only.
9. If the unit is equipped with a **Butterfly Valve**, clean as follows:
  - a) Place valve in open position.
  - b) Wash using a warm water and mild detergent solution.
  - c) Remove food deposits using a nylon brush.
  - d) Rinse with fresh water.
  - e) Leave valve open when unit is not in use.
10. Using mild soapy water and a damp sponge, wash the exterior, rinse, and dry.

## NOTES

- ⇒ For more difficult cleaning applications one of the following can be used: alcohol, baking soda, vinegar, or a solution of ammonia in water.
- ⇒ Leave the cover off when the kettle is not in use.
- ⇒ For more detailed instructions refer to the Nafem Stainless Steel Equipment Care and Cleaning manual (supplied with unit).



# STAINLESS STEEL EQUIPMENT CARE AND CLEANING

(Supplied courtesy of Nafem. For more information visit their web site at [www.nafem.org](http://www.nafem.org))

## Contrary to popular belief, stainless steels ARE susceptible to rusting.

Corrosion on metals is everywhere. It is recognized quickly on iron and steel as unsightly yellow/orange rust. Such metals are called "active" because they actively corrode in a natural environment when their atoms combine with oxygen to form rust.

Stainless steels are passive metals because they contain other metals, like chromium, nickel and manganese that stabilize the atoms. 400 series stainless steels are called ferritic, contain chromium, and are magnetic; 300 series stainless steels are called austenitic, contain chromium and nickel; and 200 series stainless, also austenitic, contains manganese, nitrogen and carbon. Austenitic types of stainless are not magnetic, and generally provide greater resistance to corrosion than ferritic types.

With 12-30 percent chromium, an invisible passive film covers the steel's surface acting as a shield against corrosion. As long as the film is intact and not broken or contaminated, the metal is passive and stain-less. If the passive film of stainless steel has been broken, equipment starts to corrode. At its end, it rusts.

## Enemies of Stainless Steel

There are three basic things which can break down stainless steel's passivity layer and allow corrosion to occur.

1. Mechanical abrasion
2. Deposits and water
3. Chlorides

**Mechanical abrasion** means those things that will scratch a steel surface. Steel pads, wire brushes and scrapers are prime examples.

**Water** comes out of the faucet in varying degrees of hardness. Depending on what part of the country you live in, you may have hard or soft water. Hard water may leave spots, and when heated leave deposits behind that if left to sit, will break down the passive layer and rust stainless steel. Other deposits from food preparation and service must be properly removed.

**Chlorides** are found nearly everywhere. They are in water, food and table salt. One of the worst chloride perpetrators can come from household and industrial cleaners.

## So what does all this mean? Don't Despair!

Here are a few steps that can help prevent stainless steel rust.

### 1. Use the proper tools.

When cleaning stainless steel products, use non-abrasive tools. Soft cloths and plastic scouring pads will not harm steel's passive layer. Stainless steel pads also can be used but the scrubbing motion must be in the direction of the manufacturers' polishing marks.

### 2. Clean with the polish lines.

Some stainless steel comes with visible polishing lines or "grain." When visible lines are present, always scrub in a motion parallel to the lines. When the grain cannot be seen, play it safe and use a soft cloth or plastic scouring pad.

### 3. Use alkaline, alkaline chlorinated or non-chloride containing cleaners.

While many traditional cleaners are loaded with chlorides, the industry is providing an ever-increasing choice of non-chloride cleaners. If you are not sure of chloride content in the cleaner used, contact your cleaner supplier. If your present cleaner contains chlorides, ask your supplier if they have an alternative. Avoid cleaners containing quaternary salts; it also can attack stainless steel and cause pitting and rusting.

### 4. Treat your water.

Though this is not always practical, softening hard water can do much to reduce deposits. There are certain filters that can be installed to remove distasteful and corrosive elements. To insure proper water treatment, call a treatment specialist.

### 5. Keep your food equipment clean.

Use alkaline, alkaline chlorinated or non-chloride cleaners at recommended strength. Clean frequently to avoid build-up of hard, stubborn stains. If you boil water in stainless steel equipment, remember the single most likely cause of damage is chlorides in the water. Heating cleaners that contain chlorides have a similar effect.

### 6. Rinse, rinse, rinse.

If chlorinated cleaners are used, rinse and wipe equipment and supplies dry immediately. The sooner you wipe off standing water, especially when it contains cleaning agents, the better. After wiping equipment down, allow it to air dry; oxygen helps maintain the stainless steel's passivity film.

### 7. Never use hydrochloric acid (muriatic acid) on stainless steel.

### 8. Regularly restore/passivate stainless steel.

## Recommended cleaners for specific situations

Job	Cleaning Agent	Comments
Routine cleaning	Soap, ammonia, detergent, Medallion	Apply with cloth or sponge
Fingerprints & smears	Arcal 20, Lac-O-Nu Ecoshine	Provides barrier film
Stubborn stains & discoloration	Cameo, Talc, Zud, First Impression	Rub in direction of polish lines
Grease & fatty acids, blood, burnt-on-foods	Easy-off, De-Grease It Oven Aid	Excellent removal on all finishes
Grease & oil	Any good commercial detergent	Apply with sponge or cloth
Restoration/Passivation	Benefit, Super Sheen	

## Review

1. Stainless steels rust when passivity (film-shield) breaks down as a result of scrapes, scratches, deposits and chlorides.
2. Stainless steel rust starts with pits and cracks.
3. Use the proper tools. Do not use steel pads, wire brushes or scrapers to clean stainless steel.
4. Use non-chlorinated cleaners at recommended concentrations. Use only chloride-free cleaners.
5. Soften your water. Use filters and softeners whenever possible.
6. Wipe off cleaning agent(s) and standing water as soon as possible. Prolonged contact causes eventual problems.

To learn more about chloride-stress corrosion and how to prevent it, contact the equipment manufacturer or cleaning materials supplier.

Developed by Packer Engineering, Naperville, Ill., an independent testing laboratory.

# **MAINTENANCE**

## **ALL SERVICE MUST BE PERFORMED BY A QUALIFIED SERVICE TECHNICIAN.**

This kettle requires very little preventative maintenance other than daily cleaning. The pressure relief valve must be tested twice a year.

---

### **PRESSURE RELIEF VALVE TESTING PROCEDURE**

**WARNING**  
Kettle will be hot. Use gloves for protection.

The pressure relief valve (optional on kettles) must be checked at least twice a year as part of the normal maintenance performed.

- 1.** Open steam valve and preheat kettle.
- 2.** Stand to the side of the pressure relief valve discharge tube and pull ring three or four times to insure free movement. Hold valve open for two seconds each time, insuring there is rapid steam escape each time.
- 3.** If valve appears to be sticking replace pressure relief valve. If foreign material is discharged, replace pressure relief valve and eliminate the source of contamination.

### **STEAM TRAP**

To remove line condensate that forms inside the steam jacket, each kettle should be equipped with a steam trap in the line of the kettle outlet to the drain. A good steam trap at startup releases air and wet steam into the drain line for a few minutes, then holds the steam jacket. During cooking, the trap periodically releases accumulated condensate. If the kettle's cooking performance becomes inadequate after long use, replacement of the steam trap with a new one may restore kettle operation to peak efficiency.

### **MARINE LOCK**

Inspect lock at least twice yearly.

- 1.** Check for excessive play or wear on pivot. Adjust or replace as required.
- 2.** Insure lock is catching over the centre of the stop pin and not bent to one side or the other. Adjust or replace as required.

### **WARRANTY**

Our Company supports a worldwide network of Maintenance and Repair Centers. Contact your nearest Maintenance and Repair Centre for replacement parts, service, or information regarding the proper maintenance and repair of your cooking equipment

In order to preserve the various agency safety certification (UL, NSF, ASME/Ntl. Bd., etc.), only factory-supplied replacement parts should be used. The use of other than factory supplied replacement parts will void warranty.