



Operators Manual

TR Gas Braising Pan Installation & Operation

For units built after August 2011

SGL-30-TR
SGM-30-TR
SGL-40-TR
SGM-40-TR



For your future reference.

Model # _____

Serial # _____

Model # & Serial #.
(Open front panel to view rating label.)



1333 East 179th St., Cleveland, Ohio, U.S.A. 44110
Ph: 216.481.4900 Fx: 216.481.3782
www.clevelandrange.com



***Read the manual thoroughly.
Improper installation, operation or
maintenance can cause property
damage, injury or death.***

TABLE OF CONTENTS

For your safety	1-2
Installation	3-5
Operating Instructions	6
Cleaning Instructions	7
Preventative Maintenance	8



FOR YOUR SAFETY / POUR VOTRE SÉCURITÉ / PARA SU SEGURIDAD

FOR YOUR SAFETY

Do not store or use gasoline or any other flammable liquids and vapours in the vicinity of this or any other appliance.

POUR VOTRE SÉCURITÉ

Ne pas entreposer ou utiliser d'essence ou d'autres liquides ou vapeurs inflammables à proximité de cet appareil ou de tout autre appareil.

PARA SU SEGURIDAD

No guarde ni use gasolina o cualesquiera otros líquidos o vapores inflamables en las cercanías de éste o cualquier otro aparato.

WARNING: Improper installation, adjustment, alteration, service, maintenance or operation can cause property damage, injury or death. Read the installation and operating instructions thoroughly before installing or servicing this equipment.

AVERTISSEMENT : Une mauvaise installation, un réglage inadapté, une modification non appropriée ou un manque d'entretien peuvent occasionner des dommages matériels, des blessures ou même la mort. Lire la notice de montage et d'exploitation avant d'installer ou d'entretenir cet équipement.

ADVERTENCIA: La instalación, ajuste, alteración, servicio, mantenimiento o funcionamiento incorrectos pueden causar daños a la propiedad, lesiones o muerte. Lea detenidamente las instrucciones de instalación y de operación antes de instalar o darle servicio a este equipo.

This appliance is not to be used by persons with reduced physical, sensory or mental capabilities, or lack of experience and knowledge, unless they have been given supervision or instruction concerning use of the appliance by a person responsible for their safety.

Cet appareil ne doit pas être utilisé par des personnes dont les capacités physiques, sensorielles ou mentales sont réduites, ou des personnes dénuées d'expérience ou de connaissance, sauf si elles ont pu bénéficier, par l'intermédiaire d'une personne responsable de leur sécurité, d'une surveillance ou d'instructions préalables concernant l'utilisation de l'appareil.

Este aparato no debe ser utilizado por personas con capacidades físicas, sensoriales o mentales reducidas, o que no tengan la experiencia y los conocimientos adecuados, a menos que estas personas hayan recibido supervisión e instrucciones en cuanto al uso del aparato por la persona responsable de la seguridad de ellas.

This appliance is not for use by children and they must be supervised not to play with it.

Cet appareil n'est pas destiné à être utilisé par des enfants et ils doivent être surveillés pour s'assurer qu'ils ne jouent pas avec l'appareil.

Este aparato no debe ser usado por los niños y ellos deben ser supervisados para que no jueguen con el aparato.

Post in a prominent location, instructions to be followed in the event the user smells gas. This information shall be obtained by consulting your local gas supplier.

Affichez à un endroit bien visible les instructions à suivre dans le cas où l'utilisateur sent une odeur de gaz. Ces informations seront obtenues auprès de votre fournisseur de gaz local.

No obstruya el flujo del aire combustión y de ventilación.

Do not obstruct the flow of combustion and ventilation air.

Ne pas obstruer le flux d'air de combustion et de ventilation.

Guarde este manual para su referencia.

Retain this manual for your reference.

Conservez ce manuel pour votre référence

FOR YOUR SAFETY / POUR VOTRE SÉCURITÉ / PARA SU SEGURIDAD

Hazard warnings are for your safety. Absence of a warning does not mean the hazard is not present. Unforeseen actions may result in unanticipated hazards. / Les avertissements de danger sont pour votre sécurité. L'absence d'un avertissement ne signifie pas que le danger n'est pas présent. Les actions imprévues peuvent entraîner des dangers

imprévus. / Las advertencias sobre los peligros son para su seguridad. La ausencia de una advertencia no significa que el peligro no está presente. Las acciones imprevistas podrían resultar en peligros no anticipados.

IMPORTANT / IMPORTANT / IMPORTANTE



Inspect unit daily for proper operation. / Inspectez l'unité tous les jours pour son bon fonctionnement. / Inspeccione diariamente el funcionamiento correcto de la unidad.

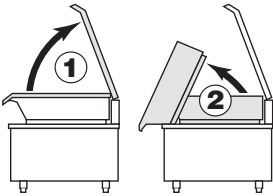

Lift lid before tilting skillet.

Ôtez le couvercle avant d'incliner la chaudière à frire.

Levante la tapa antes de inclinar la sartén.

CAUTION / ATTENTION / PRECAUCIÓN



Keep hands away from moving parts and pinch points. / Gardez les mains loin des pièces mobiles et des points de pincement. / Mantenga las manos lejos de piezas móviles y puntos de presión muy localizada.



Surfaces and product may be hot! Wear protective equipment. / Les surfaces et le produit peuvent être chauds! Portez un équipement de protection. / ¡Las superficies y el producto pueden estar calientes! Utilice equipo protector.



Hot! / Chauds ! / ¡Caliente!



Do not climb, sit or stand on equipment. / Il ne faut pas monter, s'asseoir ni se tenir debout sur l'équipement. / No subirse, ni sentarse ni pararse sobre el equipo.



Stand clear of product discharge path when discharging hot product. / Écartez-vous du chemin de décharge d'un produit chaud. / Permanezca alejado de la ruta de descarga del producto al vaciar producto caliente.



Do not lean on or place objects on kettle lip. / Ne vous appuyez pas et ne placez pas d'objets sur le bec de la chaudière. / No se apoye o coloque objetos en el borde de la marmita.

SERVICING / ENTRETIEN / SERVICIO



Have a qualified service technician maintain your equipment. / Confiez l'entretien de votre équipement à un technicien de service qualifié. / Confíe el mantenimiento de su equipamiento a un técnico de servicio calificado.

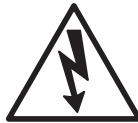

Remove electrical power prior to servicing. / Coupez l'alimentation électrique avant l'entretien. / Desconecte la energía eléctrica antes de darle servicio.

GAS APPLIANCES / APPAREILS À GAZ / APARATOS A GAS



Keep appliance and area free and clear of combustibles. / Gardez l'appareil et son entourage libre de tous combustibles. / Mantenga el aparato y el área libres de combustibles.



Do not attempt to operate this appliance during a power failure. / N'essayez pas de faire fonctionner cet appareil lors d'une panne de courant. / No intente poner en marcha este aparato durante un fallo de suministro eléctrico.



Shut gas supply off prior to servicing. / Fourniture de gaz fermée au loin avant d'entretenir. / Suministro de gas cerrado apagado antes del mantenimiento.



Unit exhaust contains carbon monoxide. Operate only under a properly functioning hood with adequate makeup air. / L'échappement de l'unité émet du monoxyde de carbone. Exploiter uniquement sous une hotte fonctionnant correctement avec une source adéquate d'air d'appoint. / El escape de la unidad contiene monóxido de carbono. Operar solamente bajo una campana en buen funcionamiento con aire de relleno adecuado.

INSTALLATION

GENERAL

Insure gas and electrical supplies match rating plate.

The rating plate is located directly behind the upper front panel (left side). For easy access, remove the two screws securing the upper front panel and hinge the lower front panel downwards. Gas type, burner ratings and electrical requirements are stated on the plate.

Installation of the unit must be accomplished by qualified installation personnel working to all applicable local and national codes.

This equipment is built to comply with applicable standards for manufacturers. Included among those approval agencies are: UL, A.G.A., NSF, ASME/N.Bd., CSA, CGA, ETL, and others. Many local codes exist, and it is the responsibility of the owner/installer to comply with these codes.

Observe all clearance requirements. Do not obstruct the flow of combustion and ventilation air.

RECEIVING INSPECTION

Before unpacking visually inspect the unit for evidence of damage during shipping.

If damage is noticed, do not unpack the unit, follow shipping damage instructions.

SHIPPING DAMAGE INSTRUCTIONS

If shipping damage to the unit is discovered or suspected, observe the following guidelines in preparing a shipping damage claim.

1. Write down a description of the damage or the reason for suspecting damage as soon as it is discovered. This will help in filling out the claim forms later.
2. As soon as damage is discovered or suspected, notify the carrier that delivered the shipment.
3. Arrange for the carrier's representative to examine the damage.
4. Fill out all carrier claims forms and have the examining carrier sign and date each form.

UNCRATING



CAUTION:

Straps under tension and will snap when cut. Carton may contain staples and skid contains nails. Use proper safety equipment and precautions. Unit is heavy. Use adequate help or lifting equipment as needed.



1. Cut straps and remove box.



2. Cut straps on unit.



3. Remove screws from back of flanged feet (x6).

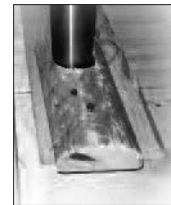

4. Remove nails to free blocks on front legs.

CLEARANCE REQUIREMENTS/ DRAIN LOCATIONS

This unit must be installed in accordance with the clearances shown on the rating label which is adhered to the unit.

FOR YOUR SAFETY. Keep the appliance area free and clear of combustible materials.

VENTILATION

Gas fired units are only to be installed under a ventilation hood in a room which has provisions for adequate make up air. Further information can be obtained by referring to the U.S.A. National Fire Protection Associations NFPA96 regulations. These standards have also been adopted by the National Building Code in Canada.



POSITIONING

This unit must be installed in accordance with the clearances shown on the rating label which is adhered to the unit.

Caution:

The actuator is mounted in center of unit, if using a fork truck, lift as illustrated.

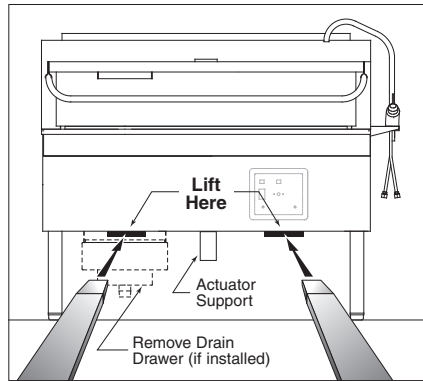

- 1 Position the unit in its permanent location.
2. Level skillet by means of adjustable stainless steel feet. For your convenience a foot wrench is taped to one leg. Use a spirit level and level unit four ways; across front and back and down left and right edges.
3. Once positioned and leveled, permanently secure the unit's flanged feet to the floor using 5/16" lag bolts and floor anchors (supplied by the installer). Three bolts are required to secure each of the flanged feet.
4. Seal joints of flanged feet with a silicone sealant.
5. Remove any protective material covering stainless steel panels.

GAS

ENSURE THE GAS SUPPLY MATCHES THE KETTLE'S REQUIREMENTS AS STATED ON THE RATING PLATE.

Installation must conform, with local codes or in the absence of local codes, with the National Fuel Gas Code ANSI Z223.1/NFPA 54, or the Natural Gas and Propane Installation Code, CSA B149.1 and B149-2 (Canada).

The appliance and its individual shut-off valve must be disconnected from the gas supply piping system during any pressure testing of that system at test pressures in excess of 1/2 psi (3.45 kPa).

The appliance must be isolated from the gas supply piping system by closing its individual manual shut-off valve during any pressure testing of the gas supply piping system at test pressures equal to or less than 1/2 psi (3.45 kPa).

It is recommended that a sediment trap (drip leg) be installed in the gas supply line. If the gas pressure exceeds 1/2 psi (3.45 kPa), a pressure regulator must be installed, to provide a maximum of 1/2 psi (3.45 kPa) gas pressure to the gas control valve.

Connect the gas line to the manual valve located at the rear left hand side. Use pipe joint sealant that is approved for use with liquefied petroleum gas.

A pressure tap is supplied with each unit and is installed on the manifold. The gas pressure must be checked when unit is installed, to ensure unit gas pressure is the same as specified on the rating plate. For access to the pressure tap, remove front panel, turn power switch to the 'OFF' position as a precaution and hinge front panel downwards. The pressure tap is located behind the front shield. If necessary, pressure adjustments can be made at the pressure regulator which is installed on the manifold. For easy access to the pressure regulator, view along left side of unit from underneath. Once pressure test is completed, turn power switch and thermostat to the 'OFF' position. Raise lower front panel back into position.

ELECTRICAL

ENSURE THE ELECTRICAL SUPPLY MATCHES THE UNIT'S REQUIREMENTS AS STATED ON THE RATING LABEL.

A cord and plug are supplied with the 115 volt unit. Simply plug the unit into any grounded outlet rated for a minimum of 10 amps.

WARNING:



Electrical Grounding Instructions.

This unit is equipped with a three-prong (grounding) plug for your protection against shock hazard and should be plugged directly into a properly grounded three-prong receptacle. Do not cut or remove the grounding prong from this plug.

Standard supply voltage is 115 volts A.C., however, optional A.C. voltages can be supplied on special order. A separate fused disconnect switch must be supplied and installed in the high voltage electrical supply line. The unit when installed, must be electrically installed and grounded in accordance with local codes, or in the absence of local codes, with National Electrical Code, ANSI/NFPA 70-1990 (USA) or the Canadian Electrical Code, CSA C22.2, Part 1 (Canada)

When a unit is ordered and built for 208/240 volt, the supply line must be connected to the wiring terminations located inside the console. Wiring diagram is located on the bottom side of component enclosure cover.

The wiring diagram is located on the back of the console access panel.

CLEANING

After installation the unit must be thoroughly cleaned and sanitized prior to cooking

INSTALLATION CHECKS

Although the unit has been thoroughly tested before leaving the factory, the installer is responsible for ensuring the proper operation of unit once installed.

1. Supply power to the unit by placing the fused disconnect switch to the "ON" position.
2. Turn on main gas supply to unit. Open the unit's shut-off valve (located at lower rear left).
3. Toggle HI / OFF / LO Switch to the "HI" or "LO" position.
4. For your safety the unit is equipped with a power interrupter which automatically shuts off the gas supply to the burners whenever the unit is raised more than 8°.
5. Turn temperature control to maximum. Tilt pan until heat indicator light turns off and heating system shuts down. The pan should be on a 5-10° angle.
6. Lower pan. Heat indicator light will re-light and heating system will re-energize.
7. Unit will continue to heat, heat indicator light will remain on until temperature is reached. Then the heat indicator light will cycle OFF indicating the heating system has shut off. The heat indicator light will continue to cycle ON and OFF as the heating system cycles ON and OFF maintaining the desired temperature.
8. Toggle HI / OFF / LO Switch to the "OFF" position.
9. Check carbon monoxide is less than 0.08 percent in an air-free sample of the flue gases. See FREE AIR CALCULATION procedure in "Maintenance Procedures & Parts Lists" manual.



OPERATING INSTRUCTIONS

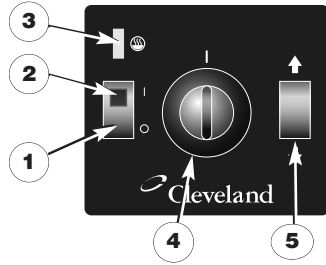

- | # | DESCRIPTION |
|-----|------------------------------------|
| 1. | On-Off Switch |
| 2. | Power Indicator Light (Red) |
| 3. | Heat Indicator Light (Yellow) |
| 4. | Temperature Dial |
| 5. | Power Tilt Switch |
| 6. | Manual Tilt Override |
| 7. | Tangent Draw-Off Valve (not shown) |
| 8. | Faucet (not shown) |
| 9. | Gas Shut Off Valve |
| 10. | Flue |

WARNING:

If ignition fails and/or the control system goes into lockout, set power switch to the 'OFF' position.

Wait 5 minutes then repeat steps 1 through 3. If the problem persists, have a qualified serviceman check the system.



OPERATING THE UNIT

1. Perform daily startup inspection.
2. Turn Power Switch to the ON position. The yellow Heat Indicator Light will indicate pan is heating.
3. **MANUAL TILT:** To raise pan, raise the cover and turn the crank clockwise. To lower pan, turn counterclockwise.
POWER TILT: To raise pan, raise the cover and press up on the tilt switch. To lower pan, press down on the tilt switch.



FOR YOUR SAFETY: A power interrupter will automatically shut off the power to the elements whenever the skillet is raised more than 1/2" (13mm).

IMPORTANT: Before commencing to cook, ensure pan is in the lowered position.

4. To preheat, set Temperature Dial to desired cooking temperature.
5. Allow skillet to preheat for approximately 15-30 minutes.
6. Once preheated, insert product in skillet and adjust Temperature Dial to required cooking temperature.
7. If desired, once product has cooked, it can be held prior to serving at a lower temperature setting.
8. When cooking is completed, set Temperature Dial and Power Switch to the OFF position.
9. Pour the contents of the unit into an appropriate container by tilting the kettle forward or using discharge valve.

NOTE: Cleaning should be completed immediately after cooked foods are removed.



OPEN COVER BEFORE TILTING PAN

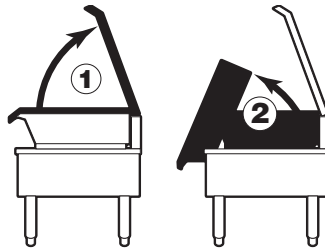

POWER TILT MANUAL OVERRIDE INSTRUCTIONS

NOTE: Once unit has been tilted there is now way to lower it until power is restored.



1. Remove plug.



2. Reach under skillet and remove tilt handle.

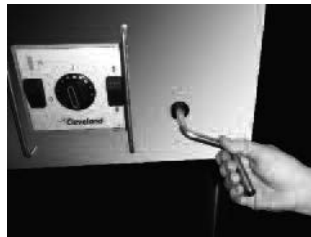

3. Insert handle onto pump shaft and turn.

OPERATING SUGGESTIONS

1. Turn power switch to the "OFF" position when skillet is not in use.
2. Allow skillet to preheat before adding product.
3. Always lift the spring assist cover before activating the tilt mechanism.
4. During an electrical power interruption, turn Power Switch to the OFF position. This unit cannot be made to operate without electrical power.

CLEANING INSTRUCTIONS



CARE AND CLEANING

Cooking equipment must be cleaned regularly to maintain its fast, efficient cooking performance and to ensure its continued safe, reliable operation. The best time to clean is shortly after each use (allow unit to cool to a safe temperature).

WARNINGS



Chloride Cleaners

Do not use detergents or cleansers that are chloride based or contain quaternary salt.



Wire Brush & Scrapers

Do not use a metal bristle brush or scraper.



Steel Pads

Steel wool should never be used for cleaning the stainless steel.

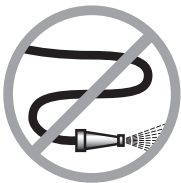

High Pressure Spray Hose

Unit should never be cleaned with a high pressure spray hose.



Stagnant Water

Do not leave water sitting in unit when not in use.

CLEANING INSTRUCTIONS

1. Turn unit off.
2. Remove drain screen (if applicable). Thoroughly wash and rinse the screen either in a sink or a dishwasher.
3. Prepare a warm water and mild detergent solution in the unit.
4. Remove food soil using a nylon brush.
5. Loosen food which is stuck by allowing it to soak at a low temperature setting.
6. Drain unit.
7. Rinse interior thoroughly.
8. If the unit is equipped with a **Tangent Draw-Off Valve**, clean as follows:
 - a) Disassemble the draw-off valve first by turning the valve knob counter-clockwise, then turning the large hex nut counter-clockwise until the valve stem is free of the valve body.
 - b) In a sink, wash and rinse the inside of the valve body using a nylon brush.
 - c) Use a nylon brush to clean tangent draw-off tube.
 - d) Rinse with fresh water.
 - e) Reassemble the draw-off valve by reversing the procedure for disassembly. The valve's hex nut should be hand tight only.
9. Using mild soapy water and a damp sponge, wash the exterior, rinse, and dry.

NOTES

- ⇒ For more difficult cleaning applications one of the following can be used: alcohol, baking soda, vinegar, or a solution of ammonia in water.
- ⇒ Leave the cover off when the kettle is not in use.
- ⇒ For more detailed instructions refer to Stainless Steel Equipment Care and Cleaning (www.nafem.org/resources/stainlesssteelfinal.doc) on Nafem's website (www.nafem.org).

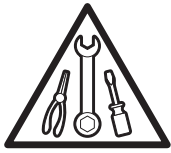

PREVENTATIVE MAINTENANCE

FOR MAINTENANCE AND REPAIRS CONTACT YOUR AUTHORIZED
MANITOWOC SERVICE AGENCY AND HAVE A QUALIFIED
SERVICE TECHNICIAN MAINTAIN YOUR EQUIPMENT.

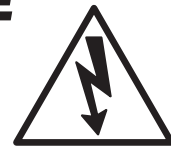

Cleveland Range equipment requires little preventative maintenance. We do however provide the following guidelines for inspection and maintenance to keep your unit functioning at 100%.



DAILY PRE-STARTUP INSPECTION

1. Pan (A) tilts up and down correctly.
2. Tilt switch (if equipped) (E) is not broken and is functioning properly.
3. Red Light (F) comes on when unit is turned on.
4. Orange Light (G) is off when unit is tilted.
5. Orange Light (G) is off when unit is heating.
6. Temperature dial (H) is in place and functioning properly.
7. Cover (B) tilts up and down freely and is held in place when fully open.
8. Side (C) and rear (D) panels are in place.
9. Draw-Off Valve (if equipped) is installed and handle is in place.

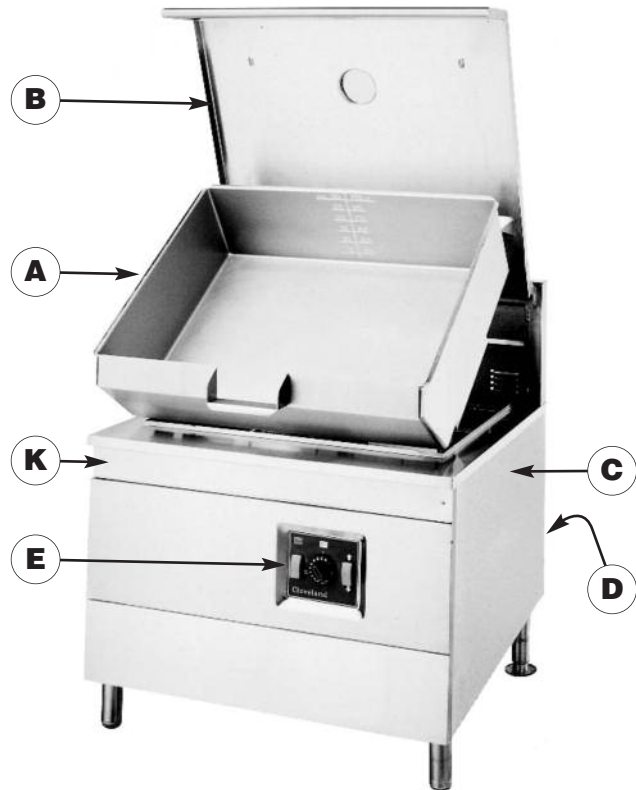

SIX MONTH SERVICE INSPECTION

1. Perform daily startup inspection.
2. Tilt hand wheel is tight (if equipped).
3. Fasteners securing panels (K) are in place and tight.
4. There are no hydraulic oil leaks.
5. Adequate exhaust and makeup air is supplied to working area.

YEARLY SERVICE INSPECTION

1. Perform six month service inspection.
2. Check units maximum temperature setting.
3. Inspect safety thermostat for proper connections.
4. No oil leaks in tilting system.
5. Clean blower.
6. Perform fre air calculation (see FREE AIR CALCULATION).

