

Compact Refrigerators & Freezers

400 & 4000 Series

Original Instructions

Service Manual

English



Safety Notices

⚠ Warning

Read this manual thoroughly before operating, installing or performing maintenance on the equipment. Failure to follow instructions in this manual can cause property damage, injury or death.

⚠ DANGER

Do not install or operate equipment that has been misused, abused, neglected, damaged, or altered/modified from that of original manufactured specifications.

⚠ DANGER

Keep power cord AWAY from HEATED surfaces. DO NOT immerse power cord or plug in water. DO NOT let power cord hang over edge of table or counter.

⚠ DANGER

All utility connections and fixtures must be maintained in accordance with Local and national codes.

⚠ Warning

Authorized Service Representatives are obligated to follow industry standard safety procedures, including, but not limited to, local/national regulations for disconnection / lock out / tag out procedures for all utilities including electric, gas, water and steam.

⚠ Warning

Do not store or use gasoline or other flammable vapors or liquids in the vicinity of this or any other appliance. Never use flammable oil soaked cloths or combustible cleaning solutions, for cleaning.

⚠ Warning

This product contains chemicals known to the State of California to cause cancer and/or birth defects or other reproductive harm. Operation, installation, and servicing of this product could expose you to airborne particles of glasswool or ceramic fibers, crystalline silica, and/or carbon monoxide. Inhalation of airborne particles of glasswool or ceramic fibers is known to the State of California to cause cancer. Inhalation of carbon monoxide is known to the State of California to cause birth defects or other reproductive harm.

⚠ Warning

Do not use electrical appliances or accessories other than those supplied by the manufacturer.

⚠ Warning

Use caution when handling metal surface edges of all equipment.

⚠ Warning

This appliance is not intended for use by persons (including children) with reduced physical, sensory or mental capabilities, or lack of experience and knowledge, unless they have been given supervision concerning use of the appliance by a person responsible for their safety. Do not allow children to play with this appliance.

⚠ Caution

Use caution handling, moving and use of the R290 refrigerators to avoid either damaging the refrigerant tubing or increasing the risk of a leak. Components shall be replaced with like components. Servicing shall be done by a factory authorized service personnel to minimize the risk of possible ignition due to incorrect parts or improper service.

Notice

Proper installation, care and maintenance are essential for maximum performance and trouble-free operation of your equipment. Visit our website www.mtwkitchencare.com for manual updates, translations, or contact information for service agents in your area.

Table of Contents

Section 1

General Information

Model Numbers	5
Serial Number Location	5
Warranty Information	5
Regulatory Certifications	5

Section 2

Installation

Location	7
Weight of Equipment	8
Clearance Requirements.....	8
Dimensions	8
Electrical Service	9
Voltage	9
Rated Amperages, Horsepower, Voltage & Power Cord Chart.....	9
Heat of Rejection	9
Drain Connections.....	10
Caster Or Leg Installation	10
Leg Leveling	10
Caster and Leg Mounting Detail.....	11
Loosen Freezer Compressor Bolts.....	11

Section 3

Operation

Controls/Programming/Settings	14
R404A Refrigerators.....	14
R290 Refrigerators.....	14
Freezers	15
Evaporator Fan Operation.....	15

Section 4

Maintenance

Cleaning and Sanitizing Procedures.....	17
General.....	17
Interior Cleaning.....	18
Exterior Cleaning.....	18
Doors/Hinges.....	18
Preventing Blower Coil Corrosion	19
Field Installation	19
Casters.....	19
Cleaning the Condenser Coil	19
Drain.....	19
Evaporator Drain Line Maintenance, Part 1	20
Evaporator Drain Line Maintenance, Part 2	20

Section 5

Troubleshooting

Problem -> Cause -> Correction Chart.....	21
---	----

**Section 6
Refrigeration**

R404A

Refrigerant Recovery / Evacuation & Recharging.....23
 Charging Procedures23
 System Contamination Clean-up24
 Mild System Contamination Clean-Up Procedure25
 Severe System Contamination Clean-Up Procedure25
 Filter Driers26
 Refrigerant Re-Use Policy26

R290

Refrigeration Components Overview.....27
 Properties of R-290 (Propane).....28
 Service Procedures.....29
 Normal Operating Temperatures for Models Using Refrigerant R290.....31
 86°F (30°C) Ambient / 32° (0°C) Degree Box Temperature32
 100°F (38°C) Ambient / 32°F (0°C) Box Temperature33
 Review34

**Section 7
Air Flow**

Unit Air Flow Design35

**Section 8
Control**

Power Cord at Junction Box.....36
 R290 Refrigeration Control Specifications.....36
 Control Thermistor Connections.....37
 Thermistor Installation37
 Unit Operation.....37
 Service Tips37

**Section 9
Diagrams**

R404A Compressor Wiring.....38
 Models 402, 406, 406CA, ST4048 & UC404839
 402P, 406P, 406CAP, ST4048P, UC4048P40
 Export Models 402-CE, 406-CE, 406CA-CE, ST4048-CE & UC4048-CE.....41
 Models 403, 407, 407CA, ST4148 & UC414842
 Export Models 403-CE, 407-CE & 407CA-CE.....43
 Export Models ST4148-CE & UC4148-CE44

**Section 10
Replacement Procedures**

406P - Connect Compressor's Starter Box45
 Door Mounting Bracket46
 Door Gasket46

Section 1

General Information

Model Numbers

This manual covers standard units only.

NOTE: For custom units, consult Manitowoc KitchenCare at 1-844-724-CARE.

Work Top Refrigerator Bases With Stainless Steel Top & Backsplash	
402, 402P	ST4048, ST4048P

Undercounter Refrigerator Bases With Stainless Steel Top	
406, 406P	UC4048, UC4048P

Undercounter Refrigerator With Subtop And 3.75" Casters	
406CA, 406CAP	

The prefix P on a model number indicates the use of the refrigerant propane.

Work Top Freezer Bases With Stainless Steel Top & Backsplash	
403	ST4148

Undercounter Freezer Bases With Stainless Steel Top	
407	UC4148

Undercounter Freezer With Subtop And 3.75" Casters	
407CA	

Serial Number Location

The serial number on 400 series compact refrigerators and freezers is printed on the right side of the interior back wall.

The serial tag on 4000 series compact refrigerators and freezers is located either on the left upper sidewall inside the cabinet or under the top nosing directly above the door when the door is in the closed position (right hand door when there are two doors).

Always have the serial number of your unit available when calling for parts or service.

Warranty Information

Visit

http://www.delfield.com/minisite/service/warranty_info to:

- Register your product for warranty.
- Verify warranty information.
- View and download a copy of your warranty.

Regulatory Certifications

Models are certified by:

- National Sanitation Foundation (NSF)
- Underwriters Laboratories (UL)
- Underwriters Laboratories of Canada (CUL)

THIS PAGE INTENTIONALLY LEFT BLANK

Section 2 Installation

⚠ DANGER

Installation must comply with all applicable fire and health codes in your jurisdiction.

⚠ DANGER

Use appropriate safety equipment during installation and servicing

⚠ Warning

Remove all removable panels before lifting and installing.

⚠ Warning

Do not damage the refrigeration circuit when installing, maintaining or servicing the unit.

Location

⚠ Warning

This equipment must be positioned so that the plug is accessible unless other means for disconnection from the power supply (e.g., circuit breaker or disconnect switch) is provided.

⚠ Warning

Adequate means must be provided to limit the movement of this appliance without depending on or transmitting stress to the electrical conduit or gas lines.

⚠ Warning

To avoid instability the installation area must be capable of supporting the combined weight of the equipment and product. Additionally the equipment must be level side to side and front to back.

⚠ Warning

This equipment is intended for indoor use only. Do not install or operate this equipment in outdoor areas.

⚠ Caution

Do not position the air intake vent near steam or heat exhaust of another appliance.

The location selected for the equipment must meet the following criteria. If any of these criteria are not met, select another location.

- Units are intended for indoor use only.
- The location **MUST** be level, stable and capable of supporting the weight of the equipment.
- The location **MUST** be free from and clear of combustible materials.
- Equipment **MUST** be level both front to back and side to side.
- Position the equipment so it will not tip or slide.
- Front casters **MUST** be locked once positioned.
- Recommended air temperature is 41° - 86°F (5° - 30°C).
- Proper air supply for ventilation is **REQUIRED AND CRITICAL** for safe and efficient operation. Refer to Clearance Requirements chart on page 8.
- Do not obstruct the flow of ventilation air. Make sure the air vents of the equipment are not blocked.

- Do not install the equipment directly over a drain. Steam rising up out of the drain will adversely affect operation, air circulation, and damage electrical / electronic components.

Weight of Equipment

Model	Weight
402, 402P	176lbs (80kg)
403	184lbs (83kg)
406, 406P	176lbs (80kg)
406CA, 406CAP	168lbs (76kg)
407	176lbs (80kg)
407CA	168lbs (76kg)
ST4048, ST4048P	234lbs (106kg)
ST4148	242lbs (110kg)
UC4048, UC4048P	236lbs (107kg)
UC4148	236lbs (107kg)

Clearance Requirements

⚠ DANGER

Minimum clearance requirements are the same for noncombustible locations as for combustible locations. The flooring under the appliance must be made of a noncombustible material.

⚠ DANGER

Risk of fire/shock. All minimum clearances must be maintained. Do not obstruct vents or openings.

Back	3.00" (76mm)
Top / Sides	1.00" (25mm)
Bottom	2.00" (51mm)

- Keep the vents clean and free of obstruction.
- The factory installed legs must be used and not removed.

Dimensions

Model	Length	Depth	Height
402, 402P	27" (69cm)	28.5" (72cm)	39.5" (100cm)
403	27" (69cm)	28.5" (72cm)	39.5" (100cm)
406, 406P	27" (69cm)	28.5" (72cm)	35.5" (90cm)
406CA, 406CAP	27" (69cm)	27.75" (70cm)	33.25" (84cm)
407	27" (69cm)	28.5" (72cm)	35.5" (90cm)
407CA	27" (69cm)	27.75" (70cm)	33.25" (84cm)
ST4048, ST4048P	48" (122cm)	28.5" (72cm)	39.5" (100cm)
ST4148	48" (122cm)	28.5" (72cm)	39.5" (100cm)
UC4048, UC4048P	48" (122cm)	28.5" (72cm)	35.5" (90cm)
UC4148	48" (122cm)	28.5" (72cm)	35.5" (90cm)

Model	Volume	Shelf Space
402 402P 403 406 406P 406CA 406CAP 407 407CA	5.7Ft ³ (161L)	4.6Ft ² (43dm ²)
ST4048 ST4048P ST4148 UC4048 UC4048P UC4148	10.80Ft ³ (306L)	8.0Ft ² (74dm ²)

Electrical Service

⚠ DANGER
 Check all wiring connections, including factory terminals, before operation. Connections can become loose during shipment and installation.

⚠ DANGER
 Units with two power cords must be plugged into individual branch circuits. During movement, cleaning or repair it is necessary to unplug both power cords.

⚠ Warning
 This appliance must be grounded and all field wiring must conform to all applicable local and national codes. Refer to rating plate for proper voltage. It is the responsibility of the end user to provide the disconnect means to satisfy the authority having jurisdiction.

VOLTAGE

All electrical work, including wire routing and grounding, must conform to local, state and national electrical codes.

The following precautions must be observed:

- The equipment must be grounded.
- A separate fuse/circuit breaker must be provided for each unit.
- A qualified electrician must determine proper wire size dependent upon location, materials used and length of run (minimum circuit ampacity can be used to help select the wire size).
- The maximum allowable voltage variation is $\pm 10\%$ of the rated voltage at equipment start-up (when the electrical load is highest).
- Check all green ground screws, cables and wire connections to verify they are tight before start-up.

RATED AMPERAGES, HORSEPOWER, VOLTAGE & POWER CORD CHART

Units with plugs are supplied with approximately 6ft (183cm) cords.

Models 406 and 407 may be stacked using a stacking collar. In this case two 6ft (183cm) long grounded supply cords and plugs are standard.

Model	Amps	HP	Voltage, Cycle, Phase	NEMA Plug
402, 402P	4.0	1/5	115/60/1	5-15P
403	5.8			
406, 406CA, 406CAP, 406P	4.0			
407, 407CA	5.8			
ST4048, ST4048P	4.0			
ST4148	5.6	1/3		
UC4048, UC4048P	4.0	1/5		
UC4148	5.6	1/3		

Heat of Rejection

Model	BTU/Hour Capacity	Heat of Rejection	Charge
402	1100	1430	7oz R404A
402P	1356	210	100g R290
403	840	1092	7oz R404A
406	1100	1430	7oz R404A
406CA	1100	1430	7oz R404A
406CAP	1356	210	100g R290
406P	1356	210	100g R290
407	800	339	6.5oz R404A
407CA	800	339	6.5oz R404A
ST4048	1100	1430	7oz R404A
ST4048P	1356	316	100g R290
ST4148	1080	1404	7oz R404A
UC4048	1100	1430	7oz R404A
UC4048P	1356	316	100g R290
UC4148	1080	1404	7oz R404A

Drain Connections

⚠ Warning

If a refrigerated base does not have a condensate evaporator supplied, you must connect the condensate line to a suitable drain. Otherwise, water will collect on the floor, causing a potentially hazardous situation.

⚠ Warning

Moisture collecting from improper drainage can create a slippery surface on the floor and a hazard to employees. It is the owner's responsibility to provide a container or outlet for drainage.

Caster Or Leg Installation

⚠ DANGER

Legs or casters must be installed and the legs or casters must be screwed in completely to prevent bending. When casters are installed the mass of this unit will allow it to move uncontrolled on an inclined surface. These units must be tethered/secured to comply with all applicable codes.

⚠ Warning

The unit must be installed in a stable condition with the front wheels locked. Locking the front casters after installation is the owner's and operator's responsibility.

⚠ Warning

Use a jack to lift the refrigeration unit off the ground just far enough to remove the leg/caster. Place blocking underneath the unit. Do not work underneath a raised unit without proper blocking. Do not lift the unit more than necessary to remove the leg/caster. Lifting the unit too far can make the unit unstable.

⚠ Caution

All single-section units require that the swivel casters be mounted on the front and rigid casters be mounted on the rear.

Installation Instructions

1. Carefully place the unit on its back.
2. Located at each caster mounting location are 4 Phillips head screws, for a total of 16 screws. Remove them.
3. Place a locking plate caster or leg over one of the front holes, matching the 4 mounting holes to the pre-drilled holes in the underside of the unit. Insert 4 Phillips head screws and tighten. Repeat with the other locking front caster or leg.
4. Repeat step 3 with the non-locking casters or legs in the rear of the unit.
5. Carefully lift the unit upright.

⚠ Caution

After installing casters, the unit must stand upright for twenty-four (24) hours before being powered up to assure oil return to the compressor sump.

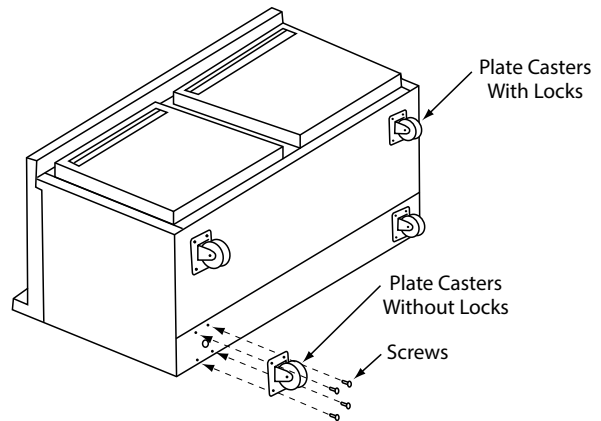

LEG LEVELING

All four legs are adjustable. Adjust each leg until the unit is stable and level left to right. If necessary adjusting the front legs slightly higher than the rear by about 1/8" (3mm) will help the door remain closed.

CASTER AND LEG MOUNTING DETAIL

A universal bolt hole pattern is provided on the bottom of the cabinet. It will accommodate any leg or caster. Simply line up the plate holes with the corresponding cabinet holes.

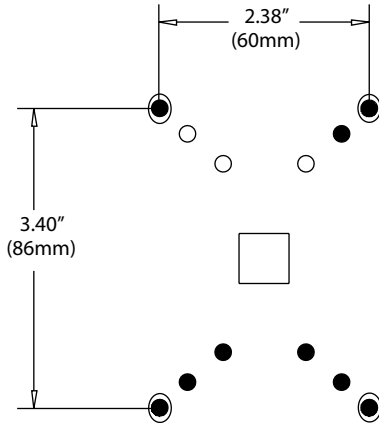

NOTE: If hole pattern on caster/leg matches the one above mount in outer set of holes.

- 6" Leg - 3234569

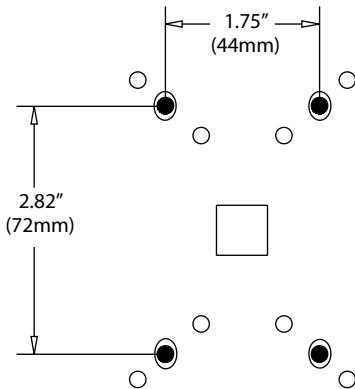

NOTE: If hole pattern on caster/leg matches the one above mount in middle set of holes.

- 3" Caster - 3234024
- 5" Caster - 3234161
- 6" Leg - 3234791

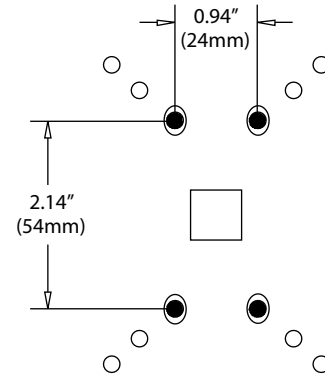

NOTE: If hole pattern on caster/leg matches the one above mount in inner set of holes.

- 2" Caster - 3234148

Loosen Freezer Compressor Bolts

Semi hermetic models should be loosened before operating. Loosen (but do not remove) the bolts on the compressor. If not done the freezer may vibrate excessively when the compressor is running,

THIS PAGE INTENTIONALLY LEFT BLANK

Section 3 Operation

DANGER

The on-site supervisor is responsible for ensuring that operators are made aware of the inherent dangers of operating this equipment.

DANGER

Do not operate any appliance with a damaged cord or plug. All repairs must be performed by a qualified service company.

DANGER

Never stand on the unit! They are not designed to hold the weight of an adult, and may collapse or tip if misused in this manner.

Warning

Do not contact moving parts.

Warning

All covers and access panels must be in place and properly secured, before operating this equipment.

Warning

Do not use electrical appliances inside the food storage compartment of this appliance.

Warning

The operator of this equipment is solely responsible for ensuring safe holding temperature levels for all food items. Failure to do so could result in unsafe food products for customers.

Warning

Overloading shelves can damage equipment or cause bodily injury.

Warning

Damp or wet hands may stick to cold surfaces.

Caution

Do not block the supply and return air grills or the air space around the air grills. Keep plastic wrappings, paper, labels, etc. from being airborne and lodging in the grills. Failure to keep the air grills clear will result in unsatisfactory operation of the system.

Caution

Do not throw items into the storage area. Failure to heed this recommendation could result in damage to the interior of the cabinet or to the blower coil.

Controls/Programming/Settings

R404A REFRIGERATORS

After the unit is connected to power it will automatically begin operating. With the doors closed, the temperature of the cabinet should reach 36°F to 40°F (2°C to 4°C) on refrigerators in about one hour.

A thermostat located in the evaporator housing on interior rear of the unit, controls the temperature in the box. The factory setting for the control is 4 and maintains about 38°F (3°C) in the box. Set toward 1 for higher temperatures and toward 7 for lower temperatures.

Refrigerators defrost automatically with every cycle of the compressor. The water generated is routed to a pan on the rear of the unit and is evaporated by the heat given off by the compressor.

During normal operation the evaporator fan may cycle and/or pulse independently of the compressor. Consult the service manual or contact Technical Support at 1-844-724-CARE if you are unsure of the proper function.

R290 REFRIGERATORS

At initial start-up or anytime power is disconnected, then reconnected to the unit, the control will delay all operations for a short time (up to 30 minutes.) While in this delay period the control will initialize.

With the doors closed, the temperature of the cabinet should reach 36°F to 40°F (2°C to 4°C) on refrigerators in about one hour. The electronic temperature control constantly monitors box temperature and evaporator coil temperature to maintain consistent product temperatures.

Refrigerators periodically go into defrost to allow the accumulated frost on the evaporator to clear, the compressor and condenser fan motor will turn off when the temperature control detects a certain evaporator temperature. After the defrost cycle is complete, the temperature control will return to a normal cooling cycle. The water generated is routed to a pan on the rear of the unit and is evaporated by the heat given off by the compressor.

During normal operation the evaporator fan may cycle and/or pulse independently of the compressor. Consult the service manual or contact Technical Support at 1-844-724-CARE if you are unsure of the proper function.

Electronic Temperature Control Location & Adjustment

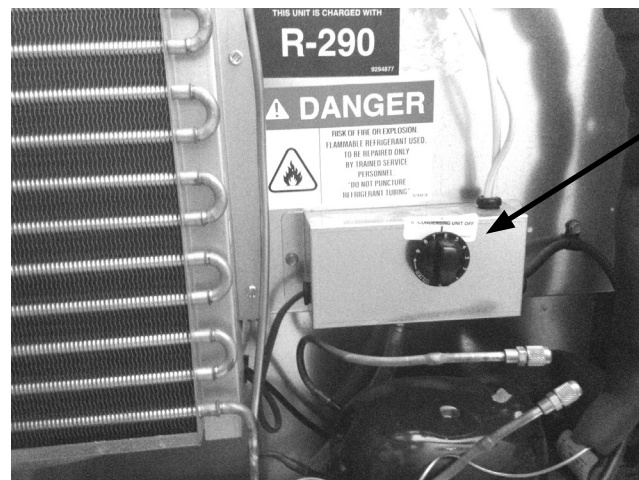

Rear View Of R290 Refrigerator

The control is located in the control box at the rear of the unit. **Never turn the knob more than one dial number and always allow eight hours for temperature stabilization before making any additional adjustments.** To adjust for colder temperatures, turn the knob clockwise. For warmer temperatures, turn the knob counter-clockwise. Turn the knob fully counter-clockwise to turn the refrigeration system off.

FREEZERS

This unit does not have a power switch, plug the unit in to begin operation. At initial start-up or anytime power is disconnected, then reconnected to the unit, the control will delay all operations for a short time (up to 40 minutes.) While in this delay period, the control initializes the control parameters and confirms that the temperature sensors and circuits are operational.

After initializing, the control will immediately enter a DEFROST mode. The compressor and condenser fan as well as the evaporator fan will remain off until initial defrost is complete. This initial defrost cycle may take up to 15 minutes to complete, at which time the freezing cycle will begin.

After initializing and the defrost cycle, the electronic temperature control will cycle the compressor, evaporator fan motor, and condenser fan motor to maintain box temperature at the control setting.

With the doors closed, the temperature of the cabinet should reach 0°F (-18°C) on freezers in about one hour after the freezing cycle begins. The electronic temperature control constantly monitors box temperature as well as evaporator coil temperature to maintain consistent product temperatures. As an added energy-saving feature, the electronic controller will switch the evaporator fan motor on and off with the compressor and condenser fan motor.

During normal operation the evaporator fan may cycle and/or pulse independently of the compressor. Consult the service manual or contact Technical Support at 1-844-724-CARE if you are unsure of the proper function.

Electronic Temperature Control Location & Adjustment

Never turn the knob more than one dial number and always allow eight hours for temperature stabilization before making any additional adjustments. The control is located in the control box at the rear of the unit. It is factory set at mid-range to maintain about -3°F (-18°C) box temperature. To adjust for colder temperatures, turn the knob clockwise. For warmer temperatures, turn the knob counter-clockwise. Turn the knob fully counter-clockwise to turn the refrigeration system off.

Freezer Automatic Defrost

The control also monitors compressor total running time and will enter a defrost cycle after total compressor running time is greater than five hours since the last defrost cycle OR if evaporator coil temperature drops below -34°F (-37°C) (indicating excessive frost on the coil).

Freezer Manual Defrost

If a manual defrost is desired, simply unplug the unit for several seconds, then plug unit back in. This will cause the control to re-initialize and then enter a defrost cycle.

When the control enters the defrost mode, whether manual or automatic, it switches off the evaporator fan motor, compressor and condenser fan motor, and switches on the defrost heater to warm the evaporator coil and melt all frost accumulated during the previous refrigeration cycle. The control will continue the defrost cycle for a MINIMUM of eight minutes and a MAXIMUM of 30 minutes depending on the amount of frost accumulated on the evaporator coil.

After the defrost cycle is complete, the control returns to a normal refrigeration cycle, however the evaporator fan motor will not switch on for two minutes AFTER the compressor and condenser fan motor have begun operating.

EVAPORATOR FAN OPERATION

	Cooling Cycle		Defrost Cycle
	Compressor On	Compressor Off	Compressor Off
	Evap Fan	Evap Fan	Evap Fan
R404A Refrigerators	On	On	On
R290 Refrigerators	On	Cycles On 3-Min Off 3Min	On
Freezer	On	Off	Off

THIS PAGE INTENTIONALLY LEFT BLANK

Section 4 Maintenance

⚠ DANGER

It is the responsibility of the equipment owner to perform a Personal Protective Equipment Hazard Assessment to ensure adequate protection during maintenance procedures.

⚠ DANGER

Failure to disconnect the power at the main power supply disconnect could result in serious injury or death. The power switch DOES NOT disconnect all incoming power.

⚠ DANGER

Disconnect electric power at the main power disconnect for all equipment being serviced. Observe correct polarity of incoming line voltage. Incorrect polarity can lead to erratic operation.

⚠ Warning)

Never use sharp objects or tools to remove ice or frost. Do not use mechanical devices or other means to accelerate the defrosting process.

Cleaning and Sanitizing Procedures

⚠ Caution

Maintenance and servicing work other than cleaning as described in this manual must be done by an authorized service personnel.

GENERAL

⚠ Warning

When using cleaning fluids or chemicals, rubber gloves and eye protection (and/or face shield) must be worn.

You are responsible for maintaining the equipment in accordance with the instructions in this manual. Maintenance procedures are not covered by the warranty.

Maintenance	Daily	Weekly	Monthly	After Prolonged Shutdown	At Start-Up
Interior	X			X	X
Gasket	X		X	X	X
Exterior	X			X	X
Drain		X		X	X
Condenser Coil			X	X	X
Casters			X	X	X

INTERIOR CLEANING**Notice**

When cleaning interior and exterior of unit, care should be taken to avoid the front power switch and the rear power cord. Keep water and/or cleaning solutions away from these parts.

Notice

Never use a high-pressure water jet for cleaning or hose down or flood interior or exterior of units with water. Do not use power cleaning equipment, steel wool, scrapers or wire brushes on stainless steel or painted surfaces.

The interior can be cleaned using soap and warm water. If this isn't sufficient, try ammonia and water or a nonabrasive liquid cleaner.

EXTERIOR CLEANING**Notice**

Never use an acid based cleaning solution on exterior panels! Many food products have an acidic content, which can deteriorate the finish. Be sure to clean the stainless steel surfaces of ALL food products.

Clean the area around the unit as often as necessary to maintain cleanliness and efficient operation.

Wipe gasket and surfaces with a damp cloth rinsed in water to remove dust and dirt from the outside of the unit. Always rub with the "grain" of the stainless steel to avoid marring the finish. If a greasy residue persists, use a damp cloth rinsed in a mild dish soap and water solution. Wipe dry with a clean, soft cloth.

Never use steel wool or abrasive pads for cleaning. Never use chlorinated, citrus based or abrasive cleaners.

Stainless steel exterior panels have a clear coating that is stain resistant and easy to clean. Products containing abrasives will damage the coating and scratch the panels. Daily cleaning may be followed by an application of stainless steel cleaner which will eliminate water spotting and fingerprints. Early signs of stainless steel breakdown are small pits and cracks. If this has begun, clean thoroughly and start to apply stainless steel cleaners in attempt to restore the steel.

DOORS/HINGES

Over time and with heavy-use doors, the hinges may become loose. If this happens, tighten the screws that mount the hinge brackets to the frame of the unit. Loose or sagging doors can cause the hinges to pull out of the frame, which may damage both the doors and the hinges. In some cases this may require qualified service agents or maintenance personnel to perform repairs.

Door Adjustment

If the door needs lowering at the handle, use a 5/16" (8mm) wrench to loosen the hinge screws and install a spacer outside of the hinge. Tighten the screws.

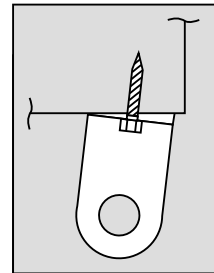

If the door needs to be higher at the handle, use a 5/16" (8mm) wrench to loosen the hinge screws and install a spacer inside of the hinge. Tighten the screws.

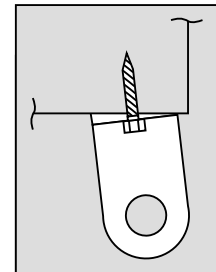

PREVENTING BLOWER COIL CORROSION

To help prevent corrosion of the blower coil, store all acidic items, such as pickles and tomatoes, in seal-able containers. Immediately wipe up all spills.

FIELD INSTALLATION

Over shelves and other items mounted to the top of the counters should never be installed in the field due to the potential damage to the refrigeration system.

CASTERS

Wipe casters with a damp cloth monthly to prevent corrosion.

CLEANING THE CONDENSER COIL

In order to maintain proper refrigeration performance, the condenser fins must be cleaned of dust, dirt and grease regularly. It is recommended that this be done monthly. If conditions are such that the condenser is totally blocked in a month, the frequency of cleaning should be increased. Clean the condenser with a vacuum cleaner or stiff brush. If extremely dirty, a commercially available condenser cleaner may be required. Keep cleaning liquid away from control, fans and compressor; keep these components dry.

Failure to maintain a clean condenser coil can initially cause high temperatures and excessive run times. Continuous operation with a dirty or clogged condenser coil can result in compressor failure. Neglecting the condenser coil cleaning procedures will void any warranties associated with the compressor and cost to replace the compressor.

DRAIN

Each unit has a drain located inside the unit that removes the condensation from the evaporator coil and routes it to an external condensate evaporator pan. Each drain can become loose or disconnected during normal use. If you notice water accumulation on the inside of the unit, be sure the drain tube is connected to the evaporator drain pan. If water is collecting underneath the unit, make sure the end of the drain tube is in the condensate evaporator. The leveling of the unit is important as the units are designed to drain properly when level. Be sure all drain lines are free of obstructions.

Evaporator Drain Line Maintenance, Part 1

1. Unplug the power cord from the outlet or shut the breaker off at the breaker panel if the unit is hard wired.
2. Remove the 5/16" hex head screws from the back panel on the back side of the unit to access the drain line.



3. Disconnect the clear rubber tubing drain line from the 90° copper pipe.

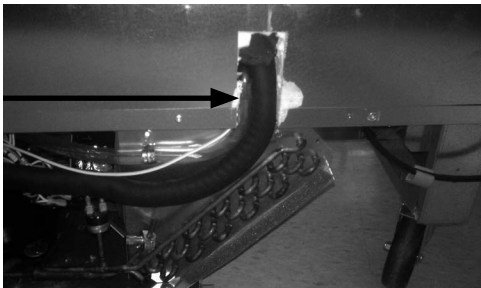

4. Clean the drain line of debris using a plastic straw or compressed air.
5. Reconnect the rubber hose drain line to the copper 90°.
6. Reinstall the back panel.
7. Plug the unit back in.

Evaporator Drain Line Maintenance, Part 2

NOTE: If the unit continues to leak water after following Part 1 instructions proceed with Part 2 instructions.

1. Unplug the power cord from the outlet or shut the breaker off at the breaker panel if the unit is hard wired.
2. Remove the shelves or drawer boxes from the unit.
3. If the unit has a center bracket that holds the shelves up then loosen the wing nuts and remove the shelf bracket.



4. Remove the four 5/16" hex head screws from the evaporator cover. Pull the evaporator cover off.

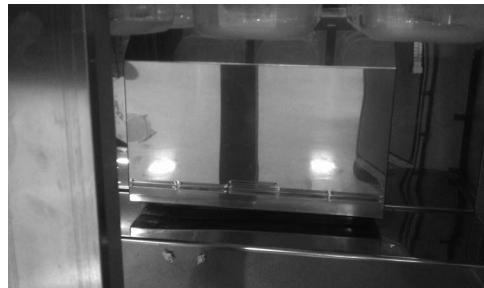

5. Locate the evaporator drain line toward the back of the drain pan on either the left or right side.

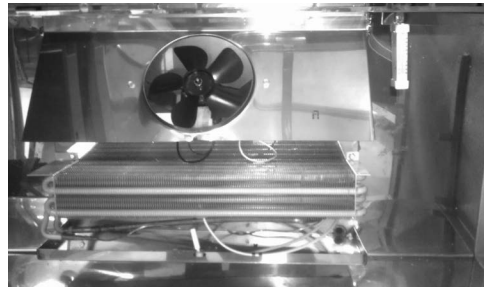

6. Clear drain and drain line of any debris using a plastic straw, compressed air, or warm water.
7. Reinstall the evaporator cover with the four 5/16" hex head screws.
8. If a center bracket was removed, reinstall it and secure it with wing nuts.
9. Reinstall the shelves or drawer boxes.
10. Plug the unit back in or turn the breaker on at the breaker panel.

Section 5 Troubleshooting

Problem -> Cause -> Correction Chart

Problem	Cause	Correction
Cabinet not running	Fuse blown or circuit breaker tripped.	Replace fuse or reset circuit breaker.
	Power cord unplugged.	Plug in power cord.
	Thermostat set too high.	Set thermostat to lower temperature.
	Main power switch turned off.	Turn main power switch on.
	Cabinet in defrost cycle. (Freezer models)	Wait for defrost cycle to finish.
Condensing unit runs for long periods or continuously	Excessive amount of warm product placed in cabinet.	Allow adequate time for product to cool down.
	Prolonged door openings or door(s) ajar.	Make sure door(s) are closed when not in use. Avoid prolonged door openings.
	Door gasket(s) not sealing properly.	Check gasket condition. Adjust door or replace gasket if necessary.
	Dirty condenser coil.	Clean the condenser coil.
	Evaporator coil iced over.	Turn unit off and allow coil to defrost. Make sure thermostat is not set too cold. Also, check gasket condition.
Cabinet temperature is too high	Thermostat set too high.	Set thermostat to lower temperature.
	Poor air circulation in cabinet.	Re-arrange product to allow proper air circulation.
	Exterior thermometer is out of calibration.	Re-calibrate thermometer.
	Excessive amount of warm product placed in cabinet.	Allow adequate time for product to cool down.
	Prolonged door openings or door(s) ajar.	Make sure door(s) are closed when not in use. Avoid prolonged door openings.
	Dirty condenser coil.	Clean the condenser coil.
	Evaporator coil iced over.	Turn unit off and allow coil to defrost. Make sure thermostat is not set too cold. Also, check gasket condition.
Cabinet is noisy	Loose part(s).	Locate and tighten loose part(s).
Refrigerator is freezing product	Thermostat is set too low.	Set thermostat to higher temperature.
	Dirty condenser coil.	Clean the condenser coil.
	Not enough cabinet clearance for proper refrigeration system operation.	Move cabinet or make other adjustments to gain proper cabinet clearances.
Compressor will not start	Low voltage to cabinet.	Check and correct incoming voltage to cabinet.

THIS PAGE INTENTIONALLY LEFT BLANK

Section 6

Refrigeration

R404A

Refrigerant Recovery / Evacuation & Recharging

Do not purge refrigerant to the atmosphere. Capture refrigerant using recovery equipment by specific manufacturer's recommendations.

Important

We assume no responsibility for the use of contaminated refrigerant. Damage resulting from the use of contaminated refrigerant is the sole responsibility of the servicing company.

Connections

1. Suction side of the compressor through the suction service valve.
2. Discharge side of the compressor through the discharge service valve.

Self-Contained Recovery/Evacuation

1. Disconnect power to the unit.
2. Install manifold gauges, charging cylinder/scale, and recovery unit or two-stage vacuum pump.
3. Perform recovery or evacuation:
 - A. Recovery: Operate the recovery unit as directed by the manufacturer's instructions.
 - B. Evacuation prior to recharging: Pull the system down to 250 microns. Then, allow the pump to run for an additional half hour. Turn off the pump and perform a standing vacuum leak check.

NOTE: Check for leaks using halide or electronic leak detector after charging the Reach-In.

Charging Procedures

Important

The charge is critical on all Reach-In units. Use a scale or a charging cylinder to ensure the proper charge is installed.

1. Disconnect power to the unit.
2. Close the vacuum pump valve, the low side service valve, and the low side manifold gauge valve.
3. Open the high side manifold gauge valve and the high side service valve.
4. Open the charging cylinder and add the proper refrigerant charge (shown on nameplate) through the discharge service valve.
5. Let the system "settle" for 2 to 3 minutes.
6. Connect power up the unit.
7. Close the high side valve on the manifold gauge set. Add any remaining vapor charge through the suction service valve (if necessary).

NOTE: Manifold gauges must be removed properly to ensure that no refrigerant contamination or loss occurs.

8. Make sure that all the vapor in the charging hoses is drawn into the Reach-In before disconnecting the charging hoses.
 - A. Run the Reach-In cooling mode.
 - B. Close the high side service valve at the Reach-In.
 - C. Open the low side service valve at the Reach-In.
 - D. Open the high and low side valves on the manifold gauge set. Any refrigerant in the lines will be pulled into the low side of the system.
 - E. Allow the pressures to equalize while the Reach-In is running.
 - F. Close the low side service valve at the Reach-In.
 - G. Remove the hoses from the Reach-In and install the caps.

System Contamination Clean-up

This section describes the basic requirements for restoring contaminated systems to reliable service.

Important

We assume no responsibility for the use of contaminated refrigerant. Damage resulting from the use of contaminated refrigerant is the sole responsibility of the servicing company.

Determining Severity Of Contamination

Either moisture or residue generally causes system contamination from compressor burnout entering the refrigeration system.

Inspection of the refrigerant usually provides the first indication of system contamination. Obvious moisture or an acrid odor in the refrigerant indicates contamination.

If either condition is found, or if contamination is suspected, use a Total Test Kit from Totaline or a similar diagnostic tool. Follow the manufacturer's directions. These devices sample refrigerant, eliminating the need to take an oil sample.

If a refrigerant test kit indicates harmful levels of contamination, or if a test kit is not available, inspect the compressor oil.

1. Remove the refrigerant charge from the Reach-In.
2. Remove the compressor from the system.
3. Check the odor and appearance of the oil.
4. Inspect the suction and discharge lines at the compressor for burnout deposits.
5. If no signs of contamination are present, perform an acid oil test.

Check the chart below to determine the type of cleanup required.

Contamination/Clean-up Chart	
Symptoms/Findings	Required Cleanup Procedure
No Symptoms or suspicion of contamination	Normal evacuation/recharging procedure
Moisture/Air Contamination symptoms <ul style="list-style-type: none"> • Refrigeration system open to atmosphere for prolonged periods • Refrigeration test kit and/or acid oil test shows contamination <ul style="list-style-type: none"> • Leak in water-cooled condenser • No burnout deposits in open compressor lines 	Mild contamination clean-up procedure
Mild Compressor Burnout symptoms <ul style="list-style-type: none"> • Oil appears clean but smells acrid • Refrigeration test kit or acid oil test shows harmful acid content <ul style="list-style-type: none"> • No burnout deposits in open compressor lines 	Mild contamination clean-up procedure
Severe Compressor Burnout symptoms <ul style="list-style-type: none"> • Oil is discolored and smells acrid • Refrigeration test kit or acid oil test shows harmful acid content • Burnout deposits found in the compressor and lines, and in other components 	Severe contamination clean-up procedure

Mild System Contamination Clean-Up Procedure

1. Replace any failed components.
2. If the compressor is good, change the oil.
3. Replace the liquid line drier.

NOTE: If the contamination is from moisture, use heat lamps during evacuation. Position them at the compressor, condenser and evaporator prior to evacuation.

Important

Dry nitrogen is recommended for this procedure. This will prevent CFC release.

4. Follow the normal evacuation procedure, except replace the evacuation step with the following:
 - A. Pull vacuum to 1000 microns. Break the vacuum with dry nitrogen and sweep the system. Pressurize to a minimum of 5 PSI.
 - B. Pull vacuum to 500 microns. Break the vacuum with dry nitrogen and sweep the system. Pressurize to a minimum of 5 PSI.
 - C. Change the vacuum pump oil.
 - D. Pull vacuum to 250 microns. Run the vacuum pump for ½ hour on self-contained models, 1 hour on remotes.

NOTE: You may perform a standing vacuum test to make a preliminary leak check. You should use an electronic leak detector after system charging to be sure there are no leaks.

5. Charge the system with the proper refrigerant to the nameplate charge.
6. Operate the Reach-In unit.

Severe System Contamination Clean-Up Procedure

1. Remove the refrigerant charge.
2. Remove the compressor.
3. Remove the liquid line drier.
4. Replace the capillary tube.
5. Wipe away any burnout deposits from suction and discharge lines at compressor.
6. Sweep through the open system with dry nitrogen.

Important

Refrigerant sweeps are not recommended, as they release CFC's into the atmosphere.

7. Install a new compressor and new start components.
8. Install a suction line filter-drier (with acid and moisture removal capability) of adequate size. Place the filter drier as close to the compressor as possible.
9. Install inlet and outlet access valves.
10. Install a new liquid line drier.
11. Follow the normal evacuation procedure, except replace the evacuation step with the following:
 - A. a) Pull vacuum to 1000 microns. Break the vacuum with dry nitrogen and sweep the system. Pressurize to a minimum of 5 PSI.
 - B. Change the vacuum pump oil.
 - C. Pull vacuum to 500 microns. Break the vacuum with dry nitrogen and sweep the system. Pressurize to a minimum of 5 PSI.
 - D. Change the vacuum pump oil.
 - E. Pull vacuum to 250 microns. Run the vacuum pump for ½ hour on self-contained models, 1 hour on remotes.

NOTE: You may perform a standing vacuum test to make a preliminary leak check. You should use an electronic leak detector after system charging to be sure there are no leaks.

12. Charge the system with the proper refrigerant to the nameplate charge.
13. Operate the Reach-In unit for one hour. Then check the pressure drop across the suction line filter-drier.
 - A. If the pressure drop is less than 1 PSI, the filter-drier should be adequate for complete clean up.
 - B. If the pressure drop exceeds 1 PSI, change the suction line filter-drier and the liquid line drier.

Repeat steps 8 through 13 until the pressure drop is acceptable.

14. Operate the Reach-In unit for 48-72 hours. Then remove the suction line filter-drier and change the liquid line drier.
15. Follow normal evacuation procedures.

Filter Driers

The size of the filter-drier is important. Using an improperly sized filter-drier will cause the Reach-In unit to be improperly charged with refrigerant.

Important

Driers are covered as a warranty part. Driers must be replaced any time the system is opened for repairs.

Refrigerant Re-Use Policy

We recommend the use of:

1. New Refrigerant
 - Must be of original nameplate type.
2. Reclaimed Refrigerant
 - Must be of original nameplate type.
3. Recovered or Recycled Refrigerant
 - Must be recovered or recycled in accordance with current local, state and federal laws.
 - Must be from and re-used in the same McCall product. Re-use of recovered or recycled refrigerant from other products is not approved.
 - Recovered refrigerant must come from a "contaminant-free" system. To decide whether the system is contaminant free, consider:
 - A. Type(s) of previous failure(s)
 - B. Whether the system was cleaned, evacuated and recharge properly following failure(s)
 - C. Compressor motor burn outs and improper past service, prevent refrigerant re-use.

R290

Refrigeration Components Overview

Delfield R290 under counter refrigeration components include:

- A self contained R-290 (propane) refrigerant system
- A Danfoss ETC solid state temperature control with on demand defrost
- Danfoss ETC control is mounted to the control box mounted to the back of the unit.
- Refrigeration metering device is a capillary tube
- Labels describing the dangers of R-290 (propane) are on the back of the unit.



R290 Refrigeration Component Identification

- Epoxy coated evaporator coil
- A hot gas condensate evaporator pan assembly is mounted on the back of the unit.

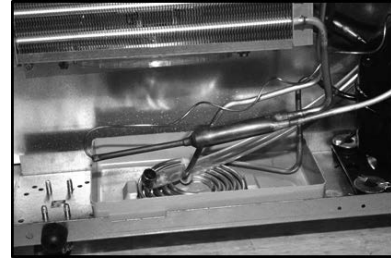

- Capillary tube metering device
- Danfoss control thermistors

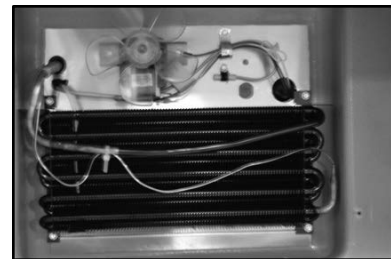

- Under Counter R-290 compressors have a spark proof cover over the electrical terminals and capacitor

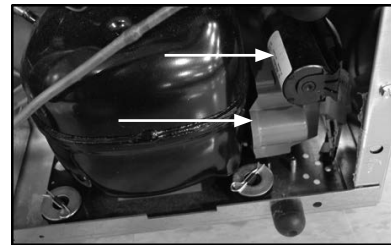

Properties of R-290 (Propane)

- R-290 is an alternative (not drop in replacement) for most commonly used refrigerants
- Special care has to be taken with R-290 because of the flammability of propane
- R-290 (propane) units are equipped with a yellow warning label



Avoiding Ignition

- Make sure the capacitors are discharged
- Never work on "live" electrical components and wiring
- Make sure the unit is grounded and the ground does not break
- Ensure that the casings on electrical components are not cracked or broken when charging or recovering refrigerant
- Replace components with factory specified components. Other components could result in ignition of refrigerant in the ambient from a leak

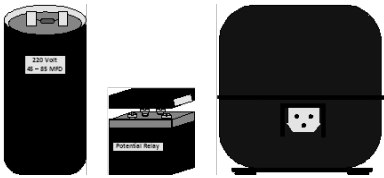

General Safety Precautions When Working With R-290

- Technicians must be instructed on the correct service procedures with R-290
- Working within confined spaces should be avoided
- No flammable materials are stored in the work area
- No ignition sources are present anywhere in the 35' work area
- Fire extinguishing equipment is available within the immediate area
- The work area is properly ventilated before working on the equipment
- Gas detectors should be present and operating to warn workers of concentrations of flammable refrigerants
- Only refrigerant handling and other service equipment designed for use with flammable refrigerants should be used when working on R-290 systems

Sources of Ignition & Avoiding Ignition

Sparks

Electrical terminals including capacitor terminals must be tightened and secured against loosening. Wires must be insulated to prevent shorting and sparking. Electrical motors must be brush-less.

Open Flames

- R-290 equipment should be positioned at a safe distance from open flames
- R-290 equipment should be positioned so that there is always good air gaps around all sides of the equipment
- R-290 equipment should be installed in a well ventilated space

Hot Surfaces

R-290 equipment should be installed where leaked refrigerant will not be exposed to any surfaces exceeding 842°F (auto-ignition temperature).

90% air / 10% propane mixture is required for ignition

Service Procedures

- Always use gas detection equipment when working on R-290 systems
- Set the alarm to 15% of the LFL (Lower Flammability Level)
- Make sure all ignition sources are removed from the work area
- Maintain a 35' area work area free of any ignition source
- Flames, sparks, and static electricity can ignite leaking refrigerant
- Always reclaim and purge system (twice) before using torch on system
- Always run the unit a minimum of 5 minutes before reclaiming refrigerant
- Follow evacuation (500 microns minimum) & purging procedures

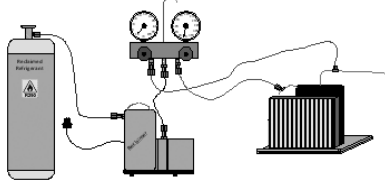

Passive recovery

Charging with R-290

- Charging with R-290 is similar to charging systems with hydrocarbons
- Like all blend refrigerants, R-290 systems must be charged with liquid to maintain correct composition of the blend

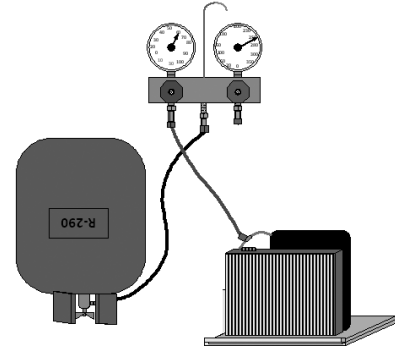

- Be sure that the unit is grounded before charging

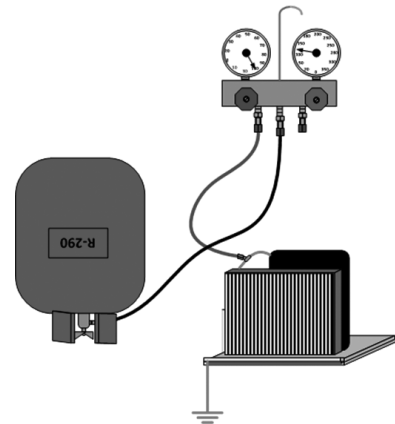

- It is very important to take care NOT to overfill the system
- Hydrocarbon charge sizes are typically 40% to 50% less than that of fluorocarbons

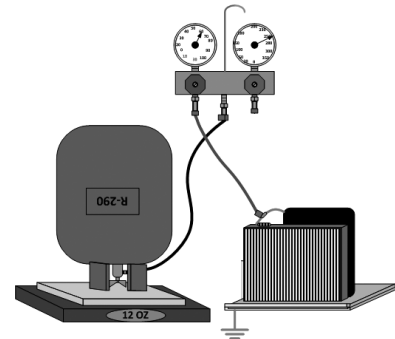

Service Procedures

- Lokring fittings should be used to seal refrigeration lines on R-290 systems.
- Tool part numbers and quantities of Lokring parts necessary to service R-290 systems are as follows:

Qty	Part #	Description	Notes
1	L13003829	Hand tool with double hinge handles	
2	L20000200	Assembly Jaw-Hand Tool MB8	
1	L14000878	Lok Prep 15ml	Good for 1 yr.
12	L13000766	Brass end caps .25	Use 2 per cap

Phone numbers to order parts: PA. 800-304-0153 and FL. 877-861-0955

To purchase from other vendors reference # WX5X1 for Lokring tool.



Normal Operating Temperatures for Models Using Refrigerant R290

75°F (24°C) Ambient / 32°F (0°C) Box Temperature

Evaporator Inlet	Evaporator Outlet	Suction Line	Compressor Top	Compressor Bottom	Condenser Inlet	Condenser Outlet
11°F	28°F	37°F	101°F	98°F	100°F	94°F
-12°C	-2°C	3°C	38°C	37°C	38°C	34°C

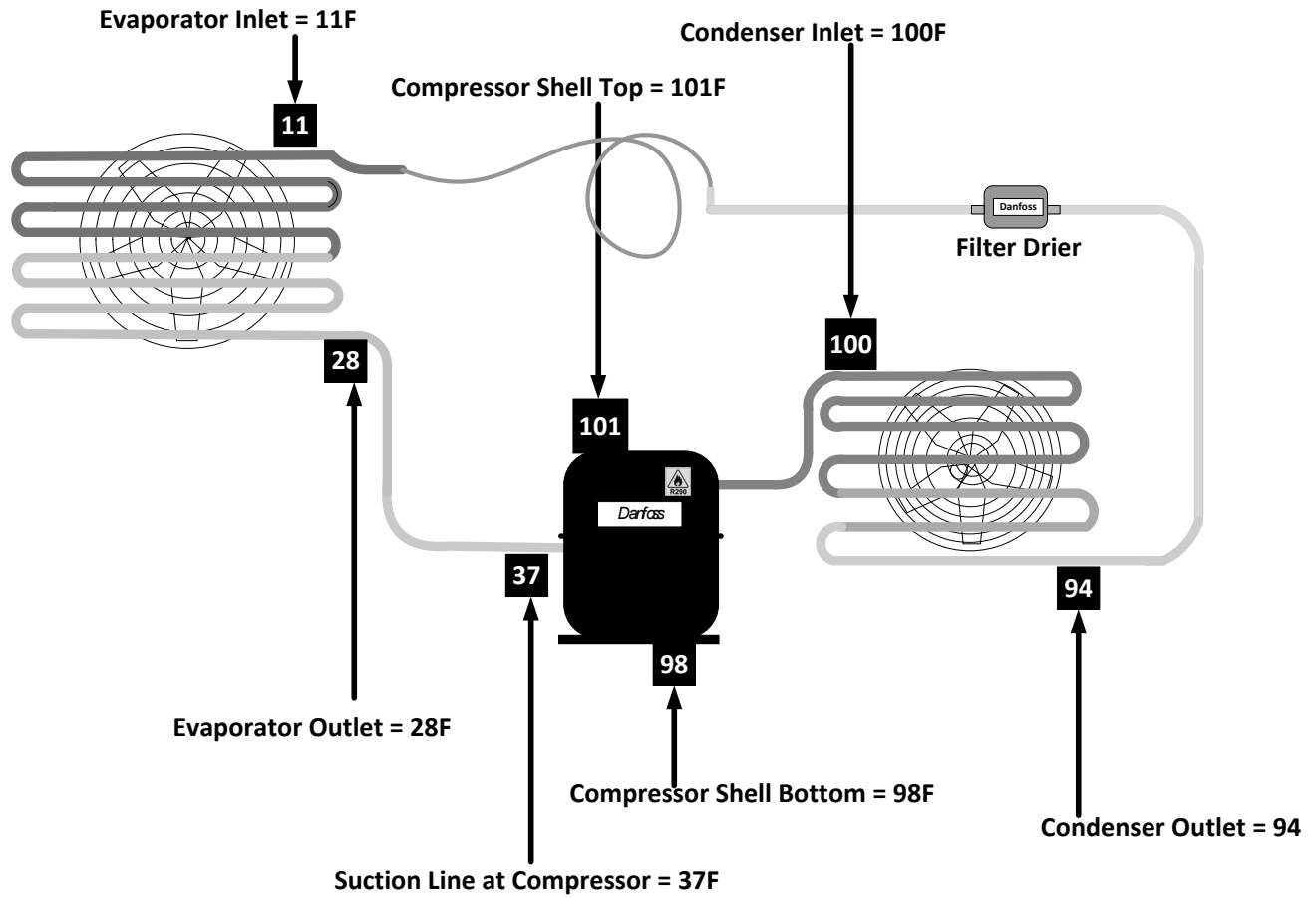

86°F (30°C) Ambient / 32° (0°C) Degree Box Temperature

Evaporator Inlet	Evaporator Outlet	Suction Line	Compressor Top	Compressor Bottom	Condenser Inlet	Condenser Outlet
12°F	26°F	41°F	115°F	112°F	115°F	104°F
-11°C	-3°C	5°C	46°C	44°C	46°C	40°C

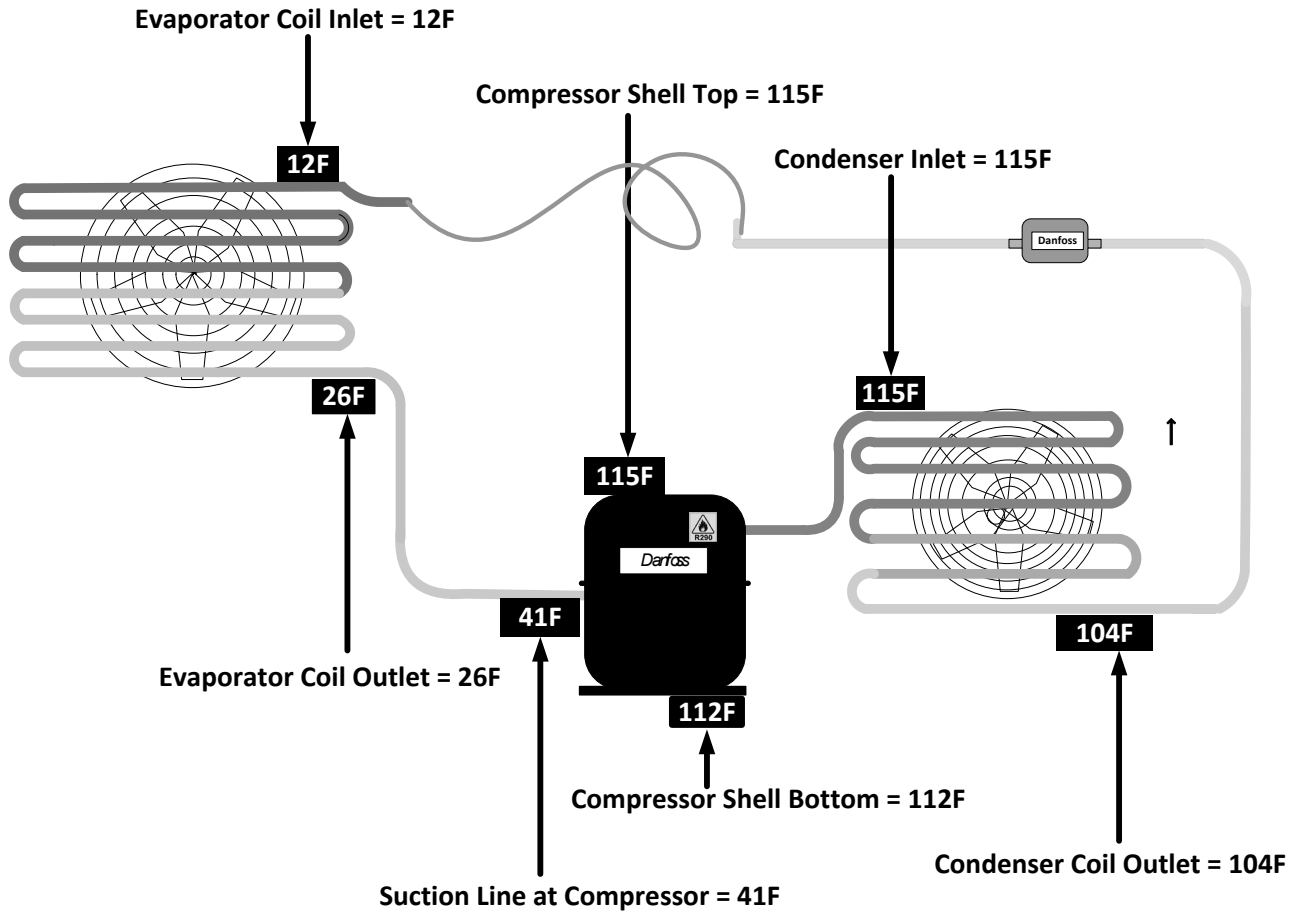

100°F (38°C) Ambient / 32°F (0°C) Box Temperature

Evaporator Inlet	Evaporator Outlet	Suction Line	Compressor Top	Compressor Bottom	Condenser Inlet	Condenser Outlet
14°F	28°F	45°F	132°F	129°F	131°F	117°F
-10°C	-2°C	7°C	56°C	54°C	55°C	47°C

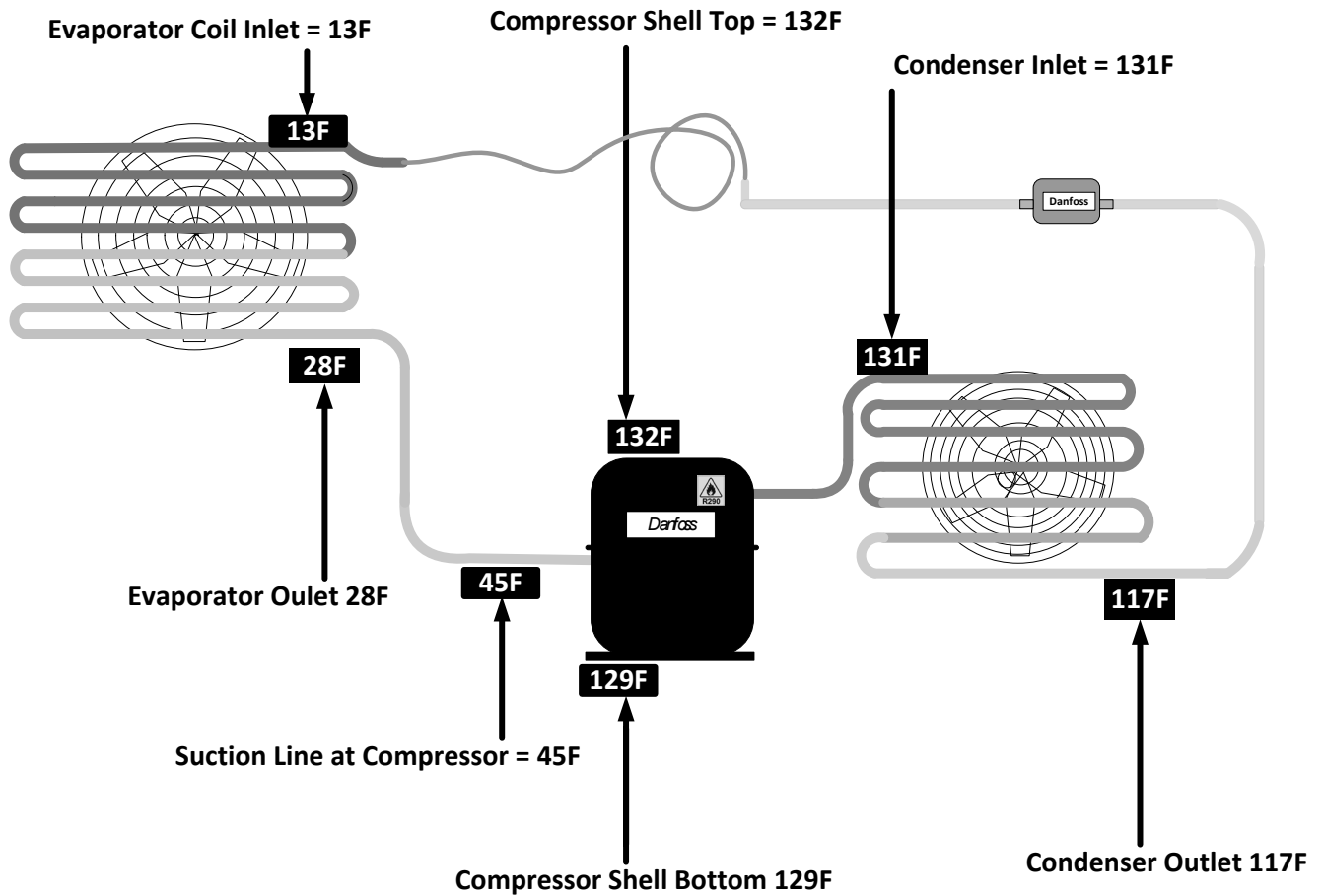

Review

- It's advisable to use portable gas detectors when working on R-290 units
- Before soldering on a R-290 system technicians should evacuate and purged with nitrogen twice
- Maximum allowable non-condensable in a R-290 system is 1%
- Evacuate the unit to a minimum of 500 microns before charging
- Bubble leak test or gas detection leak testing are the two preferred methods
- R-290 should be charged in the liquid state
- R-290 charges are typically 40% to 50% that of fluorocarbon refrigerants
- R-290 operating pressures compare to that of R-22
- Be sure to ground the unit before servicing refrigeration system
- Operate the condensing unit for a minimum of 5 minutes before evacuating to allow oil and refrigerant to separate
- Propane detectors should always be used when servicing R-290 equipment
- Reclaim and purge system twice before servicing unit
- Always cut components and fittings out of system – never use a torch to remove components
- Never leave any type of access fittings on R-290 system – always permanently seal the system

Section 7 Air Flow

Unit Air Flow Design

- Evaporator coil, capillary tube, and evaporator fan motor are accessed by removing the evaporator cover.

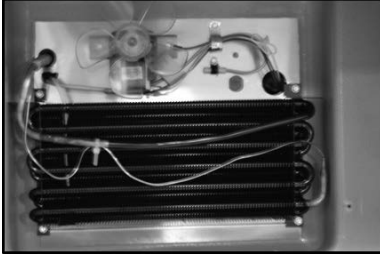

- An evaporator fan motor pulls air up through the evaporator coil and out through the fan guard.

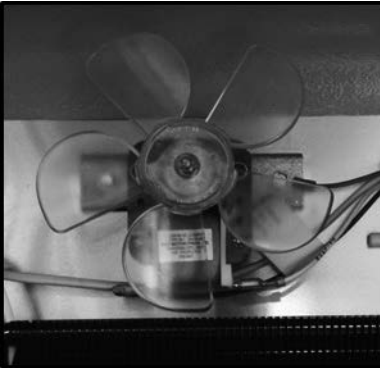

- Evaporator fan motor mounted behind evaporator cover.
- Air is pulled through the coil from the bottom and out through the fan



- Delfield condensing unit is mounted so that air flow is from bottom up through the condenser coil. Rubber bumpers are installed to keep the unit 2" from the back wall.

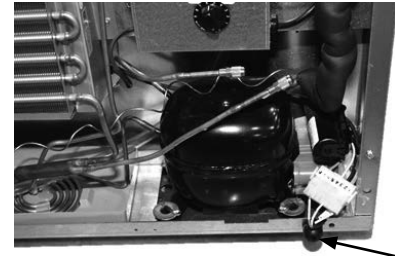

- Hot gas condensate evaporator
- Straight through airflow allows unit to be flush against side walls



Section 8 Control

Power Cord at Junction Box

- Power cord connects in junction box

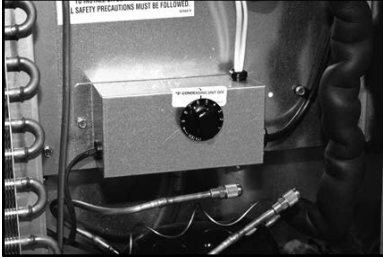

R290 Refrigeration Control Specifications

The Danfoss Solid State temperature control includes:

1. Control
2. Thermistors, black/no stripe = air sensing, blue/two stripe = coil sensing

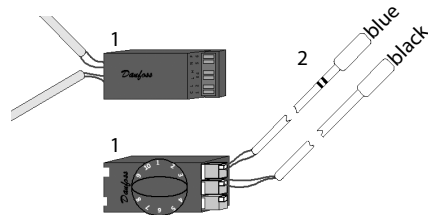

Global Refrigerator Control Wiring

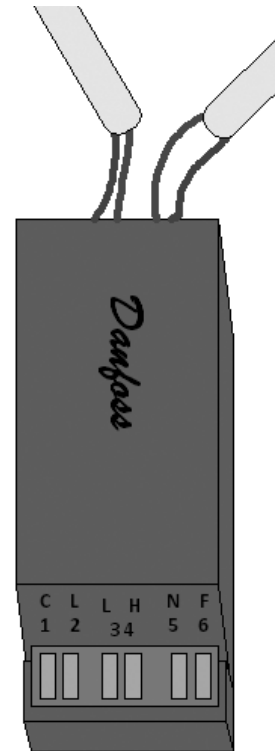

Terminals

- C1 = component being controlled
- L2 = Line voltage
- L3 = Line voltage (second terminal)
- H4 = Defrost heater
- N5 = Neutral
- F6 = Fans

Control Thermistor Connections

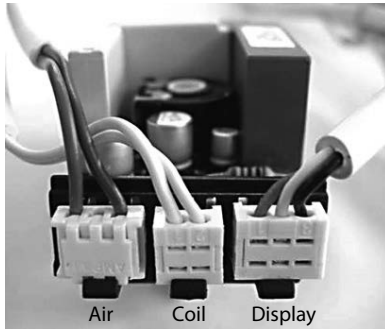

Thermistor connector ends will connect to only one spot on the control.

Connection Label	Connection Description & Thermistor Function
1.1 1.2 1.3	Display cable Powers LED Display
2.1 2.2	Blue/Two stripe thermistor Coil Sensing for Defrost
3.1 3.2 3.3	Black/No stripe thermistor Air Sensing Cycles Condensing Unit

Thermistor Installation

- Blue/two stripe thermistor is installed on the inlet of the evaporator and controls defrost
- Black/no stripe thermistor is installed in the in-let air to the evaporator and cycles the condensing unit (controls box temperature)

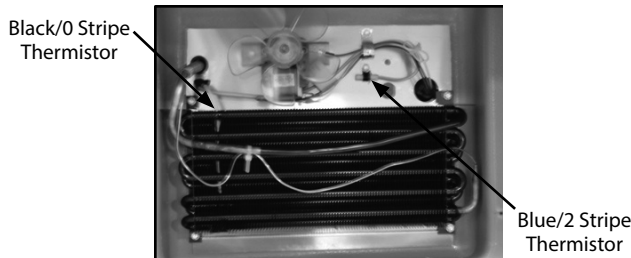

Unit Operation

- At unit start up the control will initial the parameters into the control
- This process could take up to 30 minutes to complete
- The unit will not operate until this process is complete
- During the condensing unit off cycle the evaporator fans cycle on and off every 3 minutes

Service Tips

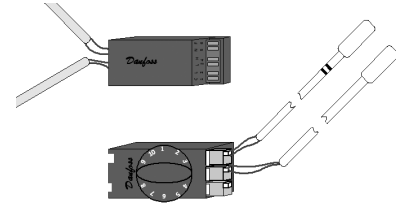

When servicing the unit reduce the off time "initialing" of the control by:

1. Turn the control to the off position
 2. Unplug the unit
 3. Service the unit
 4. Re-apply power to the unit
 5. Turn the control back to the desired setting
- Thermistor resistance is 16330 ohms at 32°F
 - 15000 to 17000 ohms at 32°F is acceptable.
 - The control must be mounted on the outside of the unit.
 - The control must be mounted in a clean and dry environment.
 - Keep control mounted in box provided with cover installed and all screws in place.
 - Always remember to re-seal openings in cabinet when replacing thermistors. Warm air infiltration will affect the box temperature thermistor and cause the condensing unit to run constantly
 - The control knob has a "stop" at the coldest and the warmest setting.
 - The control stem is made of plastic and can break if knob is forced past stop or pushed into the control.

Section 9 Diagrams

R404A Compressor Wiring

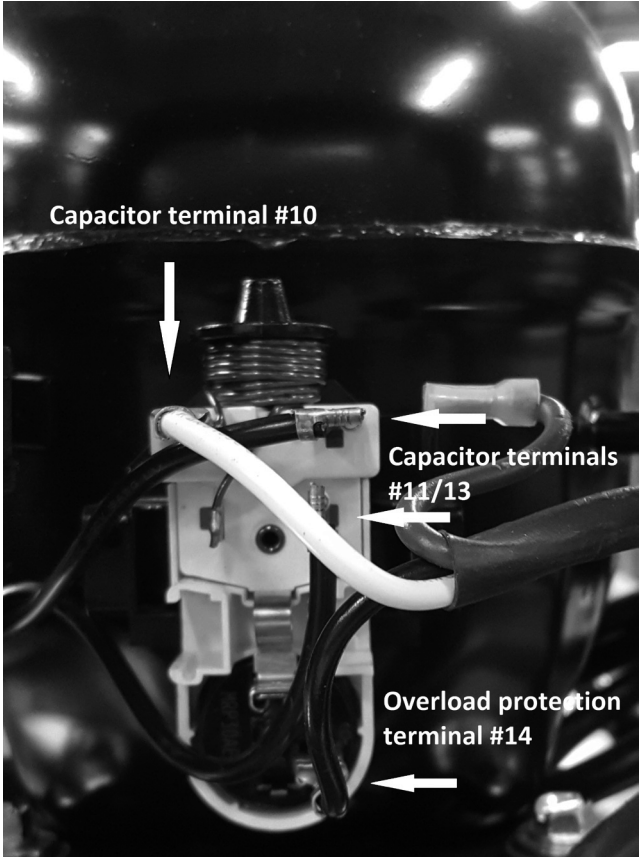
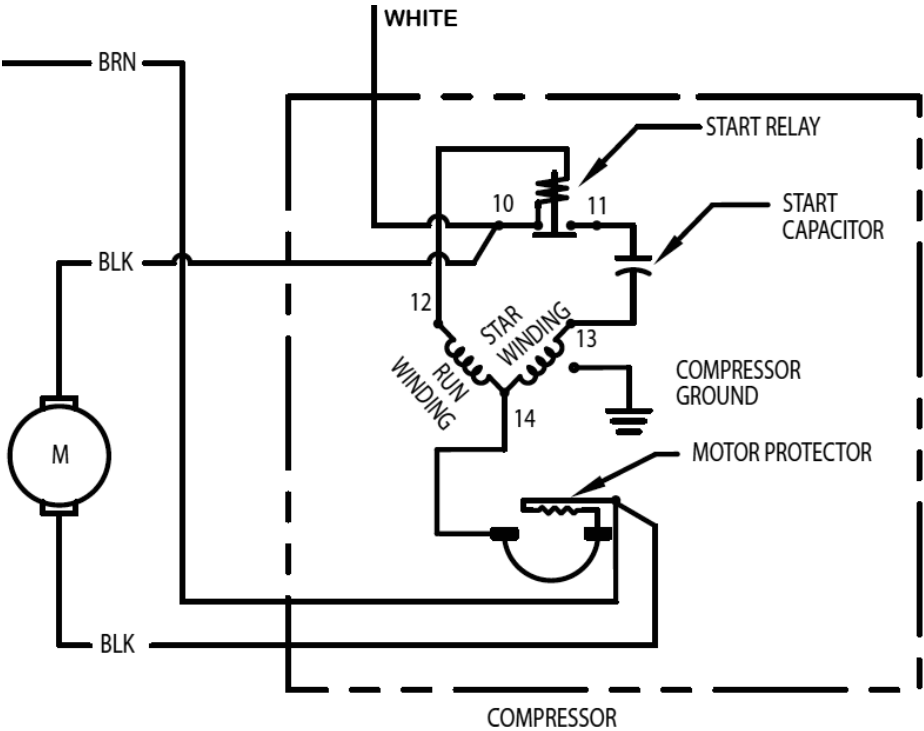

Models 402, 406, 406CA, ST4048 & UC4048

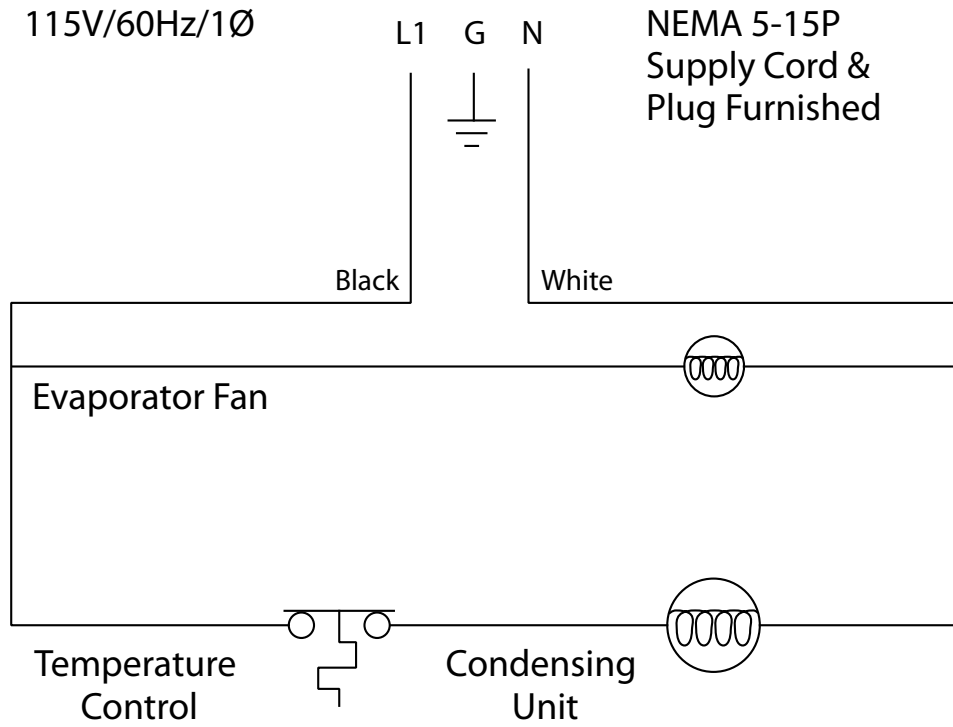

402P, 406P, 406CAP, ST4048P, UC4048P

LINE VOLTAGE
115V/60Hz/1Ph or 220V/50Hz/1Ph
SEE NAMEPLATE FOR MAXIMUM
FUSE SIZE

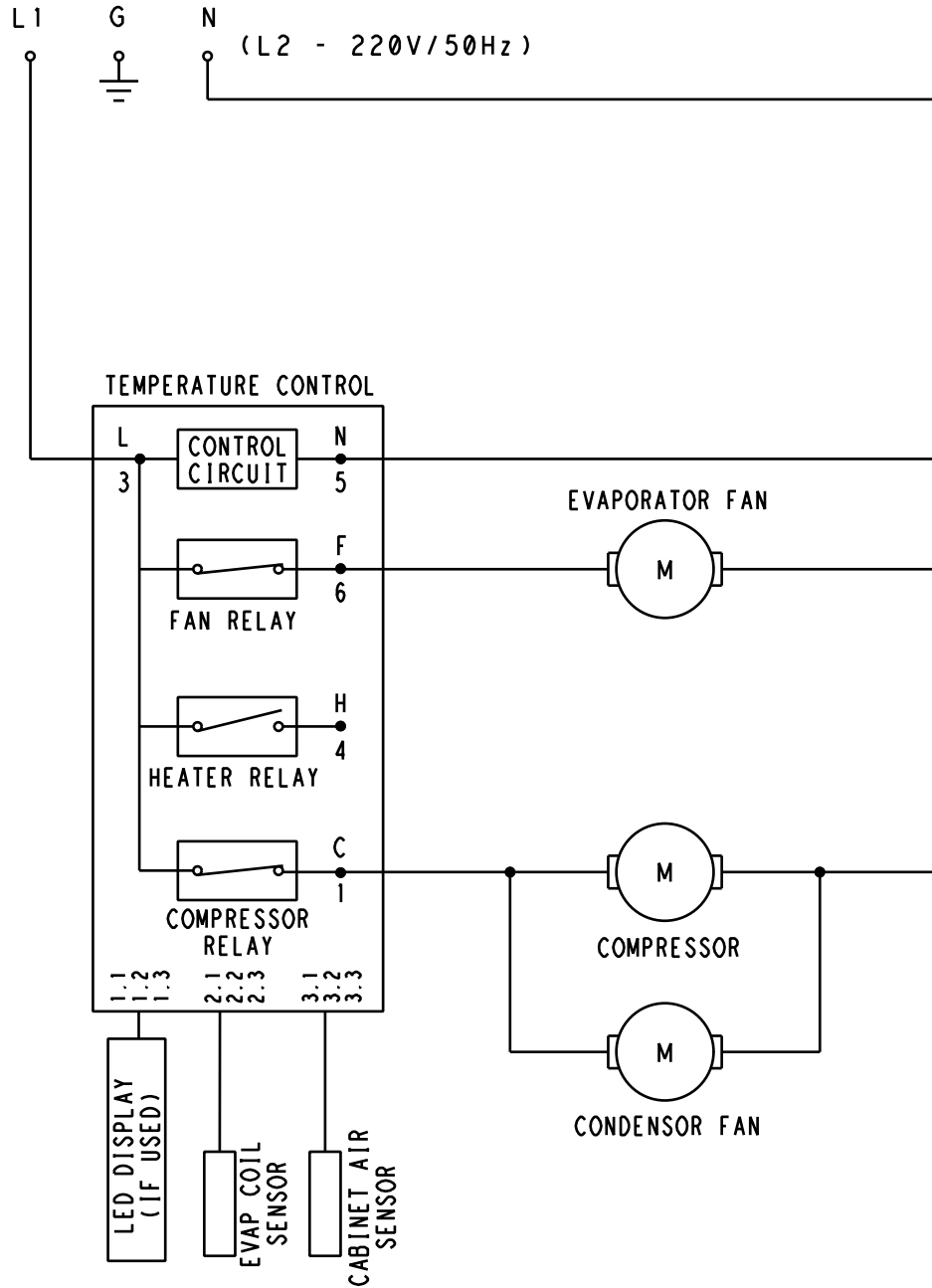

Export Models 402-CE, 406-CE, 406CA-CE, ST4048-CE & UC4048-CE

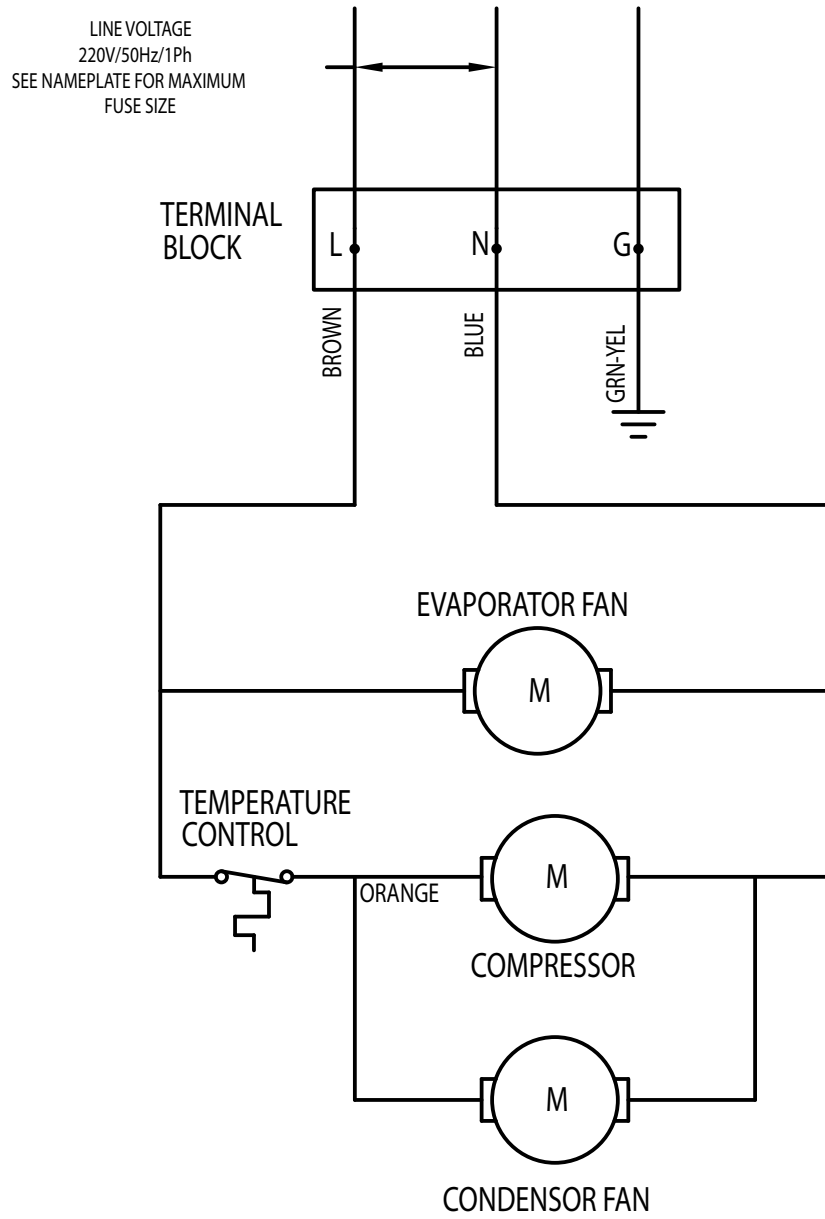

Models 403, 407, 407CA, ST4148 & UC4148

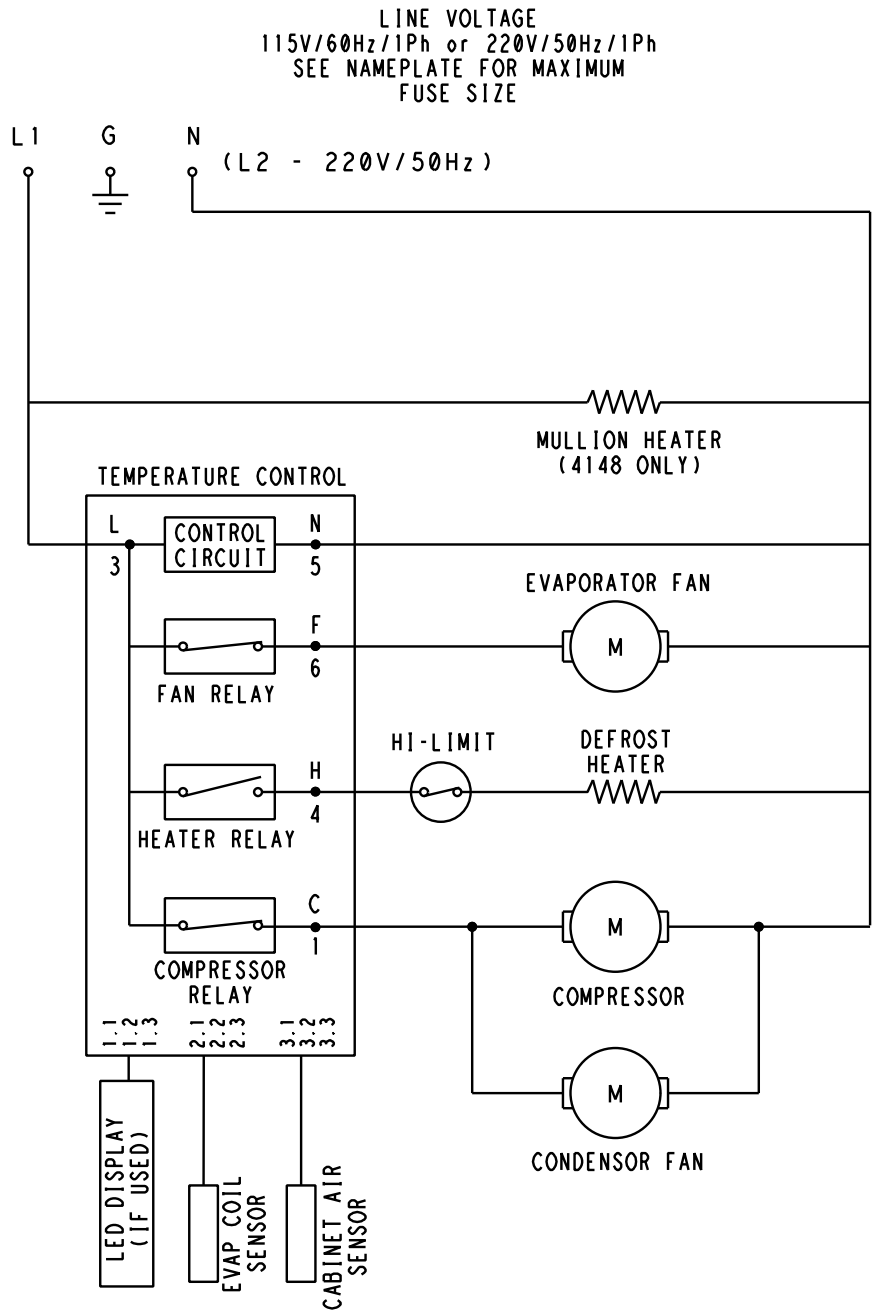

Export Models 403-CE, 407-CE & 407CA-CE

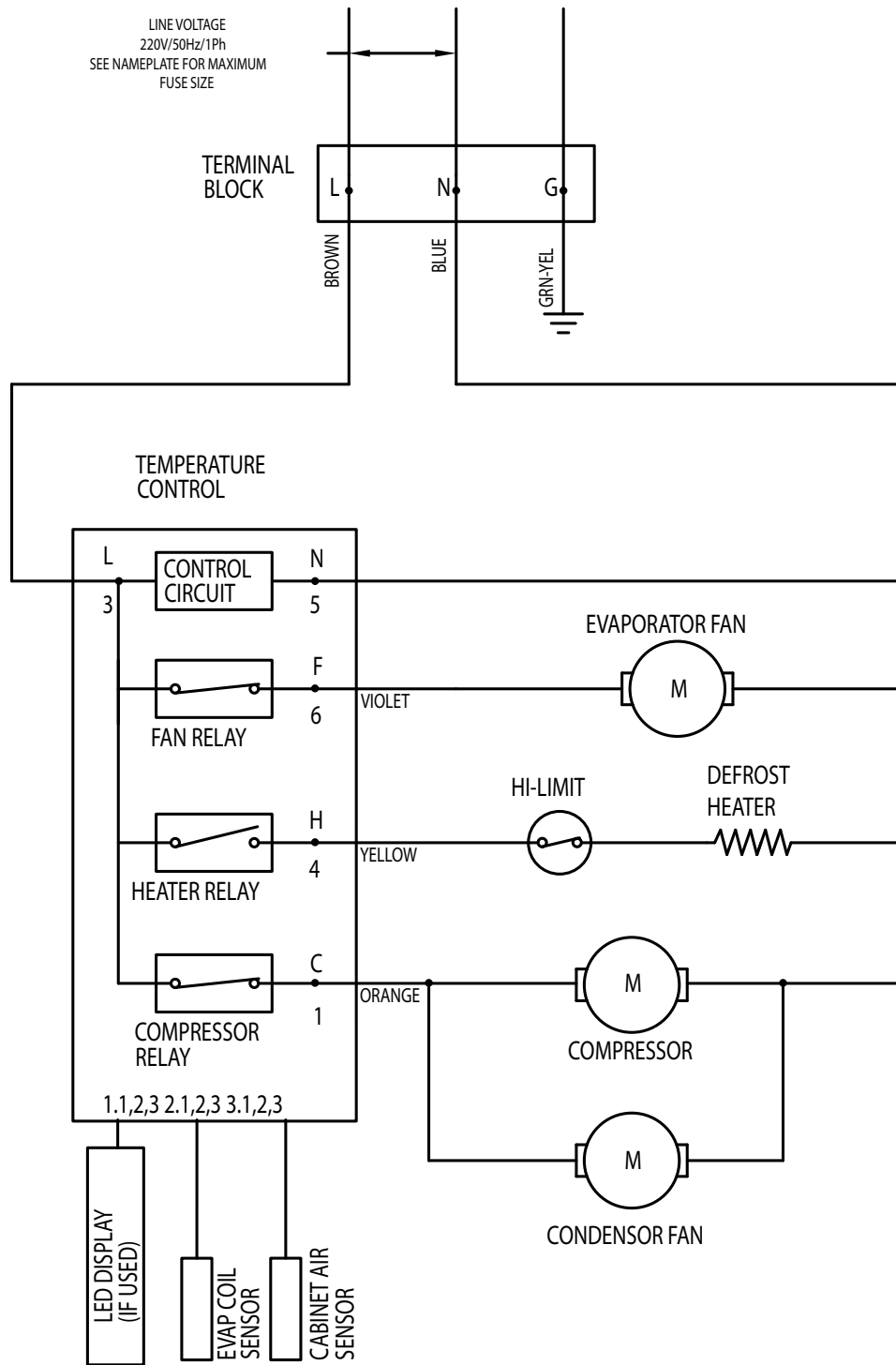

Export Models ST4148-CE & UC4148-CE

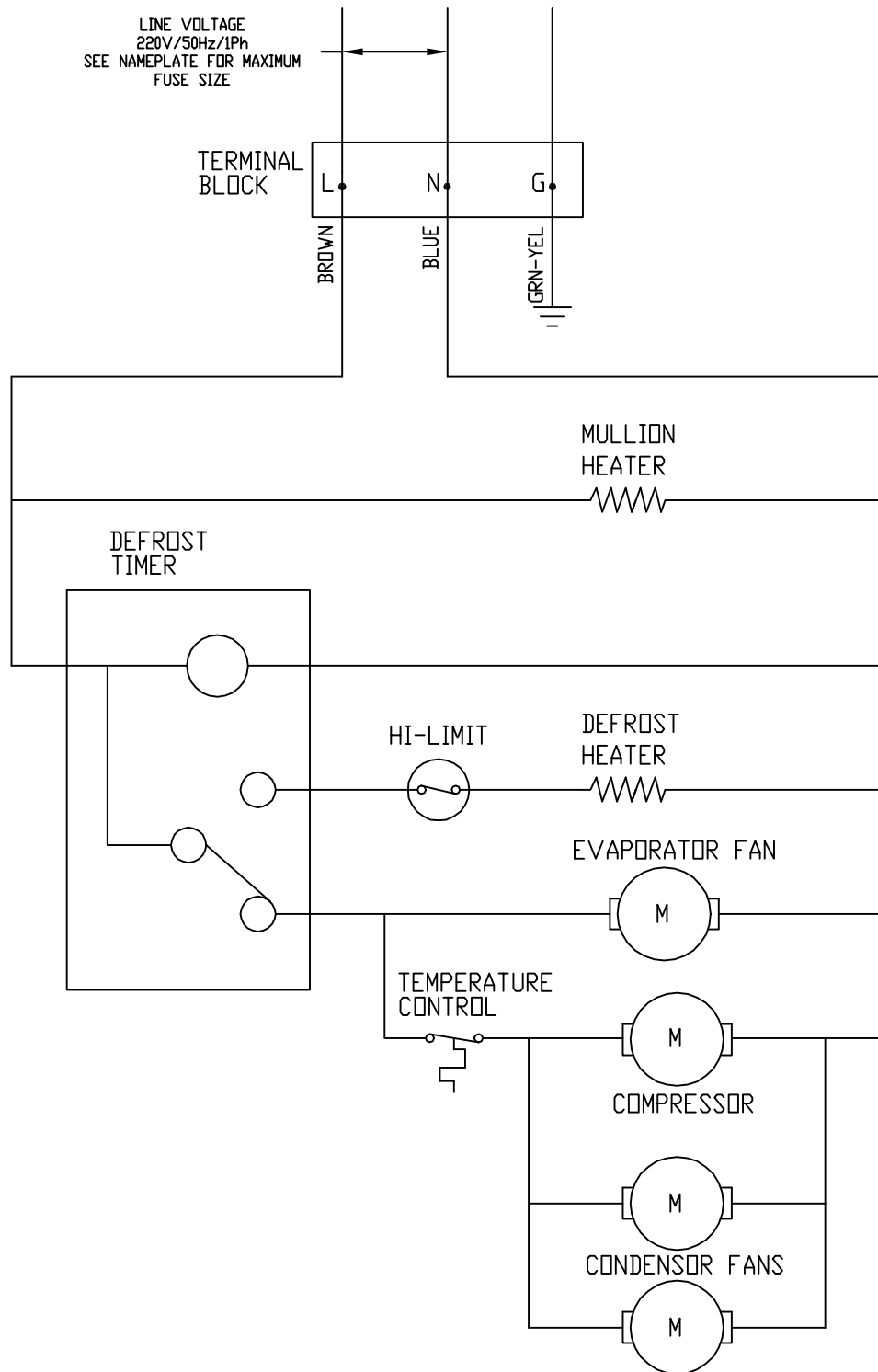

Section 10

Replacement Procedures

406P - Connect Compressor's Starter Box

- 1. Connect the starter box black wire to pin 1 of the compressor three pin connector.

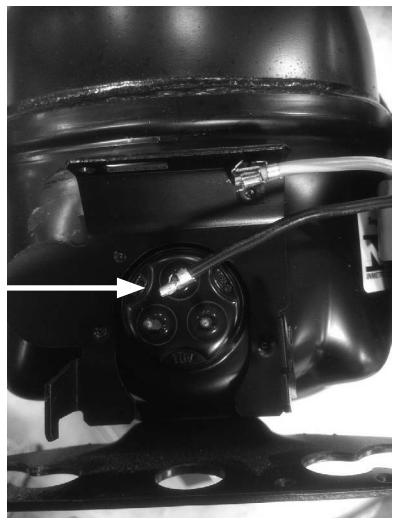

- 2. Connect the starter box green ground wire to the compressor's chassis pin.

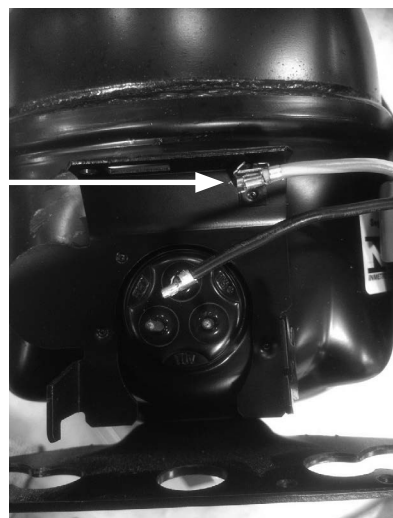

- 3. Connect the two female relay pins to pins 2 and 3 of the compressor three pin connector.

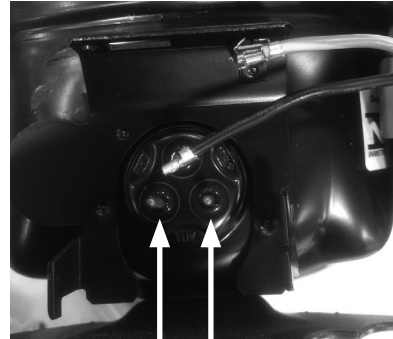

- 4. Complete. Relay pins and two starter box wires connected to compressor.



Door Mounting Bracket

A hinge pin mounted in the door attaches to a mounting bracket screwed to the face of the door opening.

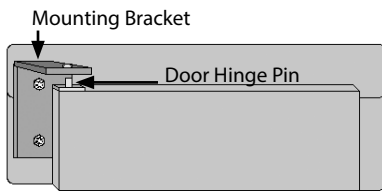

Door Gasket

Under Counter units have a bullet- type push on gasket.



**WWW.WELBILT.COM**

Welbilt provides the world's top chefs, and premier chain operators or growing independents with industry leading equipment and solutions. Our cutting-edge designs and lean manufacturing tactics are powered by deep knowledge, operator insights, and culinary expertise.

All of our products are backed by KitchenCare® – our aftermarket, repair, and parts service.

- | | | | | | |
|---------------|---------------|--------------|-----------|--------------|--------------|
| ▶ CLEVELAND | ▶ DELFIELD® | ▶ FRYMASTER® | ▶ KOLPAK® | ▶ MANITOWOC® | ▶ MERRYCHEF® |
| ▶ CONVOTHERM® | ▶ FITKITCHEN™ | ▶ GARLAND | ▶ LINCOLN | ▶ MERCO® | ▶ MULTIPLEX® |