



F18 SERIES

Service and Installation Manual

Please read this manual completely before attempting to install or operate this equipment! Notify carrier of damage! Inspect all components immediately.



Refrigerated Work Tables, Salad Tables & Freezer Bases

 **IMPORTANT INFORMATION**
READ BEFORE USE
PLEASE SAVE THESE INSTRUCTIONS!

July 2011



Important Warning And Safety Information



WARNING

Read This Manual Thoroughly Before Operating, Installing, Or Performing Maintenance On The Equipment.



WARNING

Failure To Follow Instructions In This Manual Can Cause Property Damage, Injury Or Death.



WARNING

Do Not Store Or Use Gasoline Or Other Flammable Vapors Or Liquids In The Vicinity Of This Or Any Other Appliance.



WARNING

Unless All Cover And Access Panels Are In Place And Properly Secured, Do Not Operate This Equipment.



WARNING

This Appliance Is Not Intended For Use By Persons Who Lack Experience Or Knowledge, Unless They Have Been Given Supervision Or Instruction Concerning Use Of The Appliance By A Person Responsible For Their Safety.



WARNING

This Appliance Is Not To Be Played With.



WARNING

Do Not Clean With Water Jet.



WARNING

Do Not Use Electrical Appliances Inside The Food Storage Compartment Of This Appliance.



CAUTION

Observe the following:

- Minimum clearances must be maintained from all walls and combustible materials.
- Keep the equipment area free and clear of combustible material.
- Allow adequate clearance for air openings.
- Operate equipment only on the type of electricity indicated on the specification plate.
- Unplug the unit before making any repairs.
- Retain this manual for future reference.

Contents

Serial Number Location	3
Receiving & Inspecting	3
Specifications.....	4-6
Installation	7
Operation	8
Temperature Settings.....	9
Maintenance.....	10-11
Wiring Diagrams.....	12-15
Replacement Part Lists	16-19
Replacement Part Assemblies	20-23
Warranties.....	24-26
Notes	27

Serial Number Location

The serial number on all self-contained F18 Series refrigerated work tables and freezer bases is located on the electrical specifications tag affixed inside the compressor section next to the pressure control.

On remote refrigerated bases with doors, the tag is inside the unit on the coil side. On remote refrigerated bases with drawers, the tag is affixed to the drawer divider. On remote freezer bases, the tag is located on the inside back of the unit.

Always have the serial number of your unit available when calling for parts or service. A complete list of authorized Delfield parts depots is available at www.delfield.com.

©2012 The Delfield Company. All rights reserved. Reproduction without written permission is prohibited. "Delfield" is a registered trademark of The Delfield Company.

Regulatory Certifications

The models are certified by:



National Sanitation Foundation (NSF)



Underwriters Laboratories (UL)

Receiving and Inspecting the Equipment

Even though most equipment is shipped crated, care should be taken during unloading so the equipment is not damaged while being moved into the building.

1. Visually inspect the exterior of the package on skid or container. Any damage should be noted and reported to the delivering carrier immediately.
2. If damaged, open and inspect the contents with the carrier.
3. In the event that the exterior is not damaged, yet upon opening, there is concealed damage to the equipment notify the carrier. Notification should be made verbally as well as in written form.
4. Request an inspection of the concealed equipment. This should be done within 10 days from receipt of the equipment.
5. Check the lower portion of the unit to be sure legs or casters are not bent.
6. Also open the compressor compartment housing and

visually inspect the refrigeration package. Be sure lines are secure and base is still intact.

7. Freight carriers can supply the necessary forms upon request.
8. Retain all crating material until an inspection has been made or waived.

Uncrating the Equipment

First cut and remove the banding from around the crate. Remove the front of the crate material, use of some tools will be required. If the unit is on legs remove the top of the crate as well and lift the unit off the skid. If the unit is on casters it can be "rolled" off the skid.



Specifications

Remote Refrigerated Work Tables

Model	# Of Doors	Shelf Max Load (lbs)	Base Storage Cap. FT ³	Shelf Area FT ²	Volts/Hertz/Phase	Amps	BTU Load	EVAP. BTU/°TD
F18WR31	(1) 19"	70	7.56	2.56	115/60/1	3.0	383	120/3°
F18WR39	(1) 27"	124	10.23	3.95	115/60/1	3.0	465	120/4°
F18WR44	(2) 19"	70	12.14	5.12	115/60/1	3.0	605	120/5°
F18WR52	(1) 19" & (1) 27"	70/124	15.12	6.51	115/60/1	3.0	686	120/6°
F18WR60	(2) 27"	124	18.10	7.90	115/60/1	3.0	768	120/6°
F18WR70	(2) 32"	140	21.23	9.64	115/60/1	3.0	869	120/7°
F18WR79	(2) 27" & (1) 19"	124/70	24.48	10.29	115/60/1	6.0	1050	240/4°
F18WR87	(3) 27"	124	27.46	11.85	115/60/1	6.0	1131	240/5°

Self-Contained Refrigerated Work Tables

Model	# Of Doors	Shelf Max Load (lbs)	Base Storage Cap. FT ³	Shelf Area FT ²	Volts/Hertz/Phase	Amps	BTU Load	BTU System Cap.	R-404A oz.	H.P.	NEMA Plug
F18WC39	(1) 19"	70	7.56	2.56	115/60/1	8.0	383	1462	16	1/5	5-15P
F18WC47	(1) 27"	124	10.23	3.95	115/60/1	8.0	465	1462	16	1/5	5-15P
F18WC52	(2) 19"	70	12.14	5.12	115/60/1	8.0	605	1462	16	1/5	5-15P
F18WC60	(1) 19" & (1) 27"	70/124	15.12	6.51	115/60/1	8.0	686	1462	16	1/5	5-15P
F18WC68	(2) 27"	124	18.10	7.90	115/60/1	10.0	768	1462	16	1/4	5-15P
F18WC78	(2) 32"	140	21.23	9.64	115/60/1	10.0	869	1994	16	1/4	5-15P
F18WC87	(2) 27" & (1) 19"	124/70	24.48	10.29	115/60/1	10.0	1050	2261	16	1/4	5-15P
F18WC95	(3) 27"	124	27.46	11.85	115/60/1	10.0	1131	2261	16	1/4	5-15P

Remote Refrigerated Mega Top Salad Tables

Model	# Of Doors	Shelf Max Load (lbs)	Base Storage Cap. FT ³	# of Pans	Volts/Hertz/Phase	Amps	BTU Load Base/Rail	EVAP. BTU/°TD Base/Rail
F18MR31A	(1) 19"	70	4.14	6	115/60/1	3.0	280/265	120/2°/12/22°
F18MR44A	(2) 19"	70	7.15	6	115/60/1	3.0	444/265	120/4°/12/22°
F18MR44D	(2) 19"	70	7.15	12	115/60/1	3.0	444/529	120/4°/22/25°
F18MR52A	(1) 19" & (1) 27"	70/124	8.97	6	115/60/1	3.0	515/265	120/4°/12/22°
F18MR52D	(1) 19" & (1) 27"	70/124	8.97	12	115/60/1	3.0	515/529	120/4°/22/25°
F18MR52E	(1) 19" & (1) 27"	70/124	8.97	18	115/60/1	3.0	515/794	120/4°/31/26°

Self-Contained Refrigerated Mega Top Salad Tables

Model	# Of Doors	Shelf Max Load (lbs)	Base Storage Cap. FT ³	# of Pans	Volts/Hertz/Phase	Amps	BTU Load Base/Rail	BTU System Cap. Base/Rail	R-404A oz.	H.P.	NEMA Plug
F18MC39A	(1) 19"	70	4.14	6	115/60/1	10.0	280/265	1903/925	16	1/4	5-15P
F18MC39D	(1) 19"	70	4.14	12	115/60/1	10.0	280/529	1903/1156	16	1/4	5-15P
F18MC52A	(2) 19"	70	7.15	6	115/60/1	10.0	444/265	1903/925	16	1/4	5-15P
F18MC52D	(2) 19"	70	7.15	12	115/60/1	10.0	444/529	1903/1156	16	1/4	5-15P
F18MC52E	(2) 19"	70	7.15	18	115/60/1	10.0	444/794	1903/1321	16	1/4	5-15P
F18MC60A	(1) 19" & (1) 27"	70/124	8.97	6	115/60/1	10.0	515/265	2314/864	16	1/4	5-15P
F18MC60D	(1) 19" & (1) 27"	70/124	8.97	12	115/60/1	10.0	515/529	2314/1141	16	1/4	5-15P
F18MC60E	(1) 19" & (1) 27"	70/124	8.97	18	115/60/1	10.0	515/794	2314/1361	16	1/4	5-15P
F18MC60F	(1) 19" & (1) 27"	70/124	8.97	24	115/60/1	10.0	515/1058	2314/1540	16	1/4	5-15P

Specifications

Remote Refrigerated Salad Top Tables

Model	# Of Doors	Shelf Max Load (lbs)	Base Storage Cap. FT ³	# of Pans	Volts/Hertz/Phase	Amps	BTU Load Base/Rail	Evap. BTU/°TD Base/Rail
F18SR31A	(1) 19"	70	4.14	6	115/60/1	3.0	280/265	120/2°/13/21°
F18SR44A	(2) 19"	70	7.15	6	115/60/1	3.0	491/441	120/4°/13/21°
F18SR44B	(2) 19"	70	7.15	8	115/60/1	3.0	491/441	120/4°/16/22°
F18SR44C	(2) 19"	70	7.15	10	115/60/1	3.0	491/441	120/4°/19/23°
F18SR52A	(1) 19" & (1) 27"	70/124	8.97	6	115/60/1	3.0	532/529	120/4°/13/21°
F18SR52B	(1) 19" & (1) 27"	70/124	8.97	8	115/60/1	3.0	532/529	120/4°/16/22°
F18SR52C	(1) 19" & (1) 27"	70/124	8.97	10	115/60/1	3.0	532/529	120/4°/19/23°
F18SR52D	(1) 19" & (1) 27"	70/124	8.97	12	115/60/1	3.0	532/529	120/4°/23/23°

Self-Contained Refrigerated Salad Top Tables

Model	# Of Doors	Shelf Max Load (lbs)	Base Storage Cap. FT ³	# of Pans	Volts/Hertz/Phase	Amps	BTU Load Base/Rail	BTU System Cap. Base/Rail	R-404A oz.	H.P.	NEMA Plug
F18SC39A	(1) 19"	70	4.14	6	115/60/1	10.0	280/265	1903/745	16	1/4	5-15P
F18SC39B	(1) 19"	70	4.14	8	115/60/1	10.0	280/353	1903/867	16	1/4	5-15P
F18SC52A	(2) 19"	70	7.15	6	115/60/1	10.0	444/265	1903/745	16	1/4	5-15P
F18SC52B	(2) 19"	70	7.15	8	115/60/1	10.0	444/353	1903/867	16	1/4	5-15P
F18SC52C	(2) 19"	70	7.15	10	115/60/1	10.0	444/441	1903/971	16	1/4	5-15P
F18SC52D	(2) 19"	70	7.15	12	115/60/1	10.0	444/529	1903/1061	16	1/4	5-15P
F18SC60A	(1) 19" & (1) 27"	70/124	8.97	6	115/60/1	10.0	515/265	2314/667	16	1/4	5-15P
F18SC60B	(1) 19" & (1) 27"	70/124	8.97	8	115/60/1	10.0	515/353	2314/798	16	1/4	5-15P
F18SC60C	(1) 19" & (1) 27"	70/124	8.97	10	115/60/1	10.0	515/441	2314/916	16	1/4	5-15P
F18SC60D	(1) 19" & (1) 27"	70/124	8.97	12	115/60/1	10.0	515/529	2314/1023	16	1/4	5-15P

Remote Refrigerated Reduced Height Rail

Model	# Of Doors	Shelf Max Load (lbs)	Base Storage Cap. FT ³	Shelf Area FT ²	# of Pans	Volts/Hertz/Phase	Amps	BTU Load Base/Rail	Evap. BTU/°TD Base/Rail
F18DR44	(2) 19"	70	9.54	5.12	10	115/60/1	3.0	547/441	120/5°/19/23°
F18DR52	(1) 19" & (1) 27"	70/124	13.89	6.51	12	115/60/1	3.0	625/529	120/5°/23/23°
F18DR60	(2) 27"	124	16.64	7.9	16	115/60/1	5.0	703/617	120/6°/26/24°
F18DR70	(2) 32"	140	22.96	9.64	18	115/60/1	5.0	800/794	120/7°/32/24°
F18DR79	(1) 19" & (2) 27"	70/124	22.47	10.29	18	115/60/1	5.0	962/882	240/4°/36/25°
F18DR87	(3) 27"	124	25.22	11.85	22	115/60/1	5.0	1032/970	240/4°/39/25°

Self-Contained Refrigerated Reduced Height Rail

Model	# Of Doors	Shelf Max Load (lbs)	Base Storage Cap. FT ³	Shelf Area FT ²	# of Pans	Volts/Hertz/Phase	Amps	BTU Load Base/Rail	BTU System Cap. Base/Rail	R-404A oz.	H.P.	NEMA Plug
F18DC52	(2) 19"	70	9.54	5.12	12	115/60/1	10.0	547/529	1903/1061	16	1/4	5-15P
F18DC60	(1) 19" & (1) 27"	70/124	13.89	6.51	14	115/60/1	12.0	625/617	2314/1121	24	1/3	5-15P
F18DC68	(2) 27"	124	16.64	7.9	18	115/60/1	12.0	703/794	2314/1544	24	1/3	5-15P
F18DC82	(2) 32"	140	22.96	9.64	20	115/60/1	14.0	800/882	3097/1648	32	1/2	5-20P
F18DC91	(1) 19" & (2) 27"	70/124	22.47	10.29	22	115/60/1	14.0	962/1058	3807/1839	32	1/2	5-20P
F18DC99	(3) 27"	124	25.22	11.85	24	115/60/1	14.0	1032/1147	3807/1839	32	1/2	5-20P



Specifications

Remote Refrigerated Reduced Height Rail

Model	# Of Doors	Shelf Max Load (lbs)	Base Storage Cap. FT ³	Shelf Area FT ²	Volts/Hertz/Phase	Amps	BTU Load Base/Rail	Evap. BTU/°TD Base/Rail	# of Pans
F18RR44	(2) 19"	70	9.49	5.12	115/60/1	3.0	547/441	120/5°/19/23°	10
F18RR52	(1) 19" & (1) 27"	70/124	11.81	6.51	115/60/1	3.0	625/529	120/5°/23/23°	12
F18RR60	(2) 27"	124	14.14	7.9	115/60/1	5.0	703/617	120/6°/26/24°	16
F18RR70	(2) 32"	140	17.05	9.64	115/60/1	5.0	800/794	120/7°/32/24°	18
F18RR79	(1) 19" & (2) 27"	70/124	18.68	10.29	115/60/1	5.0	962/882	240/4°/36/25°	18
F18RR87	(3) 27"	124	21.30	11.85	115/60/1	5.0	1032/970	240/4°/39/25°	22

Self-Contained Refrigerated Reduced Height Rail

Model	# Of Doors	Shelf Max Load (lbs)	Base Storage Cap. FT ³	Shelf Area FT ²	Volts/Hertz/Phase	Amps	BTU Load Base/Rail	BTU System Cap. Base/Rail	# of Pans	R-404A oz.	H.P.	NEMA Plug
F18RC52	(2) 19"	70	9.49	5.12	115/60/1	10.0	547/529	1903/1061	12	16	1/4	5-15P
F18RC60	(1) 19" & (1) 27"	70/124	11.81	6.51	115/60/1	12.0	625/617	2314/1121	14	24	1/3	5-15P
F18RC68	(2) 27"	124	14.14	7.9	115/60/1	12.0	703/794	2314/1544	16	24	1/3	5-15P
F18RC82	(2) 32"	140	17.05	9.64	115/60/1	14.0	800/882	3097/1648	20	32	1/2	5-20P
F18RC91	(1) 19" & (2) 27"	70/124	18.68	10.29	115/60/1	14.0	962/1058	3807/1839	22	32	1/2	5-20P
F18RC99	(3) 27"	124	21.30	11.85	115/60/1	14.0	1032/1147	3807/1839	24	32	1/2	5-20P

Remote Freezer Base

Model	# Of Doors	Shelf Max Load (lbs)	Base Storage Cap. FT ³	Shelf Area FT ²	Volts/Hertz/Phase	Amps	BTU Load Base/Rail	Evap. BTU/°TD
F18FR35	(1) 19"	70	5.58	2.56	115/60/1	10.0	943	160/6°
F18FR50	(2) 19"	70	12.21	5.12	115/60/1	10.0	1471	160/9°
F18FR58	(1) 19" & (1) 27"	70/124	15.00	6.51	115/60/1	10.0	1844	160/10°
F18FR66	(2) 27"	124	17.79	7.9	115/60/1	10.0	2020	160/11°
F18FR76	(2) 32"	140	21.28	9.64	115/60/1	10.0	2437	160/13°

Self-Contained Freezer Base

Model	# Of Doors	Shelf Max Load (lbs)	Base Storage Cap. FT ³	Shelf Area FT ²	Volts/Hertz/Phase	Amps	BTU Load Base/Rail	BTU System Cap. Base/Rail	H.P.	R-404A oz.	NEMA Plug
F18FC43	(1) 19"	70	5.58	2.56	115/60/1	10.0	943	1558	1/3	24	5-15P
F18FC62	(2) 19"	70	12.21	5.12	115/60/1	12.0	1471	1776	1/2	40	5-15P
F18FC70	(1) 19" & (1) 27"	70/124	15.00	6.51	115/60/1	16.0	1647	2713	3/4	56	5-20P
F18FC78	(2) 27"	124	17.79	7.9	115/60/1	16.0	1824	2713	3/4	56	5-20P
F18FC88	(2) 32"	140	21.28	9.64	115/60/1	16.0	2045	2713	3/4	56	5-20P

Self-Contained Dual Rails

Model	# Of Doors	Shelf Max Load (lbs)	Base Storage Cap. FT ³	Shelf Area FT ²	Volts/Hertz/Phase	Amps	BTU Load Base/Rail	BTU System Cap. Base/Rail	H.P.	R-404A oz.	NEMA Plug
F18PD48	(1) 27"	124	9.38	3.95	115/60/1	10.0	424/1058	2001/1865	1/5, 1/3	40	5-20P
F18PD72	(2) 27"	124	16.64	7.90	115/60/1	12.7	703/1588	2001/3174	1/5, 1/2	48	5-20P

Installation

Location

These units are intended for indoor use only. Be sure the location chosen has a floor strong enough to support the total weight of the cabinet and contents. A fully loaded 72" (183cm) long model may weigh as much as 1500 pounds (680kg)! Reinforce the floor as necessary to provide for maximum loading.

It is very important to allow for proper air flow, both inside and outside.

Avoid hot corners and locations near stoves, ovens and other pieces of cooking equipment.



NOTE:

It is recommended that the unit be installed no closer than 1" (2.54cm) from any wall. Do not install the unit near any combustible material or object affected by heat or moisture.

PDL models also require 14" (36cm) clearance at the top and 6" (15cm) clearance at the bottom (casters).

Leveling

A level cabinet looks better and will perform better because the drain pan will drain properly, the doors will line up with the frames properly, and the cabinet will not be subject to undue strain.

A unit on legs will have an adjustable bullet foot on each leg, adjust each for a level unit. A unit on casters will not be adjustable. Be sure the unit is on a level floor, make necessary changes to the floor for proper level.

Lock all front casters to ensure the stability of the unit.

Plumbing

Self-contained models are standard with a condensate evaporator. If, for some reason a unit does not have a condensate evaporator, or if the evaporator fails, the unit's drain must have an outlet to an appropriate drainage area or container. A refrigerated rail will have a 1" (2.54cm) drain which will need to be run to an appropriate floor drain or container. The drain will be stubbed to the bottom of the machine compartment. Either run drain to a floor drain or add a valve to the base of the machine compartment and drain the rail to a container when convenient. The LiquiTec option will NOT have a drain available.



CAUTION

Moisture collecting from improper drainage can create a slippery surface on the floor and a hazard to employees. It is the owner's responsibility to provide a container or outlet for drainage.

Electrical connection

Refer to the specification pages amperage data, the serial tag, your local code or the National Electrical Code to be sure the unit is connected to the proper power source. A protected circuit of the correct voltage and amperage must be run for connection of the line cord, or permanent connection of the unit.

Self-contained units with a cord and plug have an **ON/OFF** switch located directly behind the louvered panel covering the compressor section. Simply turn the switch to **ON** to begin operation.



DANGER

The power switch must be turned to OFF and the unit disconnected from the power source whenever performing service or maintenance functions.

Never operate the unit without the louvered panel in place!

If electrical receptacles are to be mounted in the unit's backsplash, they must be wired independently from the existing unit wiring.

Refrigerator Operation

Power up the unit by turning **ON** the unit's **ON/OFF** switch. Delfield refrigerated bases are designed to maintain an operational temperature of 36°F to 40°F (2°C to 4°C). Temperature in the salad top and refrigerated rail opening is 33°F to 41°F (0°C to 5°C) with pans recessed 2" (5.1cm) on a standard wrapped refrigerated rail or flush with the LiquiTec option at 86°F (30°C) ambient room temperature.



NOTE:

Do not place hot pans on/against the blue ABS liner. Do not throw items into the storage area. Failure to heed these recommendations could result in damage to the interior of the cabinet or to the blower coil.



NOTE:

Overloading the storage area, restricting the air flow, and continuous opening and closing of the doors and drawers will hamper the units ability to maintain operational temperature.

Refrigerated rail units

Product in the rail should be removed to the refrigerated base at the end of the day. This allows you to turn the rail off at night to save energy and the rail will have time to defrost as needed. It also helps maintain product quality. The standard wrapped refrigerated units are controlled by the pressure control which is set to maintain the proper rail temperature. An on/off switch is also provided for the rail and is required to be shut off at night. The rail switch shuts off the rail only. With a LiquiTec rail a thermostat is provided to maintain rail temperature as well as the rail on/off switch. The LiquiTec rail is required to be shut off at night as well to allow for defrosting. To ensure product

quality in the rail it is recommended that product be rotated every four hours.



If adding any item to the unit, be sure to keep in mind the location of the refrigeration lines on wrapped rail units. A refrigeration leak in a rail is extremely difficult and costly to repair. In some cases it cannot be repaired at all.

Refrigerator Evaporator Fan Operation

When the refrigerator is initially powered up or immediately following a power outage the unit will begin cooling after a 3-6 minute delay. During normal operation the evaporator fan pulses independently of the compressor as dictated by the controller as follows:

1. During the cooling mode, compressor and evaporator fan run simultaneously.
2. During the compressor off mode, evaporator fan pulses three minutes on and three minutes off.
3. During an actual defrost event other than the off-cycle defrost, compressor stays off but the evaporator fan runs continuously.

Cooling Cycle				Defrost Cycle	
Compressor On		Compressor Off		Compressor Off	
Evap Fan On	Evap Fan Off	Evap Fan On	Evap Fan Off	Evap Fan On	Evap Fan Off
X		Cycles On 3-Min, Off 3-Min		X	

Freezer Operation

Power up the unit by turning **ON** the unit's **ON/OFF** switch. Delfield freezer bases are designed to maintain an operational temperature of 0°F (-18°C).



NOTE:

Do not place hot pans on/against the blue ABS liner. Do not throw items into the storage area. Failure to heed these recommendations could result in damage to the interior of the cabinet or to the blower coil.



NOTE:

Overloading the storage area, restricting the air flow, and continuous opening and closing of the doors and drawers will hamper the units ability to maintain operational temperature.

Freezer Evaporator Fan Operation

The evaporator fan(s) and condenser fan will cycle off and on with the compressor to conserve energy. The temperature control will cycle the compressor and condenser fan motor and evaporator fan motor to maintain box temperature at the control setting.

Cooling Cycle				Defrost Cycle	
Compressor On		Compressor Off		Compressor Off	
Evap Fan On	Evap Fan Off	Evap Fan On	Evap Fan Off	Evap Fan On	Evap Fan Off
X			X		X

Freezer Defrost

Self-contained models use hot gas to defrost the evaporator coils. Remote freezers use electric defrost.

Temperature Control Settings

A thermostat controls temperature in the self-contained F18WC, F18FC, F18MC base, F18SC base, F18RC base, F18DC base, F18PD base and F18PD rails.

Thermostats are located in the machine compartment. They are field adjustable and do not require a service agent. The factory setting is 2.5. Set toward 1 for higher temperatures and toward 7 for lower temperatures.

A thermostat controls temperature in the remote F18FR. The temperature control is located in the machine compartment. It is field adjustable and does not require a service agent. The factory setting for a remote freezer is 0°F cut-in with a 5°F differential.



Please make small incremental adjustments if a temperature adjustment is necessary. Contact the service department at Delfield +1 (989) 773-7981 or your local service agent for additional assistance. Delfield is not responsible for charges incurred while adjusting the thermostat.

Pressure Control Settings

A pressure control controls temperature in the F18MC mega top, F18SC salad top, F18RC rail and F18DC rail.

The factory recommended low-pressure control settings are: 55psi cut-in and 30psi cut-out to maintain proper temperature for product. The interior temperature is controlled by the thermostat mounted in the mechanical compartment.

A pressure control is located in the machine compartment. An adjustable control has the word COLDER on the knob, with an arrow to indicate the adjustment direction. These controls are field adjustable and do not require a service agent.



In attempting to adjust the pressure control, you can do damage to your unit by accidentally adjusting the differential. Please make small incremental adjustments if a temperature adjustment is necessary, please contact the service department at Delfield (800) 733-8829 or your local service agent. Delfield is not responsible for charges incurred while having the pressure control adjusted.

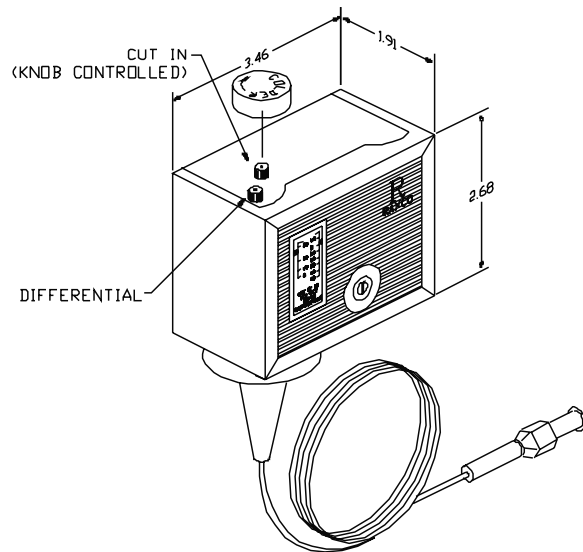

Maintenance

Door Gasket Maintenance

Door gaskets require regular cleaning to prevent mold and mildew build up and also to retain the elasticity of the gasket. Gasket cleaning can be done with the use of warm soapy water. Avoid full strength cleaning products on gaskets as this can cause them to become brittle and crack. Never use sharp tools or knives to scrape or clean the gasket. Gaskets can be easily replaced and do not require the use of tools or an authorized service person. The gaskets are “Dart” style and can be pulled out of the groove in the door and new gaskets can be “pressed” back into place.

Drain Maintenance - Base

Each unit has a drain located inside the unit that removes the condensation from the evaporator coil and routes it to an external condensate evaporator pan. Each drain can become loose or disconnected during normal use. If you notice water accumulation on the inside of the unit be sure the drain tube is connected to the evaporator drain pan. If water is collecting underneath the unit make sure the end of the drain tube is in the condensate evaporator in the machine compartment. The leveling of the unit is important as the units are designed to drain properly when level. Be sure all drain lines are free of obstructions.

Drawer Maintenance

Drawer Assembly Cleaning

The drawer assembly is designed to be cleaned easily. Both drawer and tracks are removable without tools. The drawer tracks are dishwasher safe or can be cleaned in a sink with detergents and a soft bristle brush. Drawers and tracks should be cleaned on a weekly basis.

Remove Drawers

Pull the drawer box out until it stops. Lift up on the drawer front and pull the drawer box completely out. Using a soft bristle brush, clean the track on the bottom of the drawer box. When finished, it should be wiped clean of all food and debris.

Tracks

The drawer box assembly must be removed. Pull the drawer tracks out until they hit a stop. Locate blue safety clips towards the back of each drawer track. Blue safety clips have a tab on the top. Push the tab back until it clicks. Lift up and pull the drawer tracks all the way out of the drawer cage. The drawer tracks are dishwasher safe or can be cleaned in a sink with detergents and a soft bristle brush. Drawers and tracks should be cleaned on a weekly basis. Using a soft bristle brush, wash the track making sure each roller is thoroughly cleaned. The drawer cage should be cleaned with a soft bristle brush, removing any food and debris gathered on the bottom ledge. Once it's cleaned thoroughly with a soft bristle brush, wipe remaining debris clean with a soft towel.

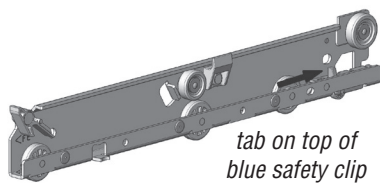

tab on top of blue safety clip

Reassembly

Push the drawer tracks into the drawer cage. The blue safety clip must remain pushed towards the back. Lift up and slide the drawer track all the way into the drawer cage. The blue safety clip will lock in place automatically. Once all tracks are replaced, insert the drawer box. Rest the drawer box bottom track on the front track roller. Then push the drawer back in place SLOWLY. When the drawer box is about half way in you will hit a STOP. You must lift the front of the drawer up approximately ½” (1.3cm) to continue inward. Clean tracks as often as possible. The cleaner the tracks are the better they will operate.

Caster Maintenance

Wipe casters with a damp cloth monthly to prevent corrosion.



The power switch must be turned to OFF and the unit disconnected from the power source whenever performing service, maintenance functions or cleaning the refrigerated area.

Refrigerators and Freezers

The interior and exterior can be cleaned using soap and warm water. If this isn't sufficient, try ammonia and water or a nonabrasive liquid cleaner. When cleaning the exterior, always rub with the “grain” of the stainless steel to avoid marring the finish. Do not use an abrasive cleaner because it will scratch the stainless steel and can damage the breaker strips and gaskets.

Stainless Steel Care and Cleaning

To prevent discoloration of rust on stainless steel several important steps need to be taken. First, we need to understand the properties of stainless steel. Stainless steel contains 70- 80% iron, which will rust. It also contains 12-30% chromium, which forms an invisible passive film over the steels surface, which acts as a shield against corrosion. As long as the protective layer is intact, the metal is still stainless. If the film is broken or contaminated, outside elements can begin to breakdown the steel and begin to form discoloration of rust. Proper cleaning of stainless steel requires soft cloths or plastic scouring pads.

NEVER USE STEEL PADS, WIRE BRUSHES OR SCRAPERS!

Cleaning solutions need to be alkaline based or non-chloride cleaners. Any cleaner containing chlorides will damage the protective film of the stainless steel. Chlorides are also commonly found in hard water, salts, and household and industrial cleaners. If cleaners containing chlorides are used be sure to rinse repeatedly and dry thoroughly. Routine cleaning of stainless steel can be done with soap and water. Extreme stains or grease should be cleaned with a non-abrasive cleaner and plastic scrub pad. Always rub with the grain of the steel. There are stainless steel cleaners available which can restore and preserve the finish of the steels protective layer. Early signs of stainless steel breakdown are small pits and cracks. If this has begun, clean thoroughly and start to apply stainless steel cleaners in attempt to restore the passivity of the steel.



Never use an acid based cleaning solution! Many food products have an acidic content, which can deteriorate the finish. Be sure to clean the stainless steel surfaces of ALL food products. Common items include, tomatoes, peppers and other vegetables.

Maintenance, continued

Cleaning the Condenser Coil

In order to maintain proper refrigeration performance, the condenser fins must be cleaned of dust, dirt and grease regularly. It is recommended that this be done at least every three months. If conditions are such that the condenser is totally blocked in three months, the frequency of cleaning should be increased. Clean the condenser with a vacuum cleaner or stiff brush. If extremely dirty, a commercially available condenser cleaner may be required.

Failure to maintain a clean condenser coil can initially cause high temperatures and excessive run times. Continuous operation with a dirty or clogged condenser coil can result in compressor failure. Neglecting the condenser coil cleaning procedures will void any warranties associated with the compressor and cost to replace the compressor.



Never use a high-pressure water wash for this cleaning procedure as water can damage the electrical components located near or at the condenser coil.

Doors/Hinges

Over time and with heavy use doors the hinges may become loose. If this happens tighten the screws that mount the hinge brackets to the frame of the unit. Loose or sagging doors can cause the hinges to pull out of the frame, which may damage both the doors and the hinges. In some cases this may require qualified service agents or maintenance personnel to perform repairs.



Do not place hot pans on/against the blue ABS liner. Do not throw items into the storage area. Failure to follow these recommendations could result in damage to the interior of the cabinet or to the blower coil. Overloading the storage area, restricting the airflow, and continuous opening and closing of the doors and drawers will hamper the units ability to maintain operational temperature.

Refrigerated rail units

Product in the rail should be removed to the refrigerated base at the end of the day. This allows you to turn the rail off at night to save energy and to defrost the rail. It also helps maintain product quality. The standard wrapped refrigerated rail units are controlled by a low-pressure control that is set to maintain the proper rail temperature. An on/off switch is also provided for the rail and is required to be shut off at night. With a LiquiTec rail a thermostat is provided to maintain rail temperature as well as the rail on/off switch. The LiquiTec rail is required to be shut off at night as well to allow for defrosting. To ensure product quality in the rail it is recommended that product be rotated every four hours.



If adding any item to the unit, be sure to keep in mind the location of the refrigeration lines on wrapped rail units. A refrigeration leak in a rail is extremely difficult and costly to repair. In some cases it cannot be repaired at all.

Preventing blower coil corrosion

To help prevent corrosion of the blower coil, store all acidic items, such as pickles and tomatoes, in sealable containers. Immediately wipe up all spills.



Units with pans should be operated with pans in place. Operating the unit without all pans in place will lower efficiency and may damage the unit.

Continuous opening and closing of the doors will hamper the unit's ability to maintain optimum refrigeration temperature. Top section is not intended for overnight storage. Product should be removed from pans. Pans can remain in unit while empty.

Wiring Diagram, F18WC

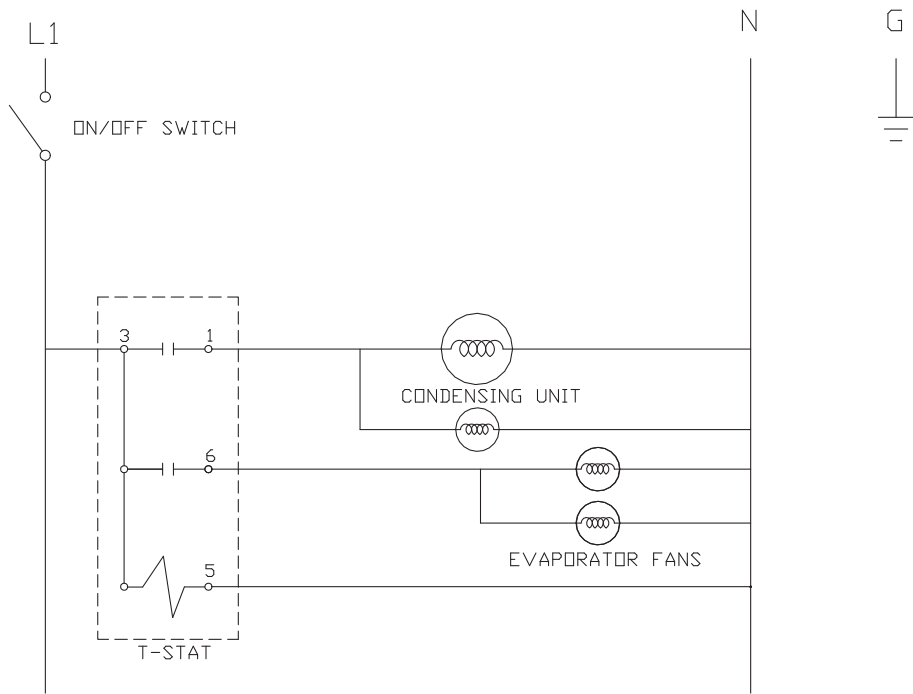

Wiring Diagram, F18WR

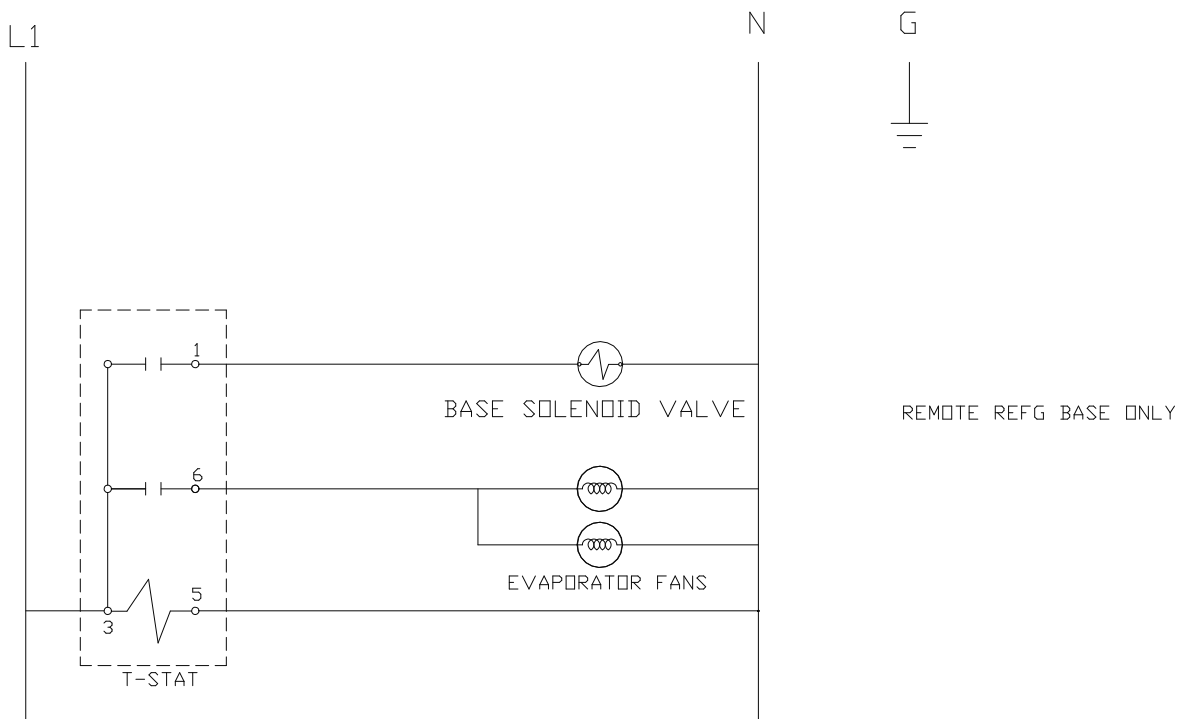

Wiring Diagram, F18MC, F18SC, F18DC & F18RC

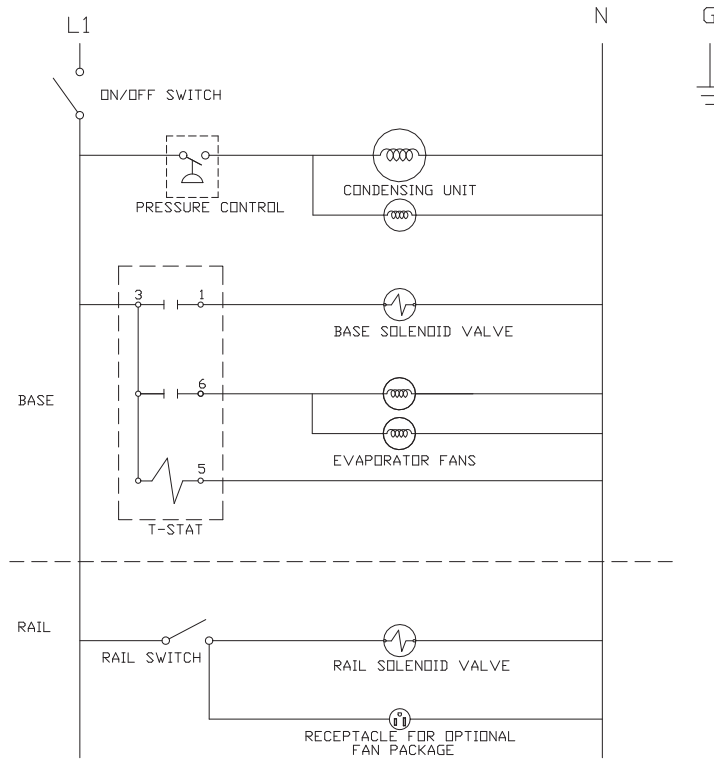

Wiring Diagram, F18MR, F18SR, F18DR & F18RR

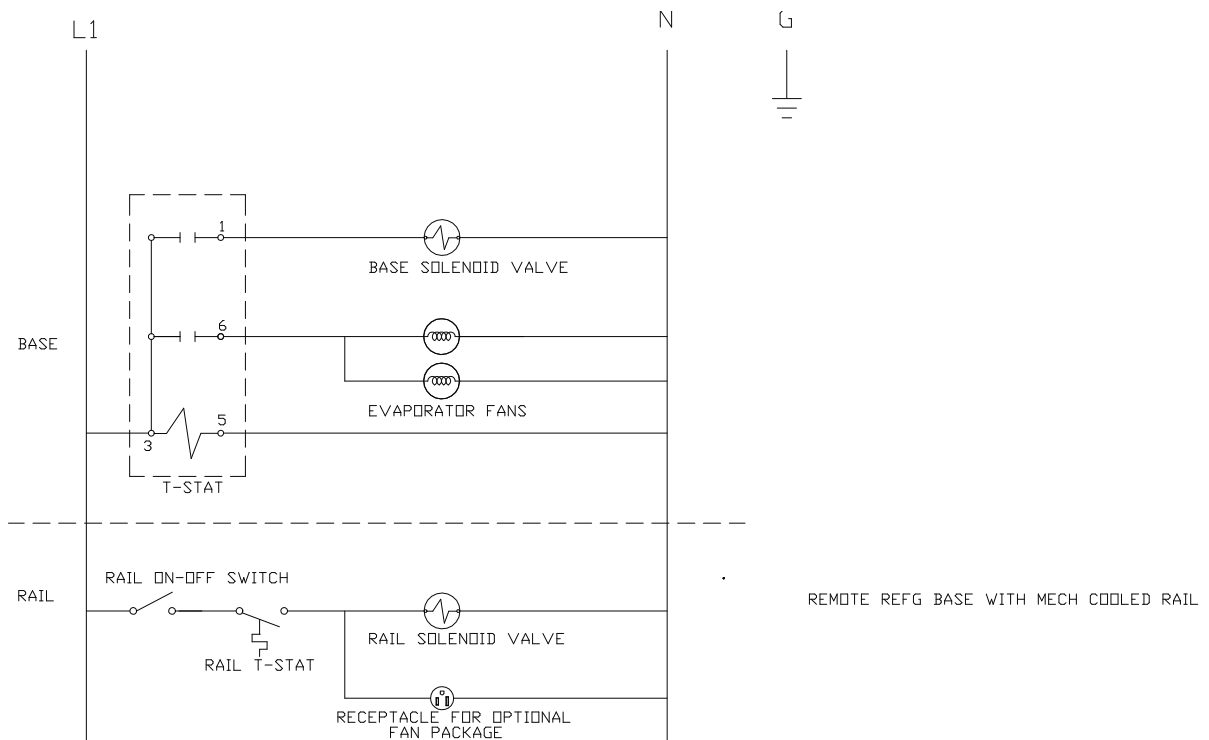

Wiring Diagram, F18FC

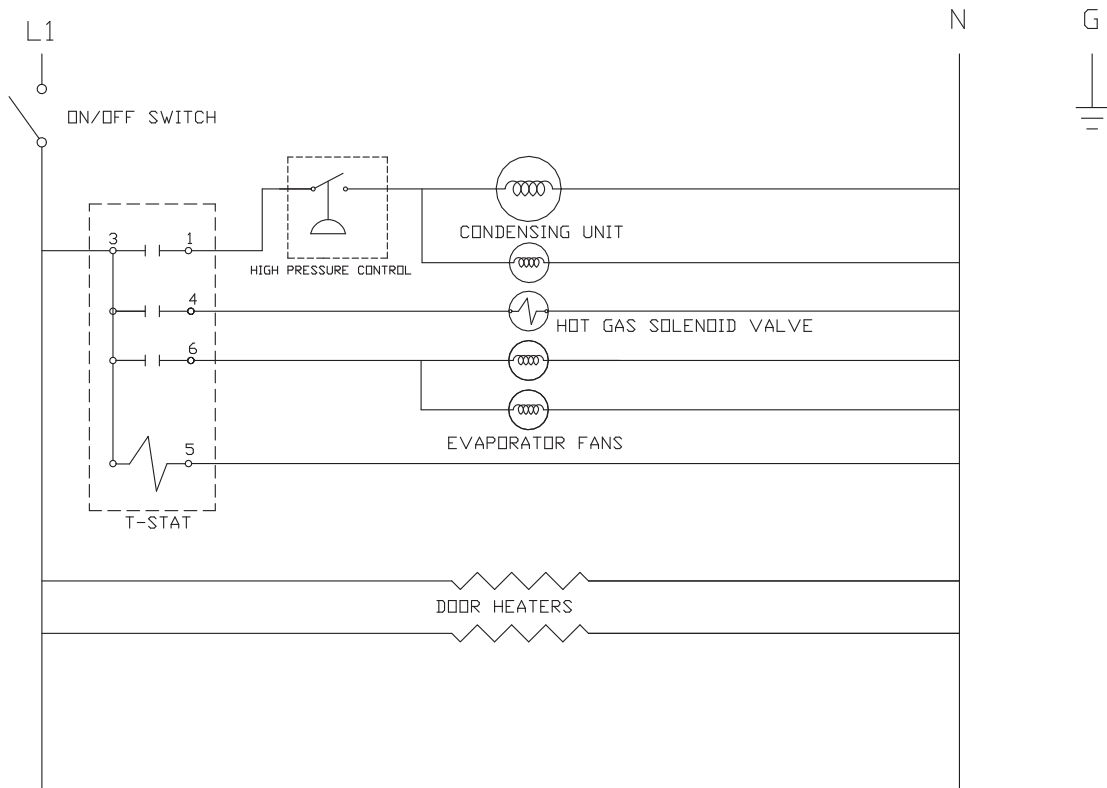

Wiring Diagram, F18FR

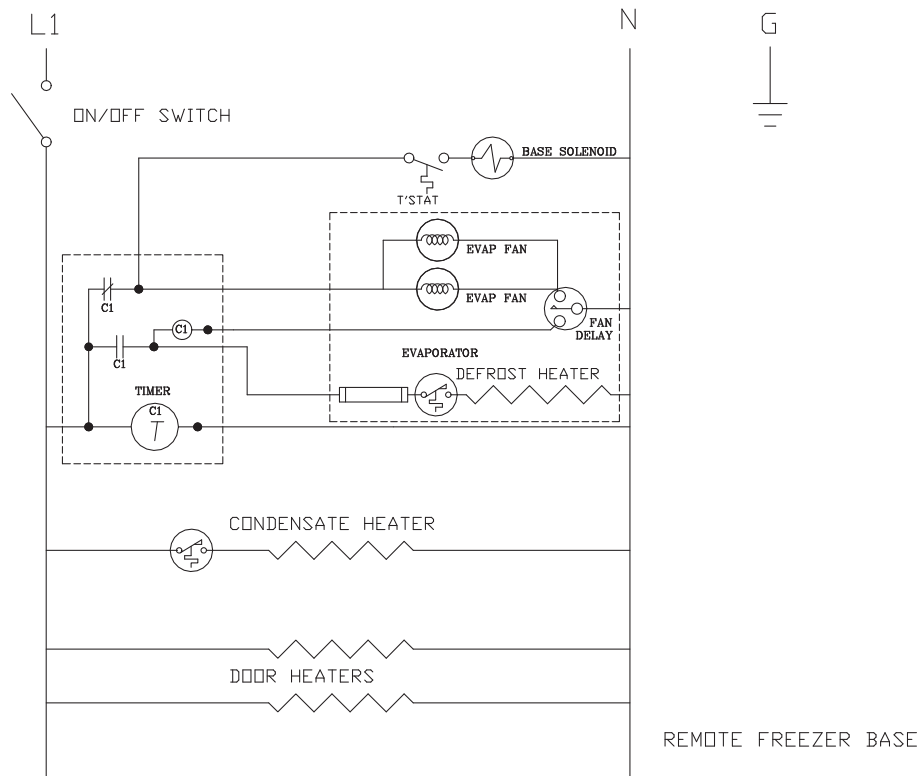

Wiring Diagram, F18PD

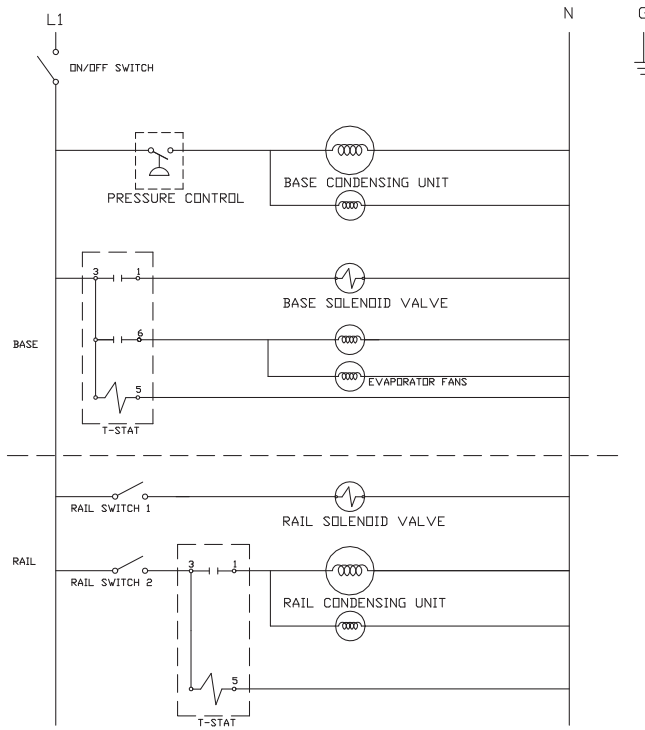

Replacement Parts

F18DC

3516053	Coil, solenoid, 120V/50/60HZ (rail)
*000-248-0030	Coil assembly, R404A
*000-BN5-0035	Condensing unit, 1/2hp, R404a
*000-BN5-0037	Condensing unit, 1/3hp, R404a
*000-BN5-0030	Condensing unit, 1/4hp, R404a
2194810	Control, Danfoss, GDM, 115V
2193927	Control, pressure, low
3234392	Hinge, pan cover, center
3234282	Hinge, pan cover, left
3234266	Hinge, pan cover, right
9321374	Hinge, pin (for pan cover)
0160179	Hinge Kit
3234645	Leg, 6", s/s
3977984	Shelf, 19" door
3977998	Shelf, 24" door
3978014	Shelf, 27" door
3977983	Shelf, 32" door
2190154	Switch, rocker
3516225	Valve, expansion (rail)
3516102	Valve, solenoid (rail)
3234290	Shelf support, 1" blue
9321040	Shelf support screw (coil side)
9321132	Shelf support screw (wall side)

F18DR

3516053	Coil, solenoid, 120V/50/60HZ (rail)
*000-248-0030	Coil assembly, R404A
*000-248-0037	Coil assembly, R404A, Fan Lt
2194810	Control, Danfoss, GDM, 115V
3234392	Hinge, pan cover, center
3234282	Hinge, pan cover, left
3234266	Hinge, pan cover, right
9321374	Hinge, pin (for pan cover)
0160179	Hinge Kit (left or right hinged)
3234645	Leg, 6", s/s
3977984	Shelf, 19" door
3977998	Shelf, 24" door
3978014	Shelf, 27" door
3977983	Shelf, 32" door
3234290	Shelf support, 1" blue

9321040	Shelf support screw (coil side)
9321132	Shelf support screw (wall side)
2190154	Switch, rocker
2194201	Thermostat, rail
3516225	Valve, expansion (rail)
3516102	Valve, solenoid (rail)

F18FC

*000-BN5-0053	Condensing unit, 1/3HP, w/rec, hg
*000-BN5-0054	Condensing unit, 1/2HP, low temp, hg
*000-BN5-0055	Condensing unit, 3/4HP, low temp, hg
*000-249-0004	Coil, assembly, freezer, R404a
2194758-4	Control, Danfoss, Freezer, 115V
0160179	Hinge Kit
3234645	Leg, 6", s/s
9321040	Shelf support screw (coil side)
9321132	Shelf support screw (wall side)
3234290	Shelf support, 1" blue
3977984	Shelf, 19" door
3977998	Shelf, 24" door
3978014	Shelf, 27" door
3977983	Shelf, 32" door
2190154	Switch, rocker

F18FR

*000-249-0006	Coil assembly, frz evap, remote
3516053	Coil, solenoid, 120V/50/60HZ
3516056	Control, Temperature
0160179	Hinge Kit
3234645	Leg, 6", s/s
9321040	Shelf support screw (coil side)
9321132	Shelf support screw (wall side)
3234290	Shelf support, 1" blue
3977984	Shelf, 19" door
3977998	Shelf, 24" door
3978014	Shelf, 27" door
3977983	Shelf, 32" door
2194151	Timer, Paragon, #8145-00
3516102	Valve, solenoid

*Replacement part assemblies on pages 19-22.

Replacement Parts, continued

F18MC

030-209-0030	Angle, Coil, Top Baffle
3516053	Coil, solenoid, 120V/50/60HZ (rail)
*000-248-0030	Coil assembly, R404A
*000-248-0037	Coil assembly, R404A, Fan Lt
*000-BN5-0030	Condensing unit, 1/4hp, R404a
2194810	Control, Danfoss, GDM, 115V
2193927	Control, pressure, low
3234392	Hinge, pan cover, center
3234282	Hinge, pan cover, left
3234266	Hinge, pan cover, right
9321374	Hinge, pin (for pan cover)
0420068	Hinge kit, lo profile (left or right)
2190154	Switch, rocker
3516225	Valve, expansion (rail)
3516102	Valve, solenoid (rail)
3234645	Leg, 6", s/s

F18MR

030-209-0030	Angle, Coil, Top Baffle
3516053	Coil, solenoid, 120V/50/60HZ (rail)
*000-248-0030	Coil assembly, R404A
*000-248-0037	Coil assembly, R404A, Fan Lt
2194810	Control, Danfoss, GDM, 115V
3234392	Hinge, pan cover, center
3234282	Hinge, pan cover, left
3234266	Hinge, pan cover, right
9321374	Hinge, pin (for pan cover)
0420068	Hinge kit, lo profile (left or right)
3234645	Leg, 6", s/s
9321041	Nut, acorn (for pan cover)
2190154	Switch, rocker
2194201	Thermostat, rail
3516225	Valve, expansion (rail)
3516102	Valve, solenoid (rail)

F18PD48

*000-248-0037	Coil assembly, R404A, Fan Lt
*000-BN5-0040	Condensing Assembly, 1/3-1/5 Stacked
2194810	Control, Danfoss, GDM, 115V
2194938	Control, Tstat, Danfoss, Etc1h-1
*000-402-0056	Cover Assembly, hinged, 6 pan, l/t
*000-187-006B	Door Assembly, ref, 27x26, lt
3234645	Leg, 6, s/s, removable Foot
*356-478-0038	Panel, louver, 14.0, sw Cut, lh
3978014	Shelf, wire, coated
3234290	Support, shelf, plastic
2190154	Switch, rocker, 20a/125v
3516135	Thermometer, hanging, 4

F18PD72

*000-248-0030	Coil assembly, R404A
*000-BN5-003Y	Condensing Assembly, 1/2-1/5 Stacked
2194810	Control, Danfoss, GDM, 115V
2194938	Control, Tstat, Danfoss, Etc1h-1
*000-402-0056	Cover Assembly, hinged, 6pan, l/t
*000-187-006B	Door Assembly, ref, 27x26, lt
*000-187-006A	Door Assembly, ref, 27x26, rt
3234645	Leg, 6, s/s, removable Foot
*356-478-0039	Panel, louver, 18.0, sw Cut, lh
3978014	Shelf, wire, coated
3234290	Support, shelf, plastic
2190154	Switch, rocker, 20a/125v
3516135	Thermometer, hanging, 4

*Replacement part assemblies on pages 19-22.



Replacement Parts, continued

F18RC

3516053	Coil, solenoid, 120V/50/60HZ (rail)
*000-248-0030	Coil assembly, R404A
*000-BN5-0035	Condensing unit, 1/2hp, R404a
*000-BN5-0037	Condensing unit, 1/3hp, R404a
*000-BN5-0030	Condensing unit, 1/4hp, R404a
2194810	Control, Danfoss, GDM, 115V
2193927	Control, pressure, low
3234392	Hinge, pan cover, center
3234282	Hinge, pan cover, left
3234266	Hinge, pan cover, right
9321374	Hinge, pin (for pan cover)
0160179	Hinge Kit
3234645	Leg, 6", s/s
3977984	Shelf, 19" door
3977998	Shelf, 24" door
3978014	Shelf, 27" door
3977983	Shelf, 32" door
3234290	Shelf support, 1" blue
9321040	Shelf support screw (coil side)
9321132	Shelf support screw (wall side)
2190154	Switch, rocker
3516225	Valve, expansion (rail)
3516102	Valve, solenoid (rail)

F18RR

3516053	Coil, solenoid, 120V/50/60HZ (rail)
*000-248-0030	Coil assembly, R404A
*000-248-0037	Coil assembly, R404A, Fan Lt
2194810	Control, Danfoss, GDM, 115V
3234392	Hinge, pan cover, center
3234282	Hinge, pan cover, left
3234266	Hinge, pan cover, right
9321374	Hinge, pin (for pan cover)
0160179	Hinge Kit
3234645	Leg, 6", s/s
3977984	Shelf, 19" door
3977998	Shelf, 24" door
3978014	Shelf, 27" door
3977983	Shelf, 32" door
3234290	Shelf support, 1" blue

9321040	Shelf support screw (coil side)
9321132	Shelf support screw (wall side)
2190154	Switch, rocker
2194201	Thermostat, rail
3516225	Valve, expansion (rail)
3516102	Valve, solenoid (rail)

F18SC

030-209-0030	Angle, Coil, Top Baffle
3516053	Coil, solenoid, 120V/50/60HZ (rail)
*000-248-0030	Coil assembly, R404A
*000-248-0037	Coil assembly, R404A, Fan Lt
*000-BN5-0030	Condensing unit, 1/4hp, R404a
2194810	Control, Danfoss, GDM, 115V
2193927	Control, pressure, low
3234392	Hinge, pan cover, center
3234282	Hinge, pan cover, left
3234266	Hinge, pan cover, right
9321374	Hinge, pin (for pan cover)
0420068	Hinge kit, lo profile (left or right)
3234645	Leg, 6", s/s
2190154	Switch, rocker
3516225	Valve, expansion (rail)
3516102	Valve, solenoid (rail)

*Replacement part assemblies on pages 19-22.

Replacement Parts, continued

F18SR

030-209-0030	Angle, Coil, Top Baffle
3516053	Coil, solenoid, 120V/50/60HZ (rail)
*000-248-0030	Coil assembly, R404A
*000-248-0037	Coil assembly, R404A, Fan Lt
2194810	Control, Danfoss, GDM, 115V
3234392	Hinge, pan cover, center
3234282	Hinge, pan cover, left
3234266	Hinge, pan cover, right
9321374	Hinge, pin (for pan cover)
0420068	Hinge kit, lo profile (left or right)
3234645	Leg, 6", s/s
2190154	Switch, rocker
2194201	Thermostat, rail
3516225	Valve, expansion (rail)
3516102	Valve, solenoid (rail)

F18WC

*000-248-0030	Coil assembly, R404A
*000-248-0037	Coil assembly, R404A, Fan Lt
*000-BN5-0030	Condensing unit, 1/4hp, R404a
*000-BN5-0031	Condensing unit, 1/5hp, R404a
2194810	Control, Danfoss, GDM, 115V
0160179	Hinge Kit
3234645	Leg, 6", s/s
3977984	Shelf, 19" door
3977998	Shelf, 24" door
3978014	Shelf, 27" door
3977983	Shelf, 32" door
2190154	Switch, rocker
3234290	Shelf support, 1" blue
9321040	Shelf support screw (coil side)
9321132	Shelf support screw (wall side)

F18WR

*000-248-0030	Coil assembly, R404A
*000-248-0037	Coil assembly, R404A, Fan Lt
2194810	Control, Danfoss, GDM, 115V
0160179	Hinge Kit (left or right hinged)
3234645	Leg, 6", s/s
3977984	Shelf, 19" door
3977998	Shelf, 24" door
3978014	Shelf, 27" door
3977983	Shelf, 32" door
3234290	Shelf support, 1" blue
9321040	Shelf support screw (coil side)
9321132	Shelf support screw (wall side)

*Replacement part assemblies on pages 19-22.



Replacement Part Assemblies

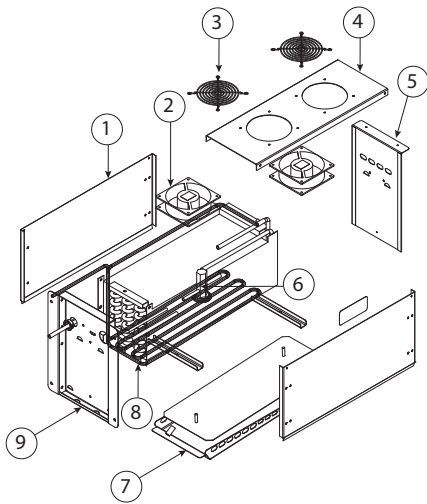

Key	Part Number	Description
-	000-249-0004	Coil Assembly, Evap, Freezer
1	030-262-0001	Side, evaporator
2	2160023	Fan, axiel
3	2160024	Guard, fan, 4.7", SC120-W2
4	030-260-0001	Top, frz, evaporator
5	030-259-0000	Front, enclosure
6	3516271	Valve, expansion, R404a
7	265-261-0001	Pan, freezer evaporator
8	3516073	Coil, Evaporator
9	030-263-0001	Back, evaporator
-	2184318	Harness, coil, frz, male
-	2194808	Probe, Defrost, Danfoss, Control
-	2194809	Probe, Temp, Sensor, Danfoss

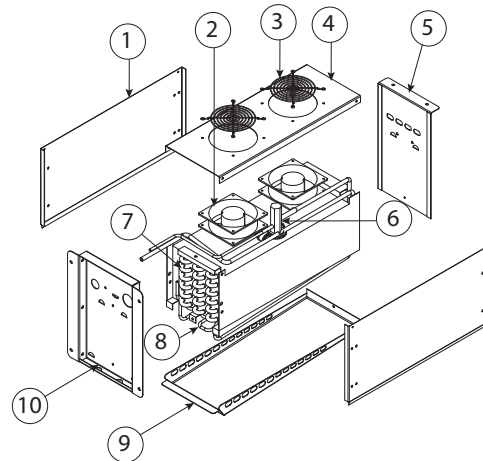

Key	Part Number	Description
-	000-249-0006	Coil Assembly, Freezer Evap, Remote
1	030-262-0001	Side, evaporator
2	2160023	Fan, axiel
3	2160024	Guard, fan, 4.7", SC120-W2
4	030-260-0001	Top, frz, evaporator
5	030-259-0000	Front, enclosure
6	3516271	Valve, expansion, R404a
7	3516073	Coil, Evaporator
8	2194034	Heater, Defrost
9	265-261-0001	Pan, freezer evaporator
10	030-263-0001	Back, evaporator
-	2194046	Control, Limit, Fan Delay/Defrost
-	2194631	Fuse, Defrost Heater, 7 Amp
-	2184323	Harness, coil, frz, male, remote

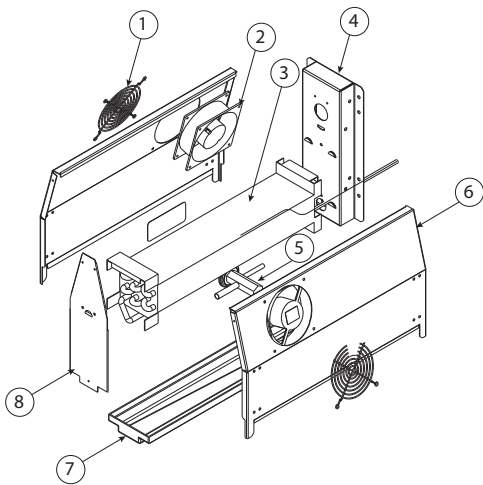

Key	Part Number	Description
-	000-248-0030	Coil Assembly, R404A, Ref
1	2160024	Guard, fan, 4.7"
2	2160023	Fan, axiel, 120V
3	3516095	Coil, evaporator
4	030-232-0003	Back, evaporator, enclosure
5	3516273	Expansion valve, 1/4, R-404a
6	030-233-0001	Side, coil, angled
7	075-231-0033	Drip pan, evaporator
8	030-234-0003	Front, coil
-	2184317	Harness, coil
-	2194808	Probe, Defrost, Danfoss, Control
-	2194809	Probe, Temp, Sensor, Danfoss

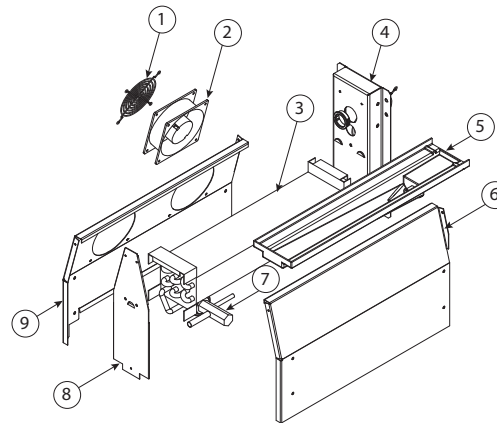

Key	Part Number	Description
-	000-248-0037	Coil Assembly, R404A, Ref, Fan Lt
1	2160024	Guard, fan, 4.7"
2	2160023	Fan, axiel, 120V
3	3516095	Coil, evaporator
4	030-232-0003	Back, evaporator, enclosure
5	000-BNH-0030	Drip pan, evaporator
6	030-233-0038	Side, coil, angled, Rt, Blank
7	3516273	Expansion valve, 1/4, R-404a
8	030-234-0003	Front, coil
9	030-233-0039	Side, Coil, Angled, Lt, 2Fan
-	2184317	Harness, coil
-	2194808	Probe, Defrost, Danfoss, Control
-	2194809	Probe, Temp, Sensor, Danfoss

Replacement Part Assemblies, continued

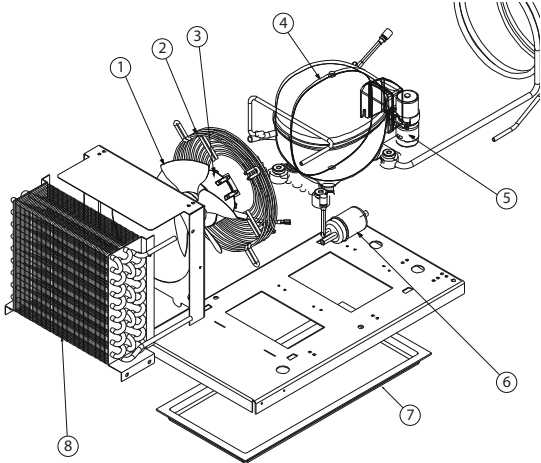

Key	Part Number	Description
-	000-BN5-0030	Assembly, 1/4 HP Condensing Unit
1	3516457	Fan Blade
2	2160020	Fan Guard
3	2162717	Fan Motor
4	3526999	Compressor, Danfoss, NF5.5CLX
5	2194787	Start Capacitor
6	3516322	Filter Dryer
7	075-231-0030	Condensate Pan
8	3516454	Condenser Coil
-	3516444	Comp, Relay, Overload, NF5.5CLX

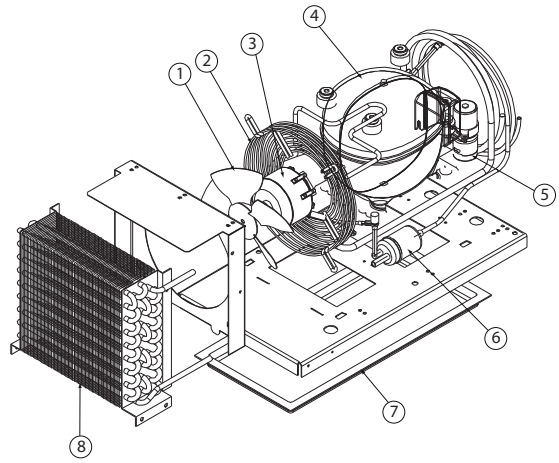

Key	Part Number	Description
-	000-BN5-0031	Assembly, 1/5 Condensing Unit
1	3516457	Fan Blade
2	2160020	Fan Guard
3	2162717	Fan Motor
4	3526997	Compressor, Danfoss, TF4CLS
5	2194787	Start Capacitor
6	3516322	Filter Dryer
7	075-231-0030	Condensate Pan
8	3516454	Condenser Coil
-	3516446	Comp, Relay, Danfoss

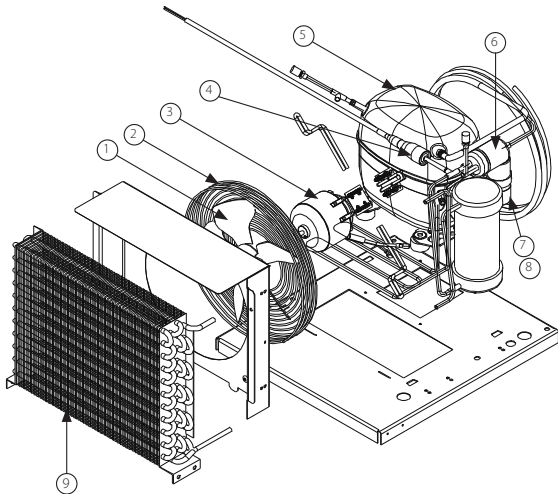

Key	Part Number	Description
-	000-BN5-0054	Assembly, 1/2HP Cond, Low, Hot gas
1	3516554	Blade, Fan, 9.00"
2	2160019	Guard, Fan, Wire
3	2162716	Motor, Fan, 16W, 115V, CW
4	3516324	Cutout, High Pressure
5	3527001	Compressor, SC12CLX.2,115/60HZ
6	3516322	Drier, Filter, (2)Inlet
7	2194789	Capacitor, Start, 240MFD
8	3516441	Relay, Comp, SC12CLX.2
9	3516455	Coil, Condenser, 1/2 HP
-	024-034-0031	Pan, Comp, 18.00

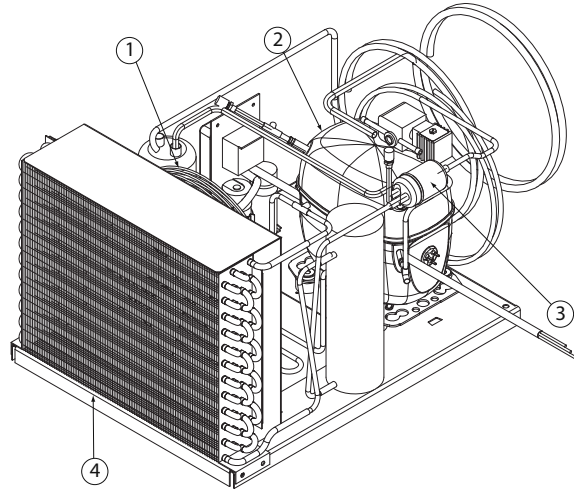

Key	Part Number	Description
-	000-BN5-0055	Assembly, 3/4 HP Cond, Low, Hot gas
1	2160019	Guard, fan condenser
	2162716	Motor, condenser fan 16W, 115V
	3516433	Blade, fan 10" CW
2	3527002	Compressor, SC18CLS.2, 115V60hz
	3516442	Capacitor, start, run assembly
3	3516322	Filter drier
4	3516456	Coil, condenser, 3/4hp

Replacement Part Assemblies, continued

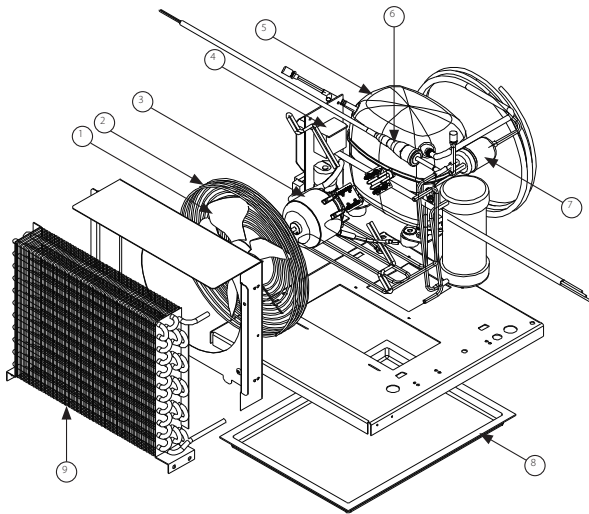

Key	Part Number	Description
-	000-BN5-0035	Assembly, 1/2HP Condenser, Med
1	3516554	Condenser fan blade
2	2160019	Condenser fan guard
3	2162716	Condenser fan motor, 115V
4	3516462	Capacitor, start-run assy
5	3527026	Compressor, Danfoss, SC12MLX
6	3516331	Hi pressure switch
7	3516322	Filter Drier
8	075-231-0031	Pan, Condensate
9	3516455	Condenser coil

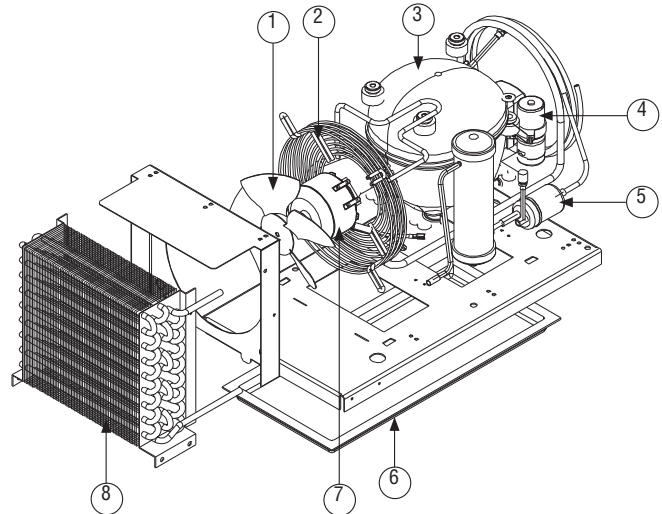

Key	Part Number	Description
-	000-BN5-0037	Assembly, 1/3 Condensing Unit
1	3516457	Fan Blade
2	2160020	Fan Guard
3	3527000	Compress, Danfoss, NF7CLS
4	2194788	Start Capacitor
5	3516322	Filter Drier
6	075-231-0030	Pan, Condensate
7	2162717	Fan Motor
8	3516454	Condenser Coil
-	3516438	Relay, overload, compressor

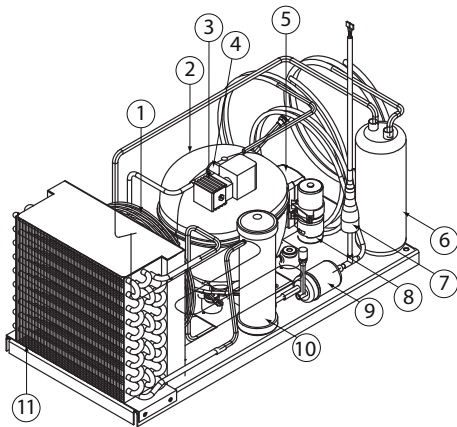

Key	Part Number	Description
-	000-BN5-0053	Assembly, 1/3HP Cond, w/rec, hg
1	3516457	Blade, Fan, 7.25"
	2160020	Guard, Fan, 7.25"
	2162717	Motor, Fan, 9W, 115V
2	3527000	Compressor, NF7.0,115/60HZ, Danfoss
3	3516053	Coil, Solenoid, 120V
4	3516102	Valve, Solenoid, 1/4ODF
5	3516438	Relay, Comp, ovld
6	3516397	Accumulator
7	000-998-0030	High Pressure Assembly, 8Amp
8	2194788	Capacitor, Start, 320MFD
9	3516322	Filter Drier, (2)Inlet
10	3516458	Receiver
11	3516454	Coil, Condenser

Replacement Part Assemblies, continued

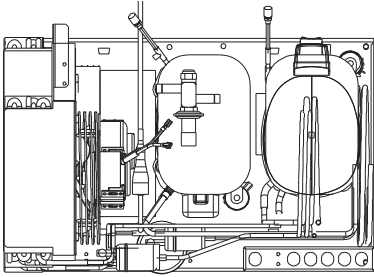

000-BN5-003Y	Assembly, 1/2-1/5 Stacked,
3516457	Blade, Fan, 7.25 Dia.,
3516433	Blade, fan, 25deg, 10", cw
2194789	Capacitor, start, 240mfd
2194787	Capacitor, start, 280mfd
3516454	Coil, Condenser, 1/5, 1/4,
3516455	Coil, Condenser, 1/2 Hp
3526997	Compressor, 1/5hp, 115/60, r404a
3527001	Compressor, sc12clx.2, 115/60hz,
3516322	Drier, filter, (2)inlet
2160020	Guard, Fan, 7.25
2160019	Guard, fan, wire
2162717	Motor, fan, 9w, 115v, cw
2162513	Motor, fan, 35w, blast
3516193	Regulator, pressure, 1/2
3516446	Relay, Compressor, Danfoss
3516441	Relay, compressor, sc12clx.2
3516225	Valve, expansion, frz, 1/4ton

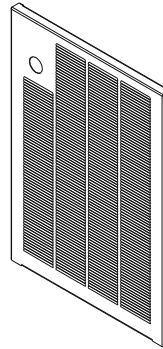

359-478-003E	Panel, louver, 15.0, ptb
359-478-003D	Panel, louver, 18.0, ptb
356-478-0038	Panel, louver, 14.0, sw Cut,lh
356-478-0039	Panel, louver, 18.0, sw Cut, lh

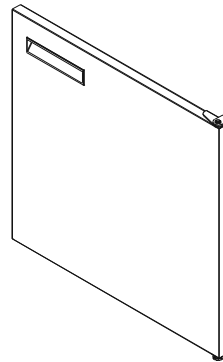

000-187-0081	Door Assembly, ref, 27x26, rt, 430
000-187-0082	Door Assembly, ref, 27x26, lt, 430
000-187-006B	Door Assembly, ref, 27x26, lt
000-187-006A	Door Assembly, ref, 27x26, rt
1701185	Gasket, door, 27, mark7
0420067	Hinge Kit

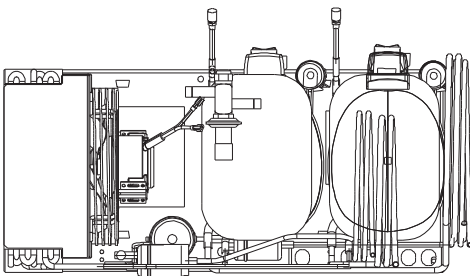

000-BN5-0040	Assy, 1/3-1/5 Stacked,
3516457	Blade, Fan, 7.25 Dia.
2194787	Capacitor, start, 280mfd
2194788	Capacitor, start, 320mfd
3516454	Coil, Cond., 1/5, 1/4
3526997	Comp, 1/5hp, 115/60, r404a
3527000	Comp, nf7cls, 115v/60hz
3516322	Drier, filter, (2)inlet
2160020	Guard, Fan, 7.25
2162717	Motor, fan, 9w,115v,cw
3516193	Regulator, pressure, 1/2
3516446	Relay, Comp, Danfoss
3516438	Relay, comp, ovlid, nf7clx
3516225	Valve, exp, frz, 1/4ton

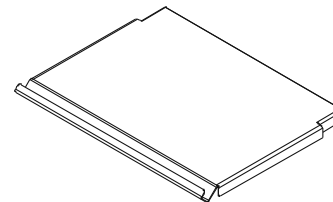

000-402-0054	Cover Assembly, hinged, 6 Pan, ptl
000-402-0056	Cover Assembly, hinged, 6pan, l/t
9321374	Pin, hinge, salad Pan
3234266	Hinge, pan Cover, end, rh,
3234282	Hinge, pan Cover, end, lh,
3234392	Hinge, pan Cover,

Standard One Year Limited Warranty — One Year Parts, 90 Day Labor

The Delfield Company (“Delfield”) warrants to the Original Purchaser of the Delfield product (herein called the “Unit”) that such Unit, and all parts thereof, will be free from defects in material and workmanship under normal use and service for a period of one (1) year from the date of shipment of the Unit to the Original Purchaser or one (1) year from the date of installation if registration is completed one (1) year from installation. During this one year warranty period, Delfield will repair or replace any defective part or portion thereof returned to Delfield by the Original Purchaser which Delfield determines was defective due to faulty material or workmanship. Only during the first 90 days of the this one year warranty period, Delfield will, subject to the limits set forth below, pay labor, crating, and freight incurred in the removal of the Unit of defective component and shipment to Delfield. A maximum of 1-hour is allowed to diagnose a defective component. A maximum of 1-hour is allowed for retrieval of parts not in stock. A maximum travel distance of 100 miles round trip and 2-hours will be reimbursed. Overtime, installation/start-up, normal control adjustments, general maintenance, glass breakage, freight damage, delayed site entry because of security or hours of operation and/or correcting an end-user installation error will not be reimbursed under warranty unless pre-approved with a Service Work Authorization from Delfield. Delfield will pay the return costs if the Unit or part thereof was defective.

The term “Original Purchaser” as used herein means that person, firm, association, or corporation for whom the Unit was originally installed.

This warranty does not apply to any Unit or part thereof that has been subjected to misuse, neglect, alteration, or accident, such as accidental damage to the exterior finish, operated contrary to the recommendations specified by Delfield; or repaired or altered by anyone other than Delfield in any way so as to, in Delfield’s sole judgment, affect its quality or efficiency. This warranty does not apply to any Unit that has been moved from the location where it was originally installed. This warranty also does not cover the refrigerator drier, door gaskets or the light bulbs used in the Unit. The warranty is subject to the user’s normal maintenance and care responsibility as set forth in the Service and Installation Manual, such as cleaning the condenser coil, and is in lieu of all other obligations of Delfield. Delfield neither assumes, nor authorizes any other person to assume for Delfield, any other liability in connection with Delfield’s products.

Removal or defacement of the original Serial Number or Model Number from any Unit shall be deemed to release Delfield from all obligations hereunder or any other obligations, express or implied.

Parts furnished by suppliers to Delfield are guaranteed by Delfield only to the extent of the original manufacturer’s express warranty to Delfield. Failure of the Original Purchaser to receive such manufacturer’s warranty shall in no way create any warranty, expressed or implied, or any other obligation or liability on Delfield’s part in respect thereof.

Under no condition does this warranty give the Original Purchaser the right to replace the defective Unit with a complete Unit of the same manufacturer or of another make. Unless authorized by Delfield in writing, this warranty does not permit the replacement of any part, including the motor-compressor, to be made with the part of another make or manufacturer.

No claims can be made under this warranty for spoilage of any products for any reason, including system failure.

The installation contractor shall be responsible for building access, entrance and field conditions to insure sufficient clearance to allow any hood(s), vent(s), or Unit(s) if necessary, to be brought into the building. Delfield will not be responsible for structural changes or damages incurred during installation of the Unit or any exhaust system.

Delfield shall not be liable in any manner for any default or delay in performance hereunder caused by or resulting from any contingency beyond Delfield’s control, including, but not limited to, war, governmental restrictions or restraints, strike, lockouts, injunctions, fire, food, acts of nature, short or reduced supply of raw materials, or discontinuance of the parts by the original part manufacturer.

Except as provided in any Additional Four Year Protection Plan, if applicable, and the Service Labor Contract, if applicable, the preceding paragraphs set forth the exclusive remedy for all claims based on failure of, or defect for Delfield products sold hereunder, whether the failure or defect arises before or during the warranty period, and whether a claim, however instituted, is based on contract, indemnity, warranty, tort (including negligence), strict liability, implied by statute, common-law or otherwise, and Delfield and its agents shall not be liable for any claims for personal injuries or consequential damages or loss, howsoever caused. Upon the expiration of the warranty period, all such liability shall terminate. **THE FOREGOING WARRANTIES ARE EXCLUSIVE AND IN LIEU OF ALL OTHER WARRANTIES, WHETHER WRITTEN, ORAL, IMPLIED OR STATUTORY. NO IMPLIED WARRANTY OF MERCHANTABILITY OR FITNESS FOR PARTICULAR PURPOSE SHALL APPLY, DELFIELD DOES NOT WARRANT ANY PRODUCTS OR SERVICES OF OTHERS**

This warranty supersedes and excludes any prior oral or written representations or warranties. The sole and exclusive remedies of any person relating to the Unit, and the full liability of Delfield for any breach of this warranty, will be as provided in this warranty.

Other than this Delfield Standard One Year Limited Warranty, any applicable Delfield Additional Four Year Protection Plan or applicable Delfield Service Labor Contract, the Original Purchaser agrees and acknowledges that no other warranties are offered or provided in connection with or for the Unit or any other part thereof. The liability of Delfield for breach of any warranty obligation hereunder is limited to: (i) the repair or replacement of the Delfield Product on which the liability is based, or with respect to services, re-performance of the services; or (ii) at Delfield’s option, the refund of the amount paid for said equipment or services. Any breach by Delfield with respect to any item or unit of equipment or services shall be deemed a breach with respect to that item or unit or service only

IN NO EVENT WILL DELFIELD BE LIABLE FOR SPECIAL, INCIDENTAL OR CONSEQUENTIAL DAMAGES, OR FOR DAMAGES IN THE NATURE OF PENALTIES.

If shipment of a replacement part is requested prior to the arrival in the Delfield factory of the part claimed to be defective, the Original Purchaser must accept delivery of the replacement part on a C.O.D. basis, with credit being issued after the part has been received and inspected at Delfield’s plant and determined by Delfield to be within this warranty.

F18PD One Year Limited Warranty — Parts And Labor

The Delfield Company (“Delfield”) warrants to the Original Purchaser of the Delfield product (herein called the “Unit”) that such Unit, and all parts thereof, will be free from defects in material and workmanship under normal use and service for a period of one (1) year from the date of shipment of the Unit to the Original Purchaser or one (1) year from the date of installation if registration is completed one (1) year from installation. During this one year warranty period, Delfield will repair or replace any defective part or portion thereof returned to Delfield by the Original Purchaser which Delfield determines was defective due to faulty material or workmanship. During this one year warranty period, Delfield will, subject to the limits set forth below, pay labor, crating, and freight incurred in the removal of the Unit of defective component and shipment to Delfield. A maximum of 1-hour is allowed to diagnose a defective component. A maximum of 1-hour is allowed for retrieval of parts not in stock. A maximum travel distance of 100 miles round trip and 2-hours will be reimbursed. Overtime, installation/start-up, normal control adjustments, general maintenance, glass breakage, freight damage, delayed site entry because of security or hours of operation and/or correcting an end-user installation error will not be reimbursed under warranty unless pre-approved with a Service Work Authorization from Delfield. Delfield will pay the return costs if the Unit or part thereof was defective.

The term “Original Purchaser” as used herein means that person, firm, association, or corporation for whom the Unit was originally installed.

This warranty does not apply to any Unit or part thereof that has been subjected to misuse, neglect, alteration, or accident, such as accidental damage to the exterior finish, operated contrary to the recommendations specified by Delfield; or repaired or altered by anyone other than Delfield in any way so as to, in Delfield’s sole judgment, affect its quality or efficiency. This warranty does not apply to any Unit that has been moved from the location where it was originally installed. This warranty also does not cover the refrigerator drier, door gaskets or the light bulbs used in the Unit. The warranty is subject to the user’s normal maintenance and care responsibility as set forth in the Service and Installation Manual, such as cleaning the condenser coil, and is in lieu of all other obligations of Delfield. Delfield neither assumes, nor authorizes any other person to assume for Delfield, any other liability in connection with Delfield’s products.

Removal or defacement of the original Serial Number or Model Number from any Unit shall be deemed to release Delfield from all obligations hereunder or any other obligations, express or implied.

Parts furnished by suppliers to Delfield are guaranteed by Delfield only to the extent of the original manufacturer’s express warranty to Delfield. Failure of the Original Purchaser to receive such manufacturer’s warranty shall in no way create any warranty, expressed or implied, or any other obligation or liability on Delfield’s part in respect thereof.

Under no condition does this warranty give the Original Purchaser the right to replace the defective Unit with a complete Unit of the same manufacturer or of another make. Unless authorized by Delfield in writing, this warranty does not permit the replacement of any part, including the motor-compressor, to be made with the part of another make or manufacturer.

No claims can be made under this warranty for spoilage of any products for any reason, including system failure.

The installation contractor shall be responsible for building access, entrance and field conditions to insure sufficient clearance to allow any hood(s), vent(s), or Unit(s) if necessary, to be brought into the building. Delfield will not be responsible for structural changes or damages incurred during installation of the Unit or any exhaust system.

Delfield shall not be liable in any manner for any default or delay in performance hereunder caused by or resulting from any contingency beyond Delfield’s control, including, but not limited to, war, governmental restrictions or restraints, strike, lockouts, injunctions, fire, flood, acts of nature, short or reduced supply of raw materials, or discontinuance of the parts by the original part manufacturer.

Except as provided in any Additional Four Year Protection Plan, if applicable, and the Service Labor Contract, if applicable, the preceding paragraphs set forth the exclusive remedy for all claims based on failure of, or defect for Delfield products sold hereunder, whether the failure or defect arises before or during the warranty period, and whether a claim, however instituted, is based on contract, indemnity, warranty, tort (including negligence), strict liability, implied by statute, common-law or otherwise, and Delfield and its agents shall not be liable for any claims for personal injuries or consequential damages or loss, howsoever caused. Upon the expiration of the warranty period, all such liability shall terminate. **THE FOREGOING WARRANTIES ARE EXCLUSIVE AND IN LIEU OF ALL OTHER WARRANTIES, WHETHER WRITTEN, ORAL, IMPLIED OR STATUTORY. NO IMPLIED WARRANTY OF MERCHANTABILITY OR FITNESS FOR PARTICULAR PURPOSE SHALL APPLY, DELFIELD DOES NOT WARRANT ANY PRODUCTS OR SERVICES OF OTHERS**

This warranty supersedes and excludes any prior oral or written representations or warranties. The sole and exclusive remedies of any person relating to the Unit, and the full liability of Delfield for any breach of this warranty, will be as provided in this warranty.

Other than this Delfield Standard One Year Limited Warranty, any applicable Delfield Additional Four Year Protection Plan or applicable Delfield Service Labor Contract, the Original Purchaser agrees and acknowledges that no other warranties are offered or provided in connection with or for the Unit or any other part thereof. The liability of Delfield for breach of any warranty obligation hereunder is limited to: (i) the repair or replacement of the Delfield Product on which the liability is based, or with respect to services, re-performance of the services; or (ii) at Delfield’s option, the refund of the amount paid for said equipment or services. Any breach by Delfield with respect to any item or unit of equipment or services shall be deemed a breach with respect to that item or unit or service only.

IN NO EVENT WILL DELFIELD BE LIABLE FOR SPECIAL, INCIDENTAL OR CONSEQUENTIAL DAMAGES, OR FOR DAMAGES IN THE NATURE OF PENALTIES.

If shipment of a replacement part is requested prior to the arrival in the Delfield factory of the part claimed to be defective, the Original Purchaser must accept delivery of the replacement part on a C.O.D. basis, with credit being issued after the part has been received and inspected at Delfield’s plant and determined by Delfield to be within this warranty.



Additional Four Year Protection Plan — For Motor-Compressor Only

Delfield Model# <div style="border: 1px solid black; height: 25px; width: 100%;"></div>	Serial# <div style="border: 1px solid black; height: 25px; width: 100%;"></div>	Installation Date <div style="border: 1px solid black; height: 25px; width: 100%;"></div>
--	--	--

General Conditions

In addition to the Standard One Year Warranty on the Motor-Compressor contained in the above listed Delfield product (the "Unit"), The Delfield Company ("Delfield") also agrees to repair, or exchange with similar or interchangeable parts in design and capacity at Delfield's option, the defective Motor-Compressor contained in the Unit (the "Motor-Compressor"), or any part thereof, for the Original Purchaser only, at any time during the four (4) years following the initial one (1) year period commencing on the date of installation for the Original Purchaser. This additional Warranty is only available if the Motor-Compressor is inoperative due to defects in material or factory workmanship, as determined by Delfield in its sole judgment and discretion. The Original Purchaser shall be responsible for returning the defective Motor-Compressor to Delfield prepaid, F.O.B. at the address shown on the back cover of this manual.

The term "Original Purchaser" as used herein shall be deemed to mean that person, firm, association, or corporation for whom the equipment was originally installed.

The term "Motor-Compressor" as used herein does not include unit base, air or water-cooled condenser, receiver, electrical accessories such as relay, capacitors, refrigerant controls, or condenser fan/motor assembly. This warranty does not cover labor charges incidental to the replacement of parts. This warranty further does not include any equipment to which said condensing unit is connected, such as cooling coils, temperature controls or refrigerant metering devices. This warranty shall be void if the Motor-Compressor, in Delfield's sole judgment, has been subjected to misuse, neglect, alteration or accident, operated contrary to the recommendations specified by the Unit manufacturer, repaired or altered by anyone other than Delfield in any way so as, in Delfield's sole judgment, to affect its quality or efficiency or if the serial number has been altered, defaced or removed. This Warranty does not apply to a Motor-Compressor in any Unit that has been moved from the location where it was originally installed. The addition of methyl chloride to the condensing unit or refrigeration system shall void this warranty.

Delfield shall not be liable in any manner for any default or delay in performance thereunder caused by or resulting from any contingency beyond Delfield's control including, but not limited to, war, governmental restrictions or restraints, strikes, lockouts, injunctions, fire, floods, acts of nature, short or reduced supply of raw material or discontinuance of any part or the Motor-Compressor by the unit manufacturer.

Replacement of a defective Motor-Compressor is limited to one (1) Motor-Compressor by us during the four (4) year period. Delfield shall replace the Motor-Compressor part only at no charge.

This Warranty does not give the Original Purchaser of the Motor-Compressor the right to purchase a complete re placement Motor-Compressor of the same make or of another make. It further does not permit the replacement to be made with a Motor-Compressor of another kind unless authorized by Delfield. In the event Delfield authorizes the Original Purchaser to purchase a replacement Motor-Compressor locally, only the wholesale cost of the Motor-Compressor is refundable.

Expressly excluded from this warranty are damages resulting from spoilage of goods.

Except as provided in any applicable Standard One Year Limited Warranty or applicable Service Labor Contract, the foregoing is exclusive and in lieu of all other war ran ties, whether written or oral, express or implied. This Warranty supersedes and excludes any prior oral or written representations or warranties. Delfield expressly disclaims any implied warranties of merchantability, fitness for a particular purpose or compliance with any law, treaty, rule or regulation relating to the discharge of substances into the environment. The sole and exclusive remedies of any person relating to the Motor-Compressor, and the full liability of Delfield for any breach of this Warranty, will be as provided in this Warranty.

Other than any applicable Delfield Standard One Year Limited Warranty, this Delfield Additional Four Year Protection Plan and any applicable Delfield Service Labor Contract, the Original Purchaser agrees and acknowledges that no other warranties are offered or provided in connection with or for the Motor-Compressor or any part thereof. In no event will Delfield be liable for special, incidental or consequential damages, or for damages in the nature of penalties.



Notes



Mt. Pleasant, MI



Covington, TN

Thank you for choosing Delfield!

Help is a phone call away. Help our team of professional, courteous customer service reps by having your model number and serial number available at the time of your call (800) 733-8829.

Model: _____ S/N: _____

Installation Date: _____



For a list of Delfield's authorized parts depots, visit our website at www.delfield.com.

