



Your Solutions Partner

Installation and Operation Manual

PRODUCT HOLDING CABINET

MODELS

FWM3-13

FWM3-14

FWM3-21

FWM3-22

FWM3-23

FWM3-24

FWM3-41

FWM3-42

FWM3-51

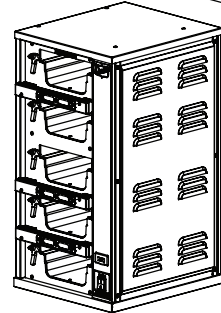
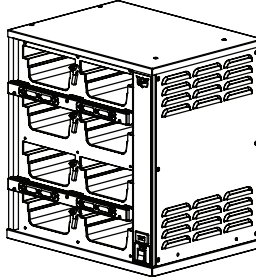
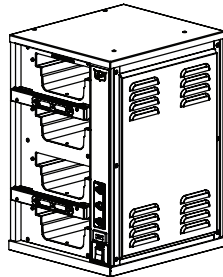
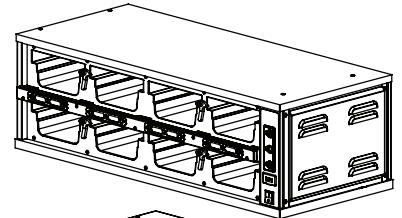
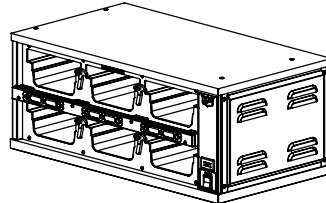
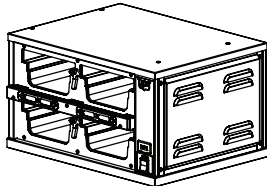
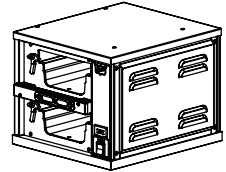
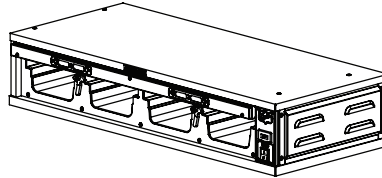
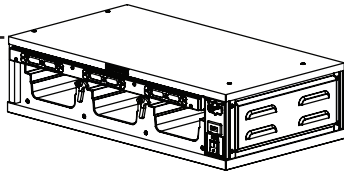

Please read this manual completely before attempting
to install, operate or service this equipment

*This manual is Copyright © 2018 Duke Manufacturing Co. All rights reserved.
Reproduction without written permission is prohibited. Duke is a registered
trademark of the Duke Manufacturing Co.*

Duke Manufacturing Co.

2305 N. Broadway
St. Louis, MO 63102
Phone: 314-231-1130
Toll Free: 1-800-735-3853
Fax: 314-231-5074
www.dukemfg.com

P/N 156237
REV Y 4/20/2018



TABLE OF CONTENTS

ELECTRICAL WARNINGS.....	4
MANUFACTURER’S INTRODUCTION.....	6
SPECIFICATIONS.....	7
Model FWM3-13.....	7
Model FWM3-14.....	8
Model FWM3-21.....	9
Model FWM3-22.....	10
Model FWM3-23.....	11
Model FWM3-24.....	12
Model FWM3-41.....	13
Model FWM3-42.....	14
Model FWM3-51.....	15
INSTALLATION INSTRUCTIONS	16
Stacking Units	17
OPERATION.....	18
OPENING CHECKLIST.....	18
OPERATION INSTRUCTIONS AND ADJUSTMENTS	18
CLOSING CHECKLIST	18
CLEANING INSTRUCTIONS.....	18
STAINLESS STEEL CARE.....	18
KEYPAD PROGRAMMING	19
Power Up.....	19
Timer Operation.....	20
Time Decrement.....	20
Menu Mode	21
WEB PROGRAMMING	22
Creating A New Program.....	22
Revising A Cabinet Setting	25
TROUBLESHOOTING	26
Electronic Control Fault Indications.....	26
Temperature Check Procedure	26
Service Hot-Line	26
PARTS LISTS AND ILLUSTRATIONS	28
WIRING SCHEMATICS.....	32-37
TABLE MOUNTING (5X1).....	38

ELECTRICAL WARNINGS

THIS MANUAL HAS BEEN PREPARED FOR PERSONNEL QUALIFIED TO INSTALL ELECTRICAL EQUIPMENT, WHO SHOULD PERFORM THE INITIAL FIELD STARTUP AND ADJUSTMENTS OF THE EQUIPMENT COVERED BY THIS MANUAL.

READ THIS MANUAL THOROUGHLY BEFORE OPERATING, INSTALLING OR PERFORMING MAINTENANCE ON THE EQUIPMENT.

⚠ WARNING: Failure to follow all the instructions in this manual can cause property damage, injury or death.

⚠ WARNING: Improper installation, adjustment, alteration, service or maintenance can cause property damage, injury or death.

⚠ WARNING: (US/CAN ONLY) Electrical connections should be performed only by a certified professional.

⚠ WARNING: Electrical and grounding connections must comply with the applicable portions of the National Electric Code and/or all local electric codes. Failure to comply with this procedure can cause property damage, injury or death.

⚠ WARNING: Before connecting the unit to the electrical supply, verify that the electrical and grounding connections comply with the applicable portions of the National Electric Code and/or other local electrical codes. Failure to comply with this procedure can cause property damage, injury or death.

⚠ WARNING: Before connecting the unit to the electrical supply, verify that the electrical connection agrees with the specifications on the data plate. Failure to comply with this procedure can cause property damage, injury or death.

⚠ WARNING: UL73 grounding instructions: This appliance must be connected to a grounded, metal, permanent wiring system. Or an equipment-grounding conductor must be run with the circuit conductors and connected to the equipment-grounding terminal or lead on the appliance. Failure to comply with this procedure can cause property damage, injury or death.

⚠ WARNING : Appliances equipped with a flexible electric supply cord, are provided with a three-prong grounding plug. It is imperative that this plug be connected into a properly grounded three-prong receptacle. Failure to comply with this procedure can cause property damage, injury or death.

⚠ WARNING: If the receptacle is not the proper grounding type, contact an electrician. Do not remove the grounding prong from the plug. Failure to comply with this procedure can cause property damage, injury or death.

⚠ WARNING: Before performing any service that involves electrical connection or disconnection and/or exposure to electrical components, always perform the Electrical LOCKOUT/TAGOUT Procedure. Disconnect all circuits. Failure to comply with this procedure can cause property damage, injury or death.

⚠ WARNING: Before removing any sheet metal panels or servicing this equipment, always perform the Electrical LOCKOUT/TAGOUT Procedure. Be sure all circuits are disconnected. Failure to comply with this procedure can cause property damage, injury or death.

⚠ WARNING: Do not operate this equipment without properly placing and securing all covers and access panels. Failure to comply with this procedure can cause property damage, injury or death.

⚠ WARNING: For your safety, do not use or store gasoline or other flammable vapors or liquids in the vicinity of this or any other appliance. Failure to comply can cause property damage, injury or death.

⚠ WARNING: In the event of a power failure, do not attempt to operate this appliance. Failure to comply can cause property damage, injury or death.

⚠ WARNING: This appliance is not intended for use by persons (including children) with reduced physical, sensory or mental capabilities, or lack of experience and knowledge, unless they have been given supervision or instruction concerning use of the appliance by a person responsible for their safety. Children should be supervised to ensure they do not play with the appliance.

⚠ WARNING: It is recommended that children be supervised to ensure that they are not playing with the appliance.

⚠ WARNING: If the power cord is damaged, it must be replaced by the manufacturer or authorized agent or qualified person in order to avoid a hazard.

CAUTION

Observe the following:

- Minimum clearances must be maintained from all walls and combustible materials.
- Keep the equipment area free and clear of combustible material.
- Maintain adequate clearance for air openings.
- Operate equipment only on the type of electricity indicated on the data sticker.
- Retain this manual for future reference.

MANUFACTURER'S INTRODUCTION

The Duke Product Holding Unit was developed for extended food-holding capabilities to provide consistently high, "just cooked" food quality.

The Duke Product Holding Unit utilizes Duke's patented "heat sink" holding technology that provides even heat distribution to food pans through the bottom and sides. This allows pre-cooked foods to be held for extended periods without noticeable degradation of quality, reducing food scrap/waste.

The self contained, individually formed, sealed compartments of the Duke Product Holding Unit eliminates food odor and taste transfer. Because the compartments are sealed and formed to the shape of the pan, no disassembly is required for cleaning and product changes.

The unique design of the Duke Product Holding Unit allows single temperature operation for all existing product groups. This 180°F(82°C) approved temperature is preset at the factory. This reduces the likelihood of inconsistent performance between restaurant locations.

The Duke Product Holding Cabinet was also designed to rethermalize food product. A thermostat setting of 180°F(82°C) minimum is required for re-thermalization. To comply with sanitation requirements do not set the temperature control lower than 180°F(82°C) or equivalent.

NOTICE: Only qualified service persons should modify control temperature presets.





SERIAL NUMBER LOCATION

The Serial Number Data Label is located on the rear of the unit, above the power cord connection. Refer to the Serial Number Data Label for proper electrical requirements. The serial number and model number are required when communicating with the Duke Service Department.

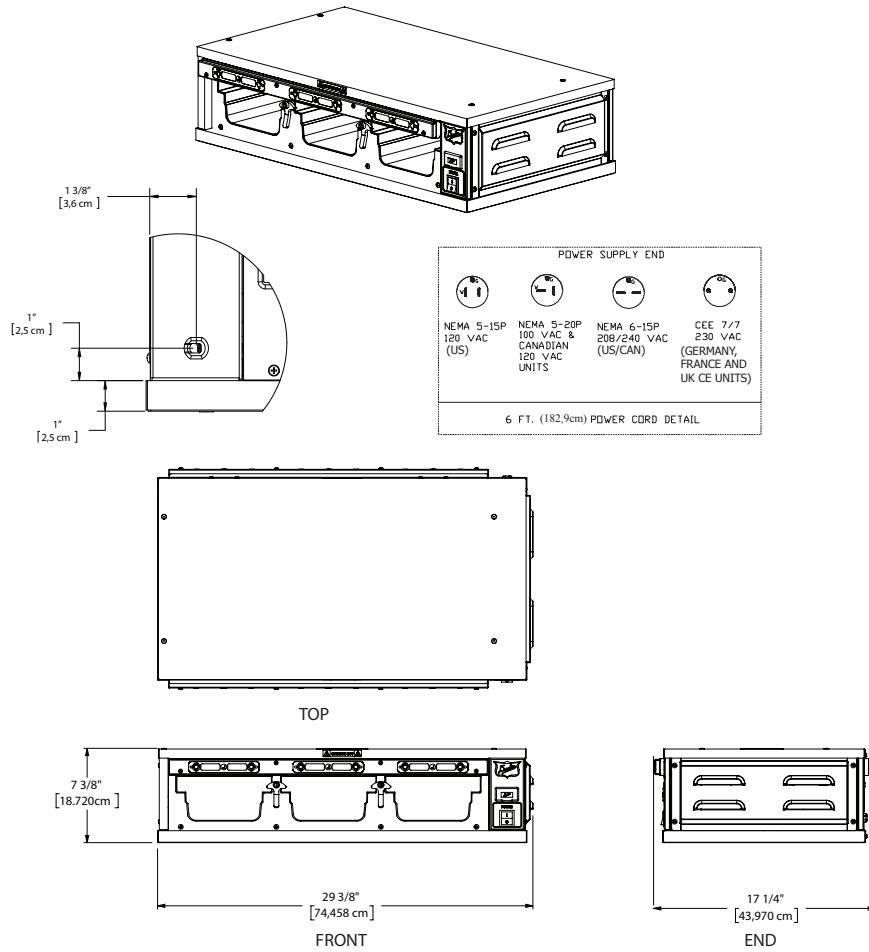
SPECIFICATIONS





MODEL FWM3-13					
MODEL	SHIPPING WEIGHT	AC Voltage (V)	Watts (W)	Amps (A)	FREQUENCY (Hz)
FWM3-13-100	75 lbs (34,1Kg)	100	600	6.0 (6,0)	60
FWM3-13-120	75 lbs (34,1Kg)	120	600	5.0 (5,0)	60
FWM3-13-208	75 lbs (34,1Kg)	208	900	4.0 (4,0)	60
FWM3-13-230	75 lbs (34,1Kg)	230	900	4.0 (4,0)	50
FWM3-13-240	75 lbs (34,1Kg)	240	900	4.0 (4,0)	60

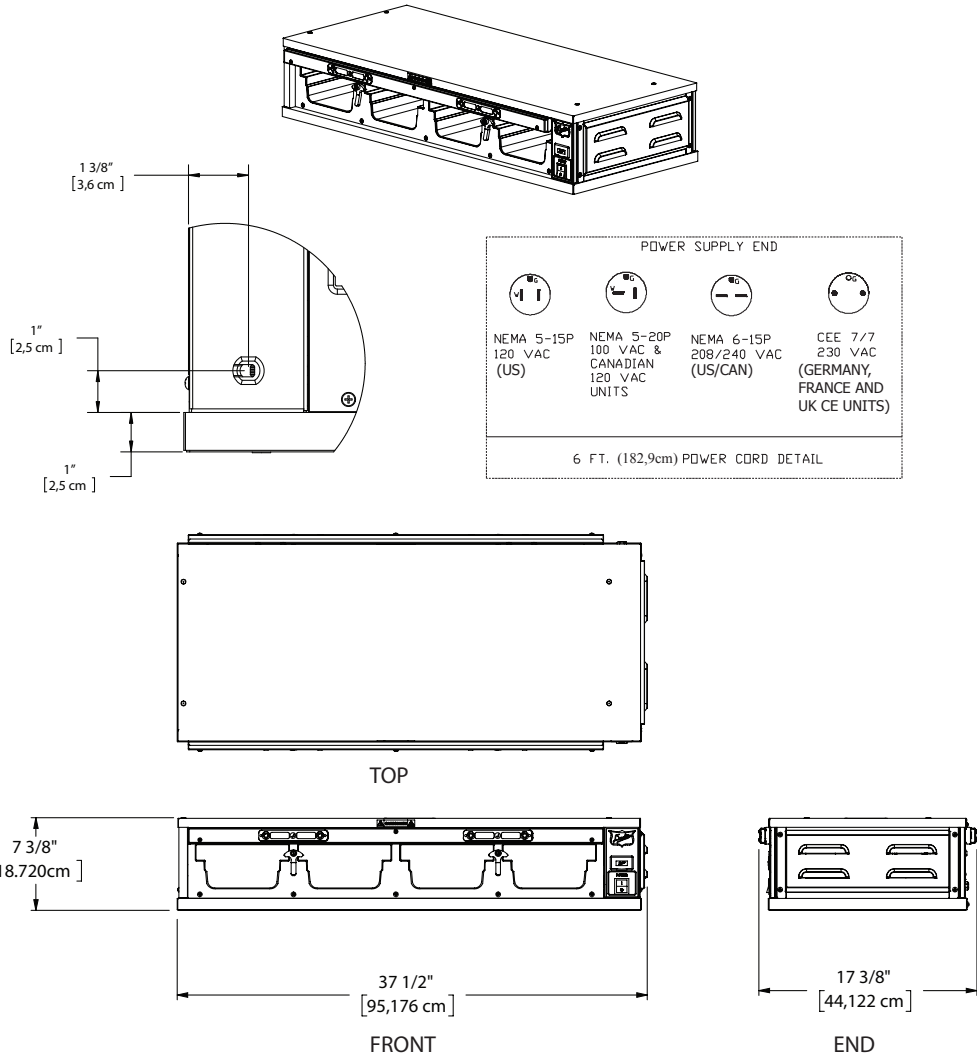

Compliance Declaration		
	Standard: UL197	File: KNGT.E17421
	Standard: CSA-C22.2 No. 109	File: KNGT7.E17421
	Standard: ANSI / NSF 4	File: TSQT.E157479
	Directive 2014/35/EU: EN60335 -1:2002, A1, A2, A11, A12 EN 60335-2-49:2003	Directive 89/336/EEC and 2014/30/EU: EN61000-3-2 EN 55014-1 EN61000-3-3 EN55014-2
	WEEE RoHS Directive 2002/96/EC	

MODEL FWM3-14					
MODEL	SHIPPING WEIGHT	AC Voltage (V)	Watts (W)	Amps (A)	FREQUENCY (Hz)
FWM3-14-100	111 lbs (50,5Kg)	100	800	8.0 (8,0)	60
FWM3-14-120	111 lbs (50,5Kg)	120	800	7.0 (7,0)	60
FWM3-14-208	111 lbs (50,5Kg)	208	1200	6.0 (6,0)	60
FWM3-14-230	111 lbs (50,5Kg)	230	1200	5.0 (5,0)	50
FWM3-14-240	111 lbs (50,5Kg)	240	1200 </td <td>5.0 (5,0)</td> <td>60</td>	5.0 (5,0)	60



Compliance Declaration		
	Standard: UL197	File: KNGT.E17421
	Standard: CSA-C22.2 No. 109	File: KNGT7.E17421
	Standard: ANSI / NSF 4	File: TSQT.E157479
	Directive 2014/35/EU: EN60335 -1:2002, A1, A2, A11, A12 EN 60335-2-49:2003	Directive 89/336/EEC and 2014/30/EU: EN61000-3-2 EN 55014-1 EN61000-3-3 EN55014-2
	WEEE RoHS Directive 2002/96/EC	

MODEL FWM3-21					
MODEL	SHIPPING WEIGHT	AC Voltage (V)	Watts (W)	Amps (A)	FREQUENCY (Hz)
FWM3-21-100	67 lbs (30,5Kg)	100	400	4.0 (4,0)	60
FWM3-21-120	67 lbs (30,5Kg)	120	400	4.0 (4,0)	60
FWM3-21-208	67 lbs (30,5Kg)	208	600	3.0 (3,0)	60
FWM3-21-230	67 lbs (30,5Kg)	230	600	3.0 (3,0)	50
FWM3-21-240	67 lbs (30,5Kg)	240	600	3.0 (3,0)	60

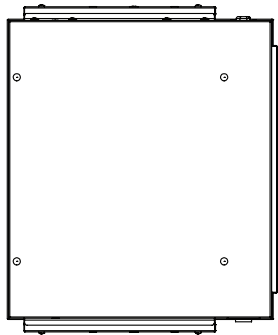
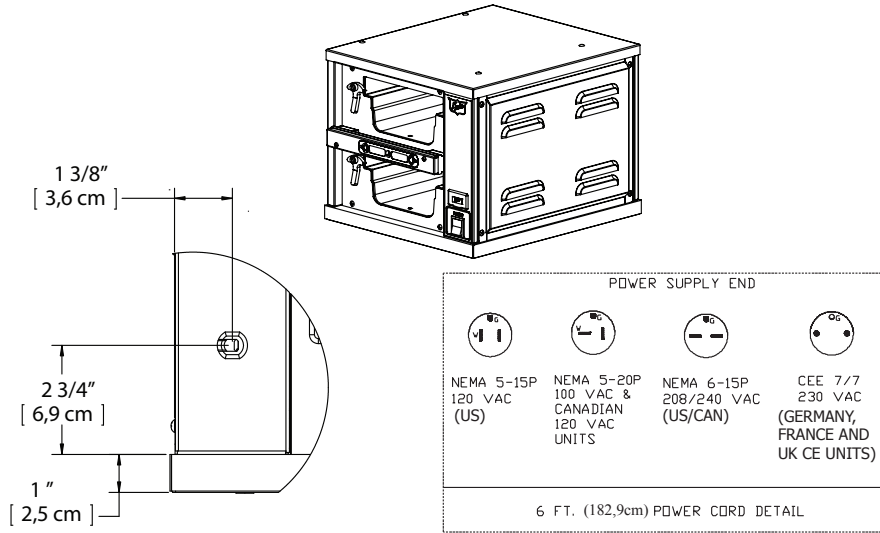



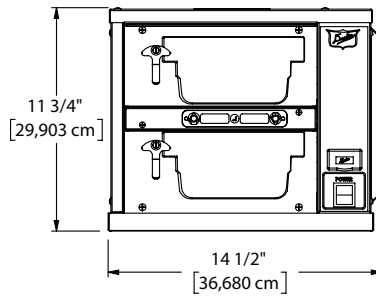

TOP

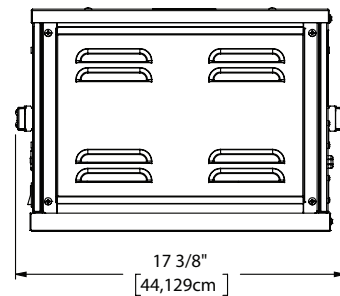

FRONT



END

Compliance Declaration		
	Standard: UL197	File: KNGT.E17421
	Standard: CSA-C22.2 No. 109	File: KNGT7.E17421
	Standard: ANSI / NSF 4	File: TSQT.E157479
	Directive 2014/35/EU: EN60335 -1:2002, A1, A2, A11, A12 EN 60335-2-49:2003	Directive 89/336/EEC and 2014/30/EU: EN61000-3-2 EN 55014-1 EN61000-3-3 EN55014-2
	WEEE RoHS Directive 2002/96/EC	

MODEL FWM3-22					
MODEL	SHIPPING WEIGHT	AC Voltage (V)	Watts (W)	Amps (A)	FREQUENCY (Hz)
FWM3-22-100	91 lbs (41,4Kg)	100	800	8.0 (8,0)	60
FWM3-22-120	91 lbs (41,4Kg)	120	800	7.0 (7,0)	60
FWM3-22-208	91 lbs (41,4Kg)	208	1200	6.0 (6,0)	60
FWM3-22-230	91 lbs (41,4Kg)	230	1200	5.0 (5,0)	50
FWM3-22-240	91 lbs (41,4Kg)	240	1200	5.0 (5,0)	60

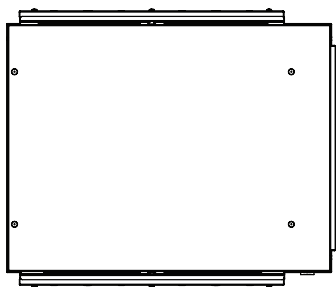
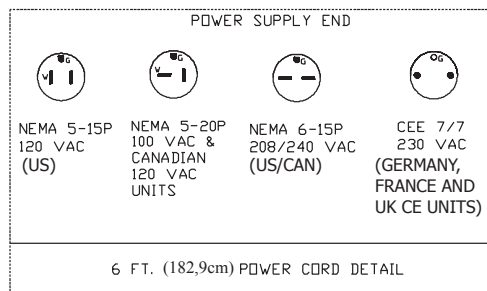
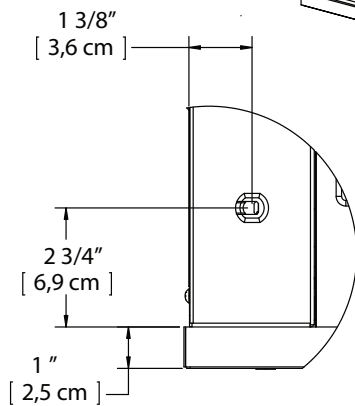
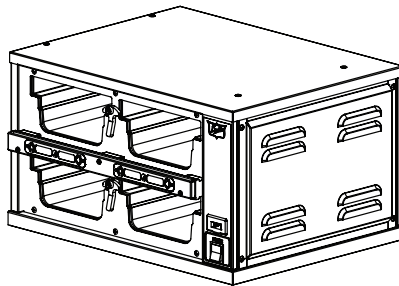



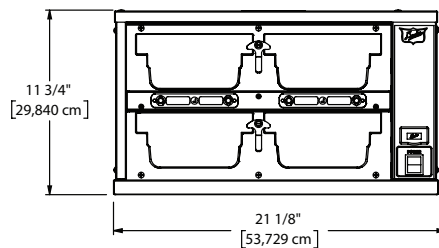

TOP

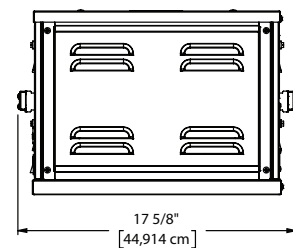

FRONT



END

Compliance Declaration		
 LISTED COMMERCIAL COOKING APPLIANCE	Standard: UL197	File: KNGT.E17421
 INDEXER COMMERCIAL APPAREIL DE CUISINE	Standard: CSA-C22.2 No. 109	File: KNGT7.E17421
	Standard: ANSI / NSF 4	File: TSQT.E157479
	Directive 2014/35/EU: EN60335 -1:2002, A1, A2, A11, A12 EN 60335-2-49:2003	Directive 89/336/EEC and 2014/30/EU: EN61000-3-2 EN 55014-1 EN61000-3-3 EN55014-2
	WEEE RoHS Directive 2002/96/EC	

MODEL FWM3-23					
MODEL	SHIPPING WEIGHT	AC Voltage (V)	Watts (W)	Amps (A)	FREQUENCY (Hz)
FWM3-23-100	113 lbs (51,4Kg)	100	1200	12.0 (12,0)	60
FWM3-23-120	113 lbs (51,4Kg)	120	1200	10.0 (10,0)	60
FWM3-23-208	113 lbs (51,4Kg)	208	1800	9.0 (9,0)	60
FWM3-23-230	113 lbs (51,4Kg)	230	1800	8.0 (8,0)	50
FWM3-23-240	113 lbs (51,4Kg)	240	1800	8.0 (8,0)	60

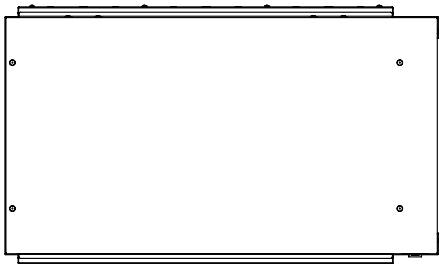
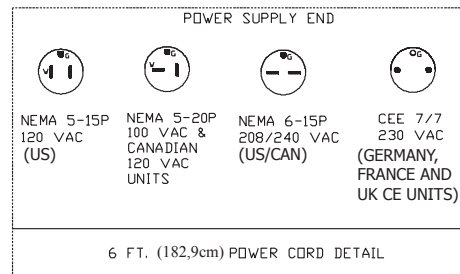
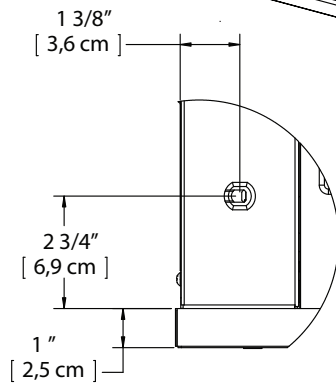
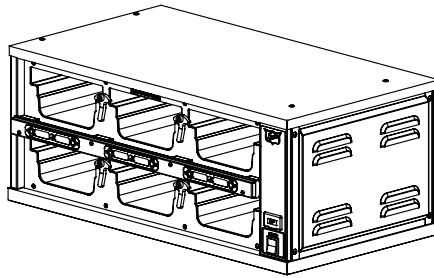



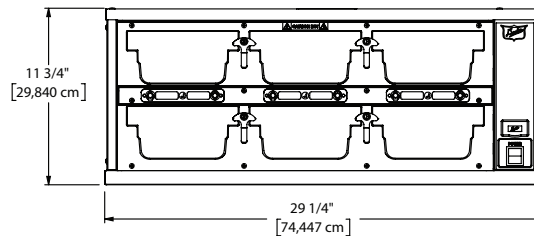

TOP

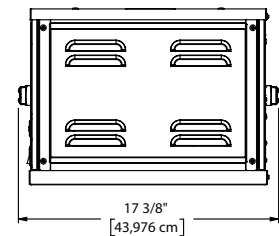

FRONT





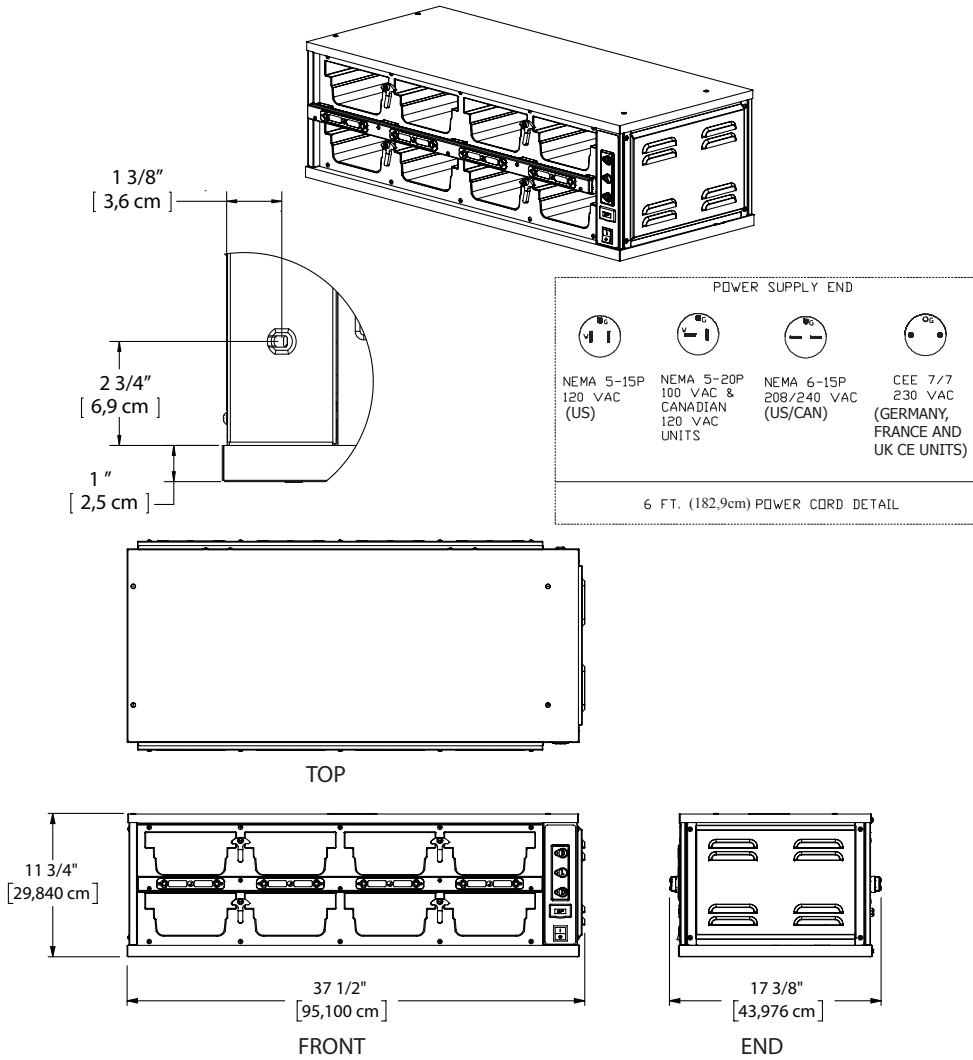

END

Compliance Declaration		
	Standard: UL197	File: KNGT.E17421
	Standard: CSA-C22.2 No. 109	File: KNGT7.E17421
	Standard: ANSI / NSF 4	File: TSQT.E157479
	Directive 2014/35/EU: EN60335 -1:2002, A1, A2, A11, A12 EN 60335-2-49:2003	Directive 89/336/EEC and 2014/30/EU: EN61000-3-2 EN 55014-1 EN61000-3-3 EN55014-2
	WEEE RoHS Directive 2002/96/EC	

MODEL FWM3-24					
MODEL	SHIPPING WEIGHT	AC Voltage (V)	Watts (W)	Amps (A)	FREQUENCY (Hz)
FWM3-24-100	141 lbs (69,1Kg)	100	1600	16.0 (16,0)	60
FWM3-24-120	141 lbs (69,1Kg)	120	1600	13.0 (13,0)	60
FWM3-24-208	141 lbs (69,1Kg)	208	2400	12.0 (12,0)	60
FWM3-24-230	141 lbs (69,1Kg)	230	2400	10.0 (10,0)	50
FWM3-24-240	141 lbs (69,1Kg)	240	2400	10.0 (10,0)	60



Compliance Declaration		
	Standard: UL197	File: KNGTE17421
	Standard: CSA-C22.2 No. 109	File: KNGT7.E17421
	Standard: ANSI / NSF 4	File: TSQTE157479
	Directive 2014/35/EU: EN60335 -1:2002, A1, A2, A11, A12 EN 60335-2-49:2003	Directive 89/336/EEC and 2014/30/EU: EN61000-3-2 EN 55014-1 EN61000-3-3 EN55014-2
	WEEE RoHS Directive 2002/96/EC	



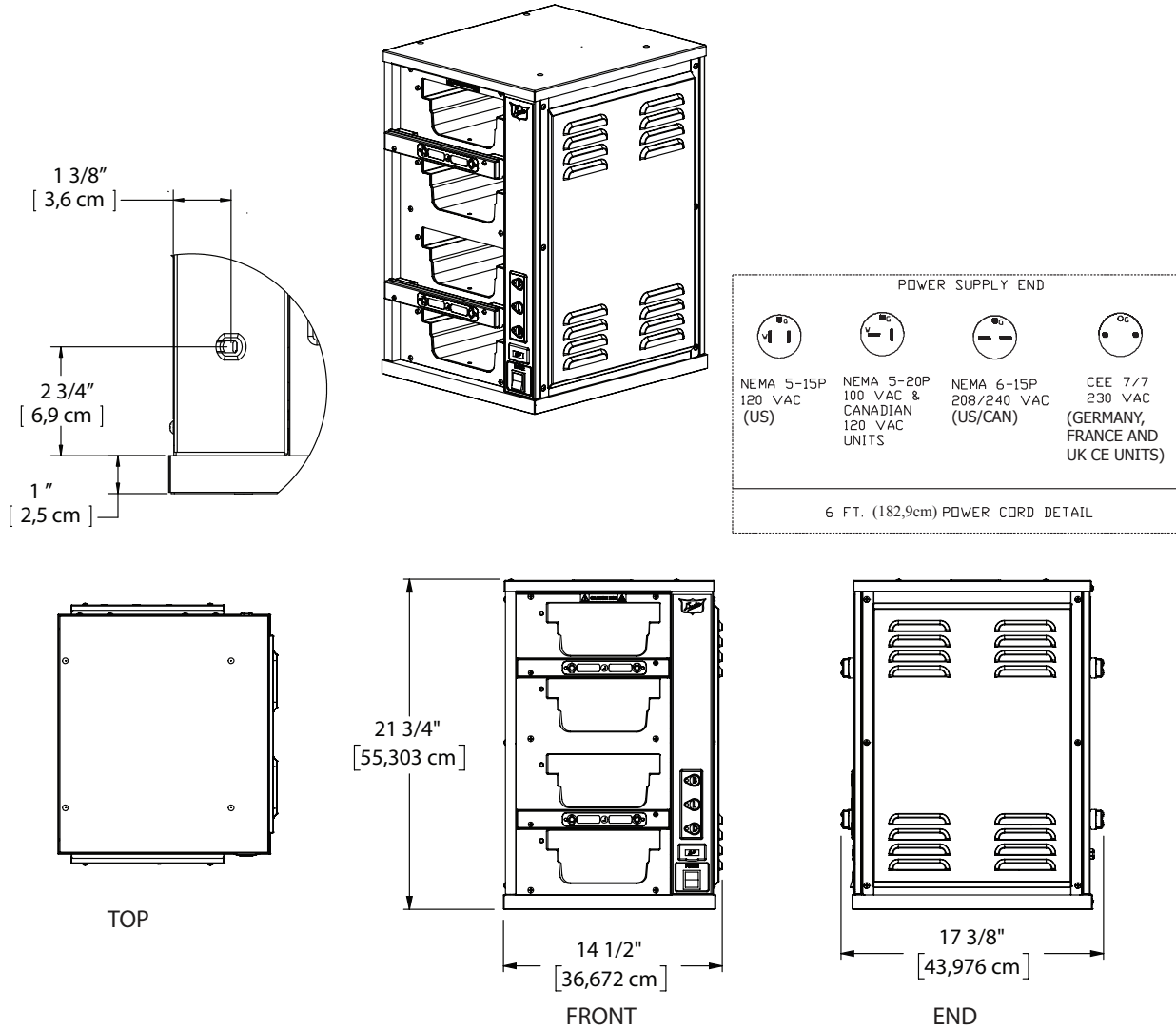

MODEL FWM3-41					
MODEL	SHIPPING WEIGHT	AC Voltage (V)	Watts (W)	Amps (A)	FREQUENCY (Hz)
FWM3-41-100	100 lbs (45Kg)	100	800	8.0 (8,0)	60
FWM3-41-120	100 lbs (45Kg)	120	800	7.0 (7,0)	60
FWM3-41-208	100 lbs (45Kg)	208	1200	6.0 (6,0)	60
FWM3-41-230	100 lbs (45Kg)	230	1200	5.0 (5,0)	50
FWM3-41-240	100 lbs (45Kg)	240	1200	5.0 (5,0)	60

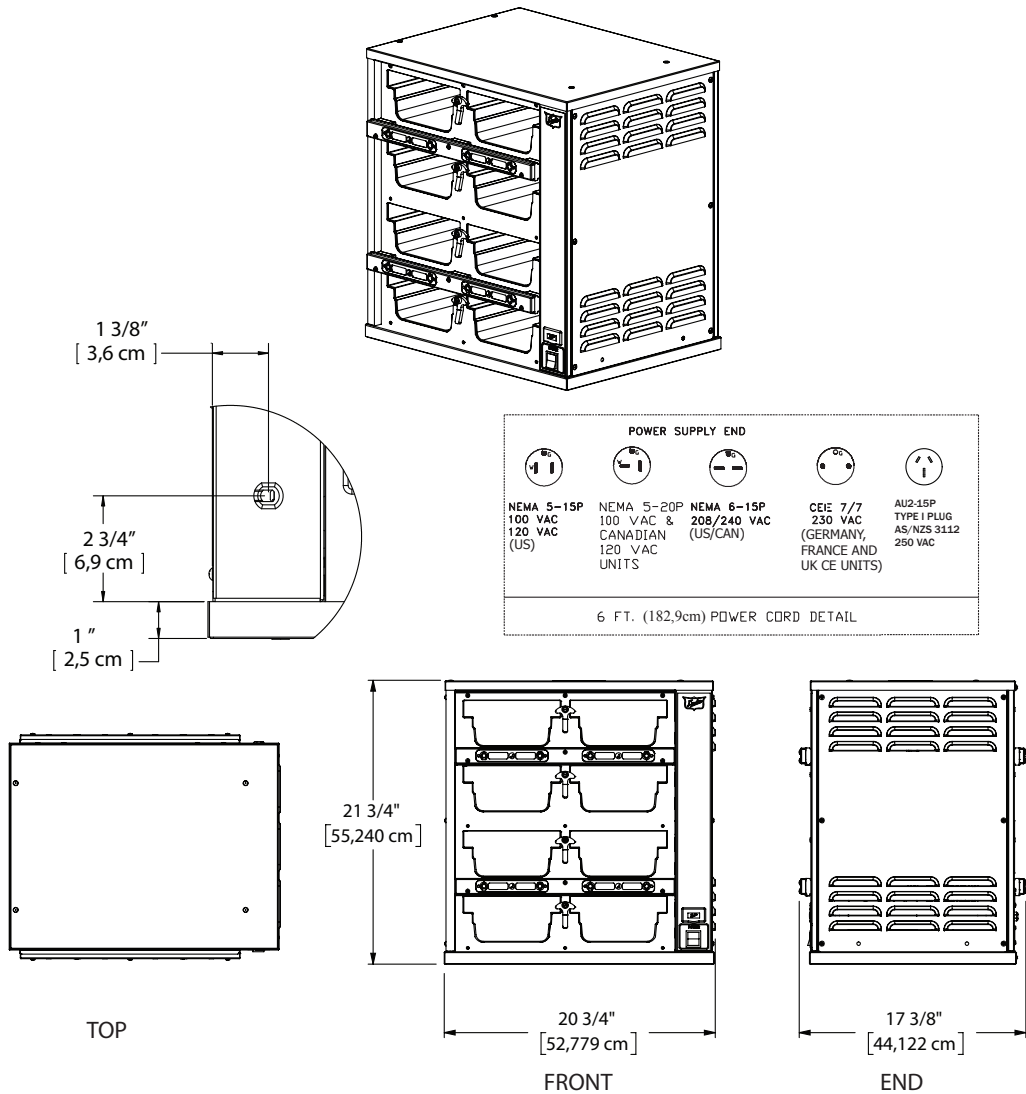

Compliance Declaration		
	Standard: UL197	File: KNGT.E17421
	Standard: CSA-C22.2 No. 109	File: KNGT7.E17421
	Standard: ANSI / NSF 4	File: TSQT.E157479
	Directive 2014/35/EU: EN60335 -1:2002, A1, A2, A11, A12 EN 60335-2-49:2003	Directive 89/336/EEC and 2014/30/EU: EN61000-3-2 EN 55014-1 EN61000-3-3 EN55014-2
	WEEE RoHS Directive 2002/96/EC	





MODEL FWM3-42					
MODEL	SHIPPING WEIGHT	AC Voltage (V)	Watts (W)	Amps (A)	FREQUENCY (Hz)
FWM3-42-100	145 lbs (65,8Kg)	100	1600	16.0 (16,0)	60
FWM3-42-120	145 lbs (65,8Kg)	120	1600	13.0 (13,0)	60
FWM3-42-208	145 lbs (65,8Kg)	208	2400	12.0 (12,0)	60
FWM3-42-230	145 lbs (65,8Kg)	230	2400	10.0 (10,0)	50
FWM3-42-240	145 lbs (65,8Kg)	240	2400	10.0 (10,0)	60

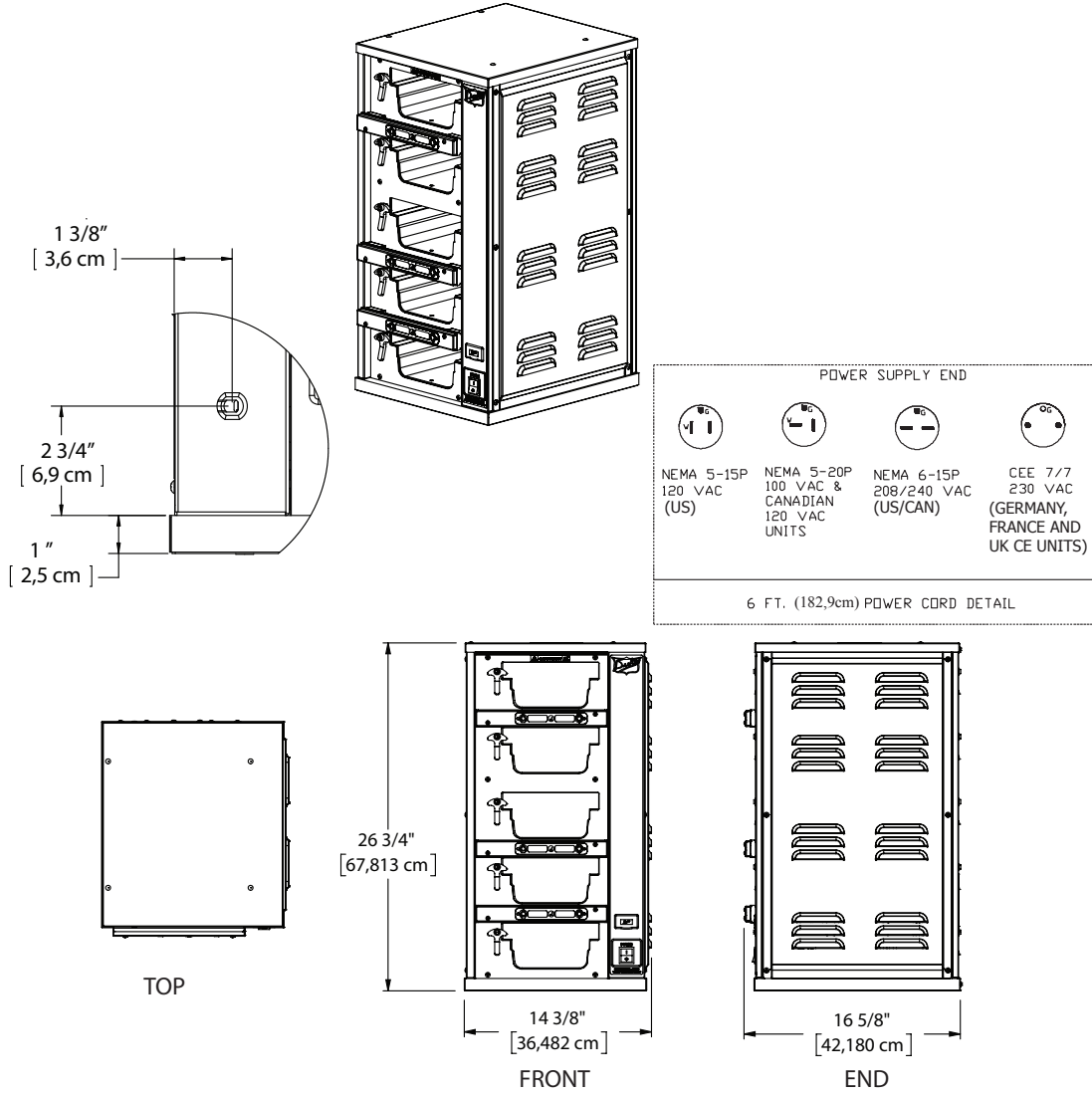

Compliance Declaration		
	Standard: UL197	File: KNQT.E17421
	Standard: CSA-C22.2 No. 109	File: KNQT7.E17421
	Standard: ANSI / NSF 4	File: TSQT.E157479
	Directive 2014/35/EU: EN60335 -1:2002, A1, A2, A11, A12 EN 60335-2-49:2003	Directive 89/336/EEC and 2014/30/EU: EN61000-3-2 EN 55014-1 EN61000-3-3 EN55014-2
	WEEE RoHS Directive 2002/96/EC	

MODEL FWM3-51					
MODEL	SHIPPING WEIGHT	AC Voltage (V)	Watts (W)	Amps (A)	FREQUENCY (Hz)
FWM3-51-100	125 lbs (56,8Kg)	100	1000	10.0 (10,0)	60
FWM3-51-120	125 lbs (56,8Kg)	120	1000	8.0 (8,0)	60
FWM3-51-208	125 lbs (56,8Kg)	208	1500	7.0 (7,0)	60
FWM3-51-230	125 lbs (56,8Kg)	230	1500	7.0 (7,0)	50
FWM3-51-240	125 lbs (56,8Kg)	240	1500	6.0 (6,0)	60



Compliance Declaration		
	Standard: UL197	File: KNGTE17421
	Standard: CSA-C22.2 No. 109	File: KNGT7.E17421
	Standard: ANSI / NSF 4	File: TSQTE157479
	Directive 2014/35/EU: EN60335 -1:2002, A1, A2, A11, A12 EN 60335-2-49:2003	Directive 89/336/EEC and 2014/30/EU: EN61000-3-2 EN 55014-1 EN61000-3-3 EN55014-2
	WEEE RoHS Directive 2002/96/EC	

INSTALLATION INSTRUCTIONS

UNPACKING UNIT

1. Inspect the shipping carton and/or container, carefully noting any exterior damage on the delivery receipt.
2. Contact the carrier immediately and file a damage claim with them. Save all packing materials when filing a claim. Freight damage claims are the responsibility of the purchaser and are not covered by the warranty.
3. Unpack and Inspect the unit for damage.
4. Report any dents or breakage to the source of purchase immediately.

CAUTION: Do not attempt to use unit if damaged.

5. Remove all materials from the unit interior.
6. If the unit has been stored in extremely cold area, wait a few hours before connecting the power.

INSTALLATION CODES AND STANDARDS

In the United States, the PHU must be installed in accordance with the following:

1. State and local codes.
2. National Electrical Code (ANSI/NFPA No. 70, latest edition) available from the National Fire Protection Association, Batterymarch Park, Quincy, MA 02269.
3. Vapor Removal from Cooking Equipment, (NFPA-96, latest edition) available from NFPA.

In Canada, the PHU must be installed in accordance with the following:

1. Local codes.
2. Canadian Electrical Code (CSAC 22.2 No. 3, latest edition) available from the Canadian Standards Association, 5060 Spectrum Way, Mississauga, Ontario, Canada L4W 5N6.

For CE Units, the PHU must be installed in accordance with the following:

1. Local codes.
2. European (IEC/CENELEC) Electrical Code

UNIT PLACEMENT

- Do not install the unit next to or above heat sources, such as oven or deep fat fryer.

- Install the unit on a level countertop surface.
- The power outlet should be located so that plug is accessible when the unit is in place.
- The FWM is designed for access from either side.
- Operate the unit according to the Operation Instructions provided in this manual.

Clearance Requirements

CLEARANCE REQUIREMENT	CLEARANCE IN INCHES
Top	0
Right Side	1
Left Side	1
Bottom	0
Rear	OPEN

- Proper airflow around the unit cools its electrical components. With restricted airflow, the unit may not operate properly and life of the electrical parts is reduced.

⚠ WARNING: To avoid risk of electrical shock or death, this unit must be grounded and plug must not be altered.

⚠ WARNING: Before connecting the unit to the electrical supply, verify that the electrical connection agrees with the specifications on the data plate. Failure to comply with this procedure can cause property damage, injury or death.

EARTHING INSTRUCTIONS

THE UNIT MUST BE GROUNDED. Grounding reduces risk of electric shock by providing an escape wire for the electric current if an electrical short occurs. This unit is equipped with a cord having a grounding wire with a grounding plug. The plug must be plugged into a receptacle that is properly installed and grounded.

Consult a qualified electrician or service agent if grounding instructions are not completely understood, or if doubt exists as to whether the oven is properly grounded.

DO NOT USE AN EXTENSION CORD. If the product power cord is too short, have a qualified electrician install a three-slot receptacle (or the country specific receptacle for International Units). This unit should be plugged into a separate circuit with the electrical rating as provided on the product data plate.

EXTERNAL EQUIPOTENTIAL BONDING TERMINAL (EXPORT ONLY)

This equipment has supplemental bonding terminal. The terminal provides an external bonding connection used in addition to the earthing prong on the plug. The terminal provides a connection for bonding to the equipment enclosure. The external equipotential bonding terminal is located on the rear outside surface of the oven, the terminal is marked with this symbol.



NOTICE: If the supply cord is damaged, it must be replaced by a special cord assembly available from Duke Manufacturing Co. or its service agent.

NOTICE: Refer to the specifications data plate when ordering or replacing a cord set.

STACKING UNITS

WARNING: TIP HAZARD! Do not stack any units over 2 pans high.

WARNING: TIP HAZARD! Do not exceed two holding cabinets per stack.

WARNING: Do not place holding cabinet stacks on surfaces that may easily tip over.

The FWM3-24 Product Holding Cabinet is designed to allow limited stacking capabilities. Use these procedures to stack FWM3-24 models.

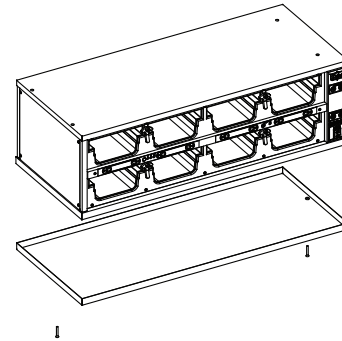

Figure 1: Removal of Base Pan

1. Remove the Base Pan from all FWM3-24s to stacked, except the bottom unit. The pan is held in place by two screws on the bottom of each unit.

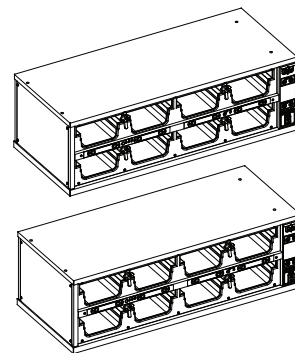

Figure 2: Placement of Bottom Unit

2. Place bottom unit into its final position then stack the next unit on top. The top of the lower holding cabinet rests inside of the base of the upper unit.

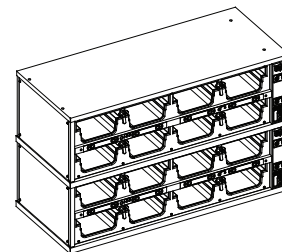
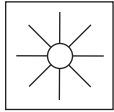

Figure 3: FWM3-24 In Stacked Arrangement

OPERATION

The following procedures must be performed on a daily basis.



OPENING CHECKLIST

1. Ensure proper Pan Covers are inserted into the correct locations for fried and broiled products.
2. Place the Power Switch, located on the front of the Product Holding Unit, in the ON position.
3. Allow the Product Holding Cabinet to heat for at least 20 min. or until the temperature disappears and the menu bars display the pre-programmed product names: "EGGS", "FISH", "----" or "EMPTY" (no product).

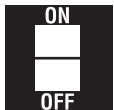

OPERATION INSTRUCTIONS AND ADJUSTMENTS

1. If the menu bars display temperature at any time during operation of the Product Holding Cabinet, discontinue use of the affected shelf until the cabinet is serviced.
2. Refer to the **KEYPAD PROGRAMMING** section of the manual for instructions on using and programming the keypad.



CLOSING CHECKLIST

1. Place the Power Switch in its OFF position.
2. Remove all pans and pan covers.
3. Allow the cabinet to cool for approximately 30 minutes.
4. Refer to the **CLEANING INSTRUCTIONS** section of the manual for proper care and cleaning of the cabinet.

⚠ WARNING: Electrical Shock Hazard, unplug the cabinet before cleaning it.

⚠ WARNING: Do not wash with water jet or hose.

⚠ WARNING: Bottom and sides of warmer wells are very hot and cool slowly.

CAUTION: Do not use caustic cleaners, acids, ammonia products or abrasive cleaners or abrasive cloths. These can damage the stainless steel and plastic surfaces.



CLEANING INSTRUCTIONS

1. Wipe down the interior and exterior of the Product Holding Cabinet with warm water and mild detergent using a soft cloth. Do not use excessive amounts of water.
2. Clean pans and pan covers using mild detergent and warm water.
3. Ensure all soap is rinsed from plastic pans and pan covers.

STAINLESS STEEL CARE

Cleaning

Stainless steel contains 70-80% iron, which will rust if not properly maintained. It also contains 12-30% chromium, which forms an invisible passive, protective film that shields against corrosion. If the film remains intact, the stainless steel will remain intact. However, if the film is damaged, the stainless steel can break down and rust. To prevent stainless steel breakdown, follow these steps:

CAUTION: Never use any metal tools. Scrapers, files, wire brushes or scouring pads (except for stainless steel scouring pads) will mar the surface.

CAUTION: Never use steel wool, which will leave behind particles that rust.

CAUTION: Never use acid-based or chloride-containing cleaning solutions, which will break down the protective film.

CAUTION: Never rub in a circular motion.

CAUTION: Never leave any food products or

salt on the surface. Many foods are acidic. Salt contains chloride.

For routine cleaning, use warm water, mild soap or detergent and a sponge or soft cloth.

For heavy-duty cleaning, use warm water, a degreaser and a plastic, stainless steel or Scotch-Brite pad.

Always rinse thoroughly. Always rub gently in the direction of the steel grain.

Preserving & Restoring

Special stainless steel polishing cleaners can preserve and restore the protective film.

Preserve the life of stainless steel with a regular application of a high quality stainless steel polishing cleaner as a final step to daily cleaning.

If signs of breakdown appear, restore the stainless steel surface. First, thoroughly clean, rinse and dry the surface. Then, on a daily basis, apply a high-quality stainless steel polish according to manufacturer's instructions.

Heat Tint

Darkened areas, called heat tint, may appear on stainless steel exposed to excessive heat, which causes the protective film to thicken. It is unsightly but is not a sign of permanent damage.

To remove heat tint, follow the routine cleaning procedure. Stubborn heat tint will require heavy-duty cleaning.

To reduce heat tint, limit the exposure of equipment to excessive heat.

KEYPAD MENU OPTIONS

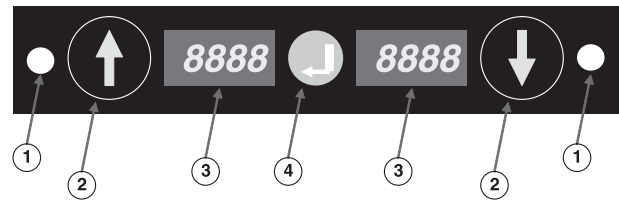

1. Status LEDs: Used for indicating status of pan.
 - a. Non-Illuminated
 - I. Timer is Inactive - no product in pan, OR
 - II. Timer is Active - product in pan – use pan with GREEN STATUS LED first.
 - b. Green = Timer is Active - product in pan (use first)
 - c. Flashing Green = Cook Warning Time reached (cook more product) or keyboard in EDIT MODE (programming).
2. Arrow Buttons
 - a. Used for Starting/Stopping/Resetting Timer.
 - b. Used for Programming.
 - c. Indicate which pan the adjacent Status LED and Pan Display are linked to (i.e. Status LED and Pan Display on left side of keyboard are linked to the pan above the keyboard and the Status LED and Pan Display on right side of keyboard are linked to the pan below).
3. Pan Display
 - a. Displays Product Name and Hold Time Remaining (alternates between the two when Timer is active).
4. Enter Button
 - a. Used for Time Decrement and Programming.

Power Up

1. Place the Power Switch in the ON position. Software initializes at startup.



- Until warmer reaches preprogrammed operating temperature, all displays will show actual temperature.



- When the set point is reached, Product Name appears on all Pan Displays.



Note: For these instructions only the pertinent keypads will be shown, for simplicity, and not the warmer or pans. It is implied that a product pan is located above and below each keypad.

Timer Operation

- Press Arrow Button that corresponds to pan the product is in. (In this example, there is product in pan above keypad).



- Status LED turns GREEN (unless same product present in another pan, then Status LED will remain non-illuminated) and Pan Display alternately shows Time Remaining and Product Name.



- At t=cook time (set to 4 minutes) the Status LED begins FLASHING, alarm sounds and Display alternately flashes Time Remaining and Product Name.



- Push Arrow Button to silence alarm – Status LED remains GREEN and stops flashing.



- At t=0, alarm sounds, Status LED is FLASHING and “00:00” is FLASHING in the Display. **Discard product in pan.** Press corresponding Arrow Button to silence alarm and reset timer.



- Status LED becomes non-illuminated and Display shows Product Name only. The pan is ready for more product.



Note: To reset the time when product is depleted, press and release the corresponding arrow key. The status LED will become non-illuminated any status LED on the same product will turn green, indicating use first.

Time Decrement

This program is used to alter Hold Time when introducing a product from another warming unit.

Example: Transfer CORN from another warmer with 19 minutes left on Hold Time.

- Press and hold the Arrow Button corresponding to the pan that’s being edited for three seconds. The display will appear as shown below with a FLASHING Status LED and a down arrow in the Display indicating the timer is in decrement mode.



“V” denotes timer is in decrement mode

- Repeatedly pressing the Arrow Button decrements time by one minute per depression.
- Holding down the button continuously will count the time down.
- To increment time, press the Enter Button. The arrow on display will point up to denote incrementing time as shown below.
- Repeatedly pressing the Arrow Button increments time by one minute per depression.

- Holding down the button continuously will speed the time up.



“^” denotes timer is in increment mode

- When the proper time is reached on the Display release the Arrow Button and after 5 seconds unit will accept new time and return to normal operation.

Menu Mode

This option is used to change Meal Set and view, Linking, Hold Time and Hold Temp.

Enter Menu Mode

- Press and hold the Enter Button for three seconds. Status LED FLASHES GREEN and “MENU” is displayed on left Display and “UP” is displayed on right, indicating upper well information will be displayed.
- To view lower well information press the Down Arrow Button – “DOWN” will appear in the right Display. FLASHING Status LED will be present on side of keypad corresponding to well being viewed.
- Press the Enter Button to accept.



Change Meal Set

Note: The Meal Set can be changed globally from any keyboard.

- Status LED stops flashing and “MEAL” “SET1” appears on the Display.



- Press the Enter Button again. Status LED FLASHES indicating edit mode.
- Use the Arrow Buttons to scroll to desired Meal Set and press the Enter Button to accept. Status LED

stops flashing and desired Meal Set is displayed.



Display Link, Hold Time & Temperature

Press Arrow Button repeatedly to scroll through Link, Time and Temperature settings.



Exit Menu Mode

Scroll to EXIT and press the Enter Button to exit menu mode.



NOTE: To comply with sanitation requirements do not set the temperature control lower than 180°F or equivalent.

DAYPART PROGRAMMING (OPTION)



PUSH BUTTONS TO CHANGE DAYPART MENU - CORRESPONDING LED WILL TURN ON (BREAKFAST SHOWN)

WEB PROGRAMMING

CREATING A NEW MENU

Open Internet Explorer web browser.

Type or paste the website address into the browser address dialog box and press Enter.

If your customer website has NOT been set up, please contact Duke Manufacturing's TECHNICAL SERVICE DEPARTMENT at 800-735-3853

Log into DukePHUwebsite
www.dukemfg.info/*****
Unique address & password is supplied at purchase. If needed, contact TECHNICAL SERVICE DEPARTMENT

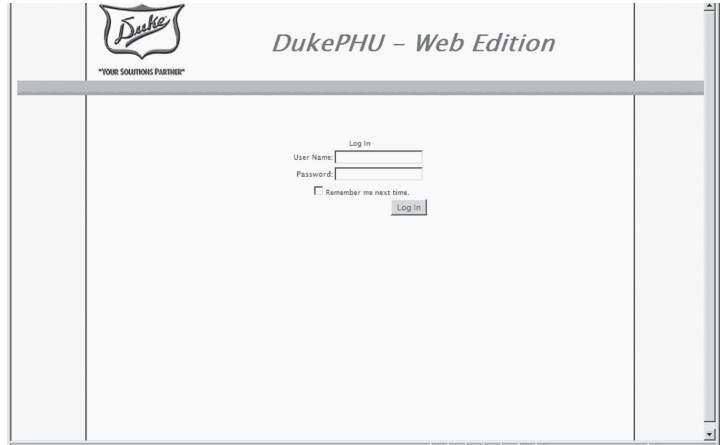

Type the assigned User Name.
Type the password.

Click the Log In button.

Click on Product Manager tab

Select product and verify cook parameters are correct for all recipes.

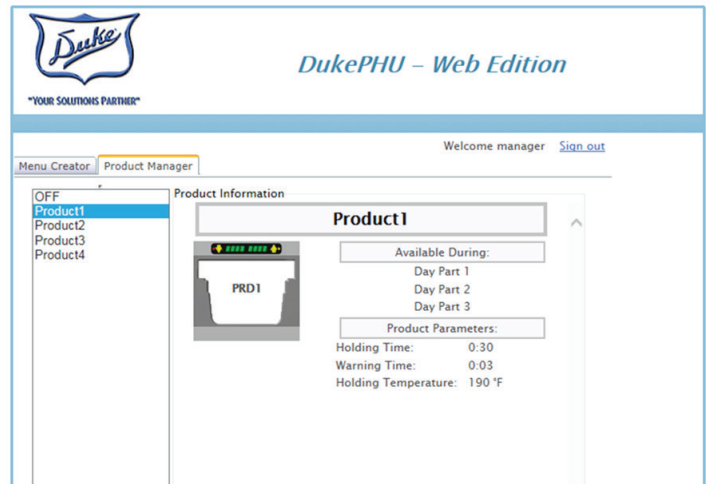

Cabinets are configured using the Menu Creator tab.

Select the unit configuration that will be programmed.

Use scroll bar to find additional configurations.

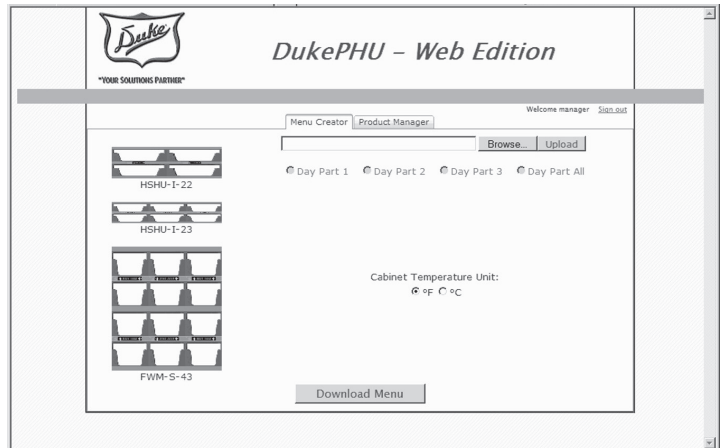

NOTE: You must program all 3 day parts EACH TIME a program is created.

Select the day part to be programmed. If only one day part is required or if you wish for all dayparts to be the same, select Day Part All.

Select the Cabinet Temperature Units F° or C°.

Place the cursor over the well to be programmed and click to display the list of choices.

Scroll through the drop down list and click the item to be programmed.

Click on **NONE** for each remaining well and select desired menu item from dropdown list.

Repeat for Daypart 2 and 3

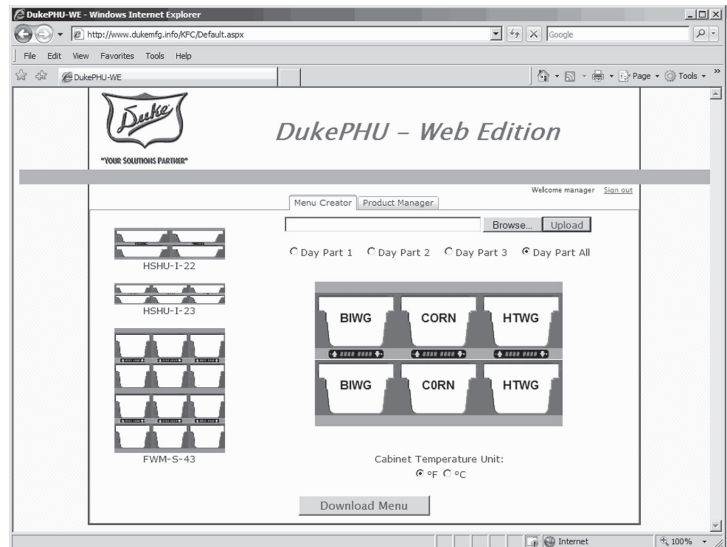
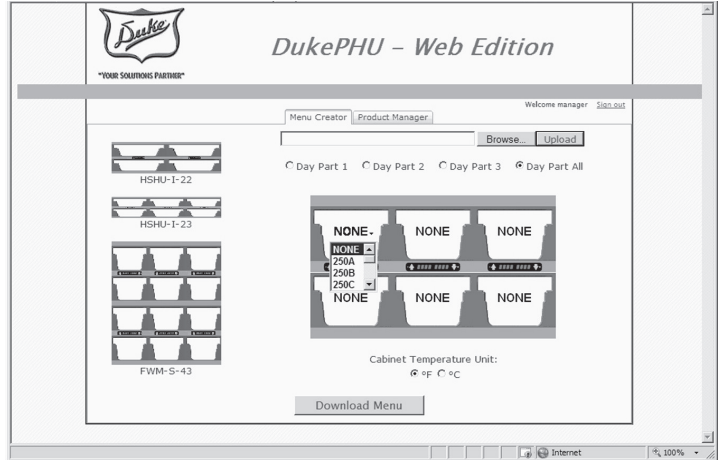

NOTE: All Day Parts should be configured prior to download

Click Download Menu

NOTE: Not all browsers will pop up with window to open or save

Click on Save

Click on Save as

The Save As dialog box will be displayed. The appearance of the screen may vary depending on the computer settings.

Ensure file is saving to Duke USB flash drive (P/N 156218)

Note: Depending on computer settings, you may be directed to the flash drive automatically or found in download folder.

NOTE: **DO NOT** customize the filename.

Ensure the File name is only **HMC343.CFG**

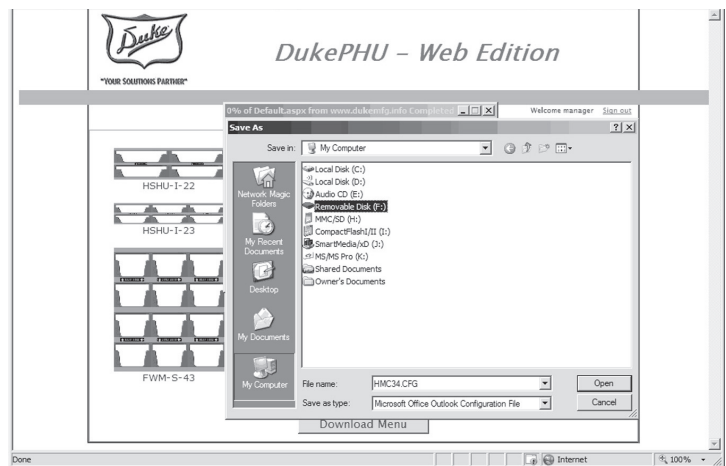
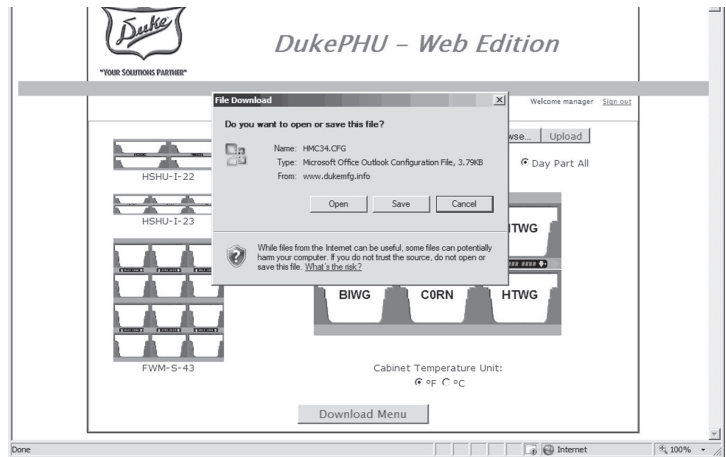

Wait until the file is completely saved on the Flash drive.

Use the Flash drive's eject option to safely remove the Flash drive from the computers USB port.

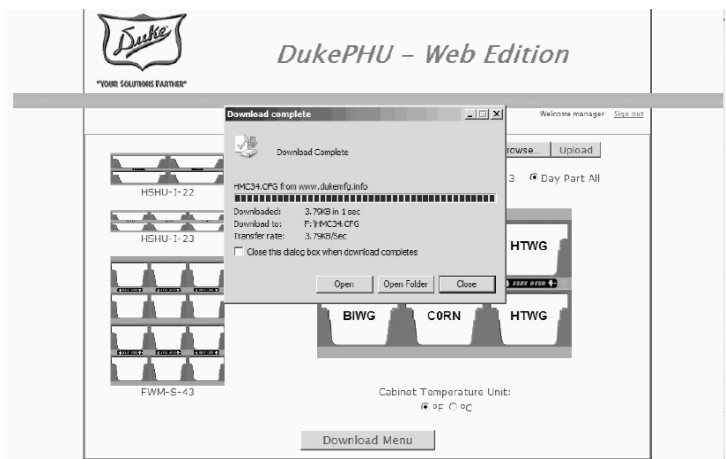

Move the power switch on the Duke PHU cabinet to its OFF position.

Insert the USB Flash drive into the PHU cabinet's USB port.

Turn unit to ON position

The program download will start automatically.

Download complete when product temperatures appear. Wait up to 2 minutes for program to load. The product names will not appear on the screen until the wells heat to the selected product set point.

Remove the Flash Drive from the PHU cabinet's USB drive.



REVISING A CABINET SETTING

Insert a blank jump drive into the PHU. Ensure that the jump drive is blank. If an HCM34.cfm file is on the jump drive it will overwrite the programming loaded in the PHU.

If the program is on the jump drive and it is the last one loaded into the PHU insert the jump drive into a USB port on the computer.

Log onto the Website. On the Menu Creator click Browse.

Find the jump drive on the computer and locate the HCM34.cfm file.

Double click on the HCM34.cfm file. When it appears in the dialog box, click Upload.

The cabinet with all of its programmed products will appear.

Make the desired changes and repeat the download process.

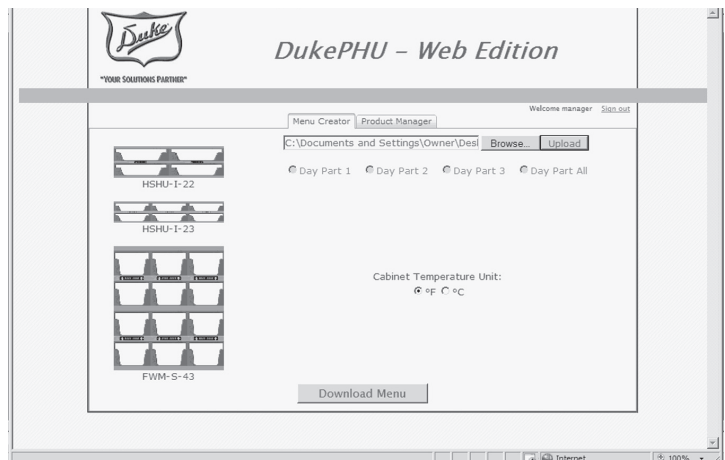
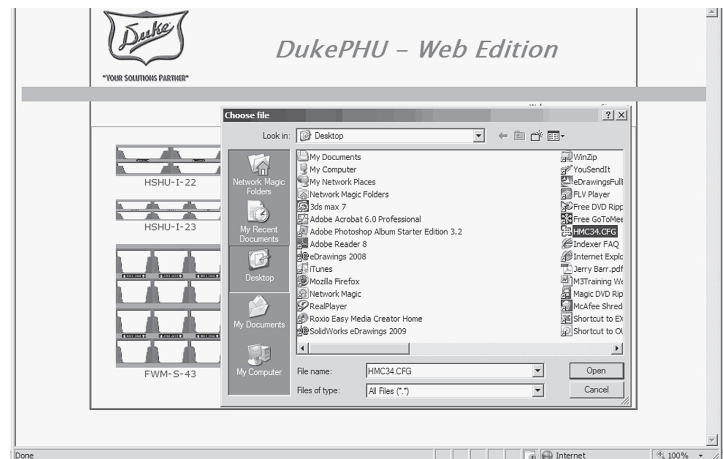

TROUBLESHOOTING

There are no user serviceable parts on the Duke Product Holding Cabinet. If a malfunction occurs, ensure unit is plugged in then check all switches and circuit breakers. If the malfunction still exists, contact your Duke Manufacturing Company authorized service agent or call 1-800-735-3853.

ELECTRONIC CONTROL FAULT INDICATIONS

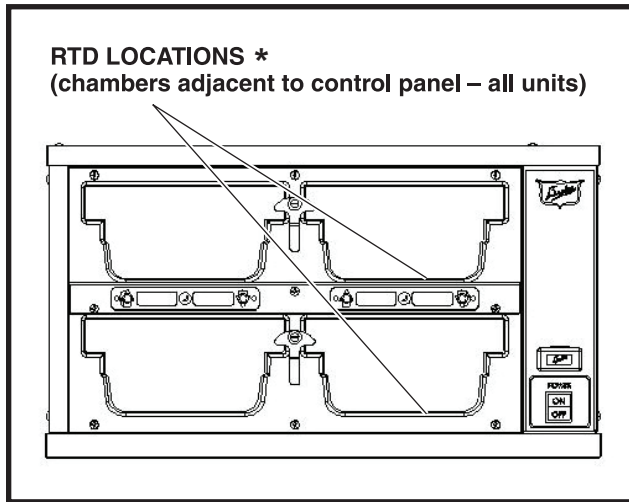

* See 5X1 wiring diagram for 5X1 RTD Locations.

The keypad display provides an indication to alert the operator to failures in the heater circuit. The possible fault conditions are as follows:

1. **Over-Temperature Fault** - An over-temperature fault occurs when the control senses that the shelf temperature is higher than the specified factory preset temperature for thirty minutes. This occurs when the power is not removed from the heating element after the shelf has achieved the preset temperature. The auxiliary thermostat prevents the temperature from exceeding safe levels by regulating the temperature to a maximum of 250°F. If this occurs, "HI" will appear on the keypad; the affected unit should not be used until the cause of the fault is corrected by a qualified service technician.
2. **Under-Temperature Fault** - An under-temperature fault occurs when the control senses that the shelf temperature is lower than the specified factory preset temperature for more than thirty minutes continuously. This occurs when heating element circuit opens or the RTD Feedback signal is faulty. If this occurs, "LO" will appear on the keypad and the affected unit should not be used until the cause of the fault is corrected by a qualified service technician.

NOTE: During normal operation the temperature may drop below the preset, due to environmental conditions. When this occurs the actual temperature will be displayed. This condition will be momentary and normal operation will resume shortly. If this should occur frequently or for long periods of time, the affected unit should not be used and you should contact the service hotline.

3. **Sensor Fault** – If at any time during normal operation "SENS" is displayed on the keypad: discontinue operation and contact qualified service technician.

TEMPERATURE CHECK PROCEDURE

1. A digital temperature meter that has been calibrated must be used to get an accurate temperature reading. Use a thermocouple surface temperature probe to measure temperatures.
2. **No pans should be in wells during the pre-heat and temperature check.** Pre-heat the warmer for 30 minutes before taking any temperature readings. Do not take readings unless the cavity has been empty for 30 minutes. This will allow the temperature to stabilize and will prevent false readings.
3. The warmer cavity should be cleaned and empty before the temperature is checked. Avoid any air drafts that might flow through the cavity.
4. Locate the surface temperature probe on the bottom of the first cavity in the geometric center. The first cavity is the one closest to the control panel (see figure). Make sure the probe is making good contact with the surface while taking readings.
5. All temperature controls exhibit a swing in temperature as the control cycles on and off while regulating to the set point. The correct calibration temperature is the average of several readings taken over a period of 20 minutes after the warmer has been pre-heated. The average temperature should be $\pm 5^{\circ}\text{F}$ from the set point.

SERVICE HOT-LINE

Check the display for fault messages. Perform the Temperature Check Procedure in this manual. Make note of the findings. Please, have this data handy before calling the Duke troubleshooting Hot Line listed above. For optimum support, please be near the suspect units with a cordless phone, if available, when calling our Technicians.

PROBLEM	PROBABLE CAUSE	SOLUTION
Display: NONE, ----, SENS, LO, '	Incorrect USB flash drive	Verify USB flash drive is a maximum of 8 GB and formatted to FAT (default) or FAT32.
	Storing multiple files on USB flash drive	Verify USB flash drive has ONLY 1 file.
	Renamed file	Verify file name is HMC34.CFG
	"Duplicate file created ex: HMC34 (1).CFG"	Rename file in all CAPS HMC34.CFG
	USB removed before download complete	Reload program, wait for product temperature and/or name to be displayed and remove USB flash drive.
	Did not wait long enough for program to load	Wait up to 2 minutes for program to load.
	Unit ON when plugging in USB flash drive	Turn OFF unit, plug in USB flash drive, and turn unit on. Wait for product temperature and/or name to be displayed and remove USB flash drive.
	NONE was programmed for only one well of a heat zone	Do not use NONE unless the entire heat zone will be programmed NONE.
Displays are incorrect	Replaced controller	Reload program.
	Misuse USB adapter	Reload program and ensure the USB port is not used for any other device (ex: cell phone).
Downloaded file, but doesn't open	File not meant to be opened	Verify file extension is still .CFG
Won't let me program what I want on the website	Temperatures not compatible with heat zone	Verify that products stored in same heat zone have the same holding temperatures.
I can't find my program file on the computer.	Using Firefox or Chrome as your web browser	"Check your download folder for HMC34.CFG file and move to USB flash drive. *Internet explorer allows you to choose where to store the file."

PARTS LISTS AND ILLUSTRATIONS

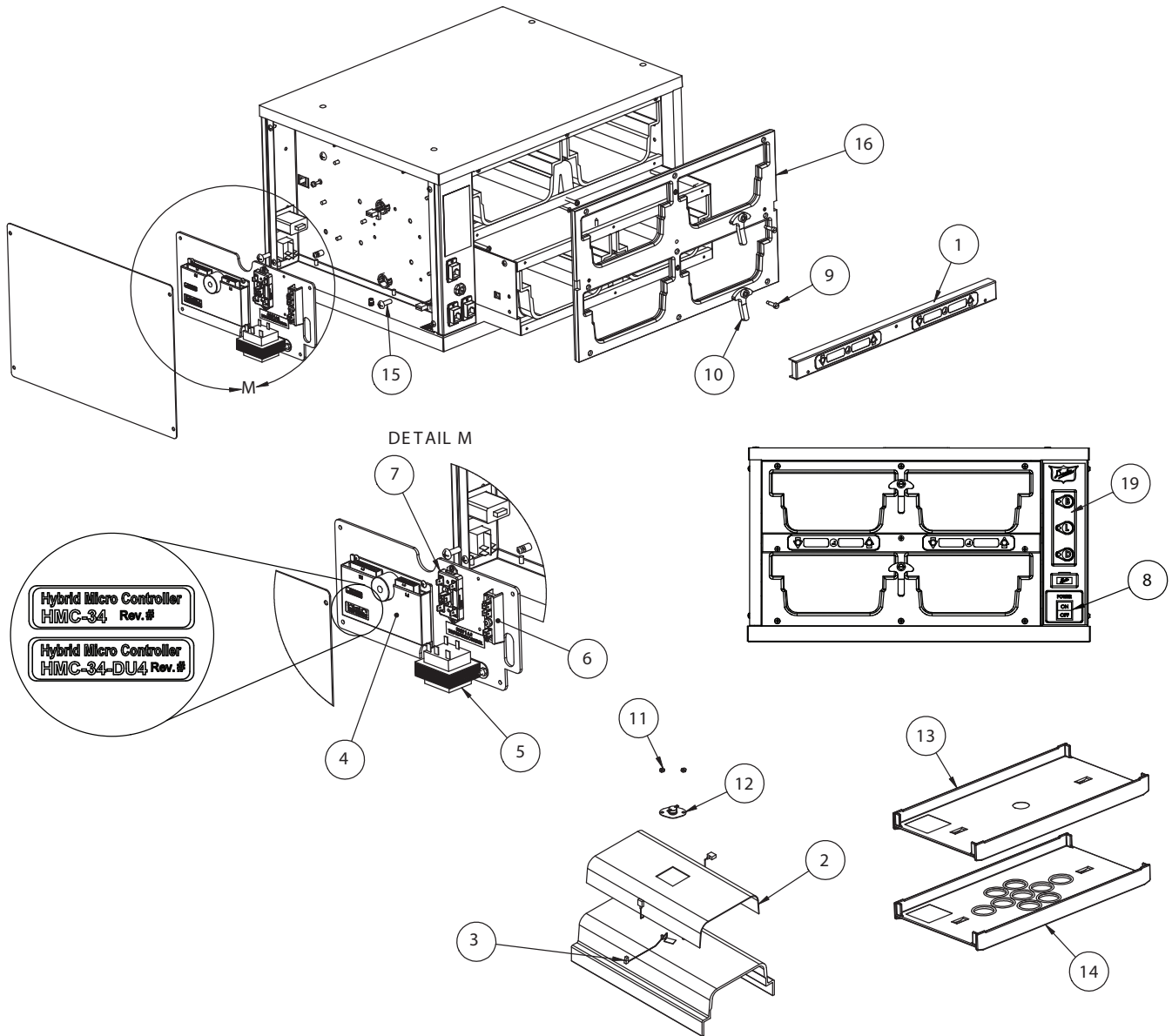

PARTS LISTS AND ILLUSTRATIONS (CONTINUED)

Locator	P/N	Description	FWM3 1X3	FWM3 1X4	FWM3 2X1	FWM3 2X2	FWM3 2X3	FWM3 2X4	FWM3 4X1	FWM3 4X2	FWM3 5X1
1	157828	KEYPAD - UP DOWN ARROWS [SER# 05162864 AND LOWER]			1 or 2	2 or 4	3 or 6	4 or 8	2 Or 4	4 or 8	3 or 6
	156292	KEYPAD - DOWN ARROWS FRONT ONLY [SER# 05162864 AND LOWER]	3	2							
	160585	KEYPAD - DOWN ARROWS REAR ONLY [SER# 05162864 AND LOWER]	3	2							
	161376	KEYPAD - UP DOWN ARROWS [SER# 05162865 AND HIGHER]			1 or 2	2 or 4	3 or 6	4 or 8	2 or 4	4 or 8	3 or 6
	161377	KEYPAD - DOWN ARROWS [SER# 05162865 AND HIGHER]	3 or 6	2 or 4							
2*	See Note	ELEMENT FOIL HEAT	3	4	2	4	6	8	4	8	5
3	155750	RTD 1K OHM THIN	1	1	2	2	2	2 or 4	4	4	2
4	600193	STANDARD CONTROL KIT	1	1	1	1	1	1	1	1	1
5	155749	TRANSFORMER, 208/240 VAC	1	1	1	1	1	1	1	1	1
	156838	TRANSFORMER, 230 VAC									
	156316	TRANSFORMER, 120 VAC									
	160840	TRANSFORMER 10 VAC/230 VAC (AUS/NZ) (Rev M or Older)									
6	157743	TERMINAL BLOCK	1	1	1	1	1	1	1	1	1
7	157830	RELAY, SMART POWER MODULE	1	1	1	1	1	1 or 2	2	2	1
8	600261	SWITCH, LIGHTED, DPST, 250V 16A, 250V	1	1	1	1	1	1	1	1	1
	600228	SWITCH, LIGHTED, DPST, 125V 20A, 120V									
9	156288	SCREW, SHOULDER	4	4	4	4	8	8	8	8	10
10	156285	LATCH, PAN	4	4	4	4	8	8	8	8	10
11	155680	NUT #8-32 KEPS	2	2	4	4	4	4	8	8	4
12	158312	THERMOSTAT AUXILIARY	1	1	2	2	2	2 or 4	4	4	2
13	161029	LID,FOODWARMER SOLID (BROILED)	AR	AR	AR	AR	AR	AR	AR	AR	AR
14	161030	LID,FOODWARMER VENTED (FRIED)	AR	AR	AR	AR	AR	AR	AR	AR	AR
15	0653638	SCREW, 1/4-20 X 3/4	4	4	8	8	8	8	16	16	20

PARTS LISTS AND ILLUSTRATIONS (CONTINUED)

Locator	P/N	Description	FWM3 1X3	FWM3 1X4	FWM3 2X1	FWM3 2X2	FWM3 2X3	FWM3 2X4	FWM3 4X1	FWM3 4X2	FWM3 5X1
16	600440	KIT, SS FACEPLATE, RENAU, FWM3-13, FRONT BARS ONLY	1								
	600441	KIT, SS FACEPLATE, RENAU, FWM3-13, FRONT AND REAR BARS	1								
	600442	KIT, SS FACEPLATE, RENAU, FWM3-14, FRONT BARS ONLY		1							
	600443	KIT, SS FACEPLATE, RENAU, FWM3-14, FRONT AND REAR BARS		1							
	600444	KIT, SS FACEPLATE, RENAU, FWM3-21, FRONT BARS ONLY			1						
	600445	KIT, SS FACEPLATE, RENAU, FWM3-21, FRONT AND REAR BARS			1						
	600437	KIT,SS FACEPLATE, RENAU, FWM3- 22, FRONT BARS ONLY				1					
	600438	KIT,SS FACEPLATE, RENAU, FWM3- 22, FRONT AND REAR BARS				1					
	600448	KIT, SS FACEPLATE, RENAU, FWM3-23, FRONT BARS ONLY					1				
	600449	KIT, SS FACEPLATE, RENAU, FWM3-23, FRONT AND REAR BARS					1				
	600450	KIT, SS FACEPLATE, RENAU, FWM3-24, FRONT BARS ONLY						1			
	600451	KIT, SS FACEPLATE, RENAU, FWM3-24, FRONT AND REAR BARS						1			
	600452	KIT, SS FACEPLATE, RENAU, FWM3-41, FRONT BARS ONLY							1		
	600453	KIT, SS FACEPLATE, RENAU, FWM3-41, FRONT AND REAR BARS							1		
	600454	KIT, SS FACEPLATE, RENAU, FWM3-42, FRONT BARS ONLY								1	
	600455	KIT, SS FACEPLATE, RENAU, FWM3-42, FRONT AND REAR BARS								1	
	600415	KIT, SS FACEPLATE, RENAU, FWM3-51, FRONT BARS ONLY									1
600416	KIT, SS FACEPLATE, RENAU, FWM3-51, FRONT AND REAR BARS									1	
17**	156603	CORD, NEMA 5-15P, 120V	1	1	1	1	1	1	1	1	1
	156621	CORD, NEMA 5-20P, 120V, CANADIAN FWM3-24,-42									
	156624	CORD, NEMA 6-15P, 208/240V									
	156631	CORD, 230V CE									
	156640	CORD, AU2-15P, AS/NZS 3112									
	175887	CORD, AUS/NZ									
18***	157964	FILTER, 10A	1	1	1	1	1	1	1	1	1
19	157916	SWITCH, DAYPART (Option)			1	1	1	1		1	1

Locator	P/N	Description	FWM3 1X3	FWM3 1X4	FWM3 2X1	FWM3 2X2	FWM3 2X3	FWM3 2X4	FWM3 4X1	FWM3 4X2	FWM3 5X1
20**	157868	REMOVABLE COVER 2X1 (OPTION)			1						
	157962	REMOVABLE COVER 2X2 (OPTION)				1					
	157840	REMOVABLE COVER 2X3 (OPTION)					1				
	160515	REMOVABLE COVER 2X4 (OPTION)						1			
	160410	REMOVABLE COVER 4X2 (OPTION)								1	
	160516	REMOVABLE COVER 5X1 (OPTION)									1
21**	157841	SCREW, 8-32 X 3/8" KNURL THUMB (FOR REMOVABLE COVER OPTION)			4	4	4	6		6	6
22**	156218	USB FLASH DRIVE	1	1	1	1	1	1	1	1	1

- * SEE SERVICE LABEL BELOW
- ** NOT SHOWN
- *** CE ONLY

Model FWM	100V		120V		208V		220V		230V		240V	
	Part No.	ID No.	Part No.	ID No.	Part No.	ID No.	Part No.	ID No.	Part No.	ID No.	Part No.	ID No.
FWM3-13*			156564	9	156301	3			156611	12	156565	10
FWM3-14*	157520	15	156566	11	155752	1			156318	5	155755	2
FWM3-21*	157906	29	160464	33	157907	30			157908	31	157909	32
FWM3-22*	156994	14	156483	6	156539	7	160820	40	156632	13	156540	8
FWM3-23*			156564	9	156301	3			156611	12	156565	10
FWM3-24*	157520	15	156566	11	155752	1			156318	5	155755	2
FWM3-34*					156856	26			157887	27	157887	27
FWM3-41*	157906	29	160464	33	157907	30			157908	31	157909	32
FWM3-42*	156994	14	156483	6	156539	7			156632	13	156540	8
FWM3-51* Upper 3	157558	16	156564	9	156301	3			156611	12	156565	10
FWM3-51* Lower 2	156994	14	156483	6	156539	7			156632	13	156540	8
FWM34-42*			157428	24	157748	19	160819	39	157749	20	160821	41
FWM34-43*					157736	17			157737	18	161300	42
FWM34-12*			157428	24					157749	20		
FWM34-15*			160671	34	160815	35	160816	36	160817	37	160818	38
FWM34-22*			157428	24	157748	19			157749	20	160821	41
FWM34-23*			157418	21	157736	17			157737	18		
FWM34-31*			160464	33					157908	31		
FWM34-32*			157428	24	157748	19	160819	39	157749	20	160821	41
FWM34-24*			157816	22	157817	23			157818	25		
FWM6-42* Upper 2			156483	6	156539	7	160820	40	156632	13	156540	8

CAUTION!
THE WARMER WELLS
HAVE DIFFERENT
HEATER ELEMENTS FOR
EACH CONFIGURATION.

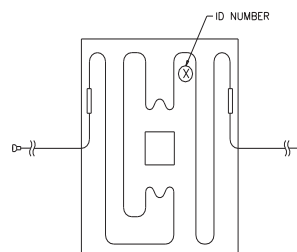

CAUTION!
VERIFY HEATER
ELEMENT ID
NUMBER BEFORE
REPLACEMENT.

* DENOTES XXX-YYY WHERE XXX IS CUSTOMER CODE AND YYY IS VOLTAGE

WIRING SCHEMATICS

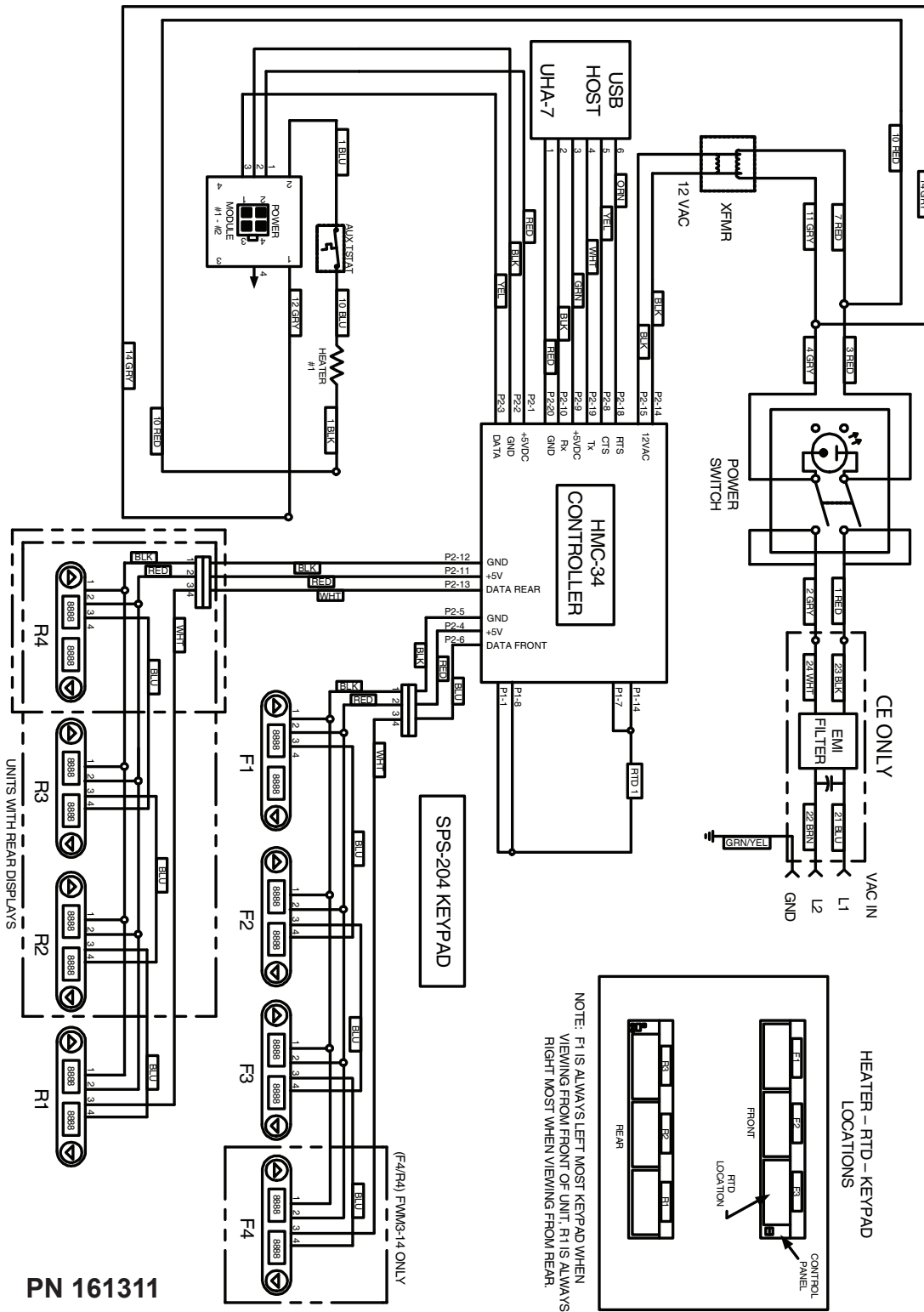

FWM 1-HIGH Internal Wiring Schematic

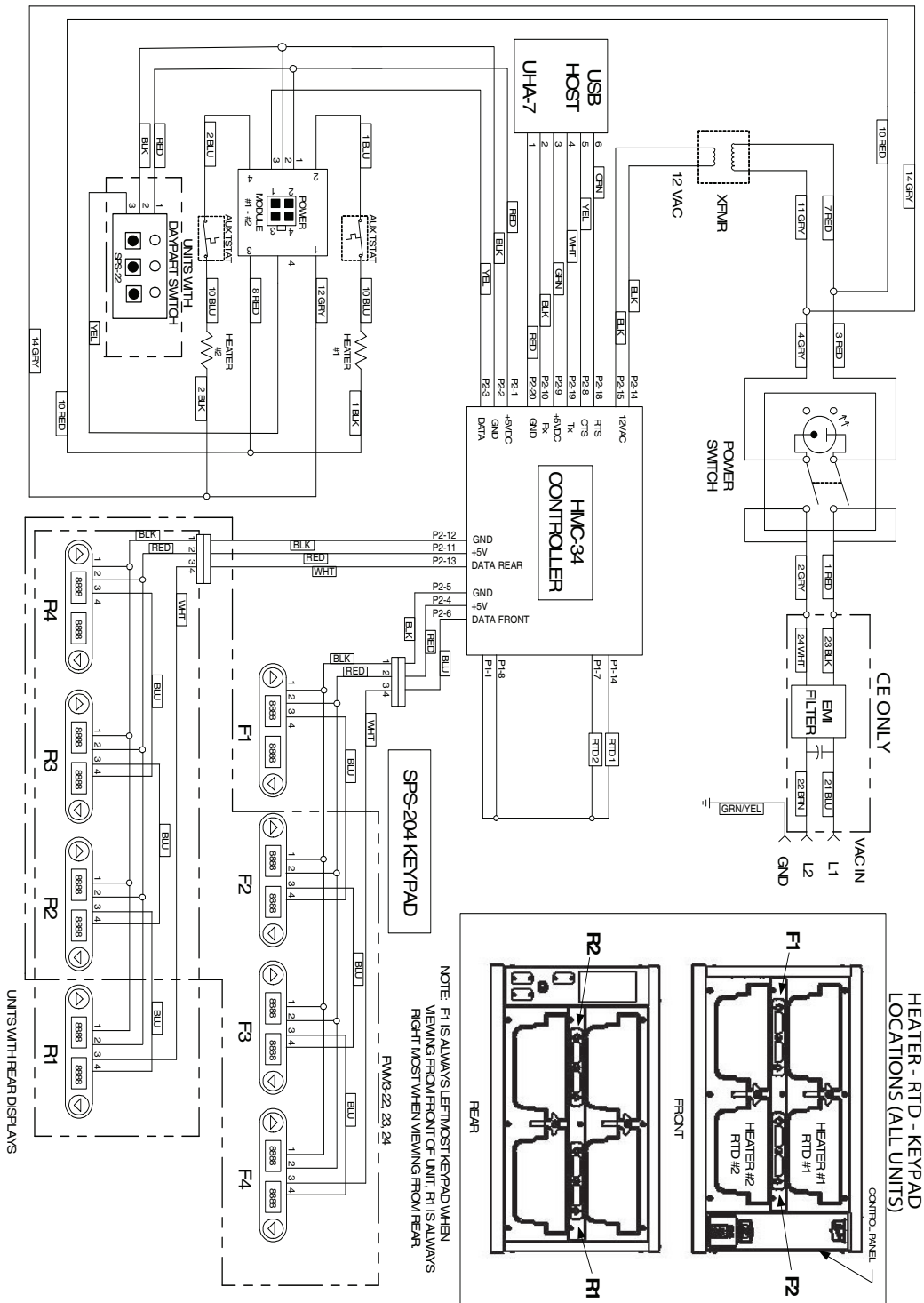

PN 161313

FWM 2-HIGH Internal Wiring Schematic

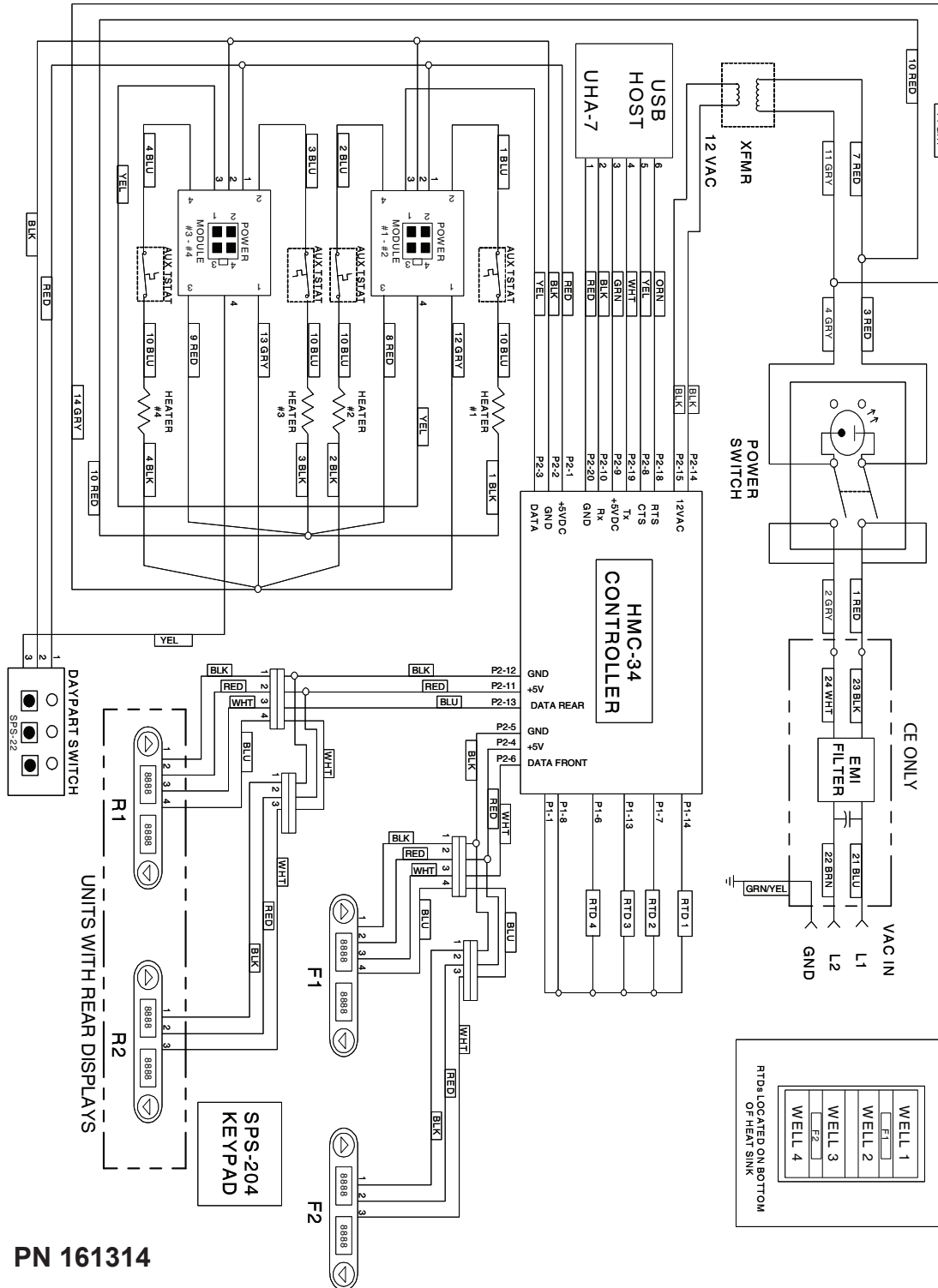

PN 161314

FWM 4x1 Internal Wiring Schematic

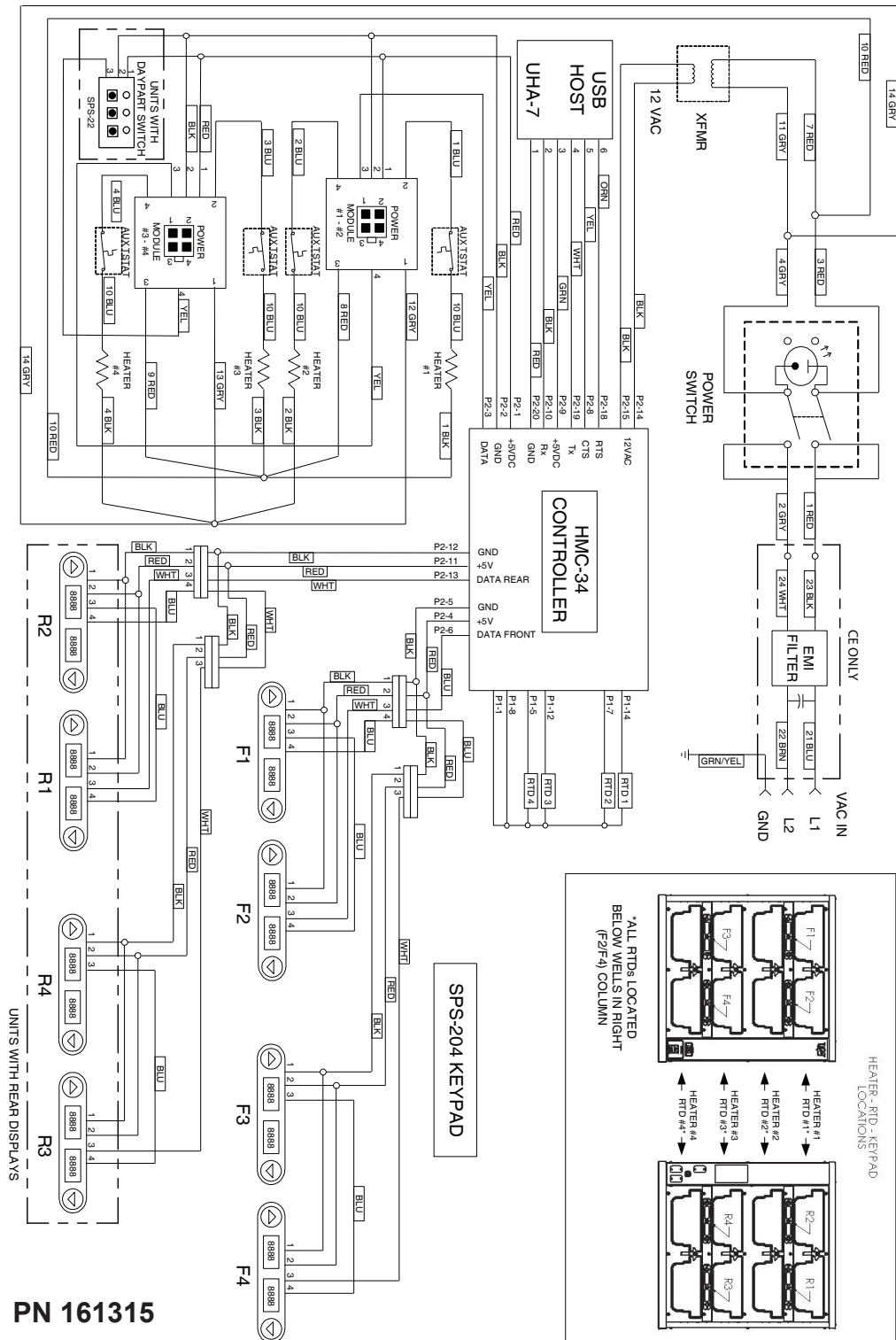

FWM 4x2 Internal Wiring Schematic

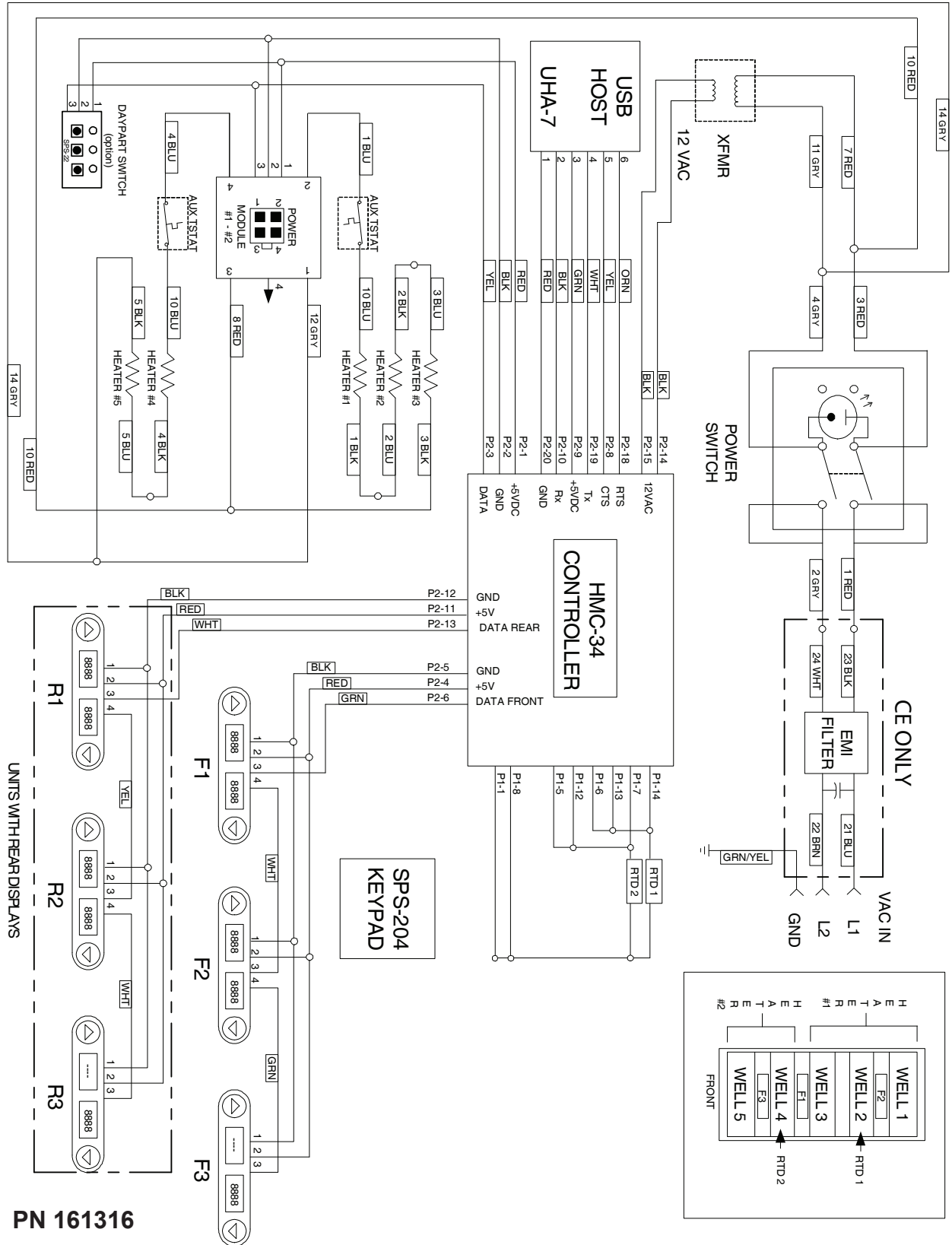

FWM 5x1 Internal Wiring Schematic

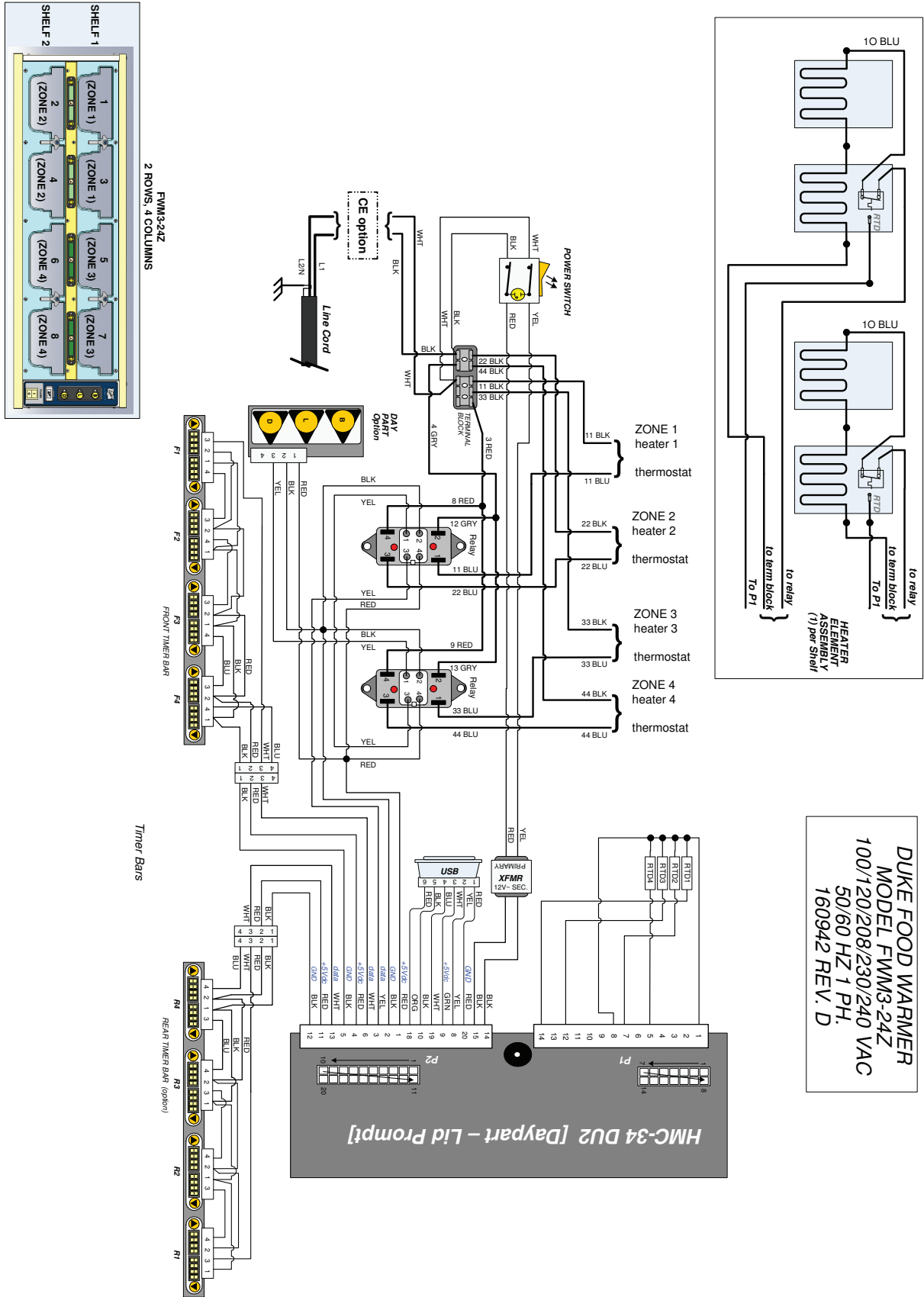

FWM 3-24Z Internal Wiring Schematic

TABLE MOUNTING (5X1)

HOLE LOCATIONS

For securing unit to table top, refer to the figure below which shows the foot print of the Duke 5X1 Food Warmer and location of the four 3/8 dia. mounting holes in base plate of unit. Position warmer on table and align holes with holes in bottom of warmer. Attach warmer to table using 1/4" bolts and washers, provided, as shown on next page. Seal all around base of warmer with Silicone. (Note: Be sure to allow sufficient clearance around base of warmer to rim of table)

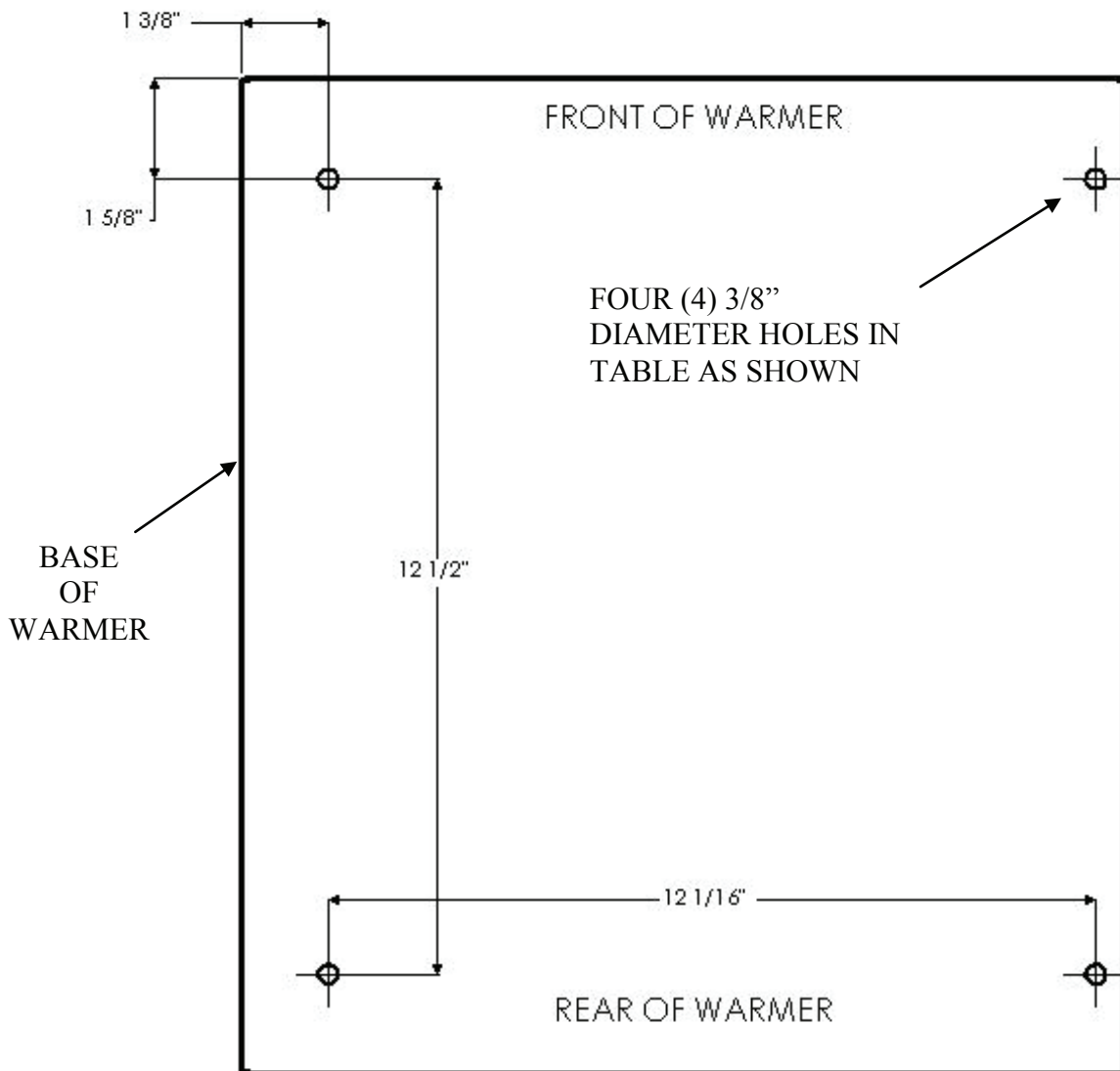

ATTACHING UNIT TO TABLE

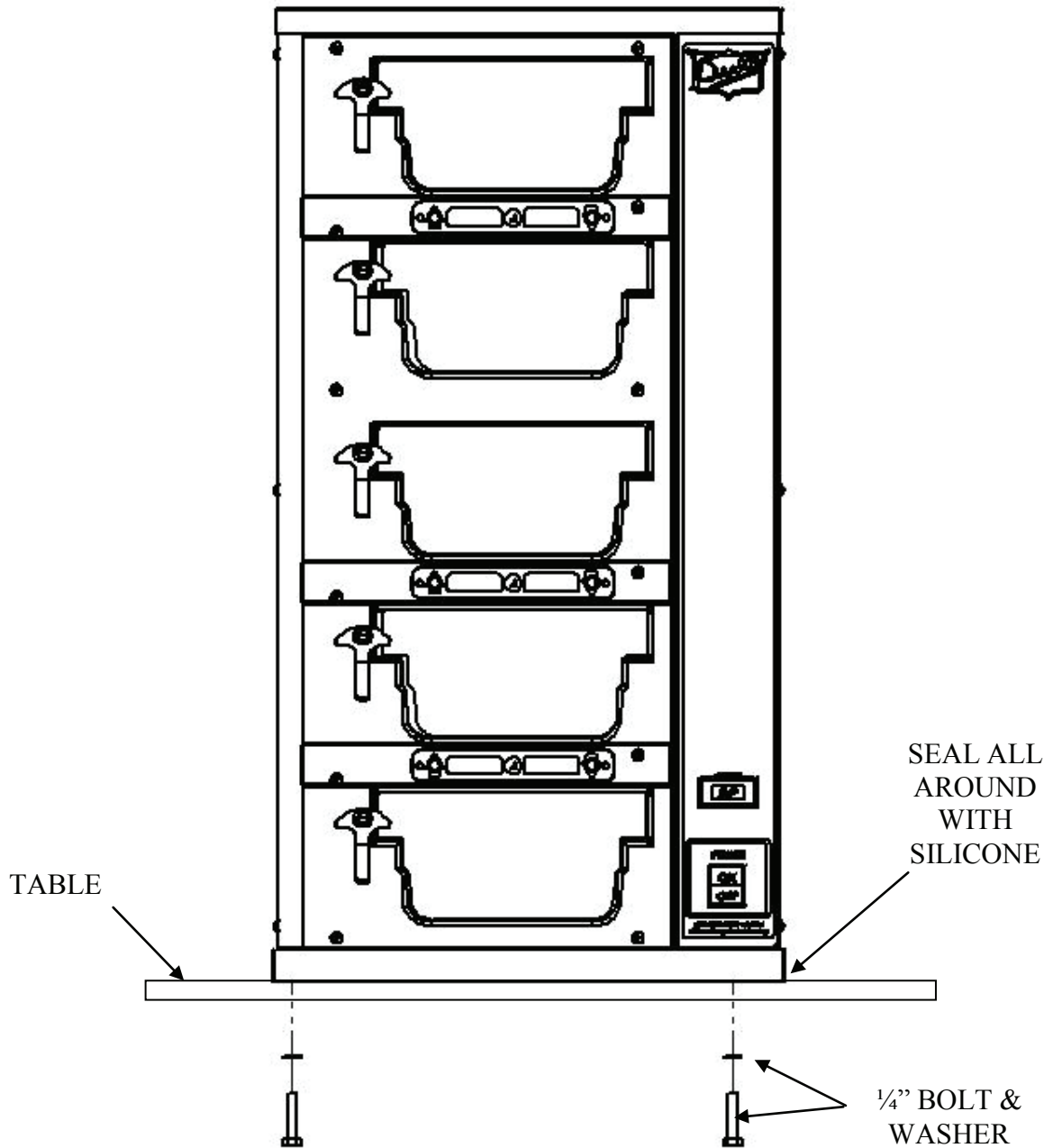



Your Solutions Partner

Duke Manufacturing Co.

2305 N. Broadway
St. Louis, MO 63102
Phone: 314-231-1130
Toll Free: 1-800-735-3853
Fax: 314-231-5074

www.dukemfg.com