

ELECTRIC COMBI - CONVECT OVENS

INSTRUCTIONS FOR INSTALLATION AND USE

Table of contents

	Page		
- Installation diagram	2	III. INSTRUCTIONS FOR USE	16
- Appliance identification	9	1. Opening the oven door	16
I. MAIN FEATURES	10	1.1 6- and 10-grid models	16
1. Description of appliance	10	1.2 20-GRID models	16
2. Table 1: Technical data	10	2. Closing the oven door	16
3. Precautions	11	2.1 6- and 10-GRID models	16
4. Safeguarding the environment	12	2.2 20-GRID models	16
4.1 Packaging	12	3. Description of the control panel	17
4.2 Use	12	3.1 Introduction	17
4.3 Cleaning	12	3.2 Main controls	17
4.4 Disposal	12	3.3 Main cooking modes	17
II. INSTRUCTIONS FOR INSTALLATION	13	3.4 Special cooking modes	17
1. Place of Installation	13	3.5 Additional functions	18
1.1 Reference standards	13	USING THE OVEN	19
1.2 Packaging	13	4. Introduction	19
2. Positioning	13	4.1 Switching the oven on	19
3. Electrical connection	13	4.2 Selecting the controls	19
3.1 Installing the power supply cable	14	4.3 Manual controls	19
4. Water mains connection	14	4.4 Automatic controls	23
4.1 Water supply characteristics	14	5. Information and error codes	26
4.2 Water drain system	14	6. SWITCHING off in the event of a fault	27
5. Safety devices	15	7. Care and maintenance	27
6. Operation check	15	7.1 Periodical maintenance of the BOILER	28
7. Servicing	15	7.2 Replacing CONSUMABLE components	29
8. Troubleshooting	15	7.3 Special cleaning instructions	29
9. Layout of main components	15	- CONTROL PANEL FIGURES	97

- APPLIANCE IDENTIFICATION

Rating plate

PNC 9PDX 260462 05 N° _____ Hz _____ kW _____

CONFORMS TO ANSI/UL STD 197
 CERTIFIED TO CSA C22.2 No. 109
 CONFORMS TO NSF/ANSI 4
 CONTROL NUMBER _____

2. TABLE 1: TECHNICAL DATA

6GN1/1			
(AOS061E)			
260450-260510	260462	260456	260454
260451-260511	260463	260457	260455
o	o	o	o
**	**	**	**
	230	200	

I. MAIN FEATURES

1. DESCRIPTION OF APPLIANCE

This booklet describes a number of appliance models. For more detailed information about the model in your possession, refer to "Technical Data" table 1.

The appliance has the following features:

- Digital temperature controlle.
- Thermostatic probe for measuring the core temperature of products (core temperature probe).
- Automatic flush to drain every two hour to prevent the build-up of lime-scale in the boiler.
- Periodic draining and automatic washing of the boiler to prevent the build-up of lime-scale.

- Boiler lime-scale level indicator (see corresponding paragraph).
- Oven chamber automatic fast steam drain device for gratins.
- Air-break (anti-backup drain) device to prevent backflows from the drain system from entering the oven.
- Halogen lighting in the cooking chamber.
- Double-action door opening **safety** mechanism designed to protect the user from scalding steam.
- Double-glazed oven door for reduced heat dispersion into the kitchen and low temperatures on the exterior of the oven.
- Self-diagnostics system indicating oven faults using error codes (see "Information and error codes").

2. TABLE 1: TECHNICAL DATA

GRIDS		6 GN 1/1				6 GN 2/1				10 GN 1/1			
PNC *	A^	267080		267090		267081		267091		267082		267092	
	C^		269080		269090		269081		269091		269082		269092
CONVECTOR *		o	o	o	o	o	o	o	o	o	o	o	o
BOILER **		**		**		**		**		**		**	
SUPPLY VOLTAGE		208V 3ph 60Hz 32amps	208V 3ph 60Hz 32amps	240V 3ph 60Hz 32amp	240V 3ph 60Hz 32amp	208V 3ph 60Hz 80amps	208V 3ph 60Hz 80amps	240V 3ph 60Hz 80amp	240V 3ph 60Hz 80amp	208V 3ph 60Hz 63amps	208V 3ph 60Hz 63amps	240V 3ph 60Hz 63amp	240V 3ph 60Hz 63amp
Total Watts		10,1 kW	9,6 kW	10,1 kW	9,6 kW	21 kW	21 kW	21 kW	21 kW	17 kW	17 kW	17 kW	17 kW
Maximum load capacities (food)		66 lbs. (30 kg)	66 lbs. (30 kg)	66 lbs. (30 kg)	66 lbs. (30 kg)	122 lbs. (60 kg)	122 lbs. (60 kg)	122 lbs. (60 kg)	122 lbs. (60 kg)	110 lbs. (50 kg)	110 lbs. (50 kg)	110 lbs. (50 kg)	110 lbs. (50 kg)
Net weight		254 lbs. (115 kg)	254 lbs. (115 kg)	254 lbs. (115 kg)	254 lbs. (115 kg)	331 lbs. (150 kg)	332 lbs. (150 kg)	333 lbs. (150 kg)	334 lbs. (150 kg)	320 lbs. (145 kg)	320 lbs. (145 kg)	320 lbs. (145 kg)	320 lbs. (145 kg)
Shipping weight		273 lbs. (124 kg)	273 lbs. (124 kg)	273 lbs. (124 kg)	273 lbs. (124 kg)	358 lbs. (162 kg)	359 lbs. (162 kg)	360 lbs. (162 kg)	361 lbs. (162 kg)	337 lbs. (153 kg)	337 lbs. (153 kg)	337 lbs. (153 kg)	337 lbs. (153 kg)
Shipping width		38 3/4"inch (985 mm)	38 3/4"inch (985 mm)	38 3/4"inch (985 mm)	38 3/4"inch (985 mm)	38 3/4"inch (1135 mm)	39 3/4"inch (1135 mm)	40 3/4"inch (1135 mm)	41 3/4"inch (1135 mm)	38 3/4"inch (985 mm)	38 3/4"inch (985 mm)	38 3/4"inch (985 mm)	38 3/4"inch (985 mm)
Shipping height		42 1/8"inc (1070 mm)	42 1/8"inc (1070 mm)	42 1/8"inc (1070 mm)	42 1/8"inc (1070 mm)	42 1/8"inc (1070 mm)	43 1/8"inc (1070 mm)	44 1/8"inc (1070 mm)	45 1/8"inc (1070 mm)	52 3/16"inch (1325 mm)	52 3/16"inch (1325 mm)	52 3/16"inch (1325 mm)	52 3/16"inch (1325 mm)
Shipping depth		37 5/8"inch (955 mm)	37 5/8"inch (955 mm)	37 5/8"inch (955 mm)	37 5/8"inch (955 mm)	37 5/8"inch (1265 mm)	38 5/8"inch (1265 mm)	39 5/8"inch (1265 mm)	40 5/8"inch (1265 mm)	37 5/8"inch (955 mm)	37 5/8"inch (955 mm)	37 5/8"inch (955 mm)	37 5/8"inch (955 mm)

Noise emission data: Noise emissions generated by the appliances described in this booklet do not exceed 70 dB (A).

* Your appliance model is indicated in the box marked **PNC** on the Identification dataplate affixed to the bottom left hand side of the oven.

^ FUNCTIONAL LEVEL (C = Convect, Convection)

GRIDS		10 GN 2/1				20 GN 1/1				20 GN 2/1			
PNC *	A^	267083		267093		267084		267094		267085		267095	
	C^		269083		269093		269084		269094		269085		269095
CONVECTOR °		o	o	o	o	o	o	o	o	o	o	o	o
BOILER **		**		**		**		**		**		**	
SUPPLY VOLTAGE		208V 3ph 60Hz 80amps	208V 3ph 60Hz 80amps	240V 3ph 60Hz 80amp	240V 3ph 60Hz 80amps	208V 3ph 60Hz 100amps	208V 3ph 60Hz 100amps	240V 3ph 60Hz 100amp	240V 3ph 60Hz 100amps	208V 3ph 60Hz 150amps	208V 3ph 60Hz 150amps	240V 3ph 60Hz 150amp	240V 3ph 60Hz 150amps
Total Watts		24 kW	24 kW	24 kW	24 kW	34.5 kW	34 kW	34.5 kW	34 kW	48 kW	48 kW	48 kW	48 kW
Maximum load capacities (food)		220 lbs. (100 kg)	220 lbs. (100 kg)	220 lbs. (100 kg)	220 lbs. (100 kg)	220 lbs. (100 kg)	220 lbs. (100 kg)	220 lbs. (100 kg)	220 lbs. (100 kg)	440 lbs. (200 kg)	440 lbs. (200 kg)	440 lbs. (200 kg)	440 lbs. (200 kg)
Net weight		461 lbs. (209 kg)	461 lbs. (209 kg)	461 lbs. (209 kg)	461 lbs. (209 kg)	534 lbs. (242 kg)	534 lbs. (242 kg)	534 lbs. (242 kg)	534 lbs. (242 kg)	860 lbs. (390 kg)	860 lbs. (390 kg)	860 lbs. (390 kg)	860 lbs. (390 kg)
Shipping weight		496 lbs. (225 kg)	496 lbs. (225 kg)	496 lbs. (225 kg)	496 lbs. (225 kg)	639 lbs. (290 kg)	639 lbs. (290 kg)	639 lbs. (290 kg)	639 lbs. (290 kg)	926 lbs. (420 kg)	926 lbs. (420 kg)	926 lbs. (420 kg)	926 lbs. (420 kg)
Shipping width		44 11/16"inch (1135 mm)	44 11/16"inch (1135 mm)	44 11/16"inch (1135 mm)	44 11/16"inch (1135 mm)	38 3/4"inch (985 mm)	38 3/4"inch (985 mm)	38 3/4"inch (985 mm)	38 3/4"inch (985 mm)	44 11/16"inch (1135 mm)	44 11/16"inch (1135 mm)	44 11/16"inch (1135 mm)	44 11/16"inch (1135 mm)
Shipping height		52 3/16"inch (1325 mm)	52 3/16"inch (1325 mm)	52 3/16"inch (1325 mm)	52 3/16"inch (1325 mm)	81 1/8"inch (2060 mm)	81 1/8"inch (2060 mm)	81 1/8"inch (2060 mm)	81 1/8"inch (2060 mm)	81 1/8"inch (2060 mm)	81 1/8"inch (2060 mm)	81 1/8"inch (2060 mm)	81 1/8"inch (2060 mm)
Shipping depth		49 13/16"inch (1265 mm)	49 13/16"inch (1265 mm)	49 13/16"inch (1265 mm)	49 13/16"inch (1265 mm)	41 3/4"inch (1060 mm)	41 3/4"inch (1060 mm)	41 3/4"inch (1060 mm)	41 3/4"inch (1060 mm)	51 3/16"inch (1300 mm)	51 3/16"inch (1300 mm)	51 3/16"inch (1300 mm)	51 3/16"inch (1300 mm)

3. PRECAUTIONS

- The following terms alert you to potentially dangerous conditions to the operator, service personnel or to the equipment.
- **Danger!** This term warns of immediate hazards which will result in severe injury or death.
- **Warning!** This term refers to a potential hazard or unsafe practice which could result in injury or death.
- **Notice.** This term refers to information that needs special attention or must be fully understood, even though not dangerous.

- Keep the appliance area free and clear from combustibles.

Warning Fire hazard.
For your safety, do not store or use gasoline or other flammable, vapors and liquids in the vicinity of this or any other appliance.
Keep area around appliances free and clear of combustibles

Warning!
Failure to properly vent the oven can be hazardous to the health of the operator; and will result in operational problems, unsatisfactory baking, and possible damage to the equipment. Damage sustained as a direct result of improper ventilation will not be covered by the Manufacturer's warranty.

NOTICE: INTENDED FOR COMMERCIAL USE ONLY. NOT FOR HOUSEHOLD USE.



CAUTION HOT SURFACES



CAUTION RISK ELECTRIC SHOCK

CAUTION: Do not locate unit adjacent to any high heat or grease producing piece of equipment, such as a range top, griddle, fryer, etc., that could allow radiant heat to raise the exterior temperature of the Air-O-Steam Oven.

- Carefully read this instruction booklet, as it contains important advice for safe installation, operation and maintenance.

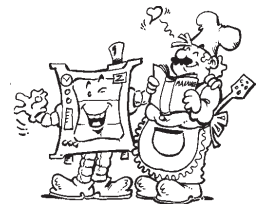

- Keep this instruction booklet in a safe place for future reference.

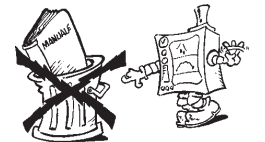

- The installation of this unit must conform to local codes or, in the absence of local codes, to all National Codes governing plumbing, sanitation, safety and good trade practices.

WARNING: The equipment warranty is not valid unless the appliance is installed, started and demonstrated under the supervision of a factory trained installer.

WARNING: The unit must be installed by Personnel who are qualified to work with electricity and plumbing. Improper installation can cause injury to personnel and/or damage to the equipment. The unit must be installed in accordance with applicable codes.

Important: The installation instructions contained herein are for the use of qualified installation and service personnel only. Installation or service by other than qualified personnel may result in damage to the appliance and/or injury to the operator. **FAILURE TO COMPLY WITH INSTALLATION INSTRUCTION OR IMPROPER INSTALLATION WILL VOID WARRANTY AND RESPONSIBILITIES OF THE MANUFACTURE.**

• Our appliances have been studied and optimized to give the highest performance. This appliance is intended for industrial use only and is specifically designed to cook food. Any other use will be considered "improper use" and will void the warranty and manufacturer liability.

WARNING: ANY POTENTIAL USER OF THE EQUIPMENT SHOULD BE TRAINED IN SAFE AND CORRECT OPERATING PROCEDURES.

• This appliance is not intended for use by people (including children) with limited physical, sensory or mental abilities or without experience and knowledge of it, unless they are supervised or instructed in its use by a person responsible for their safety.

WARNING: BEFORE SERVICING, DISCONNECT THE ELECTRICAL SERVICE AND PLACE A RED TAG AT THE DISCONNECT SWITCH TO INDICATED WORK IS BEING DONE ON THAT CIRCUIT.

NOTICE: Using any parts other than OEM original spare parts relieves the manufacturer of all warranty and liability.

NOTICE: Manufacturer reserves the right to change specifications at any time without notice.

Failure to comply with the above requirement may jeopardise the safety of the appliance and invalidate the guarantee.

WARNING: DO NOT SPRAY THE OUTSIDE OF THE APPLIANCE WITH WATER OR CLEAN WITH A WATER JET. CLEANING WITH A WATER JET CAN IMPREGNATE CHLORIDES INTO THE STAINLESS STEEL, CAUSING THE ONSET OF CORROSION.

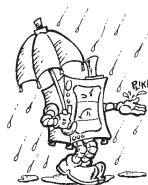

WARNING: DO NOT USE PRODUCTS CONTAINING CHLORINE (BLEACH, HYDROCHLORIC ACID ETC.) EVEN DILUTED, TO CLEAN STEEL SURFACES.

WARNING: DO NOT USE CORROSIVE SUBSTANCES (E.G. MURIATIC ACID) TO CLEAN THE FLOOR UNDER THE APPLIANCE.

4. SAFEGUARDING THE ENVIRONMENT

4.1 PACKAGING

• All the packaging materials used are environmentally safe and friendly. They may be stored without fear or danger. They may be recycled or burned in a special waste incineration plant. Recyclable plastic components are marked as follows:



polyethylene : external wrapping film, instructions booklet bag and gas injectors bag



polypropylene: top packaging panels and straps



expanded polystyrene: protective surround elements

4.2 USE

• The appliance has been designed and perfected under laboratory testing conditions to offer exceptional levels of performance. However, to minimise energy consumption (electricity, gas and water), do not leave the appliance in operation for long periods without food in the oven chamber and avoid conditions that reduce efficiency (e.g. door open). We also recommend preheating the appliance immediately prior to use.

4.3 CLEANING

• To minimise the emission of pollutants into the environment, clean the appliance (externally and, where necessary, internally) with products that are at least 90% biodegradable.

4.4 DISPOSAL

• Appliances that have reached the end of their service life should be suitably disposed of.
 • The appliance is made from more than 90% recyclable materials (stainless steel, iron, aluminium, galvanised sheet steel, etc.). These materials may therefore be scrapped in accordance with local waste disposal regulations at a conventional recycling plant.
 • Make the appliance unusable by cutting off the power cord. Also remove any compartment or interior closure device fitted on the appliance to prevent persons from becoming trapped inside.

II. INSTRUCTIONS FOR INSTALLATION

Important: The oven outer panels must be removed to perform the operations described in this chapter. Since the appliance must be switched on to make certain adjustments, exercise the utmost care when working in the vicinity of live electrical parts.

1. PLACE OF INSTALLATION

1.1 VENTILATION

The necessity for a properly designed and installed ventilation

system cannot be over emphasized. The ventilation system will allow the unit to function properly while removing unwanted vapors and products of combustion from the operating area.

The appliance must be vented with a properly designed mechanically driven exhaust hood. The hood should be sized to completely cover the equipment plus an overhang of at least 6"/15.3cm on all sides not adjacent to a wall. The capacity of the hood should be sized appropriately and provisions for adequate makeup air.

Refer to your local ventilation codes. In the absence of local codes, refer to the National ventilation code titled, "Standard for the

Installation of Equipment for the Removal of Smoke and Grease Laden Vapors from Commercial Cooking Equipment", NFPA-96-Latest Edition.

It is recommended that the ventilation system and duct work be checked at prevailing intervals as specified by the hood manufactured

- **The appliance must only be installed in adequately ventilated premises.**

NOTICE: Proper ventilation is the owner's responsibility. Any problem due to improper ventilation will not be covered by the warranty.

1.2 REFERENCE STANDARDS

Note: The electric supply installation must satisfy the requirements of the appropriate statutory authority, such as the National Electrical Code (NEC) ANSI/NFPA70, (U.S.A.); the Canadian Electrical Code, CSA C22.2; or other applicable regulations.

Note: The electric supply connection must meet all national and local electrical code requirements.

Note: The installation of this unit must conform to local codes or, in the absence of local codes, to all National Codes governing plumbing, sanitation, safety and good trade practices, and to the National Gas Code ANSI Z223.1.

- Local codes regarding installation vary greatly from one area to another. This equipment is to be installed to comply with the applicable federal, state or local codes.

The installation instructions contained herein are for the use of qualified installation and service personnel only. Installation or service by other than qualified personnel may result in damage to the appliance and/or injury to the operator.

FAILURE TO COMPLY WITH INSTALLATION INSTRUCTION OR IMPROPER INSTALLATION WILL VOID WARRANTY AND RESPONSIBILITIES OF THE MANUFACTURE.

The National Fire Protection Association, Inc states in its NFPA 96 latest edition that local codes are the "authority having jurisdiction" when it comes to installation requirements for equipment. Therefore, installations should comply with all local codes.

1.3 UNPACKAGING

- Remove the appliance from the packaging and take away the protective film that covers the appliance's external panels carefully to avoid leaving any trace of glue. If necessary remove the glue using an a non-corrosive solvent, rinsing it off and drying carefully.
- Dispose of packaging material in compliance with the regulations in force in the country where the product is to be used.

1.4 IMMEDIATELY INSPECT FOR SHIPPING DAMAGE

The container should be examined for damage before and during unloading. The freight carrier has assumed responsibility for its safe transit and delivery. If damaged equipment is received, either apparent or concealed, a claim must be made with the delivering carrier. Apparent damage or loss must be noted on the freight bill at the time of delivery. The freight bill must then be signed by the carrier representative (Driver). If the bill is not signed, the carrier may refuse the claim. The supply can supply the necessary forms. A request for inspection must be made to the carrier within 15 days if there is concealed damage or loss that is not apparent until after the equipment is uncrated. The carrier should arrange an inspection. Be certain to hold all contents plus all packing material. Under no circumstances should a damaged appliance be returned to the manufacturer without prior notice and written authorization.

2. POSITIONING

- Refer to the installation diagrams at the beginning of this booklet for the space requirements and connection dimensions of the appliance.

- Clearance of approximately **23.62" (50cm)** must be left between the appliance's left side panel and adjacent structures in order to provide space for maintenance operations when needed; the right side panel and the rear panel of the appliance must be at least **3.94" (10cm)** from adjacent structures.
- Place the appliance in the required position and level the oven with a slight pitch toward the rear to help drain water from chamber using the appropriate bullet feet.
- The appliance is not suitable for built-in installation.

Warning: The oven must be installed on an even (level) non-flammable flooring and any adjacent walls must be non-flammable. Recommended minimum clearance are specified in this manual.

Important:

Make sure steam from the oven's drain or adjacent appliances does not enter the aeration vents under the appliance, designed to cool internal components located at the bottom of the appliance.

3. ELECTRICAL CONNECTION

- A fused disconnect switch or main circuit breaker (customer furnished) **MUST** be installed in the electric supply line for the appliance. It is recommended that this switch/circuit breaker have lockout/tagout capability. Before making any electrical connections to this appliance, check that the power supply is adequate for the voltage, amperage, and phase requirements on the rating plate.

- A safety cutout switch of suitable capacity with a contact breaking distance of at least 3 mm must be fitted upstream of the appliance.

The cutout switch must be installed near the appliance in the permanent electrical system of the premises.

- The appliance must be electrically grounded in accordance with local codes, or in the absence of local codes, with the National Electrical Code, ANSI/NFPA 70, or the Canadian Electrical Code, CSA C22.2, as applicable.

The grounding conductor must therefore be connected to the terminal marked \perp on the connection terminal board. The appliance must also be connected to an earth grounding system.

This connection is made using the stop screw marked ∇ located on the outside of the appliance near the power cable inlet.

The grounding wire must have a minimum cross-section of 8 AWG (10 mm²).

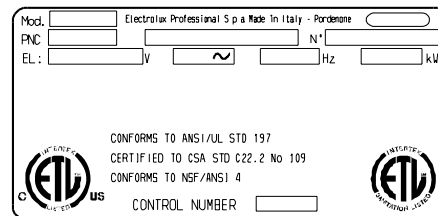

RATING PLATE

3.1 INSTALLING THE POWER SUPPLY CABLE

To access the power supply cable connection terminal board, proceed as follows:

Model 6 - 10 - 20 GN

- Remove the left side panel.
- Connect the power supply cable to the terminal board according to the instructions given in the wiring diagram and fasten the power supply cable by means of strain-relief fitting (not furnished with the oven).

Failure to comply with safety rules and regulations relieves the manufacturer of all liability.

The manufacturer requires when stacking units each appliance

have its own branch circuit protection. An air-o-steam® unit stacked with an air-o-chill® unit should have a separate protection for the upper and lower units.

4. WATER MAINS CONNECTION

(Refer to the installation diagrams at the beginning of this booklet).

This equipment is to be installed to comply with the applicable Federal, State, Local plumbing codes, or the Basic Plumbing Code of the Building Officials and Code Administrators International Inc. (BOCA) and Food Service Sanitation Manual of the Food and Drug Administration (FDA).

When connecting the appliance to the water system with flexible tubes they must be new and not used.

The appliance is fitted with two separate water inlets ("B" and "N"). The water lines supplying both inlets must be fitted with a mechanical filter and shut-off valve (keeping with local plumbing codes).

Before fitting the filters allow the water to flow out for sufficient time to flush any solid particles from the piping.

Pressure between 22 and 65 psi (150-450 kPa).

WATER INLET "N"

Attention (water inlet N)

If the supply pipes provided with the appliance are not long enough for installation, use longer ones with **int. diameter at least ø 20 mm** and free of elbow unions.

Note:

To check correct water installation, make sure the rotating wash arm (CLEANING SYSTEM) does not turn below 100 rpm (120 max).

4.1 WATER SUPPLY CHARACTERISTICS

The appliance must be supplied with **drinking water** having specific characteristics given in this section.

HARDNESS FILTER

Water inlet	Appl.	Hardness		
		°f	ppm	°dH
B	A ^	0,5 - 5	5 - 50	0,28 - 2,8
	B ^	0,5 - 5	5 - 50	0,28 - 2,8
	C ^	max 5	max 50	max 2,8
N	A ^	max 5	max 50	max 2,8
	B ^	max 40	max 400	max 22
	C ^	max 5	max 50	max 2,8

^ OPERATING LEVEL (C = Convect, Convection).

The **hardness values** given in the table are for reducing scaling inside the steam generator and possible cooking compartment washing system.

If the available water does not have these hardness characteristics a water softener must be installed.

Therefore the Automatic Water Softener with automatic regeneration for installing on the inlet line, can be requested as an accessory; it has a Resin Sterilizer kit (also by request).

HARDNESS AND CHLORIDE FILTERS

The **chloride concentration (Cl-) (ppm - mg/l)** values with **pH (>7)** and **Conductivity (µS/cm)** (measured at 68°F)(20°C) must be such as to not damage the steel structures inside the oven (only water inlet B).

Therefore the characteristics of the available water must be identified in the graph given at the end of this handbook (page 99), if necessary installing at the inlet the type of filter indicated in the relevant area of the values.

The filters indicated are:

- No filter for chloride (Cl-) in the conforming area (Normal)
- Nanofilter as an accessory on request, called Water Filter.

- Osmotizer.

Make sure the water coming out the filter is inside the optimum area (Normal).

These filters also have the function of reducing the water hardness to optimum values (below 50ppm)(5°FH), and therefore also act as a water softener.

ATTENTION: Periodical checking according to the filter manufacturer's instructions is important to maintain its efficiency and avoid the risk of corrosion in the appliance.

Level C ovens are convection ovens. If water having characteristics outside those specified is used to create humidity inside the oven, there will be the risk corrosion of the compartment and that present inside it.

Carry out regular maintenance of the water softeners and filters to ensure their optimum efficiency.

To avoid damage to the appliance, after every periodical regeneration do a filter cleaning cycle without introducing water in the oven.

The manufacturer declines any liability in case of incorrect maintenance.

Important:

The use of dosing systems designed to prevent the build-up of lime-scale in pipes (i.e. polyphosphate dosing systems) is prohibited since such systems may impair the performance of the appliance.

4.2 WATER DRAIN SYSTEM

- OVEN level A -

The oven is supplied with an air-break system to prevent any backflow from the drainage system from reaching the oven's internal circuits and the cooking chamber. The presence of this system means that the drain pipe can be connected directly to the mains drainage system or routed to a floor gully with grating.

The flexible drainage hose or rigid pipe can be directed to the side or rear of the appliance if the oven is not positioned against a wall; this line must not be directed towards the front of the appliance to prevent interference with roll-in grid racks. The drainage pipe internal diameter must be no smaller than the oven drain outlet (1 1/4"), **no longer than 3 feet (1 metre)** and must resist temperatures of up to at least 212°F (100°C). Avoid restrictions in the case of flexible hose pipes, do not fit elbows on metal pipes anywhere along the drainage line. Also avoid horizontal sections in which water might collect (minimum gradient 5%).

WARNING: BLOCKING THE DRAIN IS HAZARDOUS.

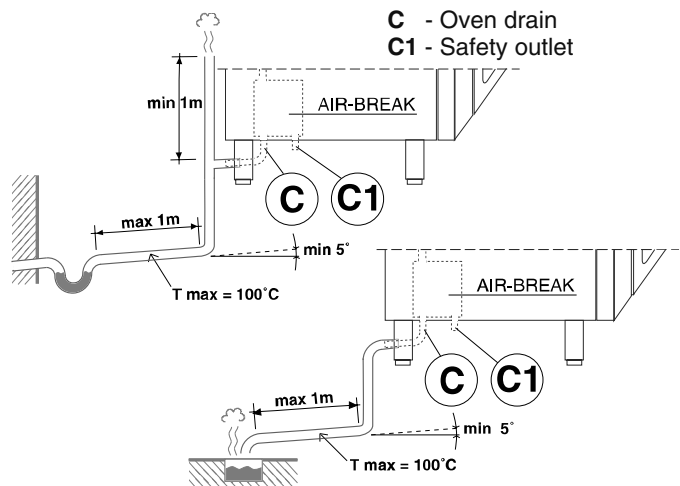

Important:

- Do not obstruct the safety outlet C1.
- Do not connect the safety outlet C1 to the drainage system.

Note:

If water comes out of the AIR-BREAK (safety outlet C1) this means the drain C is blocked. Any elimination of the obstruction **must be carried out by specialised technical personnel.**

- OVEN level C -

Connect drain fitting "C" to a drain pipe of the same diameter which is between 0.5 and 3 metres in length and is resistant to temperatures of at least 100°C. The drain pipe must be siphoned (height 80 mm) to an open drain "O" ("Air-Break") or floor grating (see Fig. 12b) in order to prevent any back-flow from the sewage system from reaching the piping inside the oven or oven chamber. Check the hoses and elbows on metal pipes for kinks or pinching along the entire drain line and make sure the drain line has a minimum gradient of 5° to prevent water from collecting inside the system.

Important: The drain system must be installed so that any vapours from the open drain do not enter the aeration vents under the appliance.

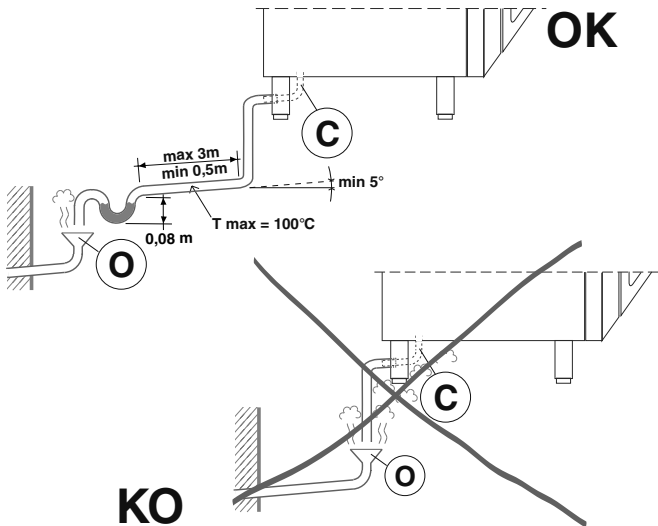
**5. SAFETY DEVICES**

The appliance is fitted with the following safety devices:

- **Fuses** (see electrical circuit diagram) located behind the control panel.

To change a fuse unscrew and remove the retainer cap and replace the blown fuse with an identically rated component; the fuse rating value is specified on the relative dataplate.

- **Oven chamber safety thermostat** with manual reset, located behind the control panel; when this device trips, convection heating power is disconnected.

Notice: CONTACT YOUR AUTHORIZED SERVICE COMPANY TO PERFORM MAINTENANCE AND REPAIRS.

- Automatic reset **thermal protection** inside the **cavity fan motor**: this device trips in the event of overheating of the cavity fan motor; this cut-out protects the appliance by disconnecting the power supply to the main PC board and an error message is display EFUN.

6. OPERATION CHECK

- Switch on the appliance in accordance with the following section "Instructions for use".
- With the aid of the Instruction Booklet, explain operation, routine maintenance, and cleaning to the user.

Important:

- Exercise due care since certain areas of the oven exterior become hot during use.
- Do not cover the exhaust outlets on top of the appliance.

7. SERVICING

All components requiring routine maintenance may be easily reached by opening the control panel, removing the left side panel, or removing the rear panel.

Danger: Live voltage is present with panels removed and unit switch on. Exercise extreme caution when work with live voltage.

NOTICE: Using any parts other than OEM original spare parts relieves the manufacturer of all warranty and liability.

8. TROUBLESHOOTING

Malfunctions may occur even when the appliance is used correctly.

Oven chamber heating not started or inefficient. Possible causes:

- Oven chamber temperature limit switch tripped
- Damaged heating elements
- Damaged heating element contactor coil
- Damaged thermostat probe showing error "EPT1".
- Damaged controller
- Fuse "F2" blown, see circuit diagram.

Steam production not started or inefficient.

Possible causes:

- Damaged heating elements
- Damaged heating element contactor coil
- Damaged controller
- Fuse "F2" blown
- No mains water supply
- Faulty boiler drainage outlet closing device
- Damaged water inlet solenoid valves (do not open)

Oven chamber temperature reading incorrect

Possible causes:

- Damaged electronic controller
- Thermostat probe damaged, dirty or interrupted, see error "EPT1".

Oven switches off

Possible cause:

- Fuse "F2" has blown due to damage of control circuit components.

Oven chamber lamp fault

WARNING: Switch off the appliance before changing oven chamber lamps.

9. LAYOUT OF MAIN COMPONENTS

(All work inside the appliance must be carried out exclusively by a trained installer authorised by the manufacturer)

Removing the control panel provides access to the following components:

Danger: Live voltage is present with panels removed and unit switch on. Exercise extreme caution when work with live voltage.

- Electronic circuit boards
- Oven chamber temperature limit thermostat
- Fuses
- Door microswitch
- Oven chamber lamp transformer
- Geared motor for the oven chamber pressure relief butterfly valve.

WARNING: Before servicing unit switch off power at the main circuit breaker and place a red tag on the breaker to indicate work is being done on the circuit.

Remove the appliance left hand side panel to gain access to all the other components.

III. INSTRUCTIONS FOR USE

Before switching on the appliance, read this instruction booklet carefully because it contains important information concerning correct use of the appliance. If you require further information about the oven's features and cooking performance, consult your local dealer.

ANY POTENTIAL USER OF THE EQUIPMENT SHOULD BE TRAINED IN SAFE AND CORRECT OPERATING PROCEDURES.

- This appliance is intended for industrial use only and is specifically designed to cook food. Any other use will be considered "improper use" and will void the warranty and manufacturer liability.
- Do not place pans or utensils on top of the oven. Avoid obstructing the fumes and steam exhaust outlets.
- Do not insert objects (eg, trays) below the bottom of the oven so as not to obstruct the holes of entry or exit of cooling air.
- Periodically the appliance should undergo a general inspection. For this purpose we recommend taking out a service contract.
- The core temperature probe is a precision instrument and must be handled with care. Avoid knocks, do not apply excessive force when inserting the probe, and do not pull on the lead (take care particularly when using roll-in racks). **The warranty does not cover damage to the temperature probe caused by improper use.**
- When using the **mixed** cooking cycle, do not exceed cooking temperatures of 392-410°F. Higher temperatures might impair the performance of the oven chamber seals.
- When placing food in the oven leave a gap of at least 1.5" (40 mm) between each pan to facilitate circulation of hot air.
- If the oven is installed near appliances that produce greasy fumes (e.g. fryer), make sure to use the **air filter** (not supplied), to be placed under the **control panel**, to protect the internal electronic components.
- During **preheating** of the oven 20 GN 1/1 or 2/1, insert the trolley (without food) to close the bottom opening between the compartment and door. This prevents steam from coming out and into the control panel with consequent damage to the electronic board.

• Do not add salt to foods when inside the oven chamber, particularly during cooking cycles with humidification.

• Do not cook with flammable liquids such as alcoholic spirits.

Attention

Cooking containers can not be inserted at a height greater than **63" (1.6m) from the level where the user operate.**

If supporting accessories other than the original ones are to be used, **do not exceed the above specified height** since this could result a **spill hazard** caused by hot cooking liquids (sauces, oil, melted fat, etc...) contained in the uppermost pans, which are not visible during handling operations.

1. OPENING THE OVEN DOOR

1.1 6- AND 10-GRID MODELS

Important! Risk of burns.

Open the door with due care when the appliance is hot.



a) Turn the door handle all the way in either direction (indifferently) to fully open the oven door.

If there is a cooking program in progress it will be interrupted.

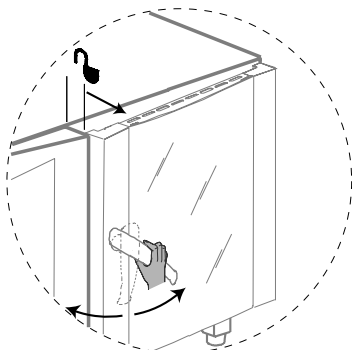

MODELS with SAFETY SYSTEM (by request)

The oven is equipped with a **safety system** to protect the user against scalding steam when the door is opened wide. Proceed as follows:

a) Turn the oven door handle clockwise as far as it will go. The door opens slightly and is arrested by the **door safety device**.

If there is a cooking program in progress it will be interrupted.

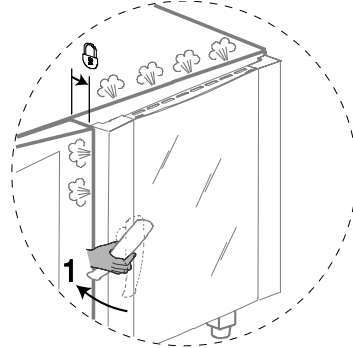

b) Turn the handle all the way counter-clockwise to open the oven door fully.

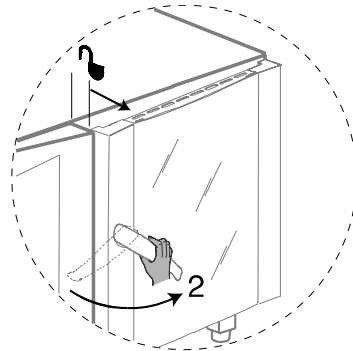

1.2 20-GRID MODELS

Important! Risk of burns.

Open the door with due care when the appliance is hot.



a) Turn the handle 90° anticlockwise to open the door fully. If there is a cooking program in progress it will be interrupted.

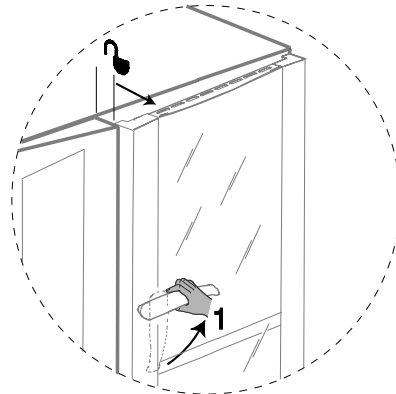

2. CLOSING THE OVEN DOOR

2.1 6- AND 10-GRID MODELS

To close the oven door press it until it locks.

2.2 20-GRID MODELS

- Turn the door handle anticlockwise as far as it will go and press the door closed against the oven.
- Keeping the door pressed closed, lock it by turning the handle to the vertical position.

3. DESCRIPTION OF THE CONTROL PANEL

3.1 INTRODUCTION

To aid understanding of the operation of the oven, find the folding double page showing the control panel for your model among those included at the back of this handbook and then open it out and keep it open while reading this section.

The following headings describe all the functions available on the various models in the range.

Some functions are shared by all models, others are available on specific models.

3.2 MAIN CONTROLS

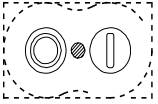

Main switch



Cooking cycle/program start/stop.

3.3 MAIN COOKING MODES

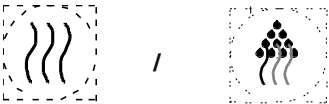

Air-convection cycle: To roast and gratin with a maximum temperature of 572°F(300°C).



Mixed cycle: superheated steam. Uses the oven chamber heaters and steam generation system at the same time to keep food soft (maximum temperature 482°F)(250°C).



Steaming cycle: ideal for steam cooking (operating temperature automatically set at 212°F)(100°C).

You can set **low temperature steam** for gentle cooking of foods in vacuum packs and for thawing (temperature from 77°F to 210°F)(25° to 99°C).

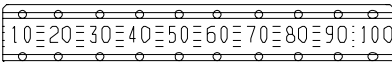

Displaying the humidity value: allows you to display the humidity level of the **air-convection, mixed** and **regeneration** cycles.



Digital thermometer/thermostat: to control the temperature in the oven chamber.

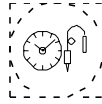

Timer to control cooking time.

Digital thermometer/thermostat: to control product core temperature.

3.4 SPECIAL COOKING MODES



Utilities

Functions useful for the type of cooking to be executed.



Pause phase: set a time in this mode to delay the start of cooking programs or to set a pause interval between two cooking cycles (e.g. for dough proving).



Regeneration cycle: gives ideal humidity conditions for rapid heating of products to be regenerated (maximum temperature 572°F)(300°C).

The regeneration program is composed of a single phase with the following characteristics:

- a special cycle with controlled humidity of 20 % (adjustable if required);
- preset temperature of 248°F (120°C)(can be altered if necessary);
- use of maximum power;
- a **preset time of 30 minutes** (adjustable if required) **and once started, remains active with door open or closed.**

DANGER: CAVITY FAN AND STEAM WILL CONTINUE TO OPERATE WHEN DOOR IS OPEN. WHEN IN REGENERATION CYCLE. OPEN DOOR SLOWLY TO AVOID THE RISK OF BURNS.



Alternatively to the set cooking time it can also accept **Cont** cooking time or the core probe.

HOLD

Cook and hold cycle: for long slow cooking, typically for meat (large piece of meat for roasting).

It can be used in combination with **convection, mixed, steam** and **regeneration** modes.

Fan operation is intermittent.

HACCP

HACCP: serves to record the cooking program in compliance with **HACCP** standards (**Hazard Analysis and Critical Control Points**). Depending on the system requested you can record cooking data on a dedicated printer or directly on a PC.



Clean Cycle: automatic or semiautomatic oven cleaning cycle (see section 7. CARE AND MAINTENANCE).



Low speed cycle (fan): for delicate cooking such as for baking cakes. Can be combined with any other cycle.



Reduced power cycle (heating): for delicate cooking such as for baking cakes. Can be combined with any other cycle.



Cooking with ECO-DELTA: for cooking large pieces of food (5kg and above, e.g. whole turkey, leg of pork, etc.).

In this cooking mode a temperature setting of between 1°C and 120°C is chosen.

In this case, cooking is moderate and long, because the CHAMBER temperature is automatically adjusted according to that inside the food (CORE PROBE), maintaining a constant difference (ECO-DELTA) between them, from start to end of cooking.

E.g:

COOKING:	START	END	
ECO-DELTA =	80°... 80...80...	80...	80°C	(set)
CORE PROBE =	10°... 11...12...	40...	60°C	(set)
CHAMBER =	90°... 91...92...	120...	140°C	(result)



Air-convection cycle with oven chamber vent open: suitable for very dry cooking cycles; allows evacuation of humidity when necessary (maximum temperature 572°F)(300°C).



Door open indicator LED.



Limescale LED: when this LED starts flashing the boiler needs to be descaled. Follow the instructions in section 7.



Boiler status LED:

- **LED off:** boiler ready;
- **LED flashing:** boiler filling or no water. **Make sure the oven water supply is working!**



Cooking parameter adjustment: allows adjustment of cooking values (humidity, temperature and time).



Automatic sequence phases: to execute a 2-phase cooking cycle switching from one phase to the other automatically (LEVEL C ONLY).

3.5 ADDITIONAL FUNCTIONS

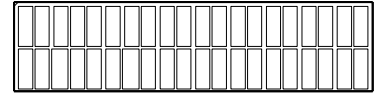
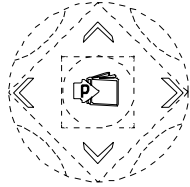

Set of controls for management of the programs library: control keys to store, edit or delete cooking programs (LEVEL A only).



Program selector : to find and select the cooking programs stored in the memory (LEVEL A only).



Manual water injection into cooking chamber: serves to boost humidity levels during the cooking cycle.



Boiler manual water draining: press this button to drain the water from the boiler.

Important! To prevent the build-up of lime-scale inside the boiler:

- Make sure the water supply corresponds with the required characteristics - see Installation.
- Always empty the boiler at the end of each day.





Rapid oven cooling: useful for passing from one type of cooking to another that requires a lower temperature; it allows the fan to run and automatic water (TS < 356°F)(180°C) injection even when oven door is open.

Important! Risk of burns.
Open the door with due care when the appliance is hot.

Before using the oven check that:

- the external safety electric switch is on;
- the water supply valve is open;
- the fumes and steam discharge outlets are not blocked.

USING THE OVEN

OPERATING LEVEL **A and C**

(C = Convect, Convection)

4. INTRODUCTION

Cooking of food is carried out by heating it and can be achieved in a specific MODE, at a specific TEMPERATURE, a specific TIME and HUMIDITY level. Therefore these parameters must be set in order to execute a COOKING CYCLE.

On this basis, the oven functions mainly by carrying out the operations shown in the following headings:

--- **SETTING THE COOKING CYCLE** ---

- SELECTING COOKING MODE
- SETTING COOKING TEMPERATURE
- SETTING COOKING TIME
- SETTING AND USING THE PROBE
- SETTING COOKING HUMIDITY
- COOKING CYCLE START

There are also several other headings illustrating support functions such as:

- MANUAL CYCLE (CONTINUOUS COOKING)
- UTILITIES
- COOKING PHASES IN AUTOMATIC SEQUENCE

Lastly there is a heading describing the storage of cooking cycles as recipes (e.g. CHICKEN RECIPE) or programs, entitled:

- STORING RECIPES OR PROGRAMS

4.1 SWITCHING THE OVEN ON

To switch the oven on press button **I** of this switch:

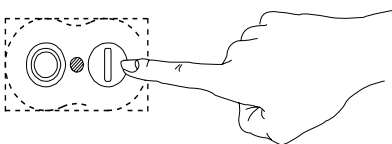

The following will occur:

- the relative button lights up;
- the control panel switches on and various functions flash;
- the Thermometer/Thermostat **TS** display shows the oven chamber temperature;
- the oven chamber lamp switches on;

- boiler in **filling** phase (flashing LED);

- boiler **ready** (LED off)

4.1.1 SWITCHING THE OVEN OFF

To switch the oven off press button **O** of this switch:

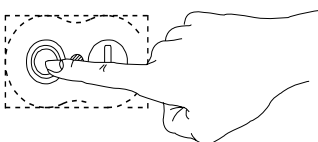

4.2 SELECTING THE CONTROLS (MANUAL or AUTOMATIC)

The control panel is divided in two parts, one for MANUAL controls and the other additional section for AUTOMATIC controls.

MANUAL controls

AUTOMATIC controls

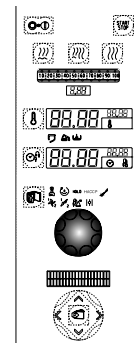
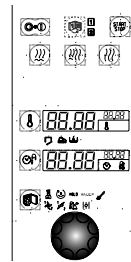

Use one of the two control modes according to your cooking needs in the level **A** oven.

The level **C** oven is equipped exclusively with MANUAL controls.

4.3 MANUAL CONTROLS

SETTING THE COOKING CYCLE

4.3.1 SELECTING COOKING MODE

After SWITCHING THE OVEN ON select one of the following cooking modes by pressing the relative illuminated button (button lights up):



Set the cooking parameters as indicated in the following paragraphs.

Note:

The temperature and time displays flash for 5 seconds awaiting setting; if no value is set, the preset value (default value) will remain stored, which stops flashing.

4.3.2 SETTING THE COOKING TEMPERATURE

Press the following illuminated button (button lights up) to select cooking temperature:



The relative **DISPLAY** will show the TEMPERATURE in the CHAMBER (large numbers) and the TEMPERATURE TO BE SET (small numbers - flash for 5 seconds).

E.g.: 93°F
CHAMBER
TEMPERATURE



E.g.: 392°F
COOKING
TEMPERATURE

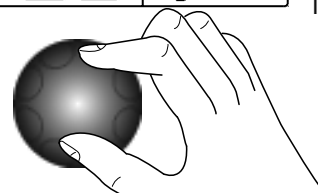

Turn the knob clockwise (to increase the value) or counter clockwise (to decrease the value) to set the desired COOKING TEMPERATURE in the small DISPLAY.

After 5 seconds the COOKING TEMPERATURE stops flashing to indicate that it has been SET.

Note

The temperature of the **steam** cycle is automatically set at 212°F(100°C). You can, however, set **low temperature steam** from 77°F to 210°F(25° to 99°C) by turning the knob.

Note 2

With the COMBI cycle it is possible to do a **dough proving** cycle by setting a temperature below 122°F(77 to 121°F), 50°C(25 to 49°C).

When the dough proving cycle is set as a first stage **compartment preheating** is excluded.

4.3.3 SETTING THE COOKING TIME

Press the following illuminated button (button lights up) to set cooking time:



The relative DISPLAY will show the TOTAL REMAINING TIME of the cooking cycle (large numbers) and the TIME TO BE SET (small numbers - flash for 5 seconds).

E.g. : 1 h 30'
TOTAL REMAINING TIME

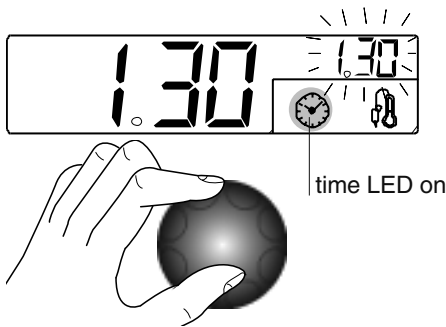

E.g.: 1 h 30'
CURRENT REMAINING TIME

Turn the knob clockwise (to increase the value) or counter clockwise (to decrease the value) to set the desired cooking TIME on the small DISPLAY.

After 5 seconds the COOKING TIME display stops flashing to indicate that it has been SET.

Note:

In this case there is only one cooking cycle or phase so CURRENT remaining time and TOTAL remaining time will coincide.

4.3.4 SETTING AND USING THE PROBE (TO MONITOR PRODUCT CORE TEMPERATURE)

This temperature probe allows high precision control of the temperature reached at the core of the product being cooked so that the desired value can be set and the cooking cycle stopped automatically when the product core reaches the set temperature.

Important: The temperature probe is a precision instrument and must be handled with care. Avoid knocks, do not apply excessive force when inserting the probe, and do not pull on the lead (take care particularly when using roll-in racks). The guarantee does not cover damage to the core temperature probe caused by improper use.

1) Switch on the oven

Remove the product core temperature probe "C" from its seat "D" and insert it into the product without forcing it and making sure that the tip (sensitive element) is located in the proximity of the centre of the product.

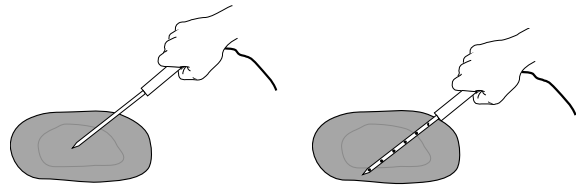
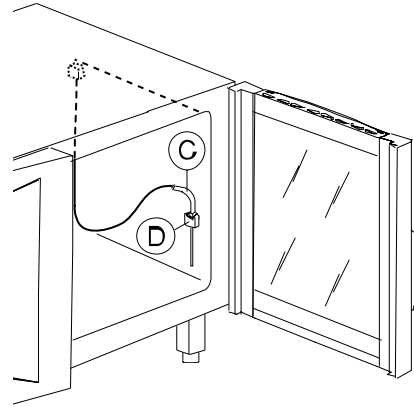

LEVEL C
probe with 1 sensor

LEVEL A
MULTIPOINT probe with 6 sensors

The LEVEL A oven is equipped with a MULTIPOINT probe with 6 sensors located at intervals along the wand, enabling the correct temperature to be read in the centre of the product even if the probe tip is not positioned at the product core.

Close the oven door.

2) Select the desired cooking cycle and set the cooking temperature on thermostat TS.

Important: do not set the cooking time on Timer TM.

3) Set the TEMPERATURE of the CORE PROBE by pressing the following illuminated button **twice** (button lights up):



The relative DISPLAY will show the PROBE TEMPERATURE (large numbers) and the TEMPERATURE TO SET (small numbers - flash for 5 seconds).

E.g.: 135°F
CURRENT PROBE TEMPERATURE

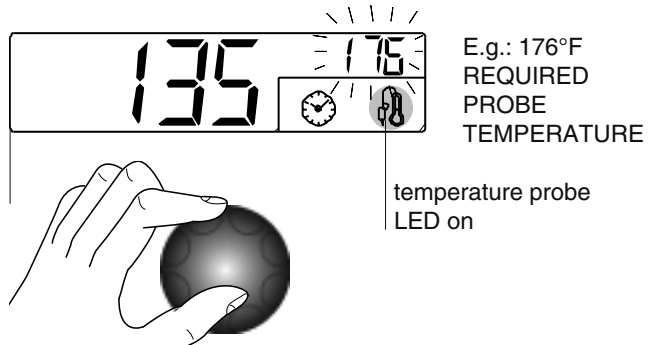

E.g.: 176°F
REQUIRED PROBE TEMPERATURE

Turn the knob clockwise (to increase the value) or counter clockwise (to decrease the value) to set the DESIRED PROBE TEMPERATURE on the small DISPLAY.

After 5 seconds the DESIRED PROBE TEMPERATURE stops flashing to indicate that it has been SET.

Note:

Press the button again to switch from the PROBE function to the TIME function: the relative LED on the DISPLAY will light up.

4) **Start the cycle.** Press the **Cooking Start/Stop** button.

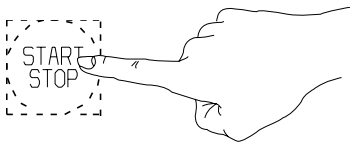

5) **Stop the cycle.** When the required product core temperature reaches the set temperature the oven stops automatically as described in heading 4.3.7 STOPPING THE COOKING CYCLE and elapsed cooking cycle time is shown on the large DISPLAY.

6) **Deactivating core probe mode.** (Possible only with no cooking cycle active). Set a cooking time on Timer **TM**. Probe cooking mode is also deactivated when the oven is switched off.

At the end of the cycle total cooking cycle TIME is shown on the large DISPLAY.

4.3.5 SETTING COOKING HUMIDITY

(Only in **CONVECTION**, **MIXED** and **REGENERATION** cooking modes)

Attention

When switching on the oven after several hours in which it has not been used, wait about 20 seconds (LAMBDA probe stabilisation time) to ensure accurate reading of the HUMIDITY value.

Note

To set humidity in AIR-CONVECTION cooking mode press the relative cycle selection button twice.

After selecting AIR-CONVECTION or MIXED cooking mode the large DISPLAY (LEVEL **A** only) will show **OVEN CHAMBER HUMIDITY** and the small display (LEVEL **A** 1%...100% and **C** 1/10...10/10) will show the humidity to be SET (flashes for 5 seconds).

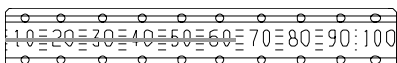

E.g.: 60 %
OVEN CHAMBER HUMIDITY

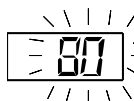

E.g.: 80 %
COOKING HUMIDITY

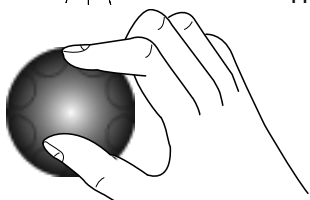

Turn the knob clockwise (to increase the value) or counter clockwise (to decrease the value) to set the desired COOKING HUMIDITY on the small DISPLAY.

After 5 seconds the COOKING HUMIDITY value stops flashing to indicate that it has been SET.

4.3.6 STARTING THE COOKING CYCLE

- make sure the oven door is closed;
- press the luminous start cooking button, which will light up (light FLASHING), for COMPARTMENT PREHEATING;

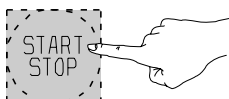

PrEH
Start COMPARTMENT PREHEATING
(light FLASHING)

The displays will show:

- **HU** humidity inside the compartment;
- **TS** automatic compartment preheating (PrEH). To skip preheating press the START button again.
- **TM** time remaining for end of cooking / **PRB** core probe temperature.

Note: In TIMED cooking, during preheating the set cooking time remains unchanged (COUNT-DOWN not activated).

At the end of preheating the message **LOAD** appears on the display **TS**:

- open the oven door and load the food.
- close the door, and the message **Strt** (START) appears on the display **TS**
- press the start cooking luminous button again; it will light up (FIXED light);

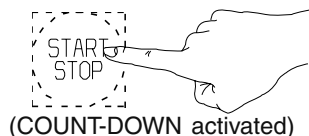

Start COOKING CYCLE
(light FIXED)

(COUNT-DOWN activated)

Note:

No cooking cycle will be available (steam, mixed, air-convection or regeneration) until the boiler is ready (boiler LED switches off - see heading 4.1).

During this interval the time count will not start and the **Start cooking** button will flash (the same will occur when the oven door is opened).

Important! Risk of burns.

Open the door with due care when the appliance is hot.



4.3.7 STOPPING THE COOKING CYCLE

When the set time has elapsed the cooking cycle will stop automatically and the appliance's audible alarm will emit a continuous beep.

Open the door and remove the product.

Important! Risk of burns.

Open the door with due care when the appliance is hot.



Note:

The audible alarm can be muted by performing any operation on the control panel or by opening the door. To stop the cooking cycle **manually** press the **cycle Start/Stop** button and keep it pressed for **two** seconds.

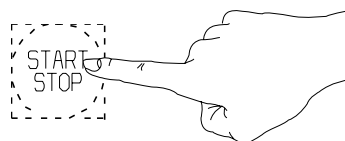

If this button is pressed for less than 2 seconds it will produce no result.

To repeat the last cooking cycle with identical parameters press the **Start/Stop** button again.

4.3.8 MANUAL CYCLE (CONTINUOUS COOKING)

Manual cooking cycles can be set by excluding the timer. Follow the instructions in heading 4.3.2 SETTING THE COOKING TIME until the display shows the word "**cont**", i.e. **continuous** cooking mode.



In this case the cooking cycle must be stopped manually by holding down the **Start/Stop** button for two seconds or by switching off the oven.

4.3.9 UTILITIES

- Switch on the oven by pressing button **I**.
- Set a cooking cycle for the following UTILITIES:

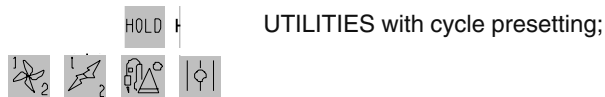

this is not necessary for the other utilities as they are already specific cycles.

- Press button **U** (UTILITY):



- The green UTILITY LEDs will light up and one will be flashing.

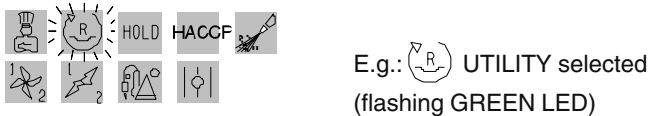

- Turn the knob clockwise or counter clockwise to select the utility required - the relative LED will flash (flashing GREEN color).
- Press button **U** until the flashing LED relative to the UTILITY selected changes colour (flashing ORANGE color).
- Wait a further 5 seconds for the LEDs relative to the selected utilities to illuminate steadily (steady ORANGE color).
- Finally, start the cycle by pressing the START/STOP button.

A complete description of the different UTILITIES available is included in heading 3.4 SPECIAL COOKING MODES (page 20).

Note:

If the **UTILITIES** are not used for 7 seconds they are **automatically cut out**, signalled by the relative button switching off.

- To **cancel one** of the following preset **UTILITIES** (ORANGE steady):



press the **U** button and turn the knob to select it so that it flashes (ORANGE flashing).

Press the **U** button again so that the UTILITY changes colour (GREEN flashing) and is thus cancelled.

- To **cancel** the other **UTILITIES** set another cooking cycle.

In case of **cycle already started**, stop it, keeping the START/STOP button pressed for 2 seconds before cancelling the UTILITY.

4.3.10 COOKING WITH TWO PHASES IN AUTOMATIC SEQUENCE

(LEVEL C ONLY)

Level B ovens allow the execution of cooking cycles composed of two sequential phases. For example:

- Phase 1:
 - air-convection 200°C
 - probe 70°C
- Phase 2:
 - mixed cycle 220°C
 - 40 minutes

The oven switches automatically from phase 1 to phase 2. To set a two-phase cycle proceed as follows:

- 1) Switch the oven;

- 2) Set the desired cooking mode, oven chamber temperature, and cooking time (or, alternatively, core probe temperature) as described in this handbook.

- 3) Press the "1-2" / "PHASE" button:

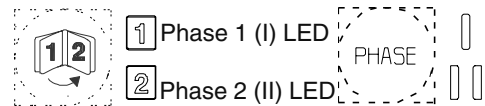

the phase 2 LED switches to RED (active phase) while the phase 1 LED is GREEN (inactive phase); at the same time the **cooking modes** button LEDs start flashing again to request a new setting for phase 2.

- 5) Select:

- phase 2 cooking mode;
- phase 2 oven chamber temperature;
- time (or core probe temperature) relative to phase 2;

- 6) The two-phase cooking cycle has now been set. Place the product to be cooked in the oven and press the START/STOP button to **start the cooking cycle**.

The cooking cycle will start from phase 1 (phase 1 LED RED) and **switch automatically** to phase 2 (phase 2 LED RED) when the first phase terminates.

When the oven switches from phase 1 to phase 2 the operator will be alerted by a brief audible signal.

When phase 2 is terminated the cooking cycle will stop automatically as already described.

4.3.11 Delta Cooking

This is an advanced method of cooking, by which the oven chamber temperature varies in function of the core temperature of the food.

The operator is able to select a **delta** value between **1°C < 120°C**, we recommend using between **20°C < 70°C**. The chamber temperature will be adjusted to automatically remain above the rising core temperature exactly by the set value.

This type of cooking is ideally suited to large joints of meat.

How to use it: Manual cooking mode.

- 1) Select the cooking mode, Ex. **Combi**.
- 2) Set a target core temperature value,
- 3) Go into **advanced utility functions (Bottom row on Control Panel)** and select



At this point you will see on the oven temperature display **25 °C** which is a **Delta** value (you can change it by highlighting the temp area and turning the dial to reach the desired Delta – for example **50°C**.)

Close the oven door and press the start button to activate the cooking cycle.

The core temperature of the meat may be for example **14 °C** when the cooking cycle is started, the oven temperature will go to **75°C**, (**50°C above core temp**), and then keep rising as the core temperature rises, maintaining a difference of **50°C** (As the core temperature of the meat rises by one degree so too does the oven temperature). The two temperatures will displayed in the lower line on the display.

If you selected a final core temperature of for ex. **67 °C**, the final oven chamber temperature will be **117 °C** at the end of the cooking cycle.

This cooking method is much slower than the 'normal' way of cooking but the benefits are higher yields and better quality.

4.4.2 SETTING THE TIME, DATE AND DELAY START

- TIME and DATE -

Proceed as follows to set the TIME and DATE:

- 1) Switch on the oven by pressing button I.
- 2) Hold down button TM until you hear a beep and the HOUR digits start flashing.



- 3) Turn the knob (while the hour digits are flashing) clockwise or counter clockwise to set the current hour.
- 4) Press button TM and set the MINUTES in the same way as for the hours (step 3).

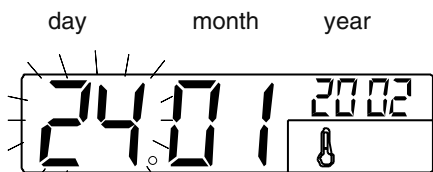

E.g.: 24-01-2002
CURRENT DATE

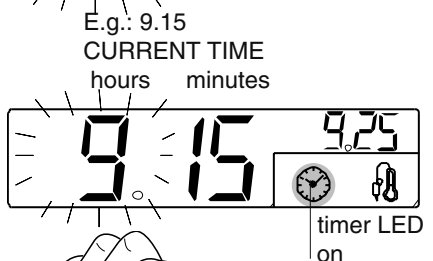

E.g.: 9.25
DELAY START
(10 minutes)

- 5) Press button TM again to set the DATE (shown on the TEMPERATURE DISPLAY) in the same way as the HOURS (previous step 3).
- 6) Press button TM to set the MONTH and YEAR repeating the procedure used to set the date.

- DELAY START- (delayed start of cooking cycle)

Once the TIME and DATE have been set (see previous heading) carry out these operations:

- 1) Press button P (program) and select the required recipe or program:

program	A	O	P	r	e	H	e	a	t	S	t	e	a	m	i	n	g
selected	P	:	M	E	N	U											

- 2) Press button P and select P: ADD DELAY.

SELECTED ITEM	A	O	P	r	e	H	e	a	t	S	t	e	a	m	i	n	g
	P	:	A	D	D	E	L	A	Y								

- 3) Press button P: a flashing letter D (Delay Start) will be displayed.

LETTER "D"	A	O	D	1													
FLASHING	P	:	M	E	N	U											

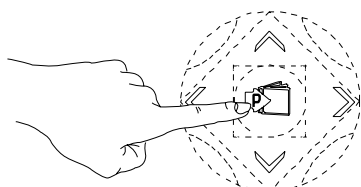

- 4) Set the required START time (shown in small numbers on the TM timer display) and press the START/STOP button. The cycle will start at the time set in the DELAY START option and the letter D will flash in alternation with a dot to remind the user that this function is active.

4.4.3 EDITING THE SET PARAMETERS

With the cooking cycle **blocked, started** or **stored**, use the relative commands to edit the following parameters:

- 1) cooking mode;
- 2) cooking temperature TS;
- 3) cooking time TM;
- 4) probe temperature PRB (in alternative to cooking time).

Note:

- When you edit the parameters of a STORED cooking program (during a cooking cycle) an asterisk "*" will appear alongside the program number.
- Editing the parameters of a STORED cooking program overwrites the original parameters with the new ones.

Proceed as follows if the oven is performing a **cooking cycle composed of various phases** and you wish to edit the parameters of the next phase to be executed:

- a) Press the START/STOP button to stop the current cooking cycle.
- b) Press the (>) button to display the phase you intend to edit, and enter the new values.
- c) Press the START/STOP button to resume the current cooking cycle.

4.4.4 STORING RECIPES OR PROGRAMS

RECIPES or programs (cooking cycles) can be stored with a sequential number and a descriptive name to assist in retrieval.

E.g.: -01----- (RECIPE n°)
CHICKEN (RECIPE description)
-02-----
POTATOES

Once a RECIPE (composed of one or more cooking phases) has been set using the **MANUAL** or **AUTOMATIC CONTROLS** carry out these operations:

- 1) Press button P

phase 1 flashing				1													
selected item	P	:	M	E	N	U											

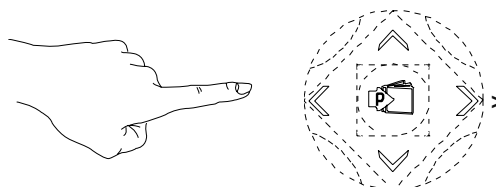

- 2) Press button P again to open the menu and select the MEMORIZE RECIPE option.

phase 1 flashing				1													
selected item	P	:	M	E	M	O	R	I	Z	E	R	E	C	I	P	E	

- 3) Press button P to start saving data, the SELECT NUMBER option is displayed.

displayed item	A	2	1														
	P	:	S	E	L	E	C	T	N	U	M	B	E	R			

4) Press button **P** to select the recipe number.

NUMBER OF RECIPE	01																		
SELECTED	P:	C	O	N	F	I	R	M											

5) Select (while flashing) the RECIPE number in which you want to store the cycle you have just set up and confirm the number by pressing button **P**.

6) Select the EDIT NAME option

selected item	01																		
	P:	E	D	I	T	N	A	M	E										

7) Press button **P**, the dash "-" flashes.

DASH FLASH.	01																		
selected item	P:	C	O	N	F	I	R	M											

8) Select the first letter required.

9) Press button (>) to enter the next letter as described in point 8 and so on for the rest of the letters to complete the description of the program (to DELETE a letter select the space).

10) Press button **P** to confirm the RECIPE NAME (e.g.: COOKING CHICKEN).

NAME RECIPE	01	C	O	O	K	I	N	G	C	H	I	C	K	E	N					
selected item	P:	C	O	N	F	I	R	M												

11) Select the SAVE RECIPE option and press button **P** to save.

NAME OF RECIPE	01	C	O	O	K	I	N	G	C	H	I	C	K	E	N					
selected item	P:	S	A	V	E	R	E	C	I	P	E									

12) Press button **P** again for a few seconds to exit the programs (or select the EXIT option and then confirm).

Note: it is not compulsory to save programs in sequence (e.g. 01-02-03, etc.): you can assign programs with any number from 0 to 99. Numbers already used for another program are marked with a dot alongside, while unoccupied numbers are shown without a dot. 0

4.4.5 RECIPE OR PROGRAM SEARCH

There are two methods for finding a recipe or program:
 - SEARCH BY NUMBER (recipe or program number)
 - SEARCH BY NAME (recipe or program name)

Note:

When setting a cooking cycle, press the P button twice and select the menu item FIND BY NUMBER OR FIND BY NAME, or press P, holding it down for a few seconds to exit cycle setting and proceed a follows.

SEARCH BY NUMBER

Press button **P** and select the desired recipe or program.

SEARCH BY NAME

Press button **P** to open the list of recipes or programs.

program	AO	Low	Temperature																
selected	P:	M	E	N	U														

Press the button **P** and select the item SEARCH BY NAME

program	AO	Low	Temperature																	
selected	P:	S	E	A	R	C	H	B	Y	N	A	M	E							

Press button **P** to begin the search and select the **first letter** of the name of the desired recipe, e.g. G (GOOSE).

letter G

flashing

A	O	G																	
P:	C	O	N	F	I	R	M												

Press the button **P** to confirm this letter, the first recipe or program starting with the letter G appears on the display.

first recipe

with letter G

14	G	A	M	M	O	N													
P:	M	E	N	U															

Select the name of the **desired recipe** from those beginning with the letter G.

desired recipe

selected

15	G	O	O	S	E														
P:	M	E	N	U															

4.4.6 USING PRESET PROGRAMS

Undeletable preset programs provide several standard service functions.

The oven is supplied with the following preset programs:

LOW TEMPERATURE COOKING (EFS-LTC)

Cooking at low temperature is a specific cooking procedure especially for beef, e.g. prime rib, beef fillet, top round, tenderloin, but also for other meat items like veal, lamb, venison, turkey, duck, pork, etc

The meat cuts can be: strip loin, shoulder, leg, saddle, T-bone steak, rump, fillet, chops, etc.

The EFS-LTC is a preset, fully automatic program to obtain matured, tender and uniform cooked food.

The program comprises 4 main phases:

PREHEAT, SEARING, MATURE, HOLD.

Set the program as indicated below for the pre-sorted programs. When the word LOAD appears on the large display, after the PREHEAT phase (If necessary change the already set cooking chamber temperature) PLACE the food in the oven and insert the 6 Point Multi Sensor, core probe.

(If necessary change the already set probe temperature).

Close the door and start the cycle by pressing the START button again.

The SEARING (sealing of the food by dry heat) phase starts, followed by the suddenly Cool Down for subsequent slow cooking; in the MATURE phase (responsible for tenderising the meat) the relevant duration flashes on the large display of the core probe (press any button and the duration disappears).

This is followed by the final HOLD phase to keep the food on a certain temperature.

The entire LTC cycle (including the HOLD phase) can last for a max. of 24 hours.

One or more phases can be skipped, going to the next phase (see SKIP PHASE in par. 4.4.1 AUTOMATIC SEQUENTIAL MULTIPHASE COOKING); this is useful, for example, when cooking is started (SEARING phase) with another appliance (e.g. fry top) and is to be completed in the oven (MATURE and HOLD phases).

The MATURE phase cannot be skipped; this means that if only the HOLD phase is to be used just set the relevant UTILITY (see par. 4.3.10 UTILITIES).

Major advantages:

- Excellent food quality.
- Standardized procedure LTC guarantees repeatable results year-in - year-out.
- Typical roast aroma, juiciness from centre to the rim.
- Uniform colour and perfected evenness in the degree of doneness.
- Fast maturing process - time saving and use of fresh cut.
- Significant less cooking shrinkage, 5-8 % (depend on food quality and selected core temperature).
- Remarkable gain of portions for selling.

- Dramatic energy-saving due to the intelligent EFS - LTC program.

CLEANING SYSTEM

This system executes an automatic oven chamber cleaning procedure using suitable detergents according to the level of soil detected; the program has four different cleaning cycles.

CLEAN 1 Soft (light)

For fresh soil deriving from low fat cooking (e.g. after a STEAM cooking cycle)

CLEAN 2 Medium (normal)

If the oven chamber is only moderately soiled and after cooking fatty foods.

CLEAN 3 Strong (intensive)

If the oven chamber is very dirty due to cooking of high fat foods (e.g. roasted chicken, sausages).

CLEAN 4 X-Strong (super intensive)

For heavy grime resulting from very high fat foods (e.g. roasted chicken, sausages) also with dry residues (baked-on food).

F00...---> F19... (recipes)

These are the 20 pre-stored recipes of the main international dishes.

For further information see the relative recipe book.

Proceed as follows to use preset programs:

Note 1:

Before cleaning the compartment with the CLEANING SYSTEM remove the **grease filter** (if present).

The CLEANING SYSTEM cycle **will commence** when the temperature automatically reaches **70°C in the oven chamber**.

Before carrying out a CLEANING SYSTEM cycle make sure the containers (located under the control panel) are supplied with cleaning products of the required type: refer first to section 7. CARE AND MAINTENANCE.

Warning:

In case of complete emptying of the detergent and/or rinse aid containers or emptying of their supply tubes, the **CLEANING SYSTEM** cycle must be started after firstly doing the CLEAN 1 cycle, then the same or other cycles. This operation allows the pipes to be refilled with the appropriate liquids and the cleaning cycles to be done correctly.

If the **CLEANING SYSTEM** is not used for long periods, it is necessary to do a cleaning cycle (CLEAN 1) with water instead of detergent and rinse aid before and afterwards, to flush the respective supply pumps.

Note 2:

When setting a cooking cycle, press the **P** button twice and select the menu item FIND BY NUMBER OR FIND BY NAME, or press **P**, holding it down for a few seconds to exit setting and proceed as follows.

- 1) Press button **P**, program **A0** flashes

program

A0	Low	Temperature																	
P:	M	E	N	U															

selected

the message **A0 Low Temperature** appears on the DISPLAY.

- 2) Select the desired program or go to step 3).
- 3) Press START/STOP to start the **A0 Low Temperature...** cycle.

To **exit, edit, skip phase**, see the paragraphs of the normal programs.

4.4.7 DELETING A RECIPE OR PROGRAM FROM THE MEMORY

- 1) Press button **I** to switch on the oven.
- 2) Press button **P**.
- 3) Select the recipe or the program to be deleted.
- 4) Press button **P** and select the CLEAR RECIPE option.

RECIPE NAME

01	COOKING	POTATOES																	
P:	C	L	E	A	R	R	E	C	I	P	E								

selected option

- 5) Press button **P** to remove the recipe or program from the memory.

RECIPE NAME

01	COOKING	POTATOES																	
P:	C	O	N	F	I	R	M												

selected option

- 6) Press button **P** again and hold it down for a few seconds to exit the programs.

4.4.8 PASSWORD

The **PASSWORD** function must be enabled by changing several parameters; for that purpose request the assistance of our After-Sales Service.

The **PASSWORD** allows the following functions to be locked in order to limit oven use (one or more by request):

- Disables the temporary modification of automatic programmes, including the special PreHeat, Low Temperature cycles and Recipes.
- Manual cooking cycles are made unusable.
- Prevents final modification, saving or cancellation of the automatic programmes.

Once the **PASSWORD** is enabled, the oven is locked (after switching on) against the use of the above functions; a password must be entered to unlock it.

To **enter** a password:

- 1) press button twice **P** and select the item **PASSWORD**, press **P** again, and the display shows:

_____***** factory-set oven password
(8 characters formed of 8 empty spaces)

- 2) Press **P** (oven unlocked) and select **CHANGE PASSWORD** with the arrow button "v" (down).

3) Press **P**, the item **New PASSWORD** appears, enter the password (alphanumeric 8 characters or less) like entering the name of a recipe (see par. 4.4.4 **STORING RECIPES** or **PROGRAMMES**).

- 4) Press **P**, the item **CONFIRM PASSWORD** requests confirmation of the password entered by typing it again, then press **P**. After a short beep signalling successful operation, or a long beep if failed, the oven goes to the initial switching on status and is thus unlocked. To lock it again, just switch it off.

To **change** a password repeat the previous operations from point 2). To quit the menu, if the **PASSWORD** is not known, switch the oven off and then on again.

5. INFORMATION AND ERROR CODES

These codes may appear on the time display.

INFORMATION codes

Codes indicating a value, function, or state.

CIn - CLEANING SYSTEM program switched on.

CInt - Semiautomatic cleaning program switched on.

cont - Unlimited time setting.

cool - Oven cooling on.

End - End of a cycle or function.

FILL - Boiler filling. (Ensure water supply tap/cock are open).

LOAd - Place the food in the oven.

oPEn - Boiler discharge valve opening.

PrEH - (TIME **TM** / **PRB** DISPLAY)Boiler preheating.

PrEH -(COMPARTMENT TEMP. DISPLAY **TS**) Automatic compartment preheating.

Soap - Detergent. Spray a suitable product on the surfaces to be cleaned as indicated in point 4) of the semiautomatic chamber cleaning cycle (see par. 7. CARE AND MAINTENANCE).

Strt - Press the START button to start the program.

Stby - CLEANING SYSTEM cleaning standby time.

ERROR codes

Codes indicating the need to call technical service

EH20 - Water supply pressure too low for CLEANING SYSTEM (pressure requirements from 1.5 to 2.5 bar)

EFUN - Fan automatic reset thermal switch device. UP appears on the small DISPLAY with reference to the single fan (6-10 GN) or upper fan (20 GN) of the chamber and DO in reference to the lower fan (only 20 GN).

E--- - Non-compliance with a parameter requirement (number of parameter appears in place of dashes "—").

Ept1 - Chamber sensor interrupted or short-circuited.

Ept2 - Boiler sensor interrupted or short-circuited.

Ept3 - Probe sensor interrupted or short-circuited.

Ept4 - Bypass sensor interrupted or short-circuited.

Ept8 - Electronic controller temperature sensor damaged.

ESCH - Malfunction of commands control circuit cooling devices.

Etub - Boiler overtemperature (257°F)(125°C) warning.

Etuc - Chamber overtemperature (608°F)(320°C) warning.

EFLP - Fault in chamber steam discharge motor-operated valve.

ETC - Tripping of chamber temperature limiter.

ETB - Tripping of boiler temperature limiter.

IMPORTANT!

If an error code is displayed during a cooking cycle, the oven emits a continuous audible warning signal and the cooking cycle is interrupted.

In this case the oven can be used only in cooking modes that do not involve the conditions that generated the error.

Notify your Technical Service Center of the alarm code displayed.

6. SWITCHING OFF IN THE EVENT OF A FAULT

If the appliance malfunctions, switch off as follows:

- Disconnect the main circuit breaker of the appliance and close the water valve.
- Contact your authorized service company to perform maintenance and repairs.

7. CARE AND MAINTENANCE

- At the end of each day clean the oven interior with an oven cleaner, following the product supplier's directions.
- Do not wash the appliance with water jets.
- Do not clean steel surfaces with products containing chlorine (bleach, hydrochloric acid etc.) even diluted.
- Do not use corrosive substances (e.g. muriatic acid) to clean the floor under the appliance.

The appliance has an automatic compartment cleaning programme called CLEANING SYSTEM; for its use see par. 1.4.3 USING PRESTORED PROGRAMMES for LEVEL A, whereas for LEVEL B and C see below.

The CLEANING SYSTEM program uses detergent and rinse aid. Therefore, fill the DETERGENT container - max. 5 litres (on the RIGHT with RED cap) and the RINSE AID container - max. 1,2 litres (on the LEFT with BLUE cap) located under the control panel:

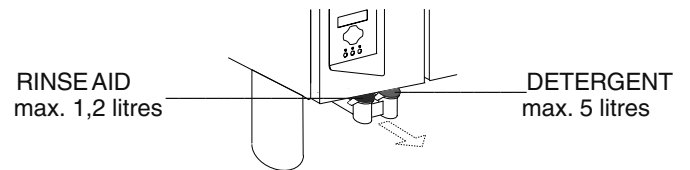

Use the following cleaning products:

- ECOLAB "Oven Cleaner Power" detergent (**not** in Gel).
- ECOLAB "Oven Rinse Power" rinse aid (**not** in Gel).

NB:

Cleaning of the oven chamber is not ensured if a different type of detergent or rinse aid from that specified above is used.

Do not use detergent or rinse aid powder **dissolved in water** as it could damage the internal components of the appliance.

Independent of the oven, the detergent and rinse aid tanks must not be placed higher than the appliance support surface.

The oven features a UTILITY to perform a automatic or semiautomatic oven chamber cleaning cycle. Proceed as follows. In the level A oven, carry out the AUTOMATIC cleaning cycle by following the instructions in par. 4.4.6 CLEANING SYSTEM.

----- AUTOMATIC (C) -----
and SEMIAUTOMATIC (A-C) cycle

1) - Remove any large food remnants using a water jet.
Do not use the spray shower or water jets to quickly cool the compartment and the inside glass of the oven door.

2) - Set the following UTILITY as described in heading 4.3.9 UTILITIES:



3) - Select one of the following wash cycles by turning the knob on the display TS:

CLNT (semiautomatic) (level **A-C**)

CLN1...2...3...4 (automatic) (level **C**) only for the description of these cycles see CLEANING SYSTEM in par. 4.4.6.

4) - Press the following button to confirm the selection



5) - Press the START/STOP button to start the cycle.

———— SEMIAUTOMATIC Cycle only (A-C) ————

The cycle **will commence** when the temperature automatically reaches **100 °C in the oven chamber**.

6) - The 1st cleaning phase (STEAM cycle) ends after 5 minutes, as signalled by the audible alarm.

7) - Open the oven door and spray the surfaces to be cleaned with a suitable cleaning product.

8) - Close the oven door. On the **TS DISPLAY** the 120 second pass, to allow the degreasing agent to perform its action. At the end of the degreasing phase the 2nd cleaning phase (STEAM cycle) lasting 10 minutes starts, after which the alarm sounds (cycle finished).

9) - Open the oven door and rinse the interior of the chamber.

To facilitate the oven chamber cleaning procedure, remove the guides for roll-in racks located at the bottom of the cooking chamber and open the air intake wall.

• To open the cooking chamber **air intake wall A** (Fig. 2) follow these instructions:

- switch off the oven and disconnect the appliance from the electrical power supply;
- insert the tip of a screwdriver in opening B and pry inwards towards the oven (1) to open the side panel by disengaging it from the pins B1 at the back.

To **remove** the air intake wall **completely** follow these instructions:

- unscrew nut C1 with a hex wrench (2).
- lift (3) the air intake wall to disengage it (4) from the lower pin C of the oven chamber;
- lower (5) the wall to disengage upper pin D and then withdraw the wall completely (6).

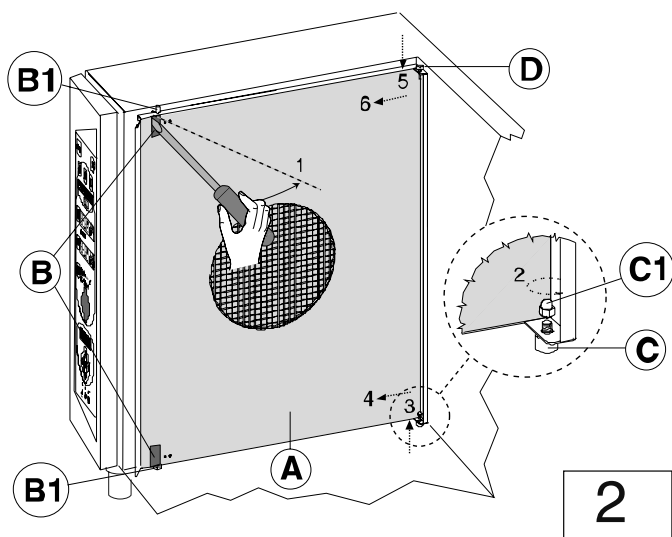

To refit the air intake wall, repeat the steps in reverse order and retighten nut C1.

- If present, clean the oven compartment **grease filter** (not supplied) at least every three cooking cycles.
- If present, clean the **air filter** (not supplied) at least once a month, removing it from under the **control panel**.

Failure to clean the filter may affect its performance and impair cooking.

- Each day wash the stainless steel surfaces with lukewarm

soapy water and then rinse and dry thoroughly.

- When cleaning stainless steel, never use abrasive tools such as steel wool, wire brushes or scrapers, since they may leave ferrous particles which will promote rusting on the steel surfaces.
- If the appliance is not to be used for long periods, proceed as follows:
 - Disconnect the electrical power supply and close the water valve;
 - Using a cloth soaked in petroleum jelly, vigorously rub the stainless steel surfaces to apply a light protective film;
 - Periodically air the place of storage.

7.1 PERIODICAL MAINTENANCE OF THE BOILER

- The build-up of lime-scale inside the boiler is signalled by illumination of the LED shown below.



When this LED illuminates the boiler must be descaled.

The manufacturer declines all liability for failure to clean the boiler when necessary. Moreover, the repair or replacement of scale-damaged parts is not covered by the guarantee if the characteristics of the water supply do not comply with those stipulated (see corresponding paragraph).

The boiler may be descaled using either:

- pure vinegar (100%);
- or
- a chemical descaler (as instructed below).

The oven must be switched on prior to descaling the boiler.

7.1.2 VINEGAR CLEANING METHOD

- 1) Close the water supply valve.
- 2) Empty the boiler by pressing the drain button



3) Close the boiler drain after one minute by pressing the above button.

4) Remove the plastic cap from the boiler filler pipe and pour in 8 litres (6-10gn) or 16 litres (20gn) approx. of pure vinegar.

5) Open the water cock.

6) Run a "steam" cycle for 20 minutes.

7) Switch off the oven and wait 60 minutes.

8) Restart the oven in steam mode for a further 10 minutes.

9) Switch off the oven again and wait 60 minutes.

10) With the water cock open, re-open the drain outlet and drain off the vinegar (press the above button).

11) Switch off the oven.

12) Insert a rubber hose inside the boiler filler pipe and rinse thoroughly until the water flowing out of the drain is clear.

13) Refit the filler plug and close the boiler drain (press the above button).

7.1.3 DESCALER CLEANING METHOD

If you decide to descale the boiler using a chemical product, follow the directions provided by the product supplier.

For example, when using ECOLAB's "STRIP-A-WAY" descaler, proceed as follows:

- Follow the instructions given in the previous paragraph and supply the following product quantities via the boiler filler pipe:
 - 2 litres of descaler liquid plus 6 litres of water (6-10gn).
 - 4.5 litres of descaler liquid plus 11.5 litres of water (20gn).
- Run a "steam" cycle for 12 minutes.
- Switch off the oven and wait 40 minutes.
- Reopen the boiler drain outlet and proceed as described in the paragraph above.

IMPORTANT - 1

Insert a rubber hose inside the boiler filler pipe and rinse thoroughly with water to remove all traces of descaling agent.

- Refit the filler plug and close the boiler drain (by pressing the relative button).

After descaling the boiler, it is good practice to execute a 30-minute STEAM cycle with the oven empty.

IMPORTANT - 2

If the water supply cock cannot be easily accessed, to empty the boiler proceed as follows:

- 1) Open the boiler discharge valve with the special pushbutton.
- 2) Wait 2 minutes and switch the oven off; the discharge valve will close automatically.

7.2 REPLACING CONSUMABLE COMPONENTS

Changing the oven chamber lamp (Fig. 3)

If the oven chamber lamp burns out, replace as follows:

- Disconnect the appliance from the power supply.
- Unscrew the four screws fixing flange "A" and remove glass shield "V" together with seal "G".
- Remove halogen lamp "L" and fit an equivalent lamp with identical characteristics (12V - 20W - 572°F). Important: do not touch the new lamp with your fingers, wrap it in paper or a clean cloth when fitting.
- Refit the glass shield with the seal in the lamp recess then smear food grade silicone grease on the seal and secure the flange using the four screws.

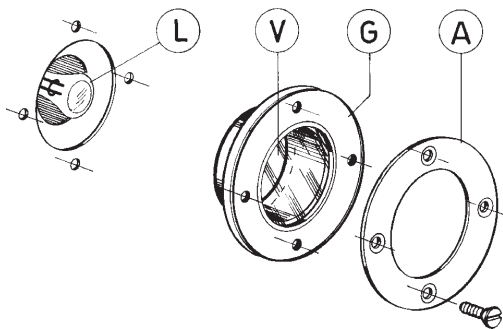

3

Replacing the oven door seal (Fig. 4)

N.B.: The oven door seal is prone to normal wear and aging and should be replaced whenever it starts to harden or crack.

To change the oven door seal proceed as follows:

- prise the seal out of its seat and remove all traces of old silicone from the channel.
- apply a bead of silicone sealant in point 1 along the internal frame of the seal seating channel.
- insert the new seal, pressing it home along the entire length of the channel.

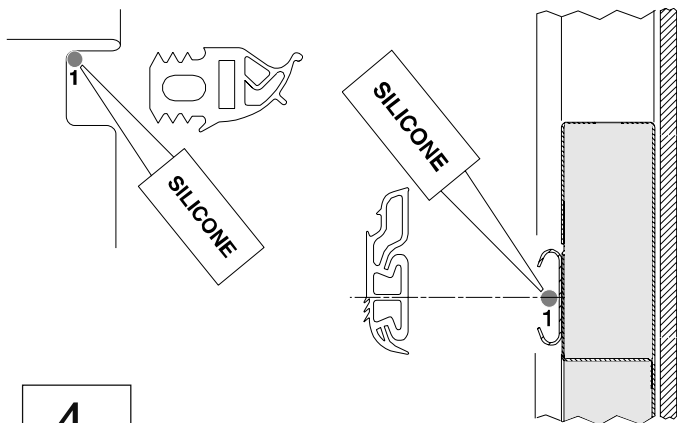

4

7.3 SPECIAL CLEANING INSTRUCTIONS

Cleaning and checking the drain system

Periodically clean the drain pipe and check for obstructions that may prevent the water from draining.

Cleaning the oven door glazing panels (Fig. 5)

Only clean the panels when the glass is cool and never use abrasive cloths or detergents.

To access the double glazing cavity, open the internal panel, which is hinged to the door.

- Open the oven door and press both upper and lower clips F to release the internal glazing panel.

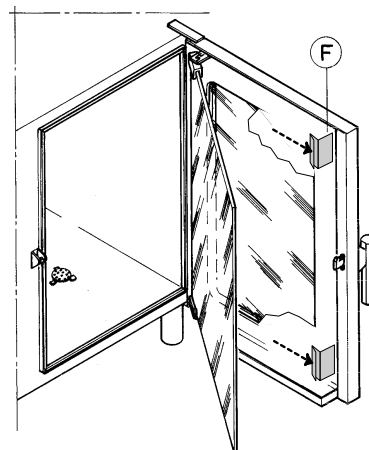

5

After cleaning close the internal panel ensuring it is properly seated against the rubber stops.

CLEANING SYSTEM rotary spray arm (Fig. 6)

Clean the spray arm in the following cases:

- prolonged disuse of the CLEANING SYSTEM
- faulty rotation of the spray arm (nozzles probably blocked)
- use of the appliance with very hard water.

If the nozzles are completely blocked, remove scale deposits using the tip of a knife.

- Disengage (without removing) spring clip A from the central block of the spray arm. For this operation, insert the tip of a screwdriver in the position shown by the arrow and turn it from the vertical to the horizontal position as shown in the figure.
- Remove the spray arm from its hub.

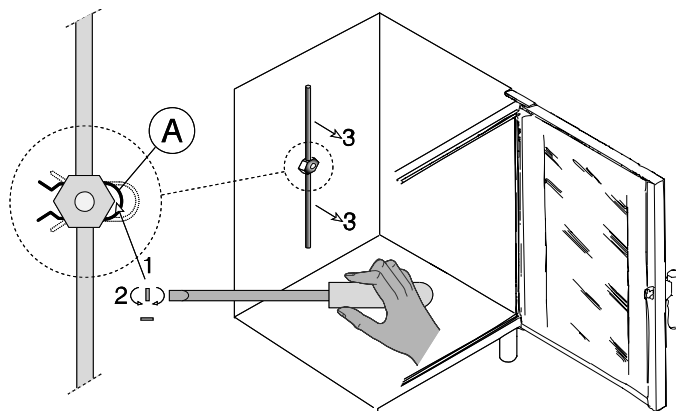

6

- Place the spray arm in a bowl full of descaling agent and leave it to soak overnight, rinsing thoroughly before refitting.
- Refit the spray arm by inserting it over the hub and returning the spring clip to its original position.

NO TEXT ON THIS PAGE