

# Replacement Parts for Single Deck Faucets

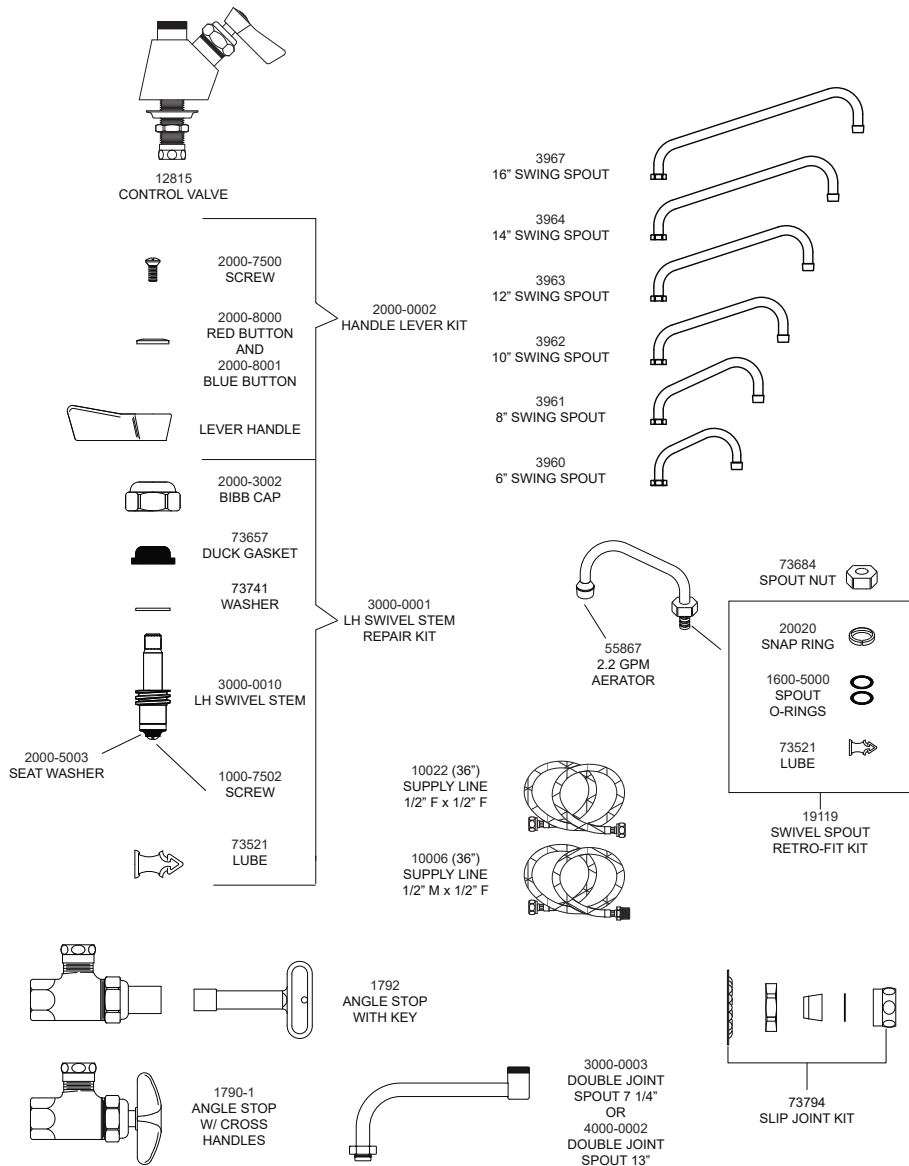

## FAHB-KF-SDL Product Installation Guide

Since 1936, Fisher Manufacturing Company has manufactured heavy-duty, high quality plumbing products and hardware specialties for the food service industry. For three generations, the Fisher family has adhered to a strict dedication of and overall value. When you install Fisher products... you install the best. Our hardware is manufactured with the standardization of internal mechanisms. All chrome plating is triple plated copper, nickel and chrome for durability. Every piece of equipment we make is rigorously tested in both our modern in-house testing center and in actual field situations under extreme conditions. Every detail is thoroughly checked. Before we make our products available to you, they pass each and every test. You get proven performance. Guaranteed.



### Limited One Year Warranty

Fisher Manufacturing Company warrants its products and parts thereof (except as noted below) against defects in materials or workmanship for a period of one year after the date of original purchase. During this period Fisher Manufacturing Company will replace a defective product or part without charge to you, provided that the entire product is delivered to Fisher Manufacturing Company. All transportation and insurance charges for shipping the product to and from Fisher Manufacturing Company must be borne by you. Charges for transportation and insurance may, at the option of Fisher Manufacturing Company, be refunded depending upon our investigation of the warranty claim. This warranty does not cover external finish (except at date of original purchase) or labor costs not specifically authorized by Fisher Manufacturing Company.

- #3010 - FAUCET SDLH 06SS
- #3011 - FAUCET SDLH 08SS
- #3012 - FAUCET SDLH 10SS
- #3013 - FAUCET SDLH 12SS
- #3014 - FAUCET SDLH 14SS
- #1643 - FAUCET SDLH 16SS

A full and complete copy of our One Year limited warranty is available upon request.

**⚠ Warning:** This product can expose you to chemicals including Lead, Nickel (Metallic), Di(2-ethylhexyl) phthalate (DEHP) which are known to the State of California to cause cancer, and Lead, Di(2-ethylhexyl) phthalate (DEHP) which are known to the State of California to cause birth defects or reproductive harm.

For more information go to:

[www.P65Warnings.ca.gov](http://www.P65Warnings.ca.gov)

KEEP THIS MANUAL FOR FUTURE REFERENCE



ANSI/A112.18.1M, ANSI/NSF 61.9

FISHER MANUFACTURING COMPANY - TOLL FREE: 800-421-6162 FAX: 800-832-8238

## Installation Instructions Continued

**BE SURE TO CHECK WITH YOUR LOCAL DEPARTMENT HAVING JURISDICTION REGARDING BACKFLOW PREVENTION**

### Installation Notes:

- Be sure to shut off water supply before beginning.
- Use pipe thread sealant such as PST on all threaded joints.
- Check the packaging for missing items BEFORE beginning installation. If items are missing, contact your supplier.

### Tools Required for Installation

- Medium Sized Crescent Wrench
- Pipe Thread Sealant
- Phillips Screwdriver
- 7/16" Drill Bit



### Package Contents

The box should contain the following:

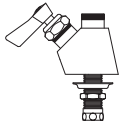

Control Valve  
Qty: 1

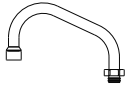

Swing Spout  
Length Determined By Model  
Qty: 1  
Each Spout Includes One 20020 Snap  
Ring And Two 1600-5000 O-Rings

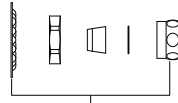

73794  
Slip Joint Kit  
Qty: 1



73521  
Lube

### Installation Instructions

1. Mount control valve on deck by inserting the nipple through a pre-drilled 7/8" hole in deck. Apply thread sealant to the nipple and attach slip joint kit. Tighten until control valve is secure.
2. If installing a double joint spout, apply lube to the o-ring on the spout. Mount the double joint spout and tighten the nut onto the faucet spout outlet.
3. Apply lube to the o-rings on the swing spout. Make sure the white snap ring is in place before mounting the swing spout. Mount the swing spout and tighten the swing spout nut onto the faucet spout outlet.
4. Turn on water supply and check for leaks.

#### Step 1

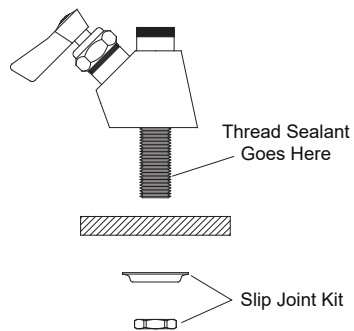

#### Step 2

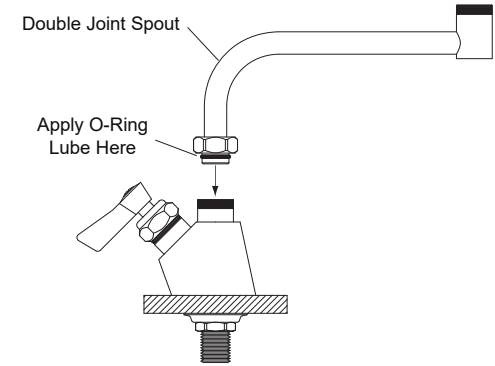

#### Step 3

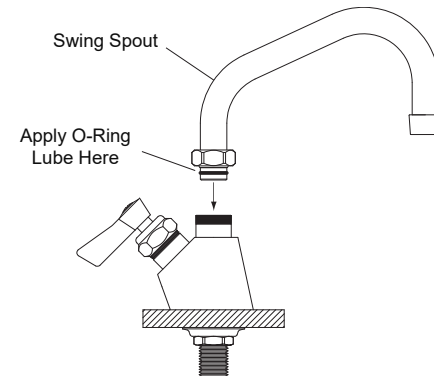

#### Step 4

