

SERVICE MANUAL

MULTI DECK HOT MERCHANDISERS MD 24 - 40 - 48

Models

**Solid back 3 and 5 level
Pass through 3 and 5 level**



MD 40 - 3 solid back

- NOTICE -

This manual is prepared for the use of trained Service Technicians and should not be used by those not properly qualified. If you have attended a training for this product, you may be qualified to perform all the procedures in this manual.

This manual is not intended to be all encompassing. If you have not attended training for this product, you should read, in its entirety, the repair procedure you wish to perform to determine if you have the necessary tools, instruments and skills required to perform the procedure. Procedures for which you do not have the necessary tools, instruments and skills should be performed by a trained technician.

Reproduction or other use of this Manual, without the express written consent of Fri-Jado, is prohibited.



USA

EMPTY PAGE

Versions		
Version	Issue date dd/mm/yy	Remarks
04/2012	16/03/2012	MD 24 Solid Back 3 level 120V added.
06/2015	01/06/2015	Replacement side glass changed. Instruction mounting side glass added. Glass doors added. Update exploded views. Various updates.
12/2016	01/12/2016	Replacement of EKC to ERC thermostat. Update front doors and electric diagrams. Various small updates.

INDEX

Index	4
General technical data	5
Removal and replacement of parts	6
Panels bottom side	6
Top cover	6
Display / illumination	7
Lamp holder	7
Tumble switch illumination (solid back)	8
Tumble switch illumination (pass through)	8
Electronic ballast	8
Drawer with telescopic slide	9
Danfoss thermostat	9
Sensor Danfoss thermostat	9
Contactor	10
Transformer	10
Swing door	10
Side glass	11
Top plate of the shelf (pass through)	12
Top plate of the shelf (solid back)	13
Blower	14
Mounting instruction glass door(s)	15
Changing Danfoss EKC to ERC thermostat	23
Electrical tests and service procedures	24
Heating element test	24
PTC 1K Sensor test	24
Contactor, blower and transformer test	25
Adjusting Danfoss ERC 211 thermostat	26
Error codes ERC 211	28
Adjusting Danfoss EKC 102A thermostat till serial number 100080772	29
Adjusting Danfoss EKC 102A thermostat till serial number 100080772	30
Control locations	31
Troubleshooting	32
Trouble shooting Multi Deck 24/40/48 - 3 and 5 level	32
Exploded views & Part lists	35
Multi Deck 24/40/48 - 3 level solid back	35
Multi Deck 24/40/48 - 3 level pass through	39
Multi Deck 24 - 3 level solid back 120 V	43
Multi Deck 24/40/48 - 5 level solid back	45
Multi Deck 24/40/48 - 5 level pass through	49
Electrical diagrams	53
Circuit Diagram Multi Deck with ERC thermostat	53
Circuit Diagram Multi Deck with EKC thermostat till serial number 100080772	54
Circuit Diagram Multi Deck 24 - 3 level 120 V	55







GENERAL TECHNICAL DATA

This manual covers the Multi Deck 24-40-48 Hot 3 and 5 level series Merchandiser cabinets. The cabinets come in 3 sizes: 24, 40 and 48 inches, and in 2 different heights: 56 7/8 inch for the 3 level version and 77 5/8 inch for the 5 level version.

- Multi Deck 24 - 3 and 5 level - Merchandiser 24 inches wide.
- Multi Deck 40 - 3 and 5 level - Merchandiser 40 inches wide.
- Multi Deck 48 - 3 and 5 level - Merchandiser 48 inches wide.

All of the information, illustrations and specifications contained in this manual are based on the latest product information available at the time of printing.

TECHNICAL DATA

Type	MD 24 - 3	MD 24 - 3	MD 24 - 5 MD 24 - 4 high	MD 40-3	MD 40-5 MD 40-4 high	MD 48-3	MD 48-5 MD 48-4 high
Power (W)	2400	2400	3600	3500	5300	4300	6400
Fuses needed with power connection 208V, 1N ~ 60Hz (1 phase with zero)	-	1x 15 A	1x 20 A	1x 20 A	1x 50 A	1x 25 A	1x 50 A
Fuses needed with power connection 208V, 3 ~ 60Hz (3 phases without zero)	-	3x 15 A	3x 15 A	3x 15 A	3x 15 A	3x 20 A	3x 20 A
Fuses needed with power connection 120V, 1N ~ 60Hz (1 phase with zero)	1x 20 A	-	-	-	-	-	-
Standard plug from factory (NEMA)	5 - 30P 	6 - 20P 	6 - 30P 	6 - 30P 	15 - 20P 	6 - 30P 	15 - 30P 
Net weight (lbs)	342	342	461	441	604	474	661
Gross weight (lbs)	401	401	542	518	710	558	778
Height (inches)	55 7/8"	55 7/8"	77 5/8"	55 7/8"	77 5/8"	55 7/8"	77 5/8"
Width (inches)	23 5/8"	23 5/8"	23 5/8"	39 3/8"	39 3/8"	47 1/4"	47 1/4"
Depth (inches)	31 1/2"	31 1/2"	31 1/2"	31 1/2"	31 1/2"	31 1/2"	31 1/2"

Tools

- Standard set of tools.
- Metric wrenches, sockets and hex socket key wrenches.
- Multi-meter and AC current clamp meter.
- Insulation value tester (Megger)
- Temperature tester.

REMOVAL AND REPLACEMENT OF PARTS

WARNING: Disconnect the electrical power to the machine at the main circuit box. Place a tag on the circuit box indicating the circuit is being serviced.

PANELS BOTTOM SIDE

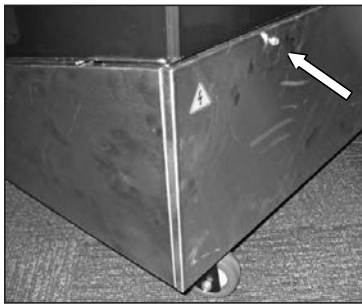

1. Open the front drawer.
2. Remove the bolts on the front panel and remove the panel.
3. Remove the bolt that secures the side panel and slide the panel to the backside to remove this.
4. Remove the bolts that secure the back panel and remove this panel.
5. Reverse the procedure to install.

Note: The panels are fitted with a folding inside a slotted hole.

TOP COVER



1. Remove the plastic plugs on the back side that cover the bolts.
2. Loosen the bolts that secure the panel and remove the panel.
3. Reverse the procedure to install.



Note: The plastic plugs cannot be re-used, so you have to replace them. Part.number plug is 9281039.

DISPLAY / ILLUMINATION



1. Remove the plastic rail profile on the top side.
2. Pull, with both hands, on the bottom side of the plastic cover to remove the cover out of the "click system". Remove the total length out of the click system.
3. Lift the top side out of the Aluminium rail and remove the display.
4. Replace lamp.
5. Reverse the procedure to install.

LAMP HOLDER

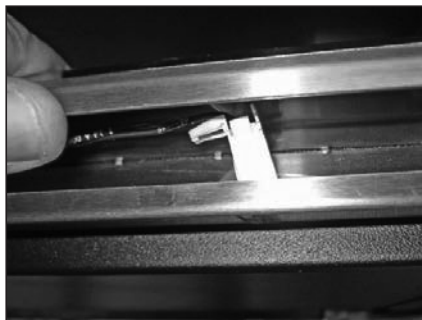

1. Remove the transparent price rail. Lift this up on the edge and remove this from the holder. Now slide the rail out to the side.
2. Remove the screws on top of the lamp holder.
3. Bend the lamp holder profile open. This is a special construction that enables you to open and close this profile.
4. Loosen the blocking clips on the sides of the lamp holder and lift the holder out.
5. Remove the wiring from the holder.
6. Reverse the procedure to install.

Note: If the lamp holder profile breaks, just screw it back on again.

TUMBLE SWITCH ILLUMINATION (SOLID BACK)

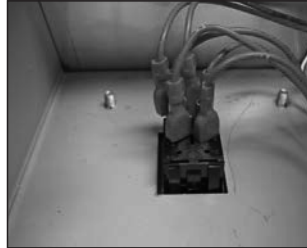
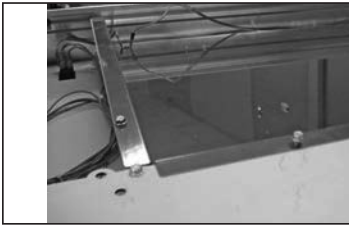

1. Remove the top cover according prior procedure.
2. Remove the wiring from the switch and remove the switch by pushing the clamps on both sides.
3. Reverse the procedure to install.

TUMBLE SWITCH ILLUMINATION (PASS THROUGH)

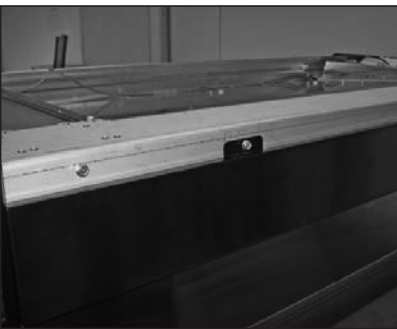

1. Remove the top cover according prior procedure.
2. Remove the bolts that secure the magnet holder profile and remove this profile.
3. Remove the bolt that secures the black cover plate and remove this plate by lifting this.
4. Remove the wiring from the switch and remove the switch by pushing the clamps on both sides.
5. Reverse the procedure to install.

ELECTRONIC BALLAST

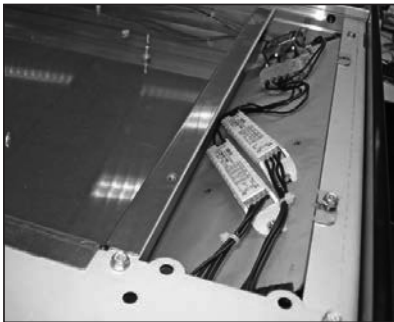

1. Remove the top cover according to prior procedure.
2. Remove the bolts on the mounting plate and lift the plate out.
3. Remove the screws on the ballast and remove the wiring.
4. Reverse the procedure to install.

Note: There is also a ballast on the bottom side of the mounting plate.

DRAWER WITH TELESCOPIC SLIDE

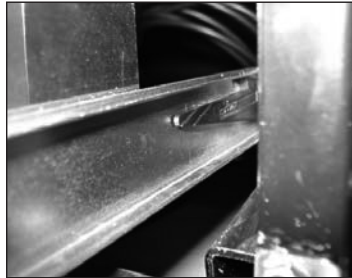

1. Open the drawer and remove the bolt that secures the electric wiring box and lift the box out.
2. If necessary remove the wiring of the sensor on the thermostat.
3. Lift the black plastic locking pin of the telescopic slide on the right hand side up and push the locking pin on the left hand side down. Now you can pull the drawer out.
4. Reverse the procedure to install.

DANFOSS THERMOSTAT



1. Open the drawer and remove the bolt that secures the electric wiring box and lift the box out.
2. Remove the wiring from the thermostat.
3. Loosen the blocking clips on the side of the thermostat and remove the thermostat.
4. Reverse the procedure to install.

Note: When changing the thermostat verify all parameters after installation. Start with parameter 07 by setting it to heating HE.

SENSOR DANFOSS THERMOSTAT

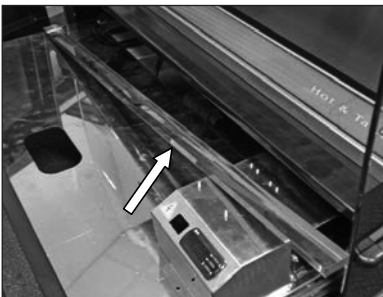

1. Lift out the stainless steel drip tray from underneath.
2. Lift out the electric wiring box according prior procedure.
3. Remove the wiring of the sensor on the thermostat.
4. Remove the screws, under the bottom shelf, that secure the holder of the sensor and remove the holder with sensor.
5. Reverse the procedure to install.

CONTACTOR

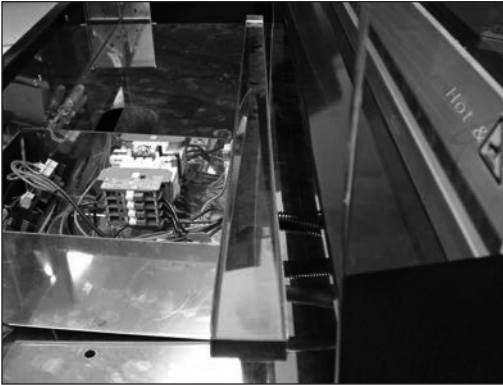

1. Lift out the electric wiring box according prior procedure.
2. Remove the contactor by sliding it upwards over the rail.
3. Remove the wiring from the contactor.
4. Reverse the procedure to install.

TRANSFORMER



1. Lift out the electric wiring box according prior procedure.
2. Remove the bolt (white arrow) that secures the cover box of the transformer and remove the box.
3. Remove the wiring of the transformer.
4. Remove the bolt and nut that secures the transformer and remove the transformer.
4. Reverse the procedure to install.

SWING DOOR



1. Open the swing door and remove the screws that secure the door hinges and remove the door.

Note: The doors are delivered as a total assembly with glass, hinges, handle and snap rivets.

SIDE GLASS

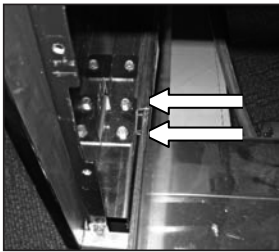

1. **(Pass through only)** Remove the top and back panel(s) according prior procedures.
2. **(Solid back only)** Remove the top cover and the rear panel according prior procedures.
3. Open the drawer.
4. Remove the bolts that secure the brackets of the glass and remove the brackets.
5. Remove all broken glass and silicon residue and clean the surface.
6. Place the new glass and secure the glass to the machine with the 2 taptite bolts in each mounting bracket. Use the side panel on the bottom side as a support for the glass. To secure the glass with one or two clamps makes it easier.
7. Seal the edge between the bottom, black coloured, drip tray and the side glass. with transparent Dow Corning 732 Silicon sealant (part.nr. 4302373). See white line in picture below.



TOP PLATE OF THE SHELF (PASS THROUGH)

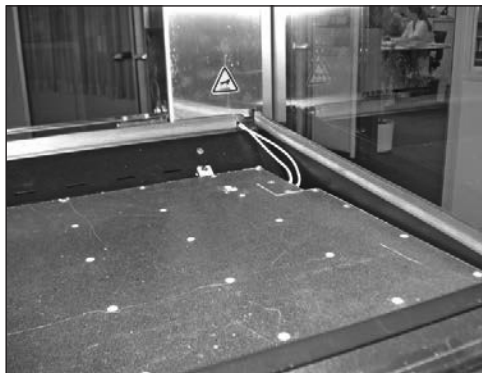
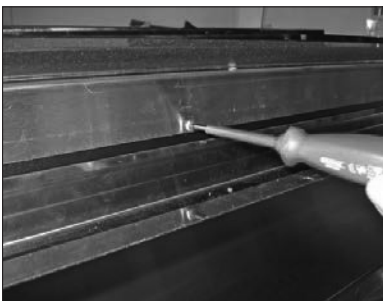
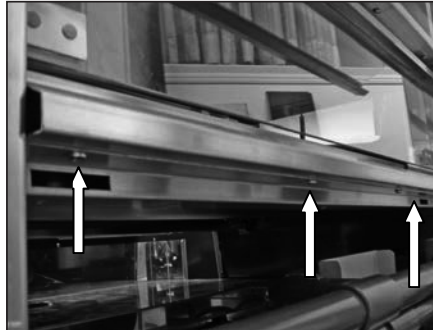

1. Remove the top cover, the magnet holder profile (**only for top shelf**) and the black cover plates on the backside according prior procedures.
2. (**Bottom shelf only**) Remove the bolts that secure the black horizontal cover profile on the bottom side and remove the profile.
3. Remove the screws on the bottom side of the cross sectional profile with the big plugs.
4. Remove the plastic plugs from this profile.
5. Loosen the screws through the big holes and remove the profile. Better to guide this with both hands on the outside of the profile.
6. Remove the transparent price rail according prior procedure.
7. Remove the plastic caps on the nuts on the front side of the shelf and remove the bolts and nuts.
8. Remove the screws on the back side that secure the top plate of the shelf and remove the plate by lifting it up from the back and remove the plate to the front side.

Note 1: When replacing the plate make sure the rubber profiles are in place.

Note 2: The plastic plugs can get damaged and need to be replaced. Part number plug is 9172419.

TOP PLATE OF THE SHELF (SOLID BACK)

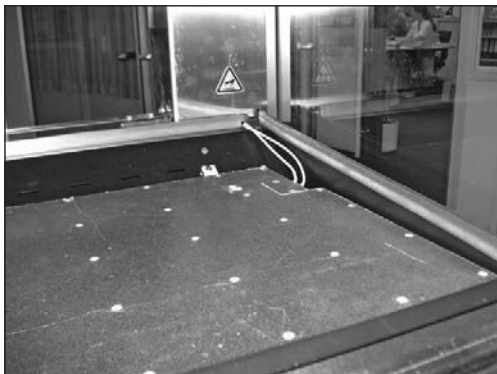
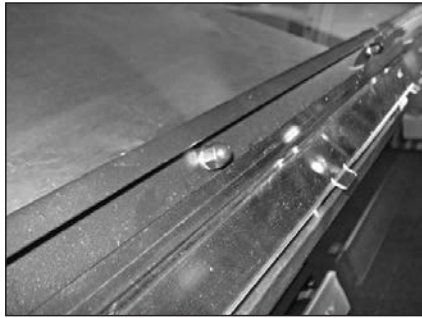
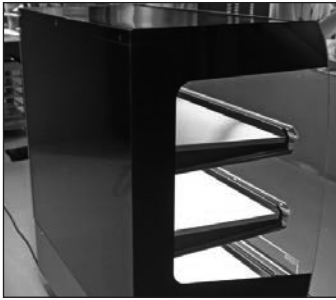

1. Remove the top cover, and the rear panel according prior procedures.
2. Remove the transparent price rail, the plastic caps on the nuts on the front side and these bolts and nuts according prior procedures.
3. Remove the screws on the back side that secure the rear plate and the top plate of the shelf and remove the rear plate.
4. Remove the top plate by lifting it up from the back and remove the plate to the front side.

Note: When replacing the plate make sure the rubber profiles are in place.

BLOWER

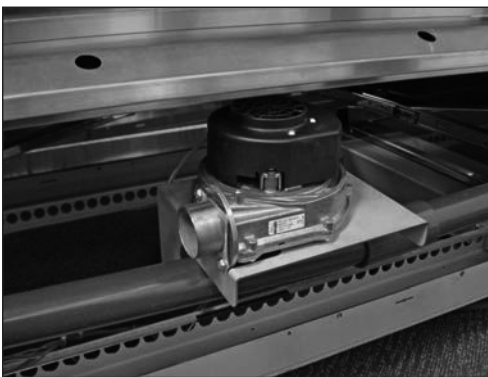
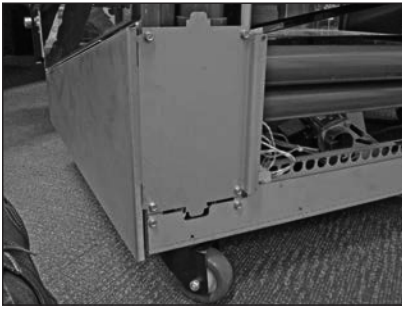

1. Remove the top cover, the magnet holder profile (pass through only), and all the black cover plates on the backside according to prior procedures.
2. Remove the bolts that secure the bottom clamp plate on the backside. This plate does not have to be removed.
3. Remove the bolts that secure the base plate of the blower and remove this plate including the blower. Take care that the connections of the air tubes on the blower are loose.
4. Slide the upper tubes in the horizontal tee-joint as far as possible to the outside.
5. Pull the upper tee-joint towards yourself to loosen the joints and remove the tee-joint and the 2 horizontal tubes.
6. Lift the base plate with the blower outside the unit and remove the wiring of the blower.
7. Remove the bolts that secure the blower on the base plate and remove the blower.
8. Reverse the procedure to install.

Note: The models MD 40 and 48 with 5 shelves have 2 blowers. Each blower operates for the left or right hand circulation.

MOUNTING INSTRUCTION GLASS DOOR(S)

Mounting instruction of the glass door MD 60 (Two doors for MD 100 and MD 120)

1. Open the drawer

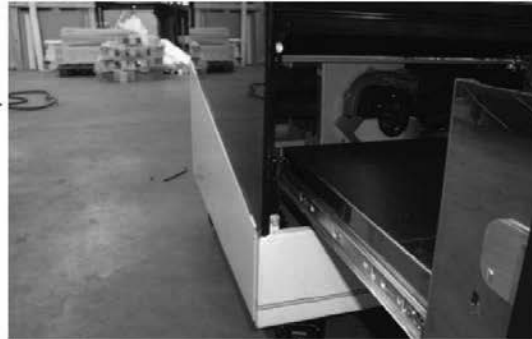
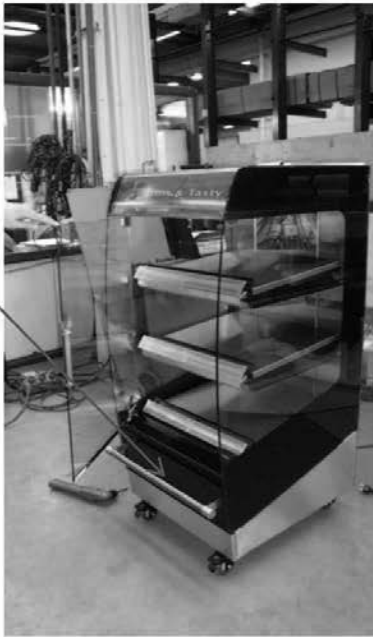

2) Remove the two M5 nuts inside the cabinet.



3) Lift transparent plate.



4) Remove transparent plate.



5) Punch out two holes (on both sides for MD 100 and MD 120)

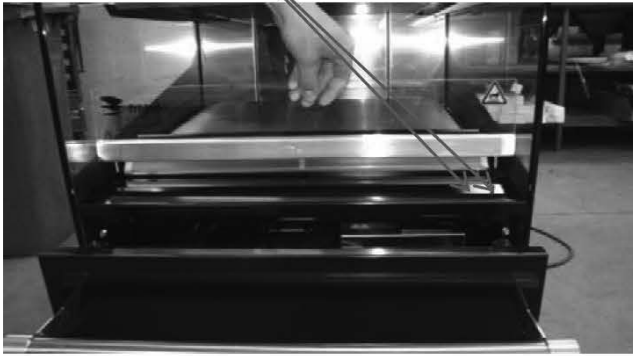

Before:

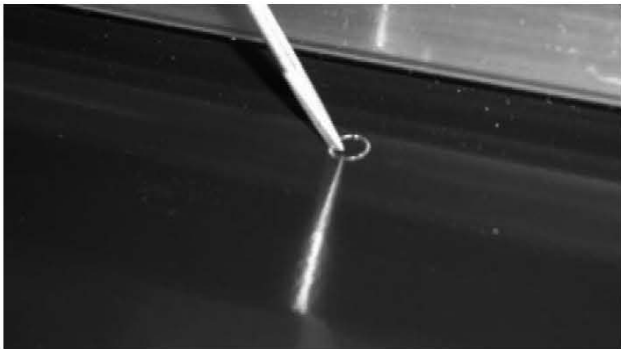

After:

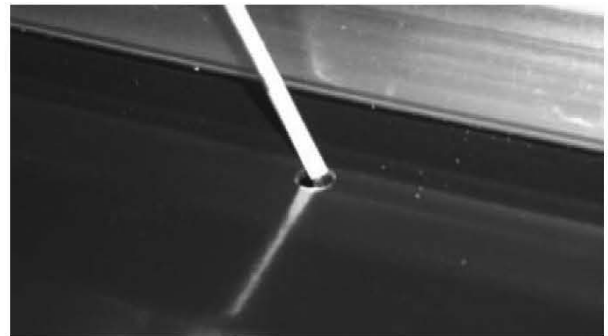
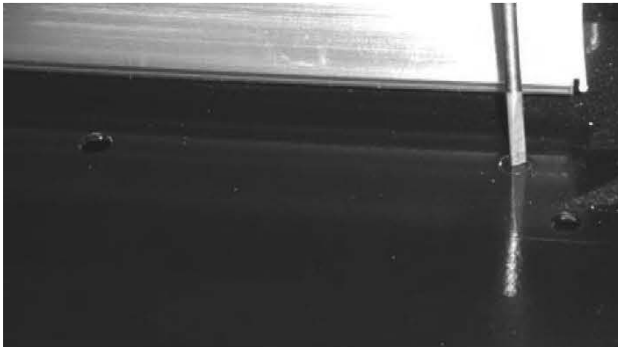
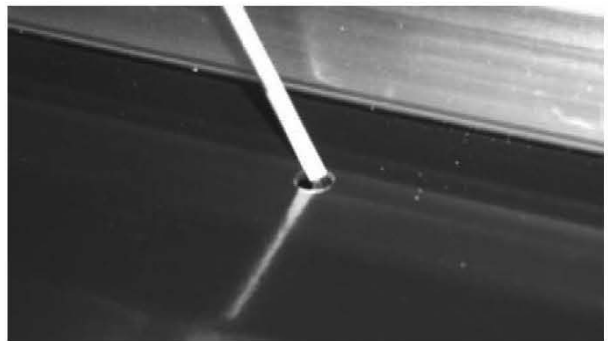

6) Unpack supplied mounting bolts, washers and nuts.



7) Mount both Phillips-head screws in holes left by transparent plate.



7a) Phillips-head screw on top.



7b) Washer and nut on inner side cabinet.



8) Unpack magnetic lock and mount as indicated. (See step 16 for MD 100 and MD 120)
(Use punched through holes, made in step 5.)



NOTE: magnetic strips must be facing the operator. (See step 16 for MD 100 and MD 120)
Washers must be mounted, and nuts must be fastened inside cabinet, similar as in step 7b.



9) Unpack door guard. 1 Piece for MD 60 and 2 pieces for MD 100 and MD 120.



Mounting holes of guard.



10) Apply door guard as indicated.

Make sure that guard is mounted to the **utmost left position** inside the cabinet! For MD 100 and MD 120 **utmost left and untmost right position**.

10a)



10b)



After placement, two rubber protection pads must face glass door.

10c)

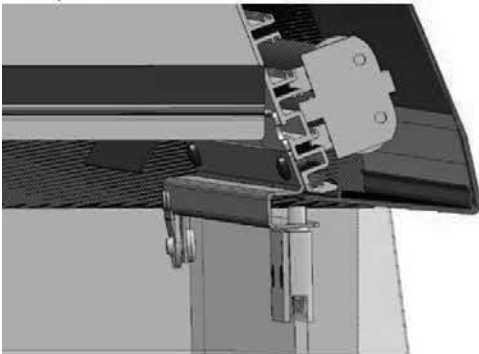

10d)

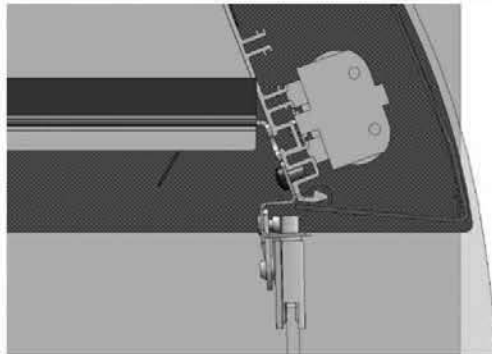

10e)



Screws must be inserted to aluminium profile.



Position of door guard MD 60

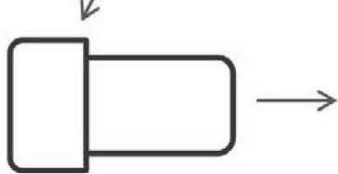
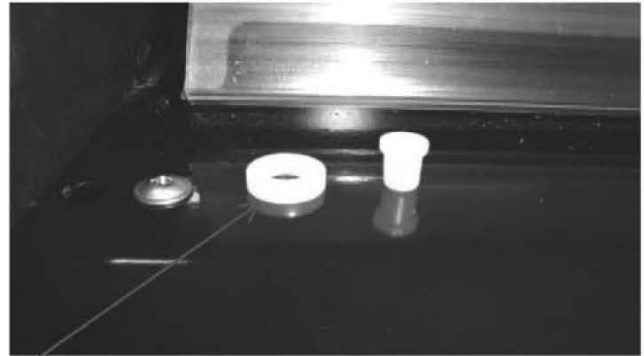
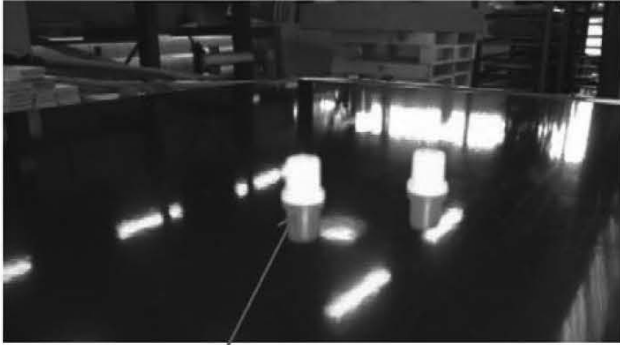

Position of door guard MD 100 and MD 120

Mounting of door:**11) Prepare upper and lower hinge:****11a) Apply white plastic washers and bushes as indicated.**

Bush 9221070

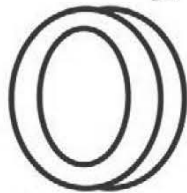

Washer 3 mm 3701242

NOTE: use washer for both hinges.**11b) Insert bush and 3 mm washer for top hinge.**

11c) Insert bush with 3 mm washer in left most hole in bottom plate for lower hinge.



12) Insert glass door in bushes.

12a) Bottom hinge:

Insert lower protrusion of door, into bush.



Push down copper interior hinge with screwdriver.



12b) Mount top hinge as described in step 12a.

13) Test hinges by opening and closing glass door.

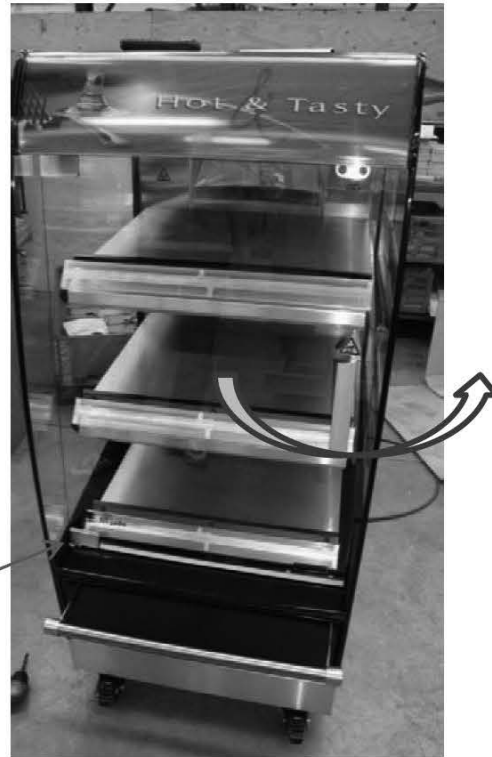
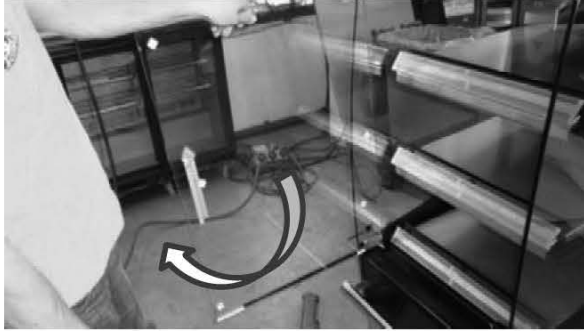

14) NOTE: if bottom side of door touches the metal plate underneath, the door must be lifted. To do this, a **1.6 mm** plastic washer must be added to the 3 mm washer under the lower hinge.

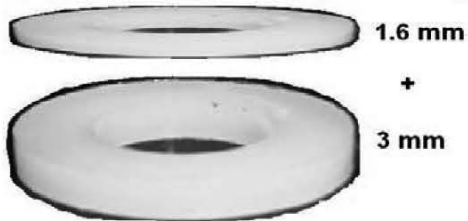

15) If needed, both hinges can be shifted in their consoles by loosening screws. (picture shows bottom hinge).

Fasten both screws after adjustment!



16) Models MD 100 and MD 120:

Magnetic lock must be placed in the centre, to close both doors.



Part number	Description
9229813	Front door ass. MD 24-3
9229814	Front door ass. MD 24-5
9229833	Front door ass. MD 40-3
9229834	Front door ass. MD 40- 5
9229853	Front door ass. MD 48-3
9229854	Front door ass. MD 48-5
9220170S	Ass. front door MD 24-3
9220171S	Ass. front door MD 24-5
9220202S	Ass. front door MD 40-3 left
9220192S	Ass. front door MD 40-3 right
9220203S	Ass. front door MD 40-5 left
9220193S	Ass. front door MD 40-5 right
9220204S	Ass. front door MD 48-3 left
9220194S	Ass. front door MD 48-3 right
9220205S	Ass. front door MD 48-5 left
9220195S	Ass. front door MD 48-5 right

CHANGING DANFOSS EKC TO ERC THERMOSTAT

Instructions for exchanging Danfoss EKC to ERC thermostat

The wiring connection numbers 1-4-2-5-13-14 on the Danfoss EKC thermostat are different than the wiring connections 3L-2-4N-1-9-10 on the ERC thermostat. keep this in mind when you change the EKC for the ERC thermostat. See also the drawing below.

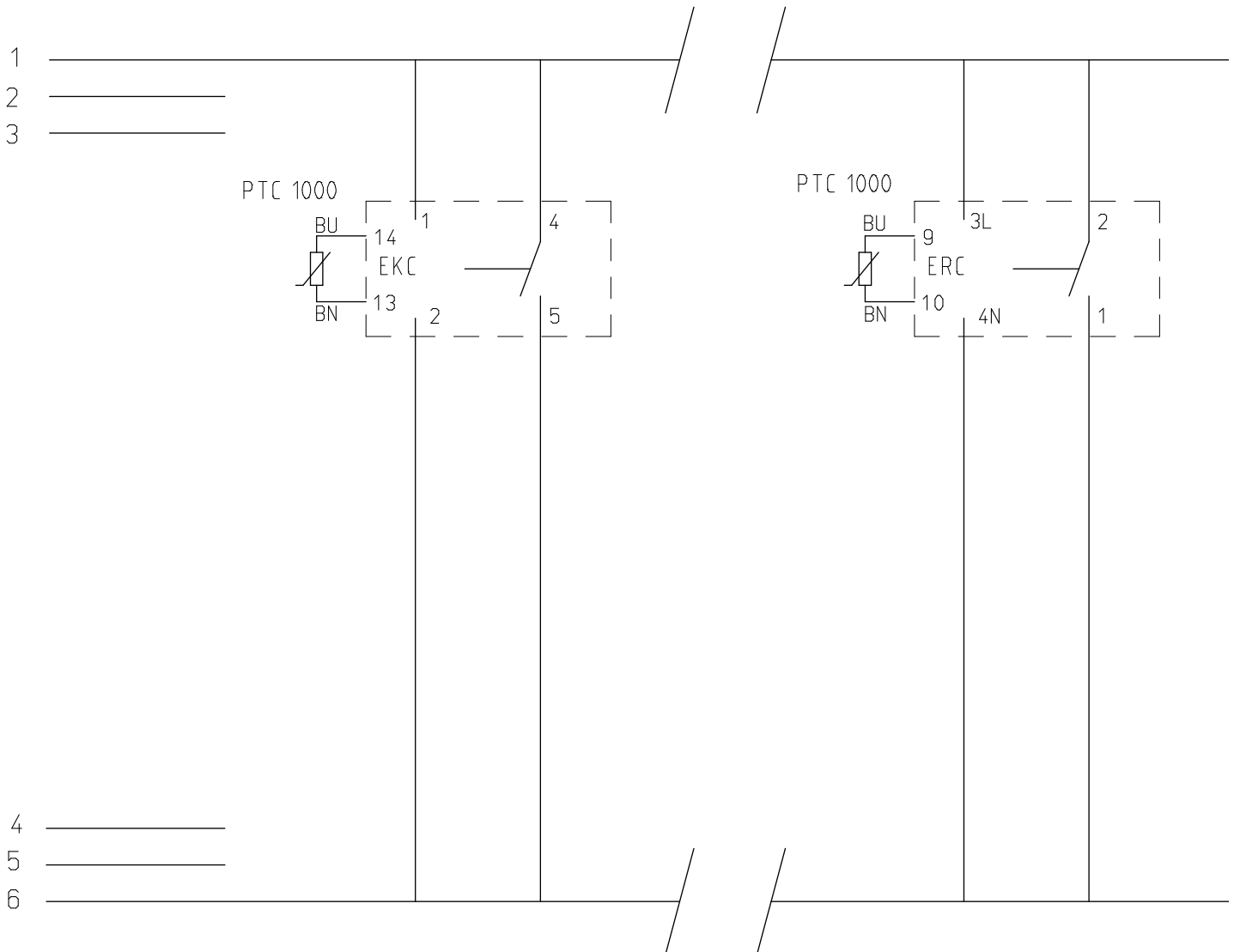

For adjusting instructions and parameter settings see electrical tests on pages 26 and 27.

ELECTRICAL TESTS AND SERVICE PROCEDURES

WARNING: Disconnect the electrical power to the machine at the main circuit box. Place a tag on the circuit box indicating the circuit is being serviced.

HEATING ELEMENT TEST

Note: When testing the resistance of the element remove the wiring from the connecting block.

Type	Wattage/Voltage	Resistance Ω -0% + 10%	Current A
MD 24	400 / 120	36.0	3.3
MD 24	600 / 120	24.0	5.0
MD 24	400 / 208	108.1	1.9
MD 24 + 40	600 / 208	72.1	2.8
MD 40 + 48	900 / 208	48.0	4.3
MD 48	1060 / 208	40.8	5.0

PTC 1K SENSOR TEST

Temperature		Resistance
°F	°C	\pm 10 Ohms
60	16	930
70	21	970
80	27	1016
90	32	1056
100	38	1107
125	52	1227
150	65	1347
200	94	1636
250	121	1935

1. Remove the right side panel according prior procedure.
2. Remove the wiring from the sensor.
3. Connect a temperature sensor to the probe for comparison.
4. Test the probe with an Ohmmeter.

CONTACTOR, BLOWER AND TRANSFORMER TEST

Note: When testing the resistance remove the wiring.







Type	Description	Voltage	Resistance
MD 120V and 208 V	Contactor	208 V	Resistance of coil (A1 - A2) ~ 525 Ω
MD 120V and 208 V	Blower See picture below	120 V	Between 1-2 ~3.5 M Ω
MD 208 V	Transformer	208 / 120 V	Between orange and brown wire ~5.0 Ω Between red and red wire ~2.5 Ω Between all other combinations infinite







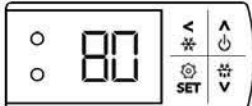







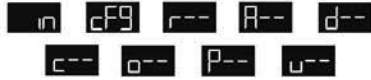

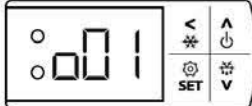

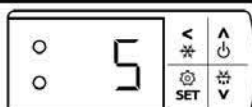

ADJUSTING DANFOSS ERC 211 THERMOSTAT

In order to adjust the thermostat, first open the panel on the backside with the key.

Adjusting Danfoss ERC211 thermostat

Changing temperature setpoint	Example screens
1. Press  to access setpoint mode	
2. Change value with  or 	
3. Press  to confirm	
When no key is pressed after last confirmation, the system goes back to normal operation after 10 seconds	

Programming menu	Example screens
1. Press  for 3 seconds to access the menu	
2. Scroll through parameter groups with  and 	
3. Select parameter group with 	
4. Scroll through parameter names with  and 	
5. Press  to read out the value	
6. Change value with  and 	
7. Press  to confirm	
8. Press  to select the next parameter and follow instruction 3 to 7	
Use  to go back in the parameter groups and once more to leave the programming menu	

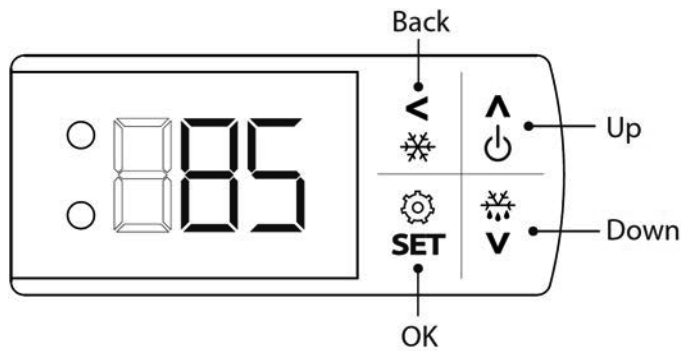

Note! Change r05 first and r03 after!

r00	Temperature set point	185	°F
r01	Differential	2	°F
r02	Min set point limitation	32	°F
r03	Max set point limitation	210	°F
r04	Display offset	0	°F
r05	Display unit (°C/°F)	°F	
r09	Calibration of Sair	-20.7	°F
r12	Main switch	1	
r13	Night set back	0	
r40	Thermostat reference displacement	0	
r96	Pull-down duration	0	
r97	Pull-down limit temperature	0	
A03	Delay for temperature alarm (normal conditions)	30	min
A12	Delay for temperature alarm (pull down/start-up/defrost)	60	min
A13	High temperature alarm limit	212	°F
A14	Low temperature alarm limit	-22	°F
A27	DI1 delay	30	min
A37	Condenser high alarm limit	176	°F
A54	Condenser high block limit	185	°F
A72	Voltage protection enable	no	
A73	Minimum cut-in voltage	0	V
A74	Minimum cut-out voltage	0	V
A75	Maximum voltage	270	V
d01	Defrost method (no=no defrost, nAt=natural)	no	
d02	Defrost stop temperature	40	°F
d03	Defrost Interval	8	hr.
d04	Max. defrost time	30	min
d05	Defrost delay at power up	0	min
d06	Drip delay	0	min

d10	Defrost stop sensor (non=time, Air=Sair)	non	
d18	Compressor accumulated	0	hr.
d30	Defrost delay after pull-down	0	min
c01	Compressor minimum ON time	0	min
c02	Compressor minimum OFF-time	0	min
c04	Compressor OFF delay	0	sec
c70	Zero crossing selection	yES	
o01	Delay of outputs	0	sec
o02	DI1 configuration	oFF	
o03	Serial address	0	
o05	Password	no	
o06	Sensor type selection (n5=NTC5 K, n10=NTC10 K, Ptc=PTC, Pt1=Pt1000)	Ptc	
o07	Cooling/heating (rE=refrigeration / Ht=heat)	Ht	
o15	Display resolution (°C)	0.1	
o23	Relay counter	0	
o61	Predefined applications	AP0	
o67	Save settings as factory	no	
o91	Display at defrost	d	
P73	DI1 input polarity	no	
P76	Keyboard lock enable	no	
u01	Air temperature (Sair)	-	°F
u02	Read the present regulation refer- ence	-	
u10	DI1 input	-	
u13	Status of night operation	-	
u58	Compressor relay status	-	-
u80	Firmware version readout	-	

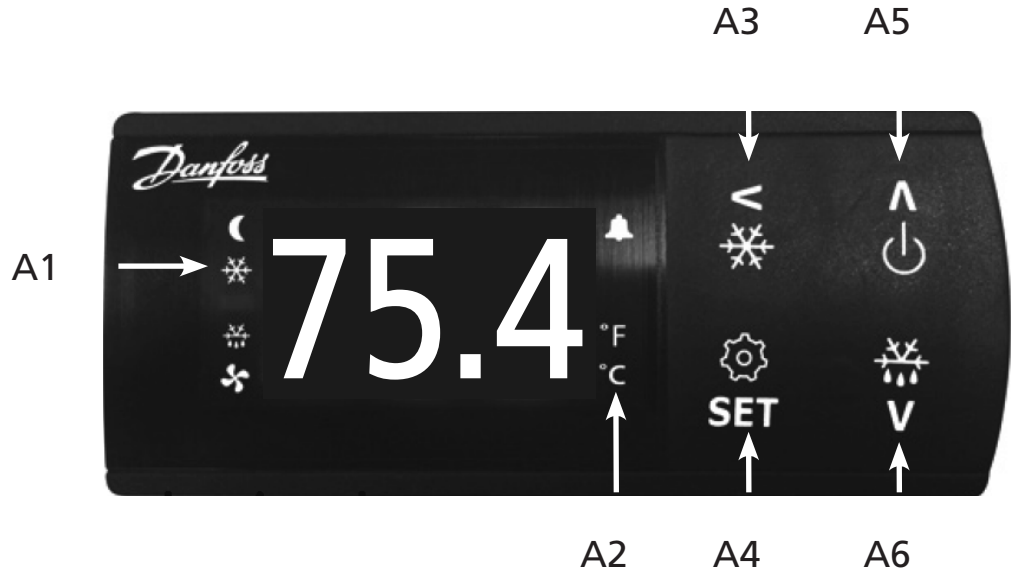
ERROR CODES ERC 211

- A1 Heating on/off
- A2 Indication °C or °F
- A3 Back key
- A4 OK/set key
- A5 Up key
- A6 Down key

If the elements are switched on, the indicator lamp A1 will go on.

Error codes on display:

E29: PT sensor broken or wiring problem sensor.

A01: High temperature alarm.

A02: Low temperature alarm.

A99: High voltage alarm.

AA1: Low voltage alarm.

oFF: Main switch alarm. Check parameter r12.

Wrong temperature displayed: Wrong type of sensor selected. Check o06.

When reporting error codes the unit is switched in stand-by mode and cannot be used until the problem is resolved.

ADJUSTING DANFOSS EKC 102A THERMOSTAT TILL SERIAL NUMBER 100080772

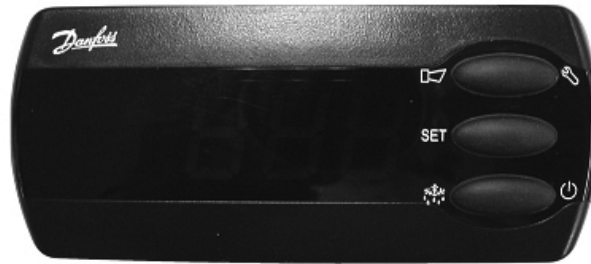

Note: In order to adjust the thermostat, first remove the thermostat according prior procedure.

Changing set point

1. Press the middle button until the temperature value is shown.
2. Change value with upper or lower button.
3. Press the middle button to confirm.

Setting internal parameters

1. Press the upper button for 3 seconds. In display the first parameter appears (r01).
2. Press the middle button to read out value.
3. Change value with upper or lower button.
4. Press the middle button to confirm.
5. Press the lower button for the next parameter. Follow instructions 2 to 4.

When no key is pressed after last confirmation, system goes back to normal operation mode after 20 seconds.

Replacing of thermostat

When you install a new thermostat, then always change parameter r05 first to 1 (°F) and change parameter o07 to HE. Otherwise some other parameters cannot be changed to the desired value. Otherwise some other parameters cannot be changed to the desired value. You can run through the parameters with the up or down keys, once you are inside the parameter settings.

Options

1. Return to factory settings: Turn the power off. Press and hold the upper and lower button and switch the power on at the same time.
2. Actual temperature of sensor 1 (Thermostat): Press up key shortly 2 times.

Error codes on display

E1: Fault in controller.

E29: Cabinet sensor broken or wiring problem sensor.

ADJUSTING DANFOSS EKC 102A THERMOSTAT TILL SERIAL NUMBER 100080772
Parameters Danfoss EKC 102A thermostat

			MD 25-40-48 3 and 5 level
	Setpoint	°F	185
r01	Differential	°F	2
r02	Higher setpoint limit	°F	210
r03	Lower setpoint limit	°F	32
r04	Off-set temperature indication	°F	0
r05	Temperature unit (°C / °F)	°F	°F
r09	Correction of signal from air output	°F	-18
r12	Start / stop of temperature control		1
c01	Minimum "ON" time compressor	min	0
c02	Minimum "OFF" time compressor	min	0
c30	Reversed function of relay contact		OFF
d01	Defrost method (EL / OFF)		OFF
d02	Defrost end temperature	°F	40
d03	Defrost interval	hour	8
d04	Maximum defrost time	min	45
d05	"ON" delay after defrost	min	0
d10	Defrost sensor (0=time, 1=air)		0
d13	Defrost at start up		no
o01	Output delay after start up	sec	0
o05	Access code all settings		0
o06	Sensor type		ptc
o07	Warm (HE) / cold (rE)		HE
o15	Step value display (yes = 0.5°C / no = 1°C)		no
o67	Store current parameter as factory default		OFF
u58	Status relay 1		-

Note: r09 is a compensation when using a long sensor cable. That means that the sensor registrates/works actually 18° higher then the setpoint. So temp. regulation is in fact on 185 + 18.

CONTROL LOCATIONS



on/off switch

On the back side with pass through version.

On the front side with solid back version.



thermostat EKC 211 or

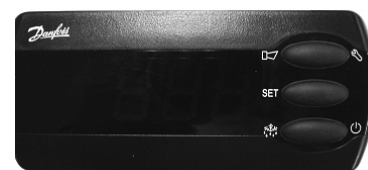

EKC 102A (till serial nr. 100080772)

TROUBLESHOOTING

TROUBLE SHOOTING MULTI DECK 24/40/48 - 3 AND 5 LEVEL

Symptom	Possible causes
No power to cabinet controls.	<ol style="list-style-type: none"> 1. Main breaker open. 2. Fuse F1 or F2 broken. 3. Wiring loose.
Main fuse or breaker blows.	<ol style="list-style-type: none"> 1. Wiring incorrectly. 2. Heating element shorted. 3. Blower shorted. 4. Wiring shorted.
Illumination does not work.	<ol style="list-style-type: none"> 1. Lamp malfunction. 2. Tumble switch malfunction. 3. Electronic ballast malfunction. 4. Wiring loose.
No heating.	<ol style="list-style-type: none"> 1. Heating element malfunction. 2. Relay K1 malfunction. 3. Wiring loose. 4. Thermostat malfunction. 5. Sensor malfunction. 6. Sensor wiring loose.
Unit does not reach desired temperature.	<ol style="list-style-type: none"> 1. Heating element(s) malfunction. 2. Strong air current along the unit. 3. Burned contact on contactor K1. 4. Air leak in PVC air flow system. 5. Sensor malfunction. 6. Blower malfunction.
Error message on display	<ol style="list-style-type: none"> 1. See errors on page 27-28.
No indication on electronic thermostat.	<ol style="list-style-type: none"> 1. Electronic thermostat malfunction. 2. Fuse F1 or F2 broken. 3. Wiring loose.
Blower motor does not run.	<ol style="list-style-type: none"> 1. Ringcore transformer malfunction. 2. Motor inoperative. 3. Fuse F1 broken. 4. Wiring loose.

This is an analytic description for servicing and repairing all major parts of the Multi Deck 24, 40 and 48 - 3 and 5 level. It consists of 4 basic steps to recognize and solve the problems:

1. Symptoms.
2. Possible causes.
3. Solving of the problem: checking/action.
4. Replacing of parts and testing:
 - a. Replacing is described in this service manual.
 - b. For testing see control locations on page 16 of this manual.

Description of part	Symptoms	Possible causes	Solving: checking / action
Contactator	Contactator does not come in	Wiring. Coil malfunction. Contact burned.	Check the wiring. Check resistance of coil. This should be $\pm 525\Omega$. Check the contacts.
Heating element	The cabinet is not reaching the adjusted temperature	Wiring. Element malfunction.	Check the wiring. Check the power on the element. Check current with AC current tester. See table on page 23.
Tumble switch	Light and heating does not switch on	Wiring. Contact burned.	Check the wiring. Check the voltage on "in"- and "output".
Electronic ballast	Light does not switch on	Wiring. Ballast malfunction.	Check the wiring. Replace ballast.
lamp(s)	Light does not switch on	Wiring. Lamp(s) broken.	Check the wiring. Check resistance on the pins on the same side. If $R = \infty$ lamp broken. Replace lamp(s).
Electronic thermostat	Display does not light up The cabinet is not reaching the adjusted temperature or does not heat up at all	Wiring. Loose sensor. Thermostat malfunction. Thermostat settings.	Check the wiring. Check sensor. Replace thermostat. Check parameters.

<p>PTC 1000 sensor</p>	<p>The cabinet is not reaching the adjusted temperature or does not heat up at all</p> <p>The cabinet becomes too hot</p>	<p>Broken sensor.</p> <p>Loose sensor.</p> <p>Broken sensor.</p> <p>Sensor shorted.</p>	<p>Replace sensor.</p> <p>Check wiring.</p> <p>Replace sensor.</p> <p>Check wiring.</p>
<p>Ringcore transformer</p>	<p>Blower motor doesn't run</p>	<p>Wiring.</p> <p>Transformer malfunction.</p>	<p>Check the wiring. Check the power on the transformer.</p> <p>Check the 120V outgoing signal on the transformer. Check the resistance of the coils: Between the brown and orange wire 5.6Ω. Between the red and red wire 3.1Ω.</p>
<p>Blower heating system</p>	<p>Blower doesn't run</p> <p>Main fuse burned</p>	<p>Wiring</p> <p>Cooling</p> <p>Short circuit in coil to earth</p>	<p>Check wiring. Check voltage on blower.</p> <p>Check cooling of blower. Check if unit is close to another heat source.</p> <p>Measure temperature of blower during process.</p> <p>Check insulation value of coil with a Megger on max. 500V Minimum value is 0.5MΩ.</p>

EMPTY PAGE

Item	Part number	Model	Qty	Description
1	9220031S	all models	1	Glass panel, left, ass.
2	9220030S	all models	1	Glass panel, right, ass.
3	9220281	MD 24	2	Shelf ass. Incl. heating element
3	9220261	MD 40	2	Shelf ass. Incl. heating element
3	9220241	MD 48	2	Shelf ass. Incl. heating element
3-1	9226202	MD 24	2	Top plate, shelf
3-1	9226402	MD 40	2	Top plate, shelf
3-1	9226602	MD 48	2	Top plate, shelf
3-2	9222450	MD 24	2	Heating element, 208 V, 600 W
3-2	9222427	MD 40	2	Heating element, 208 V, 900 W
3-2	9222428	MD 48	2	Heating element, 208 V, 1060 W
3-3	9226156	MD 24	2	Holder, price rail
3-3	9226355	MD 40	2	Holder, price rail
3-3	9226555	MD 48	2	Holder, price rail
3-4	9223200	MD 24	2	Price rail, transparent
3-4	9223208	MD 40	2	Price rail, transparent
3-4	9223207	MD 48	2	Price rail, transparent
3-5	9226108	all models	2	Airblock profile, left
3-6	9226109	all models	2	Airblock profile, right
3-7	9226116	MD 24	2	Light fixture
3-7	9226321	MD 40	2	Light fixture
3-7	9226521	MD 48	2	Light fixture
3-8	9221026S	MD 24	2	TL lamp 8 W, with 1 rubber locking ring
3-8	9221027S	MD 40-48	2	TL lamp 21 W, with 1 rubber locking ring
3-8-1	9221050	all models	4	Locking ring
3-9	9221025	all models	4	Lamp holder
3-10	4280560	all models	8	Knurled bolt M5x10
4	9220297	MD 24	1	Shelf ass. Incl. heating element
4	9220262	MD 40	1	Shelf ass. Incl. heating element
4	9220242	MD 48	1	Shelf ass. Incl. heating element
4-1	9226202	MD 24	1	Top plate, shelf
4-1	9226402	MD 40	1	Top plate, shelf
4-1	9226602	MD 48	1	Top plate, shelf
4-2	9222450	MD 24	1	Heating element, 208 V, 600 W
4-2	9222427	MD 40	1	Heating element, 208 V, 900 W
4-2	9222428	MD 48	1	Heating element, 208 V, 1060 W
4-3	9226156	MD 24	1	Holder, price rail
4-3	9226355	MD 40	1	Holder, price rail

Item	Part number	Model	Qty	Description
4-3	9226555	MD 48	1	Holder, price rail
4-4	9223200	MD 24	1	Price rail, transparent
4-4	9223208	MD 40	1	Price rail, transparent
4-4	9223207	MD 48	1	Price rail, transparent
4-5	9224718	all models	1	Sensor holder
5	9222626	MD 24	3	Diastrip, price rail
5	9222625	MD 40	3	Diastrip, price rail
5	9222624	MD 48	3	Diastrip, price rail
5A	9222426	MD 24	3	Diastrip, price rail till serial nr. 100075759
5A	9222425	MD 40	3	Diastrip, price rail till serial nr. 100075759
5A	9222424	MD 48	3	Diastrip, price rail till serial nr. 100075759
6	9222465	MD 24	1	Childguard
6	9222466	MD 40	1	Childguard
6	9222467	MD 48	1	Childguard
7	9221012	MD 24	0.6 mtr	Plastic profile
7	9221012	MD 40	1 mtr	Plastic profile
7	9221012	MD 48	1.2 mtr	Plastic profile
8	9223212	MD 24	1	Holder, childguard
8	9223211	MD 40	1	Holder, childguard
8	9223210	MD 48	1	Holder, childguard
9	9226150	MD 24	1	Cover profile
9	9226354	MD 40	1	Cover profile
9	9226554	MD 48	1	Cover profile
10	3701025	all models	1	Doormagnet
11	9226155	MD 24	1	Top plate
11	9226350	MD 40	1	Top plate
11	9226550	MD 48	1	Top plate
12	9281039	all models	2	Plug, 14.3 mm
13	9221030	MD 24	1	Lamp holder
13	9221030	MD 40-48	2	Lamp holder
14	9160019	MD 24	1	Lamp, PLL 55 W
14	9221006	MD 40	2	Lamp, PLL 36 W
14	9160019	MD 48	2	Lamp, PLL 55 W
15	9222210	MD 24	1	Bracket, lamp
15	9222210	MD 40-48	2	Bracket, lamp
16	9224721	all models	1	Clamp plate
17	9221032	MD 24	0.6 mtr	PVC T-profile
17	9221032	MD 40	1 mtr	PVC T-profile
17	9221032	MD 48	1.2 mtr	PVC T-profile
18	9223218	MD 24	1	Plastic cover
18	9223217	MD 40	1	Plastic cover
18	9223216	MD 48	1	Plastic cover
19	9222622	MD 24	1	Dia strip, top
19	9222621	MD 40	1	Dia strip, top
19	9222620	MD 48	1	Dia strip, top

Item	Part number	Model	Qty	Description
19A	9222422	MD 24	1	Dia strip, top till serial nr. 100075759
19A	9222421	MD 40	1	Dia strip, top till serial nr. 100075759
19A	9222420	MD 48	1	Dia strip, top till serial nr. 100075759
20	9281035	all models		PVC tube Ø 50 x 3.7 mm
21	9281032	all models		PVC elbow 50 mm
22	9281033	all models		PVC T-joint 50 mm
23	9220509	all models	1	Support for blower
24	9191280	all models	1	Blower
25	9226105	MD 24	1	Rear panel
25	9226305	MD 40	1	Rear panel
25	9226505	MD 48	1	Rear panel
26	9226112	MD 24	1	Rear plate, inside top
26	9226312	MD 40	1	Rear plate, inside top
26	9226512	MD 48	1	Rear plate, inside top
27	9226113	MD 24	2	Rear plate, inside
27	9226313	MD 40	2	Rear plate, inside
27	9226513	MD 48	2	Rear plate, inside
28	9226117	MD 24	1	Rear plate, bottom
28	9226358	MD 40	1	Rear plate, bottom
28	9226558	MD 48	1	Rear plate, bottom
29	9222449	MD 24	1	Heating element top, 208 V, 400 W
29	9222450	MD 40	1	Heating element top, 208 V, 600 W
29	9222427	MD 48	1	Heating element top, 208 V, 900 W
30	9224727	all models	1	Mounting plate, electrical components
31	8072071	all models	1	Connecting block
33	9221045	MD 24	2	Ballast, 4-28W
33	9221069	MD 40-48	1	Ballast, 2x21 W
34	9222065	MD 24	1	Ballast, 55 W
34	9222064	MD 40	1	Ballast, 2x55 W
34	9222065	MD 48	1	Ballast, 2x55 W
36	9221011	all models	1	Temperature sensor
37	9224703	all models	1	Side panel, right
38	9224702	all models	1	Side panel, left
39	9226151	MD 24	1	Front panel, bottom side
39	9226356	MD 40	1	Front panel, bottom side
39	9226556	MD 48	1	Front panel, bottom side
40	9223222	MD 24	1	Base profile, Alum.
40	9223221	MD 40	1	Base profile, Alum.
40	9223220	MD 48	1	Base profile, Alum.
41	9181008	all models	1	Tumble switch
42	9221023	all models	1 set	Drawer slide
43	9226102	MD 24	1	Base plate, drawer
43	9226316	MD 40	1	Base plate, drawer
43	9226516	MD 48	1	Base plate, drawer

Item	Part number	Model	Qty	Description
44	9226119	MD 24	1	Reinforcement profile
44	9226326	MD 40	1	Reinforcement profile
44	9226526	MD 48	1	Reinforcement profile
45	9226104	MD 24	1	Front, drawer
45	9226317	MD 40	1	Front, drawer
45	9226517	MD 48	1	Front, drawer
46	9220503	all models	2	Endcover, bar
47	9223215	MD 24	1	Bumper bar
47	9223214	MD 40	1	Bumper bar
47	9223213	MD 48	1	Bumper bar
48	9226120	MD 24	1	Drip tray
48	9226327	MD 40	1	Drip tray
48	9226527	MD 48	1	Drip tray
49	9221031	all models	1	GN tray 1/9
50	9224681	all models	1	Connection box
51	9221109S	all models	1	Thermostat ERC 211
52	9151010	all models	1	Connecting block, 6-pol.
53	9044564	all models	1	Connecting block, 1-2-3
54	9044572	all models	1	Connecting block, 4-5-6
55	9077088	all models	1	Rail
56	3500069	all models	1	Contactora
57	9224662	all models	1	Connection profile
58	9221033	all models	2	Strain relief M25
59	9261023	all models	2	Nut M25
60	9224761	MD 24-40	1	Restriction ring
61	9172401	MD 24	1	Connecting cable with plug 6-20P
61	9172409	MD 40-48	1	Connecting cable with plug 6-30P
62	9172125	MD 24	2	Ridget caster
62	9172065	MD 40-48	2	Swivel caster
63	9172066	all models	2	Swivel caster with break
64	9044205	all models	3	Fuse holder HPS-EE
65	9110250	all models	2	Fuse SC10A
66	9181049	all models	1	Fuse SC2.5A
67	9224680	all models	1	Cover plate box
68	8033659	all models	1	Connecting block, 9-pole
69	9221036	all models	2	Plug 4-pole
70	9221037	all models	2	Socket 4-pole
71	9222302	all models	1	Ringcore transformer
72	9224682	all models	1	Cover box transformer
73	9229801	all models	1	Temperature indicator, ass.
73-1	9221048	all models	1	Temperature indicator
74	9224669	all models	2	Plinth, short
75	9226118	MD 24	2	Plinth, long
75	9226357	MD 40	2	Plinth, long
75	9226557	MD 48	2	Plinth, long
76	9123492	All models	1	Indication plate

EMPTY PAGE

MULTI DECK 24/40/48 - 3 LEVEL PASS THROUGH

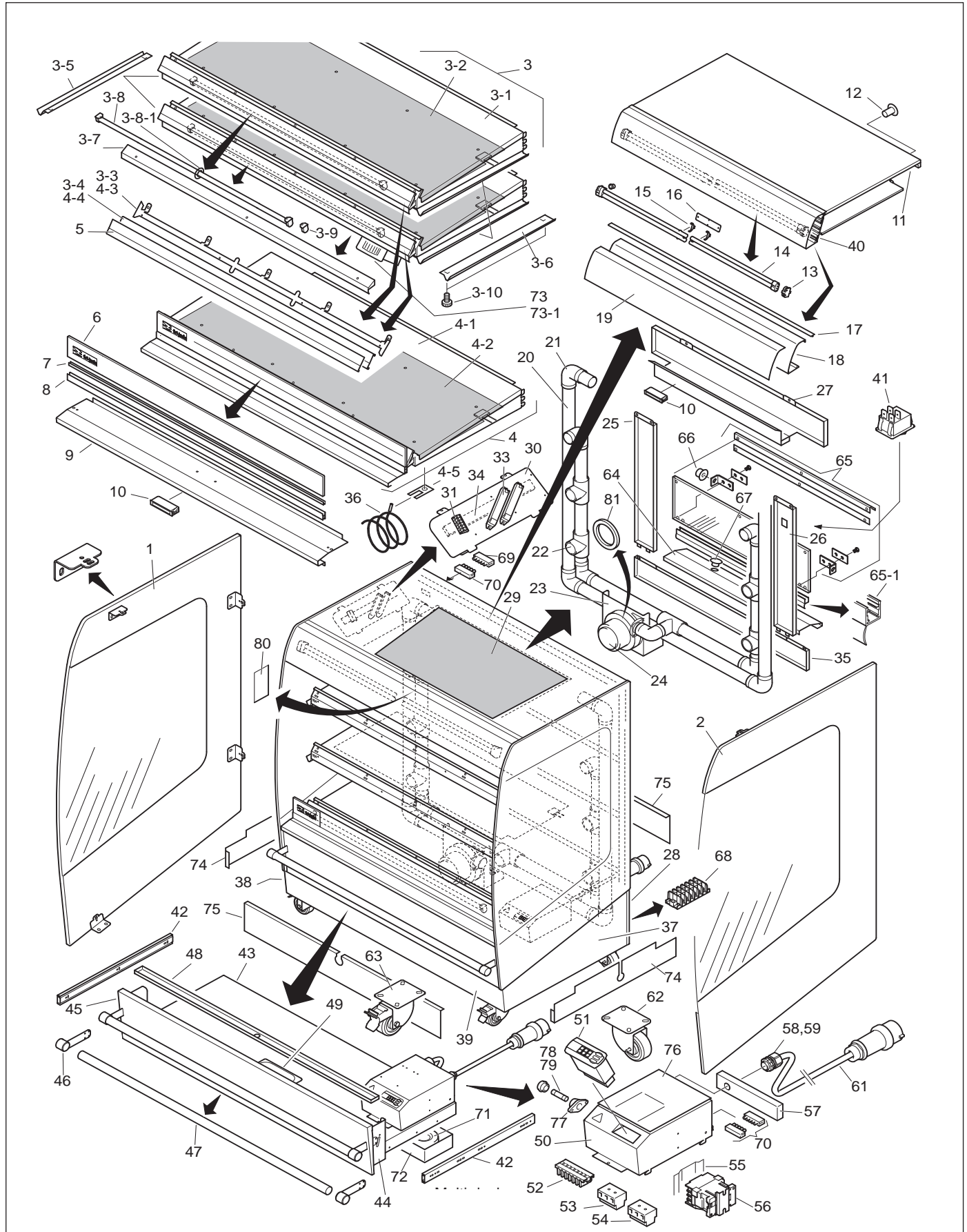

Item	Part number	Model	Qty	Description	Item	Part number	Model	Qty	Description
1	92200315	all models	1	Glass panel, left, ass.	4-3	9226555	MD 48	1	Holder, price rail
2	92200305	all models	1	Glass panel, right, ass.	4-4	9223200	MD 24	1	Price rail, transparent
3	9220281	M24	2	Shelf ass. Incl. heating element	4-4	9223208	MD 40	1	Price rail, transparent
3	9220261	MD 40	2	Shelf ass. Incl. heating element	4-4	9223207	MD 48	1	Price rail, transparent
3	9220241	MD 48	2	Shelf ass. Incl. heating element	4-5	9224718	all models	1	Sensor holder
3-1	9226202	MD 24	2	Top plate, shelf	5	9222626	MD 24	3	Diastrip, price rail
3-1	9226402	MD 40	2	Top plate, shelf	5	9222625	MD 40	3	Diastrip, price rail
3-1	9226602	MD 48	2	Top plate, shelf	5	9222624	MD 48	3	Diastrip, price rail
3-2	9222450	MD 24	2	Heating element, 208 V, 600 W	5A	9222426	MD 24	3	Diastrip, price rail till serial nr. 100075759
3-2	9222427	MD 40	2	Heating element, 208 V, 900 W	5A	9222425	MD 40	3	Diastrip, price rail till serial nr. 100075759
3-2	9222428	MD 48	2	Heating element, 208 V, 1060 W	5A	9222424	MD 48	3	Diastrip, price rail till serial nr. 100075759
3-3	9226156	MD 24	2	Holder, price rail	6	9222465	MD 24	1	Childguard
3-3	9226355	MD 40	2	Holder, price rail	6	9222466	MD 40	1	Childguard
3-3	9226555	MD 48	2	Holder, price rail	6	9222467	MD 48	1	Childguard
3-4	9223200	MD 24	2	Price rail, transparent	7	9221012	MD 24	0.6 mtr	Plastic profile
3-4	9223208	MD 40	2	Price rail, transparent	7	9221012	MD 40	1 mtr	Plastic profile
3-4	9223207	MD 48	2	Price rail, transparent	7	9221012	MD 48	1.2 mtr	Plastic profile
3-5	9226108	all models	2	Airblock profile, left	8	9223212	MD 24	1	Holder, childguard
3-6	9226109	all models	2	Airblock profile, right	8	9223211	MD 40	1	Holder, childguard
3-7	9226116	MD 24	2	Light fixture	8	9223210	MD 48	1	Holder, childguard
3-7	9226321	MD 40	2	Light fixture	9	9226150	MD 24	1	Cover profile
3-7	9226521	MD 48	2	Light fixture	9	9226354	MD 40	1	Cover profile
3-8	92210265	MD 24	2	TL lamp 8 W, with 1 rubber locking ring	9	9226554	MD 48	1	Cover profile
3-8	92210275	MD 40-48	2	TL lamp 21 W, with 1 rubber locking ring	10	3701025	all models	7	Doormagnet
3-8-1	9221050	all models	4	Locking ring	11	9226155	MD 24	1	Top plate
3-9	9221025	all models	4	Lamp holder	11	9226350	MD 40	1	Top plate
3-10	4280560	all models	8	Knurled bolt M5x10	11	9226550	MD 48	1	Top plate
4	9220297	MD 24	1	Shelf ass. Incl. heating element	12	9281039	all models	2	Plug, 14.3 mm
4	9220262	MD 40	1	Shelf ass. Incl. heating element	13	9221030	MD 24	1	Lamp holder
4	9220242	MD 48	1	Shelf ass. Incl. heating element	13	9221030	MD 40-48	2	Lamp holder
4-1	9226202	MD 24	1	Top plate, shelf	14	9160019	MD 24	1	Lamp, PLL 55 W
4-1	9226402	MD 40	1	Top plate, shelf	14	9221006	MD 40	2	Lamp, PLL 36 W
4-1	9226602	MD 48	1	Top plate, shelf	14	9160019	MD 48	2	Lamp, PLL 55 W
4-2	9222450	MD 24	1	Heating element, 208 V, 600 W	15	9222210	MD 24	1	Bracket, lamp
4-2	9222427	MD 40	1	Heating element, 208 V, 900 W	15	9222210	MD 40-48	2	Bracket, lamp
4-2	9222428	MD 48	1	Heating element, 208 V, 1060 W	16	9224721	all models	1	Clamp plate
4-3	9226156	MD 24	1	Holder, price rail	17	9221032	MD 24	0.6 mtr	PVC T-profile
4-3	9226355	MD 40	1	Holder, price rail	17	9221032	MD 40	1 mtr	PVC T-profile
					17	9221032	MD 48	1.2 mtr	PVC T-profile
					18	9223218	MD 24	1	Plastic cover
					18	9223217	MD 40	1	Plastic cover
					18	9223216	MD 48	1	Plastic cover
					19	9222622	MD 24	1	Dia strip, top
					19	9222621	MD 40	1	Dia strip, top
					19	9222620	MD 48	1	Dia strip, top

Item	Part number	Model	Qty	Description
19A	9222422	MD 24	1	Dia strip, top till serial nr. 100075759
19A	9222421	MD 40	1	Dia strip, top till serial nr. 100075759
19A	9222420	MD 48	1	Dia strip, top till serial nr. 100075759
20	9281035	all models		PVC tube Ø 50 x 3.7 mm
21	9281032	all models		PVC elbow 50 mm
22	9281033	all models		PVC T-joint 50 mm
23	9220509	all models	1	Support for blower
24	9191280	all models	1	Blower
25	9226206	all models	1	Cover panel, right
26	9226207	all models	1	Cover panel, left
27	9226121	MD 24	1	Magnet holder profile, top
27	9226324	MD 40	1	Magnet holder profile, top
27	9226524	MD 48	1	Magnet holder profile, top
28	9226117	MD 24	1	Rear plate, bottom
28	9226358	MD 40	1	Rear plate, bottom
28	9226558	MD 48	1	Rear plate, bottom
29	9222449	MD 24	1	Heating element top, 208 V, 400 W
29	9222450	MD 40	1	Heating element top, 208 V, 600 W
29	9222427	MD 48	1	Heating element top, 208 V, 900 W
30	9224727	all models	1	Mounting plate, electrical components
31	8072071	all models	1	Connecting block
33	9221045	MD 24	2	Ballast, 4-28 W
33	9221069	MD 40-48	1	Ballast, 2x21 W
34	9222065	MD 24	1	Ballast, 55 W
34	9222064	MD 40	1	Ballast, 2x55 W
34	9222065	MD 48	1	Ballast, 2x55 W
35	9226122	MD 24	1	Cover panel, bottom
35	9226325	MD 40	1	Cover panel, bottom
35	9226525	MD 48	1	Cover panel, bottom
36	9221011	all models	1	Temperature sensor
37	9224703	all models	1	Side panel, right
38	9224702	all models	1	Side panel, left
39	9226151	MD 24	1	Front panel, bottom side
39	9226356	MD 40	1	Front panel, bottom side
39	9226556	MD 48	1	Front panel, bottom side
40	9223222	MD 24	1	Base profile, Alum.
40	9223221	MD 40	1	Base profile, Alum.
40	9223220	MD 48	1	Base profile, Alum.
41	9181008	all models	1	Tumble switch
42	9221023	all models	1 set	Drawer slide
43	9226102	MD 24	1	Base plate, drawer
43	9226316	MD 40	1	Base plate, drawer
43	9226516	MD 48	1	Base plate, drawer

Item	Part number	Model	Qty	Description
44	9226119	MD 24	1	Reinforcement profile
44	9226326	MD 40	1	Reinforcement profile
44	9226526	MD 48	1	Reinforcement profile
45	9226104	MD 24	1	Front, drawer
45	9226317	MD 40	1	Front, drawer
45	9226517	MD 48	1	Front, drawer
46	9220503	all models	2	Endcover, bar
47	9223215	MD 24	1	Bumper bar
47	9223214	MD 40	1	Bumper bar
47	9223213	MD 48	1	Bumper bar
48	9226120	MD 24	1	Drip tray
48	9226327	MD 40	1	Drip tray
48	9226527	MD 48	1	Drip tray
49	9221031	all models	1	GN tray 1/9
50	9224681	all models	1	Connection box
51	92211095	all models	1	Thermostat ERC 211
52	9151010	all models	1	Connecting block, 6-pol.
53	9044564	all models	1	Connecting block, 1,2,3
54	9044572	MD 40-48	1	Connecting block, 4,5,6
55	9077088	all models	1	Rail
56	3500069	all models	1	Contactora
57	9224662	all models	1	Connection profile
58	9221033	all models	2	Strain relief M25
59	9261023	all models	2	Nut M25
60	6511519	all models	2	Coupling PG 16
61	9172401	MD 24	1	Connecting cable with plug 6-20P
61	9172409	MD 40-48	1	Connecting cable with plug 6-30P
62	9172125	MD 24	2	Ridget caster
62	9172065	MD 40-48	2	Swivel caster
63	9172066	all models	2	Swivel caster with break
64	9226115	MD 24	3	Base profile swingdoor
64	9226319	MD 40	3	Base profile swingdoor
64	9226519	MD 48	3	Base profile swingdoor
65	92202945	MD 24	3	Swingdoor, ass.
65	92202745	MD 40	3	Swingdoor, ass.
65	92202545	MD 48	3	Swingdoor, ass.
65-1	9221056	MD 24	0.17 mtr	Profile sealing, with side lip
65-1	9221056	MD 40	0.57 mtr	Profile sealing, with side lip
65-1	9221056	MD 48	0.77 mtr	Profile sealing, with side lip
66	0602072	all models	6	Brass bearing 6 mm
67	9172419	all models	6	Plug, 20.6 mm
68	8033659	all models	1	Connecting block 9-pole
69	9221036	all models	2	Plug 4-pole
70	9221037	all models	2	Socket 4-pole
71	9222302	all models	1	Ringcore transformer
72	9224682	all models	1	Cover box transformer
73	9229801	all models	1	Temperature indicator, ass.
73-1	9221048	all models	1	Temperature indicator

Item	Part number	Model	Qty	Description
74	9224669	all models	2	Plinth, short
75	9226118	MD 24	2	Plinth, long
75	9226357	MD 40	2	Plinth, long
75	9226557	MD 48	2	Plinth, long
76	9224680	all models	1	Cover plate box
77	9044205	all models	3	Fuse holder HPS-EE
78	9110250	all models	2	Fuse SC10A
79	9181049	all models	1	Fuse SC2.5A
80	9123492	all models	1	Indication plate
81	9224761	MD 24-40	1	Restriction ring

MULTI DECK 24 - 3 LEVEL SOLID BACK 120 V

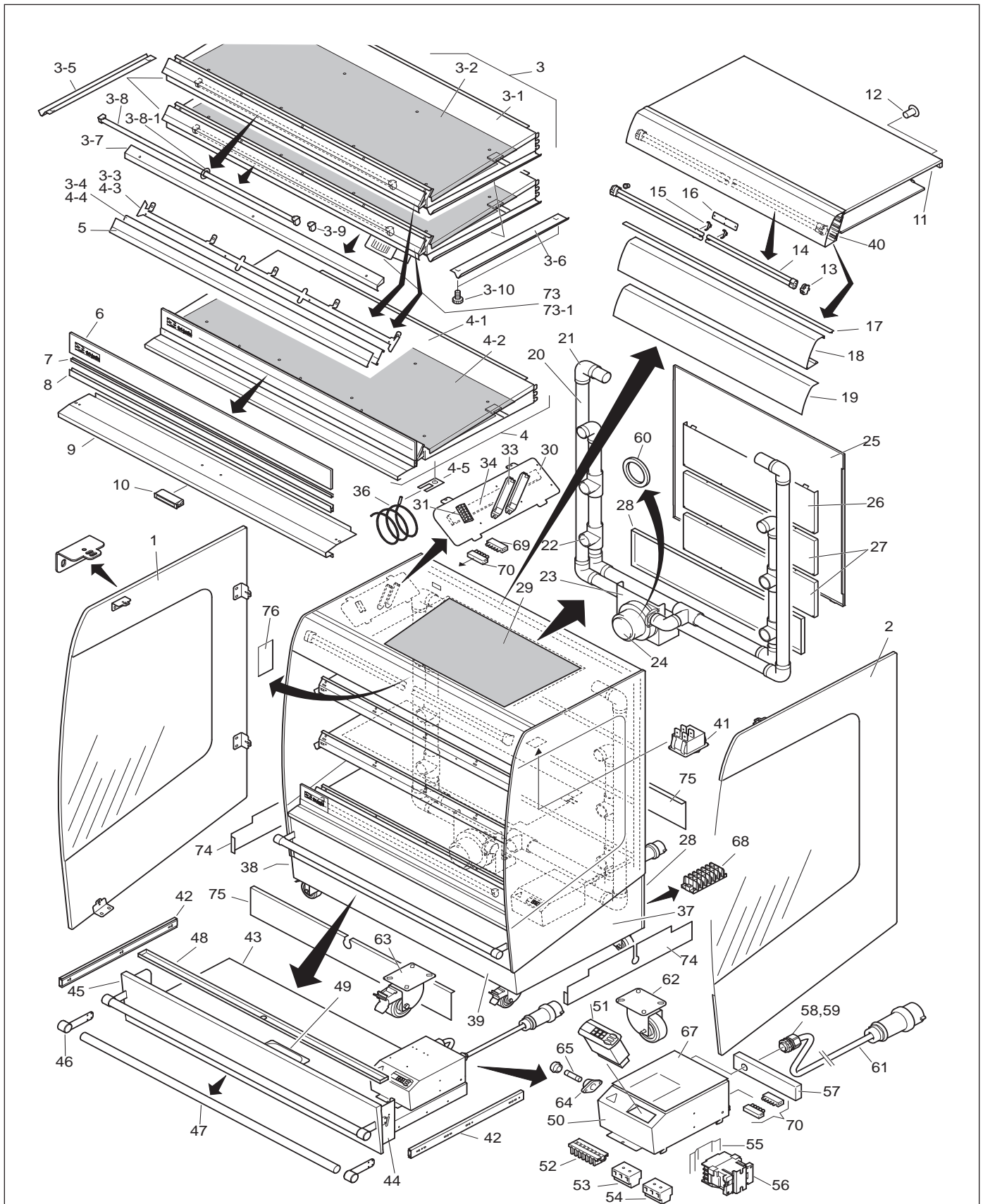

Item	Part number	Qty	Description
1	92200315	1	Glass panel, left, ass.
2	92200305	1	Glass panel, right, ass.
3	2	Shelf ass. Incl. heating element
3-1	9226202	2	Top plate, shelf
3-2	9222463	2	Heating element, 120 V, 600 W
3-3	9226156	2	Holder, price rail
3-4	9223200	2	Price rail, transparent
3-5	9226108	2	Airblock profile, left
3-6	9226109	2	Airblock profile, right
3-7	9226116	2	Light fixture
3-8	92210265	2	TL lamp 8 W, with 1 rubber locking ring
3-8-1	9221050	2	Locking ring
3-9	9221025	4	Lamp holder
3-10	4280560	8	Knurled bolt M5x10
4	1	Shelf ass. Incl. heating element
4-1	9226202	1	Top plate, shelf
4-2	9222463	1	Heating element, 120 V, 600 W
4-3	9226156	1	Holder, price rail
4-4	9223200	1	Price rail, transparent
4-5	9224718	1	Sensor holder
5	9222626	3	Diastrip. price rail
5A	9222426	3	Diastrip, price rail till serial nr. 100075759
6	9222465	1	Childguard
7	9221012	0.6 mtr	Plastic profile
8	9223212	1	Holder, childguard
9	9226150	1	Cover profile
10	3701025	1	Doormagnet
11	9226155	1	Top plate
12	9281039	2	Plug, 14.3 mm
13	9221030	1	Lamp holder
14	9160019	1	Lamp, PLL 55 W
15	9222210	1	Bracket, lamp
16	9224721	1	Clamp plate
17	9221032	0.6 mtr	PVC T-profile
18	9223218	1	Plastic cover
19	9222622	1	Dia strip, top
19A	9222422	1	Dia strip, top till serial nr. 100075759
20	9281035		PVC tube Ø 50 x 3.7 mm
21	9281032		PVC elbow 50 mm
22	9281033		PVC T-joint 50 mm
23	9220509	1	Support for blower
24	9191280	1	Blower
25	9226105	1	Rear panel
26	9226112	1	Rear plate, inside top

Item	Part number	Qty	Description
27	9226113	2	Rear plate, inside
28	9226117	1	Rear plate, bottom
29	9222464	1	Heating element top, 120 V, 400 W
30	9224727	1	Mounting plate, electrical components
31	8072071	1	Connecting block
33	9221052	2	Ballast, 4-28W, 120 V
34	9222065	1	Ballast, 55 W
36	9221011	1	Temperature sensor
37	9224703	1	Side panel, right
38	9224702	1	Side panel, left
39	9226151	1	Front panel, bottom side
40	9223222	1	Base profile, Alum.
41	9181008	1	Tumble switch
42	9221023	1 set	Drawer slide
43	9226102	1	Base plate, drawer
44	9226119	1	Reinforcement profile
45	9226104	1	Front, drawer
46	9220503	2	Endcover, bar
47	9223215	1	Bumper bar
48	9226120	1	Drip tray
49	9221031	1	GN tray 1/9
50	9224681	1	Connection box
51	9221155	1	Thermostat ERC 211, 115 V
52	9151010	1	Connecting block, 6-pol.
53	9044564	1	Connecting block, 1-2-3
54	9044572	1	Connecting block, 4-5-6
55	9077088	1	Rail
56	9221054	1	Contacteur
57	9224662	1	Connection profile
58	9222076	2	Strain relief M20
59	9222077	2	Nut M20
60	9224761	1	Restriction ring
61	9222468	1	Connecting cable with plug 5-30P
62	9172125	2	Ridget caster
63	9172066	2	Swivel caster with break
64	9044205	3	Fuse holder HPS-EE
65	9110250	2	Fuse SC10A
67	9224680	1	Cover plate box
68	8033659	1	Connecting block, 9-pole
69	9221036	2	Plug 4-pole
70	9221037	2	Socket 4-pole
73	9229801	1	Temperature indicator, ass.
73-1	9221048	1	Temperature indicator
74	9224669	2	Plinth, short
75	9226118	2	Plinth, long
76	9123492	1	Indication plate

MULTI DECK 24/40/48 - 5 LEVEL SOLID BACK

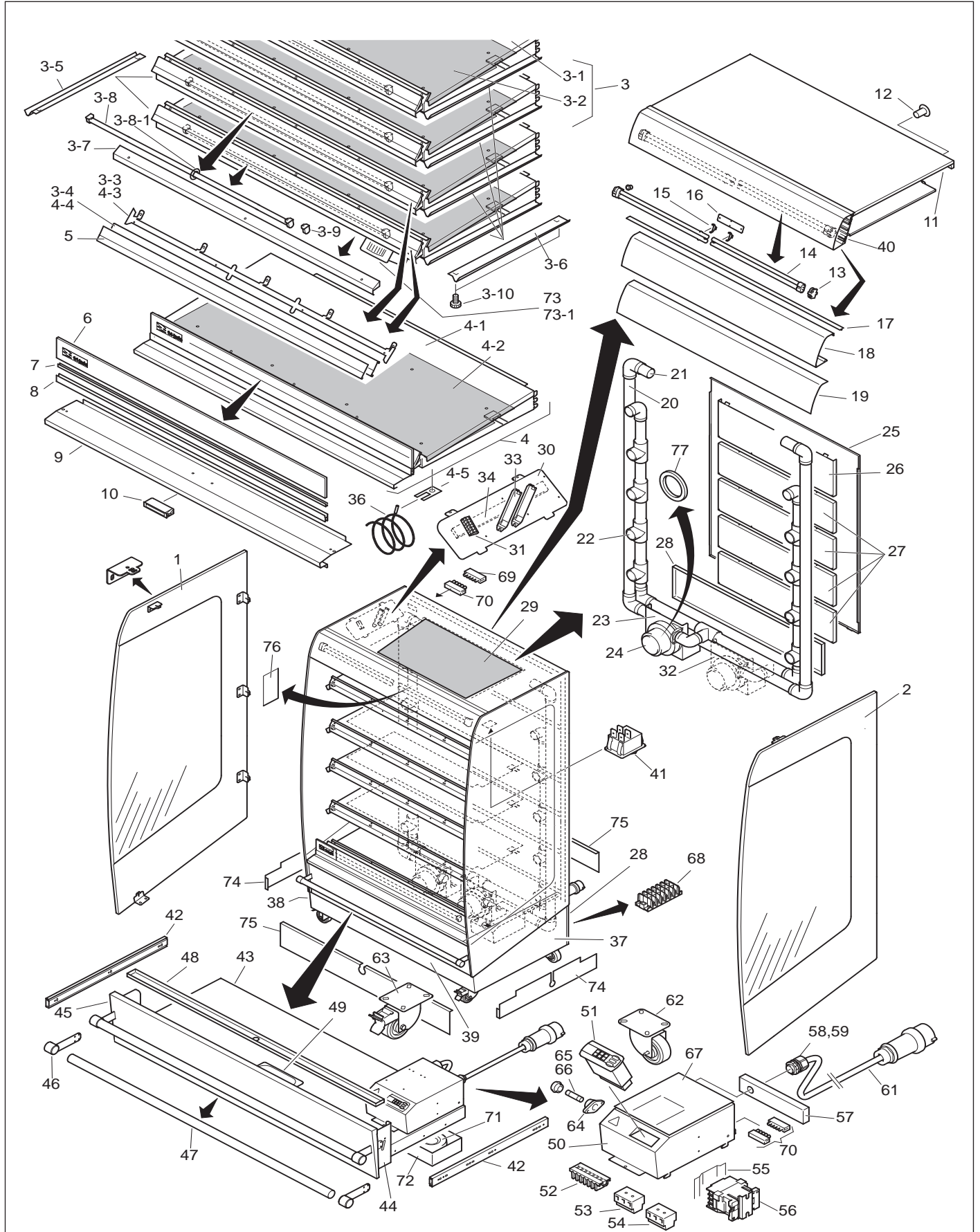

Item	Part number	Model	Qty	Description	Item	Part number	Model	Qty	Description
1	9220033S	all models	1	Glass panel, left, ass.	4-3	9226555	MD 48	1	Holder, price rail
2	9220032S	all models	1	Glass panel, right, ass.	4-4	9223200	MD 24	1	Price rail, transparent
3	9220281	MD 24	4	Shelf ass. Incl. heating element	4-4	9223208	MD 40	1	Price rail, transparent
3	9220261	MD 40	4	Shelf ass. Incl. heating element	4-4	9223207	MD 48	1	Price rail, transparent
3	9220241	MD 48	4	Shelf ass. Incl. heating element	4-5	9224718	all models	1	Sensor holder
3-1	9226202	MD 24	4	Top plate, shelf	5	9222626	MD 24	3	Diastrip, price rail
3-1	9226402	MD 40	4	Top plate, shelf	5	9222625	MD 40	3	Diastrip, price rail
3-1	9226602	MD 48	4	Top plate, shelf	5	9222624	MD 48	3	Diastrip, price rail
3-2	9222450	MD 24	4	Heating element, 208 V, 600 W	5A	9222426	MD 24	3	Diastrip, price rail till serial nr. 100075759
3-2	9222427	MD 40	4	Heating element, 208 V, 900 W	5A	9222425	MD 40	3	Diastrip, price rail till serial nr. 100075759
3-2	9222428	MD 48	4	Heating element, 208 V, 1060 W	5A	9222424	MD 48	3	Diastrip, price rail till serial nr. 100075759
3-3	9226156	MD 24	4	Holder, price rail	6	9222465	MD 24	1	Childguard
3-3	9226355	MD 40	4	Holder, price rail	6	9222466	MD 40	1	Childguard
3-3	9226555	MD 48	4	Holder, price rail	6	9222467	MD 48	1	Childguard
3-4	9223200	MD 24	4	Price rail, transparent	7	9221012	MD 24	0.6 mtr	Plastic profile
3-4	9223208	MD 40	4	Price rail, transparent	7	9221012	MD 40	1 mtr	Plastic profile
3-4	9223207	MD 48	4	Price rail, transparent	7	9221012	MD 48	1.2 mtr	Plastic profile
3-5	9226108	all models	4	Airblock profile, left	8	9223212	MD 24	1	Holder, childguard
3-6	9226109	all models	4	Airblock profile, right	8	9223211	MD 40	1	Holder, childguard
3-7	9226116	MD 24	4	Light fixture	8	9223210	MD 48	1	Holder, childguard
3-7	9226321	MD 40	4	Light fixture	9	9226150	MD 24	1	Cover profile
3-7	9226521	MD 48	4	Light fixture	9	9226354	MD 40	1	Cover profile
3-8	9221026S	MD 24	4	TL lamp 8 W, with 1 rubber locking ring	9	9226554	MD 48	1	Cover profile
3-8	9221027S	MD 40-48	4	TL lamp 21 W, with 1 rubber locking ring	10	3701025	all models	1	Doormagnet
3-8-1	9221050	all models	8	Locking ring	11	9226155	MD 24	1	Top plate
3-9	9221025	all models	8	Lamp holder	11	9226350	MD 40	1	Top plate
3-10	4280560	all models	16	Knurled bolt M5x10	11	9226550	MD 48	1	Top plate
4	9220297	MD 24	1	Shelf ass. Incl. heating element	12	9281039	all models	2	Plug, 14.3 mm
4	9220262	MD 40	1	Shelf ass. Incl. heating element	13	9221030	MD 24	1	Lamp holder
4	9220242	MD 48	1	Shelf ass. Incl. heating element	13	9221030	MD 40-48	2	Lamp holder
4-1	9226202	MD 24	1	Top plate, shelf	14	9160019	MD 24	1	Lamp, PLL 55 W
4-1	9226402	MD 40	1	Top plate, shelf	14	9221006	MD 40	2	Lamp, PLL 36 W
4-1	9226602	MD 48	1	Top plate, shelf	14	9160019	MD 48	2	Lamp, PLL 55 W
4-2	9222450	MD 24	1	Heating element, 208 V, 600 W	15	9222210	MD 24	1	Bracket, lamp
4-2	9222427	MD 40	1	Heating element, 208 V, 900 W	15	9222210	MD 40-48	2	Bracket, lamp
4-2	9222428	MD 48	1	Heating element, 208 V, 1060 W	16	9224721	all models	1	Clamp plate
4-3	9226156	MD 24	1	Holder, price rail	17	9221032	MD 24	0.6 mtr	PVC T-profile
4-3	9226355	MD 40	1	Holder, price rail	17	9221032	MD 40	1 mtr	PVC T-profile
					17	9221032	MD 48	1.2 mtr	PVC T-profile
					18	9223218	MD 24	1	Plastic cover
					18	9223217	MD 40	1	Plastic cover
					18	9223216	MD 48	1	Plastic cover
					19	9222622	MD 24	1	Dia strip, top
					19	9222621	MD 40	1	Dia strip, top
					19	9222620	MD 48	1	Dia strip, top

Item	Part number	Model	Qty	Description
19A	9222422	MD 24	1	Dia strip, top till serial nr. 100075759
19A	9222421	MD 40	1	Dia strip, top till serial nr. 100075759
19A	9222420	MD 48	1	Dia strip, top till serial nr. 100075759
20	9281035	all models		PVC tube Ø 50 x 3.7 mm
21	9281032	all models		PVC elbow 50 mm
22	9281033	all models		PVC T-joint 50 mm
23	9220509	MD 24	1	Support for blower
23	9220509	MD 40-48	1	Support for blower
24	9191280	MD 24	1	Blower
24	9191280	MD 40-48	2	Blower
25	9226129	MD 24	1	Rear panel
25	9226314	MD 40	2	Rear panel (2 parts)
25	9226514	MD 48	2	Rear panel (2 parts)
26	9226112	MD 24	1	Rear plate, inside top
26	9226312	MD 40	1	Rear plate, inside top
26	9226512	MD 48	1	Rear plate, inside top
27	9226113	MD 24	4	Rear plate, inside
27	9226313	MD 40	4	Rear plate, inside
27	9226513	MD 48	4	Rear plate, inside
28	9226117	MD 24	1	Rear plate, bottom
28	9226358	MD 40	1	Rear plate, bottom
28	9226558	MD 48	1	Rear plate, bottom
29	9222449	MD 24	1	Heating element top, 208 V, 400 W
29	9222450	MD 40	1	Heating element top, 208 V, 600 W
29	9222427	MD 48	1	Heating element top, 208 V, 900 W
30	9224727	all models	1	Mounting plate, electrical components
31	8072071	all models	1	Connecting block
32	9220501	MD 40-48	1	Support for blower
33	9221045	MD 24	2	Ballast, 4-28W
33	9221069	MD 40-48	2	Ballast, 2x21 W
34	9222065	MD 24	1	Ballast, 55 W
34	9222064	MD 40	1	Ballast, 2x55 W
34	9222065	MD 48	1	Ballast, 2x55 W
36	9221011	all models	1	Temperature sensor
37	9224703	all models	1	Side panel, right
38	9224702	all models	1	Side panel, left
39	9226151	MD 24	1	Front panel, bottom side
39	9226356	MD 40	1	Front panel, bottom side
39	9226556	MD 48	1	Front panel, bottom side
40	9223222	MD 24	1	Base profile, Alum.
40	9223221	MD 40	1	Base profile, Alum.
40	9223220	MD 48	1	Base profile, Alum.

Item	Part number	Model	Qty	Description
41	9181008	all models	1	Tumble switch
42	9221023	all models	1 set	Drawer slide
43	9226102	MD 24	1	Base plate, drawer
43	9226316	MD 40	1	Base plate, drawer
43	9226516	MD 48	1	Base plate, drawer
44	9226119	MD 24	1	Reinforcement profile
44	9226326	MD 40	1	Reinforcement profile
44	9226526	MD 48	1	Reinforcement profile
45	9226104	MD 24	1	Front, drawer
45	9226317	MD 40	1	Front, drawer
45	9226517	MD 48	1	Front, drawer
46	9220503	all models	2	Endcover, bar
47	9223215	MD 24	1	Bumper bar
47	9223214	MD 40	1	Bumper bar
47	9223213	MD 48	1	Bumper bar
48	9226120	MD 24	1	Drip tray
48	9226327	MD 40	1	Drip tray
48	9226527	MD 48	1	Drip tray
49	9221031	all models	1	GN tray 1/9
50	9224681	all models	1	Connection box
51	92211095	all models	1	Thermostat ERC 211
52	9151010	all models	1	Connecting block, 6-pol.
53	9044564	all models	1	Connecting block, 1-2-3
54	9044572	MD 25	1	Connecting block, 4-5-6
55	9077088	all models	1	Rail
56	3500069	all models	1	Contacto
57	9224662	all models	1	Connection profile
58	9221033	all models	2	Strain relief M25
59	9261023	all models	2	Nut M25
61	9172409	MD 24	1	Connecting cable with plug 6-30P
61	9172403	MD 40	1	Connecting cable with plug 15-20P
61	9172404	MD 48	1	Connecting cable with plug 15-30P
62	9172125	MD 24	2	Ridget caster
62	9172065	MD 40-48	2	Swivel caster
63	9172066	all models	2	Swivel caster with break
64	9044205	all models	3	Fuse holder HPS-EE
65	9110250	all models	2	Fuse SC10A
66	9181049	all models	1	Fuse SC2.5A
67	9224680	all models	1	Cover plate box
68	8033659	all models	1	Connecting block, 9-pole
69	9221036	all models	2	Plug 4-pole
70	9221037	all models	2	Socket 4-pole
71	9222302	all models	1	Ringcore transformer
72	9224682	all models	1	Cover box transformer

Item	Part number	Model	Qty	Description
73	9229801	all models	1	Temperature indicator, ass.
73-1	9221048	all models	1	Temperature indicator
74	9224669	all models	2	Plinth, short
75	9226118	MD 24	2	Plinth, long
75	9226357	MD 40	2	Plinth, long
75	9226557	MD 48	2	Plinth, long
76	9123492	all models	1	indication plate
77	9224761	MD 40	2	Restriction ring

MULTI DECK 24/40/48 - 5 LEVEL PASS THROUGH

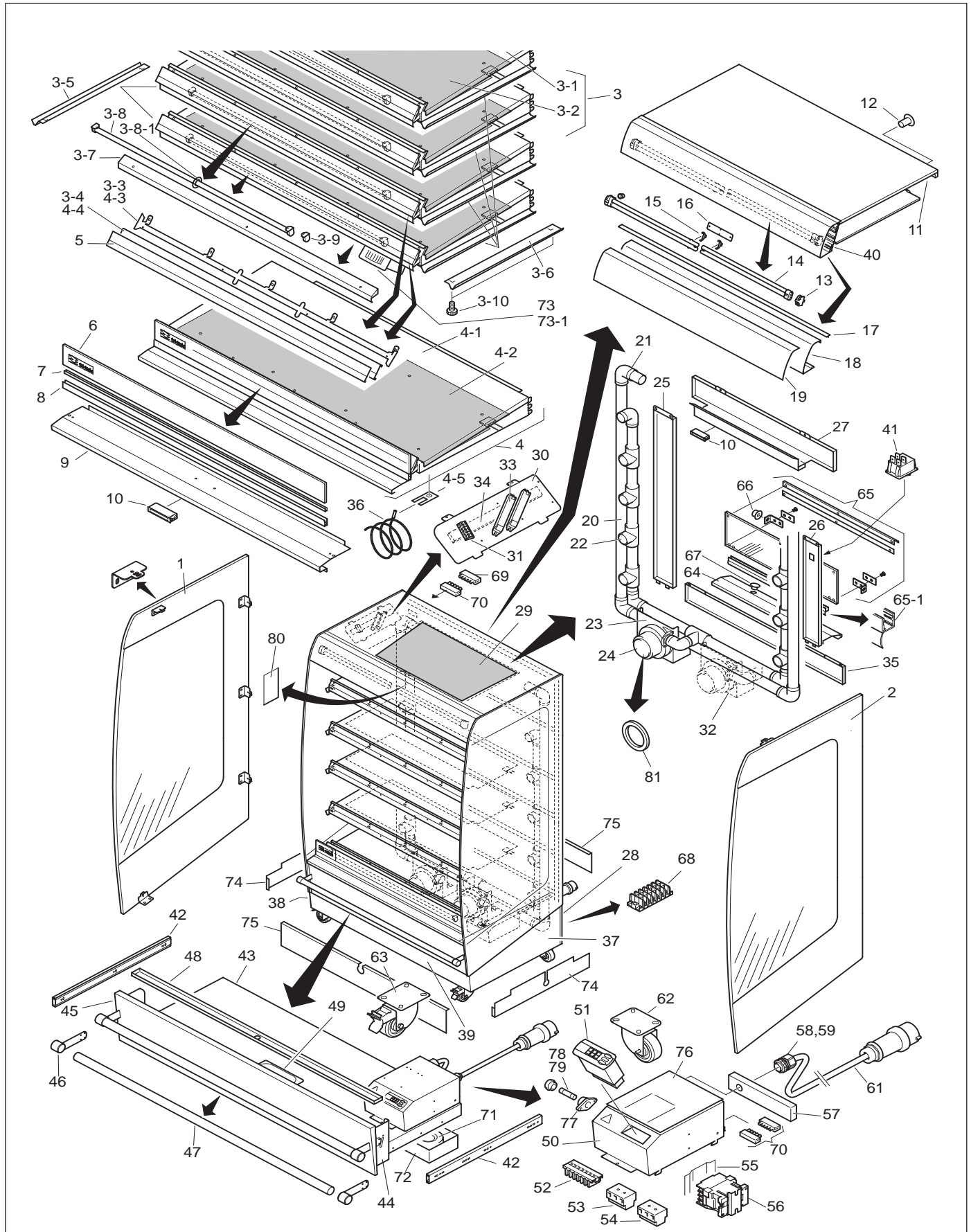

Item	Part number	Model	Qty	Description
1	92200335	all models	1	Glass panel, left, ass.
2	92200325	all models	1	Glass panel, right, ass.
3	9220281	MD 24	4	Shelf ass. Incl. heating element
3	9220261	MD 40	4	Shelf ass. Incl. heating element
3	9220241	MD 48	4	Shelf ass. Incl. heating element
3-1	9226202	MD 24	4	Top plate, shelf
3-1	9226402	MD 40	4	Top plate, shelf
3-1	9226602	MD 48	4	Top plate, shelf
3-2	9222450	MD 24	4	Heating element, 208 V, 600 W
3-2	9222427	MD 40	4	Heating element, 208 V, 900 W
3-2	9222428	MD 48	4	Heating element, 208 V, 1060 W
3-3	9226156	MD 24	4	Holder, price rail
3-3	9226355	MD 40	4	Holder, price rail
3-3	9226555	MD 48	4	Holder, price rail
3-4	9223200	MD 24	4	Price rail, transparent
3-4	9223208	MD 40	4	Price rail, transparent
3-4	9223207	MD 48	4	Price rail, transparent
3-5	9226108	all models	4	Airblock profile, left
3-6	9226109	all models	4	Airblock profile, right
3-7	9226116	MD 24	4	Light fixture
3-7	9226321	MD 40	4	Light fixture
3-7	9226521	MD 48	4	Light fixture
3-8	92210265	MD 24	4	TL lamp 8 W, with 1 rubber locking ring
3-8	92210275	MD 40-48	4	TL lamp 21 W, with 1 rubber locking ring
3-8-1	9221050	all models	8	Locking ring
3-9	9221025	all models	8	Lamp holder
3-10	4280560	all models	16	Knurled bolt M5x10
4	9220297	MD 24		Shelf ass. Incl. heating element
4	9220262	MD 40	1	Shelf ass. Incl. heating element
4	9220242	MD 48	1	Shelf ass. Incl. heating element
4-1	9226202	MD 24	1	Top plate, shelf
4-1	9226402	MD 40	1	Top plate, shelf
4-1	9226602	MD 48	1	Top plate, shelf
4-2	9222450	MD 24	1	Heating element, 208 V, 600 W
4-2	9222427	MD 40	1	Heating element, 208 V, 900 W
4-2	9222428	MD 48	1	Heating element, 208 V, 1060 W
4-3	9226156	MD 24	1	Holder, price rail
4-3	9226355	MD 40	1	Holder, price rail

Item	Part number	Model	Qty	Description
4-3	9226555	MD 48	1	Holder, price rail
4-4	9223200	MD 24	1	Price rail, transparent
4-4	9223208	MD 40	1	Price rail, transparent
4-4	9223207	MD 48	1	Price rail, transparent
4-5	9224718	all models	1	Sensor holder
5	9222626	MD 24	3	Diastrip, price rail
5	9222625	MD 40	3	Diastrip, price rail
5	9222624	MD 48	3	Diastrip, price rail
5A	9222426	MD 24	3	Diastrip, price rail till serial nr. 100075759
5A	9222425	MD 40	3	Diastrip, price rail till serial nr. 100075759
5A	9222424	MD 48	3	Diastrip, price rail till serial nr. 100075759
6	9222465	MD 24	1	Childguard
6	9222466	MD 40	1	Childguard
6	9222467	MD 48	1	Childguard
7	9221012	MD 24	0.6 mtr	Plastic profile
7	9221012	MD 40	1 mtr	Plastic profile
7	9221012	MD 48	1.2 mtr	Plastic profile
8	9223212	MD 24	1	Holder, childguard
8	9223211	MD 40	1	Holder, childguard
8	9223210	MD 48	1	Holder, childguard
9	9226150	MD 24	1	Cover profile
9	9226354	MD 40	1	Cover profile
9	9226554	MD 48	1	Cover profile
10	3701025	all models	1	Doormagnet
11	9226155	MD 24	1	Top plate
11	9226350	MD 40	1	Top plate
11	9226550	MD 48	1	Top plate
12	9281039	all models	2	Plug, 14.3 mm
13	9221030	MD 24	1	Lamp holder
13	9221030	MD 40-48	2	Lamp holder
14	9160019	MD 24	1	Lamp, PLL 55 W
14	9221006	MD 40	2	Lamp, PLL 36 W
14	9160019	MD 48	2	Lamp, PLL 55 W
15	9222210	MD 24	1	Bracket, lamp
15	9222210	MD 40-48	2	Bracket, lamp
16	9224721	all models	1	Clamp plate
17	9221032	MD 24	0.6 mtr	PVC T-profile
17	9221032	MD 40	1 mtr	PVC T-profile
17	9221032	MD 48	1.2 mtr	PVC T-profile
18	9223218	MD 24	1	Plastic cover
18	9223217	MD 40	1	Plastic cover
18	9223216	MD 48	1	Plastic cover
19	9222622	MD 24	1	Dia strip, top
19	9222621	MD 40	1	Dia strip, top
19	9222620	MD 48	1	Dia strip, top

Item	Part number	Model	Qty	Description
19A	9222422	MD 24	1	Dia strip, top till serial nr. 100075759
19A	9222421	MD 40	1	Dia strip, top till serial nr. 100075759
19A	9222420	MD 48	1	Dia strip, top till serial nr. 100075759
20	9281035	all models		PVC tube Ø 50 x 3.7 mm
21	9281032	all models		PVC elbow 50 mm
22	9281033	all models		PVC T-joint 50 mm
23	9220509	MD 24	1	Support for blower
23	9220509	MD 40-48	1	Support for blower
24	9191280	MD 24	1	Blower
24	9191280	MD 40-48	2	Blower
25	9226206	all models	1	Cover panel, right
26	9226207	all models	1	Cover panel, left
27	9226121	MD 24	1	Magnet holder profile, top
27	9226324	MD 40	1	Magnet holder profile, top
27	9226524	MD 48	1	Magnet holder profile, top
28	9226117	MD 24	1	Rear plate, bottom
28	9226358	MD 40	1	Rear plate, bottom
28	9226558	MD 48	1	Rear plate, bottom
29	9222449	MD 24	1	Heating element top, 208 V, 400 W
29	9222450	MD 40	1	Heating element top, 208 V, 600 W
29	9222427	MD 48	1	Heating element top, 208 V, 900 W
30	9224727	all models	1	Mounting plate, electrical components
31	8072071	all models	1	Connecting block
32	9220501	MD 40-48	1	Support for blower
33	9221045	MD 24	2	Ballast, 4-28 W
33	9221069	MD 40-48	2	Ballast, 2x21 W
34	9222065	MD 25	1	Ballast, 55 W
34	9222064	MD 40	1	Ballast, 2x55 W
34	9222065	MD 48	1	Ballast, 2x55 W
35	9226122	MD 24	1	Cover panel, bottom
35	9226325	MD 40	1	Cover panel, bottom
35	9226525	MD 48	1	Cover panel, bottom
36	9221011	all models	1	Temperature sensor
37	9224703	all models	1	Side panel, right
38	9224702	all models	1	Side panel, left
39	9226151	MD 24	1	Front panel, bottom side
39	9226356	MD 40	1	Front panel, bottom side
39	9226556	MD 48	1	Front panel, bottom side
40	9223222	MD 24	1	Base profile, Alum.
40	9223221	MD 40	1	Base profile, Alum.
40	9223220	MD 48	1	Base profile, Alum.
41	9181008	all models	1	Tumble switch
42	9221023	all models	1 set	Drawer slide

Item	Part number	Model	Qty	Description
43	9226102	MD 24	1	Base plate, drawer
43	9226316	MD 40	1	Base plate, drawer
43	9226516	MD 48	1	Base plate, drawer
44	9226119	MD 24	1	Reinforcement profile
44	9226326	MD 40	1	Reinforcement profile
44	9226526	MD 48	1	Reinforcement profile
45	9226104	MD 24	1	Front, drawer
45	9226317	MD 40	1	Front, drawer
45	9226517	MD 48	1	Front, drawer
46	9220503	all models	2	Endcover, bar
47	9223215	MD 24	1	Bumper bar
47	9223214	MD 40	1	Bumper bar
47	9223213	MD 48	1	Bumper bar
48	9226120	MD 24	1	Drip tray
48	9226327	MD 40	1	Drip tray
48	9226527	MD 48	1	Drip tray
49	9221031	all models	1	GN tray 1/9
50	9224681	all models	1	Connection box
51	9221109S	all models	1	Thermostat ERC 211
52	9151010	all models	1	Connecting block, 6-pol.
53	9044564	all models	1	Connecting block, 1,2,3
54	9044572	MD 25	1	Connecting block, 4,5,6
55	9077088	all models	1	Rail
56	3500069	all models	1	Contacto
57	9224662	all models	1	Connection profile
58	9221033	all models	2	Strain relief M25
59	9261023	all models	2	Nut M25
61	9172409	MD 24	1	Connecting cable with plug 6-30P
61	9172403	MD 40	1	Connecting cable with plug 15-20P
61	9172404	MD 48	1	Connecting cable with plug 15-30P
62	9172125	MD 24	2	Ridget caster
62	9172065	MD 40-48	2	Swivel caster
63	9172066	all models	2	Swivel caster with break
64	9226115	MD 24	5	Base profile swingdoor
64	9226319	MD 40	5	Base profile swingdoor
64	9226519	MD 48	5	Base profile swingdoor
65	9220294S	MD 24	5	Swingdoor, ass.
65	9220274S	MD 40	5	Swingdoor, ass.
65	9220254S	MD 48	5	Swingdoor, ass.
65-1	9221056	MD 24	0.17 mtr	Profile sealing, with side lip
65-1	9221056	MD 40	0.57 mtr	Profile sealing, with side lip
65-1	9221056	MD 48	0.77 mtr	Profile sealing, with side lip
66	0602072	all models	10	Brass bearing 6 mm
67	9172419	all models	10	Plug, 20.6 mm

Item	Part number	Model	Qty	Description
68	8033659	all models	1	Connecting block 9-pole
69	9221036	all models	2	Plug 4-pole
70	9221037	all models	2	Socket 4-pole
71	9222302	all models	1	Ringcore transformer
72	9224682	all models	1	Cover box transformer
73	9229801	all models	1	Temperature indicator, ass.
73-1	9221048	all models	1	Temperature indicator
74	9224669	all models	2	Plinth, short
75	9226118	MD 24	2	Plinth, long
75	9226357	MD 40	2	Plinth, long
75	9226557	MD 48	2	Plinth, long
76	9224680	all models	1	Cover plate box
77	9044205	all models	3	Fuse holder HPS-EE
78	9110250	all models	2	Fuse SC10A
79	9181049	all models	1	Fuse SC2.5A
80	9123492	all models	1	Indication plate
81	9224761	MD 40	2	Restriction ring

CIRCUIT DIAGRAM MULTI DECK 24 - 3 LEVEL 120 V

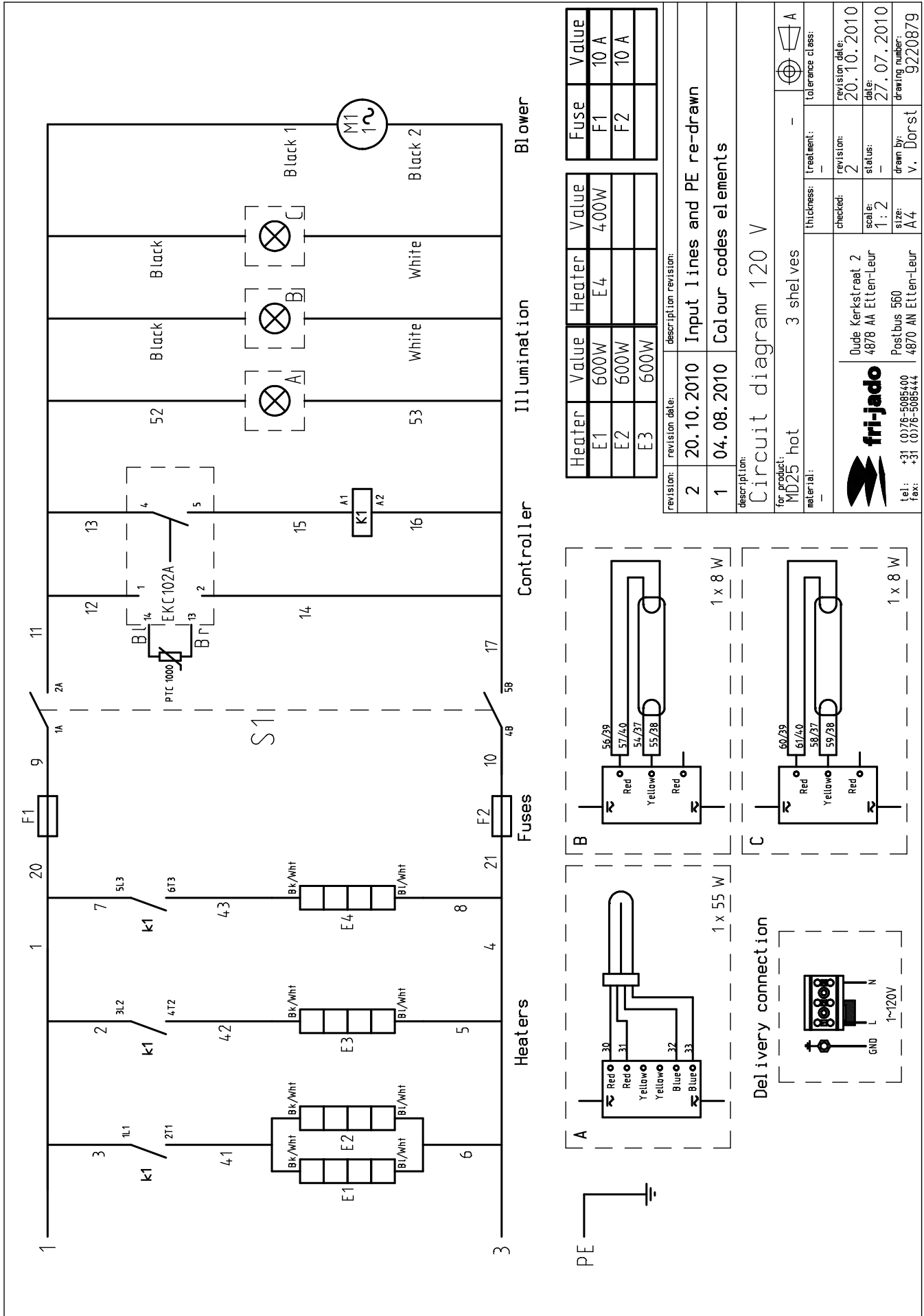

Heater	Value	Heater	Value
E1	600W	E4	400W
E2	600W		
E3	600W		

Fuse	Value
F1	10 A
F2	10 A

revision	revision date:	description	revision:
2	20.10.2010	Input lines and PE re-drawn	
1	04.08.2010	Colour codes elements	

description:		for product:		material:		checked:		revision date:	
Circuit diagram 120 V		MD25 hot		3 shelves		thickness: -		revision: 2	
								date: 20.10.2010	
								status: -	
								size: 27.07.2010	
								drawing number: 9220879	
								drawn by: V. Dorst	
								tolerance class: A	
								treatment: -	
								checked: 2	
								scale: 1:2	
								size: A4	
								drawn by: V. Dorst	
								drawing number: 9220879	

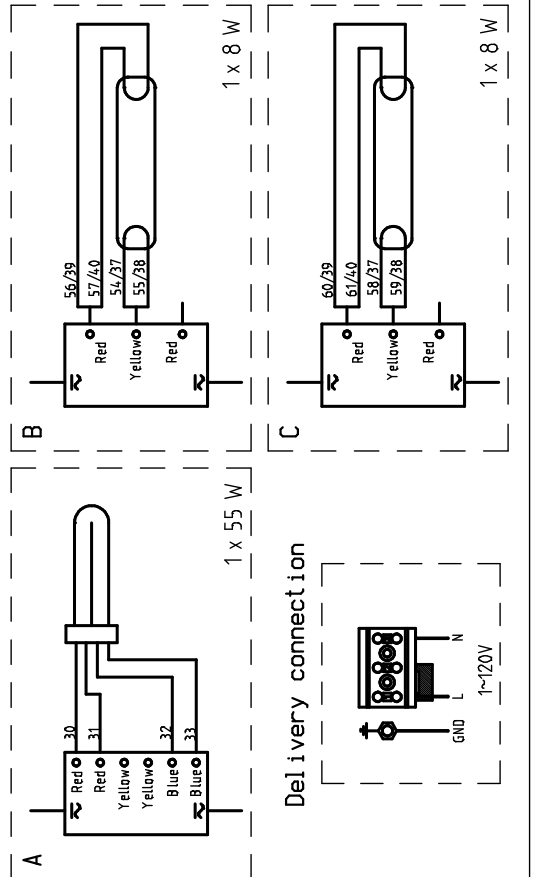

EMPTY PAGE

For technical support call: 877 392-7851
For parts call: 877 374-5236

