



Application Series

Frymaster **Dean**



Frymaster, a member of the Commercial Food Equipment Service Association, recommends using CFESA Certified Technicians.

Price: \$4.00
OCTOBER 11

24-Hour Service Hotline 1-800-551-8633

8196141A

NOTICE

This appliance is intended for professional use only and is to be operated by qualified personnel only. A Frymaster/Dean Factory Authorized Servicer (FAS) or other qualified professional should perform installation, maintenance, and repairs. Installation, maintenance, or repairs by unqualified personnel may void the manufacturer's warranty. See Chapter 1 of this manual for definitions of qualified personnel.

NOTICE

This equipment must be installed in accordance with the appropriate national and local codes of the country and/or region in which the appliance is installed. See NATIONAL CODE REQUIREMENTS in Chapter 3 of this manual for specifics.

NOTICE

Drawings and photos used in this manual are intended to illustrate operational, cleaning and technical procedures and may not conform to onsite management operational procedures.

NOTICE TO OWNERS OF UNITS EQUIPPED WITH COMPUTERS

U.S.

This device complies with Part 15 of the FCC rules. Operation is subject to the following two conditions: 1) This device may not cause harmful interference, and 2) This device must accept any interference received, including interference that may cause undesired operation. While this device is a verified Class A device, it has been shown to meet Class B limits.

CANADA

This digital apparatus does not exceed the Class A or B limits for radio noise emissions as set out by the ICES-003 standard of the Canadian Department of Communications.

Cet appareil numérique n'émet pas de bruits radioélectriques dépassant les limites de classe A et B prescrites dans la norme NMB-003 édictée par le Ministre des Communications du Canada.

DANGER

Improper installation, adjustment, maintenance or service, and unauthorized alterations or modifications can cause property damage, injury, or death. Read the installation, operating and service instructions thoroughly before installing or servicing this equipment. Only qualified service personnel may convert this appliance to use a gas other than that for which it was originally configured. See Chapter 1 of this manual for definition of qualified service personnel.

DANGER

Adequate means must be provided to limit the movement of this appliance without depending upon the gas line connection. Single fryers equipped with legs must be stabilized by installing anchor straps. All fryers equipped with casters must be stabilized by installing restraining chains. If a flexible gas line is used, an additional restraining cable must be connected at all times when the fryer is in use.

⚠ DANGER

The front ledge of the fryer is not a step. Do not stand on the fryer. Serious injury can result from slips or contact with the hot oil.

⚠ DANGER

Do not store or use gasoline or other flammable vapors and liquids in the vicinity of this or any other appliance.

⚠ DANGER

Instructions to be followed in the event the operator smells gas or otherwise detects a gas leak must be posted in a prominent location. This information can be obtained from the local gas company or gas supplier.

⚠ DANGER

The crumb tray in fryers equipped with a filter system must be emptied into a fireproof container at the end of frying operations each day. Some food particles can spontaneously combust if left soaking in certain shortening material. Additional information can be obtained in the filtration manual included with the system.

⚠ WARNING

No structural material on the fryer should be altered or removed to accommodate placement of the fryer under a hood. Questions? Call the Frymaster/Dean Service Hotline at 1-800-551-8633.

⚠ WARNING

Do not bang fry baskets or other utensils on the fryer's joiner strip. The strip is present to seal the joint between the frypot. Banging fry baskets on the strip to dislodge shortening will distort the strip, adversely affecting its fit. It is designed for a tight fit and should only be removed for cleaning.

NOTICE

If, during the warranty period, the customer uses a part for this Manitowoc Food Service equipment other than an unmodified new or recycled part purchased directly from Frymaster/Dean, or any of its authorized services, and/or the part being used is modified from its original configuration, this warranty will be void. Further, Frymaster/Dean and its affiliates will not be liable for any claims, damages or expenses incurred by the customer which arise directly or indirectly, in whole or in part, due to the installation of any modified part and/or part received from an unauthorized servicer.

NOTICE

The Commonwealth of Massachusetts requires any and all gas products to be installed by a licensed plumber or pipe fitter.



Application Series Gas Fryers

Installation and Filtration Quick Reference

Manuals appropriate for the fryer models installed in this Application Series cabinet are included with the fryer. See those manuals for fryer-specific operation instructions.

Table of Contents

	Page
Introduction	1-1
After Purchase	1-1
Ordering Parts	1-1
Service Information	1-1
Computer Information	1-1
Safety Information	1-2
Service Personnel	1-2
Important Information	2-1
Receiving and Unpacking Equipment	2-1
General	2-1
Rating Plate	2-2
Pre-Installation	2-3
Air Supply and Ventilation	2-4
Equipment Installed at High Altitudes	2-4
Installation	3-1
Installing the Fryer	3-1
Leveling the Fryer (Fryers equipped with legs only)	3-1
Installing Casters and Legs	3-1
Gas Connections	3-1
Adjustments/Adaptation to Different Gases	3-5
Electrical Connections	3-6
Filtration Quick Reference	4-1

Application Series: Introduction

1.1 After Purchase

In order to improve service, have the following chart filled in by the Frymaster or Dean Authorized Servicer who installed this equipment.

Authorized Service	
Technician	
FAS Address	
Telephone/Fax	
Model Number	
Serial Number	
Gas Type	

To speed up your order, provide the model number, serial number, gas type, part needed, item part number (if known), and quantity needed.

1.2 Ordering Parts

Customers may order parts directly from their local factory authorized service center. For this address and phone number, contact your factory authorized servicer or call the Frymaster and Dean Service Hotline number, 1-800-551-8633.

1.3 Service Information

Call the Frymaster and Dean Service Hotline, 1-800-551-8633, for the location of your nearest factory authorized servicer. To assist you more efficiently, always provide the service technician with the model number, gas type, serial number, and the nature of the problem.

1.4 Computer Information

This equipment has been tested and found to comply with the limits for a Class A digital device, pursuant to Part 15 of the FCC rules. While this device is a verified Class A device, it has been shown to meet the Class B limits. These limits are designed to provide reasonable protection against harmful interference when the equipment is operated in a commercial environment. This equipment generates, uses and can radiate radio frequency energy and, if not installed and used in accordance with the instruction manual, may cause harmful interference to radio communications. Operation of the equipment in a residential area is likely to cause harmful interference in which case the user will be required to correct the interference at his own expense.

The user is cautioned that any changes or modifications not expressly approved by the party responsible for compliance could void the user's authority to operate the equipment. If necessary, the user should consult the dealer or an experienced radio and television technician for additional suggestions. The user may find the following booklet, prepared by the Federal Communications Commission, helpful: "How to Identify and Resolve Radio-TV Interference Problems". This booklet is available from the U.S. Government Printing Office, Washington, DC

Application Series: Introduction

20402, Stock No. 004-000-00345-4.

1.5 Safety Information

Before attempting to operate your unit, read the instructions in this manual and in the fryer - specific manuals which accompany this Application Series fryer thoroughly.

Throughout this manual, you will find statements enclosed in bordered boxes, similar to the ones below. Be attentive to the caution, warning and danger issues they introduce.

1.6 Service Personnel

1.6.1 Definitions

A. Qualified and/or Authorized Operating Personnel

1. Qualified/authorized operating personnel are those who have carefully read the information in this manual and have familiarized themselves with the equipment functions, or have had previous experience with the operation of equipment covered in this manual.

B. Qualified Installation Personnel

1. Qualified installation personnel are individuals, firms, corporations, and/or companies, which, either in person or through a representative, are engaged in and are responsible for the installation of gas-fired appliances. Qualified personnel must be experienced in such work, be familiar with all gas precautions involved, and have complied with all requirements of applicable national and local codes.

C. Qualified Service Personnel

1. Qualified service personnel are those who are familiar with Frymaster and Dean equipment and have been authorized by Frymaster and Dean to perform service on Frymaster and Dean equipment. All authorized service personnel are required to be equipped with a complete set of service parts manuals and stock a minimum amount of parts for Dean and Frymaster equipment. A list of Factory Authorized Servicers (FASs) is located on the Frymaster website at www.frymaster.com. Failure to use qualified service personnel will void the warranty on your equipment.

CAUTION

Caution boxes contain information about actions or conditions that may cause or result in a malfunction of your system.

WARNING

Warning boxes contain information about actions or conditions that may cause or result in damage to your system, and which may cause your system to malfunction.

DANGER

Danger boxes contain information about actions or conditions that may cause or result in injury to personnel, and which may cause damage to your system and/or cause your system to malfunction.

Application Series: Important Information

2.1 Receiving and Unpacking Equipment

- A. Check that the container is upright. Use an outward prying motion - no hammering - to remove the carton. Unpack the fryer carefully and remove all accessories from the carton. Do not discard or misplace these, as they will be needed.
- B. After unpacking, immediately check the equipment for visible signs of shipping damage. If damage has occurred, contact the carrier and file the appropriate freight claims. Do not contact the factory. Shipping damage responsibility is between the carrier and the dealer.

If your equipment arrives damaged:

1. File claim for damages immediately, regardless of extent of damage.
2. Be sure visible loss or damage is noted on the freight bill or express receipt and is signed by the person making the delivery.
3. If damage is unnoticed until equipment is unpacked, notify freight company or carrier immediately, and file a concealed damage claim. This should be done within 15 days of date of delivery. Be sure to retain container and all packing materials for inspection.

Note: Frymaster and Dean Do Not Assume Responsibility for Damage or Loss Incurred in Transit.

- C. Four-battery systems: Casters are pre-installed on the frying system and the carton is furnished with three unloading ramps. Remove the braces from the front casters by taking out the securing bolts. Carefully roll the unit down the ramps from the front (cooking side).
- D. Remove all plastic skin from sides, front, and doors of the fryer(s). Failure to do this prior to initial fryer operation will make it very difficult to remove later.

2.2 General

Qualified, licensed, and/or authorized installation or service personnel only (as defined in Section 1.6) should perform the following:

- Installation and service on equipment.
- Conversion of this appliance from one gas type to another.

Failure to use qualified, licensed, and/or authorized installation or service personnel to install, convert to another gas type or otherwise service this equipment will void the warranty and may result in damage to the equipment or injury to personnel.

Application Series: Important Information

Where conflicts exist between instruction/ information in this manual and local or national codes or regulations, installation and operation shall comply with the codes or regulations in force in the country in which the equipment is installed.

Upon arrival, inspect the fryer carefully for visible or concealed damage. (See Receiving and Unpacking Equipment in Section 2.1.)

2.2.1 Product Description

See supplied manuals for specific fryers installed in Application Series fryer.

2.3 Principles of Operation

See supplied manuals for specific fryers installed in Application Series fryer.

2.4 Rating Plate

A rating plate is attached to the inside front door panel for each fryer. Information provided includes the model and serial number of the fryer, BTU/hr input of the burners, outlet gas pressure in inches W.C. and whether the unit has natural or propane gas orifices.

DANGER

Building codes prohibit a fryer with its open tank or hot oil/shortening from being installed beside an open flame or any time, including those of broilers and ranges.

Caution

Fryers equipped with legs are for stationary installations. Appliances fitted with legs must be lifted during movement to avoid damage to the appliance and bodily injury. For moveable installations, optional equipment casters must be used. For moveable installations, optional equipment casters must be used. Questions? Call 1-800-551-8633.

Warning

The on-site supervisor is responsible for ensuring that operators are made aware of the inherent hazard of operating a hot oil frying system, particularly the aspects of system operation, oil filtration, draining and cleaning procedures.

Danger

Fryers **MUST** be connected **ONLY** to the gas type identified on the attached rating plate.

Application Series: Important Information

2.5 Pre-Installation

A. General: Only licensed personnel should install any gas-fired equipment.

1. A manual gas shut-off valve must be installed in the gas supply line ahead of the fryers for safety and ease of future service.

2. See supplied manual for specific fryers in the Application Series for power requirements.

B. Clearances: The fryer area must be kept free and clear of all combustibles. This unit is design-certified for the following installations:

1. Commercial installation only (not for household use).

2. Non-combustible floor installation equipped with factory-supplied 6-inch (15-cm) adjustable legs or 5-inch (13-cm) casters;

3. Combustible construction with a minimum clearance of 6-inches (15-cm) side and 6-inches (15-cm) rear, and equipped with factory-supplied 6-inch (15-cm) adjustable legs or 5-inch (13-cm) casters.

C. Installation Standards

<p>U.S. installations must meet: American National Standards Institute ANSI Z83.11 American Gas Association 8501 E. Pleasant Valley Road Cleveland, OH 44131</p> <p>National Electrical Code AMSI/NFPA #70 American National Standard Institute 1430 Broadway New York, NY 10018</p> <p>NFPA Standards #96 and #211 National Fire Protection Association 470 Atlantic Avenue Boston, MA 02110</p>	<p>Canadian installations must meet:</p> <p>CAN 1-B149 Installation Codes Canadian Gas Association 55 Scarsdale Road Don Mills, ONT, M3B 2R3</p> <p>Canadian Electric Code c22.14, part 1 Canadian Standards Association 178 Rexdale Blvd. Rexdale, OT M9W 1R3</p> <p>Australian Requirements To be installed in accordance with AS5601/AG601, local authority, gas, electricity and any other relevant statutory regulations.</p>
--	--

 **Danger**

Do not connect this appliance to the gas supply before reviewing all information in this chapter.

Application Series: Important Information

2.6 Air Supply and Ventilation

Keep the area around the fryer clear to prevent obstruction of combustion and ventilation airflow as well as for service and maintenance.

A. Do not connect this fryer to an exhaust duct.

B. Correct installation and adjustment will ensure adequate airflow to the fryer system.

C. A commercial, heavy-duty fryer must vent its combustion wastes to the outside of the building. A deep-fat fryer must be installed under a powered exhaust hood, or an exhaust fan must be provided in the wall above the unit, as exhaust gas temperatures are approximately 800-1000°F (427-538°C). Check air movement during installation. Strong exhaust fans in the exhaust hood or in the overall air conditioning system can produce slight air drafts in the room.

D. Do not place the fryer's flue outlet directly into the plenum of the hood, as it will affect the gas combustion of the fryer.

E. Never use the interior of the fryer cabinet for storage or store items on shelving over or behind the fryer. Exhaust temperatures can exceed 800°F (427°C) and may damage or melt items stored in or near the fryer.

F. Adequate distance must be maintained from the flue outlet of the fryer(s) to the lower edge of the filter bank. Per NFPA Standards No. 96, a minimum of 18-inches (45-cm) should be maintained between the flue(s) and the lower edge of the exhaust hood filter.

G. Filters and drip troughs should be part of any industrial hood, but consult local codes before constructing and installing any hood. The duct system, the exhaust hood and the filter bank must be cleaned on a regular basis and kept free of grease.

 Danger
This appliance must be installed with sufficient ventilation to prevent the occurrence of unacceptable concentrations of substances harmful to the health of personnel in the room in which it is installed.

2.7 Equipment Installed at High Altitudes

A. The fryer input rating (BTU/hr) is for elevations up to 2,000 feet (610-m). For elevations above 2,000 feet (610-m), the rating should be reduced four percent for each additional 1,000 feet (305-m) above sea level.

B. The correct orifices are installed at the factory if operating altitude is known at time of the customer's order.

Application Series: Installation

3.1 Installing the Fryer

- A. **Initial Installation:** If the fryer is installed with legs, do not push the fryer to adjust its position. Use a pallet or lift jack to lift the fryer slightly, then place the fryer where it is to be installed.
- B. **Relocating the fryer:** Remove all weight from each leg before moving a fryer with legs installed. Do not slide the fryer on the legs.
- C. If a leg becomes damaged, contact your service agent for immediate repair/replacement.

 **Danger**

Hot shortening can cause severe burns. Avoid contact. Under all circumstances, oil must be removed from the fryer before attempting to move it to avoid oil spills, and the falls and severe burns that could occur. This fryer may tip and cause personal injury if not secured in a stationary position.

3.2 Leveling the Fryer (Fryers equipped with legs only)

- A. **All Installations:** If the floor is uneven or has a definite slope, place the fryer on a level platform.
- B. Place a spirit level across the top of the fryer and level the unit both front-to-back and side-to-side. If it is not level, the unit may not function efficiently, the oil may not drain properly for filtering and in a line-up it may not match adjacent units.
- C. Adjust to the high corner and measure with the spirit level. If floor is uneven, level the unit with the screw adjustments on each leg (**ensure minimum clearances as discussed in Chapter 2 are maintained during the leveling procedure**).
- D. **Re-leveling:** If the fryer is moved, re-level the fryer following the above instructions.
- E. The install must be reviewed at the time of installation to ensure it meets the intent of these instructions.

 **Caution**

Fryers must be at room temperature, empty of oil and if fitted with legs, lifted during movement to avoid damage and possible bodily injury.

 **Warning**

Fryers equipped with legs are for permanent installations. Fryers fitted with legs must be lifted during movement to avoid damage and possible bodily injury. For a moveable or portable installation, optional equipment casters must be used. Questions? Call 1-800-551-8633.

3.3 Installing Casters and Legs

- A. Install casters and/or legs near where the fryer is to be used, as neither is secure for long transit. Application Series gas fryers cannot be curb mounted and must be equipped with either legs or casters provided.
- B. After unpacking, use a pallet or lift jack to raise the unit before installing the casters.
- C. Align the caster or leg base holes with the leg support assembly and insert bolt. Install

Application Series: Installation

the washers and nut hand tight, and repeat for all four holes in caster/leg base assembly.

- D. Tighten the caster/leg against the leg support assembly by using appropriate tools. Ensure that all four bolts are evenly tightened. Tighten the bolts to 50 inch-lbs. (5.65 Nm) torque.
- E. The level of the front casters can be adjusted. Remove the setscrew (see arrow below) and turn flange above wheel. The rear casters cannot be adjusted.



Arrow points to setscrew on front caster.

3.4 Gas Connections

National Code Requirements

This equipment is to be installed in compliance with the Basic Plumbing Code of the Building Officials and Code Administrators International, Inc. (BOCA) and the Food Service Sanitation Manual of the U.S. Food and Drug Administration.

This equipment is manufactured to use the type of gas specified on the rating plate attached to the door. Connect equipment stamped “NAT” only to natural gas and that stamped “PRO” only to LP (Propane) gas.

Installation must be made with a gas connector that complies with national and local codes. Quick-disconnect devices, if used, must likewise comply with national and local codes.

- A. The gas supply (service) line must be the same size or greater than the fryer inlet line. Depending on fryer configuration, the unit is equipped with 1/2 to 1-1/4-inch NPT male inlet. The gas supply line must be sized to accommodate all the gas-fired equipment that may be connected to that gas supply. Consult your contractor, gas company, supplier, or other knowledgeable authorities.

Danger

Before connecting new pipe to this appliance, the pipe must be blown out thoroughly to remove all foreign material. Foreign material in the burner and gas controls will cause improper and dangerous operation.

Application Series: Installation

Gas Supply Line Sizes		
Gas Type		
	2-3	4 or more*
Natural	1" (28mm)	1-1/4" (35mm)
Propane	3/4" (22mm)	1" (28mm)
* When exceeding 18 feet for a configuration of more than four fryers, provide a 1-1/4" (35mm) rigid gas connection.		

B. Rigid Connections: Check any installer-supplied intake pipe(s) and clean threading chips, or any other foreign matter before installing into a service line. If the intake pipes are not clear of all foreign matter, the orifices will clog when gas pressure is applied. Seal pipe joints with a sealant resistive to LP gas. When using thread compound on gas piping, use very small amounts and only on male threads. Use a pipe thread compound that is not affected by the chemical action of LP gases. **DO NOT** apply thread compound to the first two pipe threads—doing so will cause clogging of the burner orifices and control valve.

 **Danger**

The fryer must be connected to the gas supply specified on the rating and serial number plate located on the back of the fryer door.

C. Manual shut-off valve: This gas service supplier-installed valve must be installed in the gas service line ahead of the fryers in the gas stream and in a position where it can be reached quickly in the event of an emergency.

 **Danger**

If gas orders are detected, the gas supply **MUST** be shut off at the main shut-off valve. The local gas company or FASC should be contacted immediately to rectify the problem.

D. Regulating Gas Pressure: The fryer and shut-off valve must be disconnected from the gas supply during any pressure testing of the system.

1. External gas regulators are not normally required on this fryer. A safety control valve protects the fryer against pressure fluctuations. If the incoming pressure is in excess of 1/2" PSI (3.45 kPa/35 mbar), **a step-down regulator will be required.**

E. Manifold Pressure: Your local service technician should check the manifold pressure with a manometer.

1. Check the rating plate for specific manifold gas pressures. Natural gas units normally require 4" W.C., and propane units normally require 11" W.C. gas pressure.
2. Double check the arrow forged into the bottom of the regulator body, which shows gas flow direction. It should point downstream towards the fryers. The air vent cap is also part of the regulator and should not be removed.

Application Series: Installation

3. If a vent line from the gas pressure regulator is used, it should be installed in accordance with local codes or in the absence of local codes, with the National Fuel Gas Code, ANSI Z223.1-(latest edition).

F. Regulators can be adjusted in the field, but it is recommended that they not be unless the part is known to be out of adjustment or serious pressure fluctuations are found to exist and can be solved no other way.

G. Only qualified service personnel should make adjustments to the regulators.

H. Orifices: The fryer can be configured to operate on any available gas. The correct safety control valve, appropriate gas orifices, and pilot burner are installed at the factory. While the valve can be adjusted in the field, only qualified service personnel should make any adjustments with the proper test equipment.

I. Flexible Couplings, Connectors and Casters:

1. If the fryer is to be installed with flexible couplings and/or quick-disconnect fittings, the installer must use a heavy-duty AGA design-certified commercial flexible connector sized to accommodate the fryer configuration (with suitable strain reliefs), in compliance with the Standard for Connectors for Movable Gas Appliances, ANSI Z21.69-(latest edition) and Addenda Z21.69a-(latest edition). Quick disconnect devices must comply with the Standard for Quick-Disconnect Devices for Use with Gas Fuel, ANSI Z21.41-(latest edition).

2. The fryer must be restrained by means independent of the flexible coupling or connector in order to limit the movement of the fryer. Clips are located on the back panel of the fryer for the attachment of restraints.

3. If disconnection of the restraint is necessary, this restraint must be reconnected after the fryer has been returned to its originally installed position.

Danger

All connections must be sealed with a joint compound suitable for the gas being used and all connections must be tested with a solution of soapy water before lighting any pilots.

Never use matches, candles or any other ignition source to check for leaks. If gas odors are detected, shut off the gas supply to the appliance at the main shut-off valve and immediately contact the local gas company or an authorized service agency for service.

Danger

“Dry firing” your unit will cause damage to the frypot and can cause a fire. Always ensure that melted shortening, cooking oil or water is in the frypot before firing the unit.

Danger

When pressure testing incoming gas supply lines, disconnect the fryer from the gas line if the test pressure is 1/2 PSI (3.45 kPa or 14-inches water column or greater to avoid damage to the fryer’s gas piping and gas valve(s).

Application Series: Installation

- J. After hook-up, bleed the gas line of air to ensure that the pilot light will ignite quickly.

3.5 Adjustments/Adaptation To Different Gases

- A. Proper operation of Dean gas fryers requires operator to inspect the following adjustments in terms of:

1. Gas inputs and pressures.
2. Voltage and polarities of electrical power supplies.

- B. Frymaster and Dean gas fryers are manufactured to use the type of gas and pressure specified on the rating plate. When changing to a different gas, **adaptation must be performed by qualified personnel**. Failure to use qualified personnel will void the warranty.

3.5.1 Specifications

3.5.1.1 Adjustments to Different Gas Types

See fryer-specific manuals provided with the Application Series fryer for gas pressure information.

3.5.2 Gas Conversion Procedures

See fryer-specific manuals provided with the Application Series fryer for gas conversion procedures.

Contact factory with the following information when performing conversions:

- Fryer Serial Number
- Fryer Model Number
- Gas Type
- Operating Altitude

Conversions can only be executed by qualified, factory-authorized personnel.

Warning

Use a diluted soap solution to find potentially dangerous gas leaks when making new connections.

Warning

Do not attach accessories to this fryer unless the fryer is secured from tipping. Personal injury may result.

Danger

This appliance was configured at the factory for a specific type of gas. Converting from one gas type to another requires the installation of specific conversion components. Switching to a different type of gas without installing the proper conversion components may result in fire or explosion. Never attach this appliance to a gas supply for which it is not configured. Conversion of this appliance from one type of gas to another should only be performed by qualified, licensed and authorized installation or service personnel, as defined in section 1.6 of this manual.

Application Series: Installation

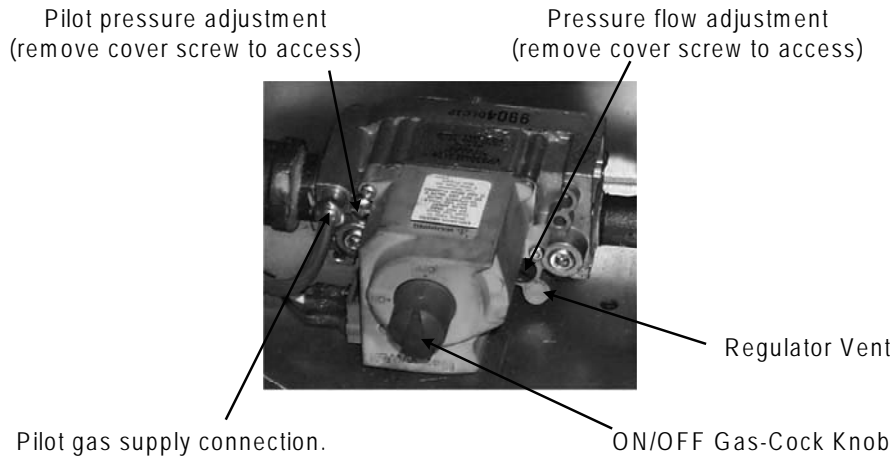

3.6 Electrical Connections

The fryer when installed must be electrically grounded in accordance with local codes, or in the absence of local codes, with the National Electrical Code, ANSI/NFPA 70- (latest edition).

The rating plate and wiring diagram are located inside the front door. See fryer-specific manuals provided with the Application Series fryer for electrical specifications. Do not cut or remove the ground prong from the power cord plug. Do not attempt to use the fryer during a power outage.

Danger

This fryer is equipped with a three-prong (grounding) plug for protection against electrical shock and must be plugged directly into a properly grounded, three-prong receptacle. **DO NOT CUT, REMOVE OR OTHERWISE BYPASS THE GROUNDING PRONG ON THIS PLUG!**

Danger

This appliance requires electrical power for operation. Place the gas control valve in the OFF position in case of a prolonged power outage. Do not attempt to operate this appliance during a power outage.

Application Series: Filtration

Boilout/Filtration

Boilout, the process that removes manufacturing related residue, is detailed in the manuals that accompany this Application Series fryer. Filtration is also covered in each manual. A Dean filter system is included with this unit. Follow the directions for pan preparation and filtration in the Decathlon manual, which shipped with the unit.

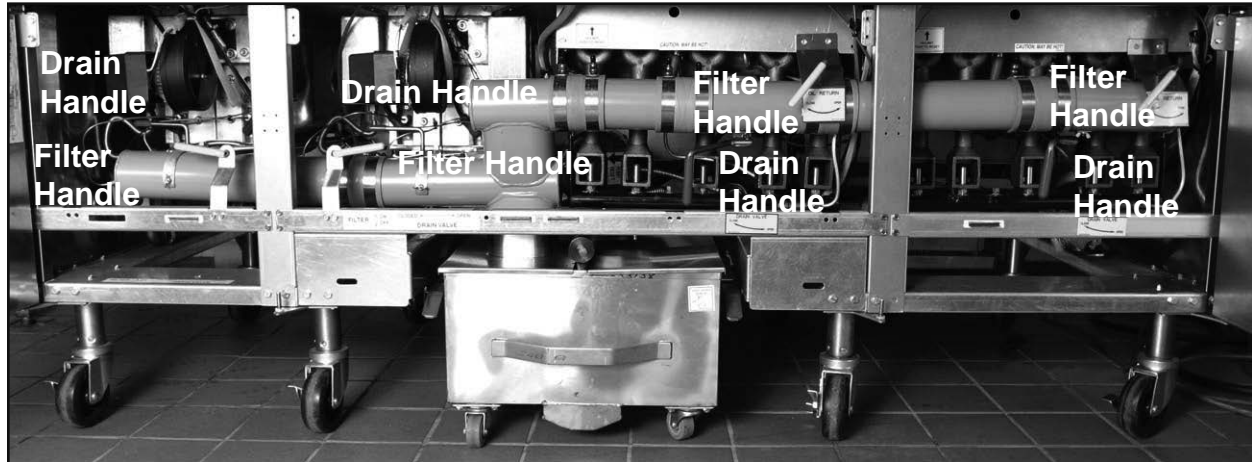

Above is an annotated view of the handles for the filter and drain operation unique to this unit. A quick reference for filtration of the unit is provided to the right and below.

Filtration begins with disassembling and cleaning the filter pan.

Filter Pan Reassembly

- Inner screen in the bottom of the pan.
- Filter paper on top of the screen.
- Hold-down ring on the filter paper, ensuring the filter paper laps onto the walls of the filter pan.
- Crumb screen, which catches large debris before it enters the frypot.
- The lid, which must be present.

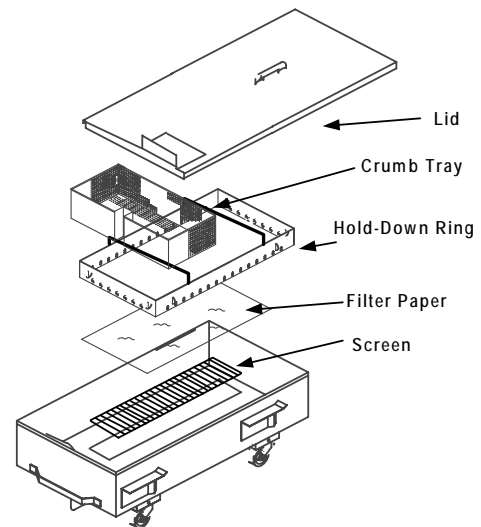

Oil Filtration

- Heat the oil to be filtered to operating temperature and turn the fryer off.
- Skim large debris from the oil.
- After ensuring the filter pan is properly prepared, open the drain (red handle) under the fryer to be filtered. DO NOT drain more than one vat of oil at a time into the filter pan and DO NOT filter cold oil. The pump motor will stall.

⚠ Warning
Use caution and wear protective clothing, Hot oil can cause serious injury.

Application Series: Filtration

- Oil flows from the frypot to the filter pan.
- Leave the drain valve open and turn on the filter pump (Yellow handle, See illustration on page 4-1).
- Oil flows from the filter pan to the frypot. Allow it to flow for five minutes.
- Close the drain valve; leave the filter pump on.
- Oil will fill the frypot.
- Bubbles will form in the frypot as the filter pan is emptied. Allow the bubbling to last 30-45 seconds, which clears the return line,
- Empty the crumb tray into a fireproof container. Certain oil and organic matter combinations can spontaneously combust.

THIS PAGE INTENTIONALLY LEFT BLANK.



Frymaster, L.L.C., 8700 Line Avenue, Shreveport, Louisiana 71106

TEL 318-865-1711

FAX (Parts) 318-219-7140

FAX (Tech Support) 318-219-7135

Service Hotline

1-800-551-8633

Price \$4.00
819-6141A
OCT 11