



**FE155 Rethernalizer**  
Installation and Operation Manual



Frymaster, a member of the Commercial Food Equipment Service Association, recommends using CFESA Certified Technicians.

**24-Hour Service Hotline 1-800-551-8633**

[www.frymaster.com](http://www.frymaster.com)

Email: [service@frymaster.com](mailto:service@frymaster.com)

**11/2016**



PRINTED IN THE  
USA

**Please read all sections of this manual and retain for future reference.**

**NOTICE**

This appliance is intended for professional use only and is to be operated by qualified personnel only. A Frymaster Factory Authorized Servicer (FAS) or other qualified professional should perform installation, maintenance, and repairs. Installation, maintenance, or repairs by unqualified personnel may void the manufacturer's warranty.

**NOTICE**

Drawings and photos used in this manual are intended to illustrate operational, cleaning and technical procedures and may not conform to onsite management operational procedures.

**NOTICE**

IF, DURING THE WARRANTY PERIOD, THE CUSTOMER USES A PART FOR THIS MANITOWOC FOOD SERVICE EQUIPMENT OTHER THAN AN UNMODIFIED NEW OR RECYCLED PART PURCHASED DIRECTLY FROM FRYMASTER/DEAN, OR ANY OF ITS AUTHORIZED SERVICERS, AND/OR THE PART BEING USED IS MODIFIED FROM ITS ORIGINAL CONFIGURATION, THIS WARRANTY WILL BE VOID. FURTHER, FRYMASTER/DEAN AND ITS AFFILIATES WILL NOT BE LIABLE FOR ANY CLAIMS, DAMAGES OR EXPENSES INCURRED BY THE CUSTOMER WHICH ARISE DIRECTLY OR INDIRECTLY, IN WHOLE OR IN PART, DUE TO THE INSTALLATION OF ANY MODIFIED PART AND/OR PART RECEIVED FROM AN UNAUTHORIZED SERVICER.

** DANGER**

Improper installation, adjustment, maintenance or service, and unauthorized alterations or modifications can cause property damage, injury, or death. Read the installation, operating and service instructions thoroughly before installing or servicing this equipment. Only qualified service personnel may convert this appliance to use a gas other than that for which it was originally configured.

** DANGER**

Adequate means must be provided to limit the movement of this appliance without depending upon the gas line connection. Single fryers equipped with legs must be stabilized by installing anchor straps. All fryers equipped with casters must be stabilized by installing restraining chains. If a flexible gas line is used, an additional restraining cable must be connected at all times when the fryer is in use.

** DANGER**

The front ledge of the unit is not a step. Do not stand on the rethermalizer. Serious injury can result from slips or contact with the hot water.

** DANGER**

Do not store or use gasoline or other flammable vapors and liquids in the vicinity of this or any other cooking appliance.

** WARNING**

No structural material on the fryer should be altered or removed to accommodate placement of the fryer under a hood. Questions? Call the Frymaster Service Hotline at 1-800-551-8633.

 **WARNING**

Do not bang fry baskets or other utensils on the fryer's joiner strip. The strip is present to seal the joint between the frypot. Banging fry baskets on the strip to dislodge shortening will distort the strip, adversely affecting its fit. It is designed for a tight fit and should only be removed for cleaning.

**IMPORTANT**

Safe and satisfactory operation of Frymaster equipment depends upon its proper installation. Installation **MUST** conform with local codes, or in the absence of local codes, to European Community (CE) Standards.

**COMPUTERS**

**FCC**

This device complies with Part 15 of the FCC rules. Operation is subject to the following two conditions: 1) This device may not cause harmful interference, and 2) This device must accept any interference received, including interference that may cause undesired operation. While this device is a verified Class A device, it has been shown to meet the Class B limits.

**CANADA**

This digital apparatus does not exceed the Class A or B limits for radio noise emissions as set out by the ICES-003 standard of the Canadian Department of Communications.

Cet appareil numérique n'émet pas de bruits radioélectriques dépassant les limites de classe A et B prescrites dans la norme NMB-003 édictée par le Ministre des Communications du Canada.

 **DANGER**

**THIS PRODUCT CONTAINS CHEMICALS KNOWN TO THE STATE OF CALIFORNIA TO CAUSE CANCER AND/OR BIRTH DEFECTS OR OTHER REPRODUCTIVE HARM.**

Operation, installation, and servicing of this product could expose you to airborne particles of glasswool or ceramic fibers, crystalline silica, and/or carbon monoxide. Inhalation of airborne particles of glasswool or ceramic fibers is known to the State of California to cause cancer. Inhalation of carbon monoxide is known to the State of California to cause birth defects or other reproductive harm.

**NOTICE**

The Commonwealth of Massachusetts requires any and all gas products and/or electrical products attached to a water supply to be installed by a licensed plumber or pipe fitter.

 **DANGER**

Do not use a water jet to clean this appliance.

 **WARNING**

Raise the lid slowly. Trapped steam may escape from beneath the lid.

**NOTICE**

All units shipped without factory supplied cords and plug assemblies must be hardwired using flexible conduit to the terminal block located on the rear of the unit. These units should be wired to NEC specifications. Hardwired units must include installation of restraint devices.

** DANGER**

Adequate means must be provided to limit the movement of this appliance without depending on or transmitting stress to the electrical conduit. A restraint kit is provided with the fryer. If the restraint kit is missing contact your local Frymaster Factory Authorized Servicer (FAS) for part number 810-3574.

**NOTICE**

If this equipment is wired directly into the electrical power supply, a means for disconnection from the supply having a contact separation of at least 3-mm in all poles must be incorporated in the fixed wiring.

**NOTICE**

This equipment must be positioned so that the plug is accessible unless other means for disconnection from the power supply (e.g., a circuit breaker) is provided.

**NOTICE**

If the electrical power supply cord is damaged, it must be replaced by a Frymaster Dean Factory Authorized Servicer technician or a similarly qualified person in order to avoid a hazard.

**NOTICE**

If this appliance is permanently connected to fixed wiring, it must be connected by means of copper wires having a temperature rating of not less than 167°F (75°C).

# FE155 Rethermalizer

## TABLE OF CONTENTS

	PAGE
<b>CHAPTER 1: General Information</b>	
Parts Ordering and Service Information .....	1-1
Safety Information .....	1-1
Equipment Description .....	1-2
Installation, Operating, and Service Personnel .....	1-2
Shipping Damage Claim Procedure .....	1-3
<b>CHAPTER 2: Installation Instructions</b>	
General Installation Requirements .....	2-1
Caster/Leg Installation .....	2-2
Pre-Connection Preparations .....	2-2
Connection to Electrical Supply .....	2-3
Power Requirements .....	2-4
Wiring Diagrams .....	2-5
<b>CHAPTER 3: Operating Instructions</b>	
Annotated View .....	3-1
Controller/Operation/Programming .....	3-2
Start Up Procedure .....	3-3
Boil Out Procedure .....	3-4
<b>CHAPTER 4: Preventive Maintenance</b>	
Daily Service Checks .....	4-1
Quarterly Checks .....	4-1
Annual Service Checks .....	4-2
<b>CHAPTER 5: Operator Troubleshooting</b>	
Introduction .....	5-1
Troubleshooting Guide .....	5-2

# CHAPTER 1: Introduction

## 1.1 Parts Ordering and Service Information

In order to assist you as quickly as possible, the Frymaster Authorized Servicer (FAS) or Service Department representative requires certain information about your equipment. Most of this information is printed on a data plate affixed to the inside of the door.

Parts orders may be placed directly with your local FAS or distributor. Included with the unit when shipped from the factory is a list of FASs. If you do not have access to this list, contact the Frymaster Technical Service Department at 1-800-551-8633 or 1-318-865-1711. The list is also available on the Frymaster website, [www.frymaster.com](http://www.frymaster.com).

When ordering parts, the following information is required:

Model Number: \_\_\_\_\_  
Serial Number: \_\_\_\_\_  
Voltage: \_\_\_\_\_  
Item Part Number: \_\_\_\_\_  
Quantity Needed: \_\_\_\_\_

Service information may be obtained by contacting your local FAS/Distributor. Information may also be obtained by calling the Frymaster Technical Service Department at 1-800-551-8633 or 1-318-865-1711. When requesting service, please have the following information ready:

Model Number: \_\_\_\_\_  
Serial Number: \_\_\_\_\_  
Voltage: \_\_\_\_\_

In addition to the model number, serial number, and voltage, please be prepared to describe the nature of the problem and have ready any other information that you think may be helpful in solving your problem.

**RETAIN AND STORE THIS MANUAL IN A SAFE PLACE FOR FUTURE USE.**

## 1.2 Safety Information

Before attempting to operate your unit, read the instructions in this manual thoroughly.

Throughout this manual, you will find safety notations enclosed in double-bordered boxes similar to the ones illustrated below and on the following page.

 **CAUTION**

**CAUTION boxes contain information about actions or conditions that may cause or result in a malfunction of your system.**

 **WARNING**

**WARNING boxes contain information about actions or conditions that may cause or result in damage to your system, and which may cause your system to malfunction.**

 **DANGER**

**DANGER boxes contain information about actions or conditions that may cause or result in injury to personnel, and which may cause damage to your system and/or cause your system to malfunction.**

### 1.3 Equipment Description

The FE155 Series is specifically designed to rethermalize meats, sauces, and other vacuum packaged foods at a safe temperature range.

The system features a controller and an easy to clean vat. Each unit can rethermalize up to 30 lbs. (13.6 kg) of food an hour.

The cookpot is safeguarded against boil-over by a standpipe overflow drain, and comes with a 1" cookpot drain for fast, clog-free emptying. The unit has a rethermalizing/cooking area of 14.25" x 19" (362mm x 482mm) and holds 16.5 gallons (62 liters) of water.

### 1.4 European Community (CE) Specific Information

The European Community (CE) has established certain specific standards regarding equipment of this type. Whenever a difference exists between CE and non-CE standards, the information or instructions concerned are identified with a shadowed box like the one at right.



### 1.5 Installation, Operating, and Service Personnel

Operating information for Frymaster equipment has been prepared for use by qualified and/or authorized personnel only, as defined in Section 1.6.

**All installation and service on Frymaster equipment must be performed by qualified, certified, licensed, and or/authorized installation or service personnel, as defined in Section 1.5.**

### 1.6 Definitions

#### QUALIFIED AND/OR AUTHORIZED OPERATING PERSONNEL

Qualified/authorized operating personnel are those who have carefully read the information in this manual and have familiarized themselves with the equipment functions, or who have had previous experience with the operation of the equipment covered in this manual.

#### QUALIFIED INSTALLATION PERSONNEL

Qualified installation personnel are individuals, or firms, corporations, or companies which, either in person or through a representative, are engaged in and are responsible for the installation of electrical appliances. Qualified personnel must be experienced in such work, be familiar with all electrical precautions involved, and have complied with all requirements of applicable national and local codes.

## QUALIFIED SERVICE PERSONNEL

Qualified service personnel are those that are familiar with Frymaster equipment and who have been authorized by Frymaster to perform service on Frymaster equipment. All authorized service personnel are required to be equipped with a complete set of service and parts manuals, and to stock a prescribed minimum amount of Frymaster equipment parts.

A list of Frymaster Factory Authorized Servicicers (FAS's) is located on the Frymaster website at [www.frymaster.com](http://www.frymaster.com). The location and telephone number of FASs can also be found at the Frymaster website, [www.frymaster.com](http://www.frymaster.com). *Failure to use qualified service personnel will void the Frymaster Warranty on your equipment.*

### 1.7 Shipping Damage Claim Procedure

Your Frymaster equipment was carefully inspected and packed before leaving the factory. The transportation company assumes full responsibility for safe delivery upon acceptance of the equipment for transport.

#### What to do if your equipment arrives damaged:

1. **File a claim for damages immediately**, regardless of the extent of damages.
2. **Inspect for and record all visible loss or damage** and ensure that this information is noted on the freight bill or express receipt and is signed by the person making the delivery.
3. **Concealed loss or damage** that was unnoticed until the equipment was unpacked should be recorded and reported to the freight company or carrier **immediately** upon discovery. A concealed damage claim must be submitted within 15 days of the date of delivery. Ensure that the shipping container is retained for inspection.

**FRYMASTER DOES NOT ASSUME RESPONSIBILITY  
FOR DAMAGE OR LOSS INCURRED IN TRANSIT.**



## **CHAPTER 2: Installation Instructions**

### **2.1 General Installation Requirements**

**PROPER INSTALLATION IS ESSENTIAL FOR EFFICIENT, TROUBLE-FREE OPERATION OF YOUR RETHERMALIZER. ANY UNAUTHORIZED ALTERATIONS MADE TO THIS EQUIPMENT WILL VOID THE FRYMASTER WARRANTY.**

Upon arrival, inspect the equipment carefully for visible or concealed damage. Report any damage found immediately (see **Shipping Damage Claim Procedure** in Chapter 1).

#### **NATIONAL CODE REQUIREMENTS**

This equipment is to be installed in compliance with the Basic Plumbing Code of the Building Officials and Code Administrators International, Inc. (BOCA) and the Food Service Sanitation Manual of the U.S. Food and Drug Administration.

#### **AUSTRALIAN REQUIREMENTS**

To be installed in accordance with AS 5601 / AG 601, local authority, gas, electricity, and any other relevant statutory regulations.

**NOTICE: The Commonwealth of Massachusetts requires any and all products connected to the gas or water system to be installed by a licensed plumber or pipe fitter.**

#### **ELECTRICAL GROUNDING REQUIREMENTS**

All electrically operated appliances must be grounded in accordance with all applicable national and local codes, and, where applicable, CE codes. All units (cord connected or permanently connected) should be connected to a grounded power supply system. A wiring diagram is located on the inside of the unit door. Refer to the rating plate on the inside of the door for proper voltages.

#### **FCC COMPLIANCE**

The user is cautioned that any changes or modifications to Frymaster computers not expressly approved by the party responsible for compliance could void the user's authority to operate the equipment. Frymaster computers have been tested and found to comply with the limits for a Class A digital device, pursuant to Part 15 of the FCC rules. While these devices are verified as Class A devices, they have been shown to meet the Class B limits. These limits are designed to provide reasonable protection against harmful interference when the equipment is operated in a commercial environment. This equipment generates, uses, and can radiate radio frequency energy and, if not installed and used in accordance with the instruction manual, may cause harmful interference to radio communications. Operation of the equipment in a residential area is likely to cause harmful interference in which case the user will be required to correct the interference at his own expense.

If necessary, the user should consult the dealer or an experienced radio and television technician for additional suggestions.

The user may find the booklet “How to Identify and Resolve Radio-TV Interference Problems” helpful. It is prepared by the Federal Communications Commission and is available from the U.S. Government Printing Office, Washington, DC 20402, Stock No. 004-000-00345-4.

## 2.2 Caster/Leg Installation

Depending upon the specific configuration ordered, your unit might have been shipped without installed casters or legs. If casters or legs are installed, you may skip this section and proceed to Section 2.3, Pre-Connection Preparations.

**If your unit requires the installation of casters or legs, install them in accordance with the instructions included in your accessory package. NOTE: Use only the casters or legs provided by Frymaster for this equipment.**

When the fryer is leveled in its final position, install the restraints provided with the unit to limit its movement so that it does not depend on or transmit stress to the electrical conduit or connection. Install the restraints in accordance with the provided instructions (see illustration below). If the restraints are disconnected for service or other reasons, they must be reconnected before the fryer is used.

**⚠ DANGER**

**Adequate means must be provided to limit the movement of this appliance without depending on or transmitting stress to the electrical conduit. A restraint kit is provided with the fryer. If the restraint kit is missing contact your local Frymaster Authorized Servicer (FAS) for part number 810-3574.**

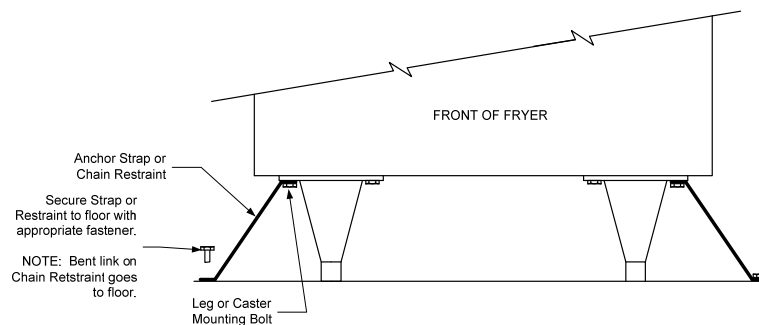

## 2.3 Pre-Connection Preparations

After the unit has been positioned in the area where it will be used, ensure the following have been accomplished *before connecting the unit to the electrical power source*:

1. This equipment must be stabilized by installing restraining chains on units equipped with casters or anchor straps on units equipped with legs. Follow the instructions shipped with the casters/legs to properly install the chains or straps.
2. Level units equipped with legs by screwing the legs out approximately one inch, then adjusting them so that the unit is level.
3. The plumbing on the FE155 can be adjusted (See Figure 1) to allow draining on either side. It ships with the drain ex-

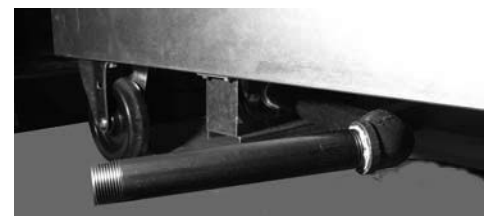



**Figure 1:** Drain shown extended away from unit cabinet.

tension pointed to the left side of the cabinet. If necessary, raise the unit and rotate drain toward the right side. The end of the drain should be extended away from the unit cabinet to ensure steam doesn't rise into the cabinet interior.

For units equipped with casters, there are no built-in leveling devices. The floor where the unit is to be installed must be level.

3. If so equipped, connect the water hose(s) to the fitting(s) at the rear of the unit and connect the unit to the water supply.

 **DANGER**  
Do not use a water jet to clean this appliance.

 **CAUTION**  
Incoming water pressure for all units should be approximately 40 PSI (2.8kg/cm<sup>2</sup>) (275.79 kPa).

 **DANGER**  
The maximum allowable incoming water pressure for all units is 80 PSI (5.62 kg/cm<sup>2</sup>) (551.58 kPa).  
The maximum allowable incoming water temperature for all units is 140°F (60°C).

 **WARNING**  
To prevent back flushing, the connection piping should be installed with a vacuum breaker or means of providing an air gap 1" (2.54 cm) above the cookpot rim.

**NOTE:** *On units equipped with water hoses, the hoses come with a quick-disconnect coupling. The quick disconnect may be attached to the unit or to the water supply line, or it may be left off entirely, whichever you prefer. If the unit is to be moved frequently (for cleaning or preventive maintenance), Frymaster recommends installing flexible water lines. If the cooker is hard-plumbed then moved, the connections may loosen and eventually cause leaks. Whichever option is chosen, Teflon thread-seal tape, Loctite™ PST56765, or equivalent thread sealer must be used when installing the fittings.*

**NOTE:** *Depending on specific model ordered, either hot {max 140°F (60°C)} or cold water, or both, may be connected to the unit. If available, connecting hot water will minimize the time required to bring the unit to operating temperature when filling with fresh water.*

4. Connect the desired drain plumbing to the drain valve. **NOTE: Ensure drain plumbing is connected in accordance with local codes. Waste water from the water bath unit should NOT be discharged directly below the appliance. Rising steam can harm the cabinet and the electrical components.**

#### 2.4 Connecting to the Electrical Supply

 **DANGER**  
This unit must be connected to the voltage and phase specified on the rating and serial number plate located on the inside of the equipment door. To determine the appropriate wire size, refer to the **POWER REQUIREMENTS** chart at the bottom of this page.

1. If the unit is not equipped with an installed power cord, open the door and remove the contactor box cover. Position the unit to gain access to the rear and remove the lower back panel.
2. Install a CE-approved harmonized cord rated for a minimum of 32 amps at 415 VAC minimum with 5 wires, including a neutral and ground. It must be oil and water resistant. Make the connections in accordance with the wiring diagram below.
3. Install the supplied strain relief, Oflex SKZ21 (8071210), which has a wire range of 15 to 23 mm, and replace the lower back panel and contactor box cover.
4. Install a CE-approved plug rated for a minimum of 32 amps at 415 VAC. It must be a 3-phase, 5-wire type with neutral and ground and be oil and water resistant.

<b>CE Standard</b>
--------------------

<b>Power Requirements</b>				
<b>Use copper wire ONLY, suitable for at least 170°F (75°C)</b>				
<b>ELECTRIC COOKER MODEL FE155</b>				
<b>Volts</b>	<b>Phase</b>	<b>kW</b>	<b>Amps (per leg)</b>	<b>Minimum Wire Size</b>
208	Single	8	38.7	8
220	Single	9	40.9	8
208	3	8	22.3	10
220	3	9	23.6	10
240	Single	10.7	44.6	6
440	Single	9	20.5	10
240	3	10.7	25.8	10
440	3	9	11.8	12
480	Single	10.7	22.3	10
480	3	10.7	12.9	12

<b>CE Power Requirements</b>				
<b>Use copper wire ONLY, suitable for at least 75°C</b>				
<b>ELECTRIC COOKER MODEL FE155</b>				
<b>Volts</b>	<b>Phase</b>	<b>kW</b>	<b>Amps (per leg)</b>	<b>Minimum Wire Size</b>
220/400	3	9.8	14.3	4.11 mm

# Field Connection Wiring Diagrams

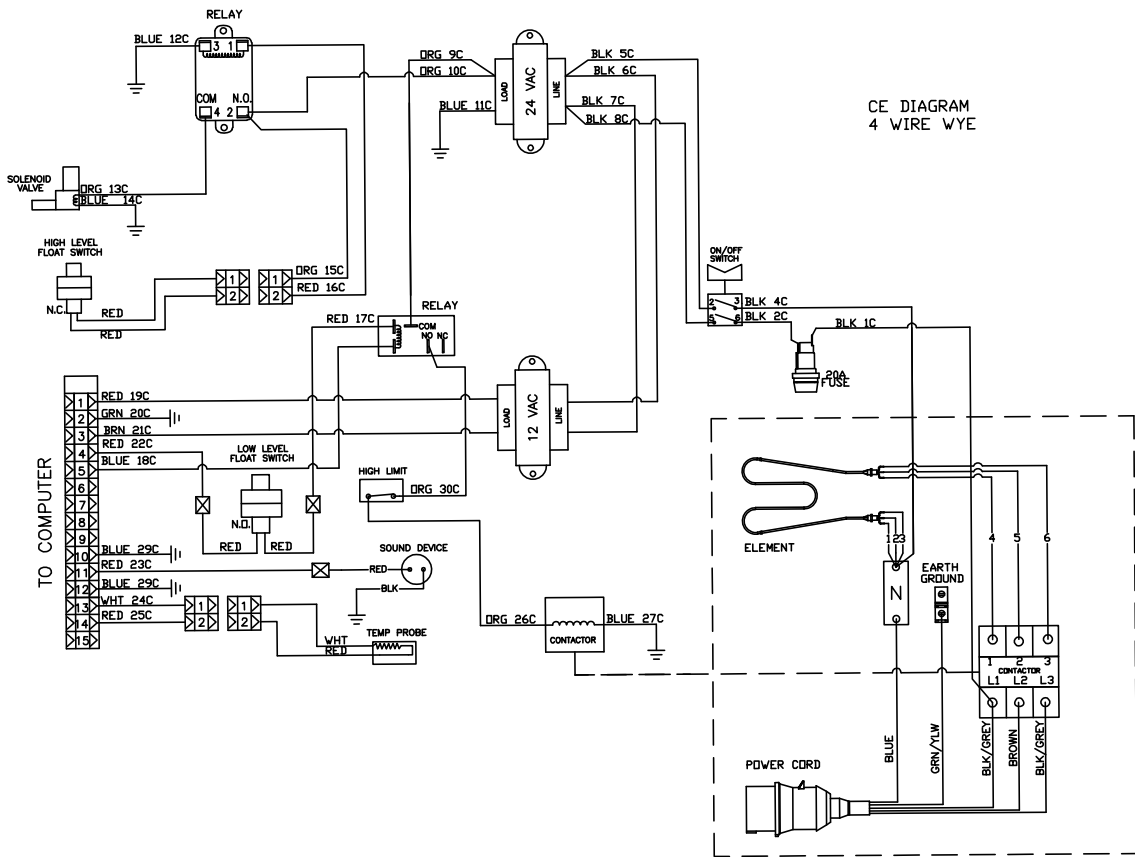
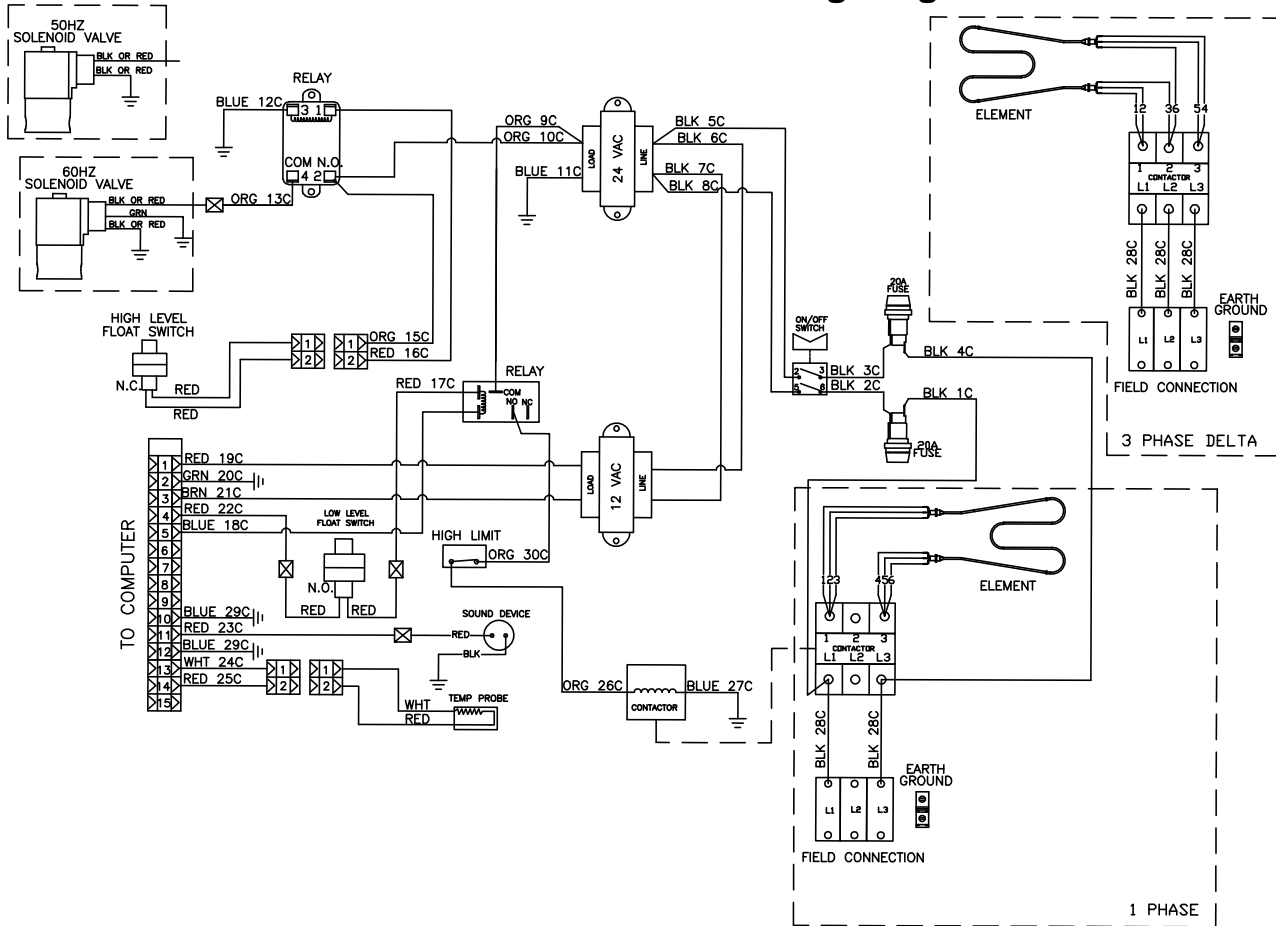

# CHAPTER 3: Operating Instructions

## 3.1 Finding Your Way Around the FE155



FE155

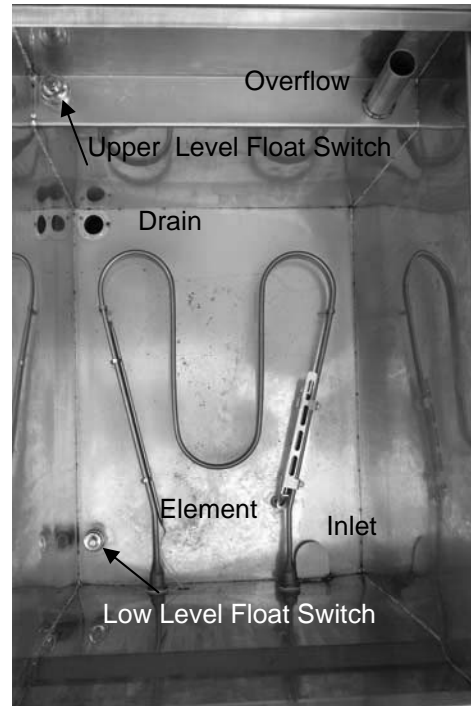

FE155 Vat

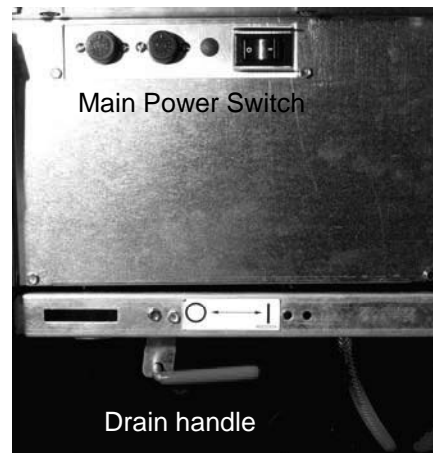

Cabinet Interior

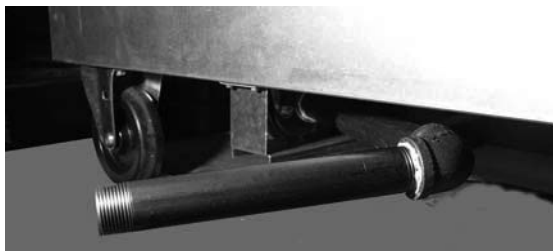

Drain extension

**NOTE:** The water inlet is controlled by the main power switch. It must be off during draining and cleaning to ensure the vat doesn't refill.

## 3.2 Controller

This equipment uses a specialized controller.

**Displays:** at setpoint alternate between dashed lines, 5 min. LO is displayed below setpoint, BOIL when the boil key is pressed.

**Temperature Keys:** pressing either key displays actual temperature on the left, setpoint on the right, alternating with 5 min. Press again to toggle to original display.

**NOTE:** In boil mode the temperature is not displayed and the temperature buttons are inactive.

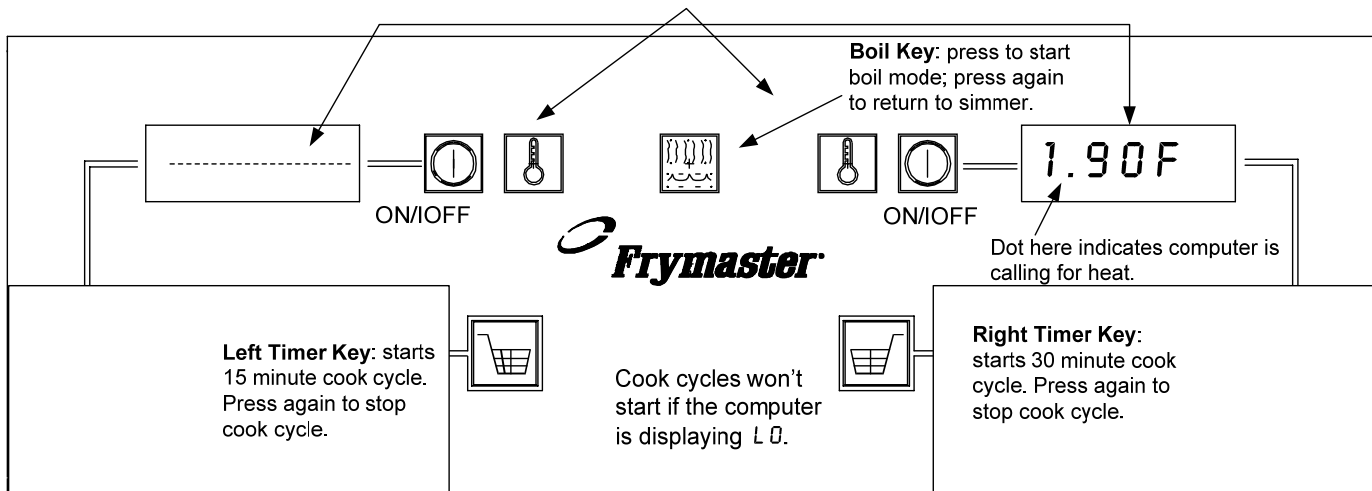

### Computer Operation

- Ensure the main power switch (behind cabinet door) is on.
- Press either ON/OFF button to turn the computer on.
- The computer displays LO as it rises to the preset 190°F setpoint for simmer.
- At setpoint, the computer displays alternate between dashed lines and 5 min.
- Press a Temperature key to toggle display to actual temperature on the left, setpoint on the right. Press again to toggle back.

### Simmer

- Place product in vat and press desired timer key. Display alternates between 5 min and remaining cook time.
- C O O C appears and an alarm sounds when the cook time elapses. Cook cycles won't start if the computer is displaying LO.
- Remove the product and press the timer key to halt the alarm.

**NOTE:** Computer returns to simmer mode if a boil cook cycle is not initiated within 15 minutes of pressing the boil key.

### Boil

- Press the boil key.
- Display changes to BOIL.
- Wait until water boils.
- Place product in vat and press the desired timer key. Temperature keys are inactive.
- Display alternates between boil and the remaining cook time.
- C O O C appears and an alarm sounds when the cook time elapses.
- Remove the product and press the timer key to halt the alarm.

**NOTE:** Pressing the Boil key with the computer OFF produces a Code display, which is used in initial programming. ON/OFF keys are inactive. Press any other key four times to clear display and reactivate ON/OFF keys.

- Press Boil key a second time to return to simmer mode.

### Programming

- **Remove the bezel** (see annotated photo on page 3-1) Lift up and then rotate out at the bottom, which exposes a keypad beside each timer button.
- **Temperature change:** Press the temperature key until the current temperature is displayed. Enter the desired temperature with the key pad.
- An illuminated dot between the last digit and the F indicates the change was accepted. Temperatures below 155°F and above 210°F can't be entered. The computer will default to its lowest setting, 155°F, upon low-temperature entry and to its highest setting, 210°F, upon high-temperature entry.
- **Time change:** Press the temperature key until the display alternates between 5 min and a dashed line. Enter the desired time, in minutes and seconds, on the key pad. Press the timer key to ensure the desired time is in place. Press the timer key a second time to stop the timer.
- **Turn the controller OFF.** Replace the bezel. Ensure it doesn't press against the key pads.

#### **WARNING**

**Raise the lid slowly. Trapped steam may escape from beneath the lid.**

#### **CAUTION**

**The electronic circuitry in your computer can be affected adversely by current fluctuations and electrical storms. Should it fail to function or program properly for no apparent reason, the computer should be reset by unplugging the computer harness from the rear of the computer and plugging it back into the computer. This could prevent a service call.**

### 3.3 Start-Up Procedure

#### **CAUTION**

**If this is the first time the unit is being used after installation, refer to Section 3.5, Boiling-Out the Cookpot.**

1. Before turning the equipment on, ensure that:
  - The unit is connected to the water supply.
  - The water supply is turned on.
  - The unit is plugged into an outlet of appropriate voltage (check rating plate to verify).
  - The electrical power supply to the equipment is turned on.
  - The main power switch is on.
2. Press the computer Power  switch.

If the cookpot is not full, the AutoFill will add water. When the water covers the upper float switch, the AutoFill solenoid valve will cut off the water. If the water level drops below the upper float switch during operation, the solenoid valve will open and add water to the cookpot.



When the water level is above the lower float switch, the elements will energize. When the unit reaches setpoint, the display will alternate between dashed lines and 5 in. Pressing either temperature key displays the actual temperature on the left, setpoint on the right.

### 3.4 Draining

1. Allow the water to cool.
2. Ensure the drain extension is positioned to allow the water to safely drain from the unit, ensuring splashing doesn't rise into the cabinet.
3. Turn the main power switch off.
4. Slowly open the drain valve.
5. Close the drain valve and turn on the main power switch to refill the unit.

 **WARNING**

**Use extreme caution if draining hot water. Severe burns can be caused by hot water and steam. Follow all restaurant safety procedures.**

### 3.5 Boiling-Out the Cookpot

To ensure that the vat is free of any contamination, the vat must be boiled out before first use.

1. Close the drain valve and fill the cookpot with a solution of cold water and 1 cup of detergent.
2. Place the unit into operation in accordance with Section 3.4.
3. Press the 30-minute timer key. Allow the unit to go through two simmer cycles.
4. Turn the unit off with the main power switch and allow the solution to cool. Add 2 gallons (7.75 liters) of cold water and stir. Drain the solution and clean the vat thoroughly.
5. Rinse the vat at least twice by filling with clean water and draining.

**NOTE:** The water inlet is controlled by the main power switch. It must be off during draining and cleaning to ensure the vat doesn't refill unexpectedly.

### 3.6 Shutting the FE155 Down

1. Turn the unit off by pressing the main power switch in the cabinet.
2. If shutting down at the end of the day, drain and clean the cookpot and put the cookpot cover in place.

## CHAPTER 4: Preventive Maintenance

### 4.1 Daily Checks and Services

#### Inspect Cooking System and Accessories for Damage

Look for loose or frayed wires and cords, leaks, foreign material in cookpot or inside cabinet, and any other indications that the rethermalizer and accessories are not ready and safe for operation.

#### Clean Cabinet Inside and Out

Clean inside the cabinet with a dry, clean cloth. Wipe all accessible metal surfaces and components to remove accumulations of oil, dust, or cooking residue.

Clean the outside of the cabinet with a clean cloth dampened with dishwashing detergent, removing oil, dust, or cooking residue.

#### DANGER

**Never attempt to clean this equipment during the rethermalizing/cooking process or when the cookpot is filled with hot water and/or food products.**

#### Clean Float Switch Assemblies, Vat

Press the computer power switch to the OFF position. Clean the float switches with a solution of detergent and warm water. A Scotchbrite™ or equivalent nylon pad may be used to scrub away any accumulated mineral deposits. Verify that both floats move freely up and down on the rod. Using a Scotchbrite™ or similar abrasive pad and a solution of detergent and warm water, clean the inside of the vat, paying particular attention to the elements.

Rinse the vat thoroughly with clean water at least twice.

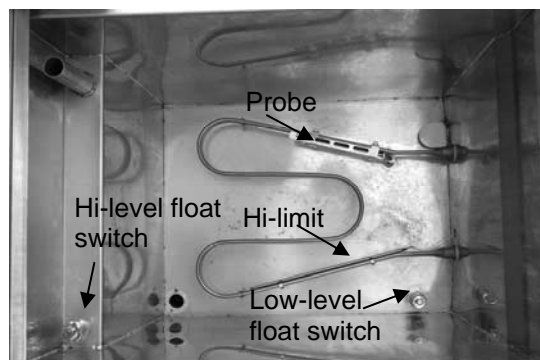

### 4.2 Quarterly Checks and Services

#### Check Controller Set Point Accuracy

1. Fill the cookpot with water. Press the controller power switch, and allow the unit to heat to setpoint. Insert a good-grade thermometer or pyrometer probe into the cookpot, with the end touching the temperature probe at the lower right front of the cookpot.
2. When the computer displays a series of four dashes, press the  switch to show the temperature. The measured temperature should be within  $\pm 5^{\circ}\text{F}$  ( $2^{\circ}\text{C}$ ) of the displayed water temperature. If the reading is outside that range, contact a Factory Authorized Servicer for assistance.

### 5.3 Periodic/Annual Checks

Frymaster recommends that the unit be inspected annually by a Factory Authorized Servicer for the following checks and adjustments:

- Verify that the heating element wires are in good condition and that leads have no visible fraying or insulation damage.
- Verify that heating elements are in good condition with no build-up. Inspect the elements for signs of extensive dry-firing.
- Verify that the float switches are in good working order and free of debris and build-up.
- Verify the heating-element amp-draw is within the allowed range as indicated on the appliance's rating plate.
- Verify that the temperature and high-limit probes are properly connected, tightened and functioning properly, and that mounting hardware and probe guard are present and properly installed.
- Verify that component box and contactor box components (i.e. computer/controller, relays, interface boards, transformers, contactors, etc.) are in good condition and free from moisture build-up, rust and other debris.
- Verify that component box and contactor box wiring connections are tight and that wiring is in good condition.
- Verify that all safety features (i.e. contactor shields, drain safety switches, reset switches, etc.) are present and functioning properly.
- Verify that the frypot/cookpot is in good condition and free of leaks and that the frypot/cookpot insulation is in serviceable condition.
- Verify that all wiring harnesses and connections are tight and in good condition.

# CHAPTER 5: Troubleshooting\Inspection

## 5.1 Introduction

This chapter provides an easy reference guide to the more common problems that may occur during the operation of this equipment. The troubleshooting guides in this chapter are intended to help you correct, or at least accurately diagnose, problems with the equipment. Although the chapter covers the most common problems reported, you may very well encounter a problem not covered. In such instances, the Frymaster Technical Service Department will make every effort to help you identify and resolve the problem.

When troubleshooting a problem, always use a process of elimination starting with the simplest solution and working through to the most complex. Never overlook the obvious. Anyone can forget to plug a cord into a receptacle or open the valve on the water supply line. Don't assume that you are exempt from such occurrences. Most importantly, try to establish a clear idea of why a problem has occurred. Part of your corrective action involves taking steps to ensure that it doesn't happen again. Keep in mind that failure of a small component may often be indicative of potential failure or incorrect functioning of a more important component or system.

If the troubleshooting and corrective actions in this chapter do not solve the problem, the problem is probably beyond the scope of most operators to solve and you should call your Authorized Service Agency for assistance. If you have doubts as to the proper action to take, do not hesitate to call the Frymaster Technical Service Department or your local Frymaster Authorized Servicer for assistance.

***Before calling a servicer or the Frymaster HOTLINE (1-800-551-8633):***

- **Verify that electrical cords are plugged in and that circuit breakers are on.**
- **Verify that water supply valves are open and that drain valves are fully closed.**

** DANGER**

**Hot water can cause severe burns. Never attempt to move this equipment when filled with hot water or to transfer hot water from one container to another.**

** DANGER**

**Use extreme care when performing electrical circuit tests. Live circuits will be exposed.**

** WARNING**

**Inspection, testing, and repair of electrical components should be performed only by qualified service personnel. The equipment should be unplugged when servicing, except when electrical tests are required.**

## 5.2 Operator Troubleshooting Guide

PROBLEM	POSSIBLE CAUSES	CORRECTIVE ACTION
Computer does not activate.	A. No power to unit.	A. Turn on circuit breaker.
	B. Computer not turned on.	B. Press computer ON/OFF key.
	C. Main power switch off.	C. Turn main power switch on.
Autofill does not add water.	A. Water not turned on.	A. Turn water on.
	B. Upper float stuck in up position.	B. Clean float switch assembly (see Section 4.1).
	C. Malfunctioning solenoid valve.	C. Call FAS.
Autofill does not shut off when the cookpot is full.	A. Dirty/sticking upper float switch.	A. Clean float switch assembly (see Section 4.1).
	B. Malfunctioning solenoid valve.	B. Call FAS.
Water will not heat (computer is on, water is at normal level, but <b>LO is not showing</b> on the computer).	A. Dirty/sticking lower float switch.	A. Clean float switch assembly (see Section 4.1).
Water will not heat (water above lower water level sensor and LO is showing on the computer).	A. Defective controller.	A. Call FAS.
	B. Malfunctioning element or other component in heating system.	B. Call FAS.
Water heats but does not reach setpoint.	A. Defective controller.	A. Call FAS.
	B. Malfunctioning element.	B. Call FAS.
Timer does not count down.	A. Operator error.	A. Push a product button.
	B. Defective controller.	B. Call FAS.



Frymaster, L.L.C., 8700 Line Avenue, Shreveport, Louisiana 71106

TEL 1-318-865-1711

FAX (Tech Support) 1-318-219-7135

PRINTED IN THE UNITED STATES

SERVICE HOTLINE  
1-800-551-8633

819-6399  
11/2016