

GF40

Accessories

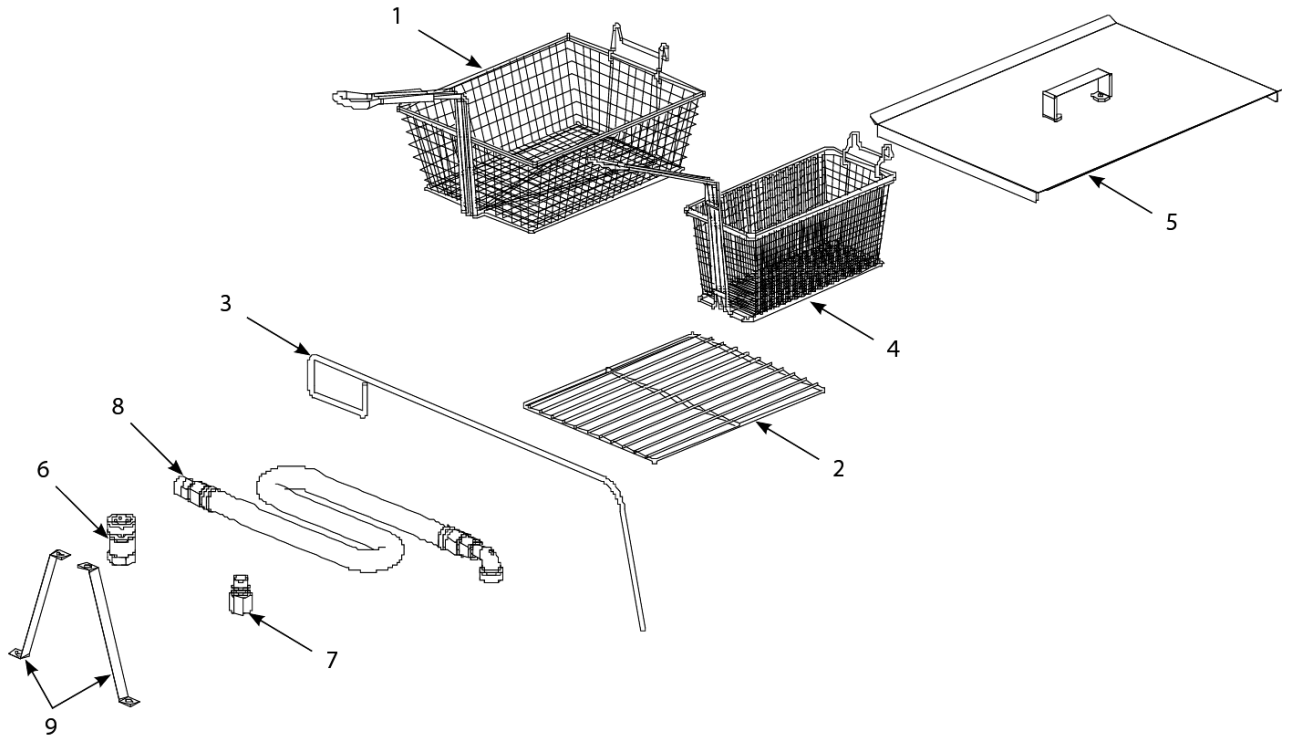

GF40

Accessories

#	PART #	DESCRIPTION	QTY	Note
1	8030015	Basket, Full	1	
1a	8030099	Basket, Full Size	1	
2	8030032	Basket Support Rack, J2X	1	
2a	8030132	Rack, Full-Vat Basket Support	1	
2b	8030037	Basket rack, fine mesh GF14	1	
2c	8030136	Basket Support Screen, Full Vat	1	
3	8030197	Fryer's Friend	1	
4	8030271	Basket, Twin Size	1	
5	8065518	Cover, Frypot, Full Vat	1	
5a	9107014	Cover, Spreader Cabinet	1	[1]
6	8103745	Quick Disconnect - 0.75"	1	
6a	8100073	Coupling, Gas Line Female Quick Disconnect 1-inch	1	
7	8103745	Quick Disconnect - 0.75"	1	
7a	8100074	Quick-Disconnect Fitting, 1-Inch Male	1	
8	8100083	Hose, Flexible Gas, 0.75-inch x 36-inch	1	
8a	8100084	Hose, Flexible Gas, 0.75-inch x 48-inch	1	
8b	8100088	Gas Line, 1-Inch Dormont Flexible, 36-Inch	1	
8c	8100085	Gas Line, 1-Inch Dormont Flexible, 48-Inch	1	
9	8261095	Anchor Strap Kit	1	[2]
10	8260900	Kit, Chain Restraint	1	[3]
11	8130188	Drain Nipple, Extended	1	
12	8263320	Leg - 4 Pack	4	
13	8100750	Caster, 90° rigid	1	
13a	8100356	Caster without Brake - 5"	1	
13b	8100357	Caster with Brake - 5"	1	
14	1064386SP	Toggle Switch	1	
15	8102793	Hanger - Wireform Basket	1	
15a	8090171	Thumbscrew, 0.25-20 x 1.375-inch	1	
15b	8090921-FRY	Spacer, Basket Hanger	1	[4]
16	8030188	Sediment tray, GF14	1	
16a	8030103	Valve, Manual Gas Shut Off 0.75"	1	

PART NOTES:

- [1] - manufactured date code before 1/1/08
- [2] - for use only on fryers equipped with legs
- [3] - for use only on fryers equipped with casters
- [4] - spacer

GF40

Burners (Post June 08 and current)

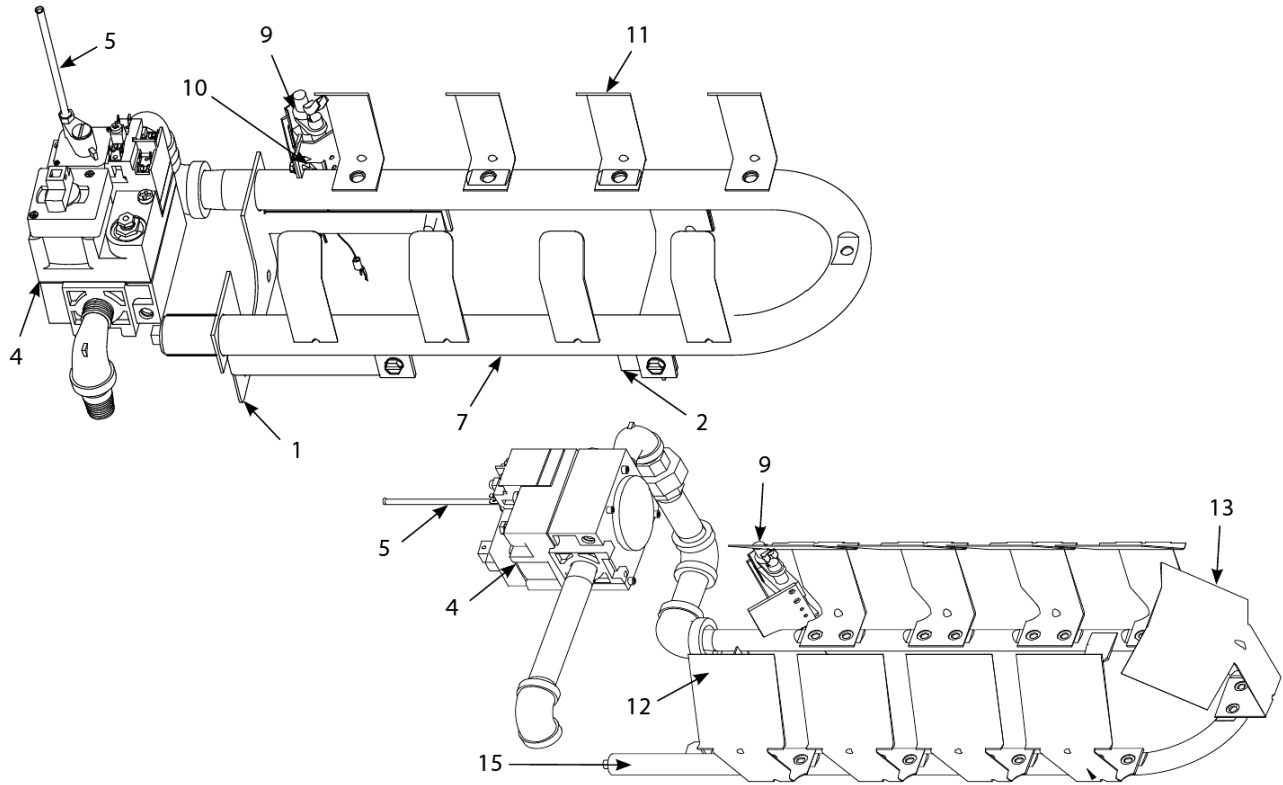

GF40

Burners (Post June 08 and current)

#	PART #	DESCRIPTION	QTY	Note
1	2000176	Bracket, Front Manifold Mounting	1	
2	2000177	Hanger, Rear Manifold	1	
3	2000749	Guard, Thermopile	1	
3a	8101873	Pilot, Powerpile	1	
4	8071603	Valve, Honeywell Millivolt Gas, Natural	1	
4a	8071604	Valve, Honeywell Millivolt Gas, Propane	1	
4b	8100975	Gas Valve Knob	1	
5	8100691	Tube, 0.125-inch Vent	1	
6	8100703	Pilot Tubing, Gas Valve to Pilot	1	
7	8101862	Burner Manifold, J2X	1	
8	8261139	Conversion Kits, GF14 Conversion Kit, Natural to LP	1	
8a	8261140	Conversion Kits, GF14 Conversion Kit, LP to Natural	1	
8b	8261143	Conversion Kit, Natural to Propane	1	
8c	8261144	Conversion Kit, Propane to Natural	1	
9	8102071	Pilot Assembly Pilot Assembly, Natural	1	
9a	8100149	Right Angle Orifice, .024-inch	1	
9b	8100426	Pilot, Natural Gas	1	
9c	8102070	Pilot Assembly (Includes bracket, hood, and thermopile), Propane Gas	1	
9d	8100148	Right Angle Orifice, .013-inch	1	
9e	8100427	Pilot, Propane Gas	1	
9f	1069922	Pilot Assembly (Includes bracket, hood, and thermopile), Propane Gas, Australian	1	
10	9001032	Pilot Mounting Bracket, J2X	1	
11	9101082	Deflector, side, GF14	1	
12	2301177	Side Deflector	1	
13	2301206	Deflector, Rear	1	
14	9102113	Target, rear, GF14	1	
15	8230496	Manifold, Burner	1	
16	8261388	GF14, Natural 1.655mm (Altitude 0-1999 feet (0-609 meters))	10	
17	8261354	GF 14, Propane 1.05 mm (Altitude 0-1999 feet (0-609 meters))	10	
18	8261357	Orifice, 1.45 mm (for natural gas, 0-1999 feet/0-609 meters)	10	
19	8261387	Orifice, 0.86 mm (for Propane gas, 0-1999 feet/0-609 meters)	10	
20	8102804	GF14, Natural Gas 1.60 mm (Altitude 2000-3999 (610-1219 meters))	1	
21	8120907	GF14, Natural Gas 1.55 mm (Altitude 4000-5999 feet (1220-1829 meters))	1	
22	8121204	GF14, Natural Gas 1.50 mm (Altitude 6000-7999 feet (1830-2438 meters))	1	
23	8261357	Orifice, 1.45 mm (for natural gas, 0-1999 feet/0-609 meters)	10	
24	8261386	Orifice, 1.40 mm (for natural gas, 2000-3999 feet/610-1219 meters)	10	
25	8100135	GF 14, Propane 1.02 mm (Altitude 2000-3999 (610-1219 meters))	1	
26	8261391	GF 14, Propane 0.99 mm (Altitude 4000-5999 feet (1220-1829 meters))	10	
27	8120906	GF 14, Propane 0.95 mm (Altitude 6000-7999 feet (1830-2438 meters))	1	

GF40

Burners (Post June 08 and current)

#	PART #	DESCRIPTION	QTY	Note
28	8120915	GF 14, Propane 0.93 mm (Altitude 8000-8999 feet (2439-2743 meters))	1	
29	8120910	GF 14, Propane 0.90 mm (Altitude 9000-9999 feet (2743-3048 meters))	1	
30	8261386	Orifice, 1.40 mm (for natural gas, 2000-3999 feet/610-1219 meters)	10	
31	8100361	Orifice, 1.36 mm (for natural gas, 4000-5999 feet/1220-1829 meters)	1	
32	8100131	Burner Orifice Burner Orifice, #56, 1.30 mm, Natural, J1C & J1X	1	
33	8100951	Orifice, 1.25 mm (for natural gas, 8000-8999 feet/2439-2743 meters)	1	
34	8100323	Orifice, 1.20 mm (for natural gas, 9000-9999 feet/2744-3048 meters)	1	
35	8100952	Orifice, 0.82 mm (for Propane gas, 2000-3999/610-1219 meters)	1	
36	8261352	Orifice, 0.81 mm (for Propane gas, 4000-5999 feet/1220-1829 meters)	10	
37	8120914SP	Orifice, 0.78 mm (for Propane gas, 6000-7999 feet/1830-2438 meters)	1	
38	8121302	Orifice, 0.76 mm (for Propane gas, 8000-8999 feet/2439-2743 meters)	1	
39	8120444	Orifice, 0.74 mm (for Propane gas, 9000-9999 feet/2743-3048 meters)	1	

GF40

Burners and Gas Supply Components (Pre June 08)

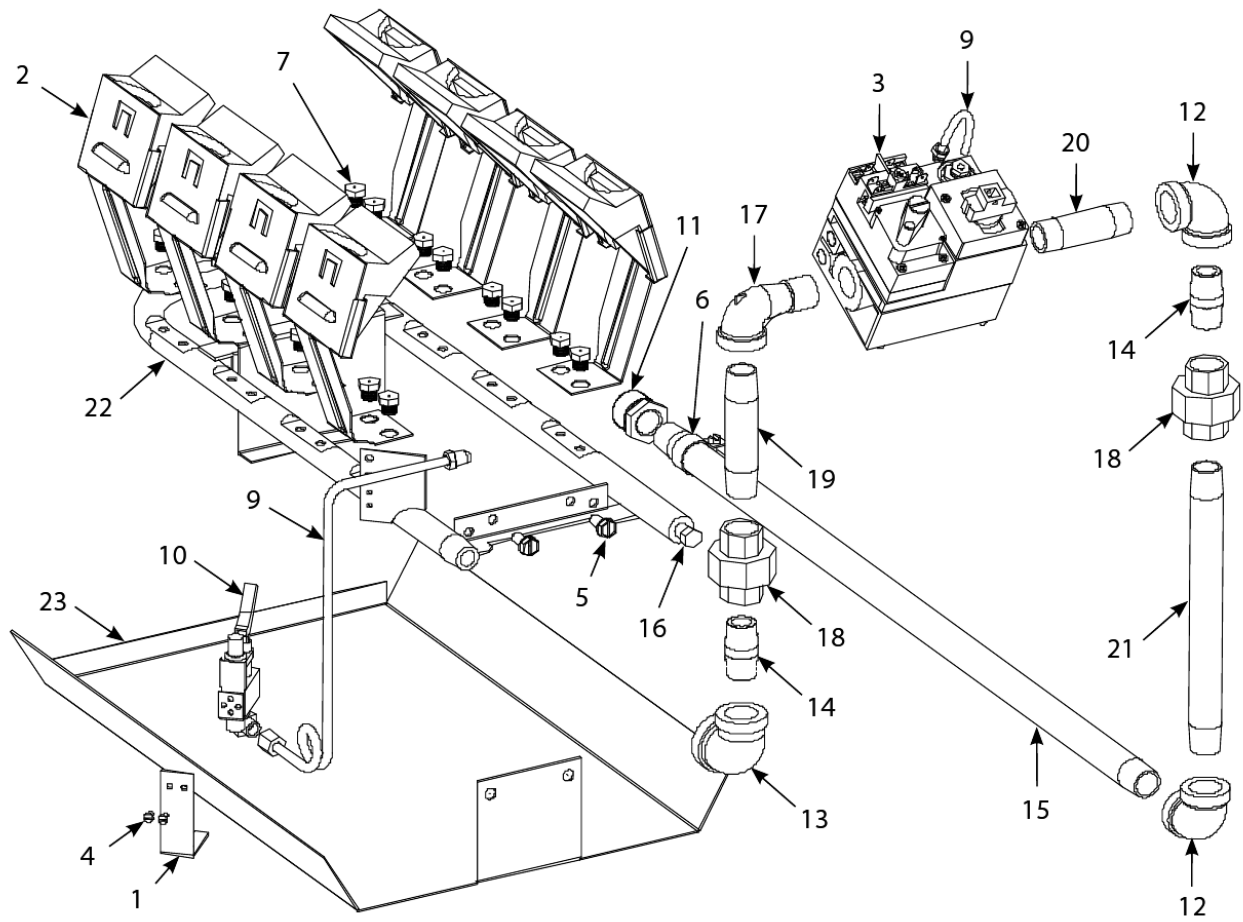

GF40

Burners and Gas Supply Components (Pre June 08)

#	PART #	DESCRIPTION	QTY	Note
1	2000749	Guard, Thermopile	1	
2	2301177	Side Deflector	1	
3	8071603	Valve, Honeywell Millivolt Gas, Natural	1	
3a	8071604	Valve, Honeywell Millivolt Gas, Propane	1	
3b	8100975	Gas Valve Knob	1	
3c	8261143	Conversion Kit, Natural to Propane	1	
3d	8261144	Conversion Kit, Propane to Natural	1	
3e	8100426	Pilot, Natural Gas	1	
3f	8100427	Pilot, Propane Gas	1	
3g	8101873	Pilot, Powerpile	1	
4	8090092	Screw - #5-40 x 0.25" Slotted Pan Head	1	
4a	8090115	Screw - #10-32 x 0.25" Truss Head	1	[1]
5	8090785	Screw - #14 x 0.75" Slotted Hex Washer Head	1	
6	8090951	Clamp, Hose	1	
7	8261357	Orifice, 1.45 mm (for natural gas, 0-1999 feet/0-609 meters)	10	
7a	8261386	Orifice, 1.40 mm (for natural gas, 2000-3999 feet/610-1219 meters)	10	
7b	8100361	Orifice, 1.36 mm (for natural gas, 4000-5999 feet/1220-1829 meters)	1	
7c	8100131	Burner Orifice Burner Orifice, #56, 1.30 mm, Natural, J1C & J1X	1	
7d	8100951	Orifice, 1.25 mm (for natural gas, 8000-8999 feet/2439-2743 meters)	1	
7e	8100323	Orifice, 1.20 mm (for natural gas, 9000-9999 feet/2744-3048 meters)	1	
7f	8261387	Orifice, 0.86 mm (for Propane gas, 0-1999 feet/0-609 meters)	10	
7g	8100952	Orifice, 0.82 mm (for Propane gas, 2000-3999/610-1219 meters)	1	
7h	8261352	Orifice, 0.81 mm (for Propane gas, 4000-5999 feet/1220-1829 meters)	10	
7i	8120914SP	Orifice, 0.78 mm (for Propane gas, 6000-7999 feet/1830-2438 meters)	1	
7j	8121302	Orifice, 0.76 mm (for Propane gas, 8000-8999 feet/2439-2743 meters)	1	
7k	8120444	Orifice, 0.74 mm (for Propane gas, 9000-9999 feet/2743-3048 meters)	1	
8	8100691	Tube, 0.125-inch Vent	1	
9	8100705	Gas Line, Pilot Supply - 0.25 x 20"	1	
10		Pilot Assembly	1	[2]
10a	8101830	Pilot Assembly - Natural Gas w/0.024" Right Angle Orifice	1	
10b	8100149	Right Angle Orifice, .024-inch	1	
10c	8101773	Pilot Assembly, Propane	1	
10d	8100148	Right Angle Orifice, .013-inch	1	
11	8130031	Bushing, 0.75-inch NPT to 0.5-inch Reducer	10	
12	8130062	Elbow - 0.5" BM x 90°	10	
13	8130068	Elbow - 0.75" NPT x 0.5" NPT x 90°	10	
14	8130087	Nipple, 0.5-inch NPT x 1.5-inch (3.8 cm)	10	
15	8130108	Nipple, 0.5-inch x 24.50-inch BM NPT	1	
16	8130154	Plug, 0.125-inch NPT Hex Head Pipe	1	

GF40

Burners and Gas Supply Components (Pre June 08)

#	PART #	DESCRIPTION	QTY	Note
17	8130165	Elbow - 0.5" x 90° NPT Street	1	
18	8130173	Union, 0.5-inch NPT	10	
19	8130247	Nipple, 0.5 x 3.5" NPT BM	10	
20	8130265	Nipple - 0.5" x 2.5" NP	1	
21	8130320	Nipple, 0.5-inch NPT x 8-inch	10	
22	8230496	Manifold, Burner	1	
23	8230574SP	Shield, Open Burner Heat	1	

PART NOTES:

- [1] - attaches Item 10 to Item 22
- [2] - Includes bracket, hood, and thermopile.

GF40

Cabinetry (Post June 08 and current)

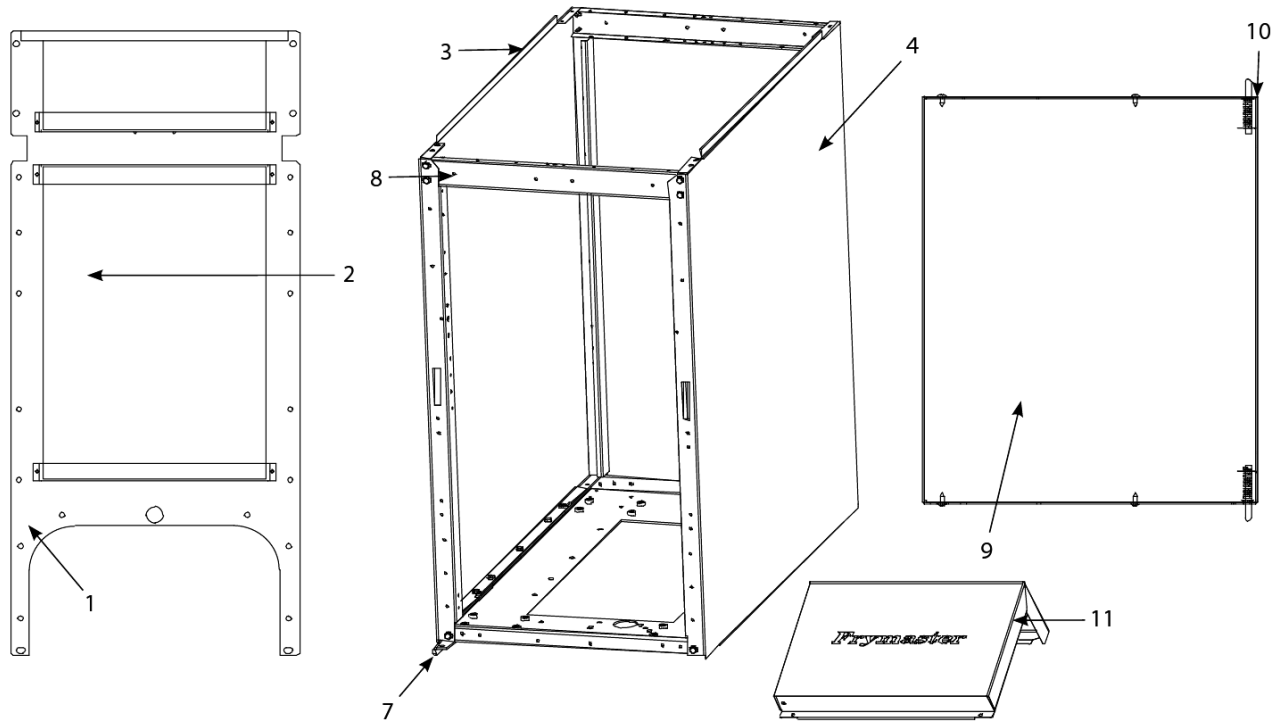

GF40

Cabinetry (Post June 08 and current)

#	PART #	DESCRIPTION	QTY	Note
1	2006903	Back GF14	1	
1a	2006904	Back GF40	1	
2	8160656	Insulation, back	1	
3	2016917SP	Left Side SS	1	
4	2026917	Right Side SS	1	
5	2126893	Right Side - Painted	1	
6	2116893SP	Left Side - Painted	1	
7	2307192	Hinge, Door Lower	1	
8	9004813	Brace, Cabinet Top Single	1	
9	1069539	Door assembly	1	
9a	2304960	Handle, Eurolook Door	1	
10	1064067SP	Door Pin Assembly	1	
11	8241946	Topcap	1	
12	8101105	Door Magnet - Vertical	1	
13	9103557	Fryer's Friend 27"	1	

GF40

Cabinetry Components (Pre June 08)

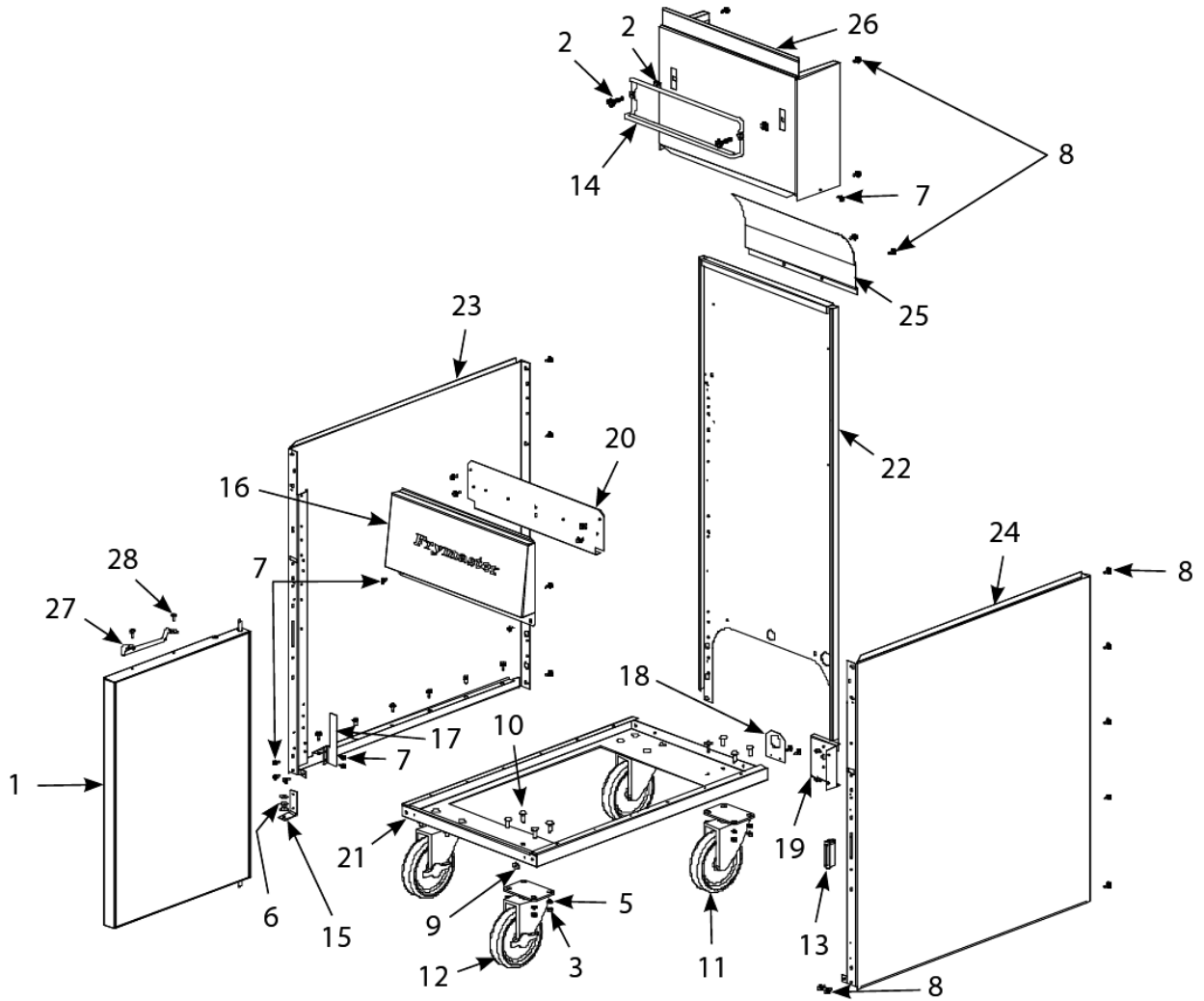

GF40

Cabinetry Components (Pre June 08)

#	PART #	DESCRIPTION	QTY	Note
1	8068396	Door Assembly	1	
2	8261351	Nut Retainer, 0.25-20 Std. Fluecap	10	[1]
3	8261362	Nut - 0.25"-20 Hex	10	
4	8090171	Thumbscrew, 0.25-20 x 1.375-inch	1	
5	8090191	Washer, Lock 0.25 Spring ZP	1	
6	8090193	Flat Washer - 0.25" Nylon	1	
7	8261371	Screw - #8 x 0.5" Hex Head ZP	25	
8	8261374	Screw - #10 x 0.5" Hex Head	25	
9	8090413	Spacer, Door Post (0.25-inch ID x 4mm nylon washer)	1	[2]
10	8090563	Bolt - 0.25-20 x 0.75" Carriage	1	
11	8100356	Caster without Brake - 5"	1	
12	8100357	Caster with Brake - 5"	1	
13	8101105	Door Magnet - Vertical	1	
14	8102793	Hanger - Wireform Basket	1	
14a	8030028	Hanger AL (obsolete)	1	
15	8101508	Hinge, Universal Door	1	
16	8240330	Panel, GF14/GF40 Control	1	
17	9000943	Bracket, Drain Extension	1	
18	9001129	Support, Gas Line	1	
19	9001501	Mount, Thermostat	1	
20	9004274	Brace, GF40 Cabinet Top	1	
21	9005764	Base, One-Piece GF40 Cabinet	1	
22	9006983SP	Back, Cabinet, Enameled Steel	1	
22a	9106983SP	Back, Cabinet, Stainless Steel	1	
23	9017311SP	Side, Left Cabinet, Enameled Steel	1	
23a	9117311SP	Side, Left Cabinet, Stainless Steel	1	
24	9027311SP	Side, Right Cabinet, Enameled Steel	1	
24a	9127311SP	Side, Right Cabinet, Stainless Steel	1	
25	9103557	Fryer's Friend 27"	1	
26	9105038	Cap, Flue	1	
27	8101422	Handle, Wireform Door	1	
28	8261379	Screw, #10 X 0.5-inch Phillips Truss Head	10	

PART NOTES:

- [1] - for use on standard fluecap
- [2] - 0.25-inch ID x 4mm nylon washer

GF40

Frypot and Related Components (Pre June 08)

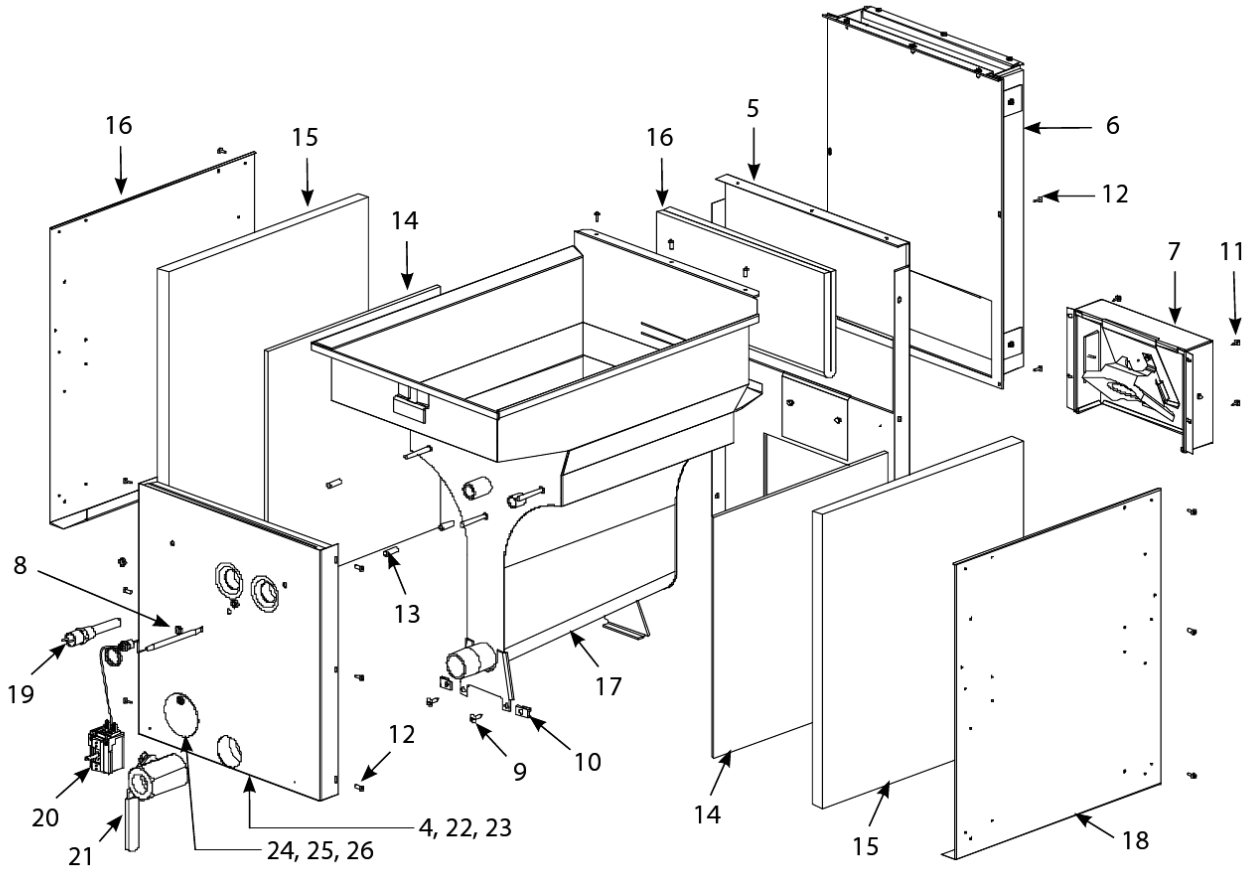

GF40

Frypot and Related Components (Pre June 08)

#	PART #	DESCRIPTION	QTY	Note
1	1062544SP	Frypot with Flue and Insulation - Stainless Steel	1	
2	8064199SP	Frypot with Flue and Insulation - Cold-Rolled Steel	1	
3	8064308SP	Complete Front Combustion Chamber	1	[1]
4	9006969	Baffle, Front Insulation	1	
5	8065566	Panel Assembly, Rear Combustion Chamber	1	
6	8065567SP	Flue Assembly with Insulation, Complete	1	
6a	8160174	Insulation, Flue Back	1	
6b	8160175	Insulation, Flue Front	1	
7	8065778SP	Box Assembly, Flue Deflector	1	
8	8261362	Nut - 0.25"-20 Hex	10	
9	8090170	Screw - #14 X 0.75" Slotted Pan Head	1	
10	8090173	Clip, Tinnerman	1	
11	8261371	Screw - #8 x 0.5" Hex Head ZP	25	
12	8090410	Screw, #8 X 0.5-inch Phillips Head Drill Point	1	
13	8100500	Spacer, .25-inch x .9375-inch	1	
14	8120248	Insulation, Kaowool M-Board 14.50 X15.93 X 0.25-inch	1	
15	8120249	Insulation, Spinglas 16.75 X 19.38 X 1.00-inch	1	
16	8120269	Insulation, Kaowool Blanket 14.00 X 14.00 X 0.50-inch	1	
17	8233470SP	Replacement Frypot without Insulation - Stainless Steel	1	
17a	8231233SP	Replacement Frypot without Insulation - Cold-Rolled Steel	1	
18	9006441	Side, Combustion Chamber	1	
19	8067546	Thermostat Assembly, High Limit	1	
20	8261809	Thermostat, Sunne Operating	1	
20a	8160578	O-Ring, Thermostat Shaft	1	
20b	8160139	Knob - Thermostat	1	
21	8101569	Valve, 1.25-inch, Non-filter, Full-vat Drain	1	
22	8120246	Insulation, Spinglas 15.00 X 16.37 X 1.00-inch	1	
23	8120245	Insulation, Kaowool M-Board 15.00 X 16.37 X 0.25-inch	1	
24	9001090	Cover, Pilot Viewport	1	
25	8100647	Holder, Security Screw	1	
26	8090409	Screw, #10 X 0.5-inch Round Head One-way Security	1	

PART NOTES:

[1] - Items 4 and 22 through 26

GF40

Frypots (Post June 08 and current)

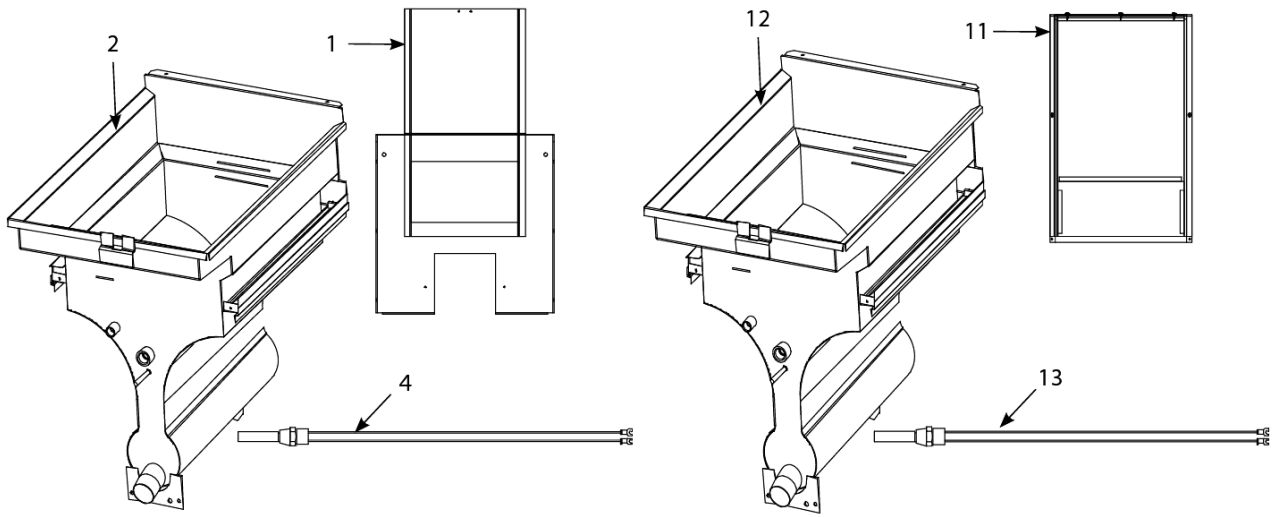

GF40

Frypots (Post June 08 and current)

#	PART #	DESCRIPTION	QTY	Note
1	8231024	Flue assembly	1	
1a	9103557	Fryer's Friend 27"	1	
2	8236655SP	Frypot, Standard	1	
2a	8234493	Frypot, Sysco-branded fryers	1	
3	8067972	Operating thermostat	1	[1]
4	1060770	Thermostat	1	
5	8261177	Thermostat, High-Limit 425°F/218°C	1	
6	8262014	Operating thermostat	1	
7	8160139	Knob - Thermostat	1	
8	9102113	Target, rear, GF14	1	
9	8101569	Valve, 1.25-inch, Non-filter, Full-vat Drain	1	
10	8260861	Insulation kit	1	
11	8065567	Flue	1	
11a	9103557	Fryer's Friend 27"	1	
12	8236667SP	Frypot	1	
13	8261177	Thermostat, High-Limit 425°F/218°C	1	
14	8262014	Operating thermostat	1	
15	8160139	Knob - Thermostat	1	
16	8101569	Valve, 1.25-inch, Non-filter, Full-vat Drain	1	
17	8260861	Insulation kit	1	

PART NOTES:

[1] - Sysco fryer