

SERVICE MANUAL

UNIVERSAL HOLDING CABINET (UHC)

MANUFACTURED BY
Frymaster®
P.O. BOX 51000
SHREVEPORT, LOUISIANA
71135-1000
PHONE 1-318-865-1711
1-800-24 FRYER



Universal Holding Cabinet	1-1
Power Up	2-1
Operational Overview	3-1
Operator Mode	4-1
Timer Operation	5-1
Cook More Prompts	6-1
Switching Between Breakfast, Lunch, Clean Mode and Slot Off	7-1
Slot Temperature Display	8-1
Temperature Alarms	9-1
Product Selection	10-1
Program Mode	10-1
Page Selection	10-2
Meal Selection	10-3
Exiting Program Mode	10-5
Example of Production Selection Change	10-6
Entering and Editing Product Information	11-1
Entering Password	11-1
Entering Product Name	11-1
Entering Product Holding Time	11-3
Enter Meal Usage	11-4
Display Adjustments	12-1
Change Display Time	12-1
Change Display Intensity	12-1
Change F° to C°	12-1
Troubleshooting Guide	13-1
Diagnostic Tests	14-1
Service Procedures	15-1
Parts Lists, Exploded Views	16-1
Wiring Diagram	17-1
Appendices	18-1
Appendix A: Food Item Default Settings	18-1
Appendix B: Cleaning and Preventive Maintenance	18-2
Appendix C: RTD Resistance Chart	18-4
Appendix D: SOC for Universal Holding Cabinet	18-5
Appendix E: Production Charts	18-6
Appendix F: Quick Reference Guide	18-7
Appendix G: Typical Setups/Stacked Arrangements	18-8

Frymaster L.L.C., 8700 Line Avenue 71106, 5489 Campus Drive 71129
P.O. Box 51000, Shreveport, Louisiana 71135-1000
PHONE 318-865-1711 FAX 318-219-7135

1 Universal Holding Cabinet

The Frymaster Universal Holding Cabinet (UHC) developed and manufactured exclusively for McDonald's, is a short-term holding device to extend the freshness of a wide variety of cooked products. The UHC meets all McDonald's standards for safety, efficiency, and cleanliness.

1.1 Warranty Statement

- A. Frymaster L.L.C. makes the following limited warranties to the original purchaser only for this equipment and replacement parts:

1.1.1 Warranty Provisions – Universal Holding Cabinet

- A. Frymaster L.L.C. warrants all components against defects in material and workmanship for a period of two years.
- B. All parts, with the exception of fuses, are warranted for two years after installation date of cabinet
- C. If any parts, except fuses, become defective during the first year after installation date, Frymaster will also pay straight-time labor costs to replace the part, plus up to 100 miles/160 km of travel (50 miles/80 km each way).

1.1.2 Parts Return

- A. All defective in-warranty parts must be returned to a Frymaster Authorized Factory Service Center within 60 days for credit. After 60 days, no credit will be allowed.

1.2.3 Warranty Exclusions

- This warranty does not cover equipment which has been damaged due to misuse, abuse, alteration, or accident such as:
- Improper or unauthorized repair;
- Failure to follow proper installation instructions and/or scheduled maintenance procedures as prescribed in your MRC cards;
- Improper maintenance;
- Damage in shipment;
- Abnormal use;
- Removal, alteration, or obliteration of the rating plate;

This warranty also does not cover:

- Transportation or travel over 100 miles/160 km (50 miles/80 km each way), or travel time over two hours;
- Overtime or holiday charges;
- Consequential damages (the cost of repairing or replacing other property that is damaged), loss of time, profits, use or any other incidental damages of any kind.

There are no implied warranties or merchantability or fitness for any particular use of purpose.

For international warranty, the above procedures apply, except that the customer is responsible for freight and duty charges.

PARTS ORDERING AND SERVICE INFORMATION

Parts orders may be placed directly with your local Frymaster Factory Authorized Service Center (FASC)/Distributor. A list of Frymaster FASC/Distributors was included with the cabinet when shipped from the factory. If you do not have access to this list, please contact the Frymaster Service Department at 1-800-24-FRYER or 1-318-865-1711.

Please note that orders for wire/plastic trays, stacking kits, carts and casters should be placed with your local Kitchen Equipment Supplier (KES). Frymaster does not supply these accessory items.

To speed up your order, the following information is required:

Model Number _____
Serial Number _____
Voltage _____
Item Part Number _____
Quantity Needed _____

Service may be obtained by contacting your local Frymaster Authorized Service Center/Distributor. Service information may be obtained by calling the Frymaster Service Department. The following information will be needed in order to assist you quickly and efficiently:

Model Number _____
Serial Number _____
Nature of the
Problem _____

Also any other information which may be helpful in solving your service problem.

RETAIN AND STORE THIS MANUAL IN A SAFE PLACE FOR FUTURE USE.

1.2 Product Trays

There are 3 product tray sizes. See Appendices A and C for specific product volumes and recommended holding sizes and times. Use the tray that is designed for the specific product described below:

- A. **1/3-size plastic tray** – Holds meat and egg products that are grilled (hamburger patties, bacon, eggs, sausage, etc.) There are two important procedures to remember when storing grilled products:
 - The product should not be drained when picked up from the grill.
 - The product is stacked when placed in the proper tray. 10-1 and sausage patties can be stacked up to six high. Eggs (except scrambled), grilled chicken and 4-1 patties can be stacked up to three high.

- B. **1/2-size wire tray** – holds fried products (McNuggets, McChicken, Filet-O-Fish, etc.) Remember this important procedure when storing fried products:
 - Fried products are to be placed on the wire rack. The rack should be placed on a crumb tray. No tray liners are required for these trays.

- C. **Full-size plastic tray** – holds baked products (biscuits, muffins, etc.) Follow these procedures for baked products:
 - After the biscuits have been removed from the biscuit oven, remove the wrapper and open the cardboard box.
 - Put a tray liner in the tray and slide the biscuits onto the liner. The biscuit trays can hold up to 30 frozen biscuits, 20 scratch biscuits or 20 muffins.

Important Operational Tips

When placing a tray into the cabinet, make sure the slot line on the tray handle lines up with the edge of the slot.

Discard cracked or damaged trays.

When removing portions from a tray, slide the tray only as far as needed, then quickly return the tray to the slot line.

1.3 Install Grill Clip

The grill clip is shipped in the accessory package and is designed to hold the 1/3-size grill tray. It attaches to the grill to make transfer from the grill to the UHC faster and safer.

- Position the front of the grill clip under the lip of the grill.
- Lower the back of the clip until the grooves rest over the grill bar. The grill clip should firmly seat on the front of the grill. If the clip doesn't fit snugly, simply loosen the four nuts under the clip and slide it in or out as needed to tighten against the bar. Tighten the nuts after the clip is properly adjusted.



The grill clip attaches to the grill and holds grilled product in a UHC tray, making transfer to the holding cabinet easier.

1.4 Installation of 4" Legs

CAUTION

Use caution when handling the cabinet or tilting the unit to/from the floor to install the legs. Maneuvering the cabinet should be accomplished by at least two people.

- A. Carefully place the Universal Holding Cabinet on its right side (direction is determined with you facing the front of the unit), exposing the base of the cabinet.
- B. Mount the leg pads to the bottom of the base using the 16-1/4"-20 x 1/2" long screws and lockwashers provided.
- C. Screw the leg into the mounted leg pad until fully tight.
- D. Carefully turn the UHC upright until the unit stands on its legs. Perform Step 2, *Power Up*.

IF THE UHC IS INSTALLED WITH THE COUNTERTOP OPTION, ENSURE THE AREA WHERE THE UHC BASE AND COUNTERTOP MEET IS PROPERLY SEALED WITH A FOOD GRADE TYPE SEALANT.

2 Power Up

ALL ELECTRICALLY OPERATED APPLIANCES MUST BE ELECTRICALLY GROUNDED IN ACCORDANCE WITH LOCAL CODES, OR IN THE ABSENCE OF LOCAL CODES, WITH NATIONAL ELECTRIC CODE, ANSI/NFPA NO. 70-1990.

A. Power Requirements:

- Voltage – 208/240 VAC
- 2620 Watts @ 208V – 3420 Watts @ 240V
- Frequency – 50/60 Hertz
- Single Phase
- 20 amp Service

THIS APPLIANCE IS EQUIPPED WITH A THREE-PRONG GROUNDING PLUG FOR YOUR PROTECTION AGAINST SHOCK HAZARD AND MUST BE PPLUGGED INTO A PROPERLY GROUNDED THREE-PRONG RECEPTACLE. DO NOT CUT OR REMOVE THE GROUNDING PRONG FROM THIS PLUG.

B. Plug the Universal Holding Cabinet into the power source.

C. Place the power switch in the ON position. All control displays will illuminate green approximately 2 seconds after the power switch is activated.

D. Monitor the temperature of the slots. The time it takes the slot(s) to heat from ambient (room) temperature to a 155°F (68°C) setpoint should be approximately 15 minutes. It should take approximately 25 minutes to reach a 200°F (93°C) setpoint. If setpoint is not consistently achieved within these limits, call your local Factory Authorized Service Center for repair.

3 Operational Overview

The Universal Holding Cabinet (UHC) has either four slots that can hold up to three trays of product per slot or two slots, which hold up to three trays. Each slot has a controller that indicates the holding time and product selection for each tray position.

Universal Holding Cabinet (UHC)

The operator enters information into the controller via the display and keypad shown below. Each product selection has a temperature setpoint and product holding time. All product timers run independently. *The slot temperature is controlled by the temperature setpoint of the leftmost product entry in each slot as viewed from the front of the cabinet. Product selections that have a holding temperature different than the leftmost product selection will not be available for entry into that slot's configuration.*

Most UHC's have a front and rear display for each slot. All operator mode selections can be made from either display. Program changes can only be made from the front display. A **Special Point of Distribution (SPOD)** cabinet has only a front controller for each slot.

UHC Controller (Front Display and Keypad)

Timer keys (Left, Center, and Right) start and stop the timer associated with each tray position. The timer keys also turn off audible alarms.

Displays (Left, Center, and Right) show product selection and holding time for each tray position. The displays also provide programming information in program mode.

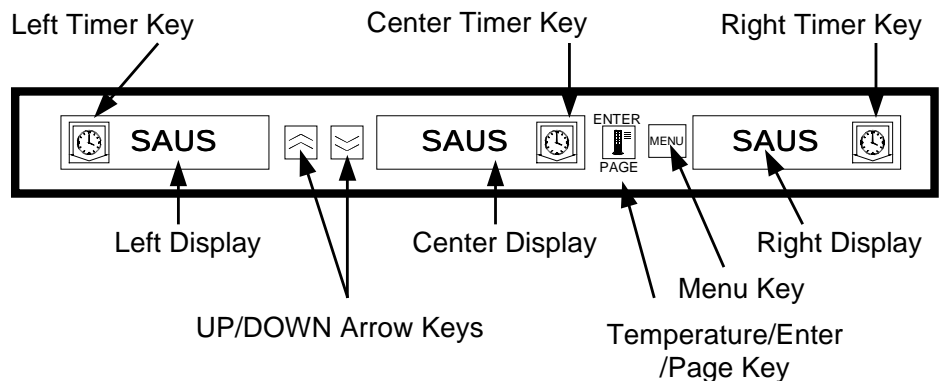

MENU key is used to select meal transitions (breakfast to lunch), Clean Mode operation and to turn individual slots on or off. The MENU key also provides access to program mode.

TEMPERATURE/ENTER/PAGE key has three functions. 1) Display slot temperature information; 2) Enter operational changes; and 3) Select Page parameters in program mode.

Up and Down ARROW keys are used to increase/decrease variables or change selections.

UHC Controller (Rear Display and Keypad, Traditional UHC Only)

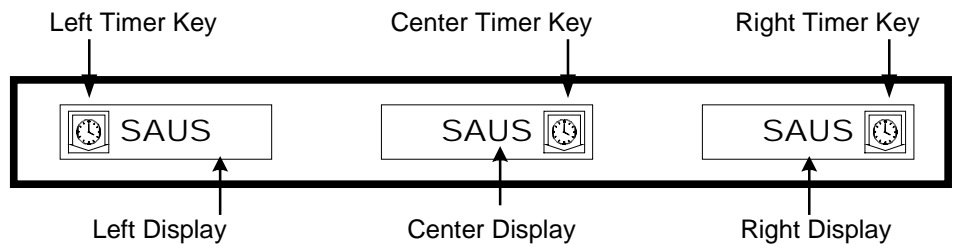

4 Operator Mode

Operator Mode is the normal operating mode of the controller when all slots are at the proper temperature and no alarm conditions exist. Product information and holding time is displayed.

4.1 Display of Product Information

In Operator Mode the slot display indicates the following:

1. **The product selection for a tray location.**
2. **The holding time remaining (in minutes) for active timers.**

An active timer alternately displays the product selection and the time remaining. Inactive timers display only product selection.

4.2 Product Information and the Use First Display

The Operator Mode indicates product selection and holding time status by changing the display intensity.

The “Use First Display” indicates the product with the least amount of holding time remaining. There are two levels of display intensity used to indicate product status.

1. **Brighter level of display intensity and running dots** indicate the “use first” product selection.
2. **Lower level of display intensity** indicates:
 - a. An active timer that is not the product selection with the least holding time remaining.
 - b. An inactive timer where only the product selection is displayed.

Timer Status Indicators

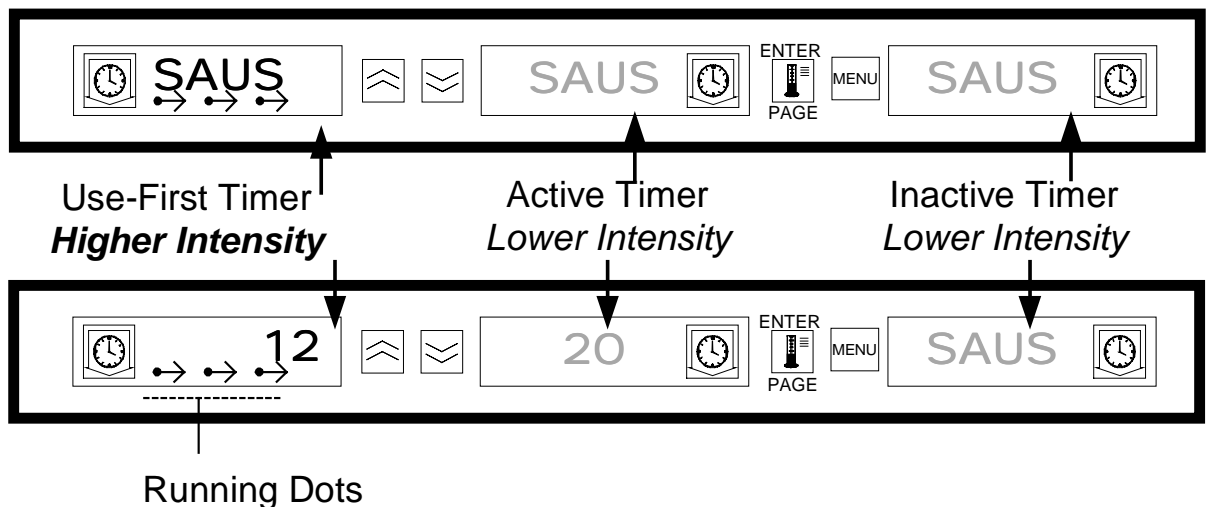

5 Timer Operation

5.1 Starting A Timer

Press the **Timer key above the tray position to start a timer**. The timer will time down from a preset value and alternately display product selection and the holding time remaining. If more than one tray of a product selection is timing, the location of the product with the least remaining holding time is indicated by the *Use First* display status.

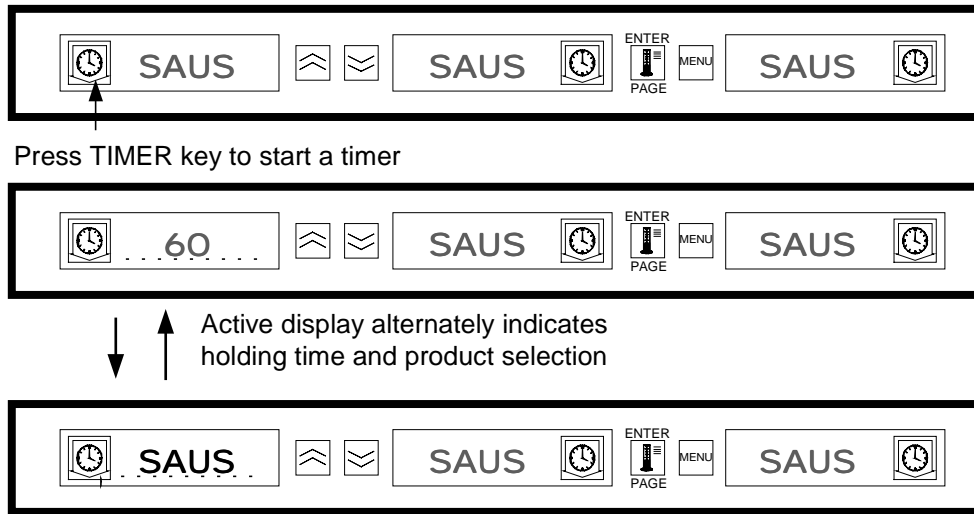

5.2 Stopping A Timer

Press the **Timer key above the slot position to turn off an active timer**. The timer stops timing and the display changes to the inactive timer status. If more than one tray of a product selection is timing, use first indication changes to next active timer.

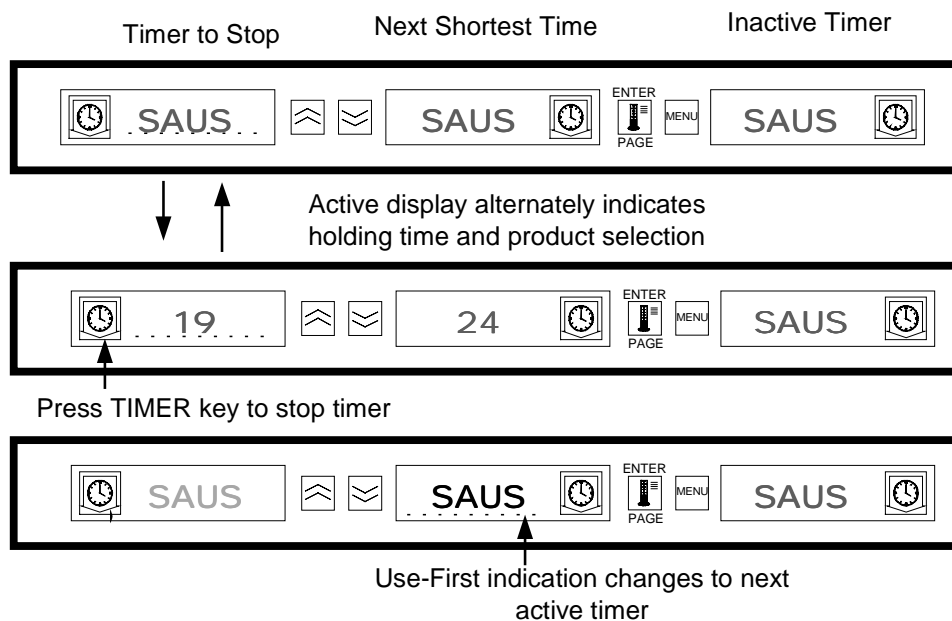

5.3 Timing Out

Time out indication alerts the operator that the product holding time has expired. When the holding time remaining reaches zero an audible alarm sounds and the display indicates -00-. All other active displays in the cabinet will switch to the lowest intensity level until the audible alarm is turned off.

Press the Timer key of the timed-out timer to clear the timer and turn off the audible alarm. If other timers in the cabinet have timed out, the audible alarm will remain on until all timers are cleared. When all timers are cleared, active timers return to normal status. *Use First* status is switched to the next timer with the least holding time remaining.

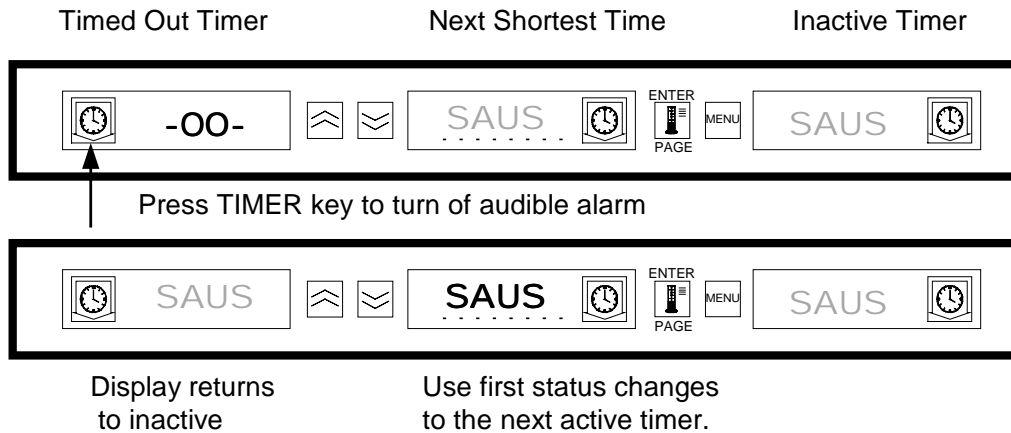

5.4 Buffer Timer

This feature allows an operator to adjust the holding time for a specified product by pressing the timer key. This means product can be transferred from a remote holding cabinet and the remaining hold time entered into another UHC. Time adjustments are in 5-minute increments.

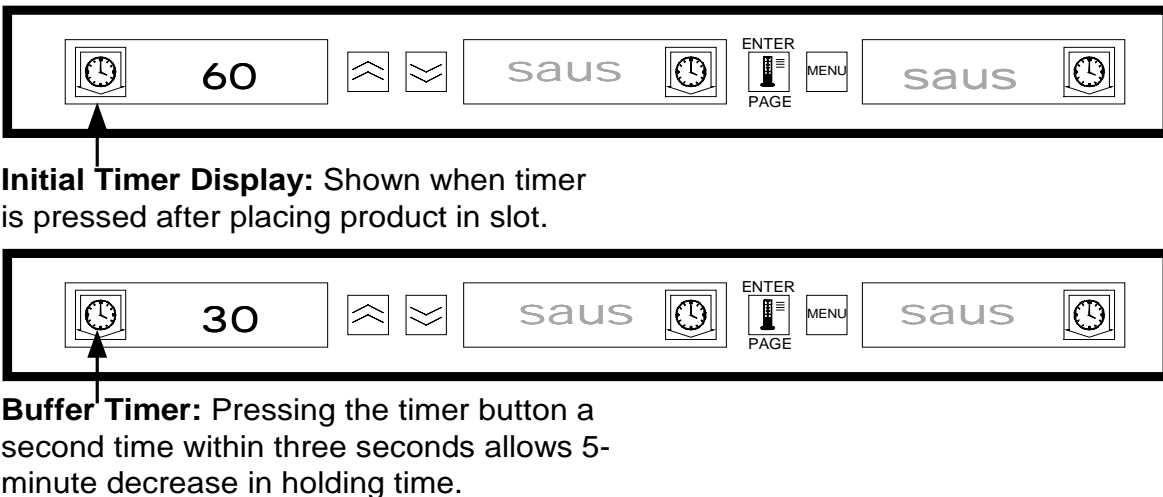

5.4 Buffer Timer (cont.)

When the "Use First" tray of a product is placed in the cabinet, the product timer is activated by pressing the corresponding timer key. The display immediately indicates the maximum holding time for the product and changes to Display Intensity three (brightest). If the timer key is pressed within 3 seconds of activating the timer, the product holding time will decrease by 5 minutes for each key press. If no timer key press occurs within 3 seconds, the display then alternately displays the remaining holding time and product mnemonic.

The Timer Display Time (TIMR TIME) and Product Display Time (PROD TIME) values determine how long (in seconds) that each message is displayed. Default settings for these values are 5 seconds and 1 second respectively.

To decrease the preset time, the holding time for each product, press the timer key and the displayed time will decrease in 5-minute increments each time the key is pressed. The timer key must be pressed within 3 seconds. If you wait longer than three seconds, the timer will reset. Preset times are the established holding times for each product. The Buffer Timer Feature is extremely useful when transferring product from another holding cabinet.

6 Cook More Prompts

The Cook More Prompts feature provides the operator with visual and audible notification that the last tray of a specific food product will be expiring soon and it is time to cook more. This feature is programmable, in one-minute increments, at the restaurant level.



When the holding time of a product equals a preset "cook more" time, an audible alarm sounds for 3 seconds and the display will alternately display: the remaining holding time / product mnemonic / COOK MORE.

- No acknowledgment of the audible alarm is required. It occurs only to get the attention of the operator.



Cook More:

After accessing the Cook More feature, use the UP and DOWN arrow keys to change the cook more time.

To change the cook more time:

- Press and hold the MENU key for 5 seconds
- Press the PAGE key to scroll to View Page
- Press MENU key to scroll to the Security Lock
- Press the Up and Down arrow keys to enter the manager security code 247
- Press the PAGE key to scroll to the Cook Page
- Press the MENU key to scroll to the Product Selection
- Press the Up and Down arrow keys to change the product cook more time
- Press and hold the MENU key for 5 seconds to return to normal operation

7 Switching Between Breakfast, Lunch, Clean Mode and Slot On/Off

Pressing the **MENU** key scrolls the following information for each slot.

1. **The inactive meal product selection (breakfast or lunch).**
2. **Clean Mode.**
3. **Slot On/Off status.**

Pressing the **MENU** key again returns the display to Operator Mode.

7.1 Selecting Breakfast and Lunch

To establish the breakfast and/or lunch menu, determine the type and number of product tray(s) to use. The following is the established configuration of trays and products:

1/3-size plastic tray – holds meat and egg products that are grilled (hamburger patties, bacon, eggs, sausage, etc.). Each slot can hold up to three trays of this type.

1/2 size plastic tray with wire insert – holds breaded fried products (McNuggets, McChicken, Filet-O-Fish, etc.). Each slot can hold up to two trays of this type.

Full-size plastic tray – holds baked products (biscuits, muffins, etc.). Each slot can hold one tray of this type.

To change the product selection of a slot from Breakfast to Lunch, press the **MENU** key to display the lunch product selections. Press the **ENTER** key to activate the meal selection. If the **ENTER** key is not pressed within 5 seconds, the product selection will return to the Breakfast meal selection.

Changing Meal Selection

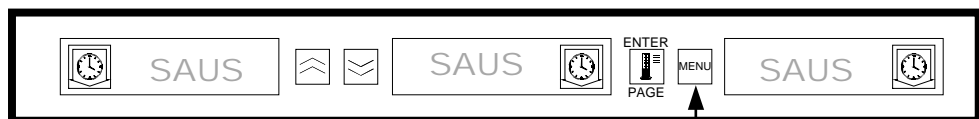

Press MENU key to display inactive meal selection

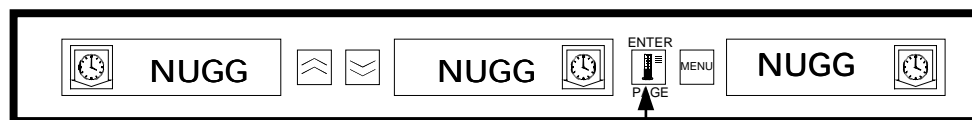

Press ENTER key to enter meal selection and return to normal display mode.



NOTE: Active timers will not change to the new meal selection until the timer(s) are stopped or timed out and reset. Active timer(s) are stopped by pressing the timer key. The default menu at start up is for breakfast items.

7.1 Selecting Breakfast and Lunch (cont.)

NOTE: Active timers will not change to the new meal selection until the timer(s) are stopped or timed out and reset. Active timer(s) are stopped by pressing the timer key. The Breakfast menu is the default at power up.

If the product selection for the meal has a holding temperature different than the current meal, a high or low temperature-alarm message displays to alert the operator that the holding temperature is being changed. To turn off the audible alarm press any **Timer Key**. The display alternately indicates the product selection and the alarm message until the slot temperature is within the preset limits. The alarm message automatically resets when the slot temperature is within the preset limits.

To change the product selection of a slot from Lunch to Breakfast, press the **MENU** key to display the Breakfast product selections. Press the **ENTER** key to activate the meal selection. If the **ENTER** key is not pressed within 5 seconds the product selection will return to the Lunch meal selection.

7.2 Clean Mode

Clean Mode changes the temperature setpoint of all slots in the cabinet to 125° F (52° C).

Starting Clean Mode

To start the Clean Mode press the **MENU** key to scroll to the Clean Mode message CLN MODE. Press the **ENTER** key to activate the Clean Mode. All slots in the cabinet will change to Clean Mode. If the **ENTER** key is not pressed within 5 seconds, the product selection will return to the previous meal selection. If the slot temperature is above 125° F (52° C), the display will alternately indicate SLOT CLN MODE and NOT SAFE YET. The display will indicate SAFE TO CLN when the slot temperature is 125° F (52° C).

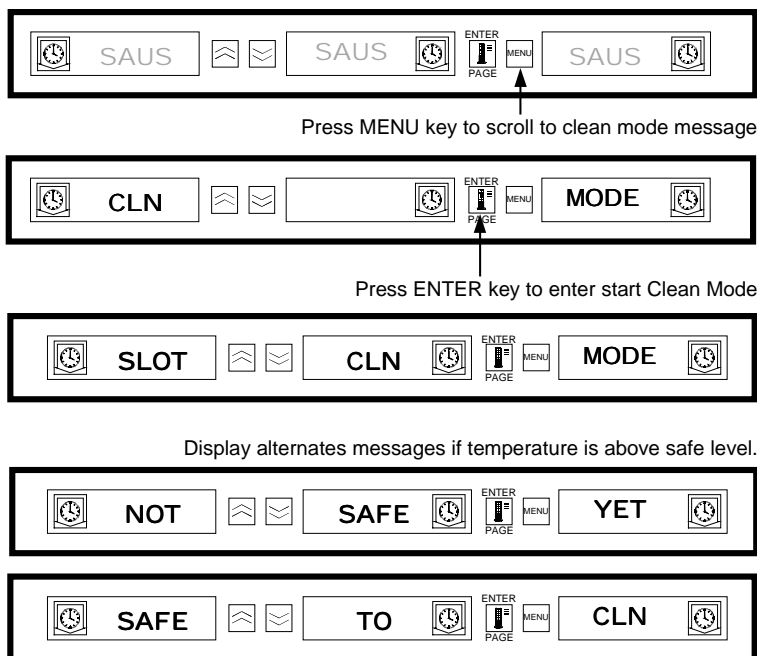

To exit Clean Mode, press the MENU key to display the Clean Mode message. Press ENTER to exit the Clean Mode and return to normal operation. The slot will alternately display SLOT TEMP LOW and the product selection until the temperature is within normal operating limits. If the ENTER key is not pressed within 5 seconds, the slot will return to the Clean Mode.

Exit Clean Mode

To exit Clean Mode press the **MENU** Key to display the Clean Mode message. Press **ENTER** to exit the Clean Mode and return to normal operation. The Slot will alternately display SLOT TEMP LOW and the product selection until the temperature is within normal operating limits. If the **ENTER** key is not pressed within 5 seconds the slot will return to the Clean Mode.

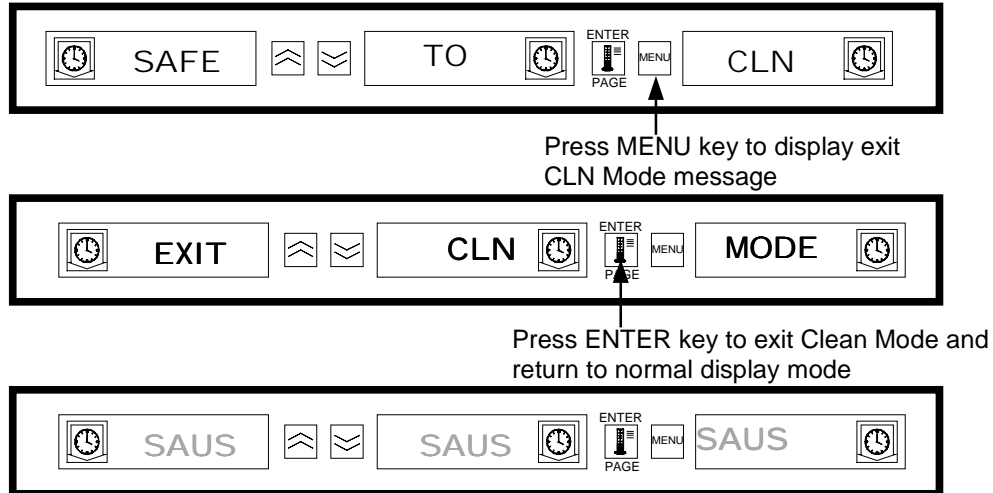

7.3 Slot On/Off

To turn a slot off, press the **MENU** key to scroll to the slot off message **TURN SLOT OFF**. Press the **ENTER** key to enter the selection. The display will read **SLOT IS OFF**. If the **ENTER** key is not pressed within 5 seconds, the product selection returns to the Operator Mode.

Turning Slot Off

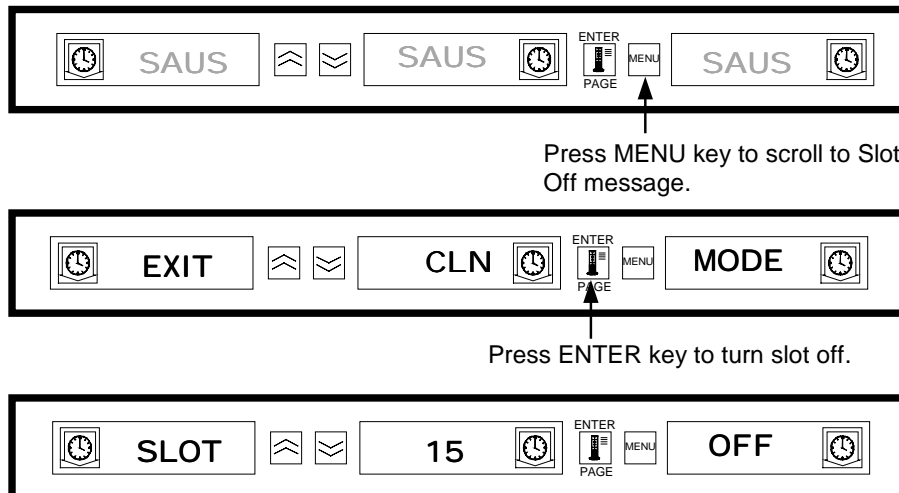

Turning Slot On

To turn a slot on, press the **MENU** key to scroll to the slot on message (TURN SLOT ON). Press the **ENTER** key to enter the selection and return to the Operator Mode. The slot alternately displays **SLOT TEMP LOW** and the product selection until the temperature is within normal operating limits. If the **ENTER** key is not pressed within 5 seconds the slot returns to the **SLOT OFF** status.

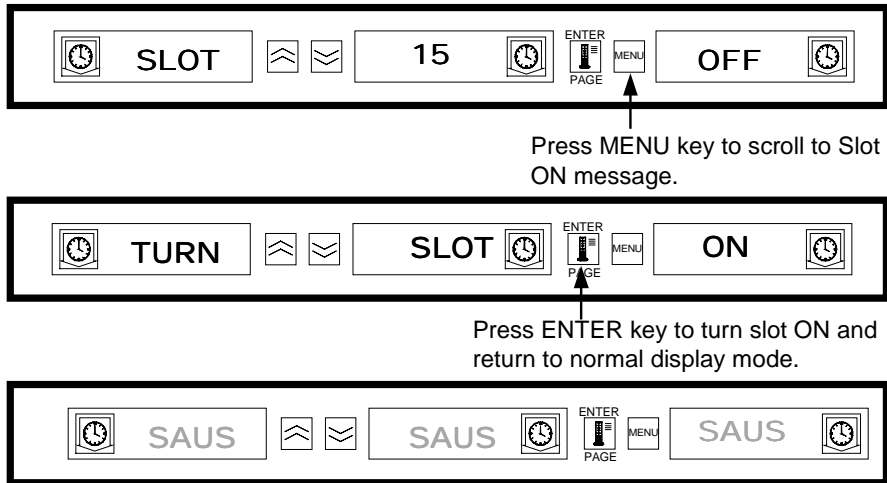

8 Displaying Slot Temperature Information (Temperature Key)

Pressing the **Temperature/ENTER/PAGE** key scrolls the following temperature information for each slot.

1. Top plate temperature
2. Bottom plate temperature
3. Top plate setpoint
4. Bottom plate setpoint

Pressing the ENTER key again will return the display to Operator Mode. The display will automatically return to Operator Mode if no key is pressed for 5 seconds.

Shelf Temperature Display

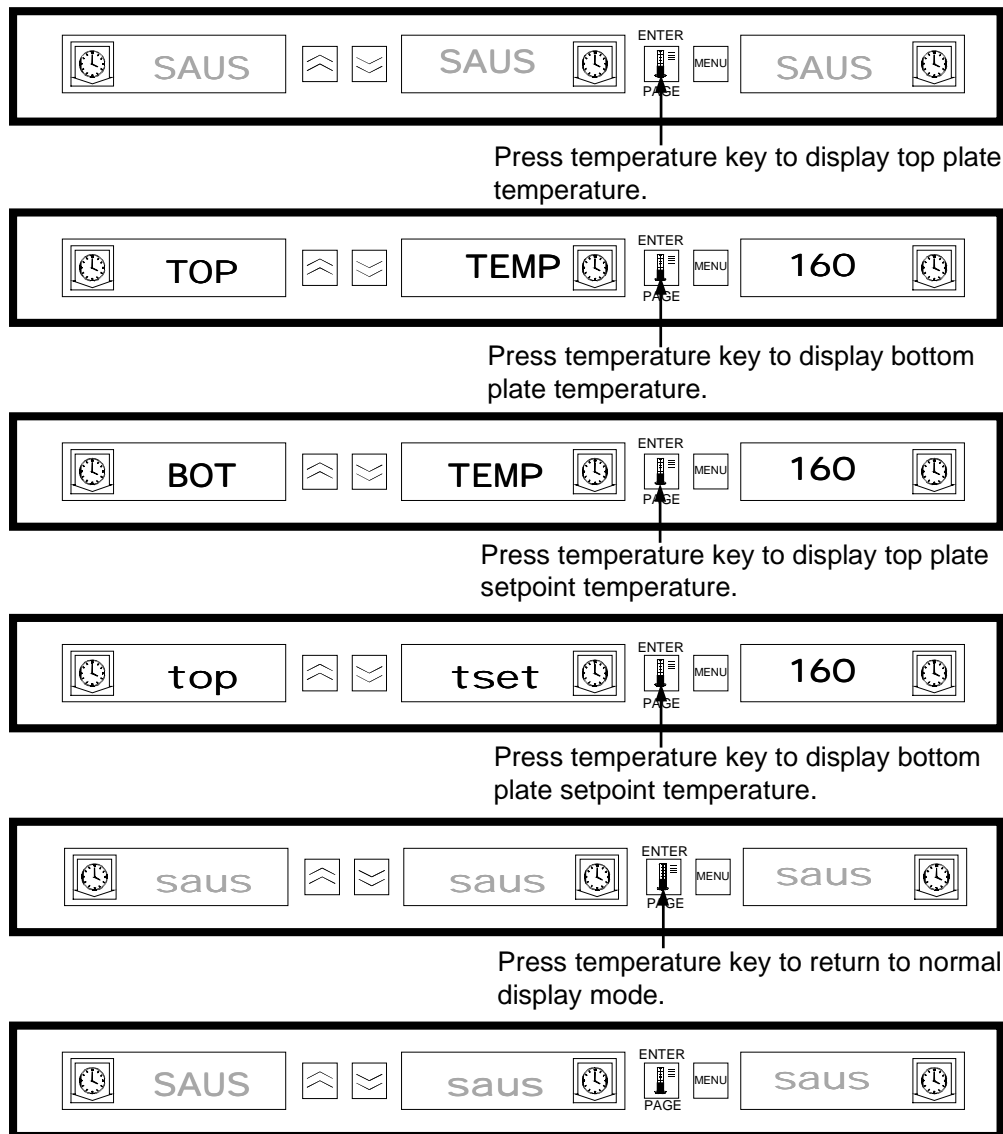

9 Temperature Alarms

There are five temperature alarm functions:

1. **High Temperature Alarm**
2. **Low Temperature Alarm**
3. **FDA Alarm**
4. **Sensor Alarm**
5. **Rise Time Alarm**

If alarm conditions occur an audible alarm will sound and the displays will alternately display the product selection and alarm message. Timers cannot be started when a slot is in alarm condition.

9.1 High and Low Temperature Alarm

If the slot temperature is above or below the preset limits for product selection, the controller will enter the High or Low alarm condition. The audible alarm will sound and the alarm message will read either SLOT TEMP HIGH or SLOT TEMP LOW.

To turn off the audible alarm, press any **Timer** key. The displays will alternately display the product selection and the alarm message until the slot temperature is within the preset limits. The alarm message will be displayed until the slot temperature is within the preset limits.

Alarm Display Messages

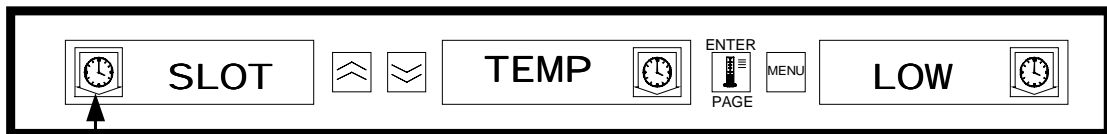

Press any TIMER key to turn off the audible alarm.

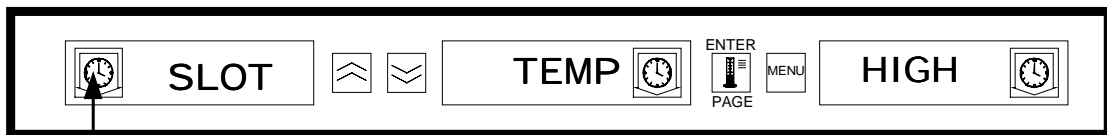

Press any TIMER key to turn off the audible alarm.

NOTE: The low temperature audible alarm is inhibited at power-up. The SLOT TEMP LOW message will be displayed until the slot temperature is within the preset limits.

9.2 Food and Drug Administration (FDA) Alarm

The FDA Alarm indicates the slot temperature is below the preset limit to hold the product. The audible alarm will sound and the alarm message will read TEMP UNDR FDA. Active timers are automatically reset.

To turn off the audible alarm, press any **Timer** key. The alarm message will remain until the slot temperature is within the preset limits. If no keys are pressed the audible alarm and alarm message will remain. **A Timer Key must be pressed to clear a FDA Alarm.**



Press any TIMER key to turn off the audible alarm.

9.3 Sensor Range Alarm

The Sensor Fail alarm indicates a sensor temperature value above or below the operating limit 90° F (32° C) to 250° F (121° C) of the slot. The alarm message is SENS ALRM.

To turn off the audible alarm, press any **Timer** key. The alarm message will be displayed until the slot temperature is within the operating limits. Power to the slot's heaters will be turned off until the sensor is repaired. **Service will be required to correct a sensor alarm.**

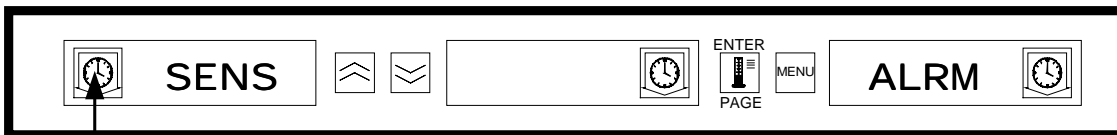

Press any TIMER key to turn off the audible alarm.

9.4 Rise Time Alarm

The Rise Time Alarm indicates that the slot temperature failed to reach operating temperature within the preset time limits of the system at power up.

To turn off the audible alarm, press any **Timer** key. **Service will be required to correct a Rise Time Alarm.**



Press any TIMER key to turn off the audible alarm and clear alarm message.

9.5 Additional Out of Tolerance Displays

9.5.1 HHHH

HHHH is the display indicates a sensor error. Service will be required to correct this condition.

9.5.2 LLLL

LLLL in the display indicates either a sensor error or a slot that is below 50° F (10° C). Allow the slot to operate for 30 minutes. If the LLLL remains, service will be required.

10 Product Selection For Each Slot

10.1 Program Mode

The following is the correct locations to program the slot controls based on the configuration of trays and products:

- **1/3-size plastic tray** – Since each slot can accommodate 3 trays, all displays can be programmed for a product. Remember, the temperature parameters established by the left display product will be in effect for the entire slot, but the timing and product settings can be different for each display within a slot.
- **1/2-size plastic tray with wire insert** – Since each slot can only accommodate two trays, the left and right displays will be used for controlling/monitoring the products. The center display should be voided by selecting NONE; the left and right displays should be active with selected product. Again, the temperature parameters established by the left display product will be in effect for the right display but the timing and product settings can be different for each display within a slot.
- **Full-size plastic tray** – Since each slot can accommodate one tray, the center display will be used to establish product parameters. The center display establishes the product parameter for the slot. The left and right displays should be voided by choosing NONE with only the center display active with the selected product.

Program Mode is used to select the products for each slot location. All selections are accomplished through simple PAGE and MENU selections. Each slot position has a page of configuration menus. The top slot in the cabinet is Slot 1. The **PAGE** key is used to select slots 1 – 4. The **MENU** key selects the configuration menu items (meal and tray location). The **Up/Down** arrow keys are used to select the available product selections for each meal. To enter the program mode, press and hold the MENU key for at least 5 seconds. The display will indicate the PROG MODE message.

To Enter Program Mode

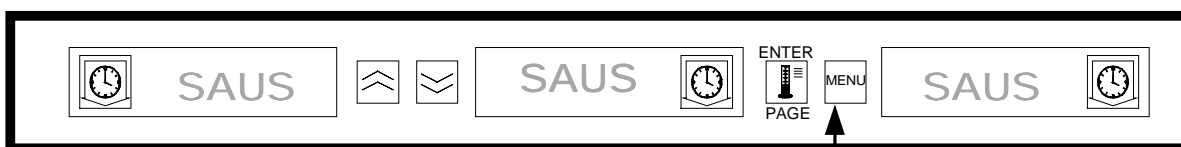

Press and hold the MENU key for at least 5 seconds to enter Program mode

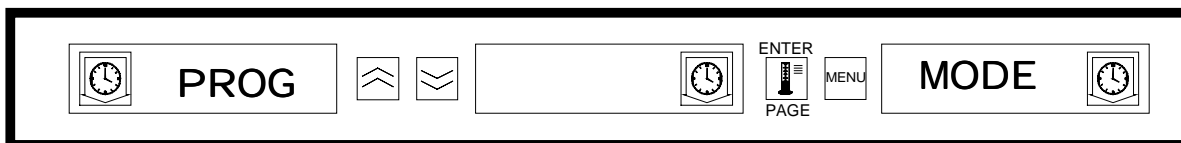

10.2 Page Selection

Each slot contains product selections for each meal (Breakfast or Lunch). To select the page press the **PAGE** key to scroll to the desired slot 1 – 4.

To Select the Slot Page:

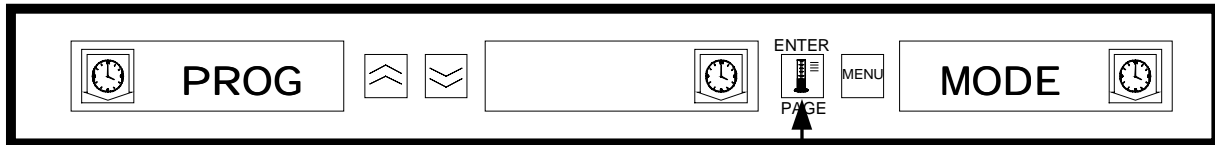

Press the PAGE key to scroll to slot page selections.

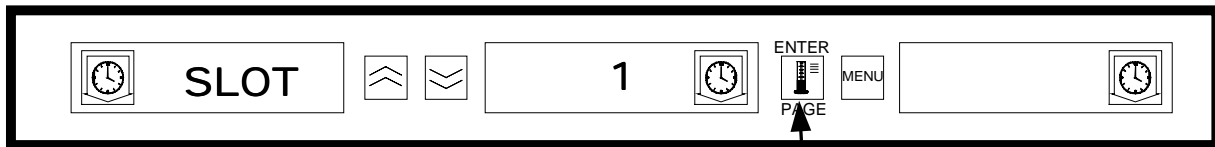

Press the PAGE key to scroll slot page selections.

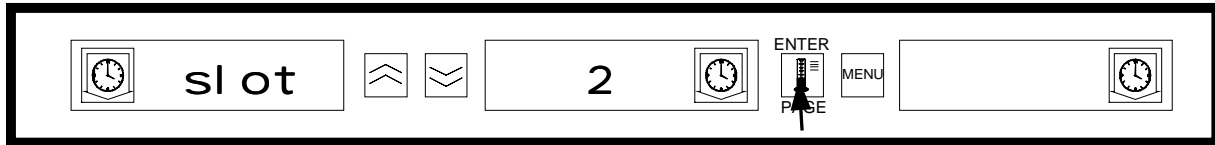

Press the PAGE key to scroll slot page selections.

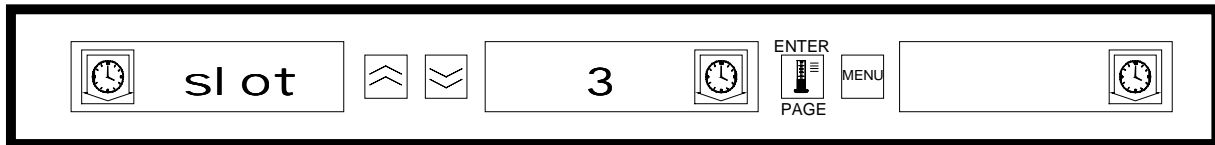

Press the PAGE key to scroll slot page selections.

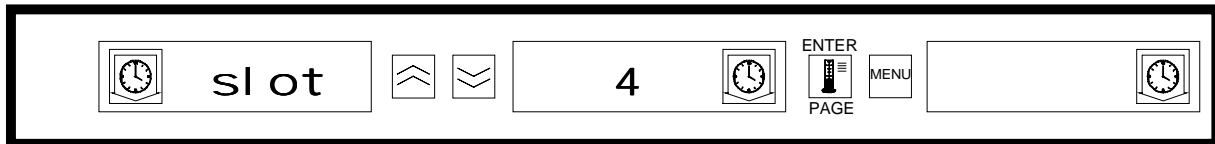

10.3 Meal Selection and Tray Position

Pressing the **MENU** key scrolls the meal and tray position in the left and center displays. The current product selection is indicated in the right display.

To Select the Meal and Tray Position:

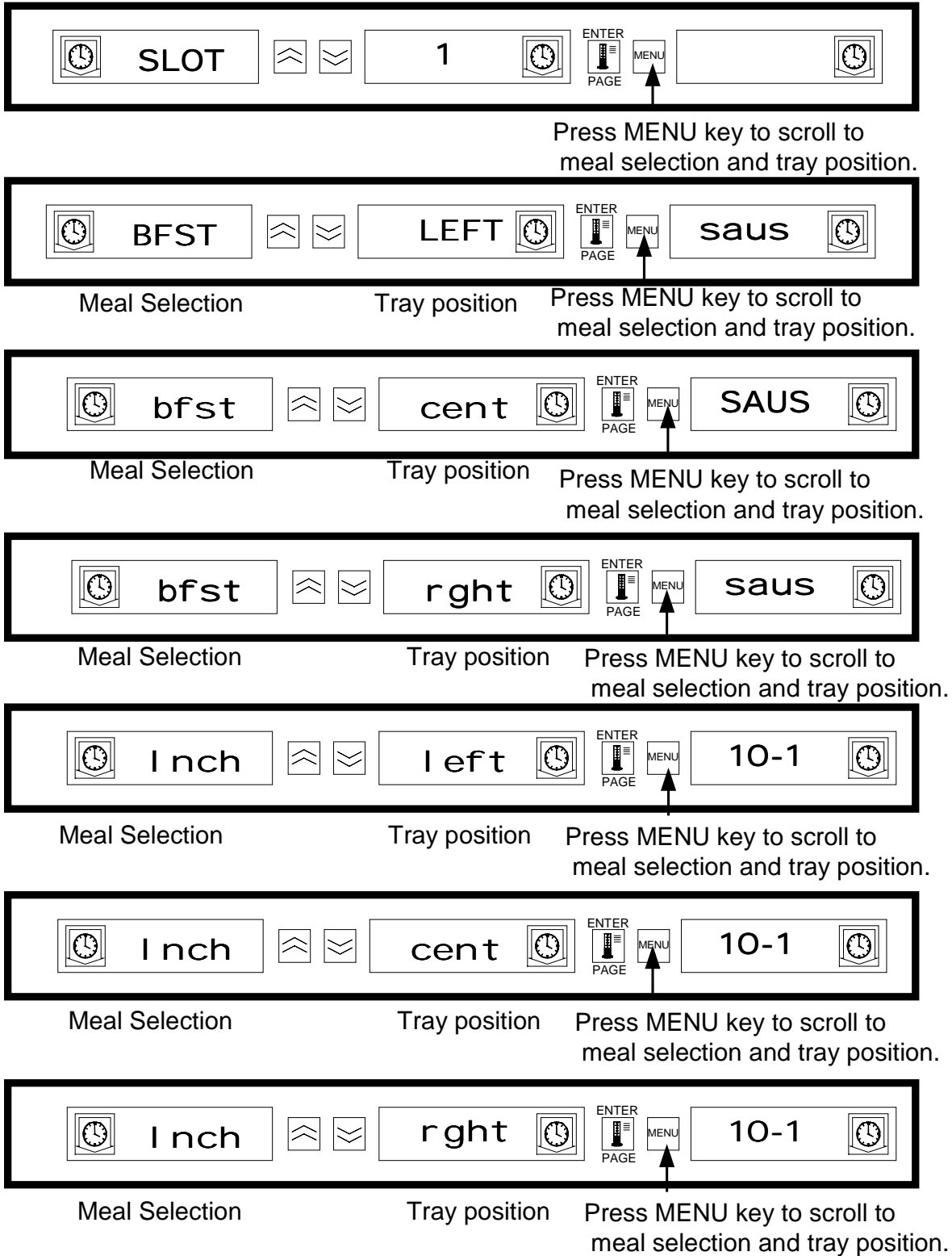

10.4 Product Selection

The **Up/Down** arrow keys are used to scroll the available product selections for each meal and tray position.

The product selected for the left tray position of each meal determines the holding temperature for the slot. Only products that have holding temperatures within 5° F (3° C) of the left most product selection will be displayed for selection in the center and right tray position.

If the left most product selection is changed, and the left product is now a different temperature, the center and right positions must be re-entered. If the product selection for an active timer is changed, the timer is automatically reset.

To Enter a Product Selection:

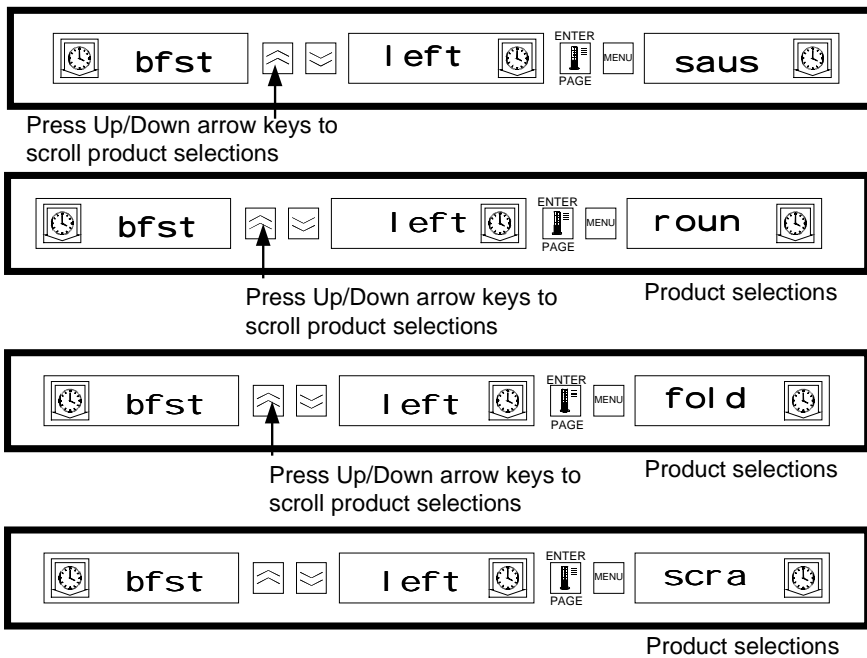

10.5 Exiting Program Mode

To return to operating mode press and hold the **MENU** key for 5-8 seconds. The controller will automatically exit the program mode if no entries occur for 5 seconds.

To Exit Program Mode:

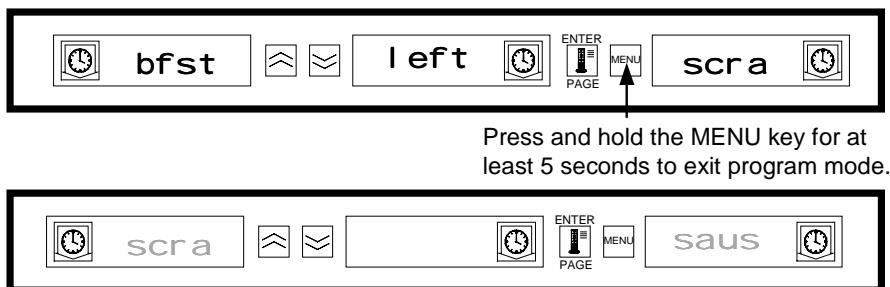

10.6 Product Selection Change (Example)

This example changes the lunch product selection in the left position of slot three from 10-1 to NUGG. Because the holding temperature for NUGG is different than 10-1, the center and right product selections will be cleared. Only items with holding temperatures within 5° F (3° C) of the left product selection can be entered for the center and right position.



Press and hold the MENU key for at least 5 seconds to enter Program mode.

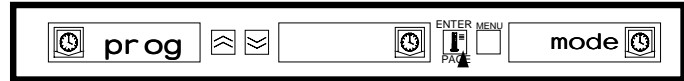

Press the PAGE key to scroll the slot selections.

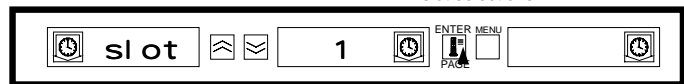

Press the PAGE key to scroll the slot selections.

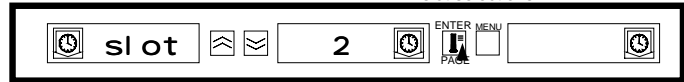

Press the PAGE key to scroll the slot page selections.

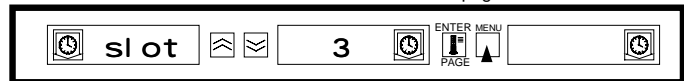

Press the MENU key to scroll meal selection and tray position.

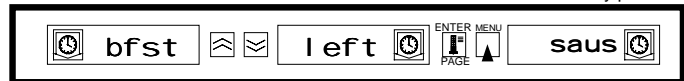

Meal Selection Tray Position Press the MENU key to scroll meal selection and tray position.



Meal Selection Tray Position Press the MENU key to scroll meal selection and tray position.



Meal Selection Tray Position Press the MENU key to scroll meal selection and tray position.



Meal Selection Tray Position Press the MENU key to scroll meal selection and tray position.



Press Up/Down arrow keys to scroll product selections

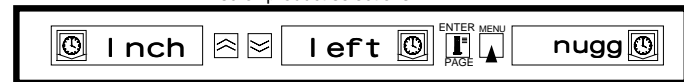

Press and hold the MENU key for at least 5 seconds to exit Program mode.

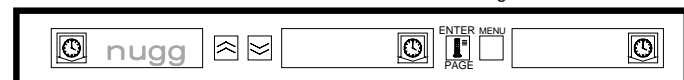

11 Entering and Editing Product Information

Changing or entering new product selections, holding times and temperature settings are password-protected functions. To enter the password, press and hold the MENU key for five seconds and enter Program Mode. Press the Page key to scroll to View PAGE. Press the MENU key to select the Security Lock (SECR LOCK).

11. 1 Entering password



Press and hold MENU key for 5 seconds to enter Program Mode

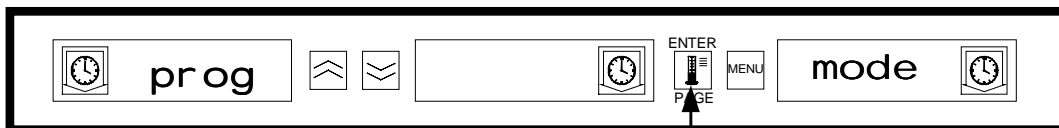

Press PAGE key to scroll to the VIEW page

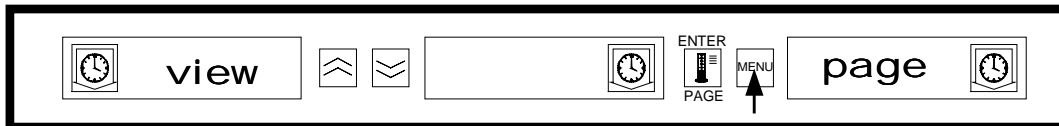

Press MENU key to scroll to the VIEW page

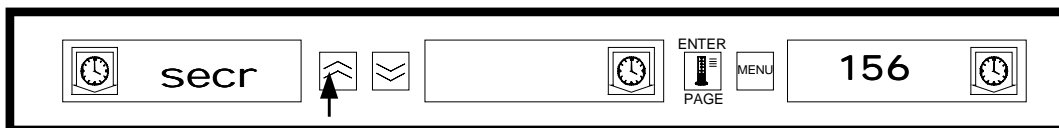

Press Up/Down arrow keys to enter password.



*Security code 247 is the manager-level password.

11.2 Entering a Product Name

A new product entry requires entry of the product name, holding time, holding temperature, meal selection and cook more time. The following example enters a new product (named XXY) with a holding time of 25 minutes, holding temperature of 180⁰F (82⁰C) and cook more time of five minutes.



Press PAGE key to scroll to the Edit Page

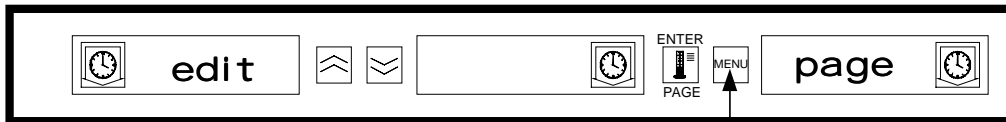

Press MENU key to scroll to an unused product space.

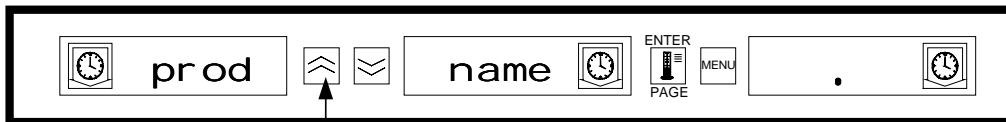

Press Up arrow key to scroll to the letter X.

Note: The decimal point indicates which display segment is being entered.



Press Down arrow key to scroll to next display segment.

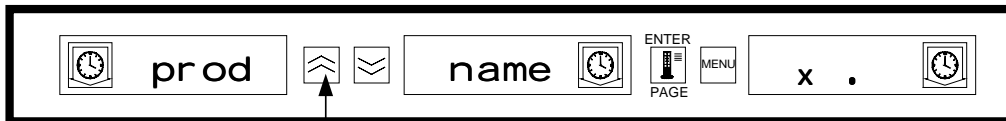

Press Up arrow key to scroll to the letter X.

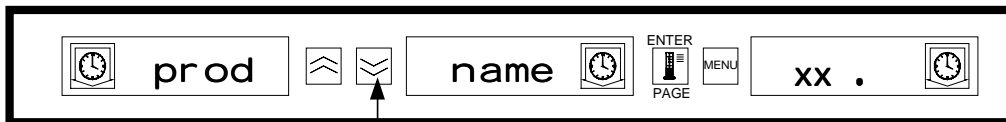

Press Down arrow key to scroll to next display segment.

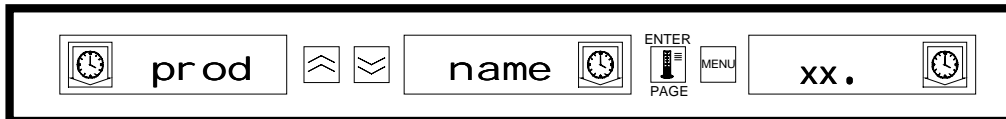

Press Up arrow key to scroll to the letter Y.

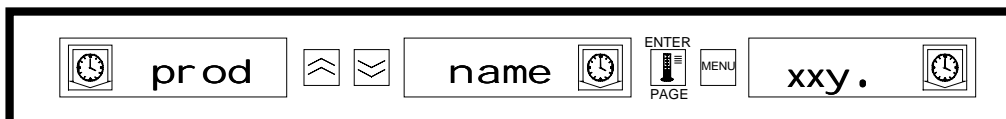

11.3 Entering Product Holding Time

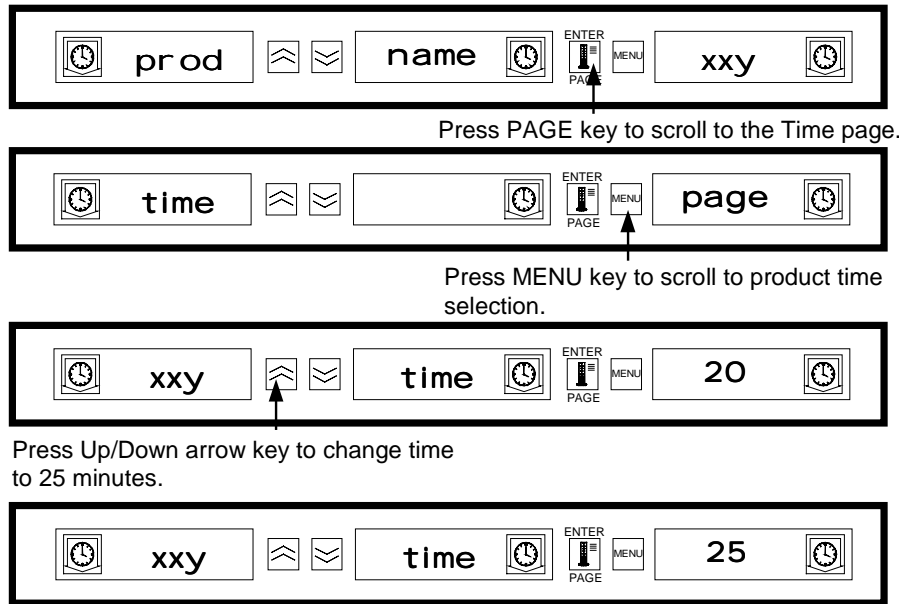

11.4 Entering Product Holding Temperature

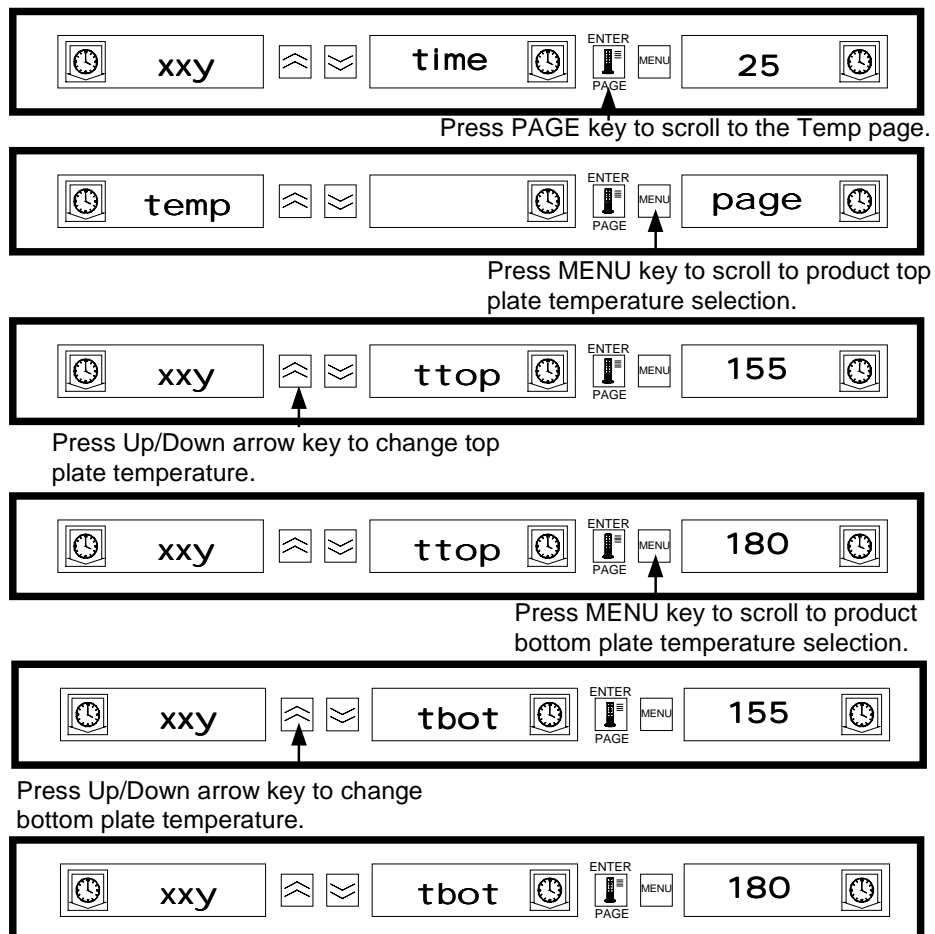

11.5 Enter Meal Usage

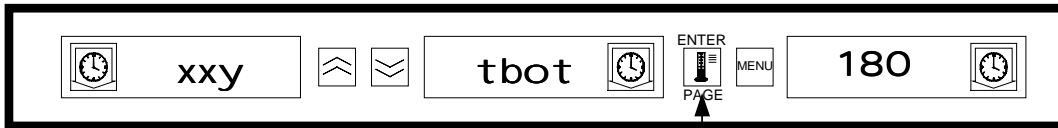

Press PAGE key to scroll to the Meal page.

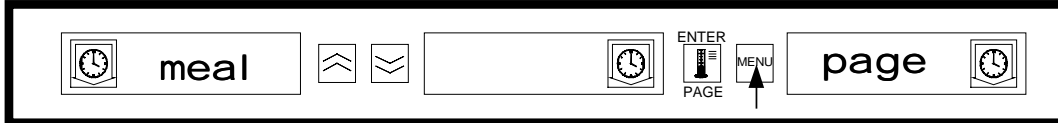

Press MENU key to scroll to product meal selection.



Press Up/Down arrow key to select BFST.



11.6 Enter Cook Time



Press PAGE key to scroll to the Cook Page.

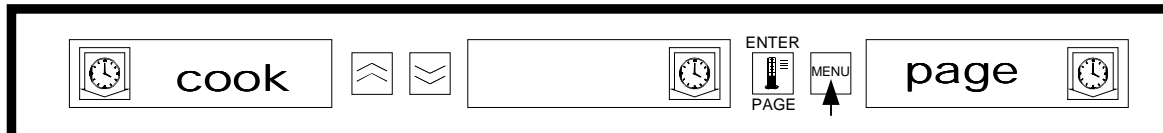

Press MENU key to scroll to the cook product selection.



Press Up/Down arrow keys to center desired cook warning time.



Press and hold MENU key for 5 seconds to exit Program Mode, return to normal operation.

12 Display Adjustments

12.1 Change Display Time

The rate at which an active timer alternately displays product selection and holding time may be adjusted as follows:

- ☞ Press and hold MENU key for 5 seconds
- ☞ Press PAGE key to scroll to View Page
- ☞ Press MENU key to scroll to the Security Lock
- ☞ Press Up and Down Arrow keys to enter the security code
- ☞ Press MENU key to scroll to Product Display time (PROD TIME)
- ☞ Press Up and down Arrow keys to change Product Display Time
- ☞ Press MENU key to scroll to Timer display Time (TIMR TIME)
- ☞ Press Up and Down Arrow keys to change Timer Display time
- ☞ Press and hold MENU key for 5 seconds to return to normal operation

12.2 Change Display Intensity

The brightness of each of the intensity levels used for product status may be adjusted as follows:

- ☞ Press and hold MENU key for 5 seconds
- ☞ Press PAGE key to scroll to View Page
- ☞ Press MENU key to scroll to the Security Lock
- ☞ Press Up and Down Arrow keys to enter the security code
- ☞ Press MENU key to scroll to Display Intensity Level
- ☞ Press Up and Down Arrow keys to change intensity level
- ☞ Press and hold MENU key for 5 seconds to return to normal operation

12.3 Change °F to °C

The following changes temperature indications from °F to °C.

NOTE: You must enter the Service code to setup or change a cook time.

- ☞ Press and hold MENU key for 5 seconds
- ☞ Press PAGE key to scroll to View Page
- ☞ Press MENU key to scroll to the Security Lock
- ☞ Press Up and Down Arrow keys to enter the security code 247
- ☞ Press MENU key to scroll to Display Units
- ☞ Press Up and Down Arrow keys to change °F to °C
- ☞ Press and hold MENU key for 5 seconds to return to normal operation

13 Troubleshooting Guide for the Universal Holding Cabinet

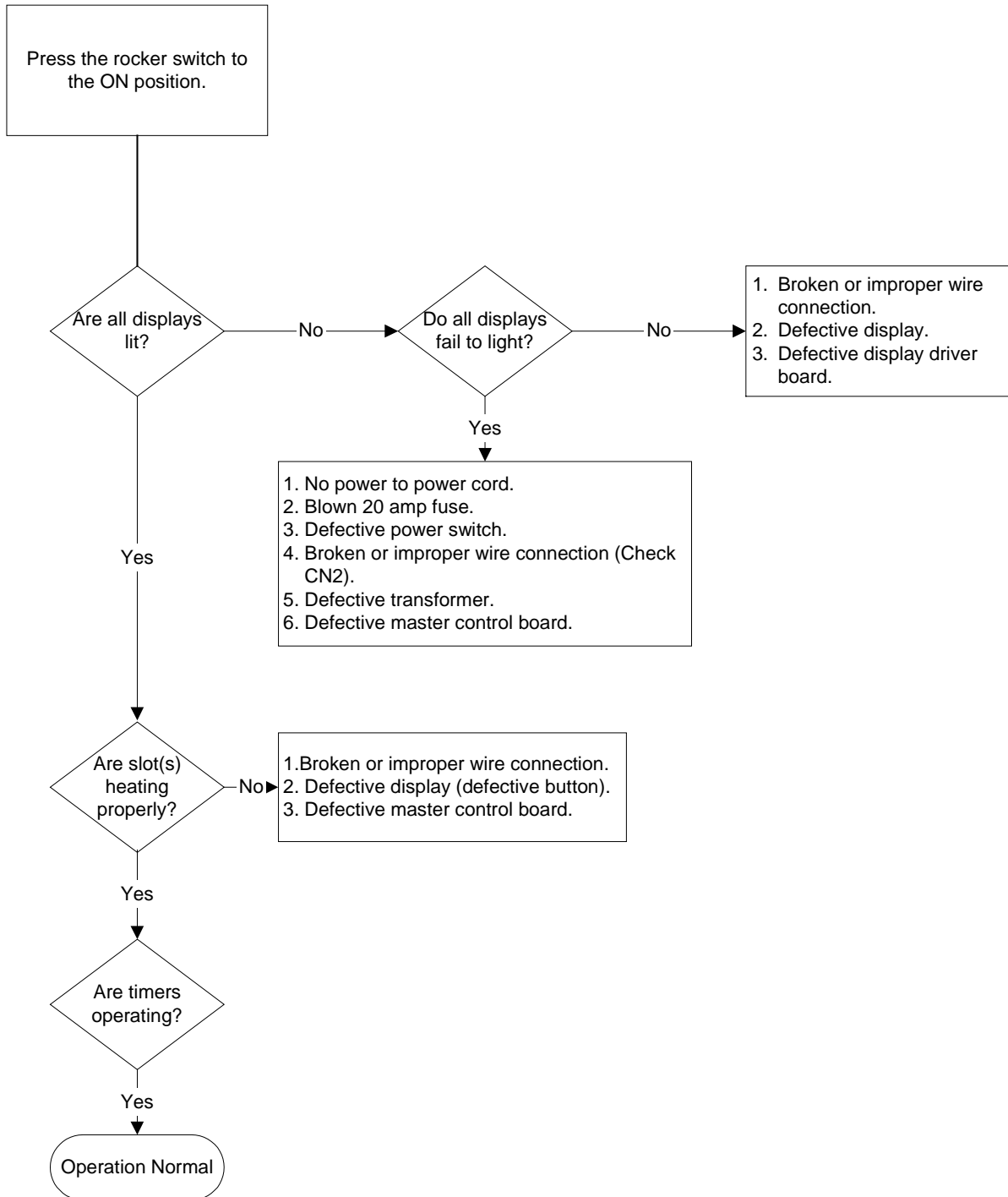

14 Tests

14.1 Transformer

1. Disconnect power to cabinet. Remove side and top panels, unless stacked. If stacked, see the service procedures for access instructions.
2. Mark for re-assembly, then remove the two bottom leads. Connect an AC meter across the outside terminals of the secondary. Apply power and note the voltage. If voltage is approximately 16 VAC, the transformer is operating normally. If zero or incorrect voltage is measured, measure the input voltage at the top two terminals (primary). The acceptable input voltage range is 177 to 264 VAC.

14.2 Master Control Board

Input Power

1. Disconnect power to the cabinet. Remove side and top panels unless stacked. If stacked, see the service procedures for access instructions.
2. Visually check all terminals and connections for loose or disconnected wires.
3. Apply power and measure AC voltage to board on connector CN1. Correct measurement is 16 volts across the two outside connectors and 8 volts from either outside connector to the center connector.

14.3 RTD/Master Board

1. Normally only one or two plates will be suspect. To isolate between a defective RTD, bad wiring connection or defective master board, first perform the heater plate test described in section 14.7.
2. If the plate tests OK (heater and RTD), isolate further by swapping the leads (heater and RTD) from the suspect slot with a slot that operates correctly.
3. If both slots operate correctly after swapping, a poor wire connection is the probable cause of the malfunction. (Reconnect the wires to their original slots and retest.)
4. If the original slot continues to malfunction with swapped leads, the master board is defective.
5. If the malfunction moves to the other slot, the heater plate/RTD assembly is defective.

NOTE: After testing, reconnect all leads to their original positions.

14.4 Master Board/Display Driver

1. To isolate between a defective master board or display driver, disconnect the front and rear ribbon cables (FC1 and FC2) and the CN2 connector on the suspect display driver. Disconnect the front and rear ribbon cables and the CN2 connector on the nearest display driver, which operates correctly.
2. Connect the connectors from the suspect display driver to a known good display driver and test the operation. If the malfunction continues, replace the master board. If the malfunction is corrected, replace the defective display driver.

NOTE: After testing, reconnect all connections to their original positions.

14.5 Shorted Triac

1. Turn the suspect slot off and measure voltage from the white terminal block to the top (black lead) heater plate. Also, measure voltage to the bottom heater plate. With slot off, there should be no line voltage. If the triac is shorted, you will measure AC line voltage. If the triac is half waving, you will get DC voltage of approximately one-half the line AC voltage. Also, with the slot off, measure the slot temperature. If the slot is heating, it is miswired or the master control board is defective (shorted triac).

14.6 Display Driver/Display Isolation Test

1. On stand-alone units, disconnect power to the cabinet and remove side and top panels. If unit is stacked, see service procedures for instructions on accessing the top panel.
2. Disconnect CN2 connector on the suspect display driver. Apply power. The selected display will indicate `Disp Test Mode`. (Note: All slots below the selected slot will not operate.) Press each functional button on the selected display, starting with the timer key at the left. Each button must be pressed in sequential order, starting at the left on the front display and continuing to the rear display on all slots. After all buttons have been pressed, each LED display segment should illuminate sequentially.
3. If the unit does not perform as described in step 2, isolate between a bad display or display driver by connecting the ribbon connector from the suspect display to one or the know good display drives and repeat the test.

NOTE: There is no output from the master control board during this test. If the unit does not operate as described in step 2, the problem cannot be the master control board.

14.7 Heater Plate

1. Disconnect power to the cabinet. On stand-alone units, remove side and top panels. On stacked units, see Service Procedures for instructions on accessing the top panel.
2. Disconnect the black heater lead and the two RTD leads (brown and red) of the suspect plate from the master board. Measure resistance of the heater from the black lead to any terminal on the white terminal block. Resistance should be 140-150 ohms.
3. Measure resistance across the brown and red RTD leads. Resistance must be within a range of 104-148 ohms. Resistance at room temperature is approximately 107 ohms. See chart on **Page 18-5** for resistance at different temperatures. If either resistance is incorrect, replace the heater plate.

14.8 Display Meanings

1. SLOT TEMP HIGH OR SLOT TEMP LOW and no audible alarm. This is normal when the slot is changing temperature in association with a menu change.
2. LLLL means the RTD indicates a temperature below 50°F (10°C). Unit will automatically heat at 20 percent until temperature is above 50°F (10°C), then operate normally.
3. HHHH means RTD indicates the temperature is above 255°F (124°C), but below "Open" circuit resistance, which causes SENS ALARM.
4. UHC VERSION _ _ _ (version number will vary) appears for five seconds when the unit is turned on. This is normal. If the UHC VERSION _ _ _ stays in the display, the normal cause is 120 VAC is applied instead of the nominal 200 to 250 VAC.

15 Service Procedures

15.1 Removing/Replacing Shelf Components

DANGER!! Failure to disconnect the power supply before servicing could result in serious injury or death. The cabinet power switch DOES NOT disconnect all incoming power to the cabinet.

1. Turn the UHC off, disconnect the power supply and allow the unit to cool (approximately 60 minutes).
2. Use a #2 Phillips-head screwdriver to remove two #10 truss-head screws from each side of the unit (**Fig. 1**).
3. Remove the side panels and set aside, being careful not to mar the panel finish.



Fig. 1. Removing side panel.

4. Removing the side panels allows access to display driver boards (removable by disconnecting the wire harnesses and removing the securing screws), fascia mounting screws and slot mounting screws (**Fig. 2**).
5. Use a 5/16" nut driver to remove the four cabinet screws holding the equipment shelf in place. The screws are located on each side of the unit, near the top corners of the inner panel.
6. Use 5/16" nut driver to remove the two #10-32 hex-head screws from each side of the front fascia.
7. Pull the front fascia out (you may use the Production Chart Holder as a grip to free the fascia from the cabinet) and up to reveal the front edge of the equipment shelf. (It is not necessary to disconnect the switch wiring. **Fig. 3**)

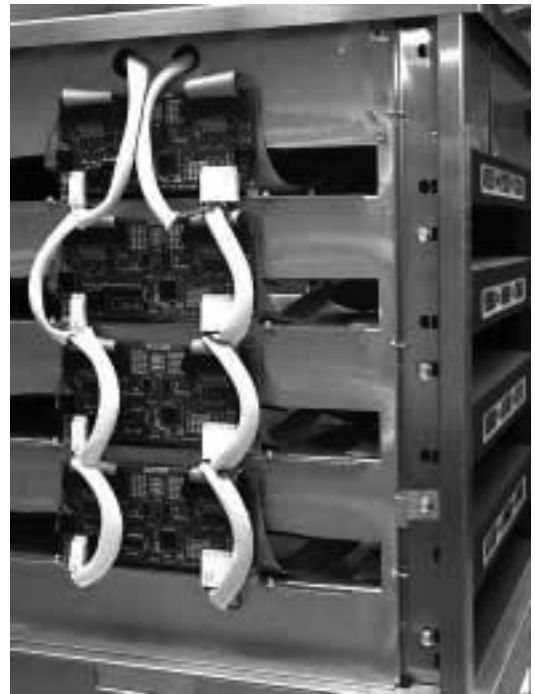

Fig. 2. Side panel removed.

NOTE: For accessibility of the fascia, the top of the unit may be removed if the configuration is either a single stand-alone unit or the top unit of a stacked arrangement.

8. Grab the edge of the shelf and pull out slightly. Remove the wire and wire harnesses to free the shelf. Mark each wire for reassembly. Pull the shelf until it engages the stops. Place the fascia on top of the shelf (**Fig. 4-5**).



Fig. 3. Removing front fascia.

9. This exposes the transformer, cooling fans, terminal blocks, fuses and main control board. These components are accessible and easily removable/replaceable.
10. Reassemble the unit by reversing the previous steps. Ensure all wiring connections are tight and in accordance with the wiring diagram. Ensure that all screws and other fasteners are snug.
11. Before reconnecting power to the unit, clean all stainless steel surfaces and the interior of the slots using approved cleansing agents. (See Appendix B).
12. Reconnect power, turn the power switch to the ON position and reprogram the controllers as necessary to the desired menu selections.



Fig. 4. Component shelf slid forward.

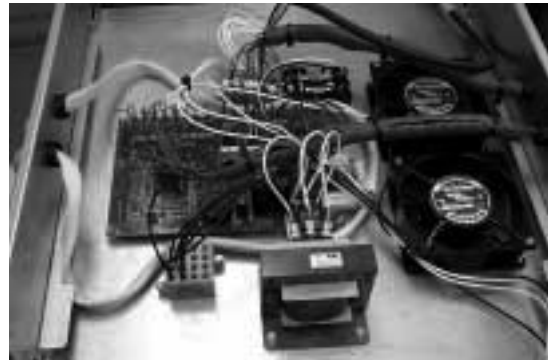

Fig. 5. Component shelf with UHC lid removed.

15.2 Replacing Membrane Switch/Switches

Perform steps 1-5 in Section 15.1

1. Release ribbon cable from top of driver board on left side of unit. Feed ribbon cable into space between slots (**Fig. 6-7**).
2. Remove Allen screw (not on early units) locking display bezel in place.
3. Loosen bolt-holding bezel.
4. Remove bezel, which contains the display, from the unit (**Fig. 7**).



Fig. 6. Remove ribbon cable from driver board.



Fig. 7. Feed ribbon cable out of UHC when bezel is removed.

5. Place bezel face down on table with slot hole at bottom and remove metal frame holding display. Note position of rib on metal frame and position of ribbon connection on display (**Fig. 8**).



Fig. 8. Note ribbon cable is at top of bezel opening.

6. Remove old display assembly.

7. Clean bezel.

8. Remove screws connecting the membrane switch to the display board (**Fig. 9**).



Fig. 9. Remove two screws securing the display board to the membrane switch.

9. Gently separate the membrane switch from the display board (**Fig. 10**).

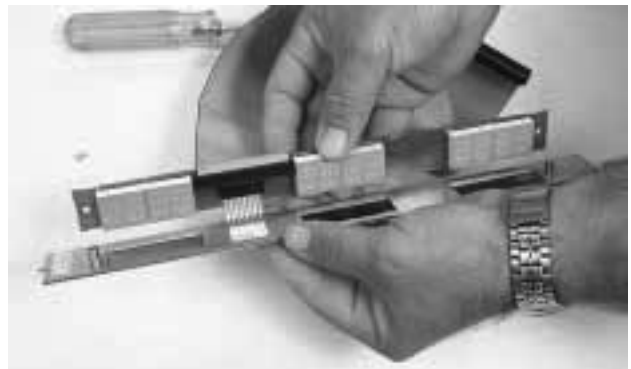

Fig. 10. Separate the display board and the membrane switch.

10. Disconnect the non-terminated ribbon, which connects the membrane switch to the display board, by gently pulling the cable from the connector on the display board (**Fig. 11**).

Note: Early production units (prior to S/N 9703) had the membrane switch soldered to the display assembly. For these units, the complete display assembly must be replaced. (Front Display Assembly: 807-3309; Rear Display Assembly: 807-3310.)



Fig. 11. The ribbon on the membrane switch is pulled free of the connector on the display board.

11. Attach the new membrane switch to the display board by sliding the non-terminated ribbon into the connector on the display board.

Note: The ribbon must be held flat during insertion. If it bows, it will not seat correctly (**Fig. 12**).

12. Replace screws securing display board to the membrane switch.
13. Return the display assembly to the bezel with ribbon connection at top.

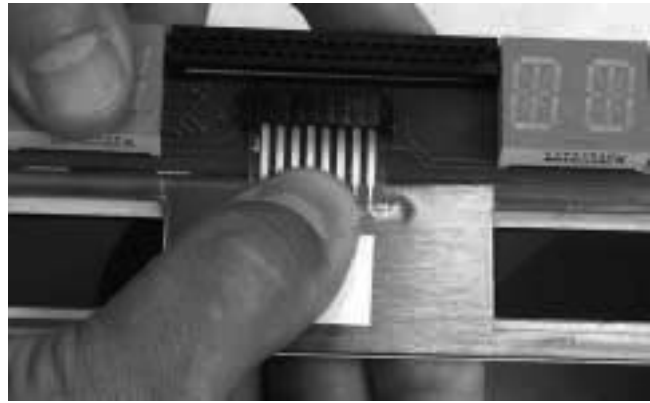

Fig. 12. Hold the ribbon cable flat when attaching the new membrane to the display board. The non-terminated cable will not seat properly if it is allowed to bow while inserting into connector.

14. Reposition metal frame (**Fig. 13**).
15. Return bezel to UHC, feeding ribbon cable through slot and back to the display driver board.
16. Reconnect ribbon cable to driver board.



Fig. 13. Position metal framework as shown.

17. When all membranes have been replaced, perform this test to ensure the displays are operating correctly:

With the cabinet's sides still off, disconnect CN2 connector from the display driver(s) to be tested (**Fig. 14**). Plug unit in and turn on power switch. The selected display will show Disp Test Mode. Press each function button on the selected membrane switch, starting with the timer key at the left. Each button must be pressed in sequential order, starting at the left on the front display and continuing to the rear display. After all buttons have been pressed, each LED (Light Emitting Diode) display should illuminate sequentially (**Fig. 15**).

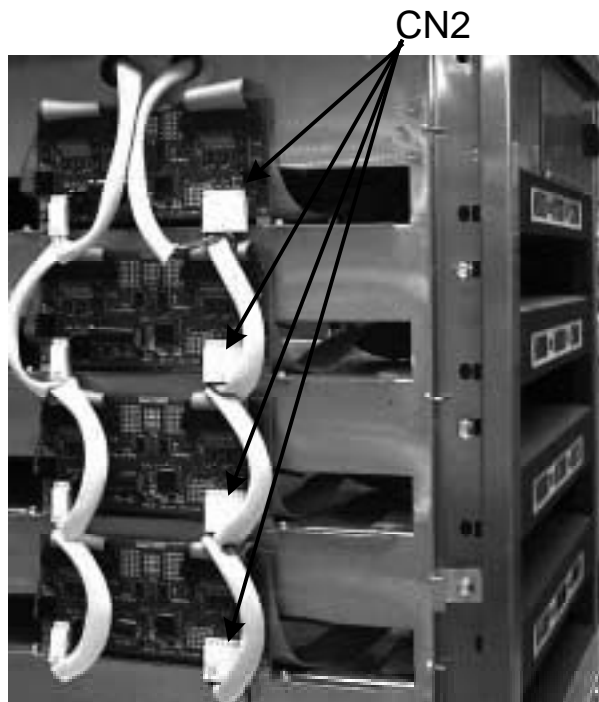

Fig. 14. CN2 connectors are disconnected from the driver board to test new displays.

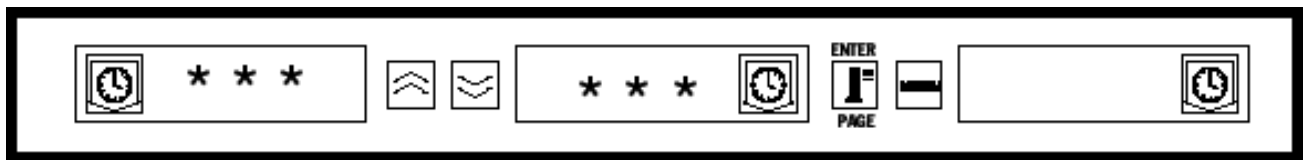

Fig: 15: In the test mode, asterisk-like symbols will illuminate in the displays, appearing to march from display to display from left to right. In units with rear displays, this light motion is repeated on the rear displays.

Note: The rear display is differentiated from the front by the absence of UP/DOWN arrows and a MENU switch.

18. If the display fails to perform in this manner, check connection between ribbon cable and display driver, ribbon cable and display assembly and non-terminated ribbon cable and membrane switch.
19. Turn off power. Reconnect CN2 connector. Install sides and return unit to operation.

15.3 Removing a Slot

1. Perform steps in Section 15-1, Steps 1-7. Disconnect heater and control wiring to the slot being removed (**Fig. 16**).
2. Using a 7/16" nut driver, loosen the four ¼ - 20 hex-head mounting screws from each corner of the slot to be removed. Loosen one full turn, but do not remove.
3. Remove wire wraps from wiring harness holding heater and control wires for affected slot.
4. Lifting slightly, carefully slide the malfunctioning slot out of the cabinet. Do not allow the slot to contact and damage the controls of the unit below.
5. Perform Section 15-1, Steps 9 – 11.



Fig. 16. Disconnect heater and control wiring from component shelf.



Fig. 17. Slide malfunctioning slot from cabinet.

15.4 Replace Heater Plate

1. Perform Section 15-2, Steps 1–7.
2. Run your fingers around the outside surface of the slot assembly. There will be four raised areas. These are the setscrews that hold the heater plate to the spacer. Punch 4 holes in the insulation, directly above the location of the setscrews (**Fig. 18**).
3. Use a 5/64" Allen wrench to loosen the four spacer-setscrews along the edges of the plate (**Fig. 19**).



Fig. 18. Locate setscrews under heater plate covering.



Fig. 19. Puncture foil with Allen wrench to loosen slot.

4. Slide the malfunctioning plate out of the spacer (**Fig. 20**).
5. Slide the replacement plate into position. Make sure the plate is inserted squarely.



Fig. 20. Slide the loosened heater plate from the spacer.



CAUTION

Ensure the heater plate setscrews are tightened securely to the spacer. Tightening the setscrews will ensure the plate is properly grounded.

6. Perform Section 15.2, Steps 9–11.

16 Parts Lists, Exploded Views

16.1 Universal Holding Cabinet Illustrated Parts Breakdown

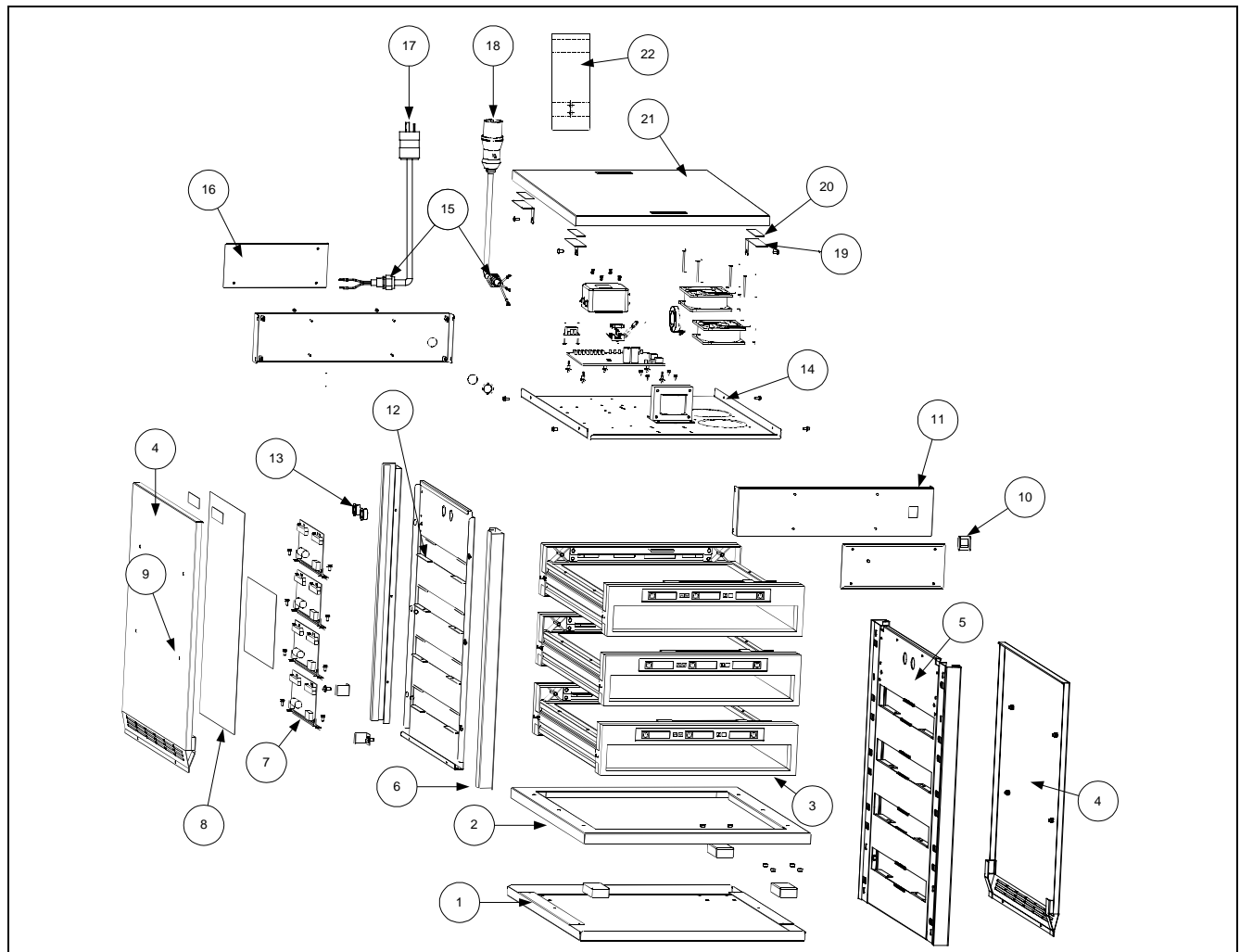

Item	Part Number	Qty/Slot	Description
1	806-8162SP	1	Bottom Pan Assembly
2	806-7904	1	Pan Base
3	See Page 16-2	4	Slot Assembly
4	910-4876SP	2	Cabinet Side, 4-slot unit (Right and Left)
Not Shown	106-0266	2	Cabinet Side, 2-slot unit (Right and Left)
5	900-4880SP	2	Inner Panel, 4-slot unit
Not Shown	900-9453	1	Inner Panel, 2-slot unit
6	910-4875	4	Vertical Support, 4-slot unit
Not Shown	910-9451	4	Vertical support, 2-slot unit

16.1 Universal Holding Cabinet Illustrated Parts Breakdown (cont.)

Item	Part Number	Qty/Slot	Description
7	807-2444E	4	Display Driver
8	816-0267	1	Driver Board Cover, 4-slot unit
Not Shown	816-0506	1	Driver Board Cover, 2-slot unit
Not Shown	807-2448	1	Driver Board AC/Data Harness, 4-slot unit
Not Shown	807-3413	1	Driver Board AC Harness, 2-slot unit
Not Shown	807-3414	1	Driver Board Data Harness, 2-slot unit
9	806-0618	8	Button Hanger
Not Shown	806-0256	8	Button Hanger Nut
10	807-3308	1	ON/OFF Switch
11	806-8654 SP	1	Front Fascia
12	900-4946	2	Slide Bracket
13	816-0265	4	Bushing .75 ID Snap-in
14	See next page	1	Shelf Assembly
15	807-3238	1	Power Cord Strain Relief
16	823-2375	1	Rear Fascia
17	807-2473	1	Pin & Sleeve Power Cord, 12 ½ Feet
18	807-2474	1	Twist Lock Power Cord, 12 ½ Feet
19	902-4882	2	Right Bracket
19	902-4882	2	Left Bracket
20	816-0262	4	VHB Tape, 3.75 x 1"
21	806-7906	1	Top Cap Assembly
22	210-0047	1	Cord Support Bracket
Not Shown	900-5217	1	Air Flow Closure
Not Shown	900-5218	1	Full Baffle
Not Shown	901-5219	1	Left Baffle
Not Shown	902-5219	1	Right Baffle
Not Shown	826-1288	4	Leg Kit
Not Shown	809-0428	16	Leg Plate Mounting Screws

16.2 Domestic Component Shelf

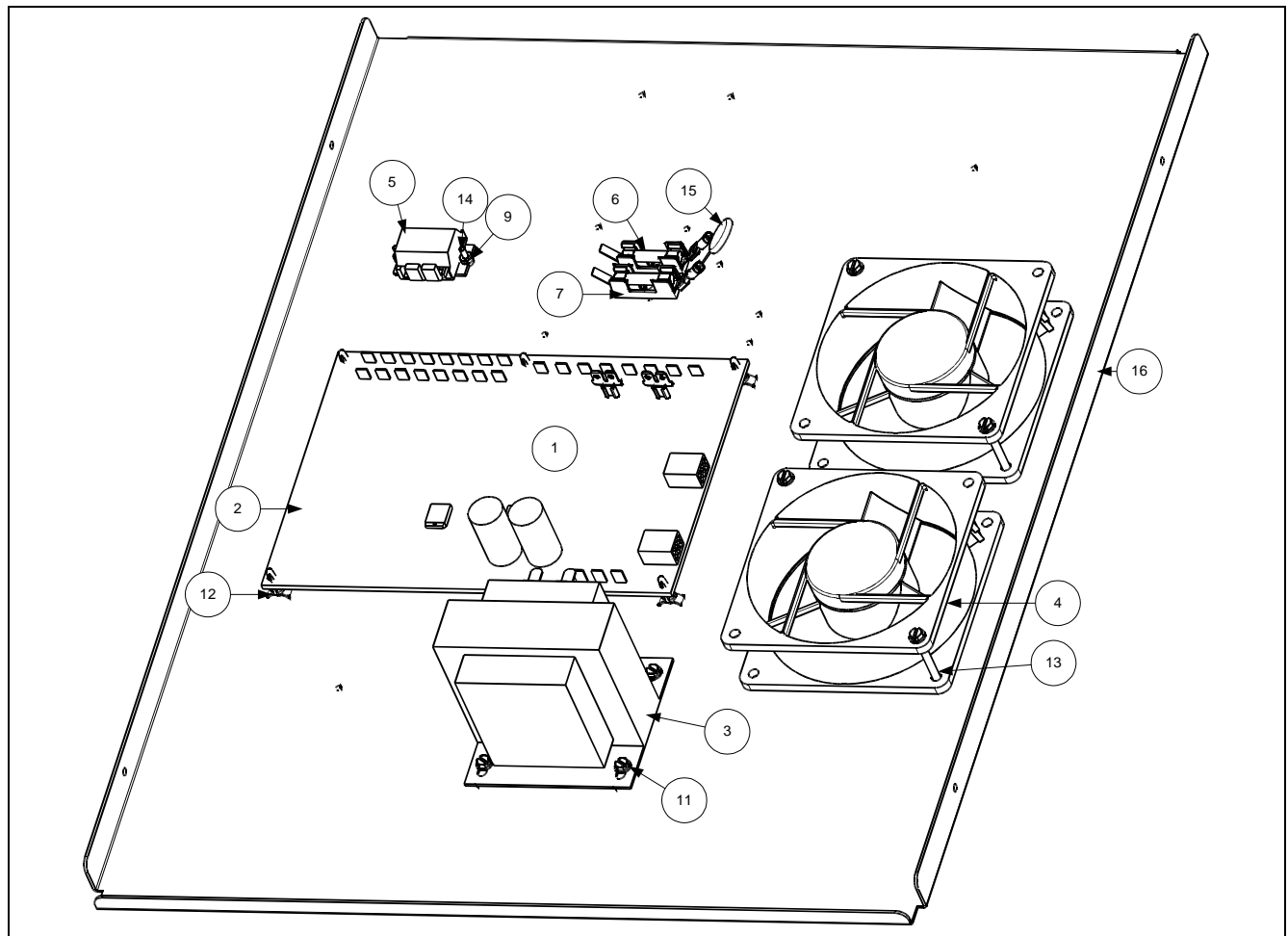

Item	Part Number	Quantity	Description
1	807-0263	2	Connector, terminal
2	807-2443	1	Motherboard
Not Shown	826-1529	1	Alarm Buzzer Kit
3	807-2460	1	Transformer
4	807-2665	2	Exhaust blower
5	807-2812	1	Terminal block
6	807-2819	2	Fuse, 20 amp
7	807-2820	1	Fuse block
8	809-0094	2	Screw, 6-32 x 3/8
9	826-1366	2	Nut, hex keps
10	809-0250	1	#6-32
11	809-0360	4	Screw, #8 x 3/4
12	809-0580	5	Stand-off, Circuit Board
13	809-0607	4	Screw, #8 x 2
14	809-0675	2	Screw, 4-40 x 1/2
15	812-1306	1	Metal oxide varistor
16	900-5511	1	Equipment shelf

16.3 CE Components

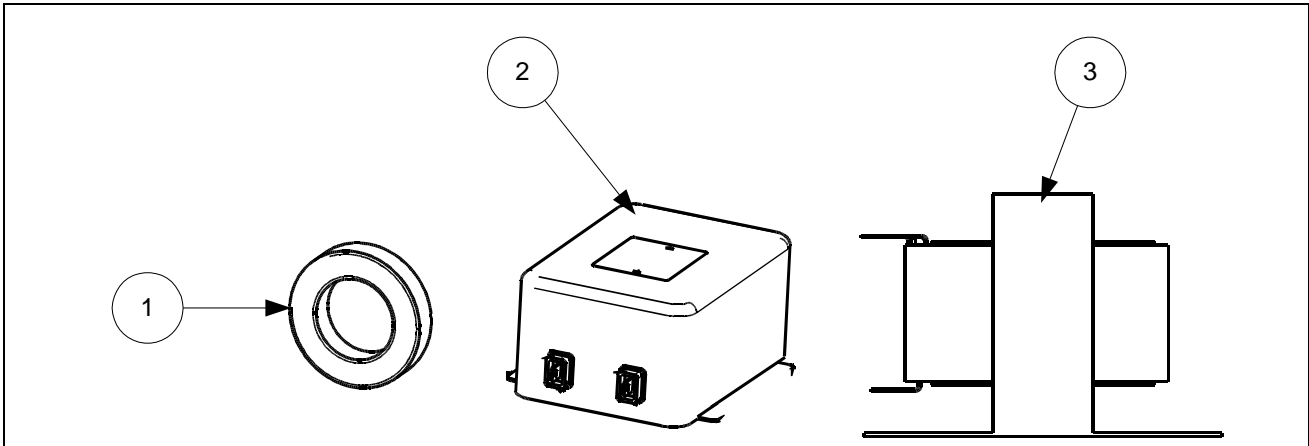

Item	Part number	Quantity	Description
1	807-2767	1	Bead Shield, CE only
2	807-2766	1	Power Line Filter, CE only
3	807-2769	1	Power Transformer, CE only

16.4 Pre-1997 Components

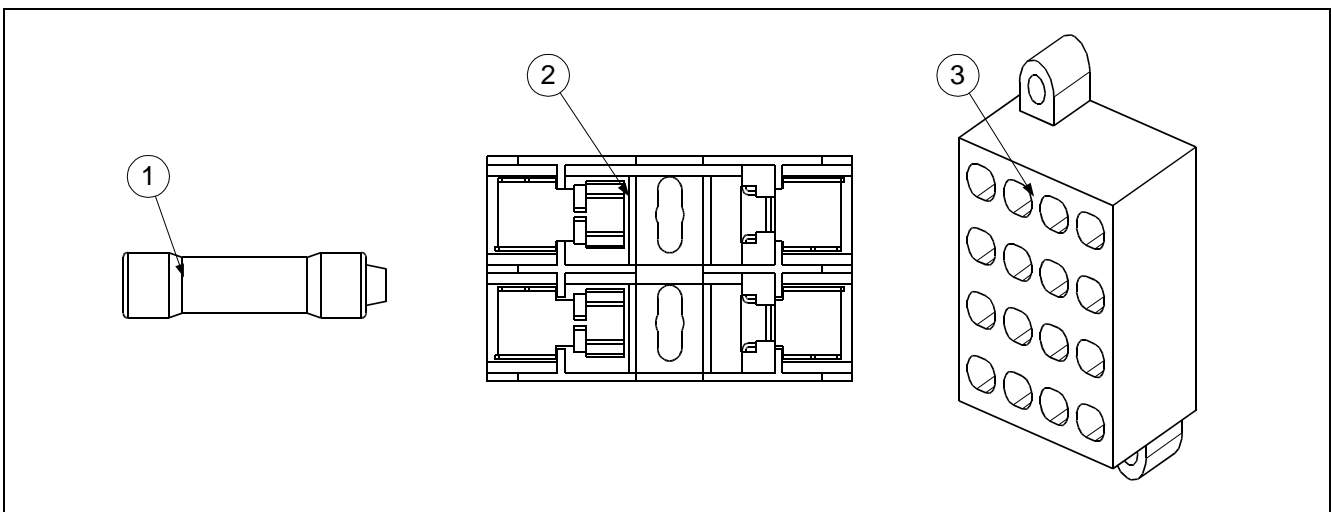

Item	Part number	Quantity	Description
1	807-2278	2	20-Amp Fuse
2	807-2447	1	Fuse Holder
3	807-2462	2	Terminal Block

16.5 Slot Assembly

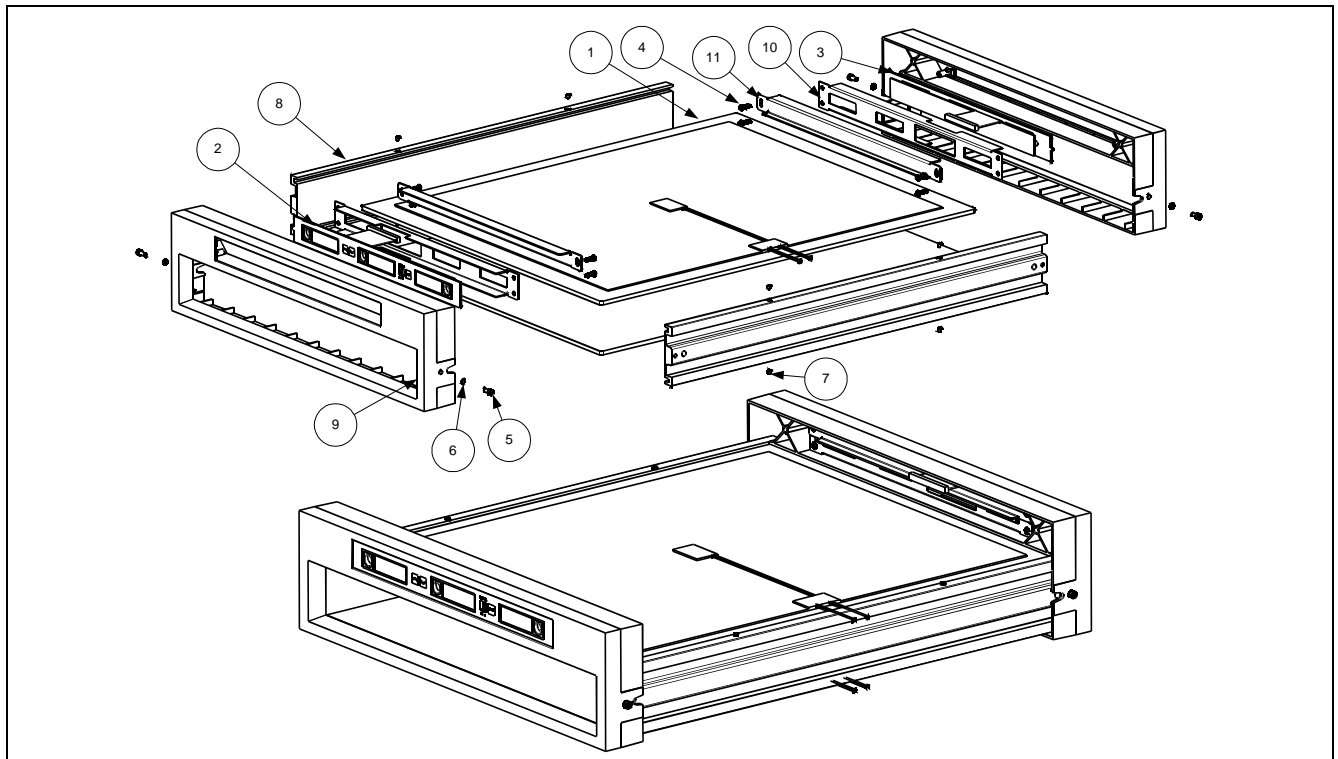

Item	Part Number	Qty/Slot	Description
1	807-2880	2	Heater Plate (includes RTD)
1	807-2906	2	Heater Plate CSA
2	807-3309	1	Display Assembly., Front Slot (All, including pre- S/N 9703)
Not Shown	807-3311	1	Membrane Switch, Front Display (Not for pre- S/N 9703)
3	807-3310	1	Display Assembly., Rear Slot (All, including pre- S/N 9703)
Not Shown	807-3312	1	Membrane Switch, Rear Display (Not for pre- S/N 9703)
4	809-0593	8	Screw, set #6 x 1/2
5	809-0609	8	Screw, set #8 x 3/8 Phillips
6	809-0610	4	Washer, #8
7	809-0612	8	Screw, #8-32 x 3/16
8	810-1286	2	Spacer
9	816-0239	2	Slot Bezel
10	900-5109	2	Display bracket
11	900-5234	2	Bezel support bracket
Not Shown	812-1455	1	Filler, SPOD Bezel
Not Shown	816-0243	1	Insulation

17 Wiring Diagram, UHC

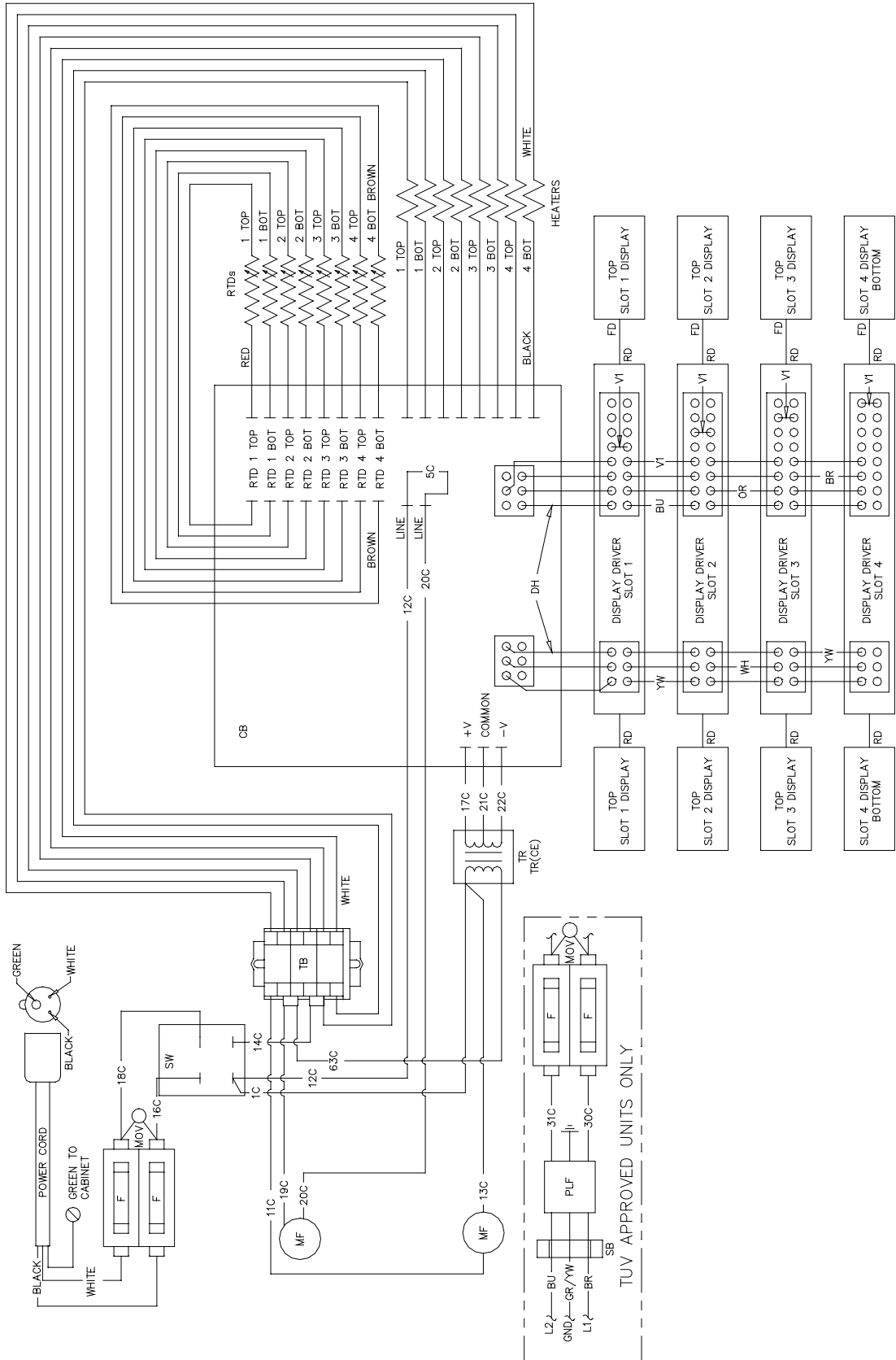

18 Appendices

Appendix A: Food Item Default Settings

Food Item	Display Name	Meal Selection	Temperature Setpoint	Time (Min)
Sausage	SAUS	BFST	185°F (85°C) top plate 185°F (85°C) bottom plate	60
Round Eggs	ROUN	BFST	175°F (79°C) top plate 175°F (79°C) bottom plate	20
Folded Eggs	FOLD	BFST	175°F (79°C) top plate 175°F (79°C) bottom plate	20
Scrambled Eggs	SCRA	BFST	175°F (79°C) top plate 175°F (79°C) bottom plate	20
Canadian Bacon	CBAC	BFST	175°F (79°C) top plate 175°F (79°C) bottom plate	30
English Muffins	MUFF	BFST	175°F (79°C) top plate 175°F (79°C) bottom plate	20
Biscuits	BISC	BFST	175°F (79°C) top plate 175°F (79°C) bottom plate	60
Burritos	BURR	BFST	185°F (85°C) top plate 185°F (85°C) bottom plate	30
Regular Patties	10-1	LNCH	200°F (93°C) top plate 200°F (93°C) bottom plate	20
Quarter Pound Patties and Big Xtra! Patties	4-1	LNCH	200°F (93°C) top plate 200°F (93°C) bottom plate	20
Grilled Chicken	NUGG	LNCH	200°F (93°C) top plate 200°F (93°C) bottom plate	60
Fish	FISH	LNCH	200°F (93°C) top plate 200°F (93°C) bottom plate	30
McChicken Patties	McCK	LNCH	200°F (93°C) top plate 200°F (93°C) bottom plate	30

Appendix B: Cleaning and Preventive Maintenance

After Each Use – Clean Trays/Racks

1. Remove all plastic and wire trays. Take trays/racks to the sink for cleaning.
2. Clean trays by washing in a hot *McD All-Purpose Super Concentrate (APSC) (HCS)* solution drawn through the sink proportioner or mix 0.3 fl. *McD APSC (HCS)* for each gallon of solution. Rinse trays/racks thoroughly under hot water.
3. Sanitize trays/racks by dipping in *McD Sink Sanitizer (HCS)* solution, (one pack per 10 gallons of water) or *McD Sanitizer (HCS)* solution (four packs per 10 gallons of water), for at least 1 minute. Remove from sanitizer solution and allow to air dry.

Daily – Clean Cabinet

1. At the end of the operating day, turn unit to Clean Mode (see Clean Mode, Section 7.2 on Pages 7-2 — 7-3).

Note: Do not use *McD Sink Sanitizer (HCS)* to clean the exterior of the Universal Holding Cabinet.

2. Let the unit cool until SAFE to CLN is displayed. Use brush to remove any remaining buildup on the slot surface by pushing the particles out the opposite end of the cabinet.

Note: Use only the cabinet cleaning brush to clean the cabinet slots. Wire brushes, abrasive pads, or metal scrapers will permanently damage the surface of the cabinet slot.

Note: Do Not use any other cleaner than *McD (APSC)(HCS)*. Using other compounds may result in damage to control components.

3. With the cabinet cleaning brush push all loose particles out the opposite end of the cabinet.
4. Use a wet, clean/sanitized towel and the cabinet cleaning brush to clean each slot. Clean the bottom and top surface of each slot.
5. Wipe clean all exterior cabinet surfaces with a clean, sanitized towel that has been soaked in *McD ASPC (HCS)*.
6. Turn the unit off.

Weekly – Cabinet Slots

Calibrate the top and bottom plates in all four UHC slots by performing the following procedure with the slots clean, empty and at operating temperature for at least 30 minutes.

1. Press the temperature key (See Displaying Slot Temperature Information on Page 8-1) to ensure the setpoint temperature was reached consistently for the 30-minute minimum.
2. Slide the Atkins sensor into a slot with the sensor facing upward to measure the top heater plate or downward to measure the bottom heater plate. Move the sensor to the center of the plate. To get an accurate reading, the sensor must be within ± 1 inch of the center of the plate.
3. Allow three minutes for the sensor to stabilize.
4. Read the temperature on the pyrometer. The temperature on the pyrometer should be within $\pm 5^{\circ}\text{F}$ ($\pm 3^{\circ}\text{C}$) of the temperature read in the UHC. Press the temperature key once to get the slot top plate within tolerance $\pm 5^{\circ}\text{F}$ ($\pm 3^{\circ}\text{C}$), check the next plate/slot. If the reading is out of tolerance, perform the following procedure:
 - Enter the program mode by pressing the Menu key for at least five seconds. Press the page key until View_____PAGE appears in the slot controller display.
 - Press the Menu key until SECR Lock _ _ _ _ is displayed. Enter the Service Code, **2 4 7** using the UP and Down arrow keys.
 - Press the Page key to display the slot to be corrected. (For slot 1, the display will read SLOT____1.)
 - Press the Menu key until you get to the top or bottom plate for correction. (For a top plate the display should read TOP OFST O).
 - Press the Up or Down arrow key to enter $1^{\circ}\text{F}/\text{C}$ at a time until the correct offset is achieved. Example: If the RTD measures 150°F (65°C) and you measure 155°F (68°C), enter $+5^{\circ}\text{F}$ ($+3^{\circ}\text{C}$) to achieve the offset. If you measure 145°F (63°C) and the RTD measures 150°F (66°C), enter -5°F (-3°C) to achieve the offset.

Annually – Clean Air Exhaust Fans

CAUTION

Failure to disconnect the power at the wall power supply could result in serious injury or death. The cabinet power switch DOES NOT disconnect all incoming power to the cabinet. This service should only be performed by qualified service personnel.

CAUTION

Use caution when handling the cabinet. Each cabinet weighs over 200 pounds. Maneuvering/handling the unit should only be attempted with at least two people.

Annually – Clean Air Exhaust Fans (cont.)

1. At the end of the operating day, place the unit in the CLEAN MODE (see Clean Mode, Pages 7-2— 7-3).
2. Perform all daily maintenance requirements.
3. Disconnect power at the power source before beginning yearly maintenance. See caution above.
4. With a Phillips screwdriver, remove the two screws in each side panel. Set the screws aside.
5. Remove the side panels from the unit.
6. Gain access to the air exhaust fans as follows:
 - a. If the cabinet is a single stand-alone unit or the top unit of a stacked arrangement, use a 5/16” socket driver to remove the four screws holding the cabinet top in place. Remove the cabinet top. Skip to step 10.
 - b. If the cabinet to be serviced is the bottom unit of a stacked arrangement, use a 5/16” socket driver and remove the four screws holding the equipment shelf in place. The screws are located on each side of the unit, near the top corners of the inner panel.
7. Use a 5/16” nut driver to remove the two #10-32 hex-head screws from each side of the front fascia.
8. Pull the front fascia out. It is not necessary to disconnect the switch wiring.
9. Remove wire and wire harnesses as needed to free the shelf. Mark each wire distinctly for re-assembly. Grab the edge of the shelf and pull straight out until the shelf engages the stops. Place the fascia on top of the shelf.
10. Wipe down the blades of the air exhaust fans with a clean cloth, dampened with *McD ASPC (HCS)*. Take care not to touch any electrical connections with the cloth. This procedure ensures efficient fan operation.
11. Reverse steps to reassemble the unit.

Appendix C: RTD Resistance Chart

Sensor Temp (°F)	R Sensor	Sensor Temp (°C)
55	104.984	12.77
60	106.065	15.55
65	107.145	18.33
70	108.224	21.11
75	109.302	23.88
80	110.380	26.66
85	111.456	29.44
90	112.532	32.22
95	113.606	35.00
100	114.680	37.77
105	115.753	40.55
110	116.825	43.33
115	117.896	46.11
120	118.966	48.88
125	120.036	51.66
130	121.104	54.44
135	122.172	57.22
140	123.239	60.00
145	124.304	62.77
150	125.369	65.55
155	126.433	68.33
160	127.496	71.11
165	128.559	73.88
170	129.620	76.66
175	130.680	79.44
180	131.740	82.22
185	132.799	85.00
190	133.856	87.77
195	134.913	90.55
200	135.969	93.33
205	137.024	96.11
210	138.078	98.88
215	139.132	101.66
220	140.184	104.44
225	141.235	107.22
230	142.286	110.00
235	143.336	112.77
240	144.385	115.55
245	145.433	118.33
250	146.480	121.11
255	147.526	123.88
260	148.570	126.66

Appendix D: S.O.C. for the Universal Holding Cabinet (UHC)

The procedure for the Universal Holding Cabinet when used for **FRIED PRODUCTS** is similar to our current procedure. The only difference is that the fried product is held in a wire rack that goes in a crumb tray and placed in the pre-designated slot in the cabinet. No tray liners are required for these trays.

The procedure for the Universal Holding Cabinet when used for **GRILLED PRODUCTS** is also similar to our current procedure, except for:

- The product should **not** be drained when picked up from the grill.
- Use a tray liner for all grilled products.
- The product is stacked when placed in the proper tray. 10-to-1 and sausage patties can be stacked up to six high. Eggs (except scrambles), grilled chicken and 4-to-1 patties can be stacked up to three high (See Appendix G, Page 18-9).

The procedure for the Universal Holding Cabinet when used for **BISCUITS** is as follows:

- After the biscuits have been removed from the biscuit oven, remove the wrapper and open the cardboard box.
- Put a tray liner in the tray and slide the biscuits onto the liner. The biscuit trays can hold up to 30 frozen biscuits, 20 scratch biscuits or 20 muffins.

Appendix E: Production Charts

Weekend(s)	Regular Menu					
Recommend Tray Size/ Stack	9/3	6/3	8/3	1/1	8/1	8/1
Ultra High Volume	18/6	12/3	15/3	1/1	10/1	14/1
Units	Trays	Trays	# Pieces	Bags	# Pieces	# Pieces
Time period	10:1	4:1	GRCK	NUGG	McCk	Fish

Weekend(s)	Breakfast Menu							
Recommend Tray Size/ Stack	30/1	12/3	6/3	6/1	6/3	15/3	5/1	9/1
Ultra High Volume	30/1	24/6	18/3	6/1	18/3	30/3	20/1	9/1
Units	Trays	Trays	Trays	Trays	Trays	Trays	Trays	Trays
Time period	BISC	SAUS	FOLD	SCRA	ROUN	CBAC	MUFF	BURR

Appendix F: UHC Quick Reference Guide

1. Go To Program Mode



Press and hold the MENU key for at least five seconds.



RESULT: You are in the Program MODE

2. Select the Slot Page



Press the PAGE Key to select the slot.

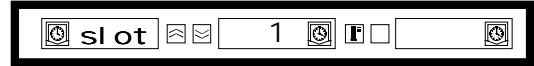

RESULT

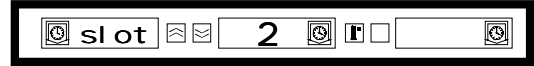

Continue to press the PAGE key to select the next slot.

3. Select the Meal and Tray Position

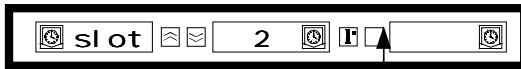

Press the MENU key to select the Meal (Breakfast or Lunch) and tray position.



RESULT



Continue to press the MENU key to select the desired meal.



4. Select the Product



Press the UP and DOWN arrow keys to select the product.



RESULT



5. Go to Next Tray Position

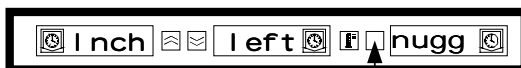

Press the MENU key to go to next Tray position.

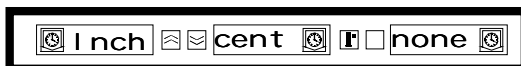

RESULT

6. Exit Program Mode



Press and hold the MENU key for at least five seconds.



RESULT: You have exited the Program Mode.

When NONE is selected, the display will show /// in the normal operating mode.

Note: The product selected for the far left tray position for each slot determines the holding temperature for the entire slot (all three tray positions). If a product cannot be selected for the center or right trays, the holding temperature is incompatible with the left tray temperature. Typically, bread and grilled products are set at 155°F and fried products at 200°F.

Appendix G: UHC Typical Setups/Stacked Arrangements

Breakfast Setup

Default Settings

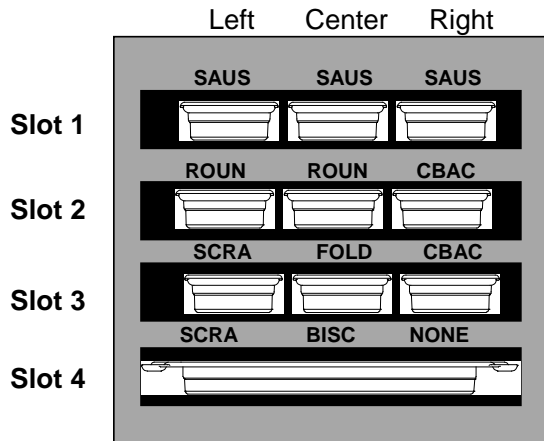

Lunch Setup

Default Settings

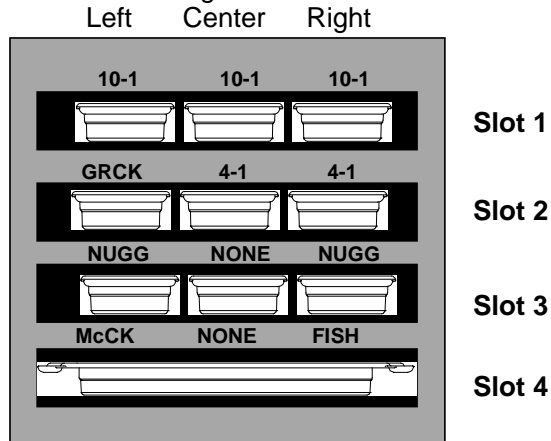

Typical Breakfast Setup

Left Cabinet*

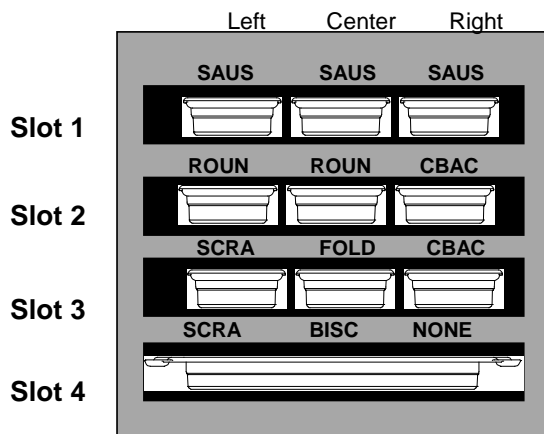

Right Cabinet

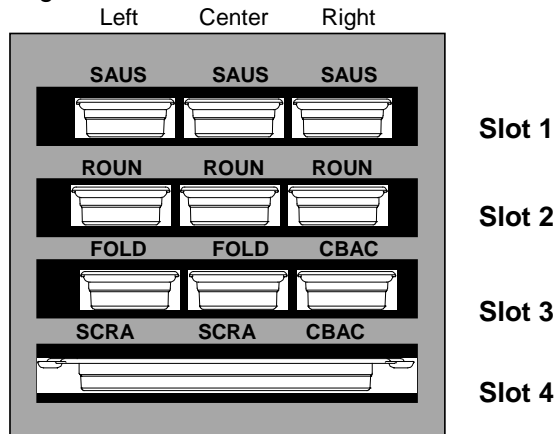

Typical Lunch Setup

Left Cabinet*

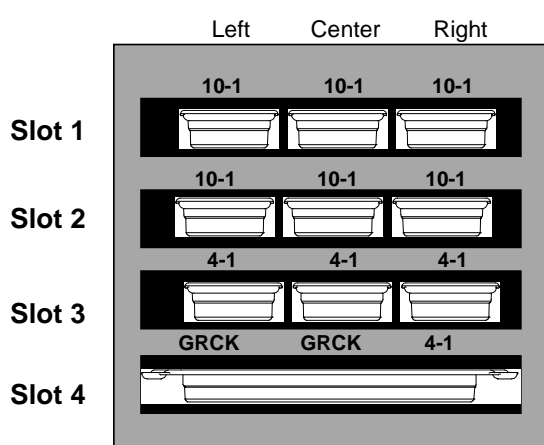

Right Cabinet

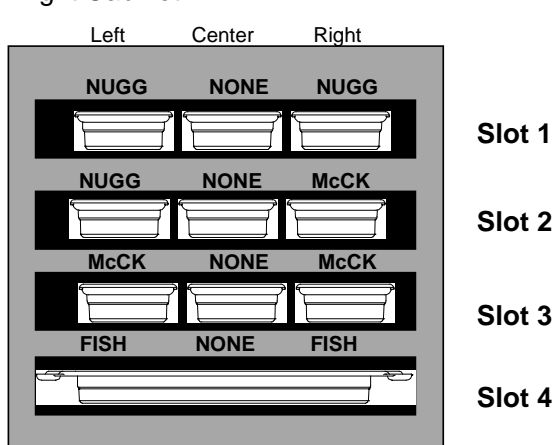

*Note: In this example, Biscuits (BISC) and Muffins (MUFF) occupy all three tray positions in a slot, therefore the middle tray should be set to the produce (BISC or MUFF) and the left and right tray positions should be set to NONE. If a tray position does not have a product, select NONE.

Stacked Arrangements

10-1 Meat Patties

Recommended Stack - Normal Volume 9/3

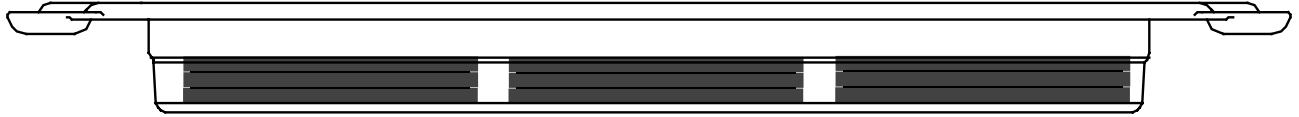

Recommended Stack - Ultra-High Volume 18/6

