



INSTALLATION AND OPERATION MANUAL

**GARLAND 3 PLATEN
GAS & ELECTRIC
CLAMSHELL GRILLS
WITH PRODUCT RECOGNITION**

**MODELS:
MWE3W-1
MWE3S-1
MWG3W-1**



FOR YOUR SAFETY:
DO NOT STORE OR USE GASOLINE OR OTHER
FLAMMABLE VAPORS OR LIQUIDS IN THE
VICINITY OF THIS OR ANY OTHER
APPLIANCE

WARNING:
IMPROPER INSTALLATION, ADJUSTMENT,
ALTERATION, SERVICE OR MAINTENANCE
CAN CAUSE PROPERTY DAMAGE, INJURY, OR
DEATH. READ THE INSTALLATION,
OPERATING AND MAINTENANCE
INSTRUCTIONS THOROUGHLY
BEFORE INSTALLING OR
SERVICING THIS EQUIPMENT

PLEASE READ ALL SECTIONS OF THIS MANUAL AND
RETAIN FOR FUTURE REFERENCE.

THIS PRODUCT HAS BEEN CERTIFIED AS
COMMERCIAL COOKING EQUIPMENT AND MUST
BE INSTALLED BY PROFESSIONAL PERSONNEL AS
SPECIFIED.

INSTALLATION AND ELECTRICAL CONNECTION MUST
COMPLY WITH CURRENT CODES:

IN CANADA - THE CANADIAN ELECTRICAL CODE
PART 1 AND / OR LOCAL CODES.

IN USA – THE NATIONAL ELECTRICAL CODE ANSI /
NFPA – CURRENT EDITION.

ENSURE ELECTRICAL SUPPLY CONFORMS WITH
ELECTRICAL CHARACTERISTICS SHOWN ON THE
RATING PLATE.

For Your Safety:

Post in a prominent location, instructions to be
followed in the event the user smells gas. This
information shall be obtained by consulting your
local gas supplier

MANUFACTURED EXCLUSIVELY FOR McDonald's BY
GARLAND COMMERCIAL RANGES
<http://www.garland-group.com>



IMPORTANT INFORMATION

WARNING:

THIS PRODUCT CONTAINS CHEMICALS KNOWN TO THE STATE OF CALIFORNIA TO CAUSE CANCER AND/OR BIRTH DEFECTS OR OTHER REPRODUCTIVE HARM. INSTALLATION AND SERVICING OF THIS PRODUCT COULD EXPOSE YOU TO AIRBORNE PARTICLES OF GLASS WOOL/CERAMIC FIBERS. INHALATION OF AIRBORNE PARTICLES OF GLASS WOOL/CERAMIC FIBERS IS KNOWN TO THE STATE OF CALIFORNIA TO CAUSE CANCER. OPERATION OF THIS PRODUCT COULD EXPOSE YOU TO CARBON MONOXIDE IF NOT ADJUSTED PROPERLY. INHALATION OF CARBON MONOXIDE IS KNOWN TO THE STATE OF CALIFORNIA TO CAUSE BIRTH DEFECTS OR OTHER REPRODUCTIVE HARM.

KEEP APPLIANCE AREA FREE AND CLEAR OF COMBUSTIBLES.

CONTENTS

IMPORTANT INFORMATION	2	To display the current temperatures:.....	37
INTRODUCTION	4	Breakfast In Manual mode.	37
WARRANTY	4	Lunch In Manual mode.	37
SHIPPING DAMAGE PROCEDURE	4	To Change The Cook Time for a Menu Item.	37
RATING PLATE DESCRIPTION	6	Breakfast In Auto mode	37
MECHANICAL SPECIFICATIONS	7	Lunch In Auto mode	37
Dimension Models: MWE3W-1, MWG3W-1	7	PRODUCT RECOGNITION	38
Dimension Models: MWE3S-1	8	Transition Cooking.....	38
ELECTRICAL INPUT SPECIFICATIONS - DELTA	9	To Shutdown Grill.....	38
ELECTRICAL INPUT SPECIFICATIONS - WYE	11	COMMON PRODUCT RECOGNITION ISSUES	39
INSTALLATION & START UP	13	PATTY PLACEMENT	40
Installation Store Responsibilities:	13	BEEF INTEGRITY	41
A start-up DOES NOT include:	13	PROGRAM LOGIC TREE; PRODUCT MENU	42
A start-up DOES include:	13	CONTROL PROGRAMMING; PRODUCT MENU	43
Items included with the purchase of your new grill from Manufacturer: ..	13	Programming Modes; Product Menu	43
Items NOT included from the manufacturer and should be		To change the name of an existing menu item	43
purchased from the Kitchen Equipment Supplier (KES):	13	To activate / deactivate a menu item in the Normal Operating	
Installation of Casters	14	mode library, or change its day-part	43
Power Supply Connection.....	15	To change the grill surface set point temperature	43
Mennekes 3 & 5 Pins (Option 1).....	16	To change the grill upper platen set point temperature	43
Mennekes 7 Pins (Option 2)	16	To Change the INSTANT ON TIME	44
Terminal Blocks Diagram	16	To Change the REMOVE IN TIME	44
Exhaust hood Type & Platen Height.....	17	To Change the MULTI STAGE TIME	44
Setting the Proper Combustion Levels.....	18	To Change the REMOVE ALARM	44
Start-up Procedure	19	To Change the GAP SETTING	44
Grill StartUp Sample	20	To Change the GAP MUL/PR START	45
TEMPERATURE PROBE CALIBRATION	21	To Change the GAP MULTI STAGE (1,2 or3)	45
INSTALLATION OF WRAP AROUND RELEASE MATERIAL		To Change the MUST REMOVE IN	45
MOUNTING BRACKETS	25	To Change the TOAST BUNS TIME.....	45
INSTALLATION OF SPLASH SHIELD	25	To Change the TOAST BUNS ALARM (Auto / Manual)	45
INSTALLATION OF RELEASE MATERIAL	26	To Change the TOO COOL FLAG	46
INSTALLATION OF VAPOR SHIELD	27	To Change the FLIP TIME	46
GRILL ACCESSORIES	27	To Change the FLIP ALARM.....	46
Splash Shield	27	To Change the SEAR TIME	46
Teflon Wraparound Kits	27	To Change the SEAR ALARM.....	47
Vapor Shield.....	27	To Add NEW Menu Items.....	47
3Phase 4-Wire (50 & 30 Amps) Cord.....	28	To activate Clean Mode	47
Teflon Sheet, Rod & Clip.....	29	PROGRAM LOGIC TREE; SYSTEM MENU	48
CLEANING & MAINTENANCE	30	Programming Modes; System Setup	49
PULL / PUSH GRILL PROCEDURE	33	To Change the Time Display Units	49
DESCRIPTION OF GRILL CONTROL	34	To change the Programming Standby Alarm	49
ERROR MESSAGING	35	CONTROL PROGRAMMING; SYSTEM MENU	49
OPERATION PROCEDURES	35	To change the Key Chirp (Yes / No)	50
General Overview:	35	To change the Audible	50
To turn the grill on:	36	To Restore Factory Defaults for All Product Menu Items.	50
To Select a Menu item:	36	FACTORY DEFAULT SETTING	51
Menu Item Library	36	Factory Default Setting - Product Menu - World	51
Indicator Lights	36	Factory Default Setting - Product Menu - Canada, Australia & UK	52
To enter the standby mode:	36	Factory Default Setting - Product Menu - Japan & Hong Kong	53
To Exit the standby Mode:.....	36	DECLARATION OF CONFORMITY (CE Marked Models) ..	54
		INSTALLATION OPERATION MANUAL HISTORY	54
		INDEX	55

INTRODUCTION

The Garland clamshell grill, manufactured exclusively for McDonald's, provides a method for efficient two-sided cooking, while accommodating a variety of products. The unit will also serve as a flat grill, and meets all of McDonald's standards for safety, efficiency, and cleanliness.

WARRANTY

This warranty covers defects in material and workmanship under normal use providing that:

- a. the equipment has not been accidentally or intentionally damaged, altered or misused.
- b. the equipment is properly installed, adjusted, operated and maintained in accordance with national and local codes and in accordance with the installation instructions provided with this product.
- c. the warranty serial number affixed to the appliance by us has not been defaced, obliterated or removed.
- d. an acceptable report for any claim under this warranty is supplied to us.

The equipment warranty coverage remains in force for two (2) years, (parts and labor), from the date the equipment is put into operation.

The Garland Group agrees to repair or replace, at it's option, any part that proves to be defective in material or workmanship at no charge for the part or normal labor.

We assume no responsibility for installation, adjustments, diagnosis, or normal maintenance such as: lubrication of springs or valves. We exclude failures caused by erratic voltage or gas supplies.

We assume no responsibility for travel costs beyond 100 miles round trip, travel other than overland, and overtime costs of repair.

We exclude broken glass, paint and porcelain finish, surface rust, gasket material, ceramic material, light bulbs and fuses from normal coverage.

We exclude damage or dysfunction caused by fire, flood, and like "Acts of God" that are beyond the control of The Garland Group.

The Garland Group's liability on a claim of warranty shall not exceed the price of the material and/or service, which caused the claim.

This warranty is limited and is in lieu of all other warranties, expressed or implied. The Garland Group, our employees, or our agents shall not be held liable for any claims of personal injury or consequential damage or loss.

This warranty gives you specific legal rights, and you may have other rights which vary from state to state.

SHIPPING DAMAGE PROCEDURE

Please note that the Garland equipment was carefully inspected and packed by skilled personnel before leaving the factory. The transportation company assumes full responsibility for safe delivery upon acceptance of the equipment. What to do if the equipment arrives damaged:

1. File a claim immediately regardless of the extent of damage.
2. Be sure to note, "visible loss or damage," on the freight bill or express receipt and have the person making the delivery sign it.
3. Concealed loss or damage: if damage is unnoticed until the equipment is unpacked, notify the freight company immediately, (within 15 days), and file a concealed damage claim.

SAFETY

- **DISCONNECT ALL POWER SUPPLIES BEFORE OPENING PANELS FOR SERVICING.**
- **KEEP THE APPLIANCE AREA FREE AND CLEAR FROM COMBUSTIBLES.**
- **DO NOT OBSTRUCT THE FLOW OF COMBUSTION AND VENTILATION AIR.**
- **ALLOW A MINIMUM OF 24 INCHES UNOBSTRUCTED CLEARANCE IN FRONT OF THE UNIT FOR SERVICING**

This appliance is for professional use and shall be used only by qualified personnel.

WARNING: Accessible parts may become hot during use. Young children should be kept away. This appliance is not intended for use by persons (including children) with reduced physical, sensory or mental capabilities, or lack of experience and knowledge, unless they have been given supervision or instruction concerning use of the appliance by a person responsible for their safety."

CAUTION: THIS EQUIPMENT MUST ONLY BE OPERATED UNDER AN APPROVED HOOD SYSTEM IN ACCORDANCE WITH LOCAL REGULATIONS IN FORCE.

DO NOT OPERATE THE GRILL UNLESS IT HAS BEEN COMMISSIONED (START-UP) BY A FACTORY AUTHORIZED SERVICE CENTER.

DO NOT operate the grill without reading this operation manual.

DO NOT operate the clamshell grill unless it has been properly installed and grounded.

DO NOT operate the clamshell grill unless all service and access panels are in place and fastened properly.

Means of disconnection, must be incorporated in the fixed wiring in accordance with local wiring rules (such as a switch, fuse, or circuit breaker). External equipotential bonding conductor provided on rear of appliance. Use as applicable, in accordance with local wiring rules.

The Garland clamshell grill is a semi-automatic cooking appliance. The upper platen is lowered automatically, following the manual, single-handed or two handed based on the model, initiation of the cooking cycle, and raised automatically upon completion of the cooking cycle.

WARNING:

When two sided cooking, the area between the upper platen and the griddle plate and the area between upper platen and ventilation hood should be regarded as a "**DANGER ZONE**". During two sided cooking the operator must keep body parts and tools clear of the danger zone when platens are in motion. When used as a flat grill, unexpected movement of platens can occur during cleaning or servicing. For whatever reason, be it cleaning, maintenance or normal operation, any exposed person must use extreme caution if within this danger zone. Temperatures on solid cooking surfaces are intended to operate above 120C (250F).

In two sided cooking the upper platen remains in the lowered position by nature of its own weight. It is not locked down. It can be raised by lifting of the handle on the front of the platen, which pivots the platen about its rear mounting point.

The clamshell grill must only be used for single and two sided cooking of foodstuffs in a McDonald's store.

SOUND EMISSIONS: Sound pressure levels at the grill operator's position may exceed 70 dB(A) when audible alarms are active. Audible volume may be adjusted to below 70 dB(A). See Control Programming Section.

WARNING: To avoid serious personal injury: **DO NOT** attempt to repair or replace any part of the clamshell grill unless all main power supplies to the grill have been disconnected.

SAFETY

USE EXTREME CAUTION in setting up, operating and cleaning the clamshell grill to avoid coming in contact with hot grill surfaces or hot grease. Suitable protective clothing should be worn to prevent the risk of burns.

WARNING: This appliance must not be cleaned with a water jet. **DO NOT** apply ice to a HOT grill surface.

NOTE: All warning labels and markings on the grill, which call attention to further dangers and necessary precautions.

HAZARD COMMUNICATION STANDARD, (HCS) - The procedures in this manual include the use of chemical products. These chemical products will be printed in bold face, followed by the abbreviation **(HCS)** in the text portion of the procedure. See the Hazard Communication Standard, (HCS) manual for the appropriate Material Safety Data Sheet(s), (MSDS).

WARNING: After turning the master power switch to the START position, the grill will go through an initialization process. If the upper platens are in the lowered position they will return to their raised upper position.

MAINTENANCE - the platen support arms carriage block bearing bushings, the platen adjuster nuts, the platen support (shoulder) bolt and the cam follower should be checked annually for wear. Should there be any noticeable play in the bearing bushings and any visible wear on the platen adjuster nuts, platen support bolts or cam follower, then they must be replaced.

MAINTENANCE - the audible alarm that sounds at the end of a cook cycle is to advise the operator that the platen is about to move. The function of this device may be tested by pushing the left hand CANCEL button. If no sound is heard, ensure that the alarm volume is not set too low in SYSTEM SETUP. If there is still no sound then a service engineer should be called out to rectify the fault.

SERVICE AND CLEANING - The grill may be secured in the grill bay by the installer using two anchors that lock onto the front casters. If the grill is to be moved out of the bay for cleaning or service, remove the anchor from each caster by turning the knob counterclockwise to loosen the retainer. When the retainer is free of the caster, lay the assembly aside on the floor.

CLEANING - **NEVER** clean the grill, interior or exterior, using a high-pressure sprayer, water jet, vapor steam cleaner or any other liquid sprayer. **NEVER** use ice to cool the grill for cleaning. **USE ONLY** approved cleaners by McDonald's.

NOTE: If anchors are present, the anchor assembly remains fastened to the back wall of the grill bay. After service or cleaning is complete, return the grill to its position in the bay and reattach the anchors by placing the retainer on the caster post and turning the knob clockwise to tighten. For safety reasons, the grill must be secured in the grill bay in this manner before operation can resume.

WARNING:
Pinch Hazard keep hands and tools clear when platens are in motion. Unexpected movement of platens can occur during cleaning or servicing process. **Turn Grill Off** at main switch when cleaning platen.

RATING PLATE DESCRIPTION

Last 2 digits of the year	Month of the year	Factory Code	Product Build Number in sequence and reset monthly
YY	MM	ZZZ	1 2 3 4 5

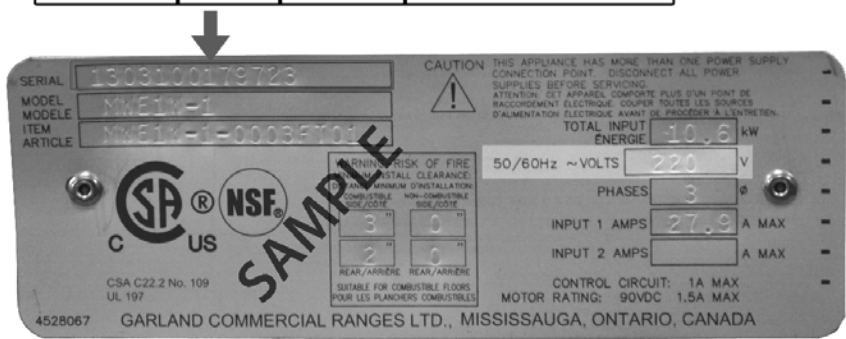

MECHANICAL SPECIFICATIONS

Dimensions:
Models MWE3S-1

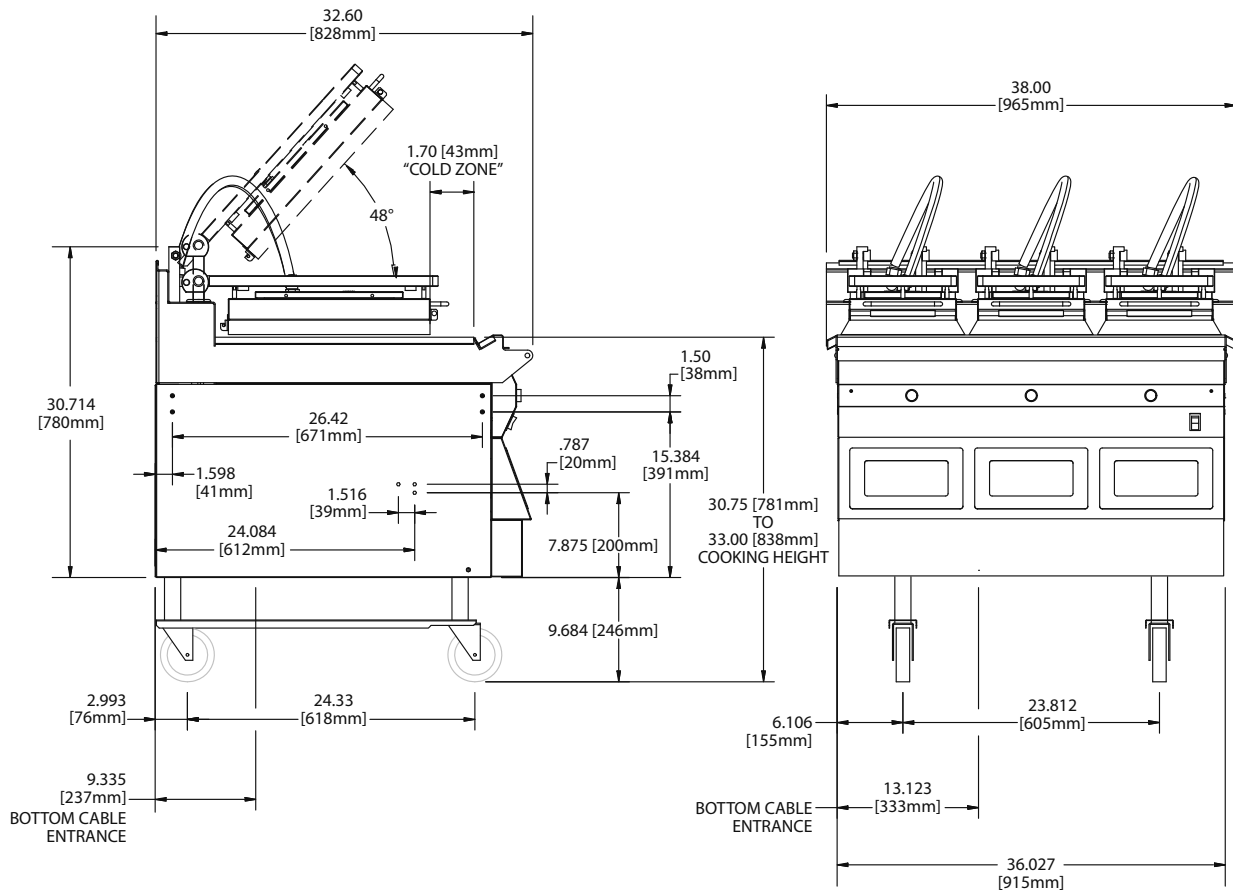
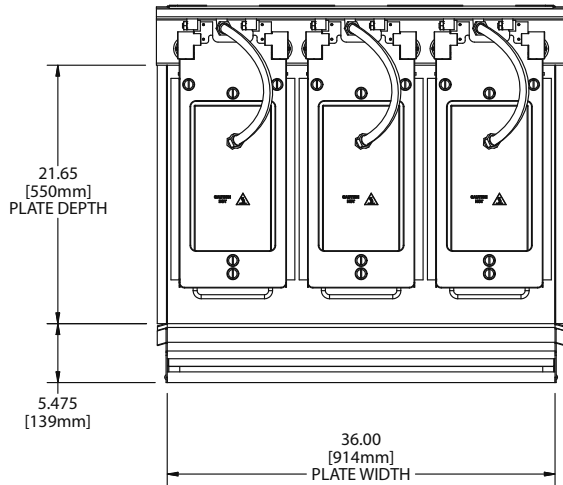

ELECTRICAL INPUT SPECIFICATIONS - DELTA

DELTA - 200 Volts Models													
Model		Drawing		Control	MCB	Total loads Kw				Amps/line			
				I/E	L1-L3	L1-L2	L2-L3	L3-L1	All	Ctrl	L1	L2	L3
3 Platen	Electric	4530440	TB1		600	2.3	2.7	2.9	7.9		21.7	22.6	24.3
			TB2	78					0.1	0.7			
			TB3			4.2	5.4	4.6	14.6		43.4	39.9	43.4
	Gas	4530442	TB1		600	3.0	3.0	3.6	9.6		26.0	28.7	28.7
			TB2	380		0.4			0.5	3.3			

DELTA - 208 Volts Models													
Model		Drawing		Control	MCB	Total loads Kw				Amps/line			
				I/E	L1-L3	L1-L2	L2-L3	L3-L1	All	Ctrl	L1	L2	L3
3 Platen	Electric	4530440	TB1		600	2.4	2.8	3.0	8.2		21.5	22.4	24.0
			TB2	78					0.1	0.6			
			TB3			4.8	5.6	4.8	15.1		43.1	39.7	43.1
	Gas	4530442	TB1		600	3.3	3.3	3.9	10.4		27.1	29.6	29.6
			TB2	380					0.4	3.2			

DELTA - 220 Volts Models													
Model		Drawing		Control	MCB	Total loads Kw				Amps/line			
				I/E	L1-L3	L1-L2	L2-L3	L3-L1	All	Ctrl	L1	L2	L3
3 Platen	Electric	4530440	TB1		600	2.4	2.8	3.0	8.2		20.4	21.2	22.7
			TB2	78					0.1	0.6			
			TB3			4.8	5.6	4.8	15.1		40.7	37.5	40.7
	Gas	4530442	TB1		600	3.3	3.3	3.9	10.4		25.6	28.0	28.0
			TB2	380					0.4	3.0			

ELECTRICAL INPUT SPECIFICATIONS - DELTA

DELTA - 230 Volts Models													
Model		Drawing		Control	MCB	Total loads Kw				Amps/line			
				I/E	L1-L3	L1-L2	L2-L3	L3-L1	All	Ctrl	L1	L2	L3
3 Platen	Electric	4530440	TB1		600	2.4	2.8	3.0	8.2		19.5	20.2	21.7
			TB2	78				0.1	0.6				
			TB3			4.8	5.6	4.8	15.1		38.9	35.9	38.9
	Gas	4530442	TB1		600	3.3	3.3	3.9	10.4		24.5	26.8	26.8
			TB2	380				0.4	2.9				

DELTA - 240 Volts Models													
Model		Drawing		Control	MCB	Total loads Kw				Amps/line			
				I/E	L1-L3	L1-L2	L2-L3	L3-L1	All	Ctrl	L1	L2	L3
3 Platen	Electric	4530440	TB1		600	2.4	2.8	3.0	8.2		18.7	19.4	20.8
			TB2	78				0.1	0.6				
			TB3			4.8	5.6	4.8	15.1		37.3	34.4	37.3
	Gas	4530442	TB1		600	3.3	3.3	3.9	10.4		23.5	25.7	25.7
			TB2	380				0.4	2.7				

ELECTRICAL INPUT SPECIFICATIONS - WYE

WYE - 380 Volts Models													
Model		Drawing		Con- trol	MCB	Total loads Kw				Amps/line			
				I/E	L1-L3	L1-L2	L2-L3	L3-L1	All	Ctrl	L1	L2	L3
3 Platen	Electric STD	4530442	TB1		600	7.8	8.4	7.2	23.3		35.3	38.1	32.6
			TB2	78					0.1	0.4			
	Electric H.K.	4530440	TB1		600	3.0	2.8	2.4	8.2		13.6	12.7	10.9
			TB2	78					0.1	0.4			
			TB3			4.8	5.6	4.8	15.1		21.7	25.4	21.7
	Gas	4530442	TB1		600	3.9	3.3	3.3	10.4		17.5	14.8	14.8
TB2			380.4					0.4	1.7				

WYE - 400 Volts Models													
Model		Drawing		Con- trol	MCB	Total loads Kw				Amps/line			
				I/E	L1-L3	L1-L2	L2-L3	L3-L1	All	Ctrl	L1	L2	L3
3 Platen	Electric STD	4530442	TB1		600	7.8	8.4	7.2	23.3		33.6	36.2	31.0
			TB2	78					0.1	0.3			
	Electric H.K.	4530440	TB1		600	3.0	2.8	2.4	8.2		12.9	12.1	10.3
			TB2	78					0.1	0.3			
			TB3			4.8	5.6	4.8	15.1		20.6	24.1	20.6
	Gas	4530442	TB1		600	3.9	3.3	3.3	10.4		16.7	14.1	14.1
TB2			380.4					0.4	1.6				

WYE - 415 Volts Models													
Model		Drawing		Con- trol	MCB	Total loads Kw				Amps/line			
				I/E	L1-L3	L1-L2	L2-L3	L3-L1	All	Ctrl	L1	L2	L3
3 Platen	Electric STD	4530442	TB1		600	7.8	8.4	7.2	23.3		32.3	34.8	29.8
			TB2	78					0.1	0.3			
	Electric H.K.	4530440	TB1		600	3.0	2.8	2.4	8.2		12.5	11.6	9.9
			TB2	78					0.1	0.3			
			TB3			4.8	5.6	4.8	15.1		19.9	23.2	19.9
	Gas	4530442	TB1		600	3.9	3.3	3.3	10.4		16.1	13.6	13.6
TB2			380.4					0.4	1.6				

GAS INPUT SPECIFICATIONS

Input Specifications, GAS Grills, North America: Gas Input						
GAS	MAX INPUT (NET) PER BURNER (BTU/H)	TOTAL INPUT RATING (BTU/H)	INJECTOR SIZE	AIR SHUTTER SETTING (MM)	SUPPLY PRESSURE (IN W.C.)	BURNER MANIFOLD PRESSURE (IN W.C.)
NATURAL GAS	32,000	96,000	#35	10	7	3.5
NATURAL GAS	27,000	81,000	#38	10	7	3.5
PROPANE	32,000	96,000	#43	10	11	3.5
PROPANE	27,000	81,000	#45	10	11	3.5

Input Specifications, GAS Grills, Japan: Gas Input						
GAS	MAX INPUT (NET) PER BURNER (BTU/H)	TOTAL INPUT RATING (BTU/H)	INJECTOR SIZE	AIR SHUTTER SETTING (MM)	SUPPLY PRESSURE (IN W.C.)	BURNER MANIFOLD PRESSURE (IN W.C.)
13A	32,000	96,000	#38	10	7	3.5
PROPANE	32,000	96,000	#43	10	11	3.5
LPG*	32,000*	96,000*	#45	10*	11	3.5

INPUTS BASED ON HEATING VALUES BELOW		
<u>13A</u>	<u>PROPANE</u>	<u>LPG*</u>
1237 BTU/ft ³	2500 BTU/ft ³	2963 BTU/ft ³ *

* VARIES DEPENDING ON COMPOSITION OF GAS

Input Specifications, GAS Grills, CE Approved Model MWG3W-CE: Gas Input							
GAS GROUP	MAX INPUT (NET) PER BURNER (kW)	TOTAL INPUT RATING (kW)	INJECTOR SIZE	AIR SHUTTER SETTING (mm)	SUPPLY PRESSURE (mbar)	BURNER PRESSURE (mbar)	VOLUMETRIC GAS RATE PER BURNER
G20 NG	8.9	26.7	2.79mm (#35)	10.0	20/25	8.7	0.94 m ³ /h
G25 NG	7.6	22.8	2.79mm (#35)	10.0	20	8.7	0.93 m ³ /h
G31 LPG	9.6	28.8	2.26mm (#43)	10.0	37/50	8.7	0.94 m ³ /h

NET HEATING VALUE BY GAS GROUP		
G20	G25	G31
34.02 MJ/m ³ ; 0.555 SG	29.25 MJ/m ³ ; 0.613 SG	88.0 MJ/m ³ (46.34 MJ/kg); 1.55 SG

GAS CATEGORIES		
CATEGORY	DESTINATION COUNTRIES	SUPPLY PRESSURE (mbar)
I _{2H}	AT, CH, CZ, DK, ES, FI, GB, IE, IS, IT, NO, PT, SE	20.0
I _{2E}	DE, LU	20.0
I _{2L}	NL	25.0
I _{2ER}	FR	20.0 / 25.0
I _{3P}	NL	30.0
I _{3P}	BE, CH, CZ, ES, FR, GB, GR, IE, LU	37.0
I _{3P}	BE, CH, DE, CZ, ES, FR, NL	50.0

INSTALLATION & START UP

Installation Store Responsibilities:

- Ensure grill gets install by a competent, qualified, trained personnel.
- Ensure store readiness of utilities, product & personnel.
- Contact your local Garland Factory Authorized Service Center for a start-up date.
- Participate in the start-up to ensure a successful start-up and familiarity with the grill.
- Conduct training with your crew personnel to ensure maximum utilization of the grill.

Once the installation is complete as per the procedures below, a factory authorized service company MUST start-up the grill according to Garland Commercial Ranges start-up standards.

A start-up DOES NOT include:

1. Uncrating the unit
2. Placing the unit in its position under the exhaust hood.
3. Leveling the grill on the floor under the exhaust hood.
4. Attaching the supply cord(s) unless supplied by the factory.
5. Making adjustments to the ventilation system.
6. Sheet metal work required due to improper exhaust hood application.
7. Adjusting the grill to achieve beef integrity that deviates from the McDonalds standard.

A start-up DOES include:

1. Verification of supply voltage and, if applicable gas supply.
2. Leak test and gas pressure check on gas grills.
3. Electrical safety check.
4. Verify operation of grill by allowing unit to attain set temperature.
5. Verify operation of platens, if applicable, and timer functions.
6. Ensure time out alarm is functional and platens raise (if applicable)

7. Set proper gas and verify with beef integrity check that two consecutive runs yield the approved beef integrity results as per McDonalds standards.
8. Conduct brief training of store manager on the operation of the grill.

Items included with the purchase of your new grill from Manufacturer:

1. One (1) World Grill gas & electric included the following list, except countries mentioned;

Part #	Description	Wrap Around	Non-Wrap Around
4521792	Teflon Sheet (Japan not included)	0	6
4527643	Teflon Release Sheet	9	0
4527294	Teflon Sheet Clip	15	3
4521355	Teflon Bar, Rear	3	3
4523492	Splash Shield	3	3
4525436	Splash Shield (Japan only)	0	3
4530053	W/A Plate, Vapor Shield (UK & Japan not included)	3	3
4530054	Silicone, Front, Vapor (UK & Japan not included)	3	3
Part #	Description	Qty	
4517563	5" Front Swivel Caster w/Brake	2	
1792003	5" Rear Swivel Caster	2	
4523352	Leg Brace Locking Bracket - Standard (Japan not included)	1	

2. One (1) World Grill gas model only included the following;

Description	Qty	Description	Qty
13" Nipple	1	Shut Off Valve	1
3/4 Street Elbows	2	Bracket, Pipe Hanger	1
Coupling	1	Screws	4
Pipe & Bracket Assy	1	Label	1
Nipple	1	Connection Instruction	1
Hanger Brackets	2		

Items NOT included from the manufacturer and should be purchased from the Kitchen Equipment Supplier (KES):

1. Any electrical cords needed for application.
2. Any flue box needed for application.
3. Any grease traps or grease rails needed for application.

INSTALLATION & START UP *(continued)*

THE FOLLOWING INSTALLATION PROCEDURE CAN BE PERFORMED BY A:

- FACTORY AUTHORIZED SERVICE CENTER
- AN APPROVED QUALIFIED INSTALLATION PERSONNEL APPROVED BY PURCHASER OF GRILL
- LICENSED INSTALLER CONTRACTED BY KES.
- CONTACT LOCAL GARLAND FACTORY AUTHORIZED SERVICE CENTER FOR MORE DETAILS. Uncrate unit from crating material

CAUTION:

PRIOR TO INSTALLATION, CHECK THE ELECTRICAL SUPPLY TO ENSURE INPUT VOLTAGE AND PHASE MATCH THE EQUIPMENT VOLTAGE RATING AND PHASE. MANY LOCAL CODES EXIST, IT IS THE RESPONSIBILITY OF THE OWNER/INSTALLER TO COMPLY WITH THESE CODES.

NOTE: ENSURE THAT PLATENS ARE STRAPPED DOWN SECURELY THROUGH STEP 6 TO PREVENT PLATENS FROM RAISING. SEVERE DAMAGE MAY OCCUR.

Installation of Casters

1. Put a pair of heavy gloves to protect your hands and wear a lumbar support for lower back. Safety is the first concern when moving a heavy grill since it weighs approximately 950lbs (431kg) or more.
2. Next procedure will require use of lifting aids and proper lifting/moving techniques. Slide the grill away from walls.
3. Check out the leg brace locking bracket included with your purchased, Ensure you understand the front and the back as shown below.

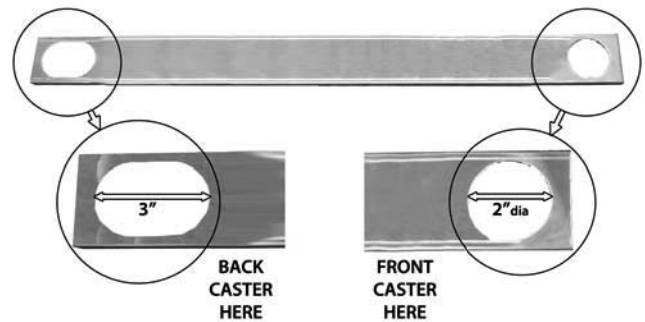

4. Check out the caster included with your purchased, Ensure you understand the front and the rear casters as shown below.

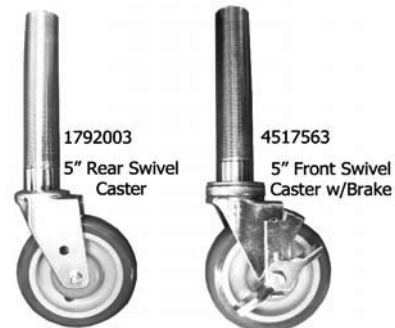

5. Tip unit over on its back. Install casters & channels as shown diagram below. Bracket notch facing the floor.

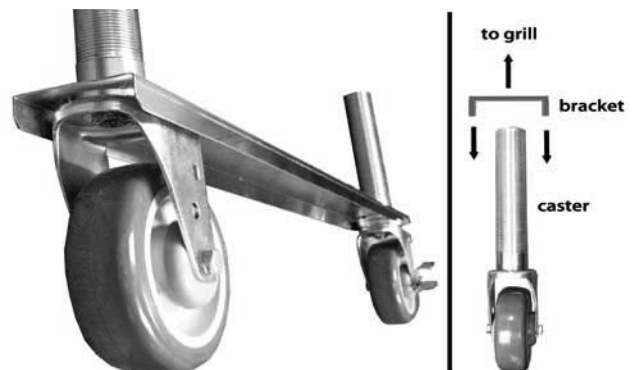

CABLE TIES

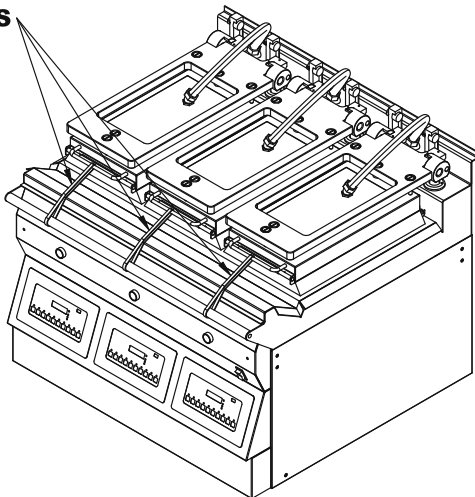

WARNING, HEAVY OBJECT!
The following procedure will require use of lifting aids and proper lifting technique when removing or replacing. To avoid serious injuries use assistance when moving or lifting.

INSTALLATION & START UP *(continued)*

WARNING:

It is recommended that the rear casters are screwed in all the way before tipping the unit.

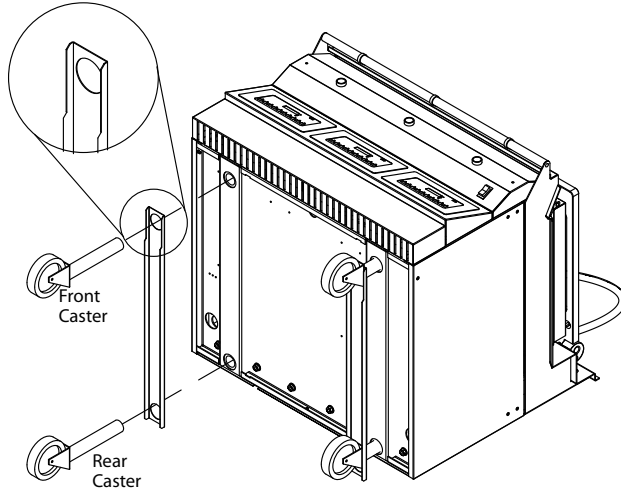

6. Block back caster in place to avoid the unit sliding forward or backward.
7. Carefully rotate grill back on its casters. Now you may cut and remove the platen securing straps.
8. Remove back body side and Install power cords per your country / area's specifications.

WARNING:

The appliances must be electrically grounded in accordance with local codes, or in the absence of local codes, with the National Electrical Code ANSI/NFPA 70, or the Canadian Electrical Code CSA C22.1 as applicable.

Power Supply Connection

All electric connections must be made by a qualified, properly equipped technician.

**NOTE: WIRING DIAGRAM LOCATED INSIDE LOWER FRONT PANEL.
"DISCONNECT POWER BEFORE OPENING"**

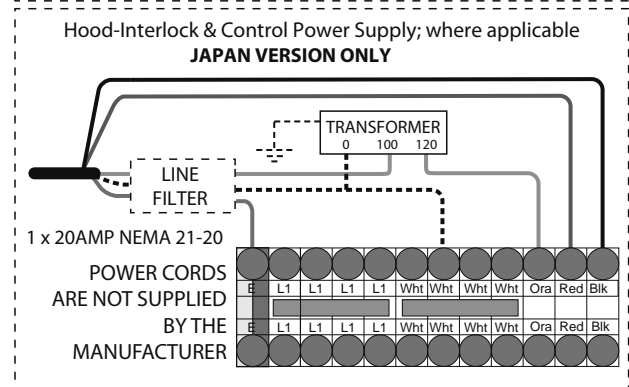
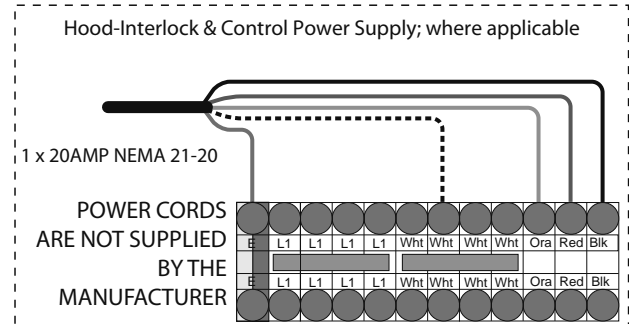
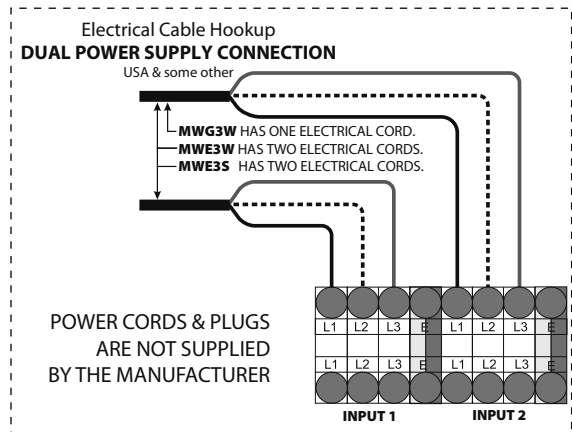
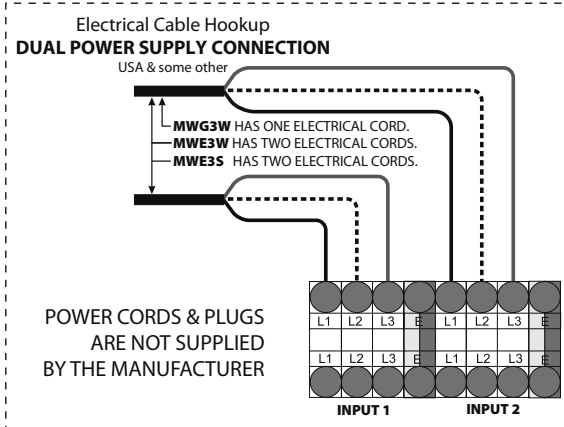

INSTALLATION & STARTUP *(continued)*

Important Note:

Mennekes option is available only in some configurations, check with your supplier for more details.

Mennekes 3 & 5 Pins (Option 1)

Connector	Pins	Intended Load	Connected to
Mennekes 5 Pins	1,2,3,4, GND	Grill and Platen Heaters ~3N 380/400/415 32Amps 50/60Hz	TB1 L1, L2, L3, N, GND
Mennekes 3 Pins	1,2,GND	~1N 120-250 VAC, 16A Control loads (N3, MCB, Ignition controller, blower, gas valve)	TB2 Orange & White Replace jumpers J-N and J-L1

Mennekes 7 Pins (Option 2)

Connector	Pins	Intended Load	Connected to
Mennekes 7 Pins	1,2,3,4, GND	Grill and Platen Heaters ~3N 380/400/415 32Amps 50/60Hz	TB1 L1, L2, L3, N, GND
	5,6	Switvh, Pilot duty only 10A 250VAC, 15A 125VAC, 12(6)A 250VAC T85	TB2 Black & Red

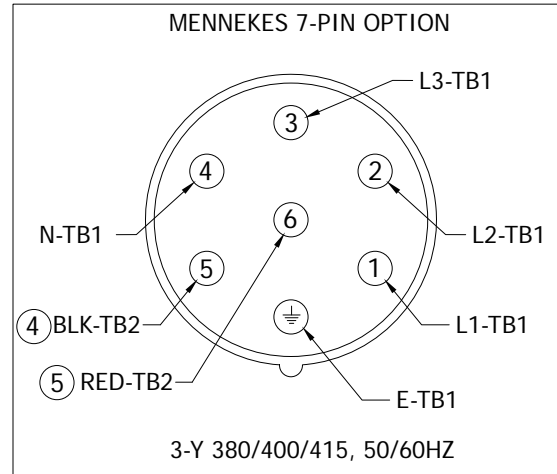
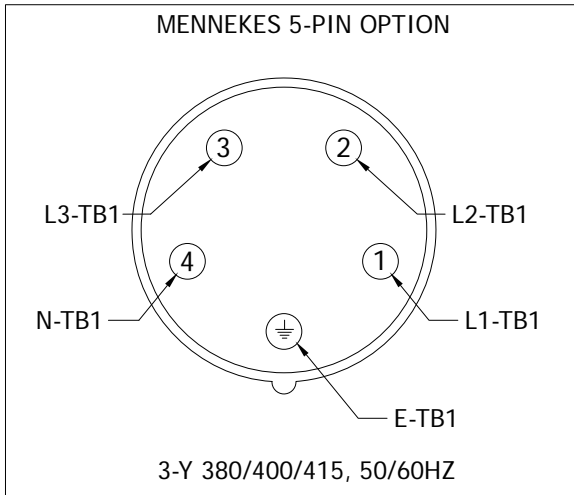

Terminal Blocks Diagram

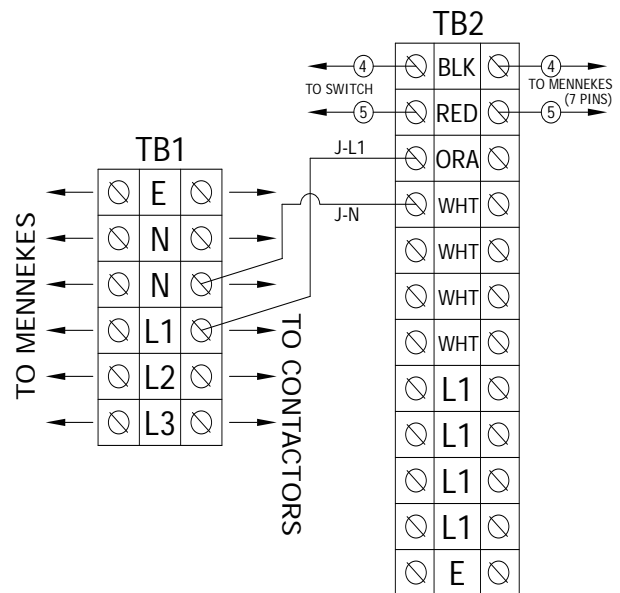
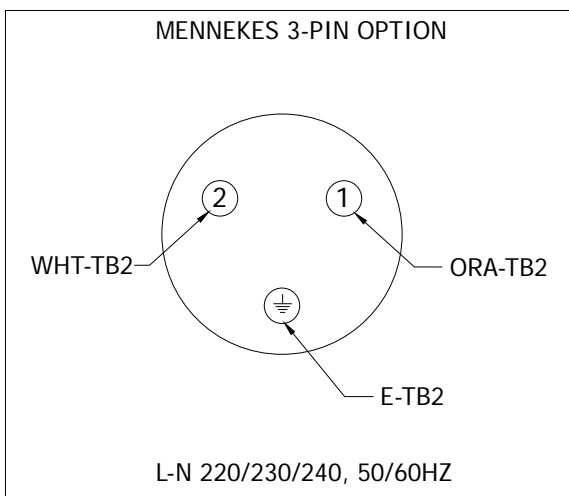

INSTALLATION & START UP *(continued)*

9. Install Optional Front Gas connection (If available).

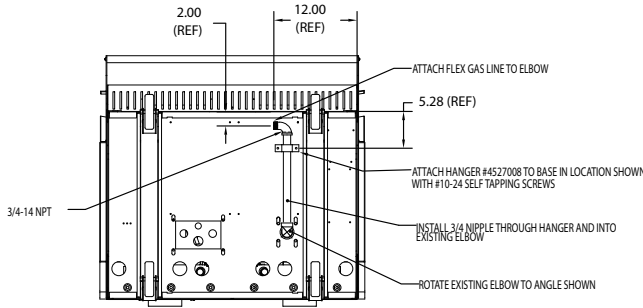

- Isolate grill from any power source by unplugging all electrical connections.
- Rotate existing elbow as shown in the diagram below.
- Attach support bracket (PN 4528775) to base as shown with #10-24 screws and lock washers supplied.

NOTE: For retrofit applications, drill 2x .161 holes and use self tapping screws provided.

- Install 3/4" NPT nipple through support bracket and onto existing elbow. Attach locking ring with 2x #10-24 screws.
- Install elbow to orientation show below.
- Install nipple.
- Attach flex gas hose to nipple.

10. GAS GRILL ONLY, (for electric grills, skip steps 7 & 8):
Install the included quick-disconnect gas hose to the inlet fitting on the underside of the grill by threading a 3/4" NPT nipple into the elbow, then install the brass male quick-disconnect coupler included with the hose.

Connect the hose and ensure the sleeve snaps fully forward against the retaining ring.

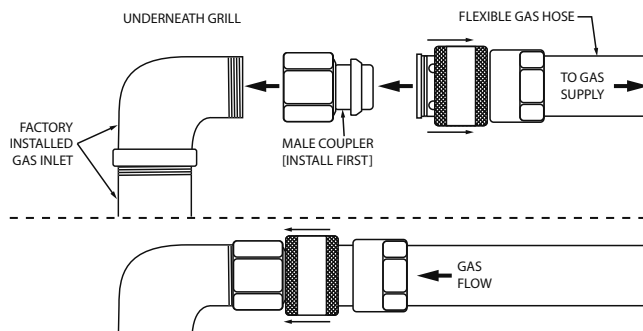

With the manual shut-off valve closed, install the other end of the hose to the gas supply.

11. Install grease bucket rails as shown below:

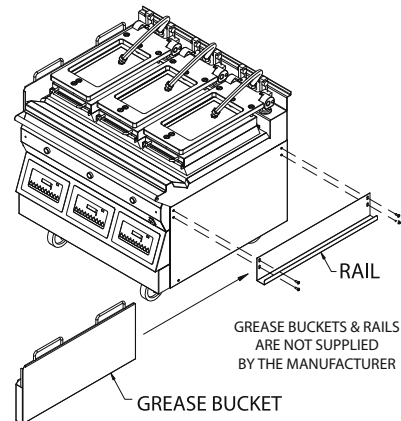

12. Install flue box to back of grill.

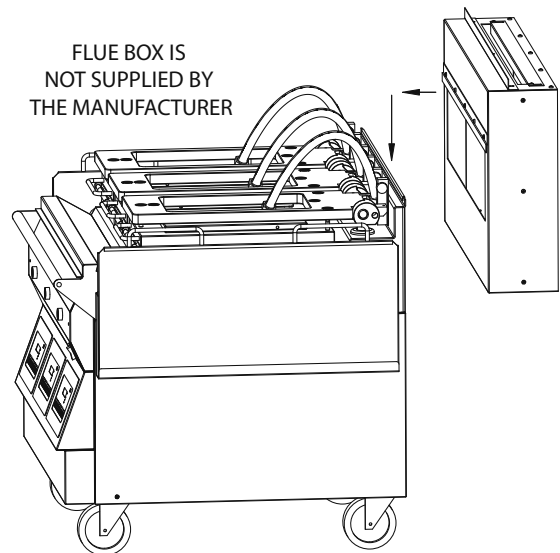

13. Roll grill under exhaust hood. Grill must be level front to back, side to side and diagonally. Adjust casters accordingly to obtain final level.

Exhaust hood Type & Platen Height

With the platens in the raised position, measure the height from the front edge of the platen to the grill surface. Determine which type of exhaust hood the store has and check for exhaust hood type/platen height compatibility according to the table below:

Exhaust hood TYPE	CORRECT PLATEN HEIGHT
Universal	18 1/2" (470mm)
92 Series	17" (432mm)
GSC	18 1/2" (470mm)

INSTALLATION & START UP *(continued)*

If the platen height is incompatible with the exhaust hood type, platen height must be adjusted by an authorized service agent.

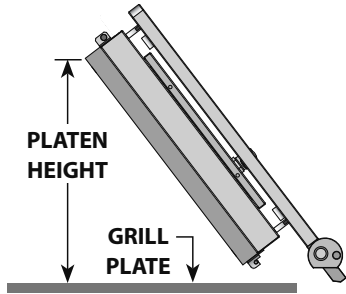

Setting the Proper Combustion Levels

In order to maintain proper combustion levels, the measurement of uA is not required. Using the following procedure will ensure that the proper O₂, CO₂, & CO levels are reached. Combustion level checks and adjustments should only be performed by a qualified technician employed by a factory authorized service center.

1. Remove control panel and lower panel. Set on floor leaving all connections in place.
2. The regulator comes set at 3.5" WC (0.864 KPA) from the factory. Verify pressure is consistent at 3.5" WC.
3. Slightly loosen nut holding butterfly air shutter adjuster on the combustion air blower connected to the burner being adjusted just enough that it can be rotated but will stay in place when force is removed.



4. From a cold start, turn on the zone (burner) and allow it to run for 30 seconds to a minute. Or with a heated zone, place a load on the grill surface to keep the burner operating for a couple of minutes. Adjust the air shutter to reduce the air to the point that the flame on the burner begins to lift and dance off of the burner surface.

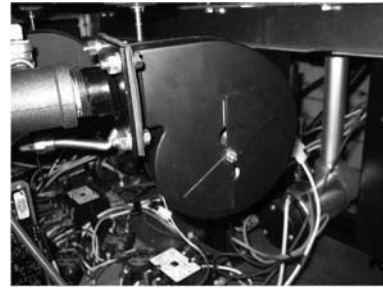

- a. Mark a line along the edge of the air shutter from the hole along the edge of the shutter marking the position of the shutter on the side of the blower face.
- b. If this condition already exists, mark the line at the position and move to the next step
5. Rotate the air shutter open to the point that the flame loses its inner light blue cone and becomes less bright and the tip of the flame elongates and becomes about an inch (25.4 mm) long. Mark a line on the edge of the shutter at this position.
- Or if air shutter is fully open, mark the line at that point.



6. Turn off Burner (zone) and measure the distance between the outside ends of the two lines previously marked and place another mark in the center of the two marks.
 - a. Add another mark 1/16" (1.6mm) more than the center mark
 - b. Rotate the butterfly shutter to this point, and retighten.

INSTALLATION & START UP *(continued)*

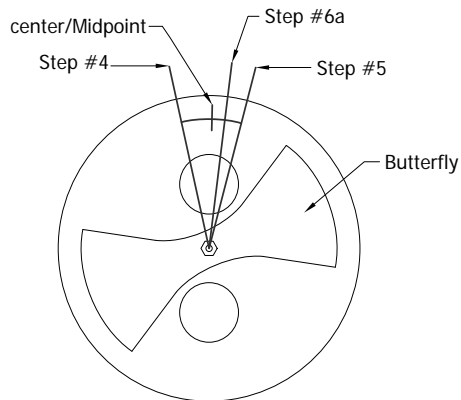

Start-up Procedure

This Garland 3-platen grill comes with a factory start-up at no additional charge. A start-up is required to take place **BEFORE** the unit is put into operation. It is the end-user responsibility to schedule the start-up with their local Factory Authorized Service Agent, or notify Garland Commercial Ranges at 1-800-446-8367 should you need assistance scheduling.

A factory start-up is a comprehensive grill check in which a factory certified technician will document all final settings programmed in the controller once various other performance checks are complete. The estimated time to complete a start-up is approximately 2.5 – 3.5 hours. Please keep in mind this estimated time when scheduling the start-up. After hours or overtime is not covered under warranty and will be billed at a charge which is the difference between the Garland Reimbursement rate and the Factory Authorized Service Centers overtime charges.

A factory start-up is necessary to start the warranty period. The Authorized Service Center is required to complete the paperwork during the start-up process, and send it to Garland Commercial Industries for reimbursement. At the time of receipt, Garland will start the warranty period which will conclude at the end of 2 years.

INSTALLATION & START UP *(continued)*

GARLAND CLAMSHELL GRILL START – UP FORM

ELECTRIC OR COMBINATION GAS / ELECTRIC

McDonald's _____ Certification ID # _____ Store # _____ Model _____
Located on Certification Sticker (Check One)

Address _____ City _____

State / Province _____ Zip Code _____ Serial# _____ Start Up Date _____
(MM / DD / YYYY)

United States Canada International (List Country) Telephone # _____

Gas Type	Electric / 3-phase	Record Amps Per Line Each Contactor		
Actual Gas Type _____	Actual Input _____ V / _____ Hz	Left	Center	Right
Matches Rating Plate? YES NO	<input type="checkbox"/> 208 VAC <input type="checkbox"/> 380 VAC <input type="checkbox"/> 220 VAC <input type="checkbox"/> 400 VAC <input type="checkbox"/> 230 VAC <input type="checkbox"/> 415 VAC <input type="checkbox"/> 240 VAC <input type="checkbox"/> 50 Hz	Line 1	Line 2	Line 3

INSPECTION / OPERATIONAL CHECK

NOTE1: CENTER(C) PLATEN should not be checked if MWE2W / MWG2W / MWE2S
NOTE2: CENTER(C) & RIGHT(R) PLATEN should not be checked if MWE1W / MWG1W / MWE1S

1. To avoid personal injury or property damage, **Check for Gas Leaks** through the entire gas line. PASSED – NO GAS LEAKS
2. Ensure equipment restraint devices are installed correctly according to local codes (Gas & Electric). Note: part supplied by others. OK
3. Verify, power cord has a strain relief attached from power supply cord to grill unit. YES / NO
4. Ensure grill is installed in the proper type of **Gas Exhaust Hood** with the proper air draw. OK
5. Ensure flue restrictors are fully opened or removed. Flue Box Supplied by KES
Flue Restrictors located inside exhaust hood. OK
6. Ensure bottom plate is leveled side to side / front to back / diagonally, in location, under hood. **Adjust casters to attain level.** OK
7. **REMOVE GRILL FROM UNDER THE HOOD.** Turn Power Switch ON, controller displays are active, **Controller displays "OFF"**. All platen raises automatically? L OK | C OK | R OK
8. Lower and raise Upper Platen and ensure movement is smooth and continuous. Grease shafts accordingly with a FOOD GRADE LUBRICANT. L OK | C OK | R OK
9. If upper platen elevation requires lowered to allow for clearance of hood, lower upper limit switch. Refer to Operations & Installation manual for platen heights. L OK | C OK | R OK
10. Press the POWER ON button. Controller displays "PREHEAT - AM", platen lowers. Heat indicator lights are AMBER? L OK | C OK | R OK
11. Press and hold the AM / PM key and set to PM. This will allow the unit to heat to Platen-425 F(217°C), Grill-350 F(177°C) for a grill with full default settings. L OK | C OK | R OK
12. Ensure grill enters SOAK mode (15:00 timer), counts down and upper platen auto calibrates while at temperature. L OK | C OK | R OK
13. Close valve handle and verify the unit tries to ignite **three (3) times** and then locks out because of Ignition Failure? L OK | C OK | R OK
14. GAS PRESSURE CHECKS (if applicable): (Note 1: Center should not be fill if MWG2W / MWG2W-1) (Note 2: Center & Right should not be fill if MWG1W / MWG1W-1)
 Rated Incoming Pressure Natural Gas: 6 – 14" W.C. Propane / Butane Gas: 11 – 14" W.C. Actual Incoming _____ "W.C.
 Rated Burner Pressure Natural Gas 3.5" W.C. Actual Left _____ Center _____ Right _____
 Propane Gas 3.5" W.C. for MWG3W/MWG3W-1 Actual Left _____ Center _____ Right _____
 10" W.C. for MWG2W/MWG2W-1 MWG1W/MWG1W-1
15. Check micro amp reading on flame sense to ensure operating micro amps ARE NO LESS THAN **0.8 uA** on all burners, unless the grill is equipped with a CE certified ignition module, in which case the minimum is **2.0 uA**. OK
Micro-amps Reading = _____
16. Upon Completion of auto calibration, platen raised automatically, and display reads "READY"
If upon completion of auto calibration process, upper platen does not raise, indicate message on controller.
Check platen level and adjust reed switches. Cycle power and retry. OK - L / C / R
Check Platen Level - L / C / R
Check Reed Switch - L / C / R
17. Select menu item "10:1 – CLAM". Verify set temperature is reached and LED lights turn GREEN. L OK | C OK | R OK
18. Initiate cook cycle by pushing the GREEN BUTTON. Platen lowers, and timing cycle begins. L OK | C OK | R OK
19. Ensure the stores pyrometer is accurate and calibrated using the ice bath method. OK
20. Perform PROBE CALIBRATION. L OK | C OK | R OK
21. Perform Platen Leveling procedure & Reed Switch Calibration in "LEVEL / REED SW" mode. L OK | C OK | R OK
22. Ensure grill performs successful Auto Calibration upon completion of reed switch calibration. L OK | C OK | R OK
23. Lock down all caps. Ensure that the lock nuts do not turn any of the adjuster nuts when tightening. L OK | C OK | R OK
24. Assist or obtain assistance with store personnel for **Beef/Chicken Integrity Testing**, testing product 10:1, 4:1, Angus, Grill Chicken until desired internal product temperatures are met and record cook time (Product cook times chart below). L OK | C OK | R OK

Product Cook Times			
	LEFT	CENTER <small>(If Applicable)</small>	RIGHT <small>(If Applicable)</small>
10:1			
4:1			
ANGUS			
GRILL CHICKEN			

Beef Integrity Product	
Manual Mode	<input type="checkbox"/> OK
Tested Auto Mode	<input type="checkbox"/> OK

Problems / Special Circumstances / Damage: _____

Submitted by:	Accepted by:
Name: _____	Name: _____
Service Agency: _____	Have you been adequately informed of the operation of the grill, its uses and its general operation? <input type="checkbox"/> YES <input type="checkbox"/> NO – Indicate comments _____
Sub Agent: (if Applicable) _____	_____
Have you trained store personnel on the operation of the grill? YES / NO	_____
Are you a factory certified technician? YES / NO	_____
Date of Certification (MM/DD/YY)	_____

Visit our <https://clamsshell.garland-group.com> for Literature & Documentation

White Copy – Factory Yellow Copy – Service Agency Pink Copy – Customer

TEMPERATURE PROBE CALIBRATION

Monthly Calibration/Verification of Grill Temperature Zones



HOT SURFACE

Grill Temperatures
Will Cause Severe
Burns



Overview

Reason: To Maintain Accurate Grill Temperature Zones.

Models: MWG3W-1, MWE3W-1, MWE3S-1.

Tools: Digital Pyrometer with Surface Probe.

Procedures:

1. Temperature Verification Procedure.
2. Temperature Calibration Procedure.

WARNING:



PERSONAL INJURY FROM BURNS MAY RESULT WHEN COMING IN CONTACT WITH HOT COOKING SURFACES.

NOTE:

1. **CALIBRATION AND VERIFICATION OF GRILL IS DONE WITH RELEASE MATERIAL SHEETS "OFF".**
2. **MUST CLEAN GRILL PLATE AND PLATEN SURFACES.**

1. Temperature Verification Procedure

PLEASE FOLLOW THESE INSTRUCTIONS EXACTLY AS THEY APPEAR BELOW:

1. The upper platens and lower grill plate should be at operating temperatures to perform this calibration procedure. Press the  or  button to select a "CLAM" operation that requires a temp of 350°F (177°C) on the griddle plate and allow the grill to reach the set temperature and stabilize, (approximately 30 minutes).
2. Press and hold the temperature button for approximately 3 seconds, or until the controller will display all temperature values (T,F,M,B).
3. Place pyrometer over the marks on grill plate indicating thermocouple location (see sketches on next pages). Allow at least 5 to 10 seconds for the pyrometer to respond and stabilize.
4. Check calibration for each heat zone when the following conditions occur:
 - A. The temperature indicator light for the specific thermocouple is GREEN.
 - B. Temperature read out for a specific thermocouple on the control is decreasing.
 - C. **Optimum range for VERIFICATION is between 355F (180C) and 350F (177C).** This procedure can require up to 10 minutes, depending on the point in time the operator gets in the heat cycle

IMPORTANT NOTE:

For **3 Platen Gas Grill**, value B on the controller display represents the thermocouple on the middle plate.















TEMPERATURE PROBE CALIBRATION *(continued)*

Monthly Calibration/Verification of Grill Temperature Zones

5. Temperature delta between pyrometer and controller must be +/-5F (+/-3C). If the temperature delta between pyrometer and controller is more than +/-5F (+/-3C) go to TEMPERATURE CALIBRATION PROCEDURE to correct required zone.

2. Temperature Calibration Procedure

PLEASE FOLLOW THESE INSTRUCTIONS EXACTLY AS THEY APPEAR BELOW:

- The upper platens and lower grill plate should be at operating temperatures to perform this calibration procedure. Press the  or  button to select a "CLAM" operation that requires a temp of 350° (177°C) on the griddle plate and allow the grill to reach the set temperature and stabilize, (approximately 30 minutes).
 - PRESS and HOLD the  button for approximately 3 seconds, or until the controller will display: "PROBE CAL"
 - PRESS the  button to display the first temperature zone to be calibrated. The first zone to be calibrated is "FRONT TEMP CAL". The zones are displayed in order of FRONT TEMP CAL, MIDDLE TEMP CAL, BACK TEMP CAL, TOP TEMP CAL.
 - Select a heat zone display using the  or  buttons.
 - Place pyrometer over the marks on grill plate indicating thermocouple location (see sketches on next pages). Allow at least 5 to 10 seconds for the pyrometer to respond and stabilize. Note the temperature on the pyrometer.
- IMPORTANT NOTE:**
Optimum range for CALIBRATION is between 355F (180C) and 350F (177C). This procedure can require up to 10 minutes, depending on the point in time the operator gets in the PROBE CAL.
- Adjust the temperature on the grill control accordingly to match the temperature on the pyrometer. The  button will increase the displayed temperature in one, (1) degree increments. The  button will decrease the displayed temperature in one, (1), degree Increments.
- NOTE: During step 6, the control should be sounding a high-pitched tone. The temperature can only be adjusted if this tone is sounding and display flashing. If the control is silent and display not flashing, the temperature will not change.**
- As soon as you have a temperature match PRESS the  button to lock the calibrated temperature into the controller.
- Note: If calibration window is missed, press  to go back to the previous step.**
-  = Exits function without any modification, as long as  button has not been pressed.**
- Press the  or  button to select the next heat zone.
 - Move the pyrometer's surface probe to the newly selected heat zone and repeat steps 5, 6, and 7.
- IMPORTANT NOTE:**
For 3 Platen Gas Grill, value B on the controller display represents the thermocouple on the middle plate.
- Repeat the procedure for each of the heat zones.
- Exit the program mode by pressing the  button. The controller will return to its previous state in the Normal Operating Mode for temperature verification (page 1).

TEMPERATURE PROBE CALIBRATION *(continued)*

General Definition of Thermocouples Usage

Grill Models	Quantity of Thermocouples on Grill	Controller Display	Thermocouple Location on Grill Plate	Quantity of Thermocouples on Platen	Thermocouple Location on Platen
MWE3W-1 / MWE3S-1	3	B	Back	1	T = Top Center
		M	Middle		
		F	Front		



Grill Models	Quantity of Thermocouples on Grill	Controller Display	Thermocouple Location on Grill Plate	Quantity of Thermocouples on Platen	Thermocouple Location on Platen
MWG3W-1	1	B	Middle	1	T = Top Center



Note: Temperature reading could be in Fahrenheit or Celsius.

TEMPERATURE PROBE CALIBRATION *(continued)*

3 Platen Thermocouple Location of Grill Zones

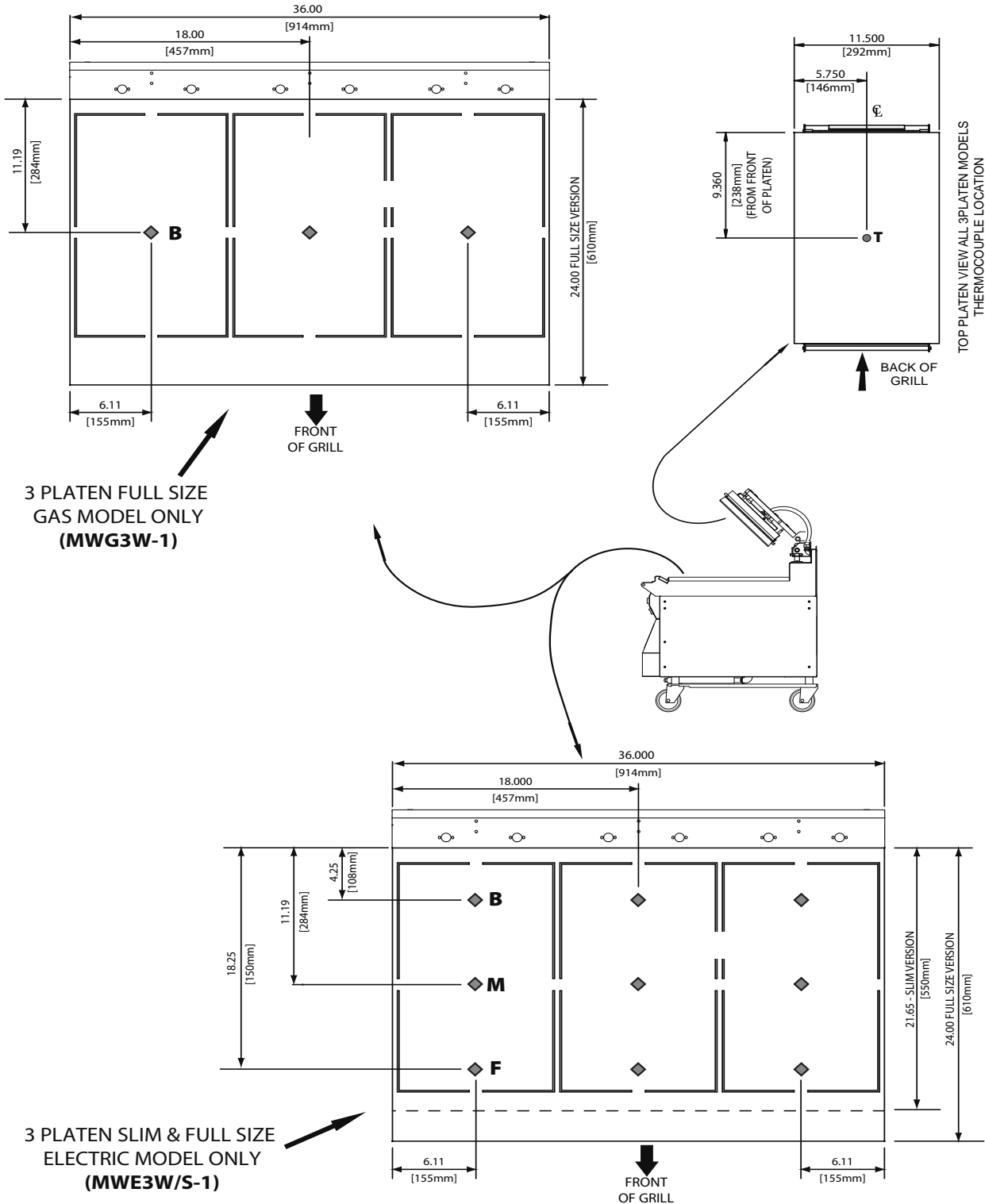

INSTALLATION OF WRAP AROUND RELEASE MATERIAL MOUNTING BRACKETS

CAUTION:
UPPER PLATEN IS EXTREMELY HOT.

WARNING:
ISOLATE POWER SOURCE TO PREVENT ELECTRICAL SHOCK.

1. Ensure Electrical Power is unplugged before proceeding to the next step.
2. Loosen two (2) screws from each side of the platen lid.
3. Position side bracket assemblies over screws and insert into place.

4. Retighten four (4) screws on the platen lid.

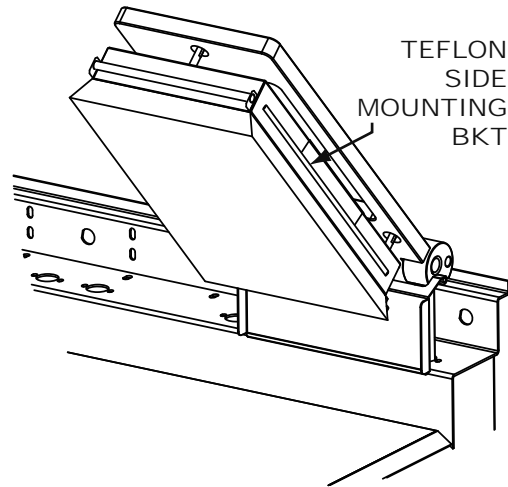
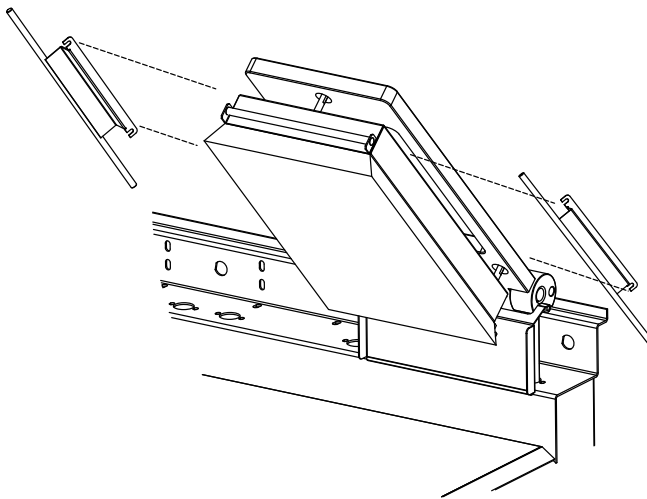

5. Part number and description shown below.

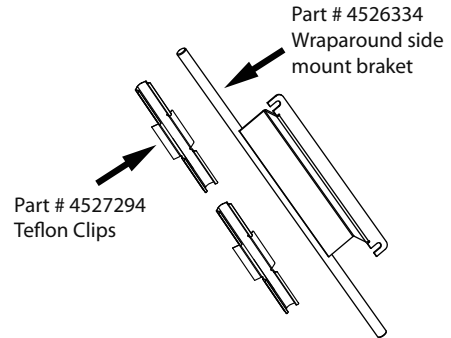

INSTALLATION OF SPLASH SHIELD

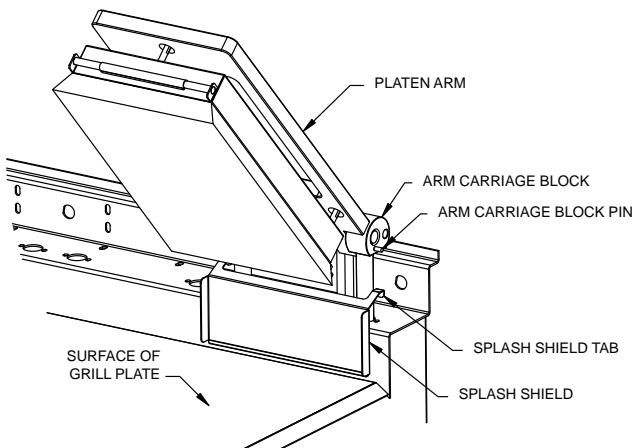

NOTE: SOME COMPONENTS OMITTED FOR CLARITY

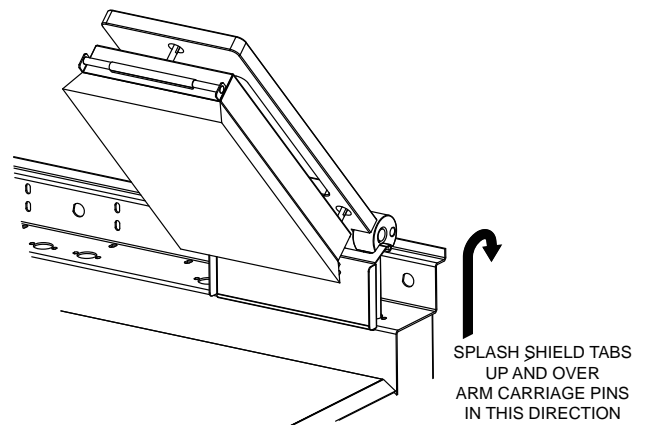

NOTE: SOME COMPONENTS OMITTED FOR CLARITY

INSTALLATION OF RELEASE MATERIAL

1. Slide release material rod through hemmed end of the Release Material® sheet.
2. Hook Release Material® rod on brackets located at the rear of the upper platen.

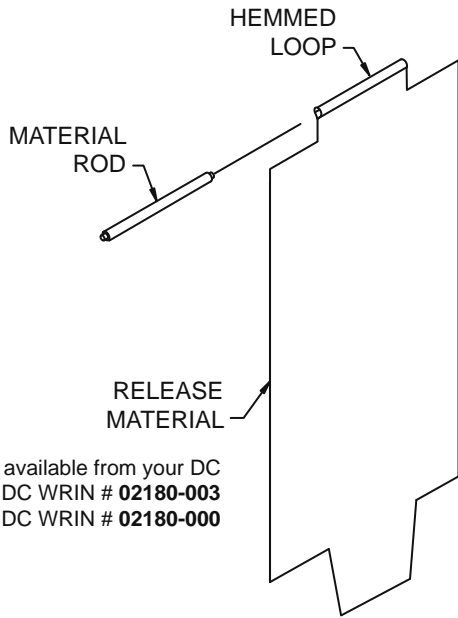

"Teflon Sheet" available from your DC
 Saint Gobain: DC WRIN # 02180-003
 Taconic: DC WRIN # 02180-000

3. Holding the bottom of the release material sheet in place, gently pull the sheet toward the front of the platen.

Note:
 Make sure Release Material® fits smoothly over upper platen.

4. Place one (1) locking clip over release material sheet in front and press into place over release material bar.

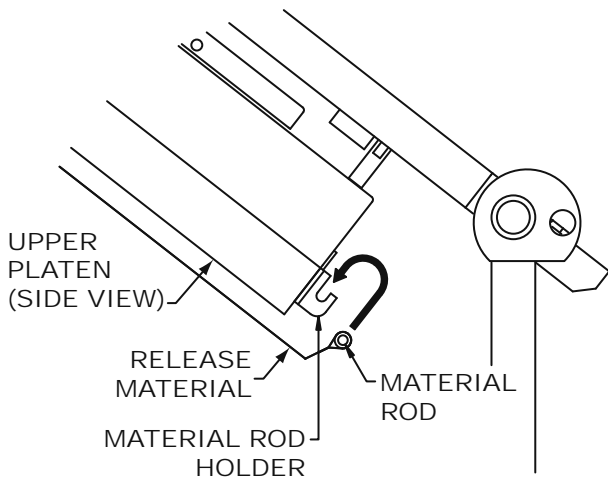

5. Gently pull the release material sheet flap over the left side of the platen and secure in place with two (2) locking clips.

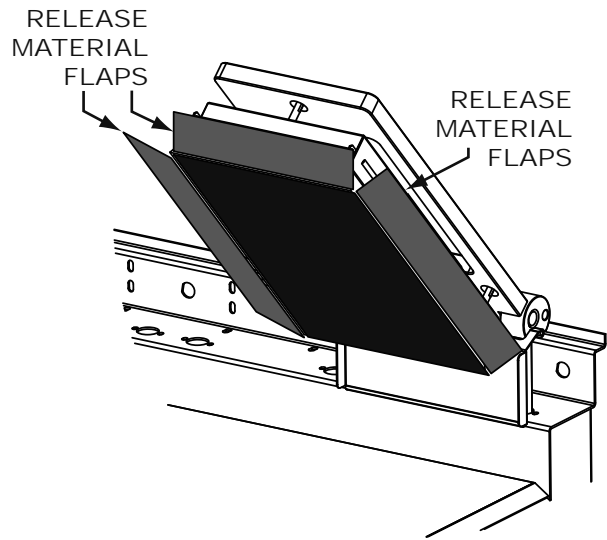

Note:
 Failure to install the correct number of clips on the upper platen will cause the Release Material® to be loose, and wear quickly. Ensure the correct placement of all clips to prevent premature wear and/or poor product quality.

6. Check alignment and tightness of release material against upper platen.

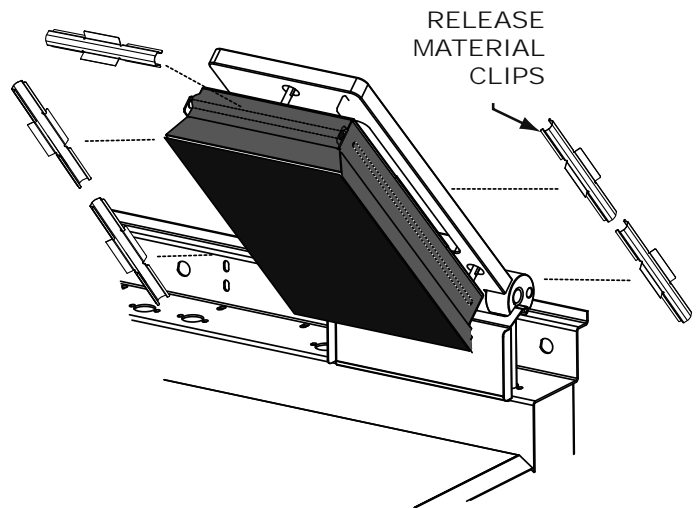

INSTALLATION OF VAPOR SHIELD

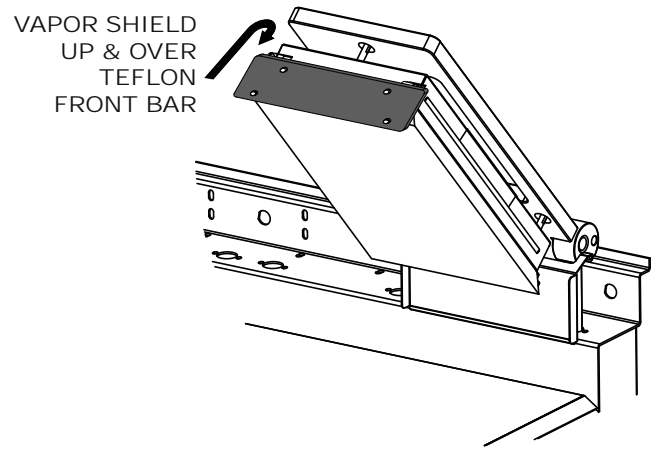
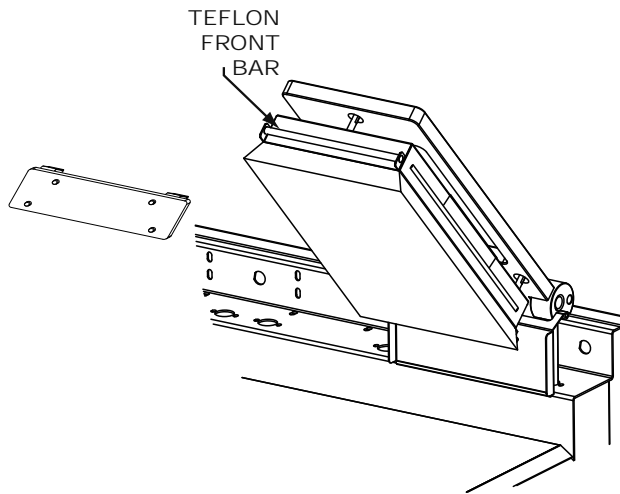

GRILL ACCESSORIES

Splash Shield
Item 4523492



Vapor Shield
Item CK4530053

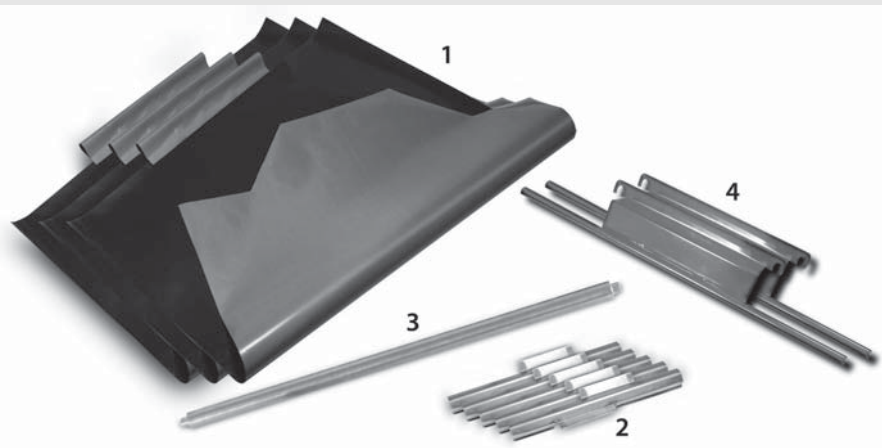

Teflon Wraparound kit (3 platens)

	Description	Part #
1	Teflon Sheet (Wraparound)	4527643
2	Clips	4527294
3	Teflon Rear Bar	4521355
4	Side Mount Bracket	4526334

AVAILABLE ACCESSORIES

BELOW POWER CORDS ARE RECOMMENDED ONLY.
CORDS APPLY TO APPLICATIONS AND ARE NOT STANDARD.

3Phase 4Wire 50 AMP Power Cord (Electric Grill ONLY)
(No Garland P/N) - *** Not supplied by Garland

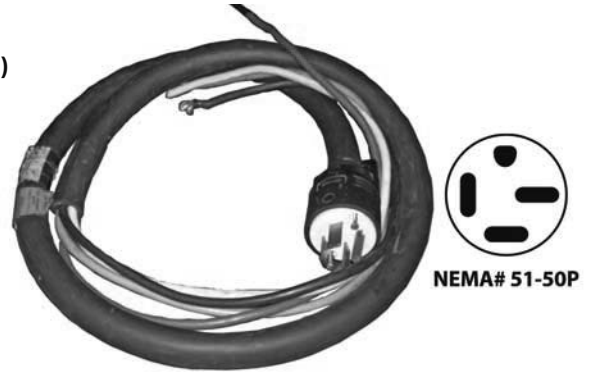

3Phase 4Wire 30 AMP Power Cord (Electric Grill ONLY)
(No Garland P/N) - *** Not supplied by Garland



Interlock Cord - 5Wire
(No Garland P/N) - *** Not supplied by Garland

Note:

Power cord not included with the purchase of your new grill from manufacturer.

AVAILABLE ACCESSORIES

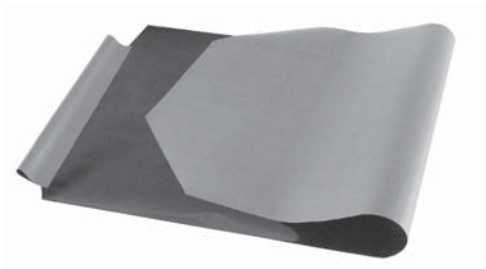

Teflon Sheet (Not Wraparound)
Item 4521792



Release Material Sheet Rod
Item 4526436)



Quick-Disconnect Gas Hose
Item 1591506



Release Material Sheet Retaining Clip
Item 4527294)

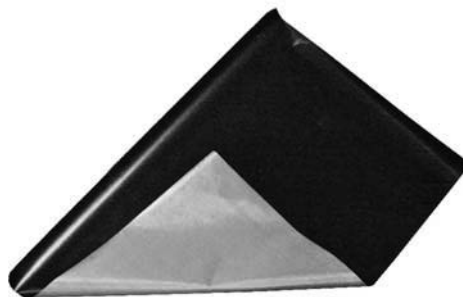

Lower Teflon Release Sheet
Item 4531542

CLEANING & MAINTENANCE

Warning: Pinch Hazard keep hands and tools clear when platens are in motion. Unexpected movement of platens can occur during cleaning or servicing process. Turn Grill Off at main switch when cleaning platen



McD Hi-Temp Grill Cleaner



KAY Grill Cleaning Pad Holder & KAY Grill Cleaning Pad



Heat-Resistant Gloves



Clean, Sanitizer-Soaked Grill Cloths



Lid

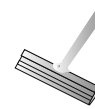

Grill Squeegee

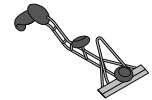

Grill Scraper

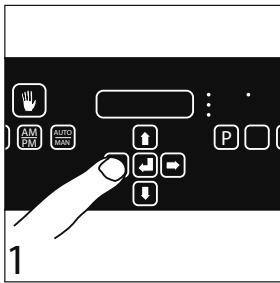

- Select Clean Mode. Once Clean Mode has been reached turn each zone OFF.
- Turn main switch **OFF** when cleaning platens

Warning

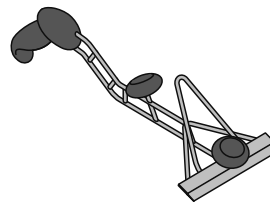

- Following Step has to be performed by using a Grill Scraper approved by McDonald's.
- Failure to use a McDonalds approved scraper may result in grill surface damage.
- **Note:** Never use a steel scraper to clean the upper platens.

Grill Scraper

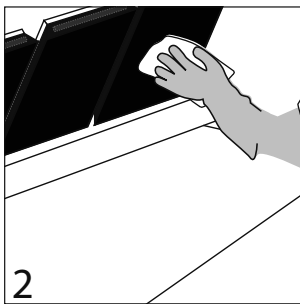

- Wipe the Release Material® sheets with a clean, sanitizer-soaked grill cloth.

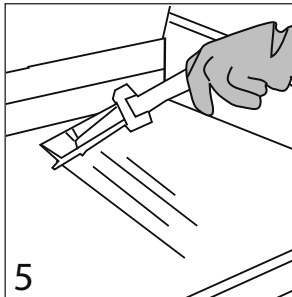

- Scrape the lower grill surface with the grill scraper.
- Use grill squeegee to push residual grease into trough.
- Take grill scraper to the 3-compartment sink to be washed and rinsed.

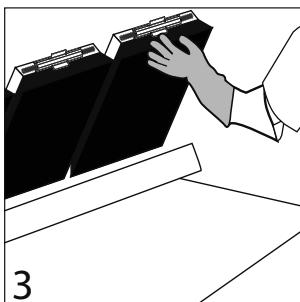

- Remove the locking clips, bars, and release Material® sheets.
- Take the clips and bars to the 3-compartment sink to be washed and rinsed; set aside.
- Set release Material® sheets aside on a flat surface.

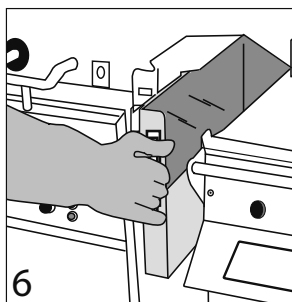

- Empty and replace the grease troughs.

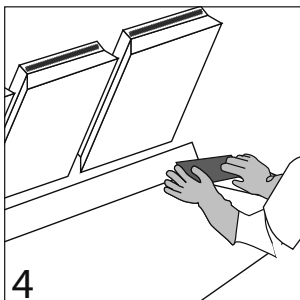

- If splash guards are installed, detach and take to the 3-compartment sink to be washed and rinsed; set aside.

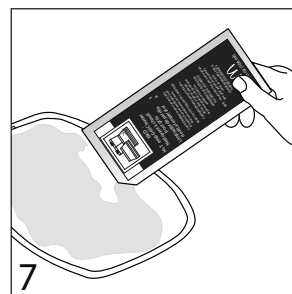

- Open one packet of McD Hi-Temp Grill Cleaner and empty the contents into a lid or stainless steel pan.
- Put on the heat-resistant gloves and safety glasses..

CLEANING & MAINTENANCE

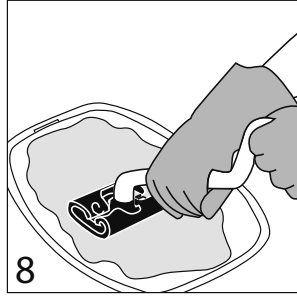

- Dip the KAY Grill Cleaning Pad Holder into the grill cleaner.
- **Note:** Never use a steel scraper to clean the upper platens.

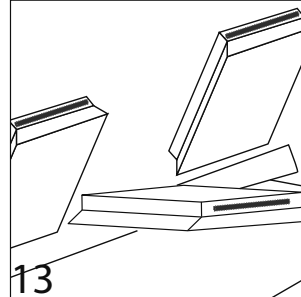

- Turn main switch **ON**.
- Press green button to lower center platen.
- Turn main switch **OFF**

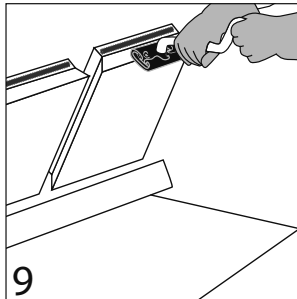

- Apply McD Hi-Temp Grill Cleaner to front side of platens starting from right platen to left platen.
- **DO NOT SCRUB**

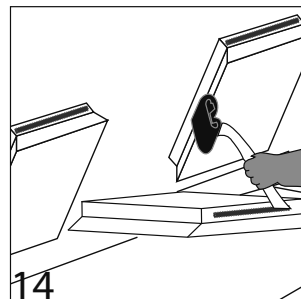

- Apply grill cleaner to inner edges of the right and left platens.
- Apply grill cleaner to side edges of the center platen
- Turn main switch **ON**.
- Press green button to raise right platen.

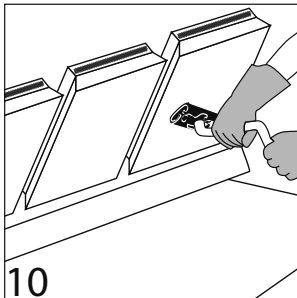

- Apply the grill cleaner to platen surfaces starting from right platen to left platen.
- **DO NOT SCRUB**

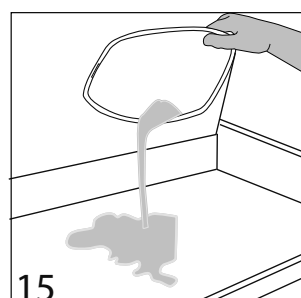

- Turn main switch **OFF**.
- Pour remaining McD Hi-Temp Grill Cleaner over bottom grill surface.

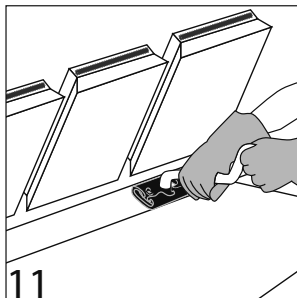

- Apply the grill cleaner to back side of platens from right platen to left platen.
- **DO NOT SCRUB**

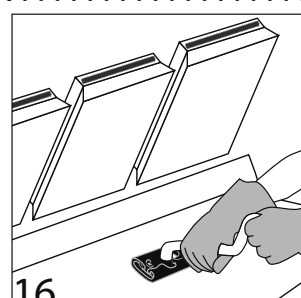

- Spread the cleaner over the entire lower grill surface from front to back using even strokes.
- **DO NOT SCRUB**

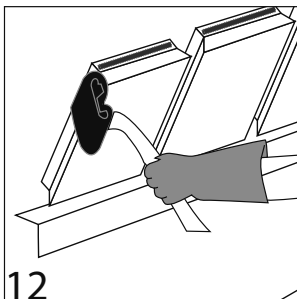

- Apply the grill cleaner to outer edges of right and left platens.
- **DO NOT SCRUB**

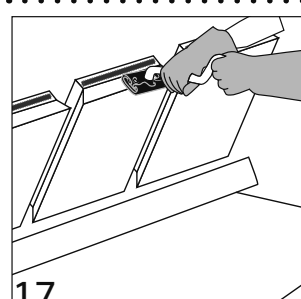

- Start scrubbing now.
- Scrub front side of platens from right platen to left platen with KAY Grill Cleaning Pad Holder and Pad.

CLEANING & MAINTENANCE

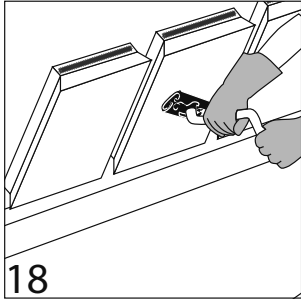

- Scrub flat grill surfaces starting from right platen to left platen.

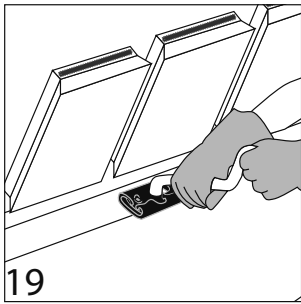

- Scrub back side of platens from right platen to left platen.

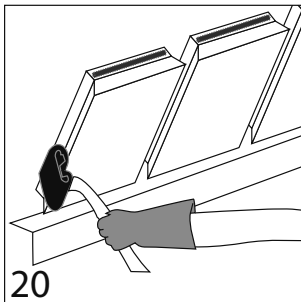

- Scrub outer edges of right and left platens.
- Turn main switch **ON**

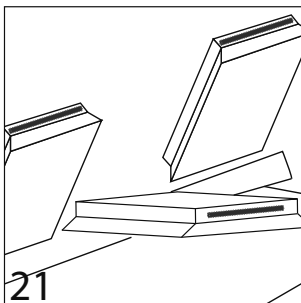

- Press green button to lower center platen
- Turn main switch **OFF**..

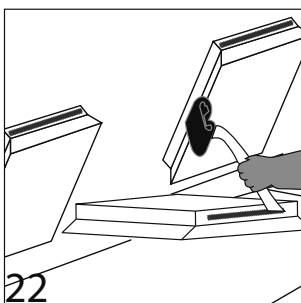

- Scrub inner edges of the right and left platens
- Scrub side edges of the center platen.
- Turn main switch **ON**.
- Press green button to raise the center platen.

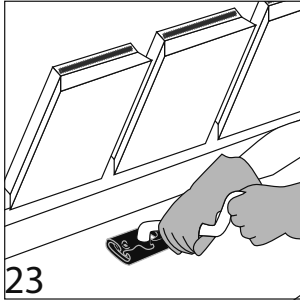

- Turn main switch **OFF**..
- Scrub lower grill surface.

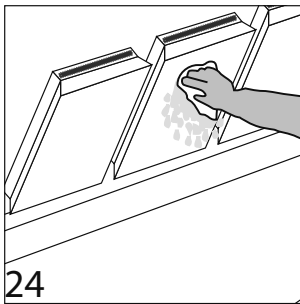

- Rinse front, side and back of platen surfaces with a clean, sanitizer-soaked grill cloth, starting from right to left platens.
- Turn main switch **ON**.

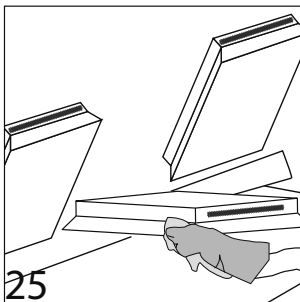

- Press the green button to lower center platen.
- Turn main switch **OFF**.
- Rinse edges of all platens.
- Turn main switch **ON**.
- Raise platen.

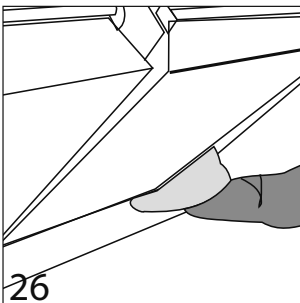

- Turn main switch **OFF**.
- Wipe back of lower grill with a clean, sanitizer-soaked grill cloth.



- Pour a small amount of lukewarm water on a clean, sanitizer-soaked grill cloth over the bottom grill surface and wipe off residue.

CLEANING & MAINTENANCE

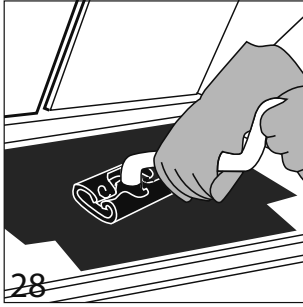

- Place upper platen Release Material sheets flat on grill surface.
- Gently clean both sides of the Release Material sheets with the KAY Grill Cleaning Pad Holder.

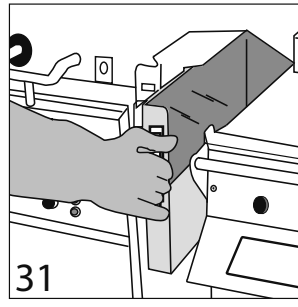

- Empty, wash, rinse, and replace the grease troughs.

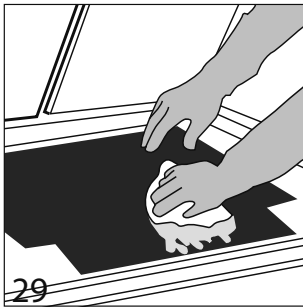

- Rinse both sides of the Release Materialsheets with a clean, sanitizer-soaked grill cloth.
- Reinstall upper Release Material sheets; secure in place with bars and clips.

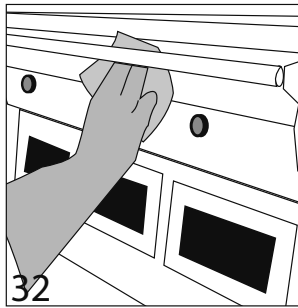

- Wipe remaining grill surfaces with a clean, sanitizer-soaked grill cloth.

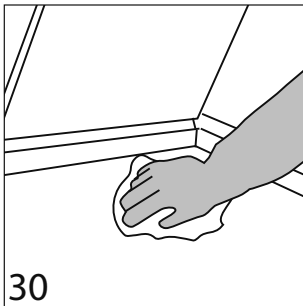

- Wipe lower grill with a clean, sanitizer-soaked grill cloth. Repeat until no visible soil remains.

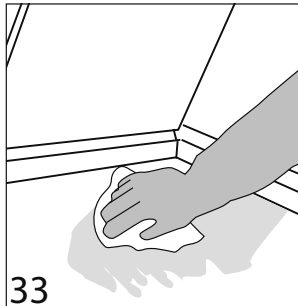

- Apply a thin coat of fresh shortening to the lower grill surface only.

PULL / PUSH GRILL PROCEDURE

1. Turn main switch ON.
2. Press green button to lower platen(s).
3. Turn main switch OFF.
4. Unplug power cord and proceed with pull/push.



WARNING,
Avoiding procedure may cause damage or loss of calibration on the platen and potential of error message can occur.

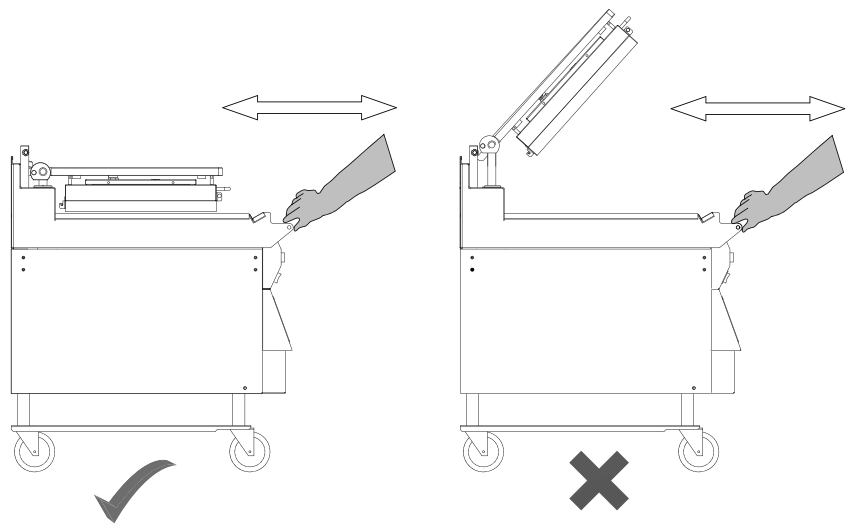

PASS – Gently pull or push

FAIL – Potential to damage platen adjustment

DESCRIPTION OF GRILL CONTROL

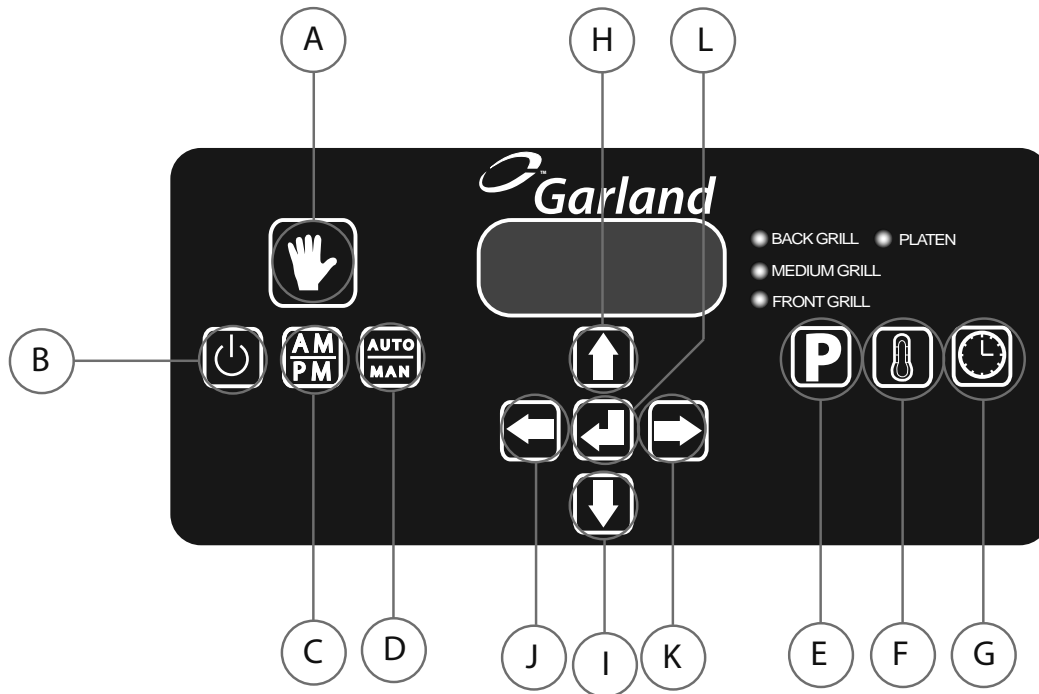

Items	Key Data	Funtions
A	Key A – Standby	Key A will be used to put the control into the Standby mode.
B	Key B – On/Off	Key B will turn the control on and off. PRESSING and HOLDING button for 2 seconds
C	Key C – AM/PM	This button is used to toggle back and forth between the AM menu list and the PM menu list in manual cook mode. In automatic mode this button will toggle between the AM product recognition gaps and the PM product recognition gaps.
D	Key D – Automatic/Manual	Key D will be used to select between Automatic and Manual cooking. Used for product recognition only.
E	Key E – Programming	Key E will allow the user to enter and exit the Programming Mode. PRESSING & HOLDING button for 3 seconds
F	Key F – Temperature	Key F will be used to view the set point and actual temperature of the grill and platen.
G	Key G - Time	Key G will be used to change the remove time of a specific menu item and to calibrate the grill temperatures.
H	Key H – Up Arrow	Key H will scroll up through the menus as well as scroll up in the programming mode.
I	Key I – Down Arrow	Key F will scroll Downs through menus as well as decrement values in the programming mode.
J	Key J – Left Arrow	Key J will be used for scrolling through menus and well as in programming.
K	Key K – Right Arrow	Key K will be used for scrolling through menus and well as in programming.
L	Key L – Enter Function (Menu Select)	Key L will be used to enter new values that have been changed in the programming modes.

LED	Description
Platen	IF the temperature is below set point the LED will be orange, if the temperature is between the set point and 79F LED will be green, if the temperature is set point plus 80F or higher the LED will be red If Platen is disabled LED will be off.
Back Grill	Will work in sequence with the other middle and front grill Heater LED’s. IF the temperature is below set point the LED will be orange, if the temperature is between the set point and 79F LED will be green, if the temperature is set point plus 80F or higher the LED will be red.
Middle Grill	Will work in sequence with the other middle and front grill Heater LED’s. IF the temperature is below set point the LED will be orange, if the temperature is between the set point and 79F LED will be green, if the temperature is set point plus 80F or higher the LED will be red.
Front Grill	Will work in sequence with the other middle and front grill Heater LED’s. IF the temperature is below set point the LED will be orange, if the temperature is between the set point and 79F LED will be green, if the temperature is set point plus 80F or higher the LED will be red.

ERROR MESSAGING

- Error messages were improved in this latest product release and have now actionable items.
- An error log feature will help technicians with up to 51 different error codes in the troubleshooting process.
- A maximum of 99 error instances can be saved in a non-volatile memory so the information can be read regardless the unit has been powered OFF.
- All new diagnostic features and error information is detailed in service manual.
- Results from latest successful calibration are saved in the Calibration Log under the Service Menu.
- Some examples of more common errors and actions are as follows:

Error Code#	Message on Screen	Possible Meaning	Action
Several	ERROR	Refer to Service Manual	1
21	OBSTRUCTION	Check for object under platen that could jam platen	1
34	ROOM TEMP LOW	Raise room temperature above 32 degrees F / 0 degrees C	2
35	ROOM TEMP HIGH	Lower room temperature to below 176 degrees F / 80 degrees C	2
36	NO IGNITION	Check gas gauge supply for gas models or electric power for electric models	2
Several	GRILL TOO HOT	Temperature high - Allow cool down	1
48	PROD. NOT RECOG	Check object on the grill - Clean grill	1
54	WRONG GRILL TYPE	Gas grill set to electric or viceversa - correct setting	2

Action to take :

1. Press Green button to recalibrate grill and see if error repeats. if error persist call for service near you area.
2. Turn main switch off and on.

OPERATION PROCEDURES

General Overview:

The grill controller will allow for 2 functions, both described in detail in the following sections



The **“Normal Operating Mode”**, also known as the Cook Mode is the mode used during normal cooking. In the normal operating mode, the operator can start a cook cycle, cancel a cook cycle, view actual temperatures, scroll to another menu item, and enter the Programming Mode.

The **“Programming Mode”** is the mode in which the operator can program the controller’s various settings. To enter the programming mode, PRESS and HOLD 

There are currently 3 methods of cooking that can be utilized with the 3 platen Garland clamshell:

Manual Mode Cooking – This is the cook method that utilizes a single gap setting for each menu item. The timer will count down according to the selected menu item.

Multi Stage Cooking – This method of cooking utilizes 2 different gap settings during the cook cycle. The timer will count down according to the selected menu item.

Automatic Mode Cooking (Product Recognition) – The Product Recognition (PR) method of cooking uses the magnetic switches mounted on the upper platen arm assembly to determine the product being cooked. Using the PR feature, the operator simply selects the  button on the controller. Select Automatic Mode; press and hold  button. This will allow the controller to know what product group to select from. When a cook cycle is initiated, the platen will come down and recognize the product being cooked. The cook timer will count down according to the time set for the recognized item. For more information on product Recognition, see the next section; “Product Recognition.”

OPERATION PROCEDURES

To turn the grill on:

The Main Power Switch – Controls power to the grill and must be turned ON to start operation. The controller displays will be active. Upon successful power up checks, the controllers will display “OFF”.

AM Operation – Release Material sheets MUST be ON at this time and the grill surface should be free and clear of carbon.

Once the grill controller displays “OFF” press . The grill controller will go to PREHEAT mode and default to AM preheat temperatures. To preheat to PM temperatures, press and hold .

AM PREHEAT	PM PREHEAT
375°F(190°C)Upper Platen	425°F (218°C) Upper Platen
275°F (135°C) Grill	350°F (177°C) Grill

Upon reaching the AM or PM set temperature (whichever is selected), the grill will stabilize in temperature for fifteen (15) minutes. Once this time has elapsed, the grill will autocalibrate. Upon completion of autocalibration, **the upper platens will raise** to there normal position, and the grill controller will display “READY”.

To Select a Menu item:

Scroll forward through the list of available menu items by pressing repeatedly. Scroll backward through the list of available menu items by pressing repeatedly.

Menu Item Library

The menu item library is loaded in the computer based upon the setting programmed in [CONFIGURE]->[GRILL REGION]. Each menu item consists of a function called [DISPLAY ACTIVE]. The settings in this function (AM, PM, AM/PM, No) determine what menu items are displayed when the button is pressed.

Menu Item	Display Active – Default
10:1 - CLAM	PM
4:1 - CLAM	PM
STRIP BACON - CLAM	AM/PM
SAUSAGE CLAM FZN	AM
MCRIB - CLAM	NO
STEAK - CLAM	AM/PM
GRILLED CHICKEN - FLAT	PM
FOLDED EGGS FLAT	AM
ROUND EGGS - FLAT	AM
CHICKEN FLAT BRD - FLAT	NO
10:1 FLAT	NO

4:1 - FLAT	NO
MCRIB - FLAT	NO
SAUSAGE FLAT FZN	NO
HOTCAKES - FLAT	NO
FOLDED EGGS CLAM	AM
ROUND EGGS CLAM	AM
3:1 ANGUS CLAM	PM
MUSHROOMS CLAM	AM/PM
OPT MENU 5 - CLAM	NO
OPT MENU 6 - CLAM	NO
OPT MENU 7 - CLAM	NO
OPT MENU 1 - FLAT	NO
OPT MENU 2 - FLAT	NO
OPT MENU 3 - FLAT	NO
OPT MENU 4 - FLAT	NO

Indicator Lights

The LED lights on the main control indicate the temperature status of each zone.

Electric grills have (4) zones per section , TOP, (platen), BACK GRILL, MIDDLE GRILL, and FRONT GRILL.

Gas grills have (2) zones per section , TOP, (platen), and BACK GRILL.

RED – The zone(s) is “TOO HOT” (more than 79°F/43°C over set temperature) OR a heat zone failure has occurred.

AMBER – The zone(s) is calling for heat.

GREEN – The zone(s) is at or above set temperature, but below 79°F/43°C over set temperature.

To enter the standby mode:



1. Press the button. The upper platen will lower, and in most cases the grill will maintain the grill set point of the last product cooked.

To Exit the standby Mode:

1. Press the GREEN or GREEN & BLACK) push-button(s). The upper platen will raise.

OPERATION PROCEDURES

To display the current temperatures:







- Press the  button and repeat for each zone to be displayed:
 - 1st key press – Front Set Point
 - 2nd key press – Front Actual
 - 3rd key press – Mid Set Point
 - 4th key press – Mid Actual
 - 5th key press – Back Set Point
 - 6th key press – Back Actual
 - 7th key press – Platen Set Point
 - 8th key press – Platen Actual
- Pressing and holding the  button for five (3) seconds will display all of the current temperatures at once.

T###	F###	T###	GAS
M###	B###	GAS	B###

ELECTRIC DISPLAY







GAS DISPLAY

Breakfast In Manual mode

- Select AM mode. Press and hold the  button.
- Select Manual mode. Press and hold the  button.
- Select a product from the AM product library using the  or  arrow buttons.
- Following McDonalds procedures for the item selected, load product on the grill.
- Press the  GREEN or ( GREEN &  BLACK) push-button(s) to initiate a cook cycle.
- Alarm will sound when the cook cycle is complete.
- Remove product and clean grill to prepare for the next cook cycle.

Lunch In Manual mode







Note: Switching from breakfast to lunch menu items will take approximately 10 minutes to heat to the appropriate temperatures.

- Select PM mode. Press and hold the  button.
- Select Manual mode. Press and hold the  button.
- Select a product from the PM product library using the  or  arrow buttons.
- Following the below lay pattern, load product on the grill.
- Press the  GREEN or ( GREEN &  BLACK) push-





button(s) to initiate a cook cycle.

- Alarm will sound when the cook cycle is complete
- Remove product and clean grill to prepare for next cook cycle.

To Change The Cook Time for a Menu Item





- Select AM or PM mode. Press and hold the  button.
- Select Manual mode. Press and hold the  button.
- Select a product using the  or  arrow buttons.
- PRESS the  button to display the cook time.
- Use the  and  buttons to change the cook time.
- The control will automatically default back to the normal operating mode after 3 seconds.

Breakfast In Auto mode

- Select AM mode. Press and hold the  button.
- Select Auto mode. Press and hold the  button. The control will display "AM / AUTOMATIC"
- Following McDonalds procedures for the item selected, load product on the grill.
- Press the  GREEN or ( GREEN &  BLACK) push-button(s) to initiate a cook cycle. The platen will lower, and recognize the product that has been loaded on the grill.
- Alarm will sound when the cook cycle is complete.
- Remove product and clean grill to prepare for the next cook cycle.

Lunch In Auto mode

Note: Switching from breakfast to lunch menu items will take approximately 10 minutes to heat to the appropriate temperatures.



- Select PM mode. Press and hold the  button.
- Select Auto mode. Press and hold the  button. The control will display "PM / AUTOMATIC."
- Following the lay patterns shown on the following page, load product on the grill.
- Press the  GREEN or ( GREEN &  BLACK) push-button(s) to initiate a cook cycle. The platen will lower, and recognize the product that has been loaded on the grill.

OPERATION PROCEDURES

5. Alarm will sound when the cook cycle is complete
6. Remove product and clean grill to prepare for next cook cycle.

Transition Cooking

Approximately 30 minutes before changing to the lunch menu, perform the following:

1. PRESS the  button (to display the upper platen temperature).
2. Press the  button.

3. The upper platen indicator will turn on. The upper platen will heat to 425 degrees F (217 degrees C) the platen will maintain this set temperature unless another menu item is selected.

To Shutdown Grill





Turn Main Power Switch OFF to disable all burners. For extended periods of shutdown, turn Main Power Switch OFF, close and disconnect main gas and/or electrical connections.

PRODUCT RECOGNITION

This Garland Clamshell grill is equipped with Product Recognition Controls (PRC) for McDonald's specified select products only. This new technology allows the user to simply start a cook cycle WITHOUT having to select a specific menu item. The PRC will recognize the product thickness by utilizing switches inside the upper platen and the magnets mounted on the platen arms. Once the PRC calculates the thickness of the product that's been loaded, it will look up product from the product range library (below), and automatically select that product. (The minimum and maximum values for applicable product are noted in the Factory Default Setting section near the end of this document.)

While cooking in Automatic Mode, the platen will lower and rest on the top of the product. The platen arms will continue to move in a downward motion performing various calculations to measure the thickness of the product that has been placed. In the event "**Product Not Recognized**" or the wrong product is recognized, perform a Auto Forced Calibration. Performing an Auto Force Calibration will reset the platen to the grill surface.

TO PERFORM AUTO FORCED CALIBRATION

1. PRESS and HOLD the  and  buttons together. The control will display "AUTO GAP FORCE - NO".
2. PRESS the  button. The "NO" will begin to flash.
3. PRESS the  button. The flashing "NO" will change to flashing "YES".
4. PRESS the  button. **The upper platen will immediately begin to lower and perform an auto calibration routine.**

COMMON PRODUCT RECOGNITION ISSUES

Product Recognition Errors can appear in 2 ways:

1. After initiating cook cycle, the controller displays "PRODUCT NOT RECOGNIZED - NO RECIPE FOUND".
2. The controller displays the incorrect product for the product that was layed on the grill.

In both cases, the most common reasons for these 2 issues are as follows:

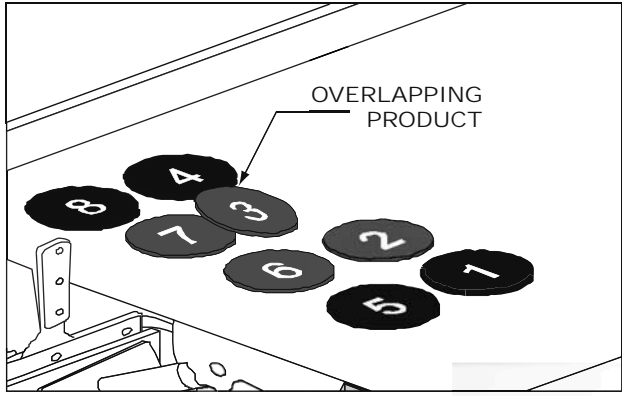
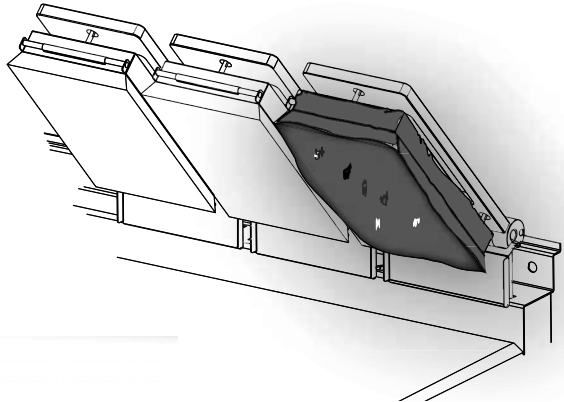
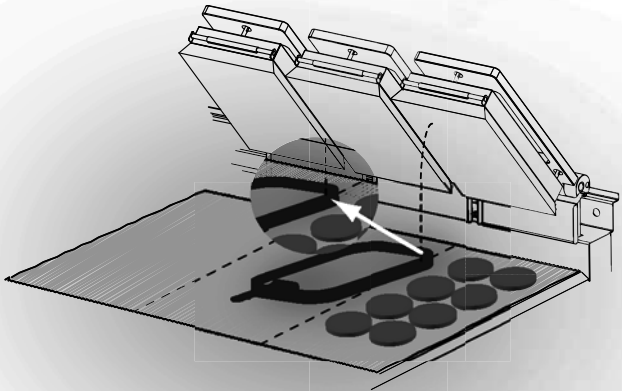
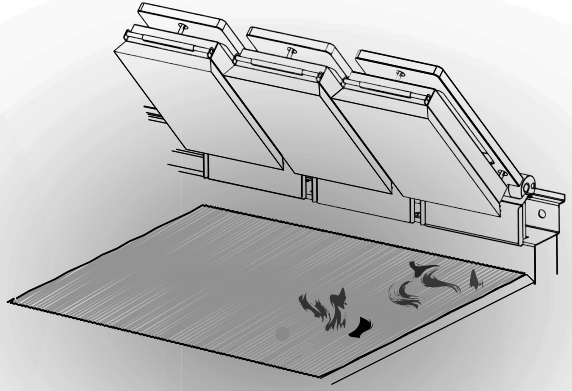
	
<p>Overlapping Product - Ensure that you do not have any patties overlapping when you lay product. This will fool the controller into thinking that there is much thicker product on the grill than there is.</p>	<p>Wrinkled or Worn Teflon Sheet - Ensure that the teflon sheet is installed and/or wrapped correctly to platen. A loose, worn, or teflon sheet with tears and/or scratches can effect product recognition</p>
	
<p>Platen makes contact with Chicken Ring - Always make sure that the chicken ring is clear of the adjacent platen prior to initiating a cook cycle.</p>	<p>Auto calibration done with carbon build up or product residue on grill surface - Ensure that the grill surface is free of any carbon build up. Debris on the grill surface during auto calibration will cause the control to mark the location of the grill surface incorrectly</p>

In any of the cases as outlined above or in any other event, perform a Forced Auto Calibration to reset the upper platen distance to the grill surface. Prior to performing a Forced Auto Calibration, be sure to:

1. Make sure the upper platen is free and clear of any carbon build up or debris.
2. Ensure that the grill surface is scraped and cleaned.
3. Teflon sheet should not be worn and be fitted to the upper platen tightly.

Perform a Forced Auto Calibration routine as indicated in section "PRODUCT RECOGNITION", "TO PERFORM FORCED AUTO CALIBRATION".

PATTY PLACEMENT

This procedure for placement and removal of meat products on the clamshell grill should be followed as indicated below and as follows:

1. Each gray rectangle depicted below represents one cooking area beneath one upper platen.
2. Patties are generally placed two at a time from front to back of grill and right to left.
3. The **removal order** of the patties is shown in the diagrams **by the number shown** in the center of each patty.

NOTE:

Patty placement procedures for International Markets may differ. Follow the recommendations of your local McDonald's authorities.

Maximum patty load per lane:

- 8 regular (10:1) patties
- 4 angus (3:1) patties (region and country applicable)
- 6 quarter-pound (4:1) patties
- 8 sausage patties
- 6 circular bacon

NOTE: Lay patties 2 at a time, from front to back:

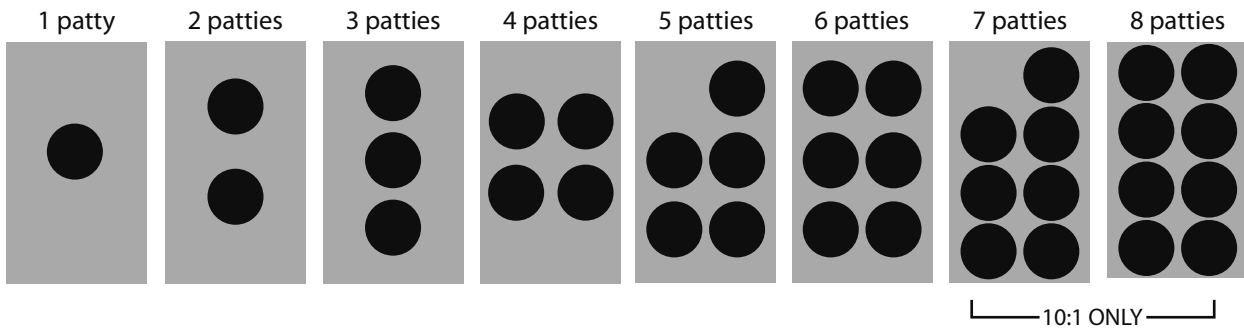

NOTE: Remove the patties in the number ordered shown below:

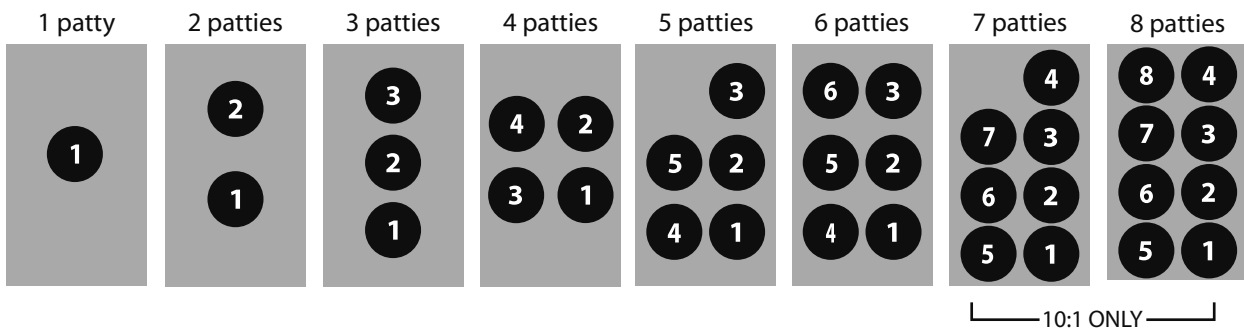

BEEF INTEGRITY

As shown in the previous page, lay product on the grill in the manner reflected. Product internal temperatures are taken on the corner patties.

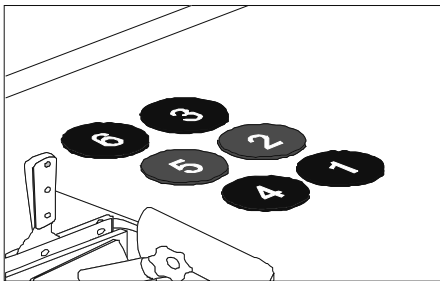
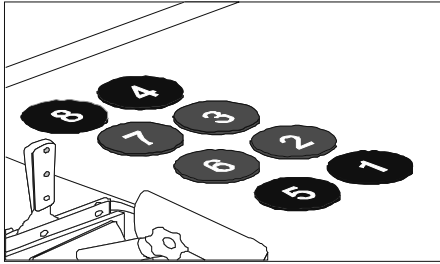

KEY NOTES:

- Full runs are always required when performing food safety
- Target removal times are 37 seconds for 10:1's & 107 seconds for 4:1's.
- Seasoning the patties must be done prior to removing the product from the grill..



Cooking grilled chicken utilizes various functions and settings within the controller to ensure proper temperature and integrity.

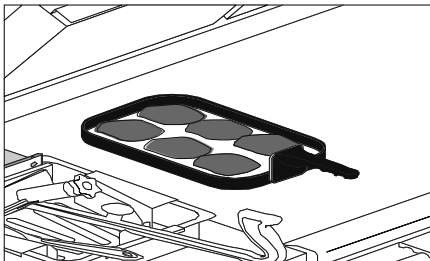

The use of a "Too Cool Flag" is programmed under Menu Item programming. The Too Cool Flag should be set to "ON" in Grilled Chicken & Mushrooms ONLY. In all remaining menu items, the "TOO COOL FLAG" should be turned off.

The "Too Cool Flag" is a function in the control that allows the grill operator to continue to cook approximately 1 additional run of product should the grill be in a "TOO COOL" state prior to the start of a cook cycle, or at the end of a cook cycle

10:1 Patties - Remove in 2 stacks of 4; Probe in center of corner patties (1, 4, 5, 8).	
	Step 1: Using a store calibrated pyrometer, probe the #1 patty (front right corner) in the center of the patty.
	Step 2: Using a store calibrated pyrometer, probe the #4 patty (rear right corner) in the center of the patty.
	Step 3: Using a store calibrated pyrometer, probe the #5 patty (front left corner) in the center of the patty.
	Step 4: Using a store calibrated pyrometer, probe the #8 patty (left rear corner) in the center of the patty.

4:1 Patties - Remove in 3 stacks of 2; Probe in center of corner patties (1, 2, 5, 6).	
	Step 1: Using a store calibrated pyrometer, probe the #1 patty (front right corner) in the center of the patty.
	Step 2: Using a store calibrated pyrometer, probe the #2 patty (rear right corner) in the center of the patty.
	Step 3: Using a store calibrated pyrometer, probe the #5 patty (front left corner) in the center of the patty.
	Step 4: Using a store calibrated pyrometer, probe the #6 patty (left rear corner) in the center of the patty.



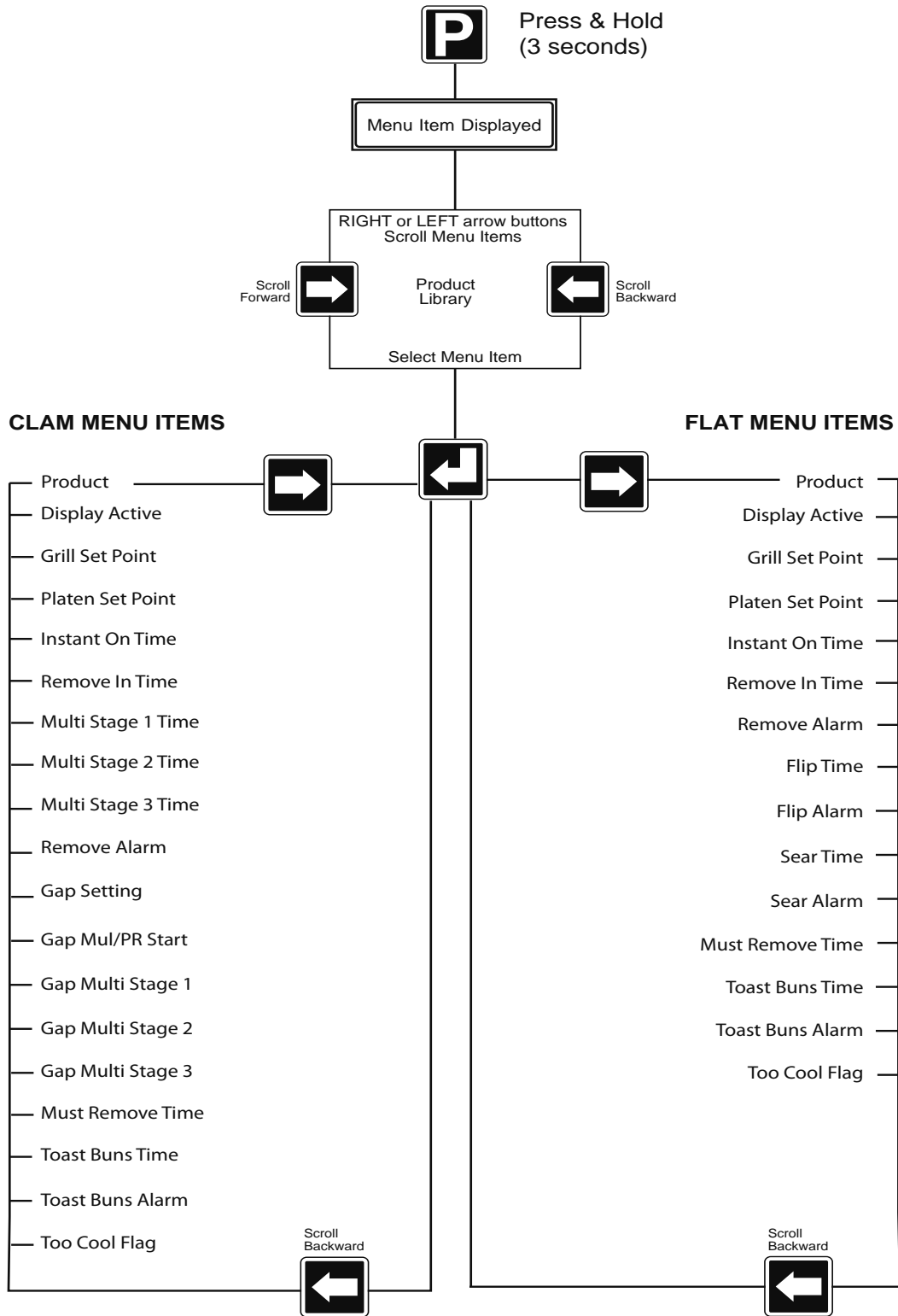



PROGRAM LOGIC TREE; PRODUCT MENU



CONTROL PROGRAMMING; PRODUCT MENU





Programming Modes; Product Menu

To change the name of an existing menu item

- Using the  or  button, select the menu item that requires a name change.
- PRESS and HOLD the  button for approximately 3 seconds. Controller will display previously selected menu item and its corresponding item number.
- PRESS and HOLD the  button.
- To spell out the product name:
 - Use the  or  arrow buttons to scroll through the character library.











Character Library:

space ! " # \$ % & ' () * + , - . / 0 1 2 3 4 5 6 7 8 9 ; : < = > ? @ A B C D E F G H
I J K L M N O P Q R S T U V W X Y Z [\] ^ _ ` a b c d e f g h i j k l m n o p q r
s t u v w x y z

- PRESS  or  to scroll right or left.
 - PRESS the  button to save the new menu item name.
- PRESS the  2X to exit and return to normal operating mode.











To activate / deactivate a menu item in the Normal Operating mode library, or change its day-part

(Defaults are listed in section "OPERATING PROCEDURES")

- PRESS and HOLD the  button for approximately 3 seconds. Controller will display previously selected menu item and its corresponding item number.
- Using the  or  arrow buttons, select the menu item that requires activation / deactivation.
- PRESS the  button. The controller will display "Product". The menu item will flash.
- PRESS the  or  arrow buttons until "Display Active" is displayed on the controller.
- PRESS the  button. The current setting will flash.
- PRESS the  or  button to select a different setting.
- PRESS the  button to save the new setting.
- PRESS the  2X to exit and return to normal operating mode.







To change the grill surface set point temperature

NOTE: Grill temperature set points are preset in the controller to the currently region required standard. Before any adjustment to the grill set point temperature consult McDonald's management office on your region. Garland grill set point temperature default on page 51





- Using the  or  arrow buttons, select the menu item that requires a temperature change.
- PRESS and HOLD the  button for approximately 3 seconds. Controller will display previously selected menu item and its corresponding item number.
- PRESS the  button. The controller will display "Product".
- PRESS the  or  arrow buttons until "Grill SetPt" is displayed on the controller.
- PRESS the  button. The current grill set temperature will begin to flash.
- Using the  or  button, change the temperature set point to the new desired temperature.
- PRESS the  button to save the new temperature set point.
- PRESS the  2X to exit and return to normal operating mode.

To change the grill upper platen set point temperature











NOTE: Grill temperature set points are preset in the controller to the currently required standard. You should not change this set point to any temperature other than what is shown in section "OPERATING PROCEDURES".

- Using the  or  button, select the menu item that requires a temperature change.
- PRESS and HOLD the  button for approximately 3 seconds. Controller will display previously selected menu item and its corresponding item number.
- PRESS the  button. The controller will display "Product".
- PRESS the  or  button until "Platen SetPt" is displayed on the controller.
- PRESS the  button. The "PLATEN SET POINT" will begin to flash.











CONTROL PROGRAMMING; PRODUCT MENU

6. Using the  or  button, change the temperature set point to the new desired temperature.
7. PRESS the  button to save the new temperature.
8. PRESS the  2X to return to normal operating mode.











To Change the INSTANT ON TIME

1. Using the  or  button, select the menu item that requires a cook time change.
2. PRESS and HOLD the  button for approximately 3 seconds. Controller will display previously selected menu item and its corresponding item number.
3. PRESS the  button. The controller will display "Product".
4. PRESS the  or  button until "INSTANT ON TIME" is displayed on the controller.
5. PRESS the  button. The seconds will begin to flash.
6. Using the  or  arrow buttons to change the INSTANT ON TIME to the new desired time.
7. PRESS the  button to save the new time.
8. PRESS the  2X to return to normal operating mode.











To Change the REMOVE IN TIME

1. Using the  or  button, select the menu item that requires a cook time change.
2. PRESS and HOLD the  button for approximately 3 seconds. Controller will display previously selected menu item and its corresponding item number.
3. PRESS the  button. The controller will display "Product".
4. PRESS the  or  button until "REMOVE IN TIME" is displayed on the controller.
5. PRESS the  button. The seconds will begin to flash.
6. Using the  or  arrow buttons to change the REMOVE IN TIME to the new desired time.
7. PRESS the  button to save the new time.
8. PRESS the  2X to return to normal operating mode.





To Change the MULTI STAGE TIME

1. Using the  or  button, select the menu item that requires a cook time change.
2. PRESS and HOLD the  button for approximately 3 seconds. Controller will display previously selected menu item and its corresponding item number.
3. PRESS the  button. The controller will display "Product".
4. PRESS the  or  button until "MULT STAGE(1,2 or3) TIME" is displayed on the controller.
5. PRESS the  button. The seconds will begin to flash.
6. Using the  or  arrow buttons to change the MULT STAGE TIME to the new desired time.
7. PRESS the  button to save the new time.
8. PRESS the  2X to return to normal operating mode.







To Change the REMOVE ALARM

1. Using the  or  button, select the menu item that requires a cook time change.
2. PRESS and HOLD the  button for approximately 3 seconds. Controller will display previously selected menu item and its corresponding item number.
3. PRESS the  button. The controller will display "Product".
4. PRESS the  or  button until "REMOVE ALARM" is displayed on the controller.
5. PRESS the  button. The seconds will begin to flash.
6. Using the  or  arrow buttons to change the REMOVE ALARM to the new desired option.
7. PRESS the  button to save the new time.
8. PRESS the  2X to return to normal operating mode.











To Change the GAP SETTING

1. Using the  or  button, select the menu item that requires a cook time change.
2. PRESS and HOLD the  button for approximately 3 seconds. Controller will display previously selected menu item and its corresponding item number.
3. PRESS the  button. The controller will display "Product".











CONTROL PROGRAMMING; PRODUCT MENU

- PRESS the  or  button until "GAP SETTING" is displayed on the controller.
- PRESS the  button. The seconds will begin to flash.
- Using the  or  arrow buttons to change the GAP SETTING to the new desired setting.
- PRESS the  button to save the new time.
- PRESS the  2X to return to normal operating mode.











To Change the GAP MUL/PR START

- Using the  or  button, select the menu item that requires a cook time change.
- PRESS and HOLD the  button for approximately 3 seconds. Controller will display previously selected menu item and its corresponding item number.
- PRESS the  button. The controller will display "Product".
- PRESS the  or  button until "GAP MUL/PR START" is displayed on the controller.
- PRESS the  button. The seconds will begin to flash.
- Using the  or  arrow buttons to change the GAP MUL/START to the new desired setting.
- PRESS the  button to save the new time.
- PRESS the  2X to return to normal operating mode.











To Change the GAP MULTI STAGE (1,2 or3)

- Using the  or  button, select the menu item that requires a cook time change.
- PRESS and HOLD the  button for approximately 3 seconds. Controller will display previously selected menu item and its corresponding item number.
- PRESS the  button. The controller will display "Product".
- PRESS the  or  button until "GAP MULTI STAGE (1,2 or 3)" is displayed on the controller.
- PRESS the  button. The seconds will begin to flash.
- Using the  or  arrow buttons to change the GAP MULTI STAGE to the new desired setting.
- PRESS the  button to save the new time.
- PRESS the  2X to return to normal operating mode.



To Change the MUST REMOVE IN

- Using the  or  button, select the menu item that requires a cook time change.
- PRESS and HOLD the  button for approximately 3 seconds. Controller will display previously selected menu item and its corresponding item number.
- PRESS the  button. The controller will display "Product".
- PRESS the  or  button until "MUST REMOVE IN" is displayed on the controller.
- PRESS the  button. The seconds will begin to flash.
- Using the  or  arrow buttons to change the MUST REMOVE IN to the new desired setting.
- PRESS the  button to save the new time.
- PRESS the  2X to return to normal operating mode.









To Change the TOAST BUNS TIME

- Using the  or  button, select the menu item that requires a cook time change.
- PRESS and HOLD the  button for approximately 3 seconds. Controller will display previously selected menu item and its corresponding item number.
- PRESS the  button. The controller will display "Product".
- PRESS the  or  button until "TOAST BUNS TIME" is displayed on the controller.
- PRESS the  button. The seconds will begin to flash.
- Using the  or  arrow buttons to change the TOAST BUNS TIME to the new desired setting.
- PRESS the  button to save the new time.
- PRESS the  2X to return to normal operating mode.











To Change the TOAST BUNS ALARM (Auto / Manual)

- Using the  or  button, select the menu item that requires a cook time change.
- PRESS and HOLD the  button for approximately 3 seconds. Controller will display previously selected menu item and its corresponding item number.







CONTROL PROGRAMMING; PRODUCT MENU





3. PRESS the  button. The controller will display "Product".
4. PRESS the  or  button until "TOAST BUNS ALARM" is displayed on the controller.
5. PRESS the  button. The seconds will begin to flash.
6. Using the  or  arrow buttons to change the TOAST BUNS ALARM to the new desired setting.
7. PRESS the  button to save the new time.
8. PRESS the  2X to return to normal operating mode.

To Change the TOO COOL FLAG











1. Using the  or  button, select the menu item that requires a cook time change.
2. PRESS and HOLD the  button for approximately 3 seconds. Controller will display previously selected menu item and its corresponding item number.
3. PRESS the  button. The controller will display "Product".
4. PRESS the  or  button until "TOO COOL FLAG" is displayed on the controller.
5. PRESS the  button. The seconds will begin to flash.
6. Using the  or  button, change the TOO COOL FLAG to the new desired setting.
7. PRESS the  button to save the new time.
8. PRESS the  2X to exit and return to normal operating mode.

To Change the FLIP TIME











1. Using the  or  arrow buttons, select the menu item that requires a cook time change.
2. PRESS and HOLD the  button for approximately 3 seconds. Controller will display previously selected menu item and its corresponding item number.
3. PRESS the  button. The controller will display "Product".
4. PRESS the  or  button until "FLIP TIME" is displayed on the controller.
5. PRESS the  button. The current setting will begin to flash.

6. Using the  or  arrow buttons to change the FLIP TIME to the new desired setting.
7. PRESS the  button to save the new setting.
8. PRESS the  2X to exit and return to normal operating mode.

To Change the FLIP ALARM

1. Using the  or  arrow buttons, select the menu item that requires a cook time change.
2. PRESS and HOLD the  button for approximately 3 seconds. Controller will display previously selected menu item and its corresponding item number.
3. PRESS the  button. The controller will display "Product".
4. PRESS the  or  button until "FLIP ALARM" is displayed on the controller.
5. PRESS the  button. The current setting will begin to flash.
6. Using the  or  arrow buttons to change the FLIP ALARM to the new desired setting.
7. PRESS the  button to save the new setting.
8. PRESS the  2X to exit and return to normal operating mode.

To Change the SEAR TIME

1. Using the  or  arrow buttons, select the menu item that requires a cook time change.
2. PRESS and HOLD the  button for approximately 3 seconds. Controller will display previously selected menu item and its corresponding item number.
3. PRESS the  button. The controller will display "Product".
4. PRESS the  or  button until "SEAR TIME" is displayed on the controller.
5. PRESS the  button. The current setting will begin to flash.
6. Using the  or  arrow buttons to change the SEAR TIME to the new desired setting.
7. PRESS the  button to save the new setting.

CONTROL PROGRAMMING; PRODUCT MENU

- PRESS the **⏏** 2X to exit and return to normal operating mode.

To Change the SEAR ALARM

- Using the **←** or **→** arrow buttons, select the menu item that requires a cook time change.
- PRESS and HOLD the **⏏** button for approximately 3 seconds. Controller will display previously selected menu item and its corresponding item number.
- PRESS the **⏏** button. The controller will display "Product".
- PRESS the **←** or **→** button until "SEAR ALARM" is displayed on the controller.
- PRESS the **⏏** button. The current setting will begin to flash.
- Using the **↑** or **↓** arrow buttons to change the SEAR ALARM to the new desired setting.
- PRESS the **⏏** button to save the new setting.
- PRESS the **⏏** 2X to exit and return to normal operating mode.

To Add NEW Menu Items

The following programming instructions serves as a GUIDE for programming the basic settings for CLAM menu items.

- PRESS and HOLD the **⏏** button for approximately 3 seconds. Controller will display previously selected menu item and its corresponding item number.
- PRESS the **←** or **→** button until "Opt menu # - CLAM" is displayed on the controller.
- PRESS the **⏏** button. The controller will display "PRODUCT"
- PRESS and HOLD the **⏏** button. The currently select menu item name will begin to flash.
- To spell out the product name:
 - Use the **↑** or **↓** arrow buttons to scroll through the character library.
 - PRESS **→** or **←** to scroll right or left.
 - PRESS the **⏏** button to save the new menu item name.
- PRESS the **⏏** button. "Display Active" will be displayed.
- PRESS the **⏏** button. "NO" will begin to flash.

- PRESS the **↑** button. "NO" will change to "YES".
- PRESS the **⏏** button to save the new setting.
- PRESS the **⏏** button. "GRILL SETPT" will be displayed.
- PRESS the **⏏** button. The temperature will begin to flash.
- Using the **↑** or **↓** button, change the temperature set point to the new desired temperature.
- PRESS the **⏏** button to save the new temperature set point.
- PRESS the **⏏** button. "PLATSETPT" will be displayed.
- PRESS the **⏏** button. The temperature will begin to flash.
- Using the **↑** or **↓** button, change the temperature set point to the new desired temperature.
- PRESS the **⏏** button to save the new temperature set point.
- PRESS the **⏏** button until "GAP MULTI/PR START" appears in the display.
- PRESS the **⏏** button. The gap setting will begin to flash.
- Using the **↑** and DOWN button, change the gap setting to the desired setting.
- PRESS the **⏏** button to save the new gap setting.
- PRESS the **⏏** button 2X to exit and return to the normal operating mode.

To activate Clean Mode

- Using the **←** or **→** arrow buttons, select clean mode.
- Wait until unit cool down to right temperature. Grill will start beep indicating right temperature to proceed with the cleaning.
- Wait until unit cool down to right temperature. Proceed with the cleaning.
- Press the **●** GREEN and proceed to follow cleaning procedures on [Cleaning & Maintenance](#) section from this manual.

PROGRAM LOGIC TREE; SYSTEM MENU

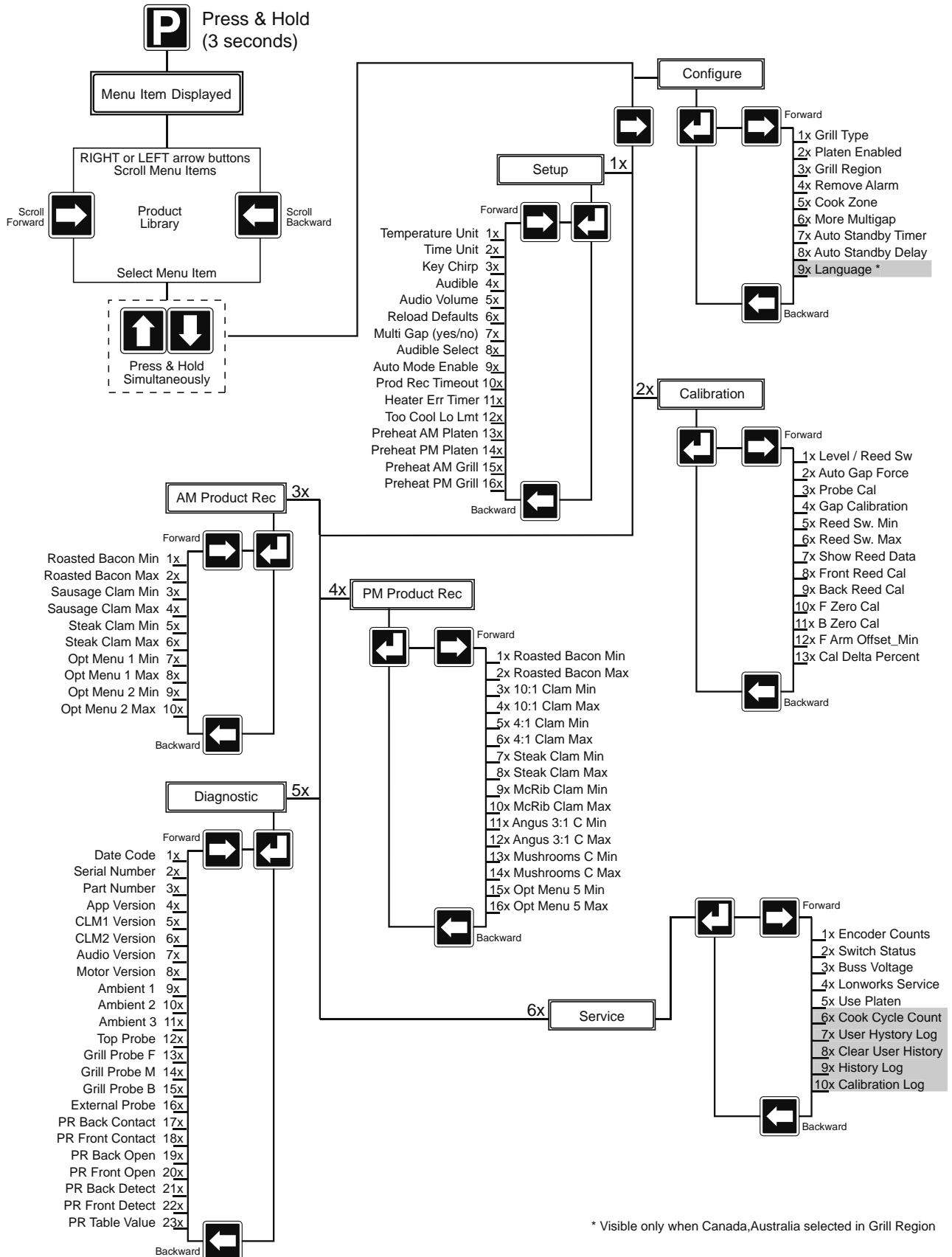











CONTROL PROGRAMMING; SYSTEM MENU

Programming Modes; System Setup







To Change the Temperature Display Units (Fahrenheit / Celcius)





The temperature display units (F or C) will change the way a temperature is displayed on the controller (F – Fahrenheit, C – Celcius)

1. With the controller display ON and either displaying the current menu item or displaying "OFF", PRESS and HOLD the  button for approximately 3 seconds. Controller will display previously selected menu item and its corresponding item number OR "Standby / Menu Item".
2. PRESS the  AND  arrow buttons TOGETHER. "CONFIGURE" will appear in the display.
3. PRESS the  arrow button. "Setup" will appear in the display
4. PRESS the  button. "Temperature Unit" will appear in the display.
5. PRESS the  button. The currently set temperature unit will flash.
6. PRESS the  OR  arrow buttons to change the flashing temperature unit.
7. PRESS the  button to save the new setting.
8. PRESS the  2X to exit the program mode.

To Change the Time Display Units

















Changing the Time Display Units will change the way timing cycles are displayed on the controller.



1. With the controller display ON and either displaying the current menu item or displaying "OFF", PRESS and HOLD the  button for approximately 3 seconds. Controller will display previously selected menu item and its corresponding item number OR "Standby / Menu Item".
2. PRESS the  AND  arrow buttons TOGETHER. "CONFIGURE" will appear in the display.
3. PRESS the  arrow button. "Setup" will appear in the display.
4. PRESS the  button. "Temperature Unit" will appear in the display.
5. PRESS the  1X. "Time Unit" will appear in the display.

6. PRESS the  button. The current time unit will flash.
7. PRESS the  OR  arrow buttons to change the flashing time unit.
For a complete listing of setup functions and their options, see section titled "FUNCTION OPTIONS; SYSTEM MENUS".
8. PRESS the  button to save the new setting
9. PRESS THE  2X to exit the program mode.

To change the Programming Standby Alarm

Turning ON the automatic alarm, will alert the operator to put the grill in standby.









1. With the controller display ON and either displaying the current menu item or displaying "OFF", PRESS and HOLD the  button for approximately 3 seconds. Controller will display previously selected menu item and its corresponding item number OR "Standby / Menu Item".
2. PRESS the  AND  arrow buttons TOGETHER for approximately three (3) seconds. "CONFIGURE" will appear in the display.
3. PRESS the  button.
4. PRESS the  or  button until "AUTO STANDBY TIMER" will appear in the display.
5. PRESS the  button. The current setting will begin to flash. Use the  or  button to turn ON /OFF the automatic alarm to alert the operator to put the grill in standby. Press the  button to save the new setting.
6. PRESS the  button until "AUTO STANDBY DELAY" is displayed. A number between 1 and 5 will be shown and this number represents the time delay in minutes until the standby alarm will sound. Go to step 6 to change the delay time or go to step 7 if the current setting is acceptable.
7. PRESS the  button. The current setting will begin to flash. Use the  or  button to change the delay time until the alarm will sound alerting operator to put grill in standby between 1 and 5 minutes. Press the  button to save the new setting.
8. PRESS the  2X to exit the program mode.

NOTE: When the alarm beeps (sounds), pressing the standby  button will silence the alarm and put the grill into standby. Pressing the green button  will only silence the alarm and reset the delay clock (it will not cause the grill to physically enter standby)

CONTROL PROGRAMMING; SYSTEM MENU





To change the Key Chirp (Yes / No)







Changing the Key Chirp On or Off will either turn on or off the sound of the controller when a button is pressed.

1. With the controller display ON and either displaying the current menu item or displaying "OFF", PRESS and HOLD the  button for approximately 3 seconds. Controller will display previously selected menu item and its corresponding item number OR "Standby / Menu Item".
2. PRESS the  AND  arrow buttons TOGETHER. "CONFIGURE" will appear in the display.
3. PRESS the  arrow button. "Setup" will appear in the display
4. PRESS the  button. "Temperature Unit" will appear in the display.
5. PRESS the  repeatedly until "Key Chirp" appears in the display.
6. PRESS the  button. The currently set Key Chirp will flash.
7. PRESS the  OR  arrow buttons to change the flashing "YES" or "NO"
8. PRESS the  button to save the new setting.
9. PRESS THE  2X to exit the program mode.

To change the Audible

Changing the Audible Sound will change the way the controller sounds when a timing cycle has completed its countdown.

1. With the controller display ON and either displaying the current menu item or displaying "OFF", PRESS and HOLD the  button for approximately 3 seconds. Controller will display previously selected menu item and its corresponding item number OR "Standby / Menu Item".
2. PRESS the  AND  arrow buttons TOGETHER. "CONFIGURE" will appear in the display.
3. PRESS the  arrow button. "Setup" will appear in the display
4. PRESS the  button. "Temperature Unit" will appear in the display.









5. PRESS the  repeatedly until "Audible" appears in the display.
6. PRESS the  button. The currently set Audible will flash.
7. PRESS the  OR  arrow buttons to change the flashing audible options.
For a complete listing of setup functions and their options, see section titled "FUNCTION OPTIONS; SYSTEM MENUS".
8. PRESS the  button to save the current setting.
9. PRESS THE  2X to exit the program mode.



WARNING,

The following procedure will result in replacing all actual setting on the grill (temperatures, cooking time and others), being reset to their factory setting defaults.

To Restore Factory Defaults for All Product Menu Items

1. With the controller display ON and either displaying the current menu item or displaying "OFF", PRESS and HOLD the  button for approximately 3 seconds. Controller will display previously selected menu item and its corresponding item number OR "Standby / Menu Item."
2. PRESS the  AND  arrow buttons TOGETHER. "CONFIGURE" will appear in the display.
3. PRESS the  arrow button. "Setup" will appear in the display
4. PRESS the  button. "Temperature Unit" will appear in the display.
5. PRESS the  button 6x. The controller will display "Reload Defaults – NO."
6. PRESS the  button. "NO" will begin to flash.
7. PRESS the  button. "NO" will change to "YES".
8. PRESS the  button. The system will Reload the MENU items to factory default settings.
9. Wait 15-20 seconds. The control then automatically returns to OFF mode.

FACTORY DEFAULT SETTING

Factory Default Setting - Product Menu - World

Menu #	PRODUCT	DIS-PLAY ACTIVE	GRILL SETPT.	PLATEN SP.	IN-START ON TIME (GAS)	RE-MOVE IN TIME	MULT STAGE 1 TIME	MULT STAGE 2 TIME	MULT STAGE 3 TIME	RE-MOVE 3 TIME ALARM	GAP SETTING	GAP MUL/PR START	GAP MULTI STAGE 1	GAP MULTI STAGE 2	GAP MULTI STAGE 3	FLIP TIME	FLIP ALARM	SEAR TIME	SEAR ALARM	MUST RE-MOVE IN	TOAST BUNS TIME	TOAST BUNS ALARM	TOO COOL FLAG	Hidden Value	
																								"PR Min"	"PR Max"
1	Off 10:1 CLAM (HIPD)	PM	350°F	425°F	25 (5)	37	5	0	0	AUTO	255	245	265	0	0	N/A	N/A	N/A	N/A	0	0	AUTO	NO	160	345
2	4:1 CLAM (HIPD)	PM	350°F	425°F	30 (10)	107	10	0	0	AUTO	415	400	425	0	0	N/A	N/A	N/A	N/A	0	0	AUTO	NO	365	499
3	ROAST BACON CLAM (HIPD)	AM/PM	350°F	425°F	0	70 (60)	0	0	0	AUTO	265	265	0	0	0	N/A	N/A	N/A	N/A	0	0	NONE	NO	1	130
4	SAUSAGE CLAM FZN (HIPD)	AM	350°F	425°F	0	82	0	0	0	AUTO	350	350	0	0	0	N/A	N/A	N/A	N/A	0	0	NONE	NO	210	405
5	MCRIB CLAM (HIPD)	NO	350°F	425°F	30 (10)	163	0	0	0	AUTO	530	530	0	0	0	N/A	N/A	N/A	N/A	0	0	NONE	NO	N/A	N/A
6	STEAK CLAM (HIPD)	AM	350°F	425°F	0	104	0	0	0	AUTO	415	415	0	0	0	N/A	N/A	N/A	N/A	0	0	NONE	YES	430	480
7	GRILL CHICK-FLAT	PM	350°F	425°F	45	475	N/A	N/A	N/A	N/A	N/A	N/A	N/A	N/A	N/A	225	MANU-AL	0	NONE	0	0	NONE	YES		
8	FOLDED EGGS FLAT	AM	265°F	OFF	0	120	N/A	N/A	N/A	N/A	N/A	N/A	N/A	N/A	N/A	0	NONE	0	NONE	0	0	NONE	YES		
9	ROUND EGGS FLAT	AM	265°F	OFF	0	150	N/A	N/A	N/A	N/A	N/A	N/A	N/A	N/A	N/A	0	NONE	0	NONE	0	0	NONE	NO		
10	CHIC F BRD FLAT	NO	350°F	425°F	0	100	N/A	N/A	N/A	N/A	N/A	N/A	N/A	N/A	N/A	0	NONE	0	NONE	0	0	NONE	NO		
11	10:1 FLAT	NO	340°F	425°F	0	125	N/A	N/A	N/A	N/A	N/A	N/A	N/A	N/A	N/A	75	AUTO	20	MANU-AL	0	0	NONE	NO		
12	4:1 FLAT	NO	365°F	425°F	0	270	N/A	N/A	N/A	N/A	N/A	N/A	N/A	N/A	N/A	150	AUTO	20	MANU-AL	0	0	NONE	NO		
13	MCRIB FLAT	NO	365°F	425°F	0	390	N/A	N/A	N/A	N/A	N/A	N/A	N/A	N/A	N/A	270	AUTO	0	NONE	0	0	NONE	NO		
14	SAUSAGE FLAT FZN	NO	365°F	425°F	0	270	N/A	N/A	N/A	N/A	N/A	N/A	N/A	N/A	N/A	150	MANU-AL	0	MANU-AL	0	0	NONE	NO		
15	HOTCAKES FLAT	NO	365°F	425°F	0	140	N/A	N/A	N/A	N/A	N/A	N/A	N/A	N/A	N/A	90	AUTO	0	NONE	0	0	NONE	NO		
16	OPT. MENU 1 CLAM (HIPD)	NO	OFF	OFF	0	0	0	0	0	AUTO	469	469	0	0	0	N/A	N/A	N/A	N/A	0	0	NONE	NO		
17	OPT. MENU 2 - CLAM (HIPD)	NO	OFF	OFF	0/0	0	0	0	0	AUTO	250	250	0	0	0	N/A	N/A	N/A	N/A	0	0	NONE	NO		
18	ANGUS 3:1 CLAM (HIPD)	PM	350°F	425°F	60 (30)	170	0	0	0	AUTO	534	534	0	0	0	N/A	N/A	N/A	N/A	0	0	NONE	NO	500	725
19	MUSHROOMS CLAM (HIPD)	AM/PM	350°F	425°F	60 (45)	104	0	0	0	AUTO	425	425	0	0	0	N/A	N/A	N/A	N/A	0	0	NONE	YES		
20	OPT. MENU 5 CLAM (HIPD)	NO	OFF	OFF	0	0	0	0	0	AUTO	250	250	0	0	0	N/A	N/A	N/A	N/A	0	0	NONE	NO		
21	OPT. MENU 6 CLAM (HIPD)	NO	OFF	OFF	0	0	0	0	0	AUTO	250	250	0	0	0	N/A	N/A	N/A	N/A	0	0	NONE	NO		
22	OPT. MENU 7 - CLAM (HIPD)	NO	OFF	OFF	0	0	0	0	0	AUTO	250	250	0	0	0	N/A	N/A	N/A	N/A	0	0	AUTO	NO		
23	FOLDED EGGS CLAM (HIPD)	NO	285°F	300°F	0	120	0	0	0	AUTO	625	625	0	0	0	N/A	N/A	N/A	N/A	0	0	NONE	NO		
24	ROUND EGGS CLAM (HIPD)	NO	285°F	300°F	0	150	0	0	0	AUTO	625	625	0	0	0	N/A	N/A	N/A	N/A	0	0	NONE	NO		
25	OPT. MENU 3 FLAT	NO	OFF	OFF	0	0	N/A	N/A	N/A	AUTO	N/A	N/A	N/A	N/A	N/A	0	AUTO	0	AUTO	0	0	NONE	NO		
26	OPT. MENU 4 FLAT	NO	OFF	OFF	0	0	N/A	N/A	N/A	AUTO	N/A	N/A	N/A	N/A	N/A	0	AUTO	0	MANU-AL	0	0	NONE	NO		
	CLEAN MODE (Not shown)	AM & PM	325°F	325°F						MANU-AL															

HIPD: means that this product will not be available to the operator if the platen is disabled

NOTE:

- All parameters can be accessed and edited by pressing the P key then using UP/Down/Right/Left/Enter keys.
- Values for Electric and Gas units are the same unless an extra value is specified in brackets () which corresponds to Gas.
- N/A means that this parameter is not applicable for this product and the menu will skip to the next available parameter
- When platen is disabled, the Platen Set Point will no longer be visible unless it is normally set to "Off". While the platen is enabled, the platen set point will remain "Off".
- The TOO COOL FLAG setting is not visible on gas grills
- The PR Values are not visible to the operator

Conversion Values:
 265°F = 129°C
 285°F = 140°C
 300°F = 149°C
 350°F = 177°C
 425°F = 218°C

FACTORY DEFAULT SETTING

Factory Default Setting - Product Menu - Canada, Australia & UK

CANADA PRODUCT MENU SETTING ONLY

Menu #	PRODUCT	ACTIVE	GRILL SETPT	PLATEN SETPT	INSTANT ON TIME	RE-MOVE IN TIME	MULT STAGE 1 TIME	MULT STAGE 2 TIME	MULT STAGE 3 TIME	RE-MOVE ALARM	GAP SETTING	GAP MUL/PR START	GAP MULTI STAGE 1	GAP MULTI STAGE 2	GAP MULTI STAGE 3	MUST RE-MOVE IN	TOAST BUNS TIME	TOAST BUNS ALARM	TOO COOL FLAG	PR Min	PR Max
	Off		NONE	NONE																	
1	10:1 CLAM (HIPD)	PM	350°F	425°F	25 (5)	37	5	0	0	AUTO	255	245	265	0	0	0	0	AUTO	NO	160	345
2	4:1 CLAM (HIPD)	PM	350°F	425°F	30 (10)	107	10	0	0	AUTO	415	400	425	0	0	0	0	AUTO	NO	365	529
18	3:1 ANGUS - CLAM (HIPD)	PM	350°F	425°F	60 (30)	190	0	0	0	AUTO	574	574	0	0	0	0	NONE	NONE	NO	530	750

UNITED KINGDOM (UK) PRODUCT MENU SETTINGS ONLY

Menu #	PRODUCT	ACTIVE	GRILL SETPT	PLATEN SETPT	INSTANT ON TIME (ELEC)	RE-MOVE IN TIME	MULT STAGE 1 TIME	MULT STAGE 2 TIME	MULT STAGE 3 TIME	RE-MOVE ALARM	GAP SETTING	GAP MUL/PR START	GAP MULTI STAGE 1	GAP MULTI STAGE 2	GAP MULTI STAGE 3	MUST RE-MOVE IN	TOAST BUNS TIME	TOAST BUNS ALARM	TOO COOL FLAG	PR Min	PR Max	
1	10:1 CLAM (HIPD)	PM	350°F	425°F	30 (10)	47	25	0	0	AUTO	245	240	245	0	0	0	20	22	AUTO	YES	160	345
2	4:1 CLAM (HIPD)	PM	350°F	425°F	30 (10)	114	10	70	0	AUTO	395	395	425	395	0	15	25	AUTO	YES	365	499	

PD: means that this product will not be available to the operator if the platen is disabled
 JTE:
 All parameters can accessed and edited by pressing the P key then using UP/Down/Right/Left/Enter keys.
 Values for Electric and Gas units are the same unless an extra value is specified in brackets () which corresponds to Gas.
 N/A means that this parameter is not applicable for this product and the menu will skip to the next available parameter.
 When platen is disabled, the Platen Set Point will no longer be visible unless it is normally set to "Off". While the platen is enabled, in this case, the platen set point will remain "Off".
 The TOO COOL FLAG setting is not visible on gas grills.
 The PR Values are not visible to the operator.

Conversion Values:
 265°F = 129°C
 285°F = 140°C
 300°F = 149°C
 350°F = 177°C
 425°F = 218°C

FACTORY DEFAULT SETTING

Factory Default Setting - Product Menu - Japan & Hong Kong

Menu #	PRODUCT	ACTIVE Edit (Pro-gram)	GRILL SETPT	PLATEN SETPT	INSTANT ON TIME (GAS)	REMOVE IN TIME	MULT STAGE 1 TIME	MULT STAGE 2 TIME	MULT STAGE 3 TIME	REMOVE ALARM	GAP SETTING	GAP MUJ/PR START	GAP MULTI STAGE 1	GAP MUJTI STAGE 2	GAP MULTI STAGE 3	FLIP TIME	FLIP ALARM	SEAR TIME	SEAR ALARM	MUST REMOVE IN	TOAST BUNS TIME	TOAST BUNS ALARM
1	Off 10:1 CLAM (HIPD)	PM	177C	218C	25 (5)	37	5	0	0	AUTO	255	245	265	0	0	N/A	N/A	N/A	N/A	18	0	AUTO
2	4:1 CLAM (HIPD)	PM	177C	218C	30 (10)	107	10	0	0	AUTO	415	400	425	0	0	N/A	N/A	N/A	N/A	15	0	NONE
3	SLICE BACON CLAM (HIPD)	NO	177C	218C	0	23	0	0	0	AUTO	89	89	0	0	0	N/A	N/A	N/A	N/A	0	0	NONE
4	SAUSAGE CLAM FZN (HIPD)	AM	177C	218C	0	82	0	0	0	AUTO	343	343	0	0	0	N/A	N/A	N/A	N/A	0	0	NONE
5	MCRIB CLAM (HIPD)	NO	177C	218C	30 (10)	163	0	0	0	AUTO	530	530	0	0	0	N/A	N/A	N/A	N/A	0	0	NONE
6	STEAK CLAM (HIPD)	NO	177C	218C	0	104	0	0	0	AUTO	415	415	0	0	0	N/A	N/A	N/A	N/A	0	0	NONE
7	GRILL CHICKEN FLAT	PM	177C	218C	45	410	N/A	N/A	N/A	AUTO	N/A	N/A	N/A	N/A	N/A	195	MANUAL	0	NONE	0	0	NONE
8	FOLDED EGGS FLAT	AM	129C	OFF	0	120	N/A	N/A	N/A	AUTO	N/A	N/A	N/A	N/A	N/A	0	NONE	0	NONE	0	0	NONE
9	ROUND EGGS FLAT	AM/PM	135C	OFF	0	135	N/A	N/A	N/A	MANUAL	N/A	N/A	N/A	N/A	N/A	0	NONE	0	NONE	0	0	NONE
10	CHIC F BRD FLAT	NO	177C	218C	0	100	N/A	N/A	N/A	AUTO	N/A	N/A	N/A	N/A	N/A	0	NONE	0	NONE	0	0	NONE
11	10:1 FLAT	NO	171C	218C	0	125	N/A	N/A	N/A	AUTO	N/A	N/A	N/A	N/A	N/A	75	AUTO	20	MANUAL	18	0	NONE
12	4:1 FLAT	NO	185C	218C	0	270	N/A	N/A	N/A	AUTO	N/A	N/A	N/A	N/A	N/A	150	AUTO	20	MANUAL	15	0	NONE
13	MCRIB FLAT	NO	185C	218C	0	390	N/A	N/A	N/A	AUTO	N/A	N/A	N/A	N/A	N/A	200	AUTO	0	NONE	0	0	NONE
14	SAUSAGE FLAT FZN	NO	185C	218C	0	270	N/A	N/A	N/A	AUTO	N/A	N/A	N/A	N/A	N/A	150	MANUAL	0	MANUAL	0	0	NONE
15	HOTCAKES FLAT	NO	185C	218C	0	140	N/A	N/A	N/A	AUTO	N/A	N/A	N/A	N/A	N/A	90	AUTO	0	NONE	0	0	NONE
16	OPT. MENU 1 CLAM (HIPD)	NO	OFF	OFF	0	0	0	0	0	AUTO	469	469	0	0	0	N/A	N/A	N/A	N/A	0	0	NONE
17	OPT. MENU 1 CLAM (HIPD)	NO	OFF	OFF	0	0	0	0	0	AUTO	250	250	0	0	0	N/A	N/A	N/A	N/A	0	0	NONE
18	ANGUS 3:1 CLAM (HIPD)	NO	177C	218C	60 (30)	230	0	0	0	AUTO	625	625	0	0	0	N/A	N/A	N/A	N/A	0	0	NONE
19	MUSHROOMS CLAM (HIPD)	NO	177C	218C	60 (45)	104	0	0	0	AUTO	415	415	0	0	0	N/A	N/A	N/A	N/A	0	0	NONE
20	HI TEMP TEST GRL	AM / PM	177C	218C	0	3599	0	0	0	AUTO	250	250	0	0	0	N/A	N/A	N/A	N/A	0	0	NONE
21	HI TEMP TEST PLT	AM / PM	177C	218	0	3599	0	0	0	AUTO	250	250	0	0	0	N/A	N/A	N/A	N/A	0	0	NONE
22	TERYAKI CLAM (HIPD)	PM	177C	218C	0	80	0	0	0	AUTO	366	366	0	0	0	N/A	N/A	N/A	N/A	0	0	NONE
23	FOLDED EGGS CLAM (HIPD)	NO	140°F	149°F	0	120	0	0	0	AUTO	625	625	N/A	N/A	N/A	0	0	0	AUTO	0	NONE	NONE
24	ROUND EGGS CLAM (HIPD)	NO	140°F	149°F	0	150	0	0	0	AUTO	625	625	N/A	N/A	N/A	0	0	0	NAUTO	0	NONE	NONE
25	OPT. MENU 3 FLAT	NO	OFF	OFF	0	0	N/A	N/A	N/A	AUTO	N/A	N/A	N/A	N/A	N/A	0	AUTO	0	AUTO	0	NONE	NONE
26	TERYAKI FLAT	NO	177C	OFF	0	180	N/A	N/A	N/A	AUTO	N/A	N/A	N/A	N/A	N/A	0	AUTO	0	MANUAL	0	NONE	NONE
27	"CLEAN MODE (Not visible)"	{AM &PM}	3259F	3259F						MANUAL												

Conversion Values:
 265° F = 129° C
 285° F = 140° C
 300° F = 149° C
 350° F = 177° C
 425° F = 218° C

HIPD : means that this product will not be available to the operator if the platen is disabled
 NOTE:
 • All parameters can be accessed and edited by pressing the P key then using UP/Down/Right/Left/Enter keys.
 • Values for Electric and Gas units are the same unless an extra value is specified in brackets () which corresponds to Gas.
 • N/A means that this parameter is not applicable for this product and the menu will skip to the next available parameter
 • When platen is disabled, the Platen Set Point will no longer be visible unless it is normally set to "OFF". While the platen is enabled, in this case, the platen set point will remain "OFF".
 • The TOO COOL FLAG setting is not visible on gas grills
 • The PR Values are not visible to the operator

DECLARATION OF CONFORMITY (CE Marked Models)

ALL MODELS:

THE ABOVE PRODUCT SERIES HAS BEEN DESIGNED AND MANUFACTURE IN ACCORDANCE WITH THE FOLLOWING DIRECTIVES AS APPLICABLE AND AMENDED, BASED ON THE LATEST AMENDED HARMONIZED STANDARD

2006/95/EEC	LOW VOLTAGE DIRECTIVE
EN60335-1	SAFETY OF HOUSEHOLD AND SIMILAR ELECTRICAL APPLIANCES

2004/108/EC	ELECTROMAGNETIC COMPATIBILITY DIRECTIVE
IEC/EN 61000-6-1:2007	EMC - IMMUNITY FOR RESIDENTIAL, COMMERCIAL AND LIGHT-INDUSTRIAL ENVIRONMENTS
IEC/EN 61000-6-3:2007	EMC - EMISSION STANDARD FOR RESIDENTIAL, COMMERCIAL AND LIGHT-INDUSTRIAL ENVIRONMENTS

THIS PRODUCT DOES NOT CONTAIN ASBESTOS. THE MATERIALS USED IN THE PRODUCTS NAMED ABOVE ARE SUITABLE FO CONTACT WITH FOOD IN ACCORDANCE WITH FRAMEWORK DIRECTIVE FOR FOOD CONTACT MATERIALS AND ARTICLES (89/109/EEC)

GAS MODELS:

THE FOLLOWING REQUIREMENTS AND TEST SPECIFICATIONS ARE CONSIDERED TO E A SUITABLE BASIS FOR DEMONSTRATING COMPLIANCE OF THE ABOVE PRODUCT(S) WITH THE ESSENTIAL REQUIREMENTS OF THE EUROPEAN GAS APPLIANCE DIRECTIVE (90/396/EEC)

EN 203-1:2005 + A1:2008; EN 203-2-9: 205; EN 437:2003 + A1:2009

IN ACCORDANCE WITH ESSENTIAL REQUIREMENT 2.2 IF ANNEX I OF THE EUROPEAN GAS APPLIANCE DIRECTIVE (90/396/EEC), WE GUARANTEE THAT THE MATERIALS USED IN THE ABOVE PRODUCTS ARE APPROPRIATE FOR THEIR INTENDED PURPOSE AND WILL WITHSTAND THE TECHNICAL, CHEMICAL AND THERMAL TO WHICH THEY WILL FORESEE ABLY BE SUBJECTED.

INSTALLATION OPERATION MANUAL HISTORY

Revision	page	Description	Date
Rev2	2	California statement added	July 5/13
	12	(Input Specifications, GAS Grills, North America: Gas Input) changed (Input Specifications, GAS Grills, Japan: Gas Input) box added	
	15	hood interlock & control power supply - Japan Only	
	9	Box (DELTA - 200 Volts Models) under (Total loads Kw / All) vertical, under (4530442) horizontal, was 0.4.	
	6	Rating plate informtion added	
	13	note added under 4523352 (Japan not included).	Sept 19/13
Rev3	15	dotted line deleted under Japan only sketch - bottom right side on the page	Sept 26/13
Rev4	49	Add PROGRAMMING STANDBY ALARM instruction	Feb 21/14
Rev5	18	<u>LonWork Information & Commissioning To Activate the grill onto the Lonworks network</u> remove from IOM - information remain in Service Manual.	Jan 30/15

INDEX

A

- Accessories Grill 27
- Auto Mode Breakfast 37
- Auto Mode Lunch 37

B

- Beef Integrity 41

C

- Casters Installation 14
- Cleaning 30
- Combustion Level 18
- Content 3
- Control Grill Description 34
- Cook Time Change 37

D

- Damage Shipping 4
- Declaration of Conformity 54

E

- Error Messaging 35
- Exhaust Hood 17
- Exit Standby Mode 36

F

- Factory Defaults 50
- Factory Default Setting 51
- Form Start Up 19,20

G

- Gas Input Specification 12

I

- Installation 13
- Items Included with Grill 13

M

- Maintenance 30
- Manual Mode Breakfast 37
- Manual Mode Lunch 37
- Mennekes Diagram 16

O

- Operation Procedures 35

P

- Patty Placement 40
- Photo Accessories 28
- Power Supply Connection 15
- Product Recognition 38
- Programming Menu 43

R

- Release Material Installation 26

S

- Safety 5
- Shutdown Grill 38
- Specification Gas 12
- Specification Mechanical 7,8
- Splash Shield Installation 25
- Start-Up 13
- System Menu 48
- System Menu Tree 42

T

- Temperature Display 37
- Temperature Probe Calibration 21
- Thermocouple Locations 24
- Turn Grill ON 36

V

- Vapor Shield Installation 27

W

- Warranty 4

 **Garland** Installation, Operation Manual



3-Platen Gas/Electric Clamshell Grills With Product Recognition

Manufactured Exclusively For McDonald's By
Garland Commercial Ranges
<http://www.garland-group.com>

