

Electric/Gas Dual Side Xpress Grill

Models:

XP(E/G)12

XP(E/G)24, XP(E/G)24-1(L/R)

XP(E/G)36, XP(E/G)36-2(L/R)

Installation, Operation and Maintenance Manual

Please read all sections of this manual and retain for future reference.

For your safety:

Post in a prominent location, instructions to be followed in the event the user smell gas. This information shall be obtained by consulting your local gas supplier.



XP(E/G)12 Shown



XP(E/G)24 Shown



XP(E/G)36 Shown

Original Instructions

Part #: GAR_IOM_ 4532522 Rev 08—6/17

THIS PAGE INTENTIONALLY LEFT BLANK

Safety Notices

DEFINITIONS

DANGER

Indicates a hazardous situation that, if not avoided, will result in death or serious injury. This applies to the most extreme situations.

Warning

Indicates a hazardous situation that, if not avoided, could result in death or serious injury.

Caution

Indicates a hazardous situation that, if not avoided, could result in minor or moderate injury.

Notice

Indicates information considered important, but not hazard-related (e.g. messages relating to property damage).

NOTE: Indicates useful, extra information about the procedure you are performing.

DISCLAIMERS

Warning

Only trained and authorized service personnel or store manager should access the service screens. If changes to these settings are made incorrectly they will cause the unit to malfunction.

Caution

Maintenance and servicing work other than cleaning as described in this manual must be done by an authorized service personnel.

DANGER

Do not install or operate equipment that has been misused, abused, neglected, damaged, or altered/modified from that of original manufactured specifications.

DANGER

All utility connections and fixtures must be maintained in accordance with local and national codes.

DANGER

It is the responsibility of the equipment owner to perform a Personal Protective Equipment Hazard Assessment to ensure adequate protection during maintenance procedures.

DANGER

The on-site supervisor is responsible for ensuring that operators are made aware of the inherent dangers of operating this equipment.

NOTE: Proper installation, care and maintenance are essential for maximum performance and trouble-free operation of your equipment. Visit our website www.mtwkitchencare.com for manual updates, translations, or contact information for service agents in your area.

Warning

Do Not Store Or Use Gasoline Or Other Flammable Vapors Or Liquids In The Vicinity Of This Or Any Other Appliance. Never use flammable oil soaked cloths or combustible cleaning solutions, for cleaning.

Warning

Do not store combustible materials on the appliance.

Warning

Warning labels mounted directly on the equipment must be observed at all times and kept in a fully legible condition.

Warning

Read this manual thoroughly before operating, installing or performing maintenance on the equipment. Failure to follow instructions in this manual can cause property damage, injury or death.

Warning

This appliance is not intended for use by persons (including children) with reduced physical, sensory or mental capabilities, or lack of experience and knowledge, unless they have been given supervision concerning use of the appliance by a person responsible for their safety. Do not allow children to play with this appliance.

Notice

Routine adjustments and maintenance procedures outlined in this manual are not covered by the warranty.

⚠ Warning

This product contains chemicals known to the State of California to cause cancer and/or birth defects or other reproductive harm. Operation, installation, and servicing of this product could expose you to airborne particles of glass-wool or ceramic fibers, crystalline silica, and/or carbon monoxide. Inhalation of airborne particles of glass-wool or ceramic fibers is known to the State of California to cause cancer. Inhalation of carbon monoxide is known to the State of California to cause birth defects or other reproductive harm.

LOCATION

⚠ Warning

Two or more people or a lifting device are required to lift this appliance.

⚠ Warning

To avoid instability the installation area must be capable of supporting the combined weight of the equipment and product. Additionally the equipment must be level side to side and front to back.

⚠ Warning

No structural material on the appliance should be altered or removed to accommodate placement of the appliance under a hood.

⚠ Warning

Be aware of the red mark in the threaded steem caster to indicated the maximum adjustment. Adjusting above the red mark could cause the caster to fail & the unit to tip. For more information see installation section 2.

⚠ Warning

The appliance must be isolated from the gas supply piping system by closing its individual manual shutoff valve during any pressure testing of the gas supply piping system at test pressures equal to or less than ½ psi (3.5 kPa).

⚠ Caution

This equipment must only be operated under an approved hood system in accordance with local regulations in force. This unit is intended for indoor use only.

ELECTRICAL

⚠ DANGER

Check all wiring connections, including factory terminals, before operation. Connections can become loose during shipment and installation.

⚠ DANGER

Do not operate any appliance with a damaged/pinched cord or plug. All repairs must be performed by a qualified service company.

⚠ DANGER

Failure to disconnect the power at the main power supply could result in serious injury or death. The power switch DOES NOT disconnect all incoming power.

⚠ DANGER

Copper wire suitable for at least 75°C (167°F) must be used for power connections.

⚠ Warning

This appliance must be grounded and all field wiring must conform to all applicable local and national codes. Refer to rating plate for proper voltage. It is the responsibility of the end user to provide the disconnect means to satisfy the authority having jurisdiction.

⚠ Warning

Do not use electrical appliances or accessories other than those supplied by the manufacturer.

⚠ Warning

This equipment must be positioned so that the plug is accessible unless other means for disconnection from the power supply (e.g., circuit breaker or disconnect switch) is provided.

⚠ Warning

Disconnect electric power at the main power disconnect for all equipment being serviced. Observe correct polarity of incoming line voltage. Incorrect polarity can lead to erratic operation.

⚠ Warning

Never touch anything that runs on electricity when your hands are wet.

CODE

Warning

Authorized Service Representatives are obligated to follow industry standard safety procedures, including, but not limited to, local/national regulations for disconnection / lock out / tag out procedures for all utilities including electric, gas, water and steam.

Warning

For an appliance equipped with casters, (1) the installation shall be made with a connector that complies with the Standard for *Connectors for Movable Gas Appliances ANSI Z21.69 • CSA 6.16*, and a quick-disconnect device that complies with the Standard for *Quick-Disconnect Devices for Use With Gas Fuel, ANSI Z21.41 • CSA 6.9*, (2) adequate means must be provided to limit the movement of the appliance without depending on the connector and the quick-disconnect device or its associated piping to limit the appliance movement and (3) the location(s) where the restraining means may be attached to the appliance shall be specified.

DAMAGE

DANGER

Improper installation, adjustment, alteration, service, or maintenance of this appliance or installation of a damaged appliance can result in DEATH, INJURY, EQUIPMENT DAMAGE, and void the warranty. NEVER install damaged appliances, equipment, or accessories. ALWAYS have installation and service performed by trained and authorized personnel.

Caution

Pouring water or ice on a hot heating elements/heated surfaces will cause damage..

Warning

Pinch Hazard. Keep hands and tools clear from the area above the platens when platens are in motion towards the exhaust hood. Be aware that adjacent platens may unexpectedly move at any time. "Turn Grill Off" at main switch when cleaning platens as there can be an unexpected movement of the platens

CLEARANCE

Caution

Do not block the supply and return air vents or the air space around the air vents. Keep plastic wrappings, paper, labels, etc. from being airborne and lodging in the vents. Failure to keep the air vents clear will result in unsatisfactory operation of the system.

Caution

Do not position the air intake vent near steam or heat exhaust of another appliance.

Warning

Slipping Hazard: Grease from food products will splatter. The areas surrounding the grill are a slipping hazard due to the splatter zone. Clean the area surrounding the grill regularly. The grill may be slippery. Ensure floor area is clean. Care needs to be taken as equipment may be hot.

Warning

Failure to maintain required clearances and additional distances as needed can result in INJURY and EQUIPMENT DAMAGE.

Consult manufacturers' literature, and sales and service agencies as needed.

DANGER

To reduce the risk of fire, the equipment is to be installed in non-combustible surroundings only, with no combustible material within 18" (457 mm) of the sides, front or rear of the appliance or within 40" (1 m) above the appliance. The appliance is to be mounted on floors of noncombustible construction with noncombustible flooring and surface finish and with no combustible material against the underside or on noncombustible slabs or arches and have no combustible material against the underside. Such construction shall in all cases extend not less than 12" (305 mm) beyond the equipment on all sides.

DANGER

Risk of fire/shock. All minimum clearances must be maintained. Do not obstruct vents or openings.

Warning

Pinch Hazard. Ensure a minimum of 1" clearance between the hood and the uppermost position of the platen arm. To reduce the risk of crushing injuries between platen & hood.

CLEANING

Caution

Ensure platens are down, in closed position, when moving grill. Follow the procedure to avoid potential damage, loss of calibration on the platen, and error messages.

Caution

Never use an acid based cleaning solution on exterior panels! Many food products have an acidic content, which can deteriorate the finish. Be sure to clean the stainless steel surfaces of ALL food products.

Caution

Do not use caustic cleaners on any part of the equipment or equipment cavity . Use mild, non abrasive soaps or detergents, applied with a sponge or soft cloth. Never use sharp implements or harsh abrasives on any part of the equipment.

Warning

When cleaning interior and exterior of unit, care should be taken to avoid front power switch and the power cord(s). Keep water and/or cleaning solutions away from these parts.

Warning

Turn grill off and unplug the unit before cleaning the side/back panels. Do not remove any panel during cleaning.

Warning

Interior cleaning must be performed by a qualified service technician only.

Warning

Never use a high-pressure water jet for cleaning or hose down or flood interior or exterior of units with water. Do not use power cleaning equipment, steel wool, scrapers or wire brushes on stainless steel or painted surfaces.

Caution

Use a commercial-grade cleaner formulated to effectively clean and sanitize food contact surfaces. Read the directions for use and precautionary statements before use. Particular attention must be paid to the concentration of cleaner and the length of time the cleaner remains on the food-contact surfaces.

Warning

Be aware that adjacent platens may unexpectedly move at any time. "Turn Grill Off" at main switch when cleaning platens as there can be an unexpected movement of the platens.

PERSONAL PROTECTION

DANGER

All utilities (gas, electric, water and steam) must be OFF to all equipment and locked out of operation according to OSHA approved practices during servicing. Always allow unit to cool.

DANGER

Use appropriate safety equipment during installation and servicing.

DANGER

Never stand on the unit! They are not designed to hold the weight of an adult, and may collapse or tip if misused in this manner.

DANGER

Keep power cord AWAY from HEATED surfaces. DO NOT immerse power cord or plug in water. DO NOT let power cord hang over edge of table or counter.

Warning

DO NOT use the unit for storage. DO NOT leave paper products, cooking utensils, or food in the unit when not in use.

Warning

Allow heated equipment to cool down before attempting to clean, service or move. Unit must be cool to touch and disconnected from power source.

Warning

Always wear some type of protective covering on your hands and arms when opening the unit.

Warning

Steam can cause serious burns. Always wear some type of protective covering on your hands and arms when opening the unit. When platen is Lifting, move away face and body from the escaping steam.

⚠ Warning

Remove all removable panels before lifting and installing.

⚠ Warning

Do not contact moving parts.

⚠ Warning

When using cleaning fluids or chemicals, rubber gloves and eye protection (and/or face shield) must be worn.

⚠ Warning

Use caution when handling all metal surface edges of the equipment.

⚠ Warning

This equipment is intended for indoor use only. Do not install or operate this equipment in outdoor areas.

⚠ Warning

All covers and access panels must be in place and properly secured, before operating this equipment.

⚠ Warning

Do not spray aerosols in the vicinity of this appliance while it is in operation.

⚠ Warning

Risk of burns from high temperatures. You may get burnt if you touch any of the parts during cooking. Surfaces close to the cooking surface including side panels may get hot enough to burn skin. Use extreme caution to avoid coming in contact with hot surfaces or hot grease. Wear personal protective equipment.

⚠ Warning

When checking for burner ignition or performance, do not get too close to the burners. Slow ignition can cause possible flashback, increasing the potential for facial and body burns.

⚠ Warning

This appliance must be installed with sufficient ventilation to prevent the occurrence of unacceptable concentrations of substances harmful to the health of personnel in the room in which it is installed.

⚠ Warning

Hazard. Keep hands and tools clear from the area above the platens when platens are in motion towards the exhaust hood. Be aware that adjacent platens may unexpectedly move at any time. "Turn Grill Off" at main switch when cleaning platens as there can be an unexpected movement of the platens.

⚠ Warning

Slipping Hazard: Grease cans must be properly installed before use. Improper installation will result in grease on the floor which will create a slipping hazard. Ensure grease cans are emptied and cleaned as needed to prevent grease from overflowing onto the floor. The grill may be slippery. Ensure floor area is clean. Care needs to be taken as equipment may be hot

⚠ Warning

Pinch Hazard. Keep hands and tools clear of area between platen and grill plate when platens are in motion. Be aware that adjacent platens may unexpectedly move at any time. "Turn Grill Off" at main switch when cleaning platens as there can be an unexpected movement of the platens.

⚠ Warning

Post in a prominent location, instructions to be followed in the event the user smell gas. This information shall be obtained by consulting your local gas supplier.

Table of Contents

Safety Notices

Definitions.....	3
Disclaimers.....	3
Location	4
Electrical	4
Damage.....	5
Clearance.....	5

Section 1 General Information

Read This Manual	10
Unit Inspection	10
Model Numbers	10
Serial Plate Numbers.....	10
Warranty Statement.....	11
Main Features and Components	12
Items included with the purchase of your new grill from manufacturer:.....	13
3 Platen Dimensions Specification	14
2 Platen Dimensions Specification	15
1 Platen Dimensions Specification	16
Electrical Input Specification - WYE (Electric models).....	17
Electrical Input Specification - DELTA (Electric models).....	18
Electrical Input Specification - WYE (gas XPG-12-CE models)	20
Electrical Input Specification - DELTA (gas XPG-12 models)	20
Electrical Input Specification - DELTA (electric XPE-24 models).....	20
Electrical Input Specification - WYE (gas XPG-24 CE models).....	21
Electrical Input Specification - DELTA (gas XPG-24 models)	21
Electrical Input Specification - DELTA (gas XPG-36 models)	22
Gas Input Specification.....	24
Determining Unit Configuration for Gas Grills:	24
Gas Elevations Settings	25
Conversion Labels:.....	28

Section 2 Installation

Removing Grill From Wood Crate.....	29
Transporting Grill To Location.....	30
Location	30
Clearance Requirements.....	30
Leveling.....	30
Exhaust Hood Requirements.....	30
Appliances Equipped with Casters	31
Casters Adjustment Procedure	31
Temporary Storage	32
Gas Connector Requirements:	32
National Codes Requirements:.....	33
Installation store responsibilities:	33
Restraining device installation Procedure	33
“Desi Pak” bags from the grill:	34
Removing “Desi Pak” bags from the grill:	34
Gas Connections, and Pipe Sizing:	34
Flue Upper Rear Panel Install Instruction.....	36
Startup Procedure	38

Section 3

Operation

Sequence of Operation	39
easyToUCH™ Controller	40
Home Screen, Recipe Selector Screen & Icons	40
On Screen Warnings and Alerts Messages	41
Operations Overview	41
easyTOUCH™ Procedures	42
Start Up & Preheat	42
Cook A Recipe	42
Check Temperatures	43
Canceling a Cook Cycle	43
Change Cook Time/Gap	43
Create New Recipe	44
setting up for 2 stage cooking, “add cheese”	46
Create a New Menu	47
Turn Menus OFF or ON	47
Activate Sleep Mode Manually	48
Shutdown	48
Cleaning Reminders	48
Special Settings — Time & Gap Adjustment Limits	49
Volume Adjustment	49
Hood Height Adjustment	50
Language Selection	50
Clean Settings	51

Section 4

Maintenance

Cleaning the easyToUCH™ controller	54
Cleaning the Stainless Steel Panels	54
Cleaning During Operation	54
Daily Cleaning	55
Moving the Grill	58

Section 5

Troubleshooting

Cooking Issues	59
Undercooked product	59
Undercooked product only at front of grill	59
Overcooked product	59
Temperature Issues	60
Grill or platen too hot	60
Grill or platen too cool	60
Unable to reach or maintain temperature	60
User Interface Issues	60
No sound	60
Screen locked out, frozen, non-responsive to touch	60
Touch screen rebooting	60
Unable to read USB	60
Unable to load USB files	60

Section 6

Tools & Cleaning Supplies

Recommended Cleaning Supplies	61
--	-----------

Section 1

General Information

Read This Manual

Garland Commercial Equipment developed this manual as a reference guide for the owner/operator and installer of this equipment. Please read this manual before installation or operation of the machine. A qualified service technician must perform installation and start-up of this equipment, consult Section 5 within this manual for troubleshooting service assistance.

If you cannot correct the service problem, call your Service Agent or Distributor. Always have your model and serial number available when you call.

Your Service Agent _____
 Service Agent Telephone Number _____
 Your Local Distributor _____
 Distributor Telephone Number _____
 Model Number _____
 Serial Number _____
 Installation Date _____

Unit Inspection

Thoroughly inspect the unit upon delivery. Immediately report any damage that occurred during transportation to the delivery carrier. Request a written inspection report from a claims inspector to document any necessary claim

Model Numbers

This manual covers the following models:

XP(E/G)12
 XP(E/G)24, XP(E/G)24-1(L/R)
 XP(E/G)36, XP(E/G)36-1(L/R), XP(E/G)36-2(L/R)

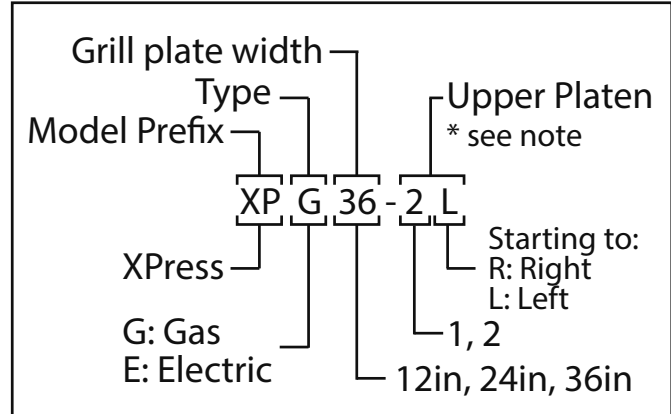

* Suffix not used if all platens included

Serial Plate Numbers

The serial plate is affixed to the lower left corner of the right panel and a serial sticker on front edge of the chassis. Important information such as the unit's model number, serial number, and electrical/gas specifications can be found on the serial plate. Serial plate is located in manual covers the following models:

SER		PLN. N.D.I.		GAS	
MOD.		CAT.		INLET PRESSURE PRESSION	mbar
ITEM				SET PRESSURE CALIBRATION DE PRESSION	mbar
ARTICLE		COUNTRY PAYS		CALIBRATION DE PRESSION	Qn:
ARTICULO				INJECTOR SIZE DIMENSION DES INJECTEURS/ DE INYECTORES	⊕
Catering Equipment / Equipement pour Cuisine / Equipo para Cocinar / TYPE A / TIPO A					
FOR INSTALLATION WITH THE FOLLOWING MINIMUM CLEARANCE POUR INSTALLATION AVEC LES DISTANCES MINIMUM ESTA UNIDAD PUEDE SER INSTALADA CON SEPARACION MINIMA DE					
COMBUSTIBLE	SIDE COTES COSTADOS	BACK ARRIERE ATRAS	FLOOR PLANCHER PISO	CE	RATED VOLTAGE TENSION VOLTAJE
NON COMBUSTIBLE	mm	mm	mm	1312	FUSE RATING FUSIBLE
4518493 REV.4 GARLAND COMMERCIAL RANGES LTD., MISSISSAUGA, ONT., CANADA					INPUT ENERGIE CAPACIDAD
					50/60 Hz

SERIAL NUMBER PLATE - SAMPLE ONLY



LIMITED WARRANTY FOR COMMERCIAL PRODUCTS - CLAMSHELL GRILL

(U.S.A & Canada)

LIMITED WARRANTY

Garland Commercial Ranges Limited ("Garland") warrants this product to be free from defects in material and workmanship for a period of two (2) year from the date the product is installed or thirty (30) months from the date of shipment unless stated otherwise for specific models or product lines from our factory, whichever comes first.

This warranty covers defects in material and workmanship under normal use providing that:

- the equipment has not been accidentally or intentionally damaged, altered or misused.
- the equipment is properly installed, adjusted, operated and maintained in accordance with national and local codes and in accordance with the installation instructions and operations manual provided with this product.
- the warranty serial number affixed to the appliance by Garland has not been defaced, obliterated or removed.
- an acceptable report for any claim under this warranty is supplied to Garland.

Garland recommends a Preventive Maintenance Program which is essential to extend the life of equipment.

During the warranty period, Garland shall repair or, at Garland's option, replace parts determined by Garland to be defective in material or workmanship, and with respect to services, shall re-perform any defective portion of said services.

The foregoing shall be the sole obligation of Garland under this Limited Warranty with respect to the equipment, products and services. With respect to equipment, materials, parts and accessories manufactured by others, Garland's sole obligation shall be to use reasonable efforts to obtain the full benefit of the manufacturers' warranties. Garland shall have no liability, whether in contract, tort, negligence, or otherwise, with respect to non-Garland manufactured products.

WHO IS COVERED

This Limited Warranty is available only to the original purchaser of the product and is not transferable.

EXCLUSIONS FROM COVERAGE

- Repair or replacement of parts required because of misuse, improper care or storage, negligence, alteration, accident, use of incompatible supplies or lack of specified maintenance shall be excluded.
- Do not remove any permanently affixed labels, warnings or data plates from the appliance as this may invalidate the Garland warranty.
- Normal maintenance items, including but not limited to, teflon sheets, gaskets, O-rings, seals, interior and exterior finishes, lubrication, broken glass, etc.
- Failures caused by erratic voltages or gas supplies.
- Travel costs beyond 100 miles in the USA and 150 km in Canada, or two (2) hours, travel other than overland, overtime, holiday charges, and any special arrangements.
- Improper or unauthorized repair.
- Changes in adjustment and calibration after ninety (90) days from equipment installation date.
- This Limited Warranty will not apply to any parts subject to damage beyond the control of Garland, or to equipment which has been subject to alteration, misuse or improper installation, accidents, damage in shipment, fire, floods, power changes, other hazards or acts of God that are beyond the control of Garland.

- This Limited Warranty does not apply, and shall not cover any products or equipment manufactured or sold by Garland when such products or commercial equipment is installed or used in a residential or non-commercial application. Installations not within the applicable building or fire codes render this Limited Warranty and any responsibility or obligations associated therein null and void. This includes any damage, costs or legal actions resulting from the installation of any Garland manufactured commercial cooking or warming equipment in a non-commercial application or installation, where the equipment is being used for applications other than those approved for by Garland.
- With respect to equipment, materials, parts and accessories manufactured by others, Garland's sole obligation shall be to use reasonable efforts to obtain the full benefit of the manufacturers' warranties. Garland shall have no liability, whether in contract, tort, negligence, or otherwise, with respect to non-Garland manufactured products.

LIMITATIONS OF LIABILITY

The preceding paragraphs set forth the exclusive remedy for all claims based on failure of, or defect in, products or services sold hereunder, whether the failure or defect arises before or during the warranty period, and whether a claim, however instituted, is based on contract, indemnity, warranty, tort (including negligence), strict liability, implied by statute, common-law or otherwise. Garland, its servants and agents shall not be liable for any claims for personal injuries or consequential damages or loss, howsoever caused. Upon the expiration of the warranty period, all such liability shall terminate. THE FOREGOING WARRANTIES ARE EXCLUSIVE AND IN LIEU OF ALL OTHER WARRANTIES, WHETHER WRITTEN, ORAL, IMPLIED OR STATUTORY. NO IMPLIED WARRANTY OF MERCHANTABILITY OR FITNESS FOR PARTICULAR PURPOSE SHALL APPLY. GARLAND DOES NOT WARRANT ANY PRODUCTS OR SERVICES OF OTHERS.

REMEDIES

The liability of Garland for breach of any warranty obligation hereunder is limited to: (i) the repair or replacement of the equipment on which the liability is based, or with respect to services, re-performance of the services; or (ii) at Garland's option, the refund of the amount paid for said equipment or services.

Any breach by Garland with respect to any item or unit of equipment or services shall be deemed a breach with respect to that item or unit or service only.

WARRANTY CLAIM PROCEDURE

Customer shall be responsible to:

- Immediately advise the Dealer or Garland Factory Authorized Service Agency of the equipment serial number and the nature of the problem. For a list of authorized service agents, please refer to the Garland web site at www.garland-group.com
- Verify the problem is a factory responsibility. Improper installation, gas adjustments or misuse of equipment are not covered under this Limited Warranty.
- Cooperate with the Service Agency so that warranty service may be completed during normal working hours.
- Submit sufficient documentation on a timely manner for reimbursement.

GOVERNING LAW

For equipment, products and services sold in Canada this Limited Warranty shall be governed by the laws of the province of Ontario, Canada; otherwise this Limited Warranty shall be governed by the laws of the state of Delaware, U.S.A., excluding their conflicts of law principles. The United Nations Convention on Contracts for the International Sale of Goods is hereby excluded in its entirety from application to this Limited Warranty.

Garland Commercial Ranges Ltd.

1177 Kamato Road, Mississauga,
Ontario, Canada L4W 1X4

Part # 4602161 Rev. 0 (May 13/16)

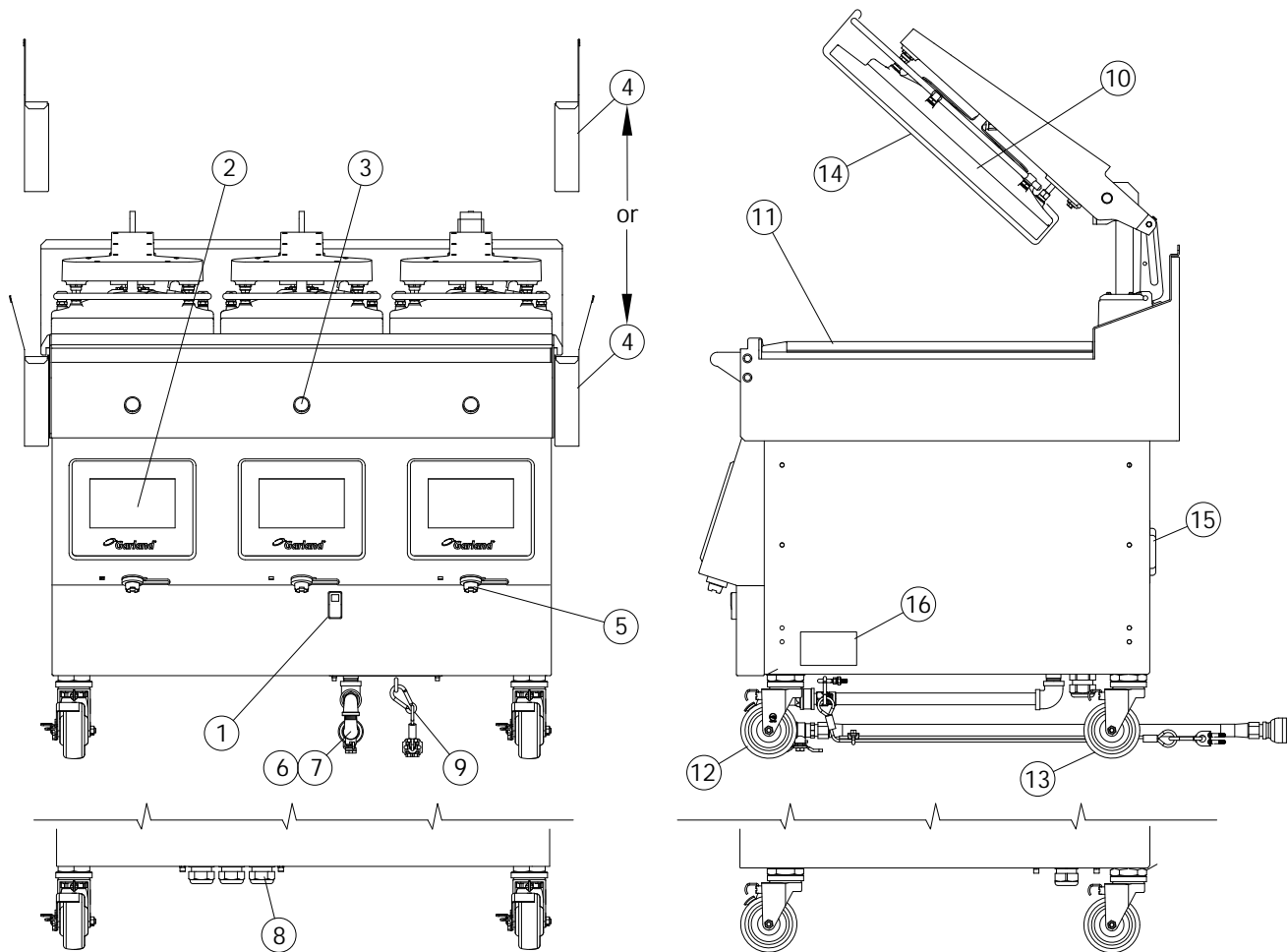

Main Features and Components

1. On/Off Power Switch.
2. easyToUCH™ Touch sensitive controls for easy operation.
3. Green Push Button.
 - press to start cook.
 - press and hold to abort.
4. Grease Buckets.
 - with straight sides to save space.
 - with flared sides to accommodate optional tool holders.
5. USB Ports - for easyToUCH.
6. Incoming gas manifold (gas models only).
7. Main gas shut off (gas models only). Supply with optional flexible hose connection assembly.
8. Main Electric Power Cables and Plugs.
9. Restraining device assembly (gas models only)
10. Platen - providing double-side cooking. Each platen can be controlled separately.
11. Grill Plate - cooking surface with three (3) Independently controlled heaters per cook zones.
12. Front Casters - height adjustable swivel casters, with brakes and swivel lock pins.
13. Rear Casters - height adjustable swivel casters and swivel lock pins (without brakes).
14. Release Material Sheet - non-stick surface for case of operation and cleaning.
15. Circuit Breaker(s)
16. Rating Plate location. - Important information such as the unit's model number, serial number, and electrical specifications can be found on the serial plate.

Note: Serial number also can be found in the control in the "Diagnostic Menu" in the "Revision" screen.

Items included with the purchase of your new grill from manufacturer:

- Each 1 platen gas & electric grill includes the following items;

1 PLATEN		
Part #	Description	Qty
4527294	Release Material Sheet Clips	3
4600722	Release Material Sheet Hanger	1
4600866	Release Material Sheet (box)	1
4600207	Grease Drawer Slide LT - GM	1
4600208	Grease Drawer Slide RT - GM	1
1838701	Platen Levelling Tool	1
4532089	Service Wrench	1
4601665	Garland Grill Start Up Form	1
4532522	Installation Operation Manual	1

4601358	Grease Buckets - right side straight	1
4601357	Grease Buckets - left side straight	1
OR		
4601443	Grease Buckets - right side flared	1
4601442	Grease Buckets - left side flared	1

NOTE: Quantity may vary according to the model.

- Each 2 platen gas & electric grill includes the following items;

2 PLATEN		
Part #	Description	Qty
4527294	Release Material Sheet Clips	6
4600722	Release Material Sheet Hanger	2
4600866	Release Material Sheet (box)	1
4600207	Grease Drawer Slide LT - GM	1
4600208	Grease Drawer Slide RT - GM	1
1838701	Platen Levelling Tool	1
4532089	Service Wrench	1
4601665	Garland Grill Start Up Form	1
4532522	Installation Operation Manual	1

4601358	Grease Buckets - right side straight	1
4601357	Grease Buckets - left side straight	1
OR		
4601443	Grease Buckets - right side flared	1
4601442	Grease Buckets - left side flared	1

NOTE: Quantity may vary according to the model.

- One Grill 3 platen gas & electric included the following list, except countries mentioned

3 PLATEN		
Part #	Description	Qty
4527294	Release Material Sheet Clips	9
4600722	Release Material Sheet Hanger	3
4600866	Release Material Sheet (box)	1
4600207	Grease Drawer Slide LT - GM	1
4600208	Grease Drawer Slide RT - GM	1
1838701	Platen Levelling Tool	1
4532089	Service Wrench	1
4601665	Garland Grill Start Up Form	1
4532522	Installation Operation Manual	1

4601358	Grease Buckets - right side straight	1
4601357	Grease Buckets - left side straight	1
OR		
4601443	Grease Buckets - right side flared	1
4601442	Grease Buckets - left side flared	1

NOTE: Quantity may vary according to the model.

Items NOT INCLUDED from the manufacturer:

- Any electrical cords needed for application (optional).
- Flexible gas hoses with shut off valve and restrain cable kit (gas models only) - (optional).
- Tool holder for spatula, scraper and wiper that integrate with flared grease buckets (optional).

THE FOLLOWING INSTALLATION PROCEDURE CAN BE PERFORMED BY:

- A factory authorized service center
- An installation person approved by Garland.
- A licensed installer contracted by purchaser of grill. Contact local Garland Factory Authorized Service Center for more details.

CAUTION:

PRIOR TO INSTALLATION, CHECK THE ELECTRICAL SUPPLY TO ENSURE INPUT VOLTAGE AND PHASE MATCH THE EQUIPMENT VOLTAGE RATING AND PHASE. MANY LOCAL CODES EXIST, IT IS THE RESPONSIBILITY OF THE OWNER/INSTALLER TO COMPLY WITH THESE CODES.

CAUTION (FOR GAS GRILLS):

PRIOR TO INSTALLATION, CHECK THAT THE GAS TYPE AVAILABLE MATCHES THE GAS TYPE LISTED ON THE RATING PLATE. MANY LOCAL CODES EXIST, IT IS THE RESPONSIBILITY OF THE OWNER/INSTALLER TO COMPLY WITH THESE CODES.

3 Platen Dimensions Specification

Dimensions: model: XP(E/G)36

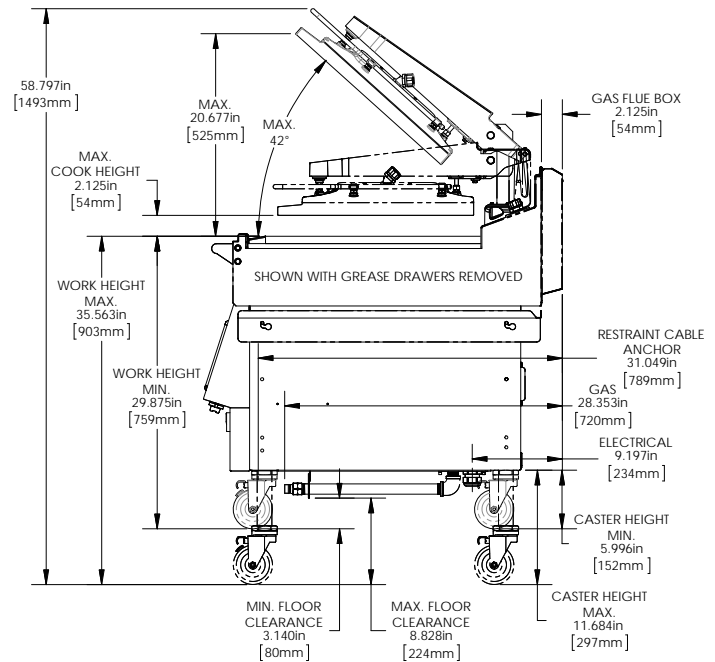
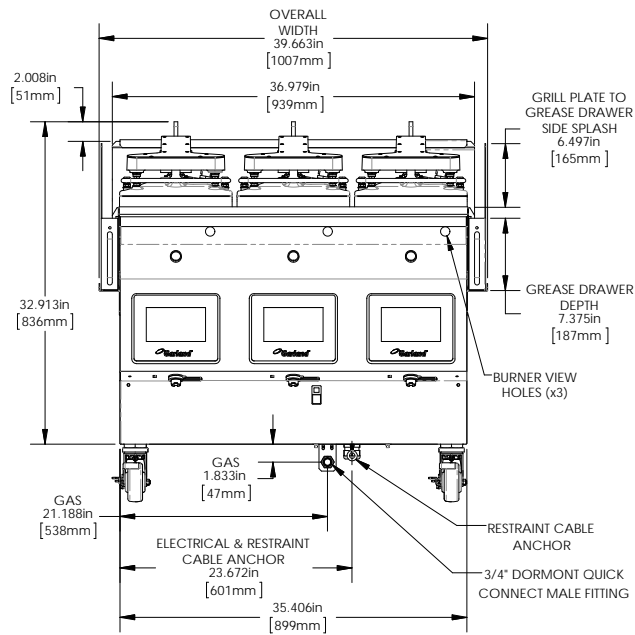
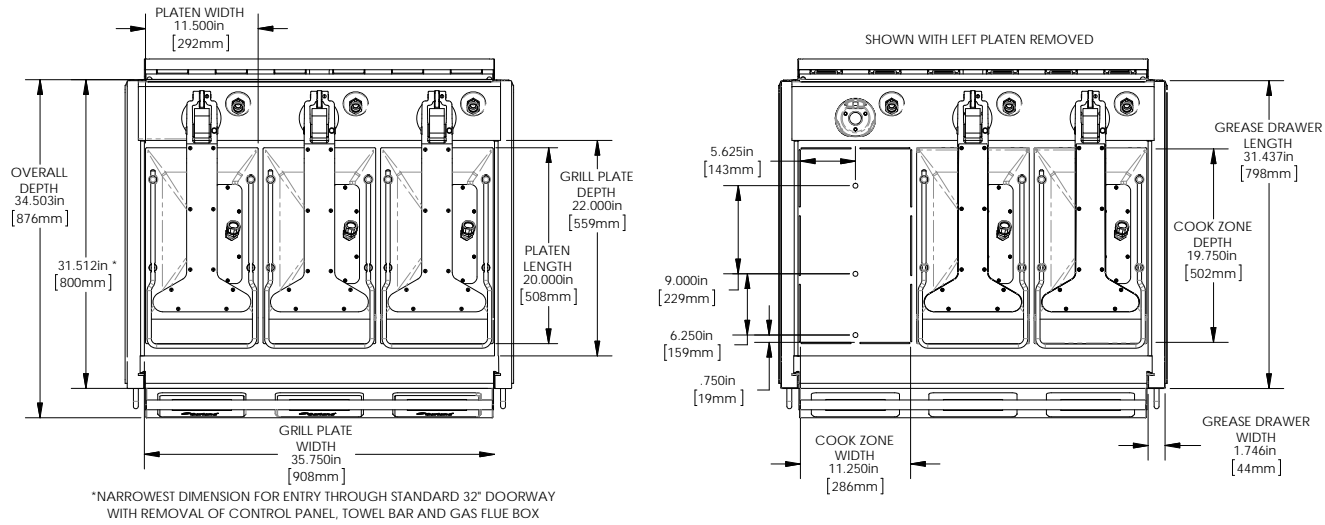

Model	Height*		Width**		Depth	
XP(E/G)36	32 in	812 mm	36 in	610 mm	34.5 in	876 mm

* Height not including caster

** Without grease buckets.

2 Platen Dimensions Specification

Dimensions: model: XP(E/G)24

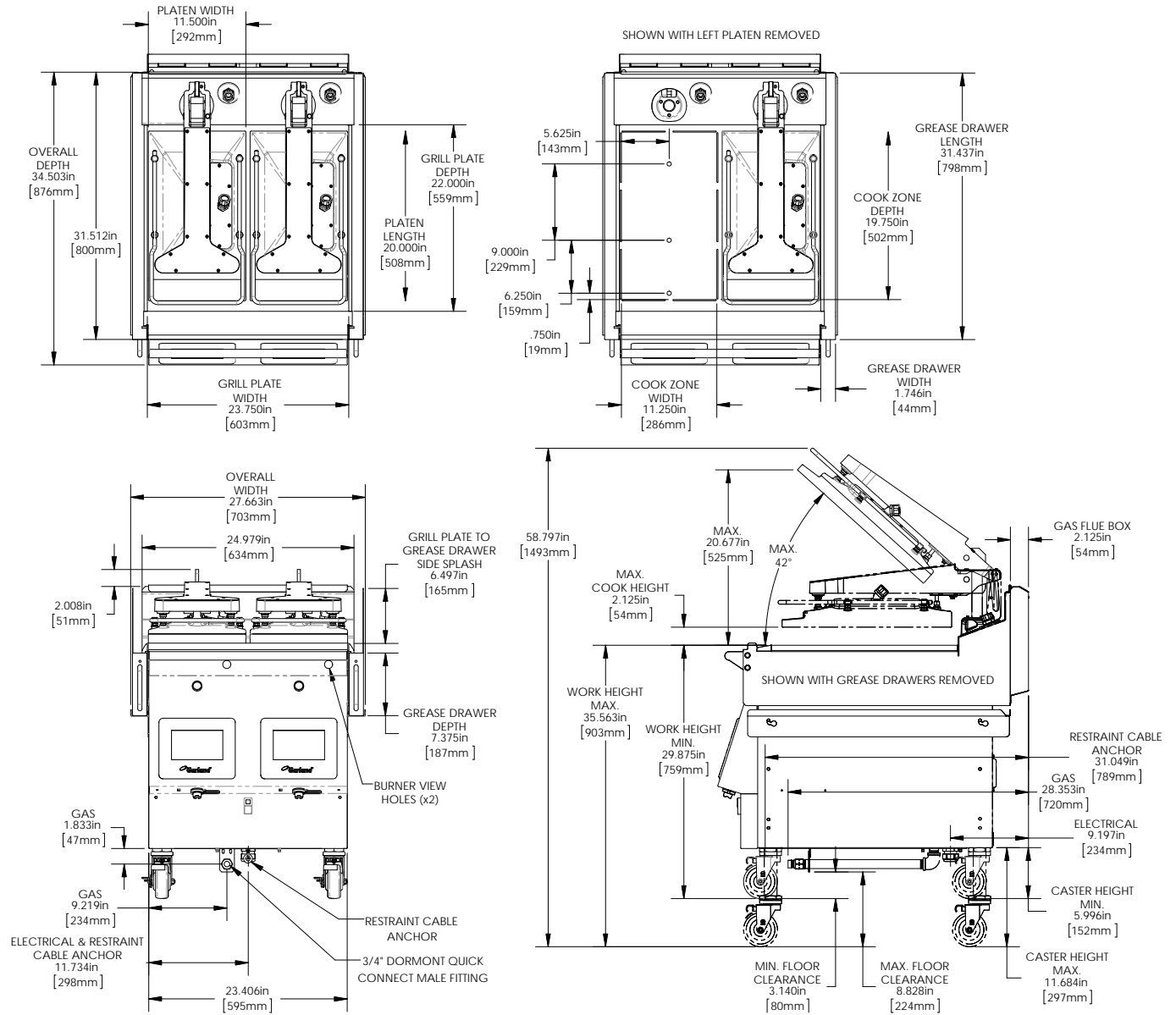

Model	Height*		Width**		Depth	
XP(E/G)24	32 in	812 mm	24 in	610 mm	34.5 in	876 mm

* Height not including caster

** Without grease buckets.

1 Platen Dimensions Specification

Dimensions: model: XP(E/G)12

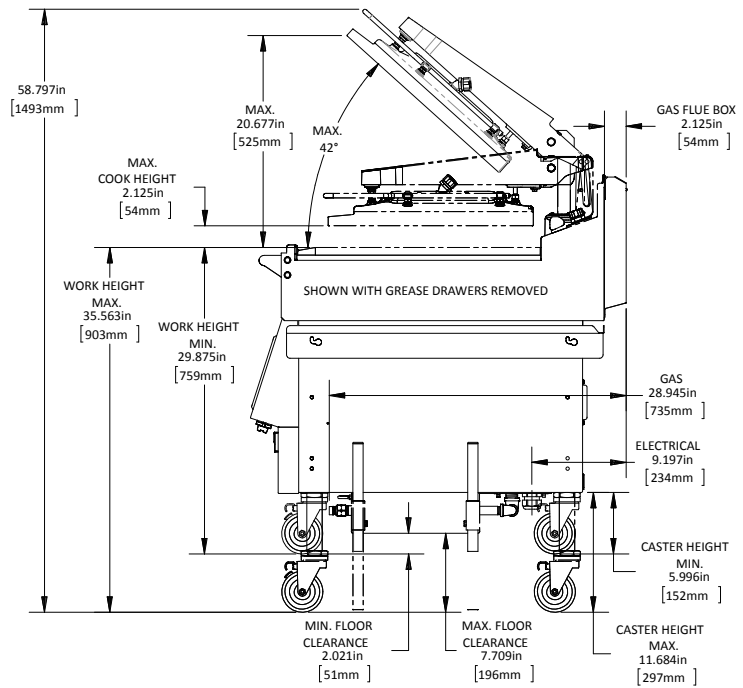
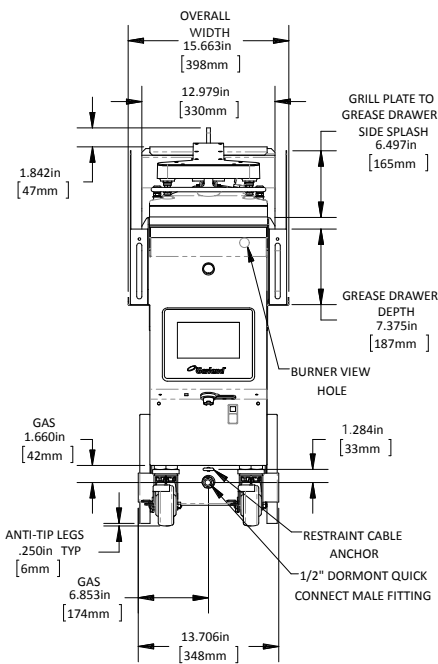
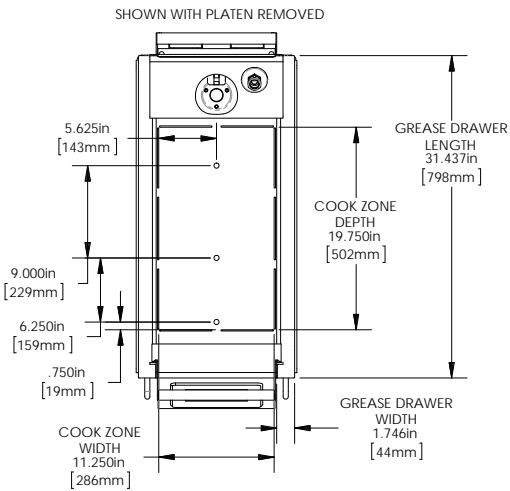
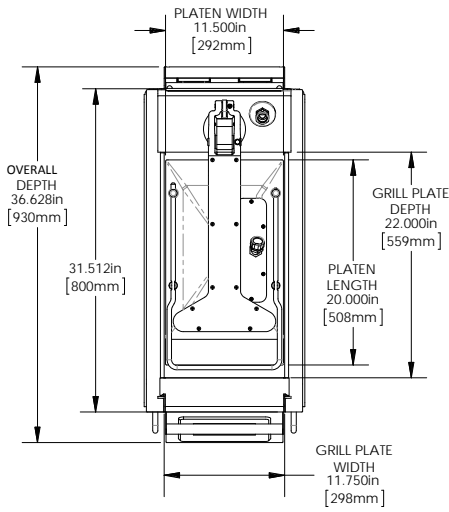

Model	Height*		Width**		Depth	
XP(E/G)12	32 in	812 mm	12 in	305 mm	34.5 in	876 mm

* Height not including caster

** Without grease buckets.

Electrical Input Specification - WYE (Electric models)

Model #	220/380V, 3N (WYE), 50/60Hz				230/400V, 3N (WYE), 50/60Hz				240/415V, 3N (WYE), 50/60Hz			
	Current (A)			Power (kW)	Current (A)			Power (kW)	Current (A)			Power (kW)
	L1	L2	L3		L1	L2	L3		L1	L2	L3	
XPE-12	12.6	15.5	13.9	7.9	11.8	15.3	13.9	8.0	11.8	15.0	13.9	8.0
XPE-12 0L/R	0.0	15.5	13.9	5.2	0.0	15.3	13.9	5.3	0.0	15.0	13.9	5.3
XPE-24 1 INPUT	24.7	24.9	26.9	15.8	23.1	23.9	26.2	15.9	22.6	22.9	25.7	15.9
XPE-24 0L/R 1 INPUT	24.7	13.8	15.7	10.5	23.1	13.8	15.5	10.6	22.6	13.8	15.2	10.6
XPE-24 1L 1 INPUT	24.7	13.8	26.9	13.1	23.1	13.8	26.2	13.3	22.6	13.8	25.7	13.2
XPE-24 1R 1 INPUT	24.7	24.9	15.7	13.1	23.1	23.9	15.5	13.3	22.6	22.9	15.2	13.2
XPE-36 1 INPUT	36.8	36.8	37.1	23.7	34.9	34.9	35.2	23.9	33.6	33.6	33.9	23.9
XPE-36 2 INPUT CORD 1	15.5	13.8	12.6	7.9	15.3	13.8	11.8	7.9	15.0	13.8	11.8	7.9
XPE-36 2 INPUT CORD 2	24.9	26.7	25.0	15.8	23.9	26.0	23.4	15.9	22.9	25.5	22.9	15.9
XPE-36 0L/R 1 INPUT	24.7	24.7	25.0	15.7	23.1	23.1	23.4	15.9	22.6	22.6	22.9	15.8
XPE-36 0L/R 2 INPUT CORD 1	15.5	13.8	0.0	5.2	15.3	13.8	0.0	5.3	15.0	13.8	0.0	5.3
XPE-36 0L/R 2 INPUT CORD 2	13.8	15.5	25.0	10.5	13.8	15.3	23.4	10.6	13.8	15.0	22.9	10.6
XPE-36 1L 1 INPUT	24.7	24.7	37.1	18.4	23.1	23.1	35.2	18.5	22.6	22.6	33.9	18.5
XPE-36 1L 2 INPUT CORD 1	15.5	13.8	12.6	7.9	15.3	13.8	11.8	7.9	15.0	13.8	11.8	7.9
XPE-36 1L 2 INPUT CORD 2	13.8	15.5	25.0	10.5	13.8	15.3	23.4	10.6	13.8	15.0	22.9	10.6
XPE-36 1R 1 INPUT	24.7	36.8	25.0	18.4	23.1	34.9	23.4	18.5	22.6	33.6	22.9	18.5
XPE-36 1R 2 INPUT CORD 1	15.5	13.8	0.0	5.2	15.3	13.8	0.0	5.3	15.0	13.8	0.0	5.3
XPE-36 1R 2 INPUT CORD 2	13.8	26.7	25.0	13.2	13.8	26.0	23.4	13.3	13.8	25.5	22.9	13.3
XPE-36 2L 1 INPUT	36.8	24.7	37.1	21.0	34.9	23.1	35.2	21.2	33.6	22.6	33.9	21.2
XPE-36 2L 2 INPUT CORD 1	15.5	13.8	12.6	7.9	15.3	13.8	11.8	7.9	15.0	13.8	11.8	7.9
XPE-36 2L 2 INPUT CORD 2	24.9	15.5	25.0	13.2	23.9	15.3	23.4	13.3	22.9	15.0	22.9	13.3
XPE-36 2R 1 INPUT	36.8	36.8	25.0	21.0	34.9	34.9	23.4	21.2	33.6	33.6	22.9	21.2
XPE-36 2R 2 INPUT CORD 1	15.5	13.8	0.0	5.2	15.3	13.8	0.0	5.3	15.0	13.8	0.0	5.3
XPE-36 2R 2 INPUT CORD 2	24.9	26.7	25.0	15.8	23.9	26.0	23.4	16.0	22.9	25.5	22.9	15.9

Electrical Input Specification - DELTA (Electric models)

Model #	200V, 3L (DELTA), 50/60Hz				208V, 3L (DELTA), 50/60Hz			
	Current (A)			Power (kW)	Current (A)			Power (kW)
	L1	L2	L3		L1	L2	L3	
XPE 12	24.1	25.9	25.2	8.1	23.7	25.4	24.8	8.2
XPE 12 0L/R	13.9	16.9	25.2	5.4	14.0	16.6	24.8	5.4
XPE-24 1 INPUT	48.4	48.4	48.4	16.1	47.4	47.3	47.3	16.3
XPE-24 2 INPUT CORD 1	25.1	25.8	24.1	8.0	24.7	25.3	23.7	8.1
XPE-24 2 INPUT CORD 2	25.1	24.3	26.0	8.1	24.7	23.9	25.5	8.2
XPE-24 0L/R 1 INPUT	48.4	28.2	28.2	10.7	47.4	27.6	27.6	10.9
XPE-24 0L/R 2 INPUT CORD 1	25.1	16.8	13.9	5.3	24.7	16.5	14.0	5.4
XPE-24 0L/R 2 INPUT CORD 2	25.1	14.1	17.0	5.4	24.7	14.2	16.7	5.5
XPE-24 1L 1 INPUT	48.4	36.9	36.9	13.4	47.4	36.1	36.1	13.6
XPE-24 1L 2 INPUT CORD 1	25.1	25.8	24.1	8.0	24.7	25.3	23.7	8.1
XPE-24 1L 2 INPUT CORD 2	25.1	14.1	17.0	5.4	24.7	14.2	16.7	5.5
XPE-24 1R 1 INPUT	48.4	36.9	36.9	13.4	47.4	36.1	36.1	13.6
XPE-24 1R 2 INPUT CORD 1	25.1	16.8	13.9	5.3	24.7	16.5	14.0	5.4
XPE-24 1R 2 INPUT CORD 2	25.1	24.3	26.0	8.1	24.7	23.9	25.5	8.2
XPE-36 2 INPUT CORD 1	25.8	25.1	24.1	8.0	25.3	24.7	23.7	8.1
XPE-36 2 INPUT CORD 2	48.4	48.4	48.4	16.2	47.4	47.3	47.3	16.3
XPE-36 0L/R 2 INPUT CORD 1	16.8	13.9	25.1	5.3	16.5	14.0	24.6	5.4
XPE-36 0L/R 2 INPUT CORD 2	48.4	28.2	28.2	10.8	47.4	27.6	27.6	10.9
XPE-36 1L 2 INPUT CORD 1	25.8	25.1	24.1	8.0	25.3	24.7	23.7	8.1
XPE-36 1L 2 INPUT CORD 2	48.4	28.2	28.2	10.8	47.4	27.6	27.6	10.8
XPE-36 1R 2 INPUT CORD 1	25.1	16.8	13.9	5.3	24.7	16.5	14.0	5.4
XPE-36 1R 2 INPUT CORD 2	48.4	36.9	36.9	8.2	47.4	36.1	36.1	13.5
XPE-36 2L 2 INPUT CORD 1	25.8	25.1	24.1	8.0	25.3	24.7	23.7	8.1
XPE-36 2L 2 INPUT CORD 2	48.4	36.9	36.9	13.5	47.4	36.1	36.1	13.5
XPE-36 2R 2 INPUT CORD 1	25.1	16.8	13.9	5.3	24.7	16.5	14.0	5.4
XPE-36 2R 2 INPUTCORD 2	48.4	48.4	48.4	16.2	47.4	47.3	47.3	16.3

Electrical Input Specification - DELTA (Electric models), continuation

Model #	220V, 3L (DELTA), 50/60Hz			230V, 3L (DELTA), 50/60Hz			240V, 3L (DELTA), 50/60Hz		
	Current (A)	Power (kW)		Current (A)	Power (kW)		Current (A)	Power (kW)	
	L1	L2	L3	L1	L2	L3	L1	L2	L3
XPE 12	22.0	23.7	22.9	7.9	21.2	23.0	22.0	22.0	21.6
XPE 12 0L/R	13.8	15.6	22.9	5.3	13.8	15.4	22.0	5.3	21.6
XPE-24 1 INPUT	42.7	43.0	43.0	15.8	40.1	40.6	39.1	39.5	39.5
XPE-24 2 INPUT CORD 1	22.8	23.6	22.0	7.9	21.9	21.2	21.5	22.5	20.7
XPE-24 2 INPUT CORD 2	22.8	22.2	23.8	7.9	21.9	23.1	21.5	20.9	22.7
XPE-24 0L/R 1 INPUT	42.7	24.9	24.9	10.5	40.1	23.3	39.1	22.8	22.8
XPE-24 0L/R 2 INPUT CORD 1	22.8	15.5	13.8	5.2	21.9	13.8	21.5	15.0	13.8
XPE-24 0L/R 2 INPUT CORD 2	22.8	14.0	15.7	5.2	21.9	14.0	21.5	14.0	15.2
XPE-24 1L 1 INPUT	42.7	32.8	32.8	13.1	40.1	30.9	39.1	30.0	30.0
XPE-24 1L 2 INPUT CORD 1	22.8	23.6	22.0	7.9	21.9	21.2	21.5	22.5	20.7
XPE-24 1L 2 INPUT CORD 2	22.8	14.0	15.7	5.2	21.9	14.0	21.5	14.0	15.2
XPE-24 1R 1 INPUT	42.7	32.8	32.8	13.1	40.1	30.9	39.1	30.0	30.0
XPE-24 1R 2 INPUT CORD 1	22.8	15.5	13.8	5.2	21.9	13.8	21.5	15.0	13.8
XPE-24 1R 2 INPUT CORD 2	22.8	22.2	23.8	7.9	21.9	23.1	21.5	20.9	22.7
XPE-36 2 INPUT CORD 1	23.6	22.8	22.0	7.9	22.9	21.2	22.5	21.5	20.7
XPE-36 2 INPUT CORD 2	42.7	43.0	43.0	15.8	40.1	40.6	39.1	39.5	39.5
XPE-36 0L/R 2 INPUT CORD 1	15.5	13.8	22.8	5.2	15.3	13.8	15.0	13.8	21.5
XPE-36 0L/R 2 INPUT CORD 2	42.7	24.9	24.9	10.5	40.1	23.3	39.1	22.8	22.8
XPE-36 1L 2 INPUT CORD 1	23.6	22.8	22.0	7.9	22.9	21.2	22.5	21.5	20.7
XPE-36 1L 2 INPUT CORD 2	42.7	24.9	24.9	10.4	40.1	23.3	39.1	22.8	22.8
XPE-36 1R 2 INPUT CORD 1	22.8	15.5	13.8	5.2	21.9	13.8	21.5	15.0	13.8
XPE-36 1R 2 INPUT CORD 2	42.7	32.8	32.8	13.1	40.1	30.9	39.1	30.0	30.0
XPE-36 2L 2 INPUT CORD 1	23.6	22.8	22.0	7.9	22.9	21.2	22.5	21.5	20.7
XPE-36 2L 2 INPUT CORD 2	42.7	32.8	32.8	13.1	40.1	30.9	39.1	30.0	30.0
XPE-36 2R 2 INPUT CORD 1	22.8	15.5	13.8	5.2	21.9	13.8	21.5	15.0	13.8
XPE-36 2R 2 INPUT CORD 2	42.7	43.0	43.0	15.8	40.1	40.6	39.1	39.5	39.5

Electrical Input Specification - WYE (gas XPG-12-CE models)

XPG-12 CE Models (gas models)						XPG-12 (OL/R) CE Models (gas models)					
Model	Volts 3N~(WYE) 50/60Hz	Total Current (A)			Power(kW)	Model	Volts 3N~(WYE) 50/60Hz	Total Current (A)			Power(kW)
		L1	L2	L3				L1	L2	L3	
XPG-12	220V/380V	12.6	4.7	0.0	3.4	XPG-12 OL/R	220V/380V	0.0	4.7	0.0	0.8
	230V/400V	11.8	4.7	0.0	3.4		230V/400V	0.0	4.7	0.0	0.8
	240V/415V	11.8	4.7	0.0	3.4		240V/415V	0.0	4.7	0.0	0.8

Electrical Input Specification - DELTA (gas XPG-12 models)

XPG-12 Models (gas models)						XPG-12 (OL/R) Models (gas models)					
Model	Volts 3~50/60Hz	Total Current (A)			Power(kW)	Model	Volts 3~50/60Hz	Total Current (A)			Power(kW)
		L1	L2	L3				L1	L2	L3	
XPG-12	200V	14.4	16.8	4.7	3.5	XPG-12 OL/R	200V	0.0	4.7	0.0	0.8
	208V	14.0	16.5	4.8	3.5		208V	0.0	4.8	0.0	0.8
	220V	12.6	15.0	4.7	3.4		220V	0.0	4.7	0.0	0.8
	230V	11.8	14.2	4.7	3.4		230V	0.0	4.7	0.0	0.8
	240V	11.8	14.1	4.7	3.4		240V	0.0	4.7	0.0	0.8

Electrical Input Specification - DELTA (electric XPE-24 models)

XPE-24, 1 Input, Models (electric models)					
Model	Volts 3~50/60Hz	Total Current (A)			Power(kW)
		L1	L2	L3	
XPE-24 1INPUT	200V	48.4	48.4	48.4	16.1
	208V	47.4	47.3	47.3	16.3
	220V	42.7	43.0	43.0	15.8
	230V	40.1	40.6	40.6	16.0
	240V	39.1	39.5	39.5	16.0

XPE-24, 2 Input Cord 1, Models (electric models)					
Model	Volts 3~50/60Hz	Total Current (A)			Power(kW)
		L1	L2	L3	
XPE-24 2INPUT CORD 1	200V	25.1	25.8	24.1	8.0
	208V	24.7	25.3	23.7	8.1
	220V	22.8	23.6	22.0	7.9
	230V	21.9	22.9	21.2	7.9
	240V	21.5	22.5	20.7	7.9

XPE-24, 2 Input Cord 2, Models (electric models)					
Model	Volts 3~50/60Hz	Total Current (A)			Power(kW)
		L1	L2	L3	
XPE-24 2INPUT CORD 2	200V	25.1	24.3	26.0	8.1
	208V	24.7	23.9	25.5	8.2
	220V	22.8	22.2	23.8	7.9
	230V	21.9	21.4	23.1	8.0
	240V	21.5	20.9	22.7	8.0

Electrical Input Specification - WYE (gas XPG-24 CE models)

XPG-24 CE Models (gas models)					
Model	Volts 3N [~] (WYE) 50/60Hz	Total Current (A)			Power(kW)
		L1	L2	L3	
2 Platen	220V/380V	4.7	12.6	16.7	6.8
	230V/400V	4.7	11.8	15.5	6.9
	240V/415V	4.7	11.8	15.6	6.9

XPG-24 (0L,0R) CE Models (gas models)					
Model	Volts 3N [~] (WYE) 50/60Hz	Total Current (A)			Power(kW)
		L1	L2	L3	
2 Platen	220V/380V	4.7	0.0	4.7	1.5
	230V/400V	4.7	0.0	4.7	1.5
	240V/415V	4.7	0.0	4.7	1.5

XPG-24 1L CE Models (gas models)					
Model	Volts 3N [~] (WYE) 50/60Hz	Total Current (A)			Power(kW)
		L1	L2	L3	
2 Platen	220V/380V	4.7	0.0	16.7	4.2
	230V/400V	4.7	0.0	15.5	4.2
	240V/415V	4.7	0.0	15.6	4.2

XPG-24 1R CE Models (gas models)					
Model	Volts 3N [~] (WYE) 50/60Hz	Total Current (A)			Power(kW)
		L1	L2	L3	
2 Platen	220V/380V	4.7	12.6	4.7	4.2
	230V/400V	4.7	11.8	4.7	4.2
	240V/415V	4.7	11.8	4.7	4.2

Electrical Input Specification - DELTA (gas XPG-24 models)

XPG-24 Models (gas models)					
Model	Volts 3 [~] 50/60Hz	Total Current (A)			Power(kW)
		L1	L2	L3	
2 Platen	200V	22.9	16.8	28.3	7.0
	208V	20.5	16.5	27.6	7.0
	220V	18.8	15.0	25.1	6.8
	230V	18.0	14.2	23.7	6.9
	240V	17.8	14.1	23.5	6.9

XPG-24 (0L,0R) Models (gas models)					
Model	Volts 3 [~] 50/60Hz	Total Current (A)			Power(kW)
		L1	L2	L3	
2 Platen	200V	7.9	4.7	4.7	1.5
	208V	8.0	4.8	4.8	1.6
	220V	7.7	4.7	4.7	1.5
	230V	7.7	4.7	4.7	1.5
	240V	7.6	4.7	4.7	1.5

XPG-24 1L Models (gas models)					
Model	Volts 3 [~] 50/60Hz	Total Current (A)			Power(kW)
		L1	L2	L3	
2 Platen	200V	20.9	4.7	18.4	4.2
	208V	20.5	4.8	18.0	4.3
	220V	18.8	4.7	16.4	4.2
	230V	18.0	4.7	15.6	4.2
	240V	17.8	4.7	15.4	4.2

XPG-24 1R Models (gas models)					
Model	Volts 3 [~] 50/60Hz	Total Current (A)			Power(kW)
		L1	L2	L3	
2 Platen	200V	7.9	16.8	16.8	4.2
	208V	8.0	16.5	16.5	4.3
	220V	7.7	15.0	15.0	4.2
	230V	7.7	14.2	14.2	4.2
	240V	7.6	14.1	14.1	4.2

Electrical Input Specification - WYE (gas XPG-36 CE models)

XPG-36 CE Models (gas models)					
Model	Volts 3N~(WYE) 50/60Hz	Total Current (A)			Power(kW)
		L1	L2	L3	
3 Platen	220V/380V	16.7	16.7	16.7	10.2
	230V/400V	15.5	15.5	15.5	10.3
	240V/415V	15.6	15.6	15.6	10.3

XPG-36 (0L/R) CE Models (gas models)					
Model	Volts 3N~(WYE) 50/60Hz	Total Current (A)			Power(kW)
		L1	L2	L3	
3 Platen	220V/380V	4.7	4.7	4.7	2.3
	230V/400V	4.7	4.7	4.7	2.3
	240V/415V	4.7	4.7	4.7	2.3

XPG-36 1L CE Models (gas models)					
Model	Volts 3N~(WYE) 50/60Hz	Total Current (A)			Power(kW)
		L1	L2	L3	
3 Platen	220V/380V	4.7	4.7	16.7	4.9
	230V/400V	4.7	4.7	15.5	5.0
	240V/415V	4.7	4.7	15.6	5.0

XPG-36 1R CE Models (gas models)					
Model	Volts 3N~(WYE) 50/60Hz	Total Current (A)			Power(kW)
		L1	L2	L3	
3 Platen	220V/380V	4.7	16.7	4.7	4.9
	230V/400V	4.7	15.5	4.7	5.0
	240V/415V	4.7	15.6	4.7	5.0

XPG-36 2L CE Models (gas models)					
Model	Volts 3N~(WYE) 50/60Hz	Total Current (A)			Power(kW)
		L1	L2	L3	
3 Platen	220V/380V	16.7	4.7	16.7	7.6
	230V/400V	15.5	4.7	15.5	7.7
	240V/415V	15.6	4.7	15.6	7.6

XPG-36 2R CE Models (gas models)					
Model	Volts 3N~(WYE) 50/60Hz	Total Current (A)			Power(kW)
		L1	L2	L3	
3 Platen	220V/380V	16.7	16.7	4.7	7.6
	230V/400V	15.5	15.5	4.7	7.7
	240V/415V	15.6	15.6	4.7	7.6

Electrical Input Specification - DELTA (gas XPG-36 models)

XPG-36 Models (gas models)					
Model	Volts 3~(WYE) 50/60Hz	Total Current (A)			Power(kW)
		L1	L2	L3	
3 Platen	200V	31.7	31.7	31.7	10.4
	208V	30.9	30.9	30.9	10.6
	220V	28.3	28.3	28.3	10.2
	230V	27.3	27.3	27.3	10.3
	240V	26.1	26.1	26.1	10.3

XPG-36 (0L/R) Models (gas models)					
Model	Volts 3~(WYE) 50/60Hz	Total Current (A)			Power(kW)
		L1	L2	L3	
3 Platen	200V	7.0	7.0	7.0	2.3
	208V	6.9	6.9	6.9	2.3
	220V	6.3	6.3	6.3	2.3
	230V	6.1	6.1	6.1	2.3
	240V	5.8	5.8	5.8	2.3

Electrical Input Specification - DELTA (gas XPG-36 models), continuation

XPG-36 1L Models (gas models)					
Model	Volts 3~(WYE) 50/60Hz	Total Current (A)			Power(kW)
		L1	L2	L3	
3 Platen	200V	20.6	7.0	20.6	5.0
	208V	20.1	6.9	20.1	5.1
	220V	18.4	6.3	18.4	4.9
	230V	17.8	6.1	17.8	5.0
	240V	17.0	5.8	17.0	5.0

XPG-36 1R Models (gas models)					
Model	Volts 3~(WYE) 50/60Hz	Total Current (A)			Power(kW)
		L1	L2	L3	
3 Platen	200V	7.0	20.6	20.6	5.0
	208V	6.9	20.1	20.1	5.1
	220V	6.3	18.4	18.1	4.9
	230V	6.1	17.8	17.8	5.0
	240V	5.8	17.0	17.0	5.0

XPG-36 2L Models (gas models)					
Model	Volts 3~(WYE) 50/60Hz	Total Current (A)			Power(kW)
		L1	L2	L3	
3 Platen	200V	31.7	20.6	20.6	7.7
	208V	30.9	20.1	20.1	7.8
	220V	28.3	18.4	18.4	7.6
	230V	27.3	17.8	17.8	7.7
	240V	26.1	17.0	17.0	7.6

XPG-36 2R Models (gas models)					
Model	Volts 3~(WYE) 50/60Hz	Total Current (A)			Power(kW)
		L1	L2	L3	
3 Platen	200V	20.6	31.7	20.6	7.7
	208V	20.1	30.9	20.1	7.8
	220V	18.4	28.3	18.4	7.6
	230V	17.8	27.3	17.8	7.7
	240V	17.0	26.1	17.0	7.6

Gas Input Specification

STANDARD GAS SETTINGS/SPECIFICATIONS FOR CSA APPROVED MODELS												
GAS TYPE	STANDARD ELEVATION		FAN SPEED	PRESSURE SWITCH SETTING		INPUT/ BURNER	"TOTAL INPUT/UNIT BTU"			SUPPLY PRESSURE	MANIFOLD PRESSURE	INJECTOR SIZE
	FEET		RPM	" W.C. CLOSE / OPEN	Colour Code	BTU	12in GRILL	24in GRILL	36in GRILL	" W.C.	" W.C.	mm
Natural Gas CSA	0	- 4500	10,000	0.15 / 0.07	Grey	10,000	20,000	40,000	60,000	7.0	4.0	1.5
Propane Gas CSA	0	- 4500	10,000	0.15 / 0.07	Grey	10,000	20,000	40,000	60,000	11.0	4.0	1.2
STANDARD GAS SETTINGS/SPECIFICATIONS FOR CE APPROVED MODELS												
GAS TYPE	ELEVATION RANGE		FAN SPEED	PRESSURE SWITCH SETTING		INPUT/ BURNER	"TOTAL INPUT/UNIT kW"			SUPPLY PRESSURE	MANIFOLD PRESSURE	INJECTOR SIZE
	METERS		RPM	" W.C. CLOSE / OPEN	Colour Code	kW	12in GRILL	24in GRILL	36in GRILL	mbar	mbar	mm
Natural Gas G20	0	- 1372	10,000	0.32 / 0.24	Red	2.93	5.86	11.72	17.58	20.0	10.0	1.5
Natural Gas G25	0	- 1372	10,000	0.32 / 0.24	Red	2.93	5.86	11.72	17.58	25.0	13.7	1.5
Propane Gas G31	0	- 1372	10,000	0.32 / 0.24	Red	2.93	5.86	11.72	17.58	" 30.0 *37.0 50.0"	10.0	1.2
*The regulator on each gas valve has been adjusted at the factory for a 37mbar supply pressure. An authorized installer may need to adjust the regulator setting to maintain the correct manifold pressure for 30mbar and 50mbar installations.												

For installations up to 4500 ft (1372 meters). Units being installed at higher elevations must be configured accordingly at the factory or modified at the installation site by a factory authorized technician, using the appropriate certified conversion kit listed in this manual.

Determining Unit Configuration for Gas Grills:

- a. If the grill has been supplied with the following label (Figure label #1), it has been configured for standard elevation which is 0 - 4,500 feet (0 - 1372 m).

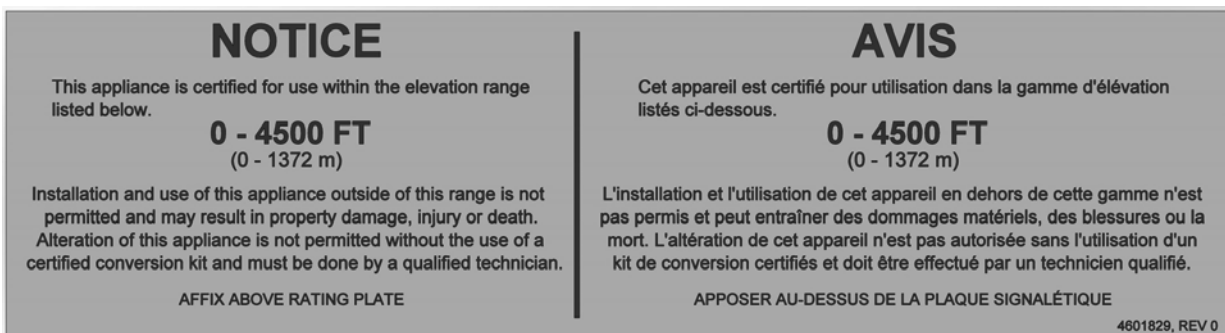

Figure label #1

Determining Unit Configuration for Gas Grills continuation:

- b. If the grill has been supplied with the following label, it has been configured for high elevation. The elevation and gas type for the unit is indicated by the punched hole in the “Appliance Set For” section. For example, on the label shown below, the unit is configured for Natural gas between 7001 and 9500 feet (2135 and 2896 meters).

NOTICE - HIGH ALTITUDE INSTALLATIONS / AVIS - HAUTE ALTITUDE INSTALLATIONS

The table below lists the elevation range that this appliance has been set to operate within. This appliance is only certified for use within the elevation range indicated below. Installation and use of this appliance outside of this range is not permitted and may result in property damage, injury or death. Alteration of this appliance is not permitted without the use of a certified conversion kit and must be done by a qualified technician.

Le tableau ci-dessous répertorie la gamme d'élévation que cet appareil a été conçu pour fonctionner à. Cet appareil est uniquement certifié pour utilisation dans la gamme d'élévation indiqué ci-dessous. Installation et utilisation de cet appareil en dehors de cette gamme est interdite et peut entraîner des dommages matériels, des blessures ou la mort. Altération de cet appareil est interdite sans l'utilisation d'un kit de conversion certifié et doit être effectué par un technicien qualifié.

NATURAL GAS / G20				PROPANE GAS / G31			
ELEVATION RANGE GAMME D'ELEVATION	4501 - 7000 FT (1373 - 2134 m)	7001 - 9500 FT (2135 - 2896 m)	9501 - 12000 FT (2897 - 3658 m)	ELEVATION RANGE GAMME D'ELEVATION	4501 - 7000 FT (1373 - 2134 m)	7001 - 9500 FT (2135 - 2896 m)	9501 - 12000 FT (2897 - 3658 m)
FAN SPEED VITESSE DU VENTILATEUR	11000 RPM	11750 RPM	12250 RPM	FAN SPEED VITESSE DU VENTILATEUR	11000 RPM	11100 RPM	11200 RPM
PRESSURE SWITCH INTERRUPTEUR DE PRESSION	0.15 "WC (37.3 Pa)	0.15 "WC (37.3 Pa)	0.15 "WC (37.3 Pa)	PRESSURE SWITCH INTERRUPTEUR DE PRESSION	0.15 "WC (37.3 Pa)	0.15 "WC (37.3 Pa)	0.15 "WC (37.3 Pa)
APPLIANCE SET FOR APPAREIL FIXE POUR	<input type="checkbox"/>	<input checked="" type="checkbox"/>	<input type="checkbox"/>	APPLIANCE SET FOR APPAREIL FIXE POUR	<input type="checkbox"/>	<input type="checkbox"/>	<input type="checkbox"/>

AFFIX ABOVE RATING PLATE / APOSER AU-DESSUS DE LA PLAQUE SIGNALÉTIQUE

4601799, REV 0

Figure label #2

Gas Elevations Settings

HIGH ELEVATION GAS SETTINGS/SPECIFICATIONS FOR CSA APPROVED MODELS												
GAS TYPE	ELEVATION RANGE		FAN SPEED	PRESSURE SWITCH SETTING		¹ INPUT/BURNER	² TOTAL INPUT/UNIT BTU			SUPPLY PRESSURE	MANIFOLD PRESSURE	INJECTOR SIZE
	FEET		RPM	" W.C. CLOSE / OPEN	Colour Code	BTU	12in GRILL	24in GRILL	36in GRILL	" W.C.	" W.C.	mm
Natural Gas CSA	4501	- 7000	11,000	0.15 / 0.07	Grey	8,900	17,800	35,600	53,400	7.0	4.0	1.5
	7001	- 9500	11,750			8,500	17,000	34,000	51,000			
	9501	- 12000	12,250			8,100	16,200	32,400	48,600			
Propane Gas CSA	4501	- 7000	11,000	0.15 / 0.07	Grey	8,900	17,800	35,600	53,400	11.0	4.0	1.2
	7001	- 9500	11,100			8,700	17,400	34,800	52,200			
	9501	- 12000	11,200			8,500	17,000	34,000	51,000			

¹Input per burner based on the middle of the elevation range, ²Calculated based on Input/Burner

Gas Elevations Settings continuation:

HIGH ELEVATION GAS SETTINGS/SPECIFICATIONS FOR CE APPROVED MODELS												
GAS TYPE	ELEVATION RANGE		FAN SPEED	PRESSURE SWITCH SETTING		¹ INPUT/BURNER	² TOTAL INPUT/UNIT KW			SUPPLY PRESSURE	MANIFOLD PRESSURE	INJECTOR SIZE
	METERS		RPM	" W.C. CLOSE / OPEN	Colour Code	kW	12in GRILL	24in GRILL	36in GRILL	mbar	mbar	mm
Natural Gas G20	1373	- 2134	11,000	0.15 / 0.07	Grey	2.61	5.22	10.44	15.66	20.0	10.0	1.5
	2135	- 2896	11,750			2.49	4.98	9.96	14.94			
	2897	- 3658	12,250			2.37	4.74	9.48	14.22			
Propane Gas G25	1373	- 2134	11,000	0.15 / 0.07	Grey	2.61	5.22	10.44	15.66	25.0	13.7	1.5
	2135	- 2896	11,100			2.55	5.10	10.20	15.30			
	2897	- 3658	11,200			2.49	4.98	9.96	14.94			
Propane Gas G31	1373	- 2134	11,000	0.15 / 0.07	Grey	2.61	5.22	10.44	15.66	30.0 ³ 37.0 50.0	10.0	1.2
	2135	- 2896	11,100			2.55	5.10	10.20	15.30			
	2897	- 3658	11,200			2.49	4.98	9.96	14.94			

¹Input per burner based on the middle of the elevation range, ²Calculated based on Input/Burner

¹Input per burner based on the middle of the elevation range, ²Calculated based on Input/Burner, ³The regulator on each gas valve has been adjusted at the factory for a 37mbar supply pressure. An authorized installer may need to adjust the regulator setting to maintain the correct manifold pressure for 30mbar and 50mbar installations.

COUNTRY	GAS CATEGORY	GAS TYPE	SUPPLY PRESSURE (mbar)
AT, CH, CY, CZ, DK, EE, ES, FI, FR, GB, GR, HR, IE, IT, LT, LU, LV, NL, NO, PT, RO, SE, SI, SK, TR	I2H	G20	20
HU	I2H	G20	25
DE, LU, PL, RO	I2E	G20	20
BE	I2E(R)	G20	20
FR	I2E(r)	G20/G25	20/25
FR, NL	I2L	G25	25
RO	I2L	G25	20
FI, HU,NL, RO	I3P	G31	30
BE, CH, CZ, ES, FR, GB, GR, HU, IE, IT, LT, NL, PL, PT, SI, SK, HR	I3P	G31	37
AT, BE, CH, CZ, DE, ES, FR, GB, GR, HU, NL, SK	I3P	G31	50

CSA APPROVED CONVERSION KITS		
CONVERSION KIT #4602236		
FOR ALL CSA APPROVED UNITS		
THIS KIT IS USED TO CONVERT CSA APPROVED STANDARD SEA LEVEL UNITS TO HIGH ELEVATION UNITS. THIS KIT APPLIES TO ALL CSA NATURAL GAS AND PROPANE GAS UNITS, REGARDLESS OF SIZE. THE KIT CONTAINS THE ITEMS LISTED BELOW.		
PART #	DESCRIPTION	QTY
4601799	LABEL - HIGH ELEVATION (4501 - 12000 FT)	1
4602121	LABEL - ELEVATION DECLARATION MG/XPG	1
4602240	INSTRUCTIONS - STD TO ELEVATION CONVERSION MG/XPG	1
4602256	LABEL - CONVERSION KIT, STD TO ELEVATION, NAT/PRO CSA UNITS	1

CE APPROVED CONVERSION KITS FOR ELEVATION		
CONVERSION KIT #4602237		
FOR ALL CE APPROVED 12in UNITS		
THIS KIT IS USED TO CONVERT 12in CE APPROVED STANDARD SEA LEVEL UNITS TO HIGH ELEVATION UNITS. THIS KIT ONLY APPLIES TO 12in GRILLS, CONFIGURED FOR USE WITH G20 NATURAL GAS AND G31 PROPANE GAS. THE KIT CONTAINS THE ITEMS LISTED BELOW.		
PART #	DESCRIPTION	QTY
4601799	LABEL - HIGH ELEVATION (4501 - 12000 FT)	1
4602121	LABEL - ELEVATION DECLARATION MG/XPG	1
4602240	INSTRUCTIONS - STD TO ELEVATION CONVERSION MG/XPG	1
4602257	LABEL - CONVERSION KIT, STD TO ELEVATION, G20/G31, 12IN CE UNITS	1
4601976	PRESSURE SWITCH ASSY, GREY PRINT PLATE, PR 0.15 WC	2

CONVERSION KIT #4602238		
FOR ALL CE APPROVED 24in UNITS		
THIS KIT IS USED TO CONVERT 24in CE APPROVED STANDARD SEA LEVEL UNITS TO HIGH ELEVATION UNITS. THIS KIT ONLY APPLIES TO 24in GRILLS, CONFIGURED FOR USE WITH G20 NATURAL GAS AND G31 PROPANE GAS. THE KIT CONTAINS THE ITEMS LISTED BELOW.		
PART #	DESCRIPTION	QTY
4601799	LABEL - HIGH ELEVATION (4501 - 12000 FT)	1
4602121	LABEL - ELEVATION DECLARATION MG/XPG	1
4602240	INSTRUCTIONS - STD TO ELEVATION CONVERSION MG/XPG	1
4602258	LABEL - CONVERSION KIT, STD TO ELEVATION, G20/G31, 24IN CE UNITS	1
4601976	PRESSURE SWITCH ASSY, GREY PRINT PLATE, PR 0.15 WC	4

CONVERSION KIT #4602239		
FOR ALL CE APPROVED 36in UNITS		
THIS KIT IS USED TO CONVERT 36in CE APPROVED STANDARD SEA LEVEL UNITS TO HIGH ELEVATION UNITS. THIS KIT ONLY APPLIES TO 36in GRILLS, CONFIGURED FOR USE WITH G20 NATURAL GAS AND G31 PROPANE GAS. THE KIT CONTAINS THE ITEMS LISTED BELOW.		
PART #	DESCRIPTION	QTY
4601799	LABEL - HIGH ELEVATION (4501 - 12000 FT)	1
4602121	LABEL - ELEVATION DECLARATION MG/XPG	1
4602240	INSTRUCTIONS - STD TO ELEVATION CONVERSION MG/XPG	1
4602259	LABEL - CONVERSION KIT, STD TO ELEVATION, G20/G31, 24IN CE UNITS	1
4601976	PRESSURE SWITCH ASSY, GREY PRINT PLATE, PR 0.15 WC	4

CE APPROVED CONVERSION KITS G20/G25		
CONVERSION KIT #4602241		
FOR ALL CE APPROVED UNITS		
THIS KIT IS USED TO CONVERT CE APPROVED UNITS FROM G20 NATURAL GAS TO G25 NATURAL GAS, REGARDLESS OF SIZE. THE KIT CONTAINS THE ITEMS LISTED BELOW.		
PART #	DESCRIPTION	QTY
4601826	LABEL - G25 GAS TYPE	6
4602243	LABEL - G20 TO G25 CONVERSION, MG/XPG	1
4602260	LABEL - CONVERSION KIT G20 TO G25 NAT GAS CE UNITS (ALL SIZES)	1
4602245	INSTRUCTIONS - G20 TO G25 & G25 TO G20 CONVERSION, MG/XPG	1

CONVERSION KIT #4602242		
FOR ALL CE APPROVED UNITS		
THIS KIT IS USED TO CONVERT CE APPROVED UNITS FROM G25 NATURAL GAS TO G20 NATURAL GAS, REGARDLESS OF SIZE. THE KIT CONTAINS THE ITEMS LISTED BELOW.		
PART #	DESCRIPTION	QTY
4601808	LABEL - NAT/G20 GAS TYPE	6
4602244	LABEL - G25 TO G20 CONVERSION, MG/XPG	1
4602261	LABEL - CONVERSION KIT G25 TO G20 NAT GAS CE UNITS (ALL SIZES)	1
4602245	INSTRUCTIONS - G20 TO G25 & G25 TO G20 CONVERSION, MG/XPG	1

Conversion Labels:

For CSA + CE conversion kits for elevation →

CONVERSION LABEL - HIGH ALTITUDE / HAUTE ALTITUDE
 MODELS / MODÈLES - XPG & MG

This appliance was converted for use at high altitude using kit #
 Cet appareil a été converti pour une utilisation à haute altitude à l'aide de la trousse

Type of gas/Type de gaz:

Installation Altitude/Altitude de l'installation:

Input per burner/Puissance par brûleur:

Orifice size/manifold pressure do not change. Fan speed/pressure switch set per instructions.
 Orifice/pression ne change pas. Interrupteur de pression/vitesse du ventilateur régler selon les instructions.

Converted by/Converti par:
 Company Name and Address
 Nom et adresse de l'entreprise

Date of Conversion/Date de conversion:
DAY / JOUR MONTH / MOIS YEAR / AN

The company above and its qualified technician accept responsibility for this conversion and certify that it has been done correctly / La société ci-dessus et son technicien qualifié acceptent la responsabilité de cette conversion et certifie que cela a été fait correctement.

AFFIX NEXT TO RATING PLATE / AFFIXE ADJACENTE À LA PLAQUE SIGNALÉTIQUE
 4602121, REV 0

For CE conversion kit G20 to G25 →

CONVERSION LABEL - G20 NATURAL GAS / G20 GAZ NATUREL
 MODELS / MODÈLES - XPG & MG

This appliance was converted for use with natural gas
 Cet appareil a été converti pour être utilisé avec gaz naturel

Conversion kit #
 Kit de conversion

ORIFICE SIZE DOES NOT CHANGE
 LA TAILLE DE L'ORIFICE NE CHANGE PAS

Inlet Pressure mbar MINIMUM
 Pression d'entrée mbar

Manifold Pressure mbar
 Pression à l'appareil mbar

Input per burner kW
 Puissance par brûleur kW

Converted by/Converti par:
 Company Name and Address
 Nom et adresse de l'entreprise

Date of Conversion/Date de conversion:
DAY / JOUR MONTH / MOIS YEAR / AN

The company above and its qualified technician accept responsibility for this conversion and certify that it has been done correctly / La société ci-dessus et son technicien qualifié acceptent la responsabilité de cette conversion et certifie que cela a été fait correctement.

AFFIX NEXT TO RATING PLATE / AFFIXE ADJACENTE À LA PLAQUE SIGNALÉTIQUE
 4602244, REV 0

For CE conversion kit for G25 to G20 →

CONVERSION LABEL - G25 NATURAL GAS / G25 GAZ NATUREL
 MODELS / MODÈLES - XPG & MG

This appliance was converted for use with natural gas
 Cet appareil a été converti pour être utilisé avec gaz naturel

Conversion kit #
 Kit de conversion

ORIFICE SIZE DOES NOT CHANGE
 LA TAILLE DE L'ORIFICE NE CHANGE PAS

Inlet Pressure mbar MINIMUM
 Pression d'entrée mbar

Manifold Pressure mbar
 Pression à l'appareil mbar

Input per burner kW
 Puissance par brûleur kW

Converted by/Converti par:
 Company Name and Address
 Nom et adresse de l'entreprise

Date of Conversion/Date de conversion:
DAY / JOUR MONTH / MOIS YEAR / AN

The company above and its qualified technician accept responsibility for this conversion and certify that it has been done correctly / La société ci-dessus et son technicien qualifié acceptent la responsabilité de cette conversion et certifie que cela a été fait correctement.

AFFIX NEXT TO RATING PLATE / AFFIXE ADJACENTE À LA PLAQUE SIGNALÉTIQUE
 4602243, REV 0

Section 2 Installation

STOP! - Follow the instructions below to safely and easily remove unit from packaging skid.

Unit very heavy Personal Protective Equipment (PPE) required.

Removing Grill From Wood Crate

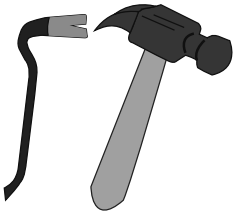

Tools required.

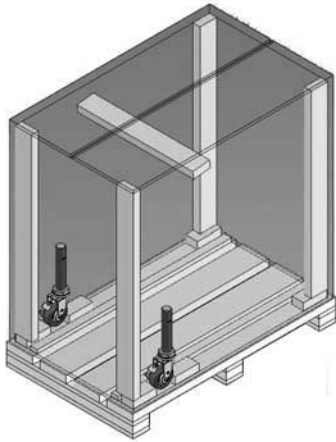

1. PACKAGING IS DIVIDED IN TWO PARTS, CARDBOARD BOX AND THE WOOD SKID.

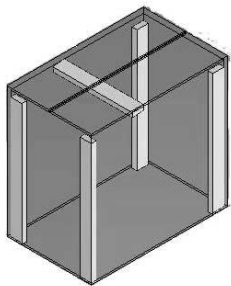

2. REMOVE AND DISCARD THE CARDBOARD BOX COVERING THE UNIT.

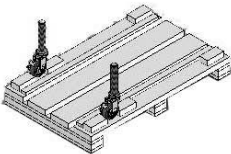

3. REMOVE AND DISCARD THE TWO (2) WOOD BLOCKS LOCKING EACH OF THE FRONT CASTER. **NOTE:** ENSURE FRONT CASTER BRAKES ARE ON WHILE BLOCK ARE BEEN REMOVED.

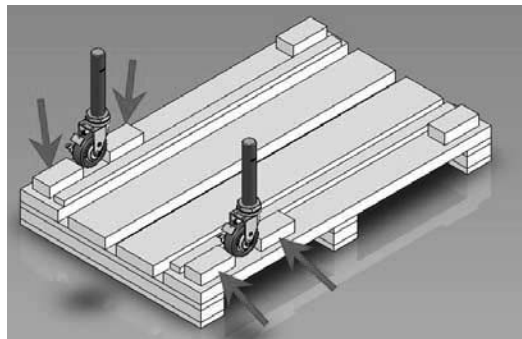

4.

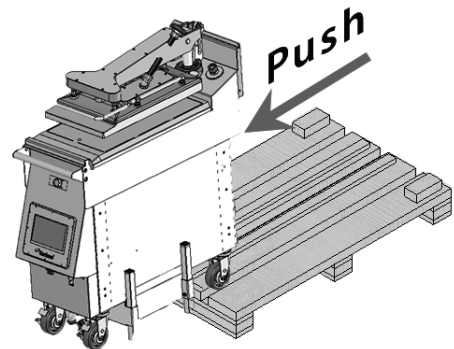

5. RELEASE THE FRONT CASTER BRAKES AND PUSH UNIT FORWARD OFF OF THE SKID. ENSURE THAT THE UNIT ROLLS STRAIGHT AS IT IS BEING MOVED.

Transporting Grill To Location

Transporting your new grill to the kitchen requires the following criteria.

- Plan first before anything else. Lower your risk of encountering problems during the transport process.
- Understand brake caster mechanism to apply or release when requires.
- Keep top platen down during transportation.
- Match transportation speed to conditions.
- Turn downhill, not uphill, if stability becomes uncertain on slope or ramp.
- Push/pull the grill by the towel bar straight even with the gentle slope.
- Do not push/pull diagonally across it.
- Do not push/pull by conduit or platen arm.
- One (1) platen model is narrow, take extra care for slope and ramp. If slope or ramp is greater than $\pm 10^\circ$ there is potential that the grill will tip-over, ask for help and use the proper techniques transporting the grill.



Location

The location selected for the equipment must meet the following criteria. If any of these criteria are not met, select another location.

- The location **MUST** be level and capable of supporting the weight of the equipment:
 - 3platen - 238.1 kg (525 lbs) approximately.
 - 2platen - 165.6 kg (365 lbs) approximately.
 - 1platen - 154.2 kg (340 lbs) approximately.
- The location **MUST** be free from and clear of combustible materials.
- Equipment **MUST** be level both front to back and side to side.
- Position the equipment so it will not tip or slide.
- The air temperature must be at least 40°F (4.4°C) must not exceed 110°F (43.3°C).
- Proper air supply for ventilation is **REQUIRED AND CRITICAL** for safe and efficient operation. Refer to Clearance Requirements chart.
- Do not obstruct the flow of ventilation air. Make sure the air vents of the equipment are not blocked

- The location must not be near heat-generating (broiler, dishwashers, etc) equipment or in direct sunlight and must be protected from weather.
- Do not install the equipment directly over a drain. Steam rising up out of the drain will adversely affect operation, air circulation, and damage electrical / electronic components.
- Do not store anything on top of a unit.

Clearance Requirements

Clearance are required to carry the gas or electric grill to the kitchen.

- Uncrated unit have different clearance requirements for different size unit. For more information check the dimension of the unit on section 1 on this manual.
- Depth 31.4 (798mm), with towel bar and front panel removed.

Clearance are required when the unit is installed to limit the probability of damage.

- The minimum clearance required; 2"(51mm) side & 4"(102mm) rear.
- If installation against non-combustible surfaces only, clearance required; zero (0).

Leveling

Position the unit under the hood and in its normal operational position to prevent warping of the grill plate & optimize cooking performance.

- Adjust the unit by turning the casters clockwise to raise the unit and counterclockwise to lower the unit.
- Adjust the casters until the grill plate is level and at the proper height.
- Grill must be level front to back, side to side and diagonally. This leveling must be done with the unit under the hood and it's normal operation.
- Tighten the lock nut on each caster tightly against the bottom of the unit.
- When the unit is in place, lock the front casters to prevent movement.
- Lock the casters from swiveling to facilitate moving the unit straight in and out for cleaning.

Exhaust Hood Requirements

1. Install the equipment under an Exhaust Hood.
2. The exhaust hood must extend over the exhaust ports and meet the following requirements:
 - A. The exhaust hood must be sized for the cumulative ventilation requirements of all the appliances in the area under the hood.

- B. If an existing hood cannot be used, a new one must be constructed over the equipment.
- C. When determining hood size; include clearances.

NOTE: Always turn ON the exhaust hood when the unit is running to prevent condensation in the unit.

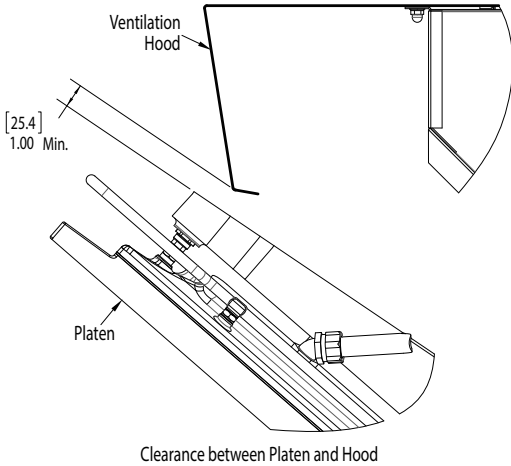

Positioning

The unit is very heavy and mechanical assistance may be required to lift and position the appliance. The unit is designed to be installed on a smooth and level floor built to withstand the weight of the fully laden appliance.

The unit is pre-installed with casters for ease of mobility for cleaning and servicing. Take proper care to push or pull the grill and ensure the grill does not tip over.

Appliances Equipped with Casters

The unit is shipped with casters installed in place, some adjustment may be required to level the unit. The front and rear casters are adjustable, only the front casters have brakes.

Garland recommends installing restraining chains/cables from the floor/wall to the rear of the unit. These restraints limit the mobility of the appliance. A restraining cable must be used for gas units connected with a flexible gas hose.

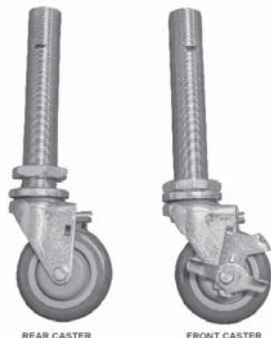

Casters Adjustment Procedure

1. Turn the clamshell grill Green Power Main Switch OFF. (green light off)

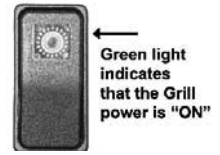

2. Rear and front Casters have a threaded stem to adjust the level of the grill independent of the swiveling action.

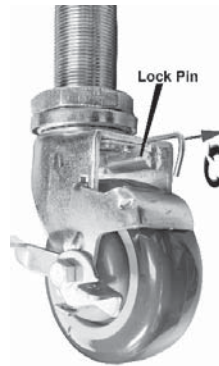

3. All casters are adjustable.
4. Lock the caster swivel using the locking pin. Pull the clip and turn 90 degrees, release pin. (Note: applying the locking pin in the lock position will lock the swivel of the caster assembly).

5. Carefully raise the unit slightly so that the wheel is off the ground and no longer bearing unit weight.
6. Loosen caster jam nut by turning it counterclockwise with a wrench.
7. Adjust the caster assembly by turning the caster (swivel locking pin on) counterclockwise to increase the height or clockwise to decrease the height.

IMPORTANT NOTE

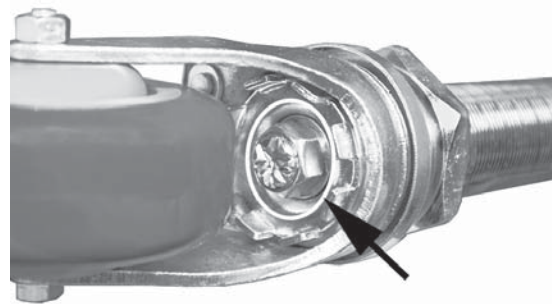

On the caster assembly shown above there is a nut used to assemble the swivel system - do not use wrench on this nut. This nut is intended for the caster swiveling system only.

8. Beware of the red mark in the threaded stem to indicated the maximum adjustment. Red mark in the threaded stem portion should not be visible.

Warning: Adjusting above the red mark could cause the caster to fail & the unit to tip.

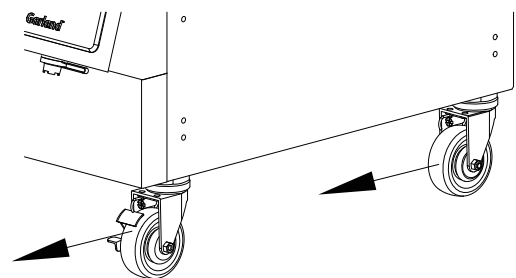
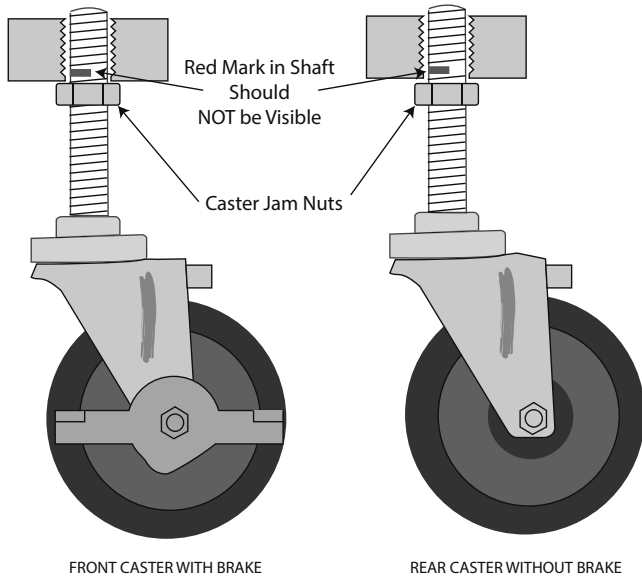

9. After the grill is completely level, align the caster wheels straight ahead as shown. Then rotate the locking pin until is seated fully into the slot and secured. Now, tighten caster jam nut to secure the caster assembly.

Securing Stabilizer Grill System (1 platen models only)

Stabilizer system will help prevent the grill from tipping-over within a range of 0° to 10° degrees angle perpendicular to the front of the unit.

1. Proceed and complete Caster Adjustment Procedure as mentioned above.
2. Lower the stabilizing arms, (total of four (4) arms located beside the side panels) until the arms touch the floor.
3. Raise each arm 0.25" (6.4mm) off the floor and secure the arm with the bolt on the side of each arm, as shown below.

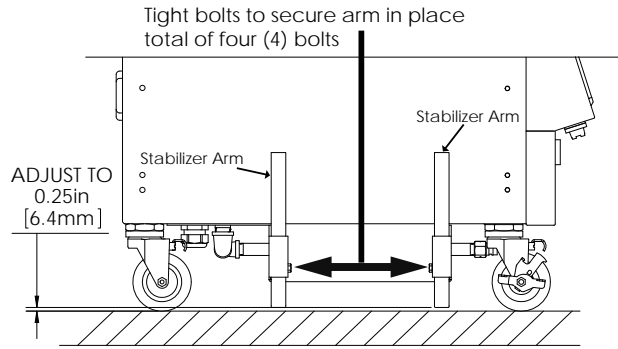

NOTE: UNDER NO CIRCUMSTANCES SHOULD YOU REMOVE THE STABILIZER SYSTEM FROM GRILL.

Remove Stainless Steel Plastic Film Cover

Removing this film is one of the things that must be done once the Grill is in place. The film covers both internal and external components (e.g. side panels, grease shield) and must be removed before turning the grill on.

1. Using a plastic scraper, wedge the film away from the stainless steel.
2. Grasp and pull the film very gently away from the stainless steel.

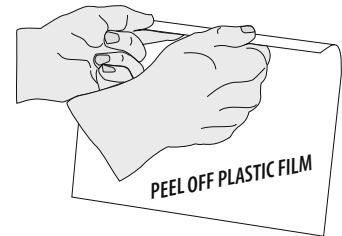

Temporary Storage

Garland provides adequate protection under normal conditions in transit and storage. The grill may need additional protection if it is stored near salt water, a tropical area, or other unfavorable conditions. Please contact Garland immediately if these conditions occur.

Gas Connector Requirements:

- Installation shall be made with the gas connector that has been supplied with the grill or similar approved connector. The quick disconnect fitting and gas shut off valve must be installed in the direction indicated on their outer body.
- NOTE: When checking gas pressure, be sure that all other equipment on the same gas line is on.
- The appliance and its individual shut-off valve must be disconnected from the gas supply piping system during any pressure testing of that system pressures in excess of ½ PSIG (3.45kPa).
- Adequate clearance must be provided for servicing and proper operation.
- A restraining device must be installed when a flexible gas hose is used.

National Codes Requirements:

- The type of gas for which the grill is equipped is stamped on the serial plate mounted on the lower left corner of the right panel. Connect a grill to the gas type stamped on the data plate only.
- The installation must conform to the National Fuel Gas Code ANSI Z223.1-1998 or latest edition, NFPA No. 54 – latest edition and National Electrical Code ANSI/NFPA 70-1990 or latest edition and/or local code to assure safe and efficient operation. In Canada, the installation must comply with CSA B149.1 and local codes where applicable.
- In Canada, electrical connection must comply with applicable sections of the Canadian Electrical Code, C22.1 - 1990, latest edition, "Safety Standard for Installation, Part 1" and C22.2- No. O-M 1982 latest edition.

Installation store responsibilities:

- The installation shall be made with a connector that complies with the Standard for Connectors for Moveable Gas Appliances, ANSI Z21.69/CSA 6.16, and quick-disconnect device that complies with the Standard for Quick Disconnect Devices for Use with Gas Fuel, ANSI Z21.41/CSA 6.9.
- The front Casters on the appliance are equipped with brakes to limit the movement of the appliance without placing any strain on the connector or quick disconnect device or its associated piping.
- Please be aware: required restraint is attached to a bracket, (which is located on the front of the grill, underneath, closest to the gas connection) and if disconnection of the restraint is necessary, be sure to reconnect the device after the appliance has been returned to its original position.

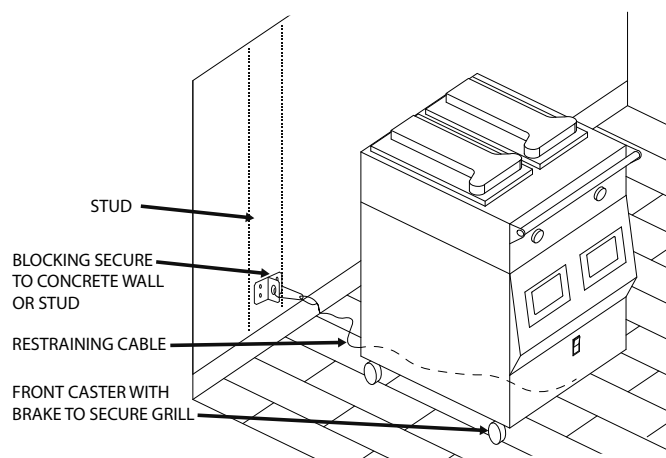

- "Adequate clearance must be provide for air opening into the combustion chamber, and for proper servicing"

- Not intended to be installed adjacent to combustible walls or on combustible floors.
- Ensure grill has been installed by a competent trained installation person.
- Ensure store readiness of utilities, product & personnel.
- Contacting your local Garland Factory Authorized Service Center for a startup date.
- Participate in the startup to ensure a successful startup and familiarity with the grill.
- Conduct training with your crew personnel to ensure maximum utilization of the grill. Once the installation is complete as per the procedures below, a factory authorized service company MUST startup the grill according to Garland Commercial Ranges startup standards.

Restraining device installation Procedure

1. Shutoff main gas line valve and disconnect the quick-disconnect gas line device before the following installation .
2. Attach the bracket to a stud in the wall.
3. Locate the area in the frame on front of the grill underneath, to place the eye-bolt. Closest to the gas connection 
4. For model one (1) platen grill gas. Discard nylon lock nut of the eye-bolt and screw it underneath of the front panel above the gas line (Figure A), tighten eye-bolt jam nut to secure it in place.
5. For model two & three (2&3) platen grill gas. Slide the eye-bolt through the hole and place the nylon lock nut on the inside frame and tighten securely (Figure B).

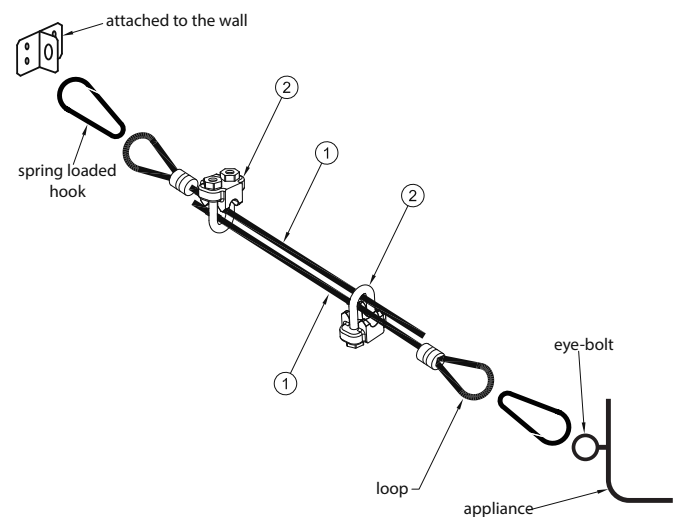

6. Attach one of the spring-loaded hook to the bracket on the wall and the other end to the eye-bolt (grill). adjust the proper distance of the cable ① and tight both clamps ② to secure the both cables
7. Test straining cable by moving the grill, movement of the grill must not place any strain on the connector or quick disconnect device or its associated piping.

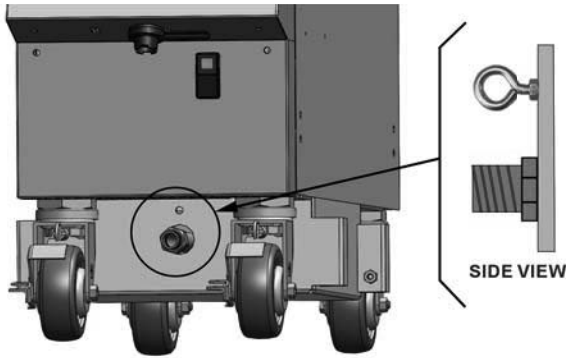

Figure A - one (1) platen

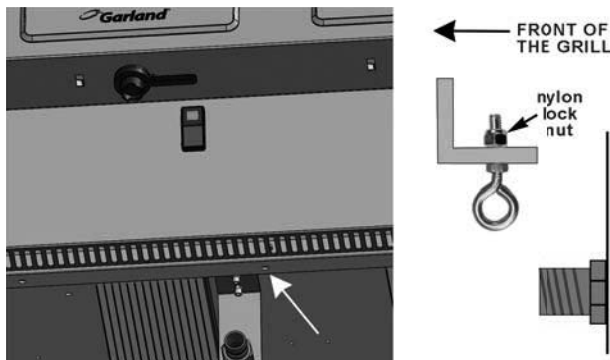

Figure B - two & three (2&3) platen

2. Remove the two phillip screws located on each side of the front panel below the user interface and store them in a save place.
3. Gently slightly move the panel up and then away from the grill, be very careful with the wires and connectors. Remove the bags.
4. Reinstall cover and tighten the screws.

Gas Connections, and Pipe Sizing:

- The size of the gas line is very important. If the line is too small, the gas pressure at the burner manifold will be low. This will cause slow recovery and delayed ignition. The incoming gas pressure line should be a minimum of 1-1/2". A 3platen grill requires a 3/4" connection and a 1platen grill requires a 1/2" connection. The 2platen grill can have either a 1/2" or 3/4" connection.
- Before connecting new pipe the pipe must be blown out to dispose of any foreign particles. These particles will cause improper operation.
- When using thread compound, use small amounts on male threads only. Use a compound that is not affected by the chemical action of LP gases. Avoid applying compound to the first two threads to prevent clogging of the burner orifices and control valve.
- Have the installer check all gas plumbing with a soap solution for leaks. DO NOT USE matches, candles or other ignition sources in checking for leaks.
- Check the data plate to determine the proper type of gas before connecting the quick disconnect or piping from the building gas supply.
- An incoming gas pressure test nipple is provided on the incoming gas manifold for pressure checks.
- Minimum incoming gas pressure for Natural Gas is 6" W.C. Maximum incoming gas pressure for Natural Gas is 14" W.C.
- Minimum incoming gas pressure for Propane is 10" W.C. Maximum incoming gas pressure for Propane is 23" W.C.
- Burner operating gas pressure can be checked at the outlet side of the gas valve at the pressure test point.
- Refer to "Gas Input Specification Chart" for correct burner manifold pressure based on gas type.
- To adjust the burner pressure;
 - a. remove the sealing screw from the pressure spigot on the outlet side of the gas valve and the connect a manometer.
 - b. remove the sealing cap on the gas valve regulator
 - c. turn on both burners in that lane and set the pressure by turning the regulator screw.

"Desi Pak" bags from the grill:

- Desi Pak bags are only intended to be left inside the grill during shipment and equipment storage. Desi Pak are designed to protect the electronic components by controlling humidity levels within the equipment.
- Garland highly recommends these bags remain in the equipment while the grills are in storage or not in operation



Removing "Desi Pak" bags from the grill:

1. Turn the clamshell grill Green Power Main Switch OFF. (green light off)



- d. turn off the grill, remove the manometer and re-fit the sealing screw on the pressure spigot and regulator.
- e. test those connection for leaks.
- f. these procedure must be done by qualify technician only.
- Gas pressures should be checked by the local Gas Company or an authorized service agency only.
- Test all piping and connections for gas leaks. A rich soap solution should be used for this purpose. Never use a flame. If inside unit, protect electronic components/boards before leak testing with soap solution.
- The appliance must be isolated from the gas supply piping system by closing its individual manual shutoff valve during any pressure testing of the gas supply piping system at test pressures equal to or greater than ½ psi (3.5 kPa).
- If included, Install the quick-disconnect gas hose to the inlet fitting on the underside of the grill. Remove the dust cap from the male coupler and snap the quick disconnect fitting on the gas hose assembly onto the male coupler.

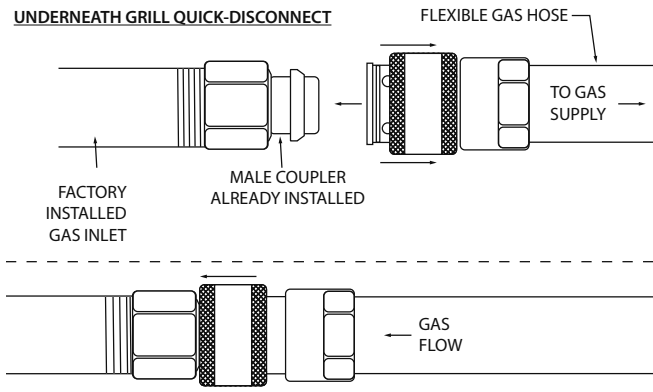

- Ensure the sleeve snaps fully forward against the retaining ring.
- With the manual shut-off valve closed, and gas hose assembly disconnected from the unit install the other end of the hose to the gas supply.
- Affix Shut-Off sticker as shown below:

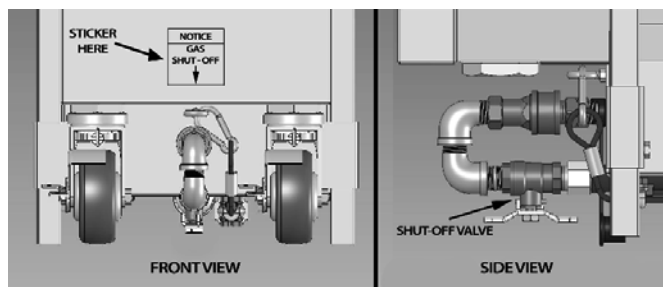

Electrical Connection

Warning

Disconnect power supply before starting this procedure.

- All electrically operated appliances must be electrically grounded in accordance with local codes; or in the absence of local codes, with the latest edition of National Wiring Regulations. A wiring diagram is located on the rear panel of the grill. See rating serial plate mounted on the lower left corner of the right panel for proper voltages.



GROUND LUG

- The entry point for the electrical connection is located on the bottom of the appliance.
- **Do not** cut or remove the grounding prong from the plug.
- Adequate means of disconnection of the supply must be provided.
- It is recommended to allow enough slack on the electrical cord to allow the appliance to be pulled out for proper cleaning and maintenance.

Flue Upper Rear Panel Install Instruction

Install flue box to the back of grill for all gas grill models only (if required).

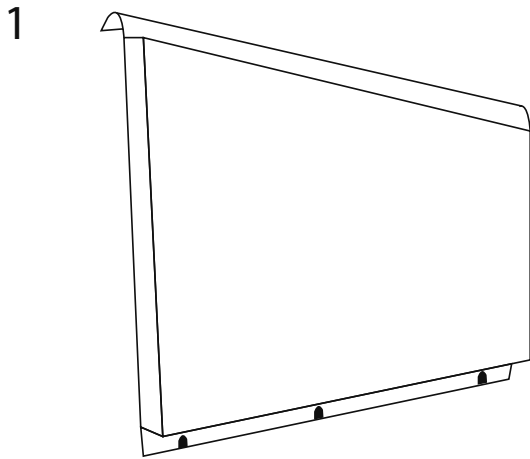

Remove the flue assembly from the accessory box

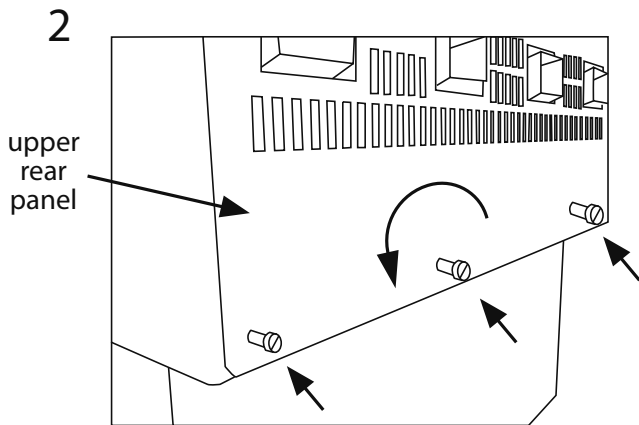

Loosen three screws, two turns counterclockwise

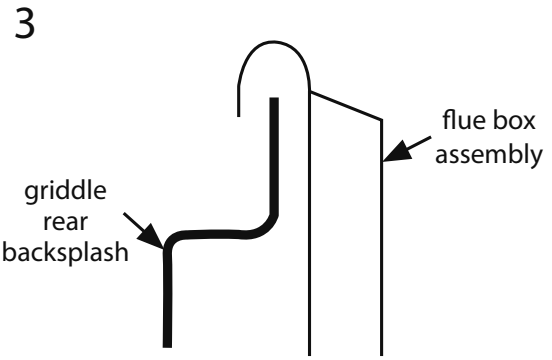

Place hemmed flange of flue box over top edge of griddle rear backsplash

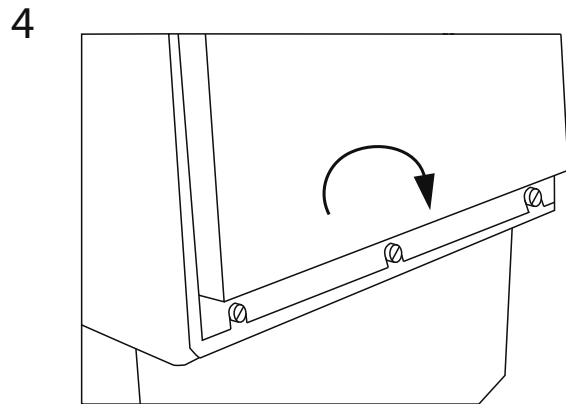

Re-tighten lower three screws



Installation completed

Install Release Material Sheets (Rear Loop Option)

In order to achieve proper cooking performance, ensure that the release material sheet is installed properly to the platen.

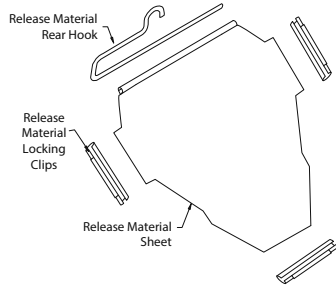

List of Material:

1. Release Material Locking Clips, use three (3) per platen
2. Release Material Rear Hook, use one (1) per platen
3. Release Material Sheet, use one (1) per platen

Platen Release Material Sheet Installation Procedure

1. Raise top platen, by pressing the green button.



2. Slide release material hook through the hemmed (tube) end of the release material sheet.

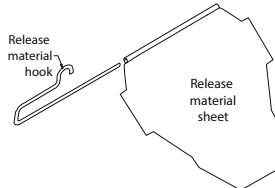

3. Hook the release material hook bar onto the anchor located at the rear of the platen.

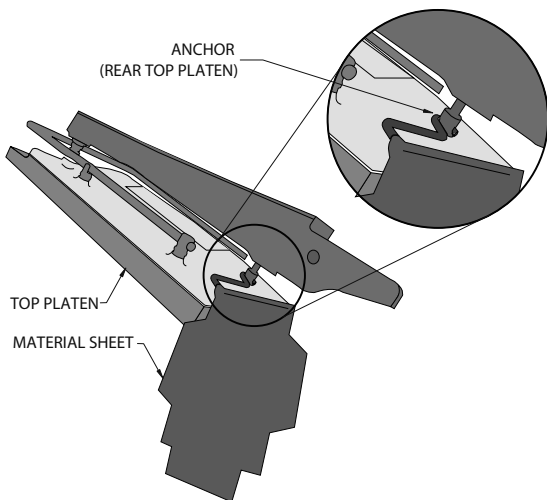

4. Gently pull the release material sheet towards the front platen and then wrap the sheet around the front of platen and over the U bar, while holding the front end sheet, place the locking clip over the sheet and press into the rod.

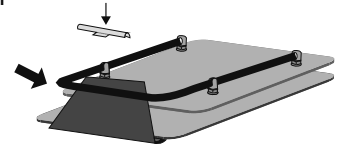

5. Repeat the above procedure for the other two sides of release material sheet.

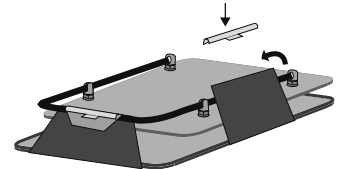

6. Check alignment and tightness of release material against the upper platen. Make adjustment if necessary.

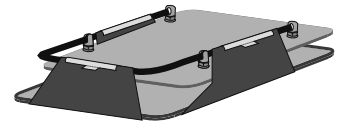

Release Material should be replaced when:

- Product sticks to release material.
- Carbon builds up.
- A tear in the release material appears.
- Release material coating is worn off sheet.

Startup Procedure

This Garland 1, 2 & 3-platen grill comes with a factory startup at no additional charge. A startup is required to take place BEFORE the unit is put into operation. It is the end-user responsibility to schedule the startup with their local Factory Authorized Service Agent.

A factory startup is a comprehensive grill check in which a factory certified technician will document all final settings programmed in the controller once various other performance checks are complete. The estimated time to complete a startup is approximately 1.5 – 2 hours. Please

keep in mind this estimated time when scheduling the startup. After hours or overtime is not covered under warranty and will be billed at a charge which is the difference between the Garland Reimbursement rate and the Factory Authorized Service Centers overtime charges. A factory startup is necessary to start the warranty period. The Authorized Service Center is required to complete the paperwork during the startup process, and send it to Garland Commercial Ranges. At the time of receipt, Garland will start the warranty period.

GARLAND XPRESS PLUS CLAMSHELL GRILL START – UP FORM
ELECTRIC OR COMBINATION GAS / ELECTRIC
(TOP COPY MUST BE RETURNED TO THE FACTORY FOR PAYMENT)

Company Name _____ Store # _____ Start-up Date _____
MM / DD / YY

Address _____ City _____ Model # _____
 State / Province (US / Canada ONLY) _____ Zip Code _____ Serial Number# _____
 United States Canada Other International _____ Phone # _____

Grill Type (Check One)

XP12" 1 Platen XP12" 0 Platen 24" 0 Platen L / R 24" 1 Platen L / R 36" 0 Platen L / R 36" 1 Platen L / R 36" 2 Platen L / R 36" 3 Platen L / R 36" 0 Platen L / R

Other (Please Specify): _____

Gas Type	Actual Gas Type	Electric/3-Phase		Actual Input	
		200 VAC-Δ	240 VAC-Δ	x y z	VAC per phase
<input type="checkbox"/> Propane Gas	<input type="checkbox"/> Other (Please Specify)	<input type="checkbox"/> 208 VAC-Δ	<input type="checkbox"/> 380 VAC-Y	<input type="checkbox"/> Other (Please Specify)	
<input type="checkbox"/> Natural Gas		<input type="checkbox"/> 220 VAC-Δ	<input type="checkbox"/> 400 VAC-Y		
<input type="checkbox"/> Butane Gas		<input type="checkbox"/> 230 VAC-Δ	<input type="checkbox"/> 415 VAC-Y		

Ensure the grill is installed in accordance with Manitowoc / Garland manuals, mandatory, and local standards.

INSPECTION / OPERATIONAL CHECK

- 1) Ensure grill is installed under the correct type of **exhaust hood** with minimum required air draw and height distance of approximately 24 inches (2 feet) from cooking surface. OK
- 2) Ensure electric connections are secure and have not become loose in start-up. OK
- 3) Ensure the grill is positioned and set level when checked from the grill surface is leveled side to side / front to back / diagonally, in location, under hood. Adjust casters to attain level. OK
- 4) Turn Power Switch ON, controller displays are active, controller Displays "OFF". Platen rises automatically? OK
- 5) Ensure operating parameters are set as indicated below for Gas and ELECTRIC: OK

Gas

Rated Incoming Pressure

Natural Gas _____ inches W.C. Actual Incoming _____

Propane / Butane Gas _____ inches W.C. Actual Incoming _____

Rated Burner Pressure

Natural Gas _____ inches W.C. Actual Left Front: _____ Left Back: _____

Propane/Butane Gas _____ inches W.C. Actual Middle Front: _____ Middle Back: _____

Actual Right Front: _____ Right Back: _____

- 6) Check micro amp reading: Should be 1.4 or greater per zone. OK

Actual Micro Amp Readings: Left front: _____ Left Back: _____

Actual Micro Amp Readings: Middle front: _____ Middle Back: _____

Actual Micro Amp Readings: Right front: _____ Right Back: _____

- 7) **Disconnect flexible gas hose or close gas valve handle** and verify the unit tries to ignite three (3) times. After 3rd attempted UI will display an Alarm. OK
- 8) Select Press n Go, ensure unit preheats and display shows temperature rise. OK
- 9) Lower and raise Upper Platen and ensure movement is smooth and continuous. If needed grease shafts accordingly with a FOOD GRADE LUBRICANT. OK
- 10) Select a product and lower platen - Timing cycle begins and counts down. OK
- 11) Platen raises automatically when timed out and alarm sounds. OK
- 12) Perform platen **zero** adjustment under **Calibration** as outlined in the service manual. OK
- 13) Assist or obtain assistance with store personnel for **Beef / Product Integrity Testing**. OK
- 14) Record cook times, gap settings / offsets, and any gap calibrations used to obtain beef/ product integrity. OK

Problems / Special Circumstances / Damage:

Zone	Menu Name	Cook Time	Platen Yes / No	Top Temp	Bottom Temp	Gap Setting

Note: If any zone is different please duplicate the chart or show differences for each zone.

Submitted by:	Accepted by:
Name: _____	Name: _____
Service Agency: _____	Are you satisfied with the Start-up procedure? YES / NO
Are You a factory certified technician? YES / NO	Please indicate any comments
Date if Certification / /	

White Copy – Factory Yellow Copy – Service Agency Pink Copy – Customer
 P/N 4601665 Rev1 (8 Dec 15)

Section 3 Operation

NOTE: Do not operate the unit without reading and understanding the safety requirements. Refer to the safety section at the front of this manual.

Sequence of Operation

After turning the power switch to "I" or ON position, the grill will go through initialization. If the upper platens are in the lowered position they will return to their raised upper position. This movement takes approximately 8 seconds.

The upper platen is lowered automatically, following the initiation of the cooking cycle, and the upper platen is raised automatically upon completion of the cooking cycle.

Warning

With two sided cooking, the area between the upper platen and the griddle plate should be regarded as a "danger zone." During two sided cooking the operator must not be within this danger zone.

In two sided cooking, the upper platen remains in the lowered position by nature of its own weight. It is not locked down. It can be raised by lifting up on the handle on the front of the platen. Under no circumstances, other than safety, should the platen be manually opened more than the normal open position.

What buttons do;

1. Power Switch turns the grill OFF or ON.

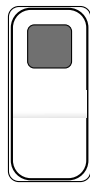

Green light indicates that the Grill power is "ON"

2. Green button:
 - press to start cook.
 - press and hold to abort

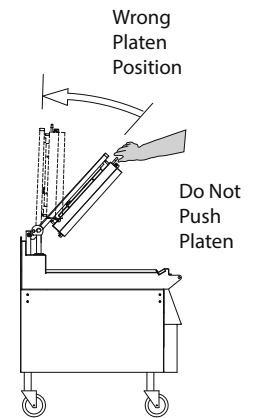
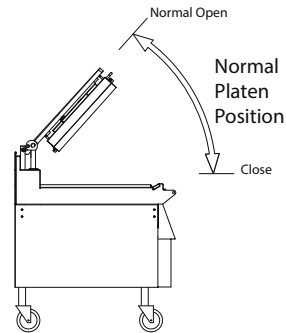

Caution

Lifting the platen manually over the normal open position is very dangerous; this can cause premature failure of the electrical flex steel conduit and the lifting mechanism.

easyToUCH™ Controller

HOME SCREEN, RECIPE SELECTOR SCREEN & ICONS

The easyToUCH™ HOME and RECIPE SELECTOR screens are the most frequently used screens. Many of the icons described below also appear on other easyToUCH™ cooking and settings screens.

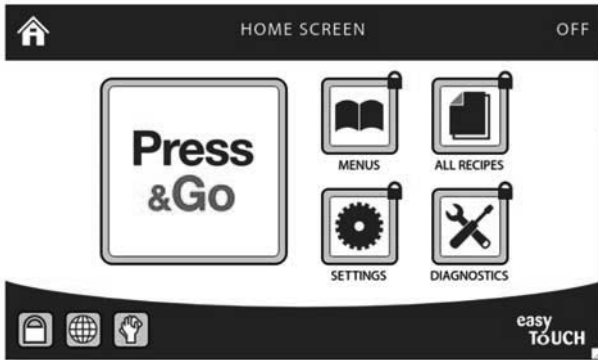

Home Screen

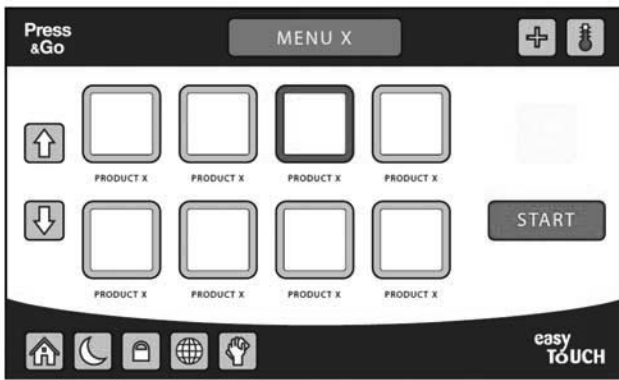

Recipe Selector Screen

PRESS & GO – is used to initiate preheat and cook on the grill.	
MENUS – is used to activate, add, edit and delete Menus from the library. A Menu is a collection of cook recipes. Password protected.	
RECIPES – is used to add, edit and delete Recipes from the library. A Recipe consists of the cooking times, temperatures and platen gap for preparing a food item. Password protected.	
SETTINGS – is used to change certain settings, such as date, time and volume. Password protected.	
DIAGNOSTICS – allows access to the diagnostics screens. Password protected.	
COOK CYCLE CHANGE – is used to adjust a recipe’s cook time or platen gap, if required to achieve food safety and quality standards.	
TEMPERATURE – is used to view the temperature settings and actual temperature in each zone.	
CLEAN MODE – is used to put the grill into Clean mode, and heat or cool the grill to the required temp. When the grill is set to enforce the cleaning schedule, using the Clean mode resets the cleaning counter.	
LOCK – is used to temporarily lock the touch screen for fifteen (15) seconds. This prevents buttons being pressed accidentally when wiping the screen.	
LANGUAGE – is used to change the language of on-screen prompts. Only available for languages that have been pre-loaded.	
HOME – returns to the Home screen, the launching point for cooking settings and programming modes. When the home screen is showing, the heaters are OFF (shown at top right corner).	
SLEEP – is used to enter Sleep mode. In Sleep mode, the grill maintains the platen lowered to conserve energy during periods of inactivity.	

NOTE: The easyToUCH™ screen display, layout and icons shown herein are for guidance purposes only and are not intended to be an exact representation of those displayed on the grill.

ON SCREEN WARNINGS AND ALERTS MESSAGES

Too Cool/Too Hot - If the grill temperature is too cool to properly cook a recipe, a “Too Cool to Cook” message appears. The grill will not allow the cook cycle to start until it has heated to the minimum required starting temperature.

Similarly, if the grill is too hot, a “Too Hot to Cook” message appears and a cook cycle can not start until the grill cools.

In either case, another recipe can be selected. If the grill is at the right temperature to cook the newly selected recipe, the message disappears and cooking can start immediately.

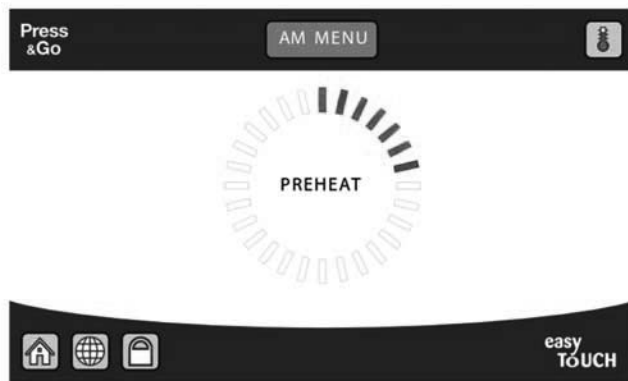

OPERATIONS OVERVIEW

The grill operates in several modes:

- **Press & Go** mode to preheat and to cook.
- **Sleep** mode to conserve energy.
- **Clean** mode to attain temperature for cleaning and reset cleaning reminders.

All operating modes are accessible using the easyToUCH™ screen. All modes except for Sleep can be selected from the Home screen. Clean mode can be selected from the Home screen or from the Press & Go screen.

Press & Go Mode



Press & Go mode is used to initiate preheat and cook on the grill.

Preheat

The grill will preheat after a menu has been selected in Press & Go mode. If multiple menus have been set up, select the appropriate menu first to ensure the grill preheats to the correct temperature, otherwise the menu is automatically selected after first ten (10) seconds for the last menu.

Menus and Recipes

Multiple menus can be set up, each using different set point and containing different or share recipes. The recipes stored by the grill contain the cooking profiles (times, temperatures, prompts and platen gap) for various products. Menus and recipes can be added, edited and deleted from the library. Cook time and/or platen gap may be changed for each recipe as well, depending on the grill set up.

Sleep Mode



Sleep mode lowers the platen to conserve energy during periods of inactivity, keeping it ready to start a cook cycle. When in Sleep mode, the grill will maintain the current temperatures.

Automatic Sleep Mode

The grill can be configured to enter Sleep mode automatically after a period of inactivity. Refer to **easyToUCH™ Diagnostics & Settings Menu**.

Manual Sleep Activation

User can also manually activate the Sleep mode when in Press & Go.

Clean Mode



Clean mode has two functions: brings the grill to the appropriate temperature for cleaning and it resets the cleaning counter.

If a cleaning temperature has been set, Clean mode will bring the grill to the set temperature prior to starting the cycle. A cleaning temperature may be specified if required by the chemicals used for cleaning.

Putting the grill into Clean mode before cleaning the grill updates the “Last cleaned” date and resets the cleaning reminder prompts, if these are enabled.

easyTOUCH™ Procedures

START UP & PREHEAT

1. Switch the grill on using the main power switch.

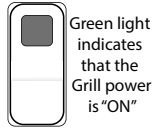

2. The easyTOUCH™ screen illuminates with the display briefly showing the software version.

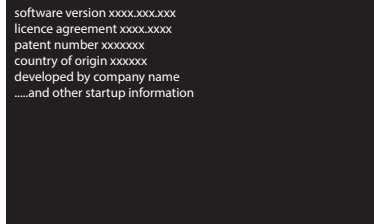

3. HOME screen appears. Select Press & Go. A choice of cook menus is displayed.



4. MENU SELECTOR screen appears. Choose the desired menu. If only one menu is available, grill will select it and quickly transition to preheat.



5. Preheating starts, using the set temperatures from the selected menu and the preheat progress is displayed.

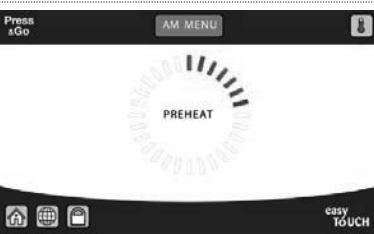

NOTE: To cancel preheating and exit to the Home Screen press . Select at the top to switch menus during preheat.

Following preheat the grill enters a soak period, allowing the temperature to stabilize throughout the upper platen. After soak, grill will start auto-gap & auto-leveling option feature.

6. The unit is ready to use when the platen opens and the Recipe Selector screen is displayed.



COOK A RECIPE

1. On the RECIPE SELECTOR screen, select a recipe to cook.

Lay product on the grill and press START or press the Green Push Button to begin the cycle.

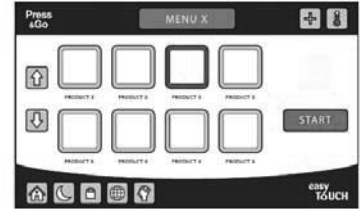

2. The screen displays a progress ring and the remaining cook time.



3. An audible warning sounds prior to the end of the cook cycle. When the cook cycle has finished, the platen lifts. Press the check mark or the Green button to clear the message.

4. The recipe selection screen reappears.

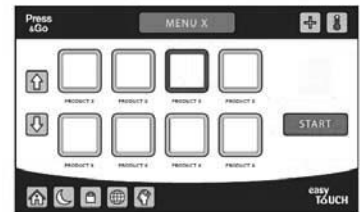

5. Selecting during the cooking stops the cook cycle. The cycle can also be aborted by pushing the Green push-button for two seconds.

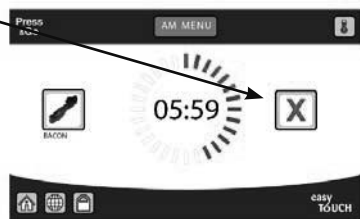

CHECK TEMPERATURES

The temperature screen shows the actual and the set point temperatures at each thermocouple.

1. The temperature screen can be displayed by pressing the icon in the top right corner when cooking, cleaning, or preheating.



2. Press the Back Arrow or the Check Mark to return to the previous screen.

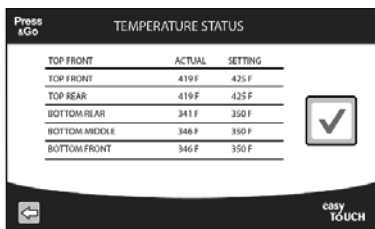

CANCELING A COOK CYCLE

1. Canceling the cook cycle raises the platen, and displays a “DISCARD PRODUCT” message. Press the check mark to clear the message.



NOTE: If the wrong recipe was selected, change the recipe by pressing **X** to stop the cook cycle. Then acknowledge the warning, select the correct recipe and press START or the GREEN push-button again. **Changes should be made promptly to avoid overcooking the product.**

CHANGE COOK TIME/GAP

The changes made to a recipe in this procedure in the Press & Go mode will still apply after the power is turned off. A recipe’s cook time and gap can be modified to allow for variations in product.

1. From the RECIPE SELECTOR screen, select a recipe and then press **+** at top right corner.

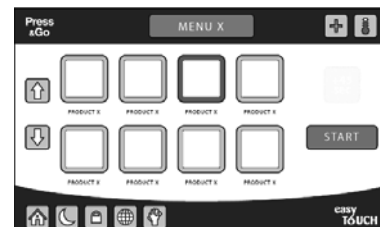

2. The COOK CYCLE CHANGE screen appears.
3. Use the up and down arrows to adjust the cook time and gap.

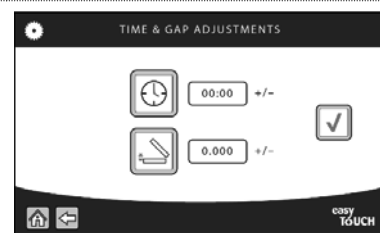

- Press **✓** to save.

NOTE: To disable this function for changing time or to adjust the pre-set limits, see Special Settings. The maximum allowable change is determined on settings.

4. Ready to cook product.

NOTE: The recipe with changes has a “+” indicator on the RECIPE SELECTOR screen.

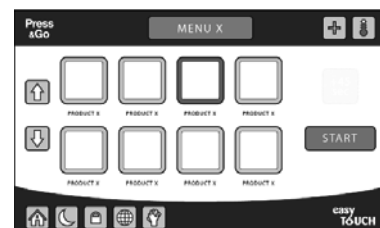

NOTE: The COOKING PROGRESS screen will show the new adjustments.



CREATE NEW RECIPE

The easyToUCH™ screen display, layout and icons shown herein are for guidance purposes only and are not intended to be an exact representation of those displayed on the grill.



1. Select All Recipes.



2. Enter password then press Return.

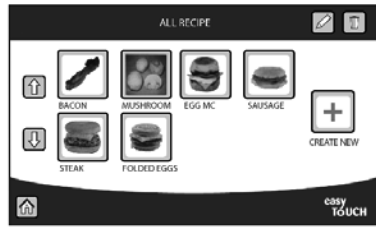

3. Press CREATE NEW.



4. Type your new Recipe Name then, press return.

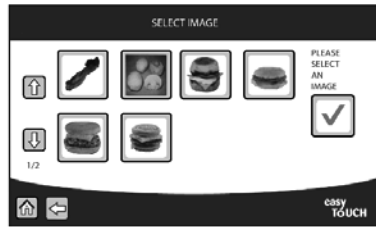

5. Select an image then, press check.



1. A recipe consists of one or more steps. A step may end with a prompt such as “Flip” or “Done” or no prompt. The total cook time for the recipe is the sum of the time for each step.

COOK TIME
MIN: 0 MAX: 9999 Sets the time for each step.

GAP
MIN: 0 MAX: 2000 For recipes that use the upper platen, this represents the gap between the platen and the grill surface, measured in mils (thousands of an inch). For flat recipes, skip this parameter.

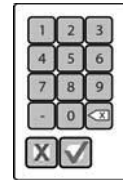

Numeric Key Pad option will pop up to allow parameter entry. Key in the number and press check.

FLAT COOKING For flat recipes, set Flat Cooking to YES to keep the upper platen raised.

PROMPT SELECTION Select which prompt to display at the end of the recipe step, or None. Pressing the button toggles through the available prompt options. See “Prompts” for information on creating and editing prompts.

UPPER PLATEN Set lower grill temperature from 149 F to 450 F. Use 32F/0F for OFF.

LOWER PLATEN Set lower grill temperature from 149 F to 400 F. Use 32F/0F for OFF.



Pressing the right arrow will give you an option to add another step to the recipe.



Pressing the list icon will display the steps in the recipe available (screen shown below).

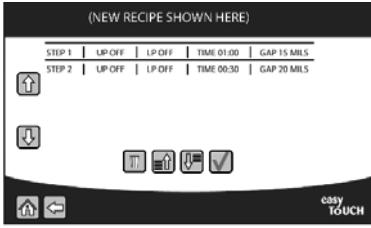

Select the step with arrows for editing, then press check.



Pressing the recycle bin icon will delete the row selected.

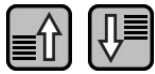

Pressing the up/down arrow icon will give the option to the selected step to move it up or down the list.



Pressing the check-mark icon will go back to the parameter entry/edit screen. Be aware this check-mark will not save your data inserted.



Pressing these up/down arrows icon will give the option to scroll up and down the list.

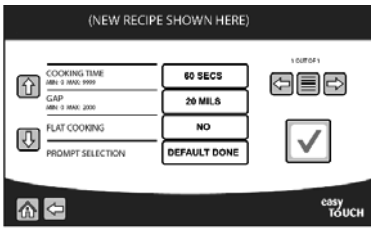

1. Press check-mark to save data.

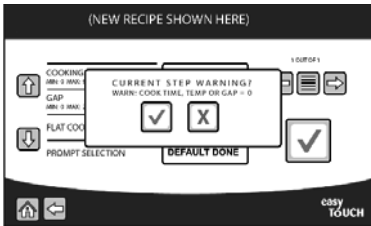

Warning sign

There may be a zero cook time, temp and/ or gap in your new recipe settings. Press to back and review.

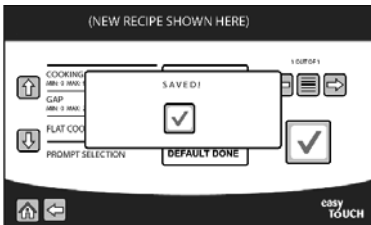

2. New recipe creation completed.

Editing an Existing Recipe

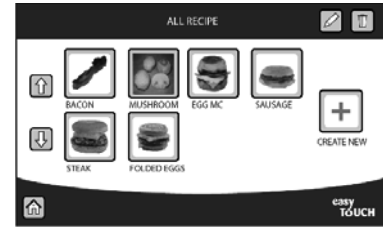

3. Press the pencil (top right of the screen) to edit an existing recipe. Similar to creating a new recipe, you will proceed through each screen;

- Recipe Name
- Image
- Protein (if applicable)
- Recipe Step(s).

Deleting an Existing Recipe

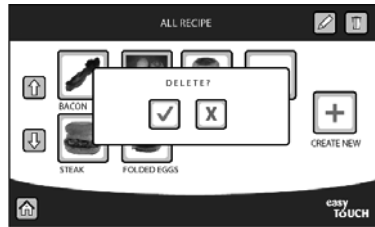

4. Select an existing recipe, then press garbage bin (top right) to confirm. Press check-mark to delete or to cancel.

SETTING UP FOR 2 STAGE COOKING, “ADD CHEESE”

Prompt definition offer the option to add cheese or other product at the end of the cooking process, the platen will come up, cheese added and the platen will come down with at higher gap without touching this gives the cheese a head start toward reaching its melting point or warm any other product. (Screen display, layout and icons shown herein are for guidance purposes only and are not intended to be an exact representation of those displayed on the broiler)



1. Go to SETTINGS.



2. Enter password then press Return.

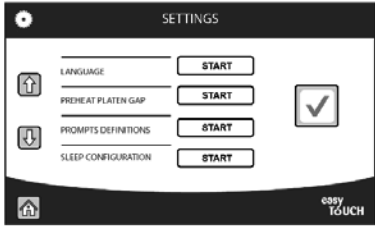

3. Scroll down to “PROMPTS DEFINITIONS” then press START.

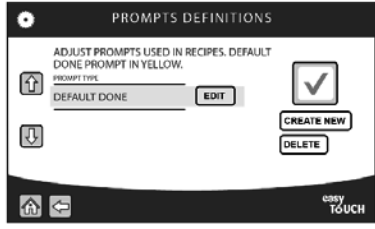

4. Select CREATE NEW.

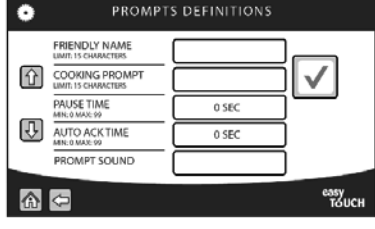

5. Five definition to complete:

- FRIENDLY NAME
- COOKING PROMPT
- PAUSE TIME
- AUTO ACK TIME
- PROMPT SOUND



6. Type definitions, (keyboard option will pop up to allow typing) then press RETURN.

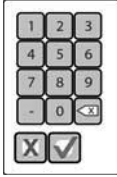

Numeric Key Pad option will pop up to allow parameter entry. Key in the number and press check.

Use for PAUSE TIME & AUTO ACK TIME.

The following definition is a sample of creating a ADD CHEESE on top of product that is cooking.

FRIENDLY NAME Type: CHEESE.

COOKING PROMPT Type: ADD CHEESE.

PAUSE TIME Type: 99.



AUTO ACK TIME Type: 0.

PROMPT SOUND Select any of the options.
Recommended: MED CHIRP

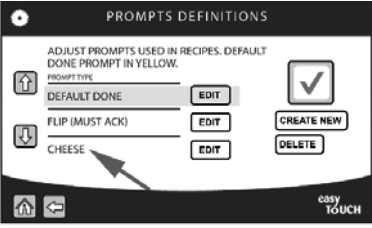

Pressing the check-mark icon will save the previous definition added. Screen will go back to PROMPT DEFINITION entry/edit screen.



7. Scroll down or up down or up with arrows   to check or edit the new prompt created, then press check-mark to save or delete.

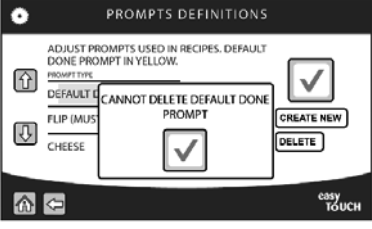

Note that the system wont allow you to delete the DEFAULT DONE.



Press the home icon to display Home and proceed with the next steps in the recipe.

The next step after a PROMPT DEFINITION is been created is to create a new recipe with the new PROMPT DEFINITION just created. For this sample will be creating a recipe “Add Cheese”. Follow the step of creating new recipe on this manual.

CREATE A NEW MENU

Menus offer the option to combine many recipes under one menu screen like breakfast, lunch and other menus available through the day.

1. Select Menus.



2. Enter password then press Return.



3. Press CREATE NEW.

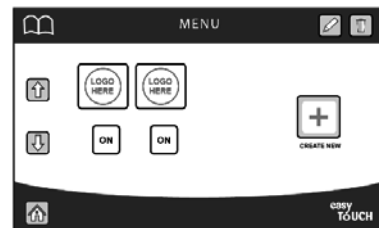

4. Type your new Recipe Name then, press return.



5. Enter preheat temperature settings.

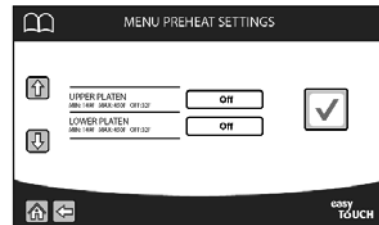

Set Upper Platen preheat temperature from 149 F to 450 F. Use 32F or 0F for OFF.
 Set Lower Platen preheat temperature from 149 F to 400 F. Use 32F/0F for OFF.
 Press check-mark to save.

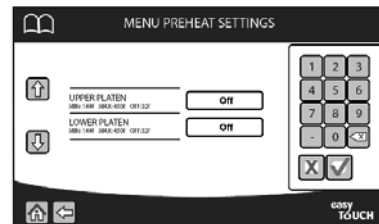

6. Select an image and press the check-mark to continue.



7. Select a recipe(s) to add to the menu and press the check-mark to continue.

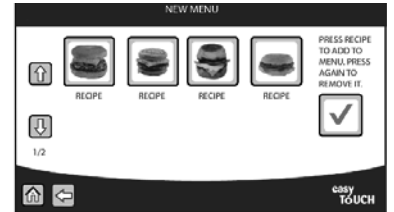

8. Pressing the up/down arrow icon will give the option to the selected step to move it up or down the list. Press the check-mark to continue.

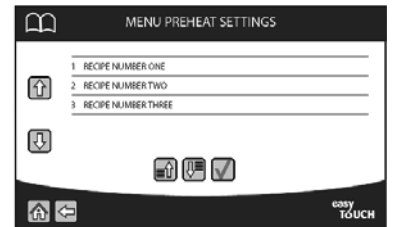

9. Menu creation completed. New menu will be OFF as a default, press OFF option to turn menu on.

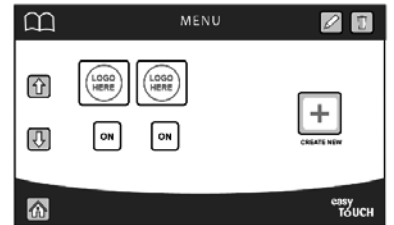

TURN MENUS OFF OR ON

Menus which can be enable or disable from the PRESS & GO option. That option can then be used with morning and afternoon restaurant menus.

1. Select Menus.

2. Enter password then press Return.

3. Press the option ON/OFF under the menu photo, the virtual button will switch to ON or OFF.

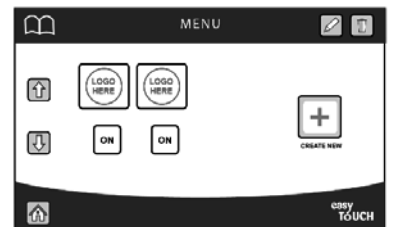

ACTIVATE SLEEP MODE MANUALLY

Sleep mode can be selected from the RECIPE SELECTOR screen to save energy during slow periods.

1. From the RECIPE SELECTOR screen, press .

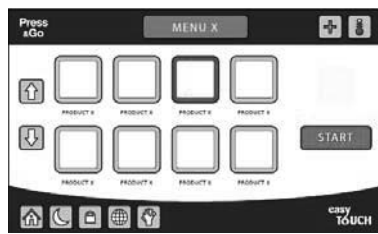

2. Press to continue or to cancel.

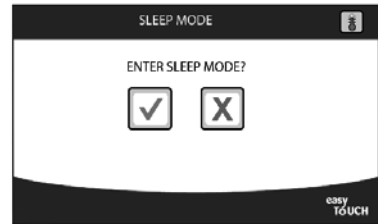

3. Top platen will close. Make sure no utensils are on the grill.
4. Press the Green button to cancel.



5. Screen will show sleeping time (hour:min). To exit Sleep mode, press WAKE on screen or the Green push-button. The platen will rise, the RECIPE SELECTOR screen appears, and the grill is ready to cook.



SHUTDOWN

1. Return to the HOME screen. Pressing the Home icon exits cooking mode and turns off the heaters.
2. Fully power off the grill and the easyToUCH™ screen using the main power switch.

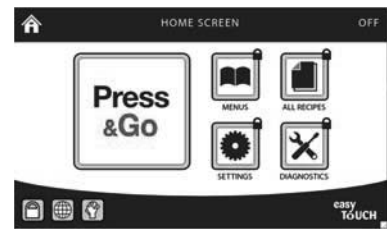

Green light indicates that the Grill power is "ON"

CLEANING REMINDERS

If a cleaning schedule has been set, a message will appear on the screen when cleaning is required based on the number of cook cycles:

- Select if the grill will be cleaned immediately, or to continue cooking.

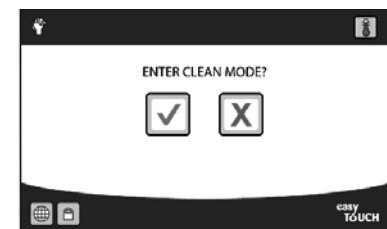

NOTE: If the grill is set to enforce cleaning schedule and the cleaning reminder has been bypassed too many times, easyToUCH™ eventually displays the CLEANING REQUIRED screen to enforce cleaning.

- Select to start the Clean mode which resets the cleaning reminder counter and brings the grill to the right temperature for cleaning (if specified).



SPECIAL SETTINGS — TIME & GAP ADJUSTMENT LIMITS

This setting limits the size of the cook cycle adjustments that can be made for a recipe using **Change Cook Time/Gap**. For example, if the time is set to 00:10, then the COOK CYCLE ADJUSTMENT screen will only allow the operator to increase or decrease the cook time by up to ten (10) seconds.

1. Select SETTING.



2. Enter password and press return.



3. Use down arrow to scroll to "Time and Gap Adjustments".

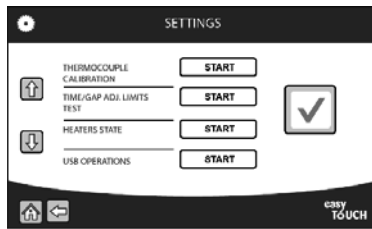

4. TIME & GAP ADJUSTMENTS screen: set to zero to prevent users from adjusting the cook cycle.

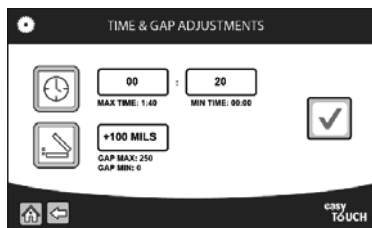

5. When the time or gap number button is selected, a numeric keypad appears.

Enter the new settings and select to proceed.

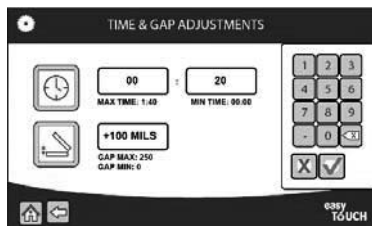

6. Select to save the new settings.

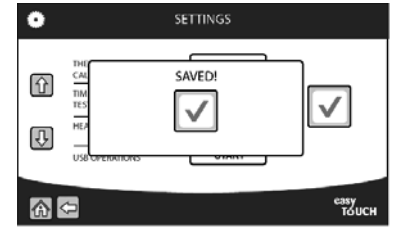

VOLUME ADJUSTMENT

This setting will set the levels of volume.

1. Select SETTING.



2. Enter password and press return.



3. Use down arrow to scroll to "Volume".

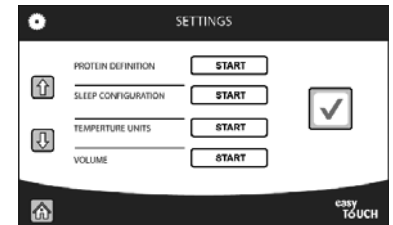

4. Select button beside volume, select option Low, Med or High. Enter the new settings and select to proceed.

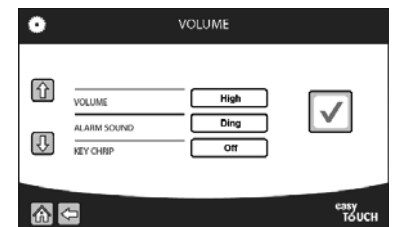

HOOD HEIGHT ADJUSTMENT

This setting limits the height of the top platen adjustment. Ensure a minimum of 1" clearance between the hood and the uppermost position of the platen arm.

1. Select SETTING.

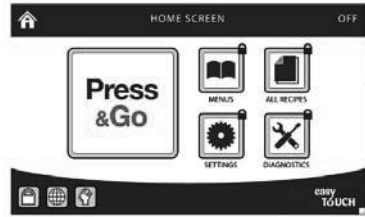

2. Enter password and press return.



3. Use down arrow to scroll to "HOOD HEIGHT". Press START button.

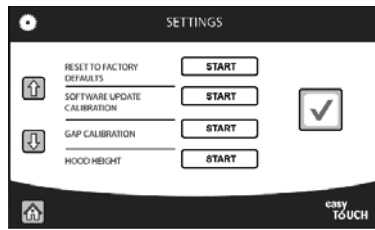

4. Record the number as reference under the PLATEN POSITION SETPOINT box.

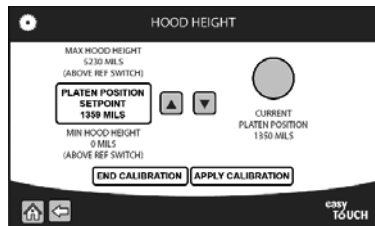

TIP:

Use the up and down arrows to move the platen height, the upper arrow option will go in multiples of 6 mils, and the lower arrow down in multiples of 4 mils. Factory default is 1366 MILS



5. When the PLATEN POSITION SETPOINT box is selected, a numeric keypad appears. Enter the new settings and select to proceed.

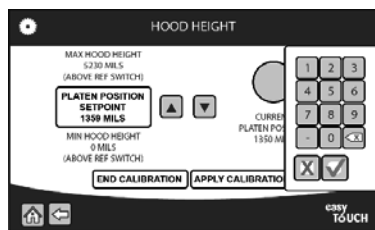

6. Select APPLY CALIBRATION to set the new setpoint.
7. Select END CALIBRATION to save the new setpoint.
8. Hood height calibration completed. System will go back to home.

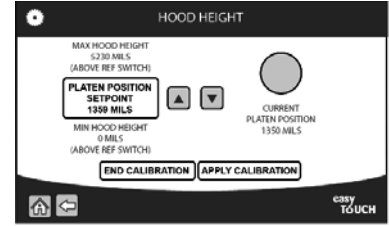

LANGUAGE SELECTION

This setting will give the option to choose different language in the display.

1. Select SETTING.

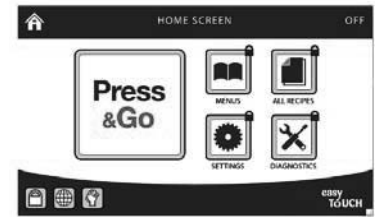

2. Enter password and press return.



3. Use down arrow to scroll to "LANGUAGE". Press START button.



4. Select the language then press the checkmark.

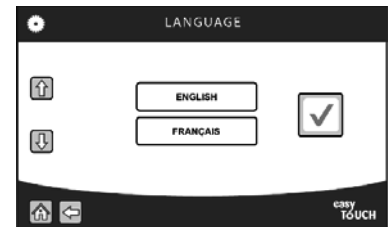

5. A save window will appear indicating that is saved.

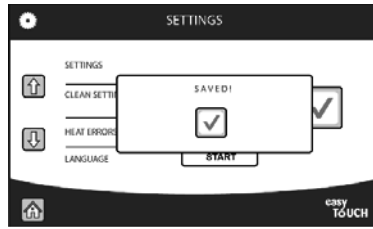

6. Language selection completed. System will go back to settings.

TIP:

Use the World icon for a Language selection short cut



CLEAN SETTINGS

This setting will give the option to control grill temperature, clean frequency and clean time during the process of cleaning. Computer will manage your cleaning schedule automachally.

1. Select SETTING.

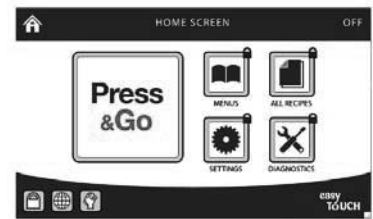

2. Enter password and press return.



3. Use down arrow to scroll to "CLEAN SETTINGS". Press START button.



4. Select an option, numeric pad will appear, enter new settings.

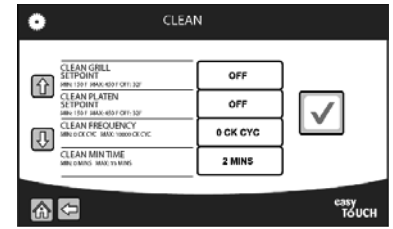

- CLEAN GRILL – this option will configure the lower grill, you can set up temperature from 150F to 450F or turn off this option by typing 32 on the numeric pad. Factory default is 325°F.
- CLEAN PLATEN – this option will configure the upper grill, you can set up temperature from 150F to 450F or turn off this option by typing 32 on the numeric pad. Factory default is 325°F.
- CLEAN FREQUENCY – this option will configure the cooking cycle you permit between clean time, computer will automatically detects when is time to clean your grill. ex: 10 CK CYC will automacatically tell you after 10 cooking cycle that CLEANING REQUIRED.
- CLEAN MIN TIME – this option will set the time of cleaning, could be from 1 to 15 minute time.
- CLEAN GRACE PERIOD – this option will set the computer automatically to count the cooking cycle after clean frequency cycles completed, when clean grace period count is completed the computer will force the grill to CLEANING REQUIRED as only option. Clean grace period calibration is by cook cycle from 0 to 1000.
- CLEAN PROMPT FREQ – this option will set the computer to automatically detects when is time to clean. Calibration Cook Cycle from 0 to 1000
- CLEAN SETPOINT TOLERANCE – this option will set the temperature setpoint tolerance. Temperature can be calibrate from 5°F to 50°F
- CLEAN READY ALARM – this option will set the alarm to OFF / DING / STOVE / SONG.

5. A window will appear indicating that is saved.

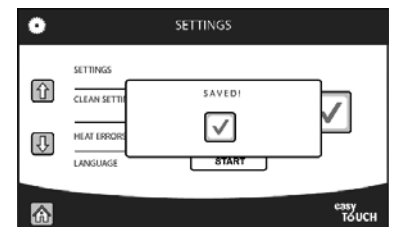

6. Clean settings completed. System will go back to settings.

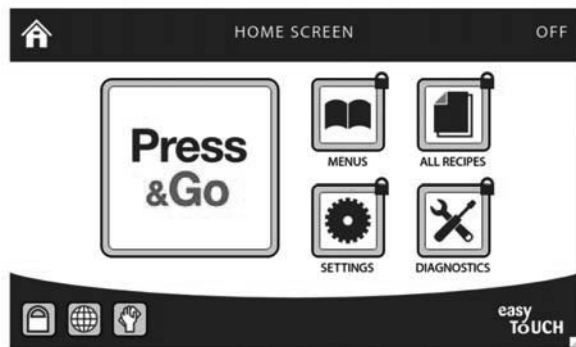

- Temperature Status
- Cooking Cycle Change
- Enter Clean Mode
- Sleep Mode
- Set Language
UI keyboard=special characters/
Symbols/#

- home page** → PRESSGO
 MENUS
 SETTINGS
 ALL RECIPES
 DIAGNOSTICS

- PressGo** → AM MENU
 → BACON
 MUSHROOM
 EGG
 SAUSAGE
 STEAK
 EGGS

- Menus** → AM MENU
 PM MENU
 AM MENU LRS
 PM MENU

- Settings** → FACTORY
 → PASSWORD
 TIME
 DATE
 FACTORY SETTINGS
 RECIPE RESET (from USB)
 SOFTWARE UPDATE
- CALIBRATION
 → GAP CALIBRATION
 HOOD HEIGHT
 THERMOCOUPLE CALIBRATION
 TIME/GAP ADJ. LIMITS
- TEST
 → HEATERS STATE
 USB OPERATIONS
- SETTINGS
 → CLEAN SETTINGS
 HEAT ERRORS & LIMITS
 LANGUAGE
 PROMPTS DEFINITIONS
 PROTEINS DEFINITIONS
 SLEEP DEFINITIONS
 TEMPERATURE UNITS
 VOLUME

- All Recipe** → QUARTER
 ANGUS
 GR CHICKEN
 BACON
 MUSHROOM
 EGG
 SAUSAGE
 STEAK

NOTE: (RECIPE WILL VARY DEPENDING ON RESTAURANT MENU)

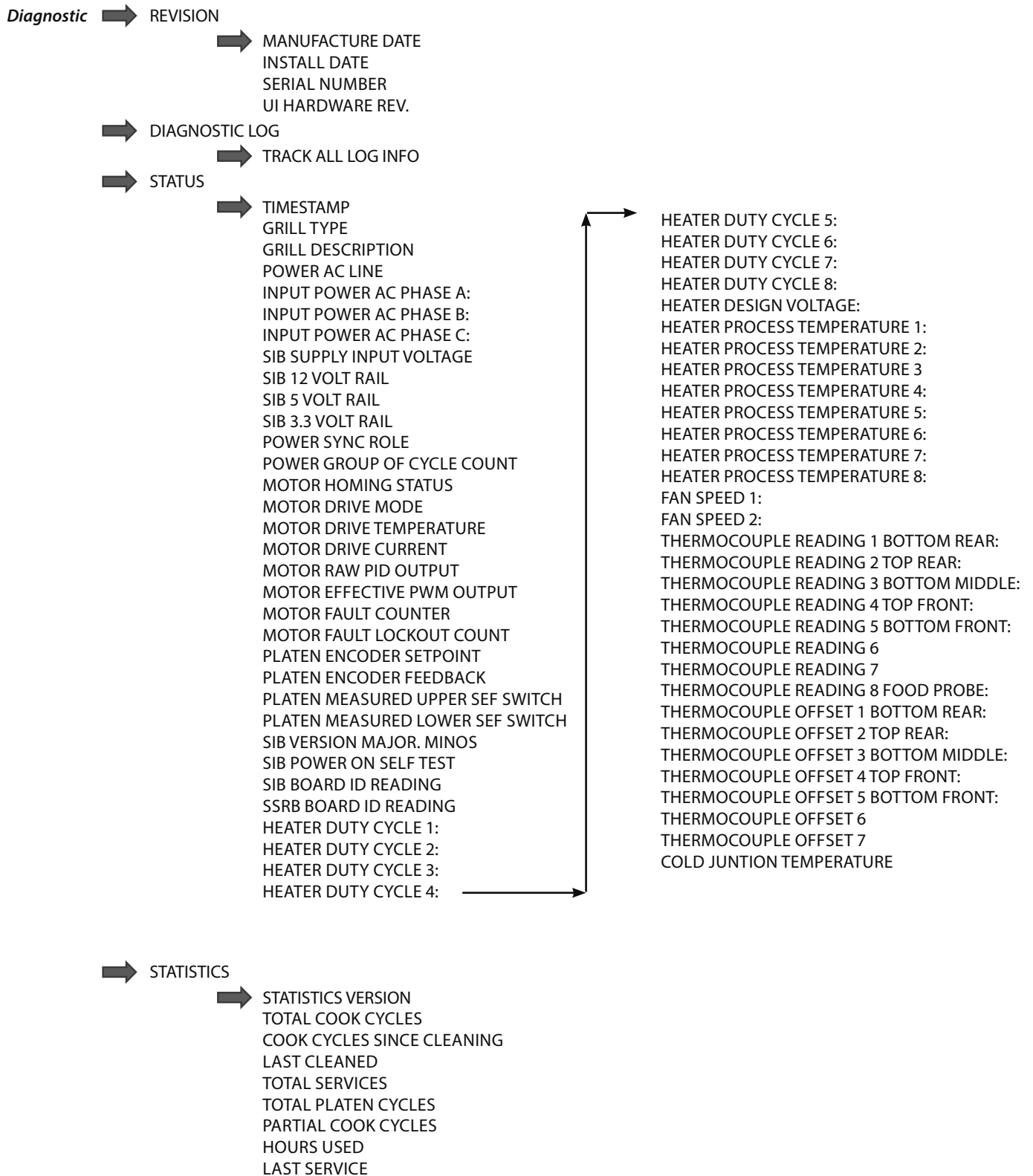

Section 4

Maintenance

Cleaning the easyToUCH™ controller

- Select lock icon  on the panel, to temporarily lock the touch screen for fifteen (15) seconds.
- Apply food safe cleaner to soft cloth or sponge, not directly on controller. Wipe controller and dry with a soft clean cloth.
- Do not use abrasive cleaners, steel-wool pads or abrasive paper towels to clean the controller, as bristles will scratch the controller surface.

Cleaning the Stainless Steel Panels

- Turn-Off-Power Switch and unplug when cleaning the side panels or front panel of the grill.
- Turn-Off-Power Switch and disconnect all power plugs before cleaning back panel. Refrain from touching anything electrical when you've got wet hands or bare feet.
- Once the unit has cooled external stainless steel panels should be cleaned using a mild detergent and/or a food-safe liquid cleaner designed to clean stainless steel, a soft cloth and hot water.
- If it is necessary to use a nonmetallic scouring pad, always rub in the direction of the grain in the metal to prevent scratching.
- **Warning:** Do not remove any panel for cleaning.
- Wash a small area at a time and rinse the washed area with a clean sponge dipped into a disinfectant. Wipe dry with a soft clean cloth.
- Do not spray chemicals into any openings, such as louvers on the front or rear vent panels. Doing so can damage critical components, resulting in a non-warranty service call.
- Keep water and/or cleaning solution away from the front main power switch and power cords. Do not spray any solution to these parts.
- The grill may be secured in the grill bay by using two anchors that lock onto the front casters. Reattach all safety clips and restraining cables (gas models) before completing the cleaning.

Cleaning During Operation

1. After each product load is removed, use a grill scraper to scrape grease on lower grill plate from front to back only. Do not scrape left to right across the lower grill plate with the grill scraper.
2. Use a grill squeegee to clean release material sheet on upper platen in a downward motion. Do not press hard against the release material sheet to prevent scratching or tearing.
3. Push the grease to the rear of the grill, or pull it to the front trough. Then, squeegee the grease into the buckets on either side. Do not use the scraper for this step.
4. Use a clean, damp cloth to clean back splash and bull nose areas as needed during operation.



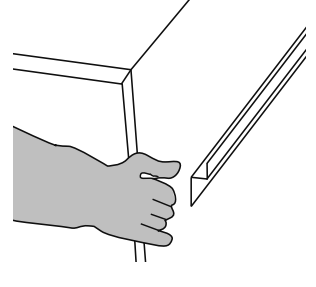
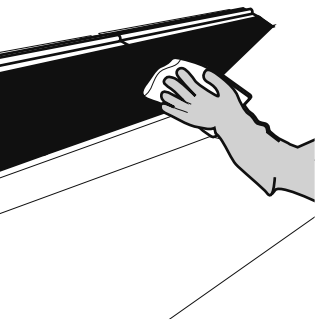
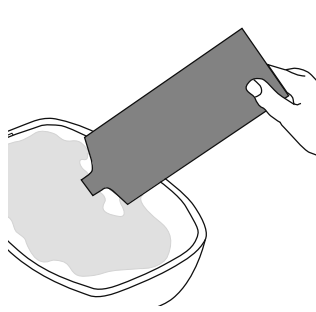
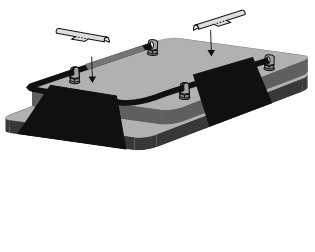
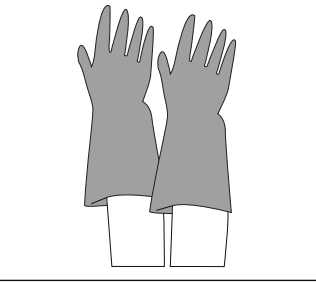
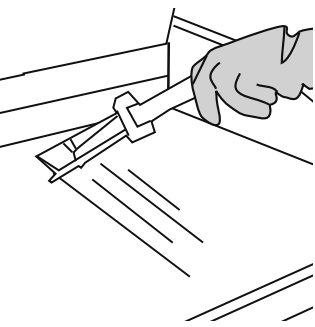
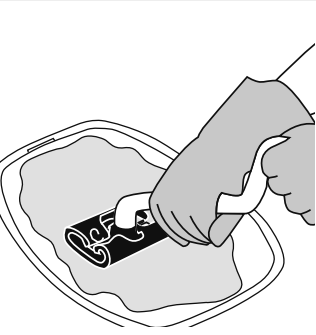
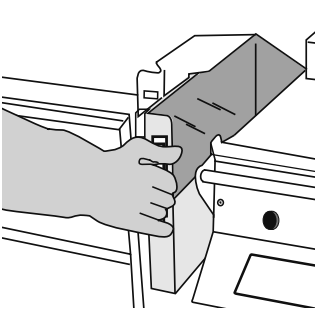
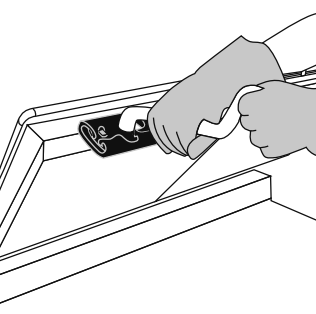

NOTE: To increase life of release material sheets, wipe them down with a folded clean, damp cloth at least four times during each hour of operation.

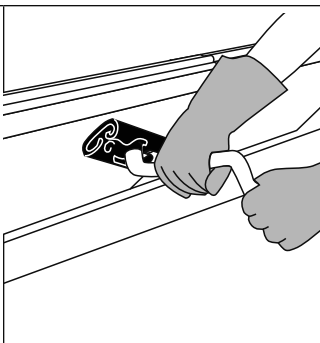
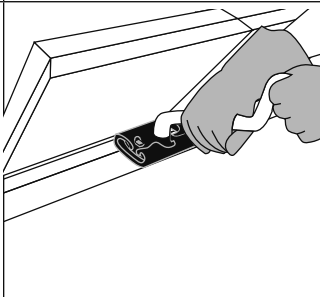
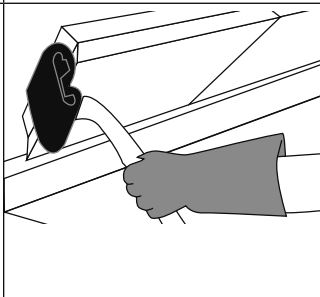
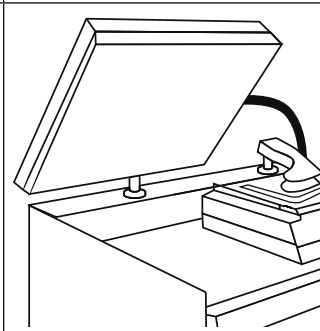
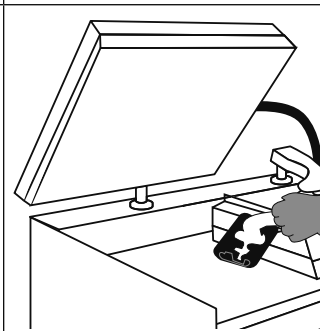
Daily Cleaning

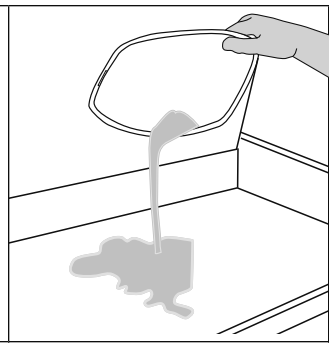
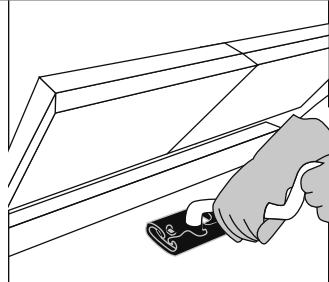
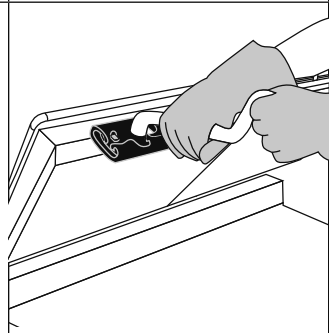
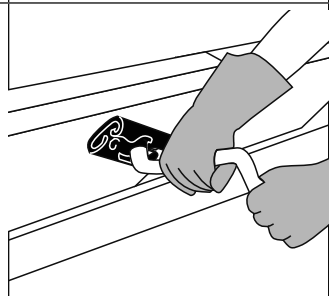
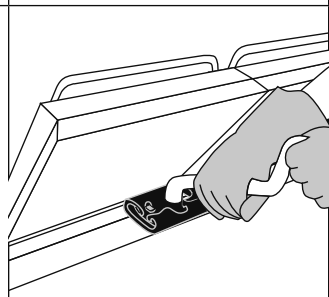
<p>1. Select Clean mode for each platen and, once Clean mode has been reached, turn each zone OFF and turn</p> <p>NOTE: Turn main switch OFF when cleaning platens.</p>		<p>6. Remove the lower support rail of the grease troughs from each side.</p>	
<p>2. Wipe release material sheet with a clean, sanitizer-soaked grill cloth.</p>		<p>7. Pour Hi-temp Grill cleaner into a bucket or stainless steel pan.</p>	
<p>3. Lower platen and remove the locking clips, the U bar and release sheets. Wash, rinse and set aside locking clips and U bar. Set release sheet aside for further cleaning.</p>		<p>8. Put on the heat-resistant gloves and safety glasses.</p>	
<p>4. Scrape the lower grill surface with the scraper. Use the grill squeegee to push residual grease into trough. Wash and rinse the squeegee and scraper.</p>		<p>9. Dip the Grill Cleaning Pad & Handle into the grill cleaner. Never use a steel scraper to clean the platens.</p>	
<p>5. Remove the grease buckets from each side.</p>		<p>10. Apply the grill cleaner to front side of platens starting from right platen to left platen. DO NOT SCRUB.</p>	

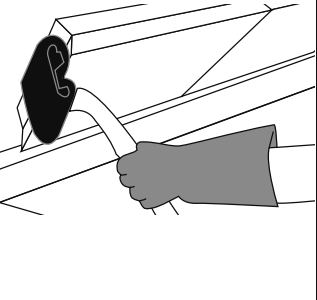
<p>11. Apply the grill cleaner to the platen surfaces starting from right platen to left platen. DO NOT SCRUB.</p>	
<p>12. Apply the grill cleaner to the back side of platens starting from right platen to left platen. DO NOT SCRUB.</p>	
<p>13. Apply the grill cleaner to the outer edges of right and left platens. DO NOT SCRUB.</p>	
<p>14. Press green button to lower right platen and turn main switch Off.</p>	
<p>15. Apply the grill cleaner to inner edges of the right and left platens. DO NOT SCRUB. Turn Main Switch On</p>	

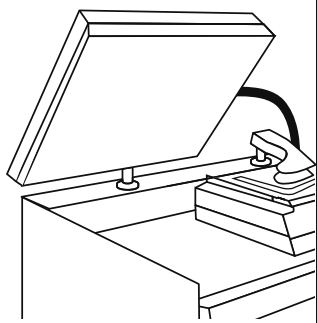
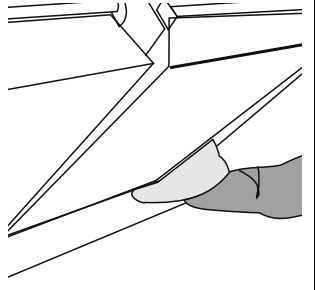
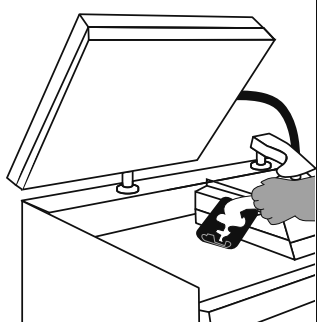
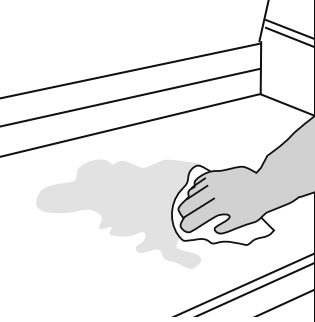
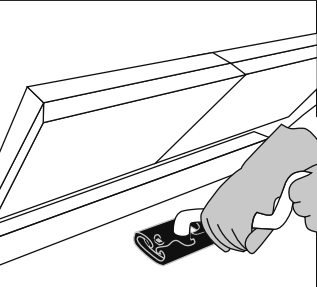
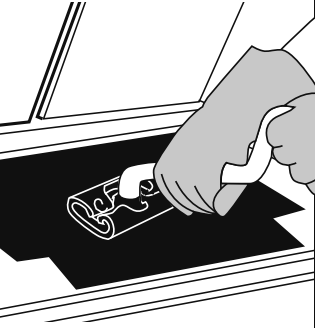
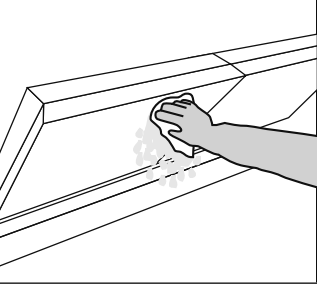
<p>16. Press green button to raise the right platen and turn main switch Off. Pour remaining Hi-temp Grill Cleaner over the bottom grill surface.</p>	
<p>17. Spread the cleaner over the entire lower grill surface from front to back using even strokes. DO NOT SCRUB.</p>	
<p>18. Start scrubbing now. Scrub front side of platens starting from right platen to left platen.</p>	
<p>19. Scrub flat grill surface starting from right platen to the left platen.</p>	
<p>20. Scrub back side of platens from right platen to the left platen.</p>	

<p>21. Scrub outer edges of right and left platens and turn main switch Off.</p>		<p>26. Turn main switch On, lower the platen and turn main switch Off. Rinse inner edges of both platens.</p>	
<p>22. Press green button to lower right platen and turn main switch Off.</p>		<p>27. Turn main switch On, raise the platen and turn main switch Off. Rinse and wipe back of lower grill.</p>	
<p>23. Scrub the grill cleaner to inner edges of the right and left platens. Turn Main Switch On.</p>		<p>28. Pour a small amount of lukewarm water on a clean, sanitizer-soaked grill cloth over the bottom grill surface and wipe off residue.</p>	
<p>24. Press green button to raise the right platen and turn main switch Off. Scrub lower grill surface.</p>		<p>29. Place upper platen release material sheets flat on grill surface. Gently clean both sides of the release material sheet.</p>	
<p>25. Rinse and wipe front, side and back of platen surfaces with a clean, sanitizer soaked grill cloth.</p>		<p>30. Rinse both sides of the release material sheet with clean sanitizer-soaked grill cloth. Reinstall release material sheet and secure in place.</p>	

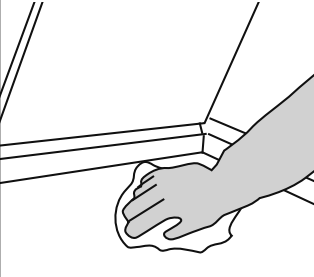
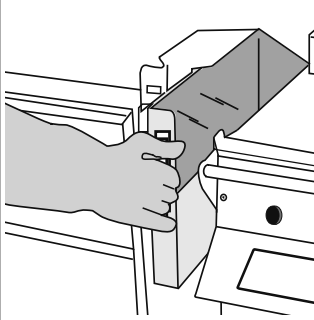
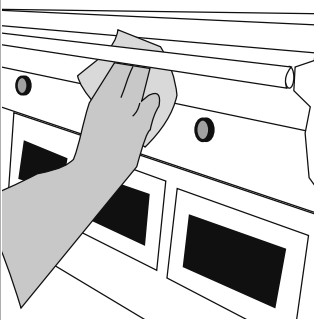
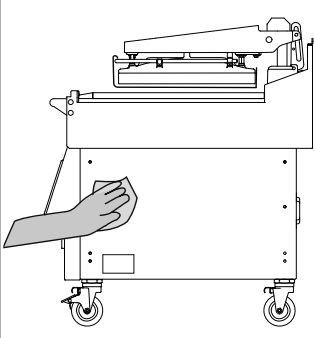
<p>31. Wipe lower grill with a clean sanitizer-soaked grill cloth. Repeat until no visible soil remains.</p>	
<p>32. Empty, wash, rinse and replace the lower support rail and the grease buckets.</p>	
<p style="text-align: center;">⚠ Warning</p> <p>Turn grill off and unplug the unit before cleaning the side/back panels. Do not remove any panel during cleaning.</p>	
<p>33. Wipe remaining grill surfaces with a clean, sanitizer-soaked grill cloth.</p>	
<p>34. Wipe grill side surfaces with a clean, sanitizer-soaked grill cloth. Remember to clean always in the direction of the grain. Do not remove panel by any circumstance, if grease migrate inside the grill call service technician for support.</p>	

Moving the Grill

⚠ Caution

Ensure platens are down, in closed position, when moving grill. Avoiding procedure may cause damage or loss of calibration on the platen and potential of error message can occur.

1. Turn main switch ON.
2. Press green button to lower platens(s).
3. Turn main switch OFF.
4. Unplug power cord.
5. Unplug gas connection (if applicable).
6. Disconnect restraining cable (gas models).
7. Release front casters brake.
8. Move unit from the towel bar only.

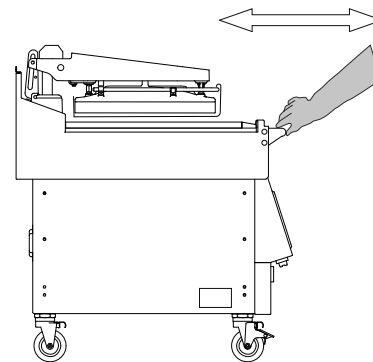

Section 5 Troubleshooting

Cooking Issues

Problem	Cause	Correction
Undercooked product	Incorrect recipe selected	Select correct recipe and retry.
	Cook time too low	Use cook cycle change screen to increase cook cycle.
	Raw product too cold	Check that uncooked product is at correct temperature (not frozen).
	Raw product too thin	Use cook cycle change screen to decrease cook gap.
	Cook cycle stopped/aborted early by operator	Discard product.
	Cook cycle stopped/aborted early by itself	Discard product.
	Grill not at temperature before starting cycle	Use temperature status screen to check zone temperatures versus set point.
	Grill temperature incorrect	See Temperature Issues.
Undercooked product only at front of grill	Possible element problems	See: Heater Problem.
	Kitchen ventilation affecting temperatures	Check whether cool or high volumes of air are directed towards the grill.
	Release material sheet misplaced	Check release material sheet installation in Section 2.
	Inconsistent gap setting (front to back or side to side)	Contact qualified service agency.
Overcooked product	Incorrect recipe selected	Select correct recipe and retry.
	Cook time too high	Use cook cycle change screen to decrease cook cycle.
	Raw product too warm	Check that uncooked product is at correct temperature (frozen meat not thawed).
	Raw product too thick	Use cook cycle change screen to increase cook gap.
	Poor quality raw product	Retry recipe with newer product.
	Inconsistent gap setting (front to back or side to side)	Contact qualified service agency.
	Grill over temperature before starting cycle	Use temperature status screen to check zone temperatures versus set point.
	Grill temperature incorrect	See Temperature Issues.

Temperature Issues

Problem	Cause	Correction
Grill or platen too hot	Recipe set points are high	Use temperature status screen to check zone temperatures versus set point.
	Temperature calibration incorrect	Reset offsets to default value and verify temperatures (default = 0° offset).
	Thermocouple wiring incorrect	Select the temperature status screen. Place a wet rag onto each thermocouple location and watch for a temperature drop at that zone.
Grill or platen too cool	Recipe set points are low	Use temperature status screen to check zone temperatures versus set point.
	Kitchen ventilation affecting temperatures	Check whether cool or high volumes of air are directed towards the unit.
	Temperature calibration incorrect	Reset offsets to default value and verify temperatures (default = 0° offset).
Unable to reach or maintain temperature	Contact or disengaged	Turn main power switch off and on, and listen for contact or disengaging.
	Temperature calibration incorrect	Reset offsets to default value and verify temperatures (default = 0° offset).

User Interface Issues

Problem	Cause	Correction
No sound	Volume set too low	Set volume to high.
Screen locked out, frozen, non-responsive to touch	Software issue	Turn off unit using main power switch, turn on after 10 seconds. If not working, connect a mouse to the USB port and check for pointer movement.
Touch screen rebooting	Main power lost	Use voltmeter to confirm main power connected and live.
Unable to read USB	Flash drive faulty	Retry with known good quality flash drive.
	Flash drive full (when attempting to collect log file)	Delete all files on flash drive and retry.
	USB cable disconnected	Check if USB connector is seated properly.
Unable to load USB files	Flash drive faulty	Retry with known good quality flash drive.
	Files on flash drive incorrect or corrupt	Delete all files on flash drive and reload update files.

Section 6 Tools & Cleaning Supplies

Recommended Cleaning Supplies

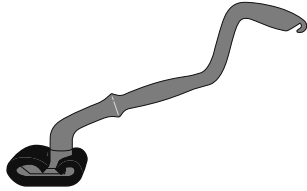

Grill Cleaning Pad & Handle

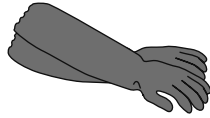

Heat-Resistant Gloves



Clean, Sanitizer-Soaked
Grill Cloths



Grill Squeegee

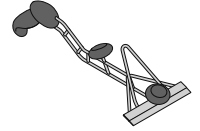

Grill Scraper

Note: Cleaning supplies not included with the purchase of your new grill from manufacturer.

Notes



Every new piece of Manitowoc Foodservice equipment comes with KitchenCare™ and you choose the level of service that meets your operational needs from one restaurant to multiple locations.

StarCare – Warranty & lifetime service, certified OEM parts, global parts inventory, performance audited

ExtraCare – CareCode, 24/7 Support, online/mobile product information

LifeCare – Install & equipment orientation, planned maintenance, KitchenConnect™, MenuConnect

Talk with KitchenCare™ • 1-844-724-CARE • www.mtwkitchencare.com

To learn how Manitowoc Foodservice and its leading brands can equip you, visit our global web site at www.manitowocfoodservice.com, then discover the regional or local resources available to you.

