



**PROTECH
OWNERS & OPERATORS
INSTRUCTION MANUAL**



Protech Model 4500

Model # _____

Serial # _____

**Protech
Series**



USDA
LISTED

Manufactured in compliance with ISO9000 standards

FOR GLOBE PROTECH SLICER MODELS 4500, 4750, 4875V

For service contact:

(place service sticker here)

Globe Food Equipment
1-937-299-5493

— IMPORTANT SAFETY NOTICE —

This manual contains important safety instructions which must be strictly followed when using this equipment.

— NOTICIA IMPORTANTE —

Este Manual contiene importantes instrucciones de seguridad que deben ser seguidas el pie de la letra cuando utilice esta máquina.

INDEX

ATTENTION-WARNING-CAUTION	4
KEY COMPONENTS	5
SAFETY TIPS	6
INSTALLATION-PROPER GROUNDING	7
OPERATING INSTRUCTIONS	9
AUTOMATIC INSTRUCTIONS	11
CLEANING	13
KNIFE SHARPENING	18
SIMPLE MAINTENANCE AND REPAIR	22
OPTIONAL ACCESSORIES	25
OPTIMAL SLICING PERFORMANCE	27
TROUBLESHOOTING	28
WARRANTY	29



GLOBE FOOD EQUIPMENT CO.
P.O. BOX 3209
DAYTON, OHIO 45401
PHONE: 937/299-5493
FAX: 937/299-4147
E-MAIL: globeinfo@globe-food.com
WEBSITE: globe-food.com

ATTENTION OWNERS AND OPERATORS!

Globe's equipment is designed to provide safe and productive processing of food products as long as the equipment is used in accordance with the instructions in this Manual and is properly maintained. Importantly, unless the operator is adequately trained and supervised, there is a possibility of serious injury. Owners of this equipment bear the responsibility to make certain that this equipment is used properly and safely, strictly following all the instructions contained in this Manual and the requirements of local, state or federal law.

Owners should not permit anyone to touch this equipment unless they are over 18 years old, are adequately trained and supervised, and have read and understood this Manual. Owners should also ensure that no customers, visitors or other unauthorized personnel come in contact with this equipment. Please remember that Globe cannot anticipate every circumstance or environment in which its equipment will be operated. It is the responsibility of the owner and the operator to remain alert to any hazards posed by the function of this equipment -- particularly the sharp knife and all moving parts. If you are ever uncertain about a particular task or the proper method of operating this equipment, ask your supervisor.

This Manual contains a Safety Tips Section listing a number of precautions to follow to help promote safe use of this equipment. Throughout the Manual you will see additional warning to help alert you to potential hazards.

Warnings affecting your personal safety are indicated by:



Warnings related to possible damage to the equipment are indicated by:



A wall chart, which includes safety instructions is also included with this equipment. This wall chart should be posted near the Slicer within easy view of the operator. You should also make certain that the Manual is available for easy reference by any operator. Globe has put several warning labels in the English language on its Slicers. Spanish labels are packed in the shipping carton and can replace the English labels at the owner's option. If any warning label, wall chart, or Manual becomes misplaced, damaged, or illegible, or if you require additional copies, please contact your nearest representative or Globe directly.

Please remember that this Manual, the wall chart, or the warnings do not replace the need to be alert, to properly train and supervise operators, and to use common sense when using this equipment.

KEY COMPONENTS OF THE SLICER

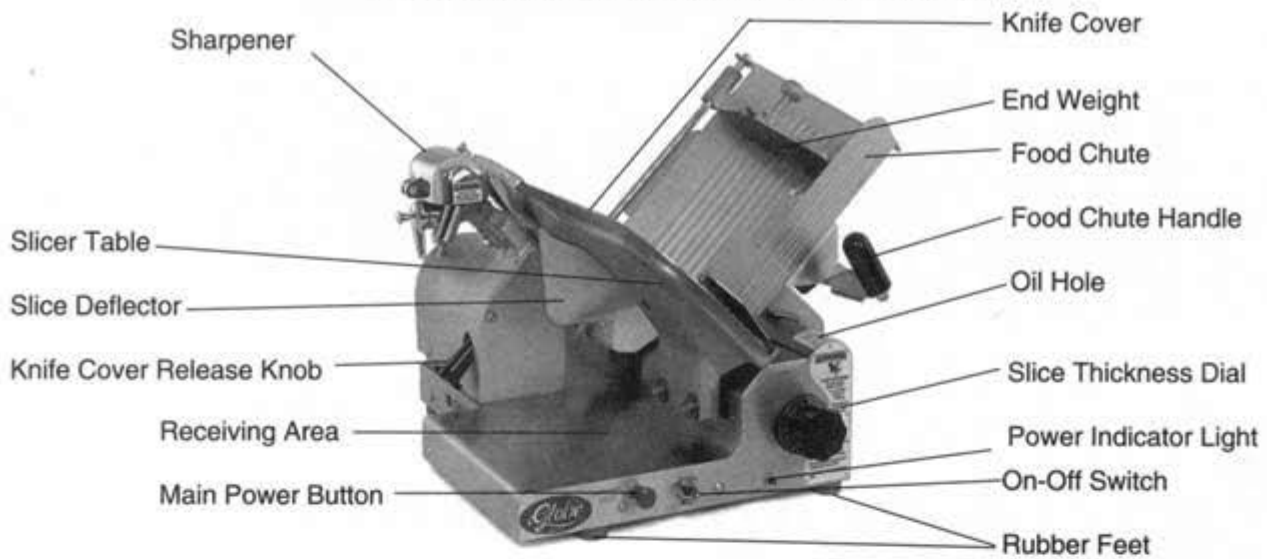

4500 FRONT VIEW

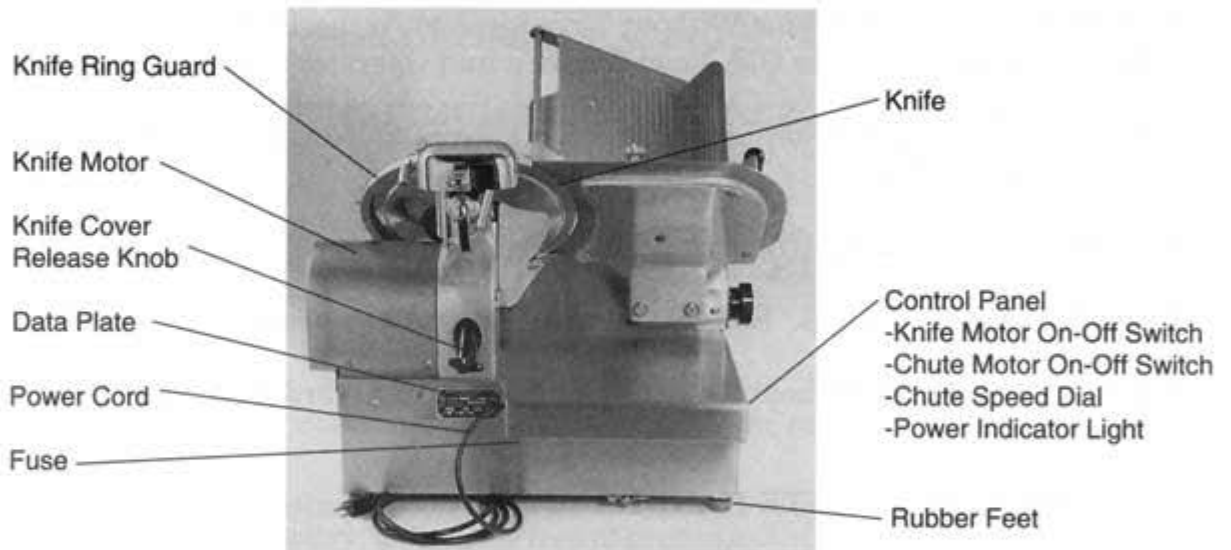

4875V SIDE VIEW

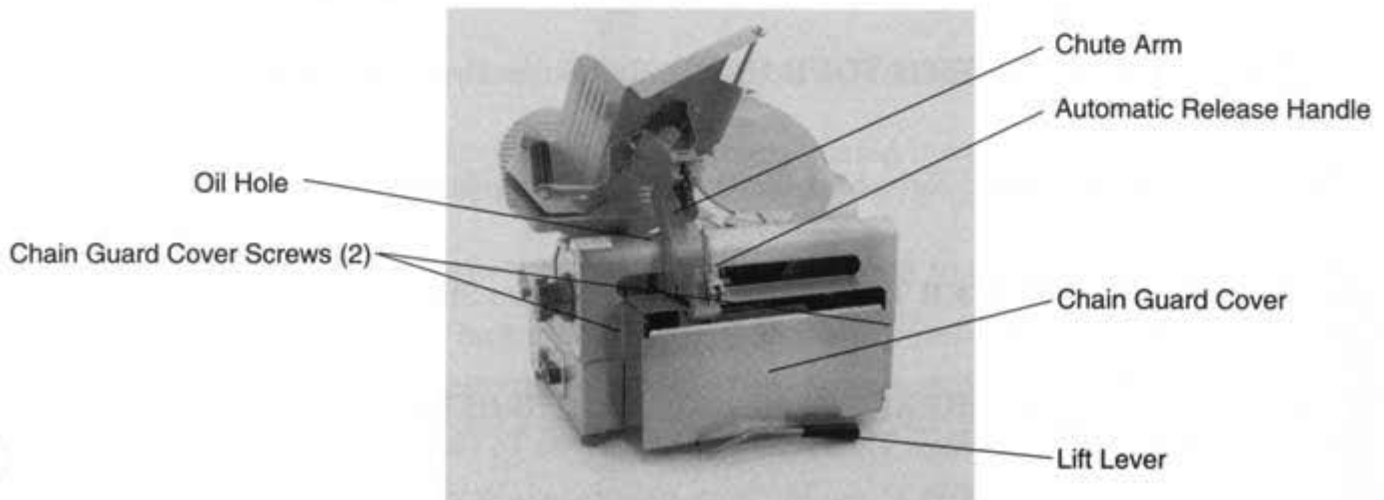

MODEL 4875V SIDE VIEW

GLOBE SLICER SAFETY TIPS



WARNING



SHARP KNIFE TO AVOID SERIOUS PERSONAL INJURY

- **NEVER** Touch This Machine Without Training And Authorization From Your Supervisor Or If You Are Under 18 Years Old. Read Owner's And Operator's Manual First.
- **ONLY** Install On Level Non-Skid Surface In Clean, Well-Lighted Work Area Away From Children And Visitors.
- **ALWAYS** Ground Slicer Utilizing Proper Power Source.
- **NEVER TOUCH KNIFE.** Keep Hands And Arms Away From All Moving Parts.
- **NEVER OPERATE** Without Knife Cover, Knife Ring Guard And Chain Guard Cover Securely Installed.
- **ONLY USE FOOD CHUTE HANDLE** To Push Food Chute During Manual Slicing.
- **ONLY USE THE END WEIGHT, NOT YOUR HAND,** To Hold Food Products When Slicing. Never Put Your Hand On Or Around Food Chute When Slicer Is On.
- **DO NOT CATCH SLICES WITH YOUR HAND.** Let Slices Drop On Paper-Covered Receiving Area.
- **ALWAYS** Turn Off Slicer And Turn Slice Thickness Dial Completely Clockwise After Each Use.
- **BEFORE CLEANING SLICER TABLE AND KNIFE,** Turn Slicer Off, Turn Slice Thickness Dial Clockwise to Closed Position, Remove Chute And Unplug Slicer.
- **BEFORE CLEANING, SHARPENING, SERVICING, OR REMOVING ANY PARTS,** Always Turn Slicer Off, Turn Slice Thickness Dial Clockwise To Closed Position, Remove Chute And Unplug Slicer.
- **USE ONLY GLOBE SLICER ACCESSORIES** Properly Installed.

INSTALLATION

UNPACKING:

Unpack the slicer immediately after receipt. If the machine is found to be damaged, save the packaging material and contact the carrier within fifteen (15) days of delivery. Immediately contact your source of the equipment.

You should receive with the slicer, legs (on Model 4500 only), rubber feet, Globe oil, operation and care manual and wall chart. Contact Globe or your local supplier if you did not receive all of these materials.



WARNING

TO AVOID SERIOUS PERSONAL INJURY PROPERLY INSTALL SLICER IN ADEQUATE WORK AREA

- **ALWAYS** Install Equipment In Work Area With Adequate Light And Space.
- **ONLY** Operate On A Solid, Level, Non-Skid Surface.
- **NEVER** Bypass, Alter, Or Modify This Equipment In Any Way From Its Original Condition. Doing So Will Void Warranty.
- **NEVER** Operate Slicer Without All Knife Guards & Covers Securely Installed.
- **NEVER** Operate Without All Warnings Attached And Globe Warning Card And Wall Chart Posted.

INSTALLATION:

1. Read this Manual thoroughly before installation and operation. **DO NOT** proceed with installation and operation if you have any questions or do not understand anything in the Manual. Contact your local representative or Globe **first**.
2. Remove the corrugated box from the skid by extracting fastener nails at the bottom of the box.
3. Carefully unbolt Slicer from bottom of skid using a 3/4" socket wrench.
4. Attach rubber feet to legs (Model 4500), then connect legs to Slicer base, making sure that they are firmly tightened. On Automatics install rubber feet.



NEVER USE SLICER WITHOUT RUBBER FEET INSTALLED.

INSTALLATION

5. Select location for Slicer that has a level, solid, non-skid surface and a well-lighted work area away from children and visitors.



USE AT LEAST TWO PEOPLE TO LIFT SLICER UP TO OPERATING LOCATION. NEVER ATTEMPT TO LIFT SLICER ALONE.



6. **THIS MACHINE IS PROVIDED WITH A THREE-PRONG GROUNDING PLUG. THE OUTLET TO WHICH THIS PLUG IS CONNECTED MUST BE PROPERLY GROUNDED. IF THE RECEPTACLE IS NOT THE PROPER GROUNDING TYPE, CONTACT AN ELECTRICIAN. DO NOT UNDER ANY CIRCUMSTANCES CUT OR REMOVE THE THIRD (GROUND PRONG) FROM THE POWER CORD OR USE ANY ADAPTER PLUG. (See Fig. 8-1, 8-2)**
7. Post Globe Safety Tips and Wall Chart close by in a location within easy view of operator.
8. Inspect Slicer to ensure all parts have been provided.
9. Make sure knife cover, knife ring guard, sharpener, switch guard and chain guard cover are in place.
10. Make sure warning labels are properly positioned and legible and Owner's Manual is available near Slicer. Place the Spanish labels on the Slicer if your work force requires them.
11. Complete Warranty Card and mail to Globe factory.
12. Clean the Slicer using the procedures outlined in the Cleaning Section (pages 13 through 17) prior to using the Slicer.
13. Contact your local representative or Globe directly if you have any questions or problems with the installation or operation of this Slicer.

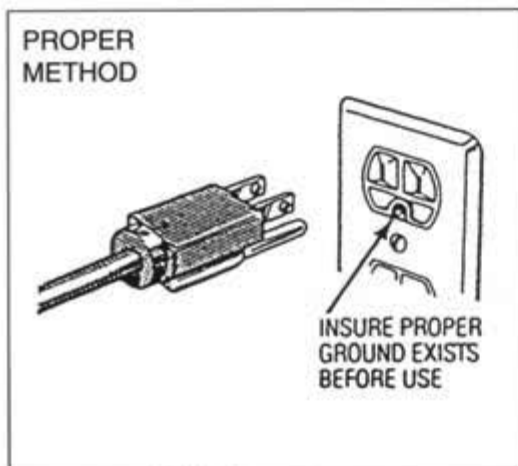

Fig. 8-1 RIGHT

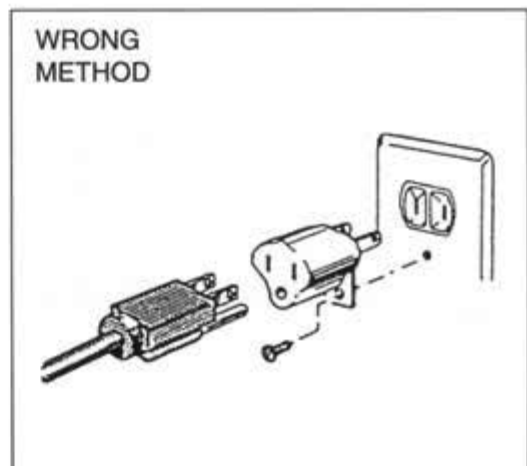

Fig. 8-2 WRONG

OPERATING INSTRUCTIONS



SHARP KNIFE TO AVOID SERIOUS PERSONAL INJURY

- **NEVER** Touch This Slicer Without Training And Authorization From Your Supervisor Or If You Are Under 18 Years Old. Read Owner's And Operator's Manual First.
- **ALWAYS** Keep Hands And Arms Away From Knife And All Moving Parts.
- **NEVER** Use Slicer Without All Guards And Parts In Place.
- **ALWAYS** Use End Weight, Not Your Hand, To Hold Food Products When Slicing.
- **ONLY USE** Food Chute Handle To Push Food Chute During Manual Slicing.
- **ALWAYS** Turn Off And Turn Slice Thickness Dial Completely Clockwise After Each Use.
- **ALWAYS** Turn Slicer Off, Turn Thickness Dial Completely Clockwise, Remove Chute, Push in Main Power Button, then Unplug Slicer Before Cleaning, Dismantling, Or Servicing.
- **BE ALERT** That Food Chute Moves Back And Forth During Automatic Operation And Returns All The Way Forward After Turning Off Slicer.

MANUAL SLICER OPERATION:

1. With slicer off, pull the food chute completely toward you and place the food product on the food chute. Slice only boneless, unfrozen product with the slicer. Use the end weight to hold the food product in place. If the end weight is not needed, it may be stored out of the way by swinging it back behind the food chute and locking it on the retaining pin.
2. Make sure all knobs are tightened prior to using the slicer.
3. Rotate the slice thickness dial counterclockwise to desired slice thickness. After slicing is complete, always turn slice thickness dial completely clockwise to close slicer table. Make sure Main Power Button (red knob) is pulled out and power indicator light is illuminated.

OPERATING INSTRUCTIONS

4. Turn slicer on. (The Slicer will not start unless the food chute is pulled all the way toward the operator.)

⚠ DO NOT Hold The Food Product With Your Hand. Never Put Your Hand On Or Around Food Chute When Slicer Is On. The Food Chute Handle Is The Only Part Of The Slicer You Should Touch While Slicing.

5. Use the food chute handle to manually push the food chute back and forth. The food chute handle is the only part of the slicer you should touch while slicing. Do not catch slices with your hand. Let slices drop on paper covered receiving area.

⚠ If A Product Needs To Be Adjusted During Slicing, ALWAYS Pull Food Chute All The Way Towards You. Turn Off Slicer, And Close Slicer Table Prior To Adjusting The Product And The End Weight.

6. After the last slice stroke, pull food chute all the way toward you and turn off slicer after each use. Always turn slice thickness dial completely clockwise to close the slicer table.

7. Now you can remove the product from the food chute.

📝 NOTE: The Slicer is equipped with an auto off timer. After 10 seconds of no chute movement the Slicer will shut off. Also the Slicer will not start unless the food chute is pulled all the way toward the operator.

MANUAL USE OF AUTOMATIC SLICER

⚠ ALWAYS Make Sure The Switch Controlling Food Chute Motor Is in OFF Position And Automatic Release Handle Is In LOWERED, UNLOCKED Position When Manually Operating Automatic Slicers.

Automatic slicers can be used manually when desired. When manually operating an automatic slicer, turn on only the knife motor. The other switch controls the food chute motor and should not be turned on. The automatic release handle must be in the lower position to manually move the food chute. (See Fig. 10-1.)

The chute must be pulled all the way toward operator to start Slicer.

The Slicer is equipped with an auto off timer. After 10 seconds of no chute movement, the Slicer will shut off.

The knife motor is controlled by the knife motor push button. (See Fig. 10-2.)



Figure 10-1



Figure 10-2

AUTOMATIC SLICER OPERATION



AUTOMATIC SLICER OPERATION:

 **DO NOT Operate Slicer Without Chain Guard Cover In Place. KEEP HANDS AWAY From Chain And Sprockets At All Times.**

 **DO NOT Operate Slicer With Lift Lever Engaged.**

1. Make sure all switches and push buttons are in the OFF position. The release handle should be in the lower position and the food chute should move freely.
2. Pull the food chute completely toward you and load the food product. Swing end weight into position to secure food product.
3. Place the chute motor speed knob in the following positions:
 - a. Model 4750 Speed Knob should be in the low speed position. (Fig. 11-1)
 - b. Models 4875V, 4850V Speed Knob should be turned completely counterclockwise to zero (0). (Fig. 11-2)
4. If food product is too long, place end weight on top of the food product and use the end weight prongs to hold the food product in place.
5. Engage slicer into automatic mode by lifting automatic release handle upward into locking position. (Fig. 11-3) Locking into position may require a slight force or tapping with your palm to secure.

 **NOTE:** Slicer will not start unless food chute is positioned closest to the operator. Also make sure that Main Power Button (red knob) is pulled out and power indicator light is illuminated.



Figure 11-1



Figure 11-2



Figure 11-3

6. Press knife motor start button.

AUTOMATIC SLICER OPERATION

⚠ BE ALERT. The Next Steps Will Cause The Food Chute To Move Automatically.

7. To activate automatic food chute, lift up on the chute motor start switch. Select proper slicing speed at this time.

✎ NOTE: Slow speeds should be used when slicing soft or delicate food products. Processed or firm food products can be sliced at higher speeds.

⚠ Never Attempt To Load Or Unload Food Chute When Slicer Is On Or When Set For Automatic Operation.

8. After slicing the desired amount of food product, first turn off the food chute motor switch. The Slicer will automatically stop with the chute in the position closest to the operator. Press the knife motor stop button.
9. Turn the slice thickness dial all the way clockwise to close the slicer table. Now you can load or unload the food product.

✎ NOTE: The food chute must be in a forward position closest to the operator for the Slicer to be turned on. Also the chain guard cover, food chute and knife cover must be on for the Slicer to operate. If the chute has not moved for 10 seconds the Slicer will automatically shut off and need to be restarted.



Figure 12-1

⚠ BE ALERT. If automatic release handle remains in up position, the food chute will be engaged and automatically move when the food chute motor is turned on. (See Figure 12-1.)

AUTOMATIC SPEED SETTINGS

<u>MODEL #</u>	<u>STROKES PER MINUTE</u>	<u>TWO SPEED/VARIABLE</u>
4750	40/60	TWO SPEED
4875V	1-60	VARIABLE
4850V	1-60	VARIABLE



SHARP KNIFE TO AVOID SERIOUS PERSONAL INJURY

- **ALWAYS** Turn Off All Switches, Close Table, Remove Food Chute And Unplug Slicer Before Cleaning Or Servicing. Make sure Main Power Button (red knob) is pushed in.
- **NEVER** Attempt To Clean Slicer With The Knife Running.
- **ALWAYS** Turn Slice Thickness Dial Completely Clockwise To Close The Slicer Table And Cover Knife Edge.
- **ONLY USE** Recommended Cleaning Equipment And Materials.
- **NEVER** Clean Automatic Slicer With The Lift Lever Engaged.

Your slicer should be cleaned and sanitized as often as necessary or at least once per day. Slicer components are easily disassembled without the use of special tools.

 **NOTE:** It may be desirable to wear cut resistant gloves during the cleaning operation.

DISASSEMBLY & CLEANING:

1. Turn Slicer Off.
2. Close Thickness Dial.

CLEANING

3. **FOOD CHUTE:** Remove the food chute by loosening the food chute release knob that fastens the food chute to the chute arm. Lift the food chute off the chute arm. The chute can not be removed without first closing the slice thickness dial.

4. Push in Main Power Button (red knob).
5. Unplug Slicer.

#1

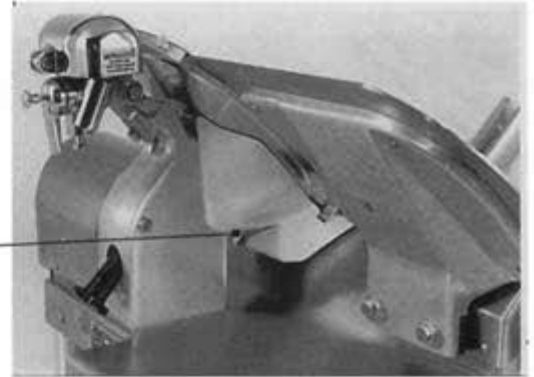

Figure 14-1

6. **SLICE DEFLECTOR:** The slice deflector (#1) is mounted on a retaining guide pin. To remove the slice deflector, pull completely forward and remove deflector (Fig. 14-1)



BE ALERT. The Next Steps Will Expose The Knife.

4. **KNIFE COVER:** The knife cover is removed by completely loosening the knife cover release knob. (Fig. 14-2) While holding the knobs on the knife cover, lift upward to remove. (Fig. 14-3) Slicer will not start with knife cover removed.

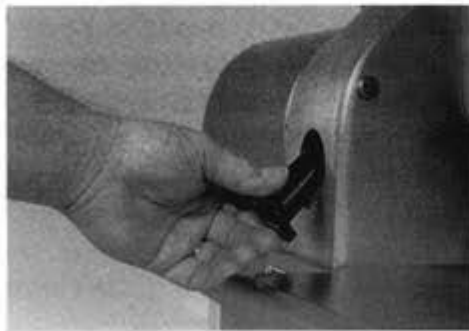

Figure 14-2



Figure 14-3



NEVER Attempt To Remove Or Dismantle The Knife Ring Guard.



NEVER Try To Remove The Knife From The Slicer. It Must Remain On The Slicer For Proper Operation, Sharpening, and Cleaning.

CLEANING

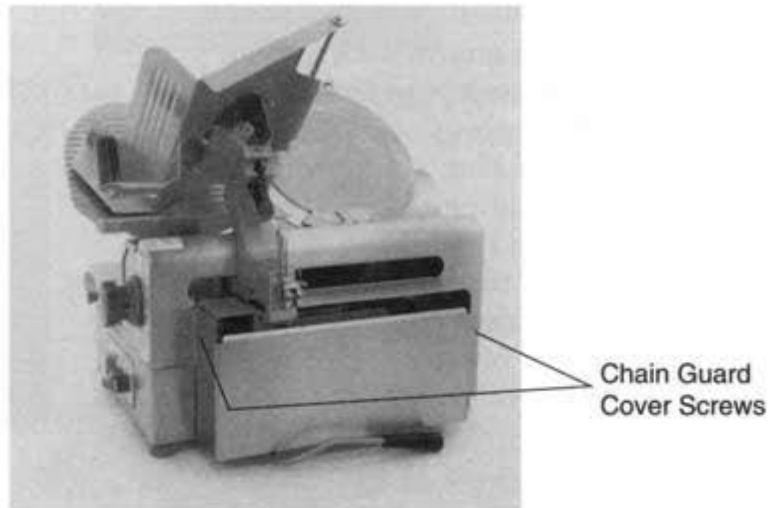

Figure 15-1

5. **CHAIN GUARD COVER** (Automatic Models Only): Remove the chain guard cover by loosening the chain guard cover screws. (Fig. 15-1) Push in on the sides of the chain guard cover to clear the chain guard cover screws. Slicer will not start with chain guard cover removed.



Do not operate slicer without chain guard cover in place. Keep hands away from chain and sprockets at all times.

CAUTION

- **DO NOT Put Components In Dishwasher.**
- **Dilute Detergent Per Supplier's Instruction.**
- **DO NOT Hose Down Or Pressure Wash Any Part Of The Slicer.**
- **NEVER Use Scrubber Pad, Steel Wool, Or Abrasive Material To Clean The Slicer.**
- **NEVER Remove Sharpener From Slicer Or Immerse In Water.**
- **Clean The Disassembled Components With A Mild Detergent And Warm Water Solution. Allow Parts To Air Dry.**

CLEANING

- The knife ring guard must now be cleaned. To clean the knife ring guard, soak a clean cloth in the mild detergent and warm water solution. **Carefully** insert the cloth between the knife and the knife ring guard as indicated by Figure 16-1. While holding the cloth between the knife and the knife ring guard, work it along the entire back side of the knife, between the knife and knife ring guard. Repeat this procedure as necessary. A nylon brush could also be used if preferred.



Figure 16-1

- The knife also must be cleaned. **Carefully** wash and rinse the top and bottom of the knife by wiping from the **center of the knife outward** as indicated by Figure 16-2.

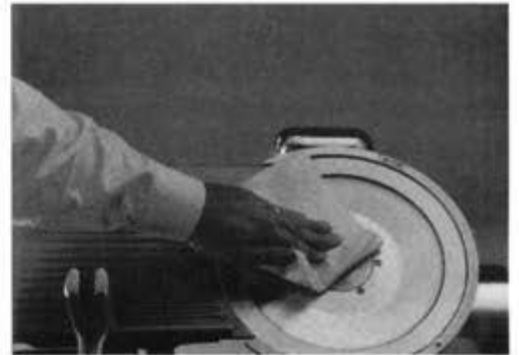

Figure 16-2



DO NOT Allow Moisture To Get Into Knife Hub.

- Now replace the knife cover on top of the knife. Hold the knife cover with one hand while securely tightening the knife cover release knob with the other hand. Be sure the knife cover is rotated completely counter-clockwise.
- With the slicer table completely closed, wipe the slicer table off by starting at the knife and pulling toward you. **Never wipe the slicer table toward the knife.**
- Clean and wipe down the entire slicer. Use a mild sanitizer if required.

CLEANING



**DO NOT Use Caustic Or Strong Detergents
On The Slicer Base or Components.**



Figure 17-1

REASSEMBLY:

1. Replace the slice deflector (#1) by sliding it over the retaining guide pin and pushing toward the rear of the slicer. (Fig. 17-1)
2. Install food chute (#2) to the original position on the chute arm. Tighten food chute release knob securely to prevent any “play” between the food chute and chute arm.
3. Replace chain guard cover to original position (automatic units only). Align front and back slots of chain guard cover with screws. Tighten front and back screws.



**DO NOT Operate Slicer Without Chain Guard Cover In Place.
KEEP HANDS AWAY From Chain And Sprockets At All Times.**



NOTE: The slicer will not operate unless the knife cover and chain guard cover are in place and tightened down.

Automatic slicers have a lift lever which raises the slicer to allow cleaning underneath.

4. To clean under a slicer equipped with a lift lever:
 - (a) With the automatic release handle disengaged, push the food chute to the back of the slicer.
 - (b) Pull the lift lever knob toward operator with your right hand, while gently lifting up on the slice thickness dial with the other.
 - (c) Pull the lift lever all the way forward toward operator until it stops.



**NEVER Try To Clean, Sharpen, Or Operate Slicer With The Lift
Lever In The Raised Position.**



SHARP KNIFE TO AVOID SERIOUS PERSONAL INJURY

- **NEVER** Touch Rotating Knife.
- **ALWAYS** Keep Hands Clear Of All Moving Parts.
- **ALWAYS** Turn Off Slicer, Turn Slice Thickness Dial Completely Clockwise, And Remove Food Chute Before Sharpening.
- **NEVER** Sharpen Slicer Unless All Guards Are Installed.
- **ALWAYS** Make Sure Food Chute Is Removed And Chute Motor Is Off When Sharpening Automatic Slicers.

GENERAL:

1. Symptoms of a dull knife are excess waste/or a “tail” on the unsliced portion remaining in the food chute.
2. The knife needs to be sharpened periodically to provide consistent slices and maximum food product yield. Sharpening the knife lightly every few days is more efficient than heavy sharpening at less frequent intervals.

KNIFE SHARPENING

PREPARING TO SHARPEN:



Turn all motor switches OFF.

1. Turn slice thickness dial completely clockwise so that slicer table covers knife edge.
2. Remove food chute from Slicer. Push in Main Power Button (red knob).
3. Clean and dry both sides of the knife before sharpening, following instructions for knife cleaning on pages 13 thru 17.
4. Expose sharpener stones by lifting the knife sharpener cover (Fig. 19-1). Stones should be clean, dry and free of grease.

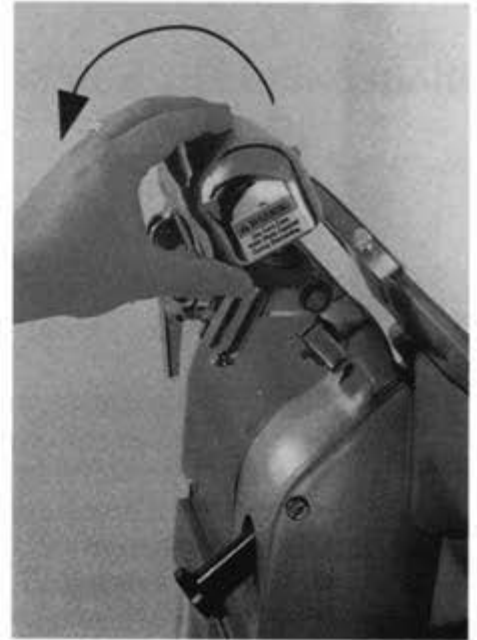

Figure 19-1



BE ALERT. The Next Steps Will Expose The Knife.

5. To expose the knife edge for sharpening, loosen the knife cover release knob (Figure 19-2, #1) and rotate the knife cover (#2) clockwise until it comes to rest on stop pin. Re-tighten the knife cover release knob. Using the knob located on the knife ring guard (#3), carefully lift the hinged portion of the knife ring guard away from the knife.

#1 Knife Cover Release Knob

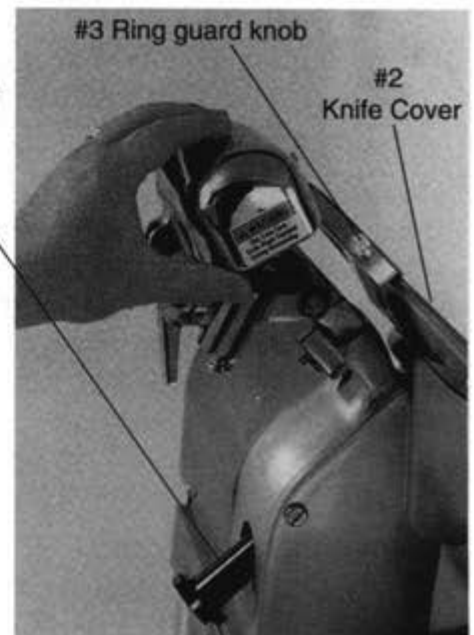



Figure 19-2



ALWAYS Keep Hands And Arms Away From Exposed Knife. MAKE SURE Slicers Have The Food Chute Removed.

SHARPENING THE KNIFE:

1. Pull out Knob #1 (Fig. 20-1) and swing sharpener into position for use.
2. Pull out Main Power Button (red knob).
3. Turn knife motor on.
4. Turn the handle counterclockwise (Fig. 20-2, #1) to bring stones into contact with the knife. Maintain pressure on the handle for 10 seconds. Be sure both stones are in contact with knife. Repeat operation until knife is sharp. Slicer must be restarted every 10 seconds.

 **NOTE: If knife becomes very dull,** activate only the bottom stone by pushing in Knob #2. (Fig. 20-2)

When sharpening with the bottom stone is completed, pull out Knob #2. This allows simultaneous sharpening with both stones. Always finish sharpening using both stones.



Figure 20-1



Figure 20-2



TURN OFF Slicer Before Inspecting.

KNIFE SHARPENING

FINISH SHARPENING:

When sharpening is finished, follow these procedures:

1. **Turn the motor switch OFF. Push in Main Power Button (red knob). Unplug the power cord.**
2. Return the sharpener to its original position by pulling out knob (#1) and swinging back. (Figure 21-1)
3. **Carefully** close the hinged area of the knife ring guard using the knob located at its top. (Fig. 21-2, #2)
4. Loosen knife cover release knob and rotate knife cover counterclockwise to its original position. Tighten knife cover release knob.
5. Wipe sharpening stones clean.
6. Close sharpener cover. (Fig. 21-3)
7. Clean slicer as necessary using cleaning procedures listed on pages 13 thru 17.
8. Plug in Slicer. Pull out Main Power Button (red knob).
7. Re-install food chute on Slicer.



Figure 21-1



Figure 21-2



Figure 21-3



**SHARP KNIFE
TO AVOID SERIOUS PERSONAL INJURY**

- **ALWAYS** Turn Off, Remove Food Chute And Unplug Slicer Before Servicing.
- **NEVER** Touch This Machine Without Proper Training And Authorization By Your Supervisor.
- **ALWAYS** Keep Hands Clear Of Rotating Knife And Moving Parts.
- **DO NOT** Tamper With, Bypass, Or Remove Any Safety Devices, Guards, Or Switches.
- **ALWAYS** Turn Off Slicer And Turn Slice Thickness Dial Completely Clockwise After Each Use.
- **USE ONLY** Globe Parts And Accessories Properly Installed.

LUBRICATION:

Various slicer parts need to be lubricated periodically using Globe Oil. Globe Oil is a light, tasteless, odorless mineral oil that will not contaminate or impart odors or taste to sliced food product.



**DO NOT USE VEGETABLE OIL TO LUBRICATE SLICER.
VEGETABLE OIL WILL DAMAGE THE SLICER.**

SIMPLE MAINTENANCE AND REPAIR

1. Chute Slide Rods

It is necessary to lubricate the food chute slide rods with Globe Oil weekly or when excessive drag is felt.

- a. Close Slicer table.
- b. Pull food chute handle completely forward (toward operator). (Fig. 23-1) Remove the food chute to improve the access to the oil hole.

 **Note:** It is important that food chute arm is as close as possible toward operator for oil reservoir to be located under oil hole.

- b. Remove cap from oil container. Add several drops of Globe Oil into the oil hole.
- c. Wipe off excess oil.



Figure 23-1

2. End Weight Slide Rod

- a. The end weight slide rod (#1) (Fig. 23-2) should be lubricated as needed with a few drops of Globe oil. The Globe Oil is intended for this use.



Figure 23-2

3. Automatic Slicer Chains

The chains on automatic slicer models should be lubricated monthly with Globe Oil.



Turn The Motor Switch(es) OFF, Close Table, Remove Food Chute And UNPLUG The Power Cord.

1. Remove the chain guard cover as explained on page 15.
2. Pull off cap to open Globe Oil container. Apply oil to each chain link. Wipe off excess oil. (Fig. 23-3)
3. Reassemble chain guard cover immediately as explained on page 17. Keep hands away from sprockets at all times. Slicer will not start unless chain guard cover is in place.



Figure 23-3

SIMPLE MAINTENANCE AND REPAIR



Slicer will not operate without chain guard cover in place. KEEP HANDS AWAY from sprockets at all times.

4. Sharpener



Turn The Motor Switch(es) Or Push Button OFF. Close Table And Remove Food Chute. UNPLUG The Power Cord.

1. The sharpener shafts should be lubricated once per month with a few drops of Globe oil.
2. Add Globe oil to each of the sharpener shaft holes where the shaft enters the sharpener housing. Lift stone completely upward to expose hole.

5. Other Lubrication

It is recommended that all threaded screws be lubricated after each cleaning to maximize the life of your slicer.



**SHARP KNIFE
TO AVOID SERIOUS PERSONAL INJURY**

- **ALWAYS** Turn Motor Switches Or Push Button Off And Close Table. Unplug Power Cord Before Installing Accessories.
- **ALWAYS** Keep Hands And Arms Away From Knife And All Moving Parts.
- **NEVER** Use Slicer Without All Guards And Parts In Place.
- **ONLY** Use Food Chute Handle To Push Food Chute During Manual Slicing.
- **NEVER** Put Hands On Or Inside Food Chute During Slicer Operation.
- **ALWAYS** Turn Off Slicer And Turn Slice Thickness Dial Completely Clockwise After Each Use.
- **ALWAYS** Turn Off, Close Table, Remove Food Chute And Unplug Slicer Before Cleaning, Dismantling, Or Servicing.
- **BE ALERT** That Food Chute Moves Back And Forth During Automatic Operation.

TUBULAR CHUTE

The tubular chute (Fig. 25-1) temporarily converts your slicer into an efficient, heavy-duty meat, fruit, and vegetable slicer. To use the tubular chute, follow the outlined procedures.



Figure 25-1



DO NOT PUT HANDS INSIDE TUBULAR CHUTE DURING SLICER OPERATION.

1. Turn Slicer Off.
2. Close Table.
3. Remove the food chute by loosening food chute release knob that fastens food chute to chute arm. Slide the food chute off the chute receiver arm.
4. Remove round end weight from tubular chute. Place the tubular chute in position on the chute arm. Tighten tubular chute knob securely to prevent any “play” between the tubular chute and chute arm.
5. Fill the tubular chute with desired product. Place round end weight in tubular chute.
6. Select desired setting with slice thickness dial.
7. Turn slicer on. Begin manual or automatic slicing. Follow operating instructions on page 9.
8. Clean the tubular chute and end weight with a mild detergent and a warm water solution.

SLICER FENCES

Slicer fences (Fig. 26-1) provide extra support to some types of food products during slicing. Two types are available: a low fence for slicing rectangular meats and cheeses, and a high fence for slicing large round objects. To use the slicer fences, follow the outlined procedures:

1. Be sure food chute end weight is in stored position behind food chute.
2. Place fence in desired position on the food chute.
3. Tighten fence thumb screw to secure fence to food chute.
4. Two or more fences may be used for quantity slicing.
5. Load food product.
6. Select desired setting with slice thickness dial.
7. Turn slicer on. Begin manual or automatic slicing. Follow operating instructions located on page 9.
8. Clean the slicer fences with a mild detergent and warm water solution.

Figure 26-1

OPTIONAL ACCESSORIES

FRONT MOUNTED END WEIGHT AND CHUTE

(Fig. 27-1)

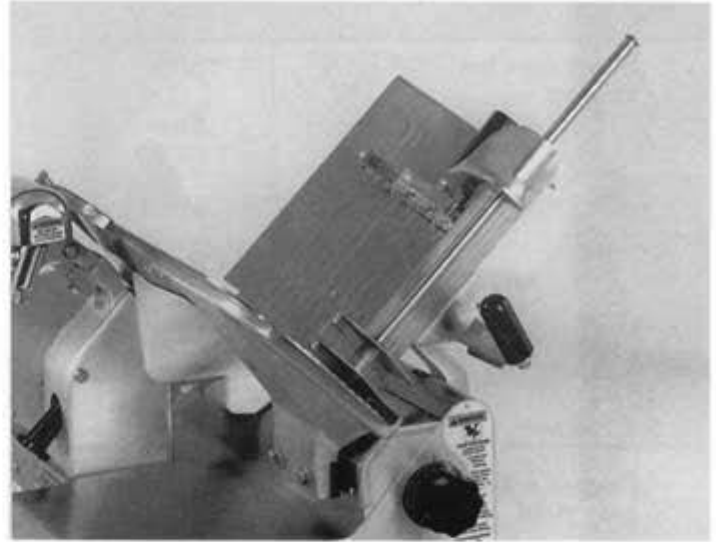

Figure 27-1

FOR OPTIMAL SLICING

TO OBTAIN THE MAXIMUM PERFORMANCE AND YIELD FROM YOUR GLOBE SLICER:

1. Read this entire Manual before touching slicer and strictly follow all instructions and precautions. **THERE IS NO SUBSTITUTE FOR SAFETY!**
2. Lubricate the slicer per the instructions on page 22.
3. Maintain a sharp knife and replace as necessary. Never attempt to replace the knife yourself.
3. Keep sharpening stones dry, clean and free of grease.
4. Clean knife prior to sharpening slicer.
5. As the knife is sharpened and the diameter is reduced:
 - (a.) it will be necessary to have the table adjusted inward toward the knife in order to maintain a consistent 1/32" clearance between the table and knife.
 - (b.) to have the sharpener assembly adjusted lower to maintain proper alignment with the knife.

**We recommend an authorized Globe service company
to perform all adjustments and preventive maintenance.**

**By adequately maintaining your slicer, it will provide years of
dependable service. The only way to damage a Globe slicer is by neglect.**

TROUBLESHOOTING GUIDE

<u>SYMPTOM</u>	<u>POSSIBLE CAUSE</u>	<u>POSSIBLE SOLUTION</u>
Slicer does not turn on	<p>Slicer not plugged in</p> <p>Fuse blown, breaker tripped</p> <p>Main Power Button pushed in</p> <p>Switch off</p> <p>Knife cover off</p> <p>Chain guard cover off</p> <p>Food chute not in start position</p>	<p>Plug in slicer</p> <p>Replace 10 amp fuse</p> <p>Re-set breaker at power box</p> <p>Pull out Main Power Button</p> <p>Turn switch on</p> <p>Install knife cover</p> <p>Install chain cover</p> <p>Pull food chute all the way toward the operator.</p>
Ragged cuts-poor yield	<p>Dull knife</p> <p>Chipped knife</p> <p>Knife-Slicer table gap too wide</p> <p>Knife too small, 11" or less</p>	<p>Sharpen knife</p> <p>Sharpen or have new knife installed</p> <p>Call for service to adjust slicer table</p> <p>Have new knife installed</p>
Metal rubbing knife	<p>Knife cover</p> <p>Food Chute</p> <p>End Weight</p> <p>Slicer table</p>	<p>Tighten knife cover release knob</p> <p>Tighten or adjust food chute</p> <p>Have defective end weight replaced</p> <p>Call for service to adjust slicer table</p>
<p>Automatic food chute doesn't travel</p> <p>NOTE: Knife motor must be ON in order for chute motor to start.</p>	<p>Switch off</p> <p>Automatic Release handle in down position</p>	<p>Turn food chute switch on</p> <p>Place automatic release handle in up position</p>
Hard to push food chute	No lubrication	Lubricate slide rods thoroughly with Globe Oil.
Hard to sharpen	<p>Stones dirty, wet or clogged with grease</p> <p>Knife dirty</p> <p>Worn stones</p> <p>Stones not properly aligned</p>	<p>Clean stones with alcohol and brush</p> <p>Dry stones</p> <p>Clean top and bottom of knife</p> <p>Have stones replaced</p> <p>Have sharpener adjusted</p>
Slicer only runs for 10 seconds and turns off	No Problem	Standard Feature

LIMITED WARRANTY

Globe Food Equipment Company ("GFE") warrants to the original purchaser of new equipment that said equipment, installed in accordance with our instructions within United States and subjected to normal use, is free from defects in material or workmanship for a period of 2 years on parts (excludes wear/expendable parts). The labor warranty is one year from date of original installation, or 18 months from actual shipment date, whichever date occurs first.

THIS WARRANTY IS IN LIEU OF ALL OTHER WARRANTIES, WHETHER EXPRESS OR IMPLIED. GFE EXPRESSLY DISCLAIMS ANY IMPLIED WARRANTY OR MERCHANTABILITY OR EXPRESS OR IMPLIED WARRANTY OF FITNESS FOR A PARTICULAR PURPOSE.

GFE'S OBLIGATION AND LIABILITY UNDER THIS WARRANTY IS EXPRESSLY LIMITED TO REPAIRING AND REPLACING EQUIPMENT WHICH PROVES TO BE DEFECTIVE IN MATERIAL OR WORKMANSHIP WITHIN THE APPLICABLE WARRANTY PERIOD. All repairs pursuant to this Warranty will be performed by an Authorized Designated GFE Service Location during normal working hours. IN NO EVENT SHALL GFE BE LIABLE FOR INCIDENTAL OR CONSEQUENTIAL DAMAGES TO BUYER OR ANY THIRD PARTY, INCLUDING, WITHOUT LIMITATION, LOSS OF PROPERTY, PERSONAL INJURY, LOSS OF BUSINESS OR PROFITS OR OTHER ECONOMIC LOSSES, OR STATUTORY OR EXEMPLARY DAMAGES, WHETHER IN NEGLIGENCE, WARRANTY, STRICT LIABILITY, OR OTHERWISE.

This Warranty is given only to the first purchaser from a retail dealer. No warranty is given to subsequent transferees.

Periodic maintenance of equipment including but not limited to lubrication, replacement of worn blades or stones and other adjustments required due to installation set up or normal wear are not covered under this warranty.

This Warranty is not in force until such time as a properly completed and signed Installation/Warranty Registration has been received by GFE within 30 days from the date of installation.

THE FOREGOING WARRANTY PROVISIONS ARE A COMPLETE AND EXCLUSIVE STATEMENT BETWEEN THE BUYER AND SELLER. GFE NEITHER ASSUMES NOR AUTHORIZES ANY PERSONS TO ASSUME FOR IT ANY OTHER OBLIGATION OR LIABILITY IN CONNECTION WITH SAID EQUIPMENT.

NOTES

In order for Slicer to operate:

1. The Main Power Button (red knob) must be pulled out and power light illuminated.
2. The food chute must be pulled completely toward the operator.
3. The knife cover must be on and secured.

Also on Automatics:

1. The chain guard cover must be on and tightened down.
2. The food chute must be in place and secured.