



Instruction Manual

15" Deluxe Servalot and P-61 Nach-A-Lot Warmer

Model No. 2185ST, 2187ST, 2189



Model 2185ST



GOLD MEDAL[®] PRODUCTS CO.

10700 Medallion Drive, Cincinnati, Ohio 45241-4807 USA



Cabinet View

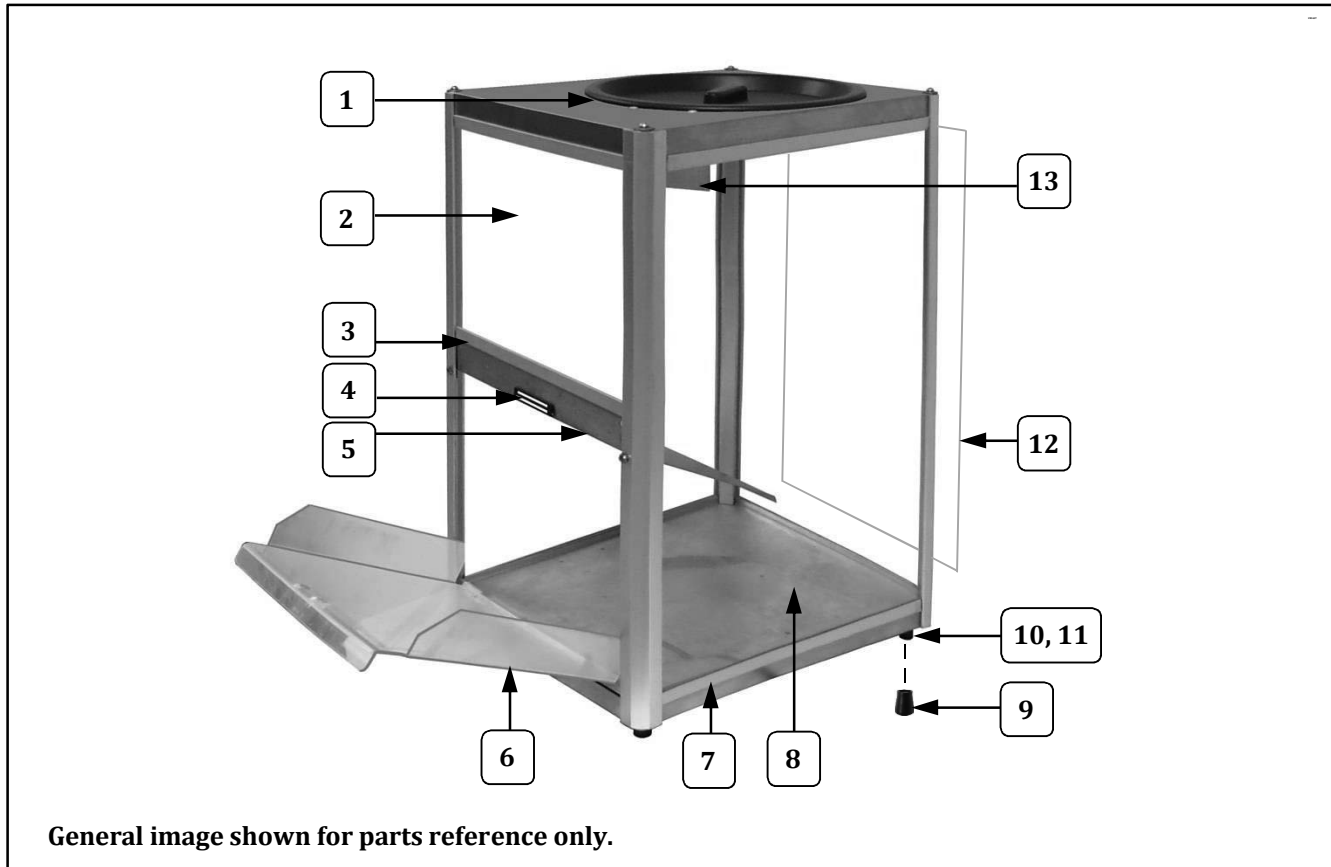

Item	Part Description	Part Number		
		2185ST	2187ST	2189
1	LID	100288	100288	100288
2	PLEXIGLASS PANEL (13 15/16 X 8 17/64)	40015	40015	
3	RETAINING EXTRUSION	40039	40039	49004
4	MAGNETIC CATCH	47561	47561	47561
5	BAFFLE	40009	40009	40065
6	DROP PANEL	40118	40118	40123
7	RETAINING EXTRUSION	40021	40021	40068
8	PLEXIGLAS PANEL	40014	40014	49019
9	CRUTCH TIP BLACK 70 DURO	49123	49123	49123
10	GLIDE	47328	47328	47328
11	SCREW, 10-24 X 3/4 HXHD	41314	41314	41314
12	PLEXIGLAS PANEL	40013	40013	49018
13	BULB PROTECTION L ANGLE	40050	40050	40050



Cabinet View

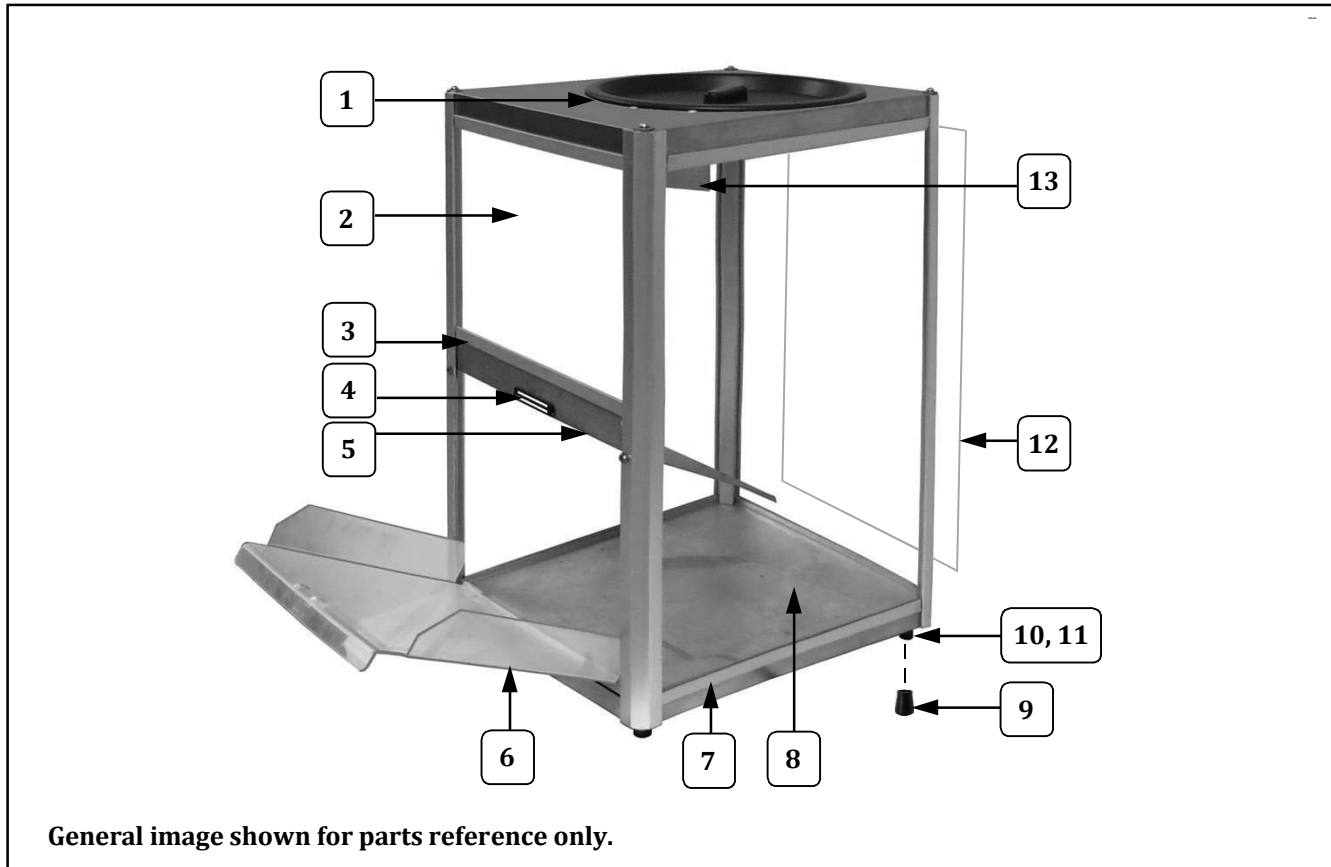

Item	Part Description	Part Number		
		2185ST	2187ST	2189
1	LID	100288	100288	100288
2	PLEXIGLASS PANEL (13 15/16 X 8 17/64)	40015	40015	
3	RETAINING EXTRUSION	40039	40039	49004
4	MAGNETIC CATCH	47561	47561	47561
5	BAFFLE	40009	40009	40065
6	DROP PANEL	40118	40118	40123
7	RETAINING EXTRUSION	40021	40021	40068
8	PLEXIGLAS PANEL	40014	40014	49019
9	CRUTCH TIP BLACK 70 DURO	49123	49123	49123
10	GLIDE	47328	47328	47328
11	SCREW, 10-24 X 3/4 HXHD	41314	41314	41314
12	PLEXIGLAS PANEL	40013	40013	49018
13	BULB PROTECTION L ANGLE	40050	40050	40050



Cabinet View

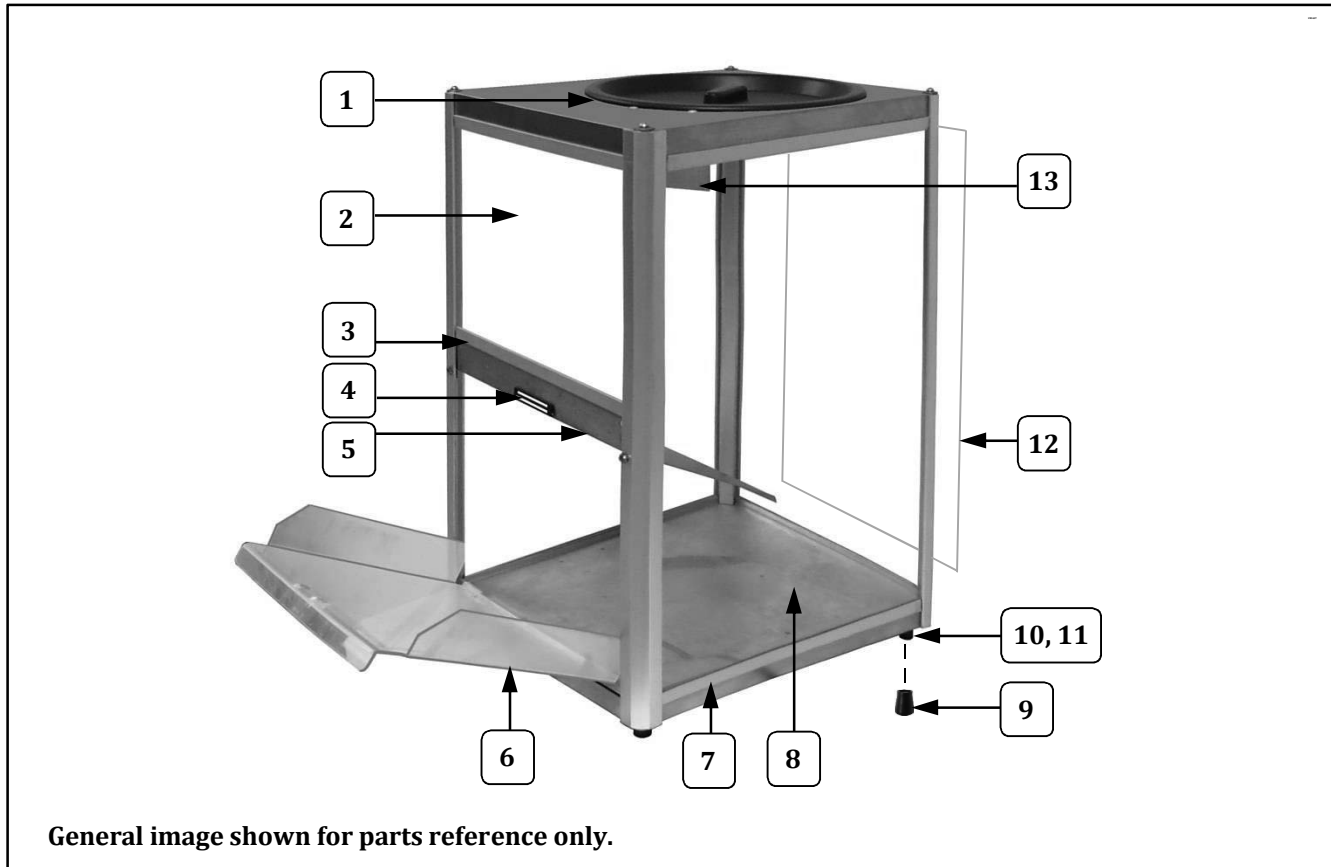

Item	Part Description	Part Number		
		2185ST	2187ST	2189
1	LID	100288	100288	100288
2	PLEXIGLASS PANEL (13 15/16 X 8 17/64)	40015	40015	
3	RETAINING EXTRUSION	40039	40039	49004
4	MAGNETIC CATCH	47561	47561	47561
5	BAFFLE	40009	40009	40065
6	DROP PANEL	40118	40118	40123
7	RETAINING EXTRUSION	40021	40021	40068
8	PLEXIGLAS PANEL	40014	40014	49019
9	CRUTCH TIP BLACK 70 DURO	49123	49123	49123
10	GLIDE	47328	47328	47328
11	SCREW, 10-24 X 3/4 HXHD	41314	41314	41314
12	PLEXIGLAS PANEL	40013	40013	49018
13	BULB PROTECTION L ANGLE	40050	40050	40050



Cabinet View

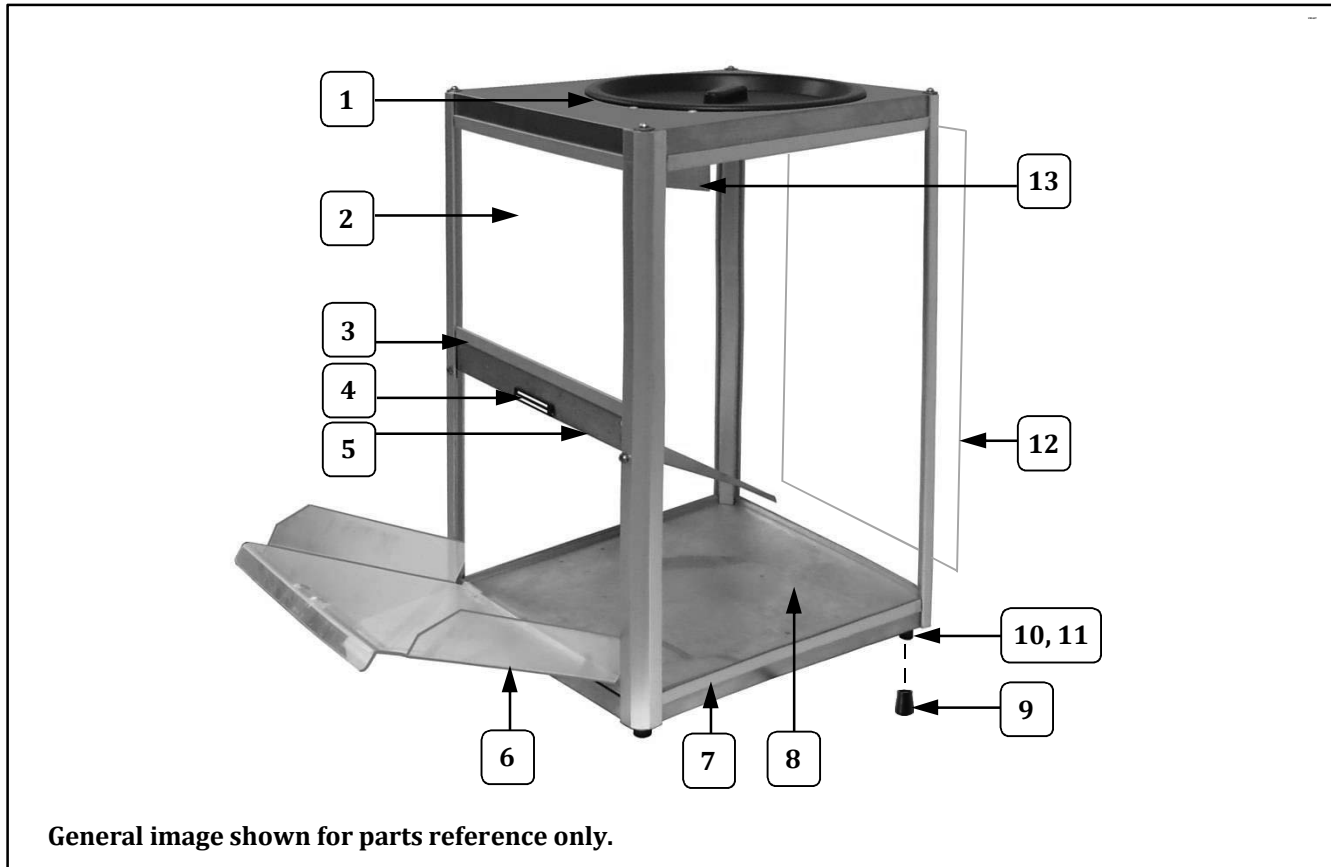

Item	Part Description	Part Number		
		2185ST	2187ST	2189
1	LID	100288	100288	100288
2	PLEXIGLASS PANEL (13 15/16 X 8 17/64)	40015	40015	
3	RETAINING EXTRUSION	40039	40039	49004
4	MAGNETIC CATCH	47561	47561	47561
5	BAFFLE	40009	40009	40065
6	DROP PANEL	40118	40118	40123
7	RETAINING EXTRUSION	40021	40021	40068
8	PLEXIGLAS PANEL	40014	40014	49019
9	CRUTCH TIP BLACK 70 DURO	49123	49123	49123
10	GLIDE	47328	47328	47328
11	SCREW, 10-24 X 3/4 HXHD	41314	41314	41314
12	PLEXIGLAS PANEL	40013	40013	49018
13	BULB PROTECTION L ANGLE	40050	40050	40050



Cabinet View

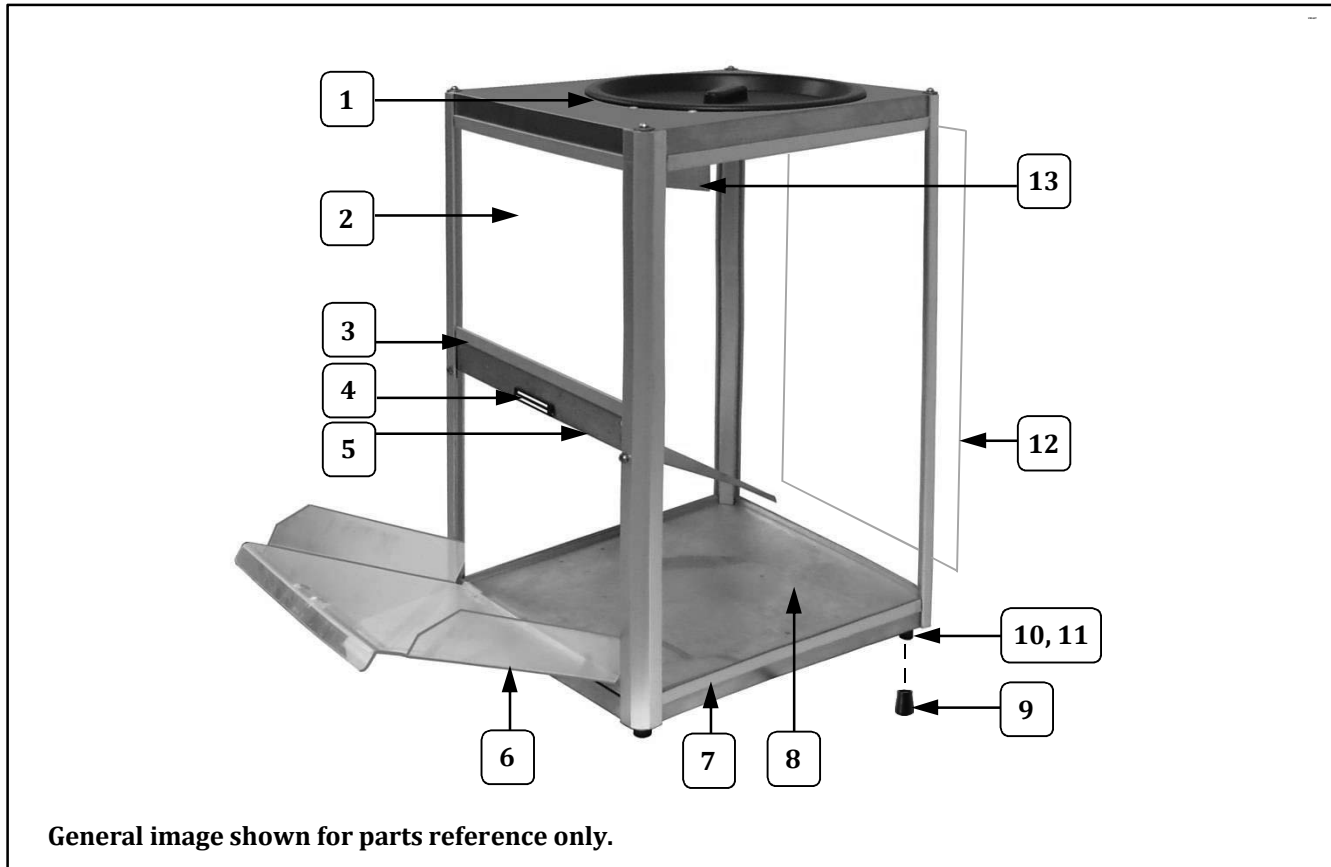

Item	Part Description	Part Number		
		2185ST	2187ST	2189
1	LID	100288	100288	100288
2	PLEXIGLASS PANEL (13 15/16 X 8 17/64)	40015	40015	
3	RETAINING EXTRUSION	40039	40039	49004
4	MAGNETIC CATCH	47561	47561	47561
5	BAFFLE	40009	40009	40065
6	DROP PANEL	40118	40118	40123
7	RETAINING EXTRUSION	40021	40021	40068
8	PLEXIGLAS PANEL	40014	40014	49019
9	CRUTCH TIP BLACK 70 DURO	49123	49123	49123
10	GLIDE	47328	47328	47328
11	SCREW, 10-24 X 3/4 HXHD	41314	41314	41314
12	PLEXIGLAS PANEL	40013	40013	49018
13	BULB PROTECTION L ANGLE	40050	40050	40050



Cabinet View

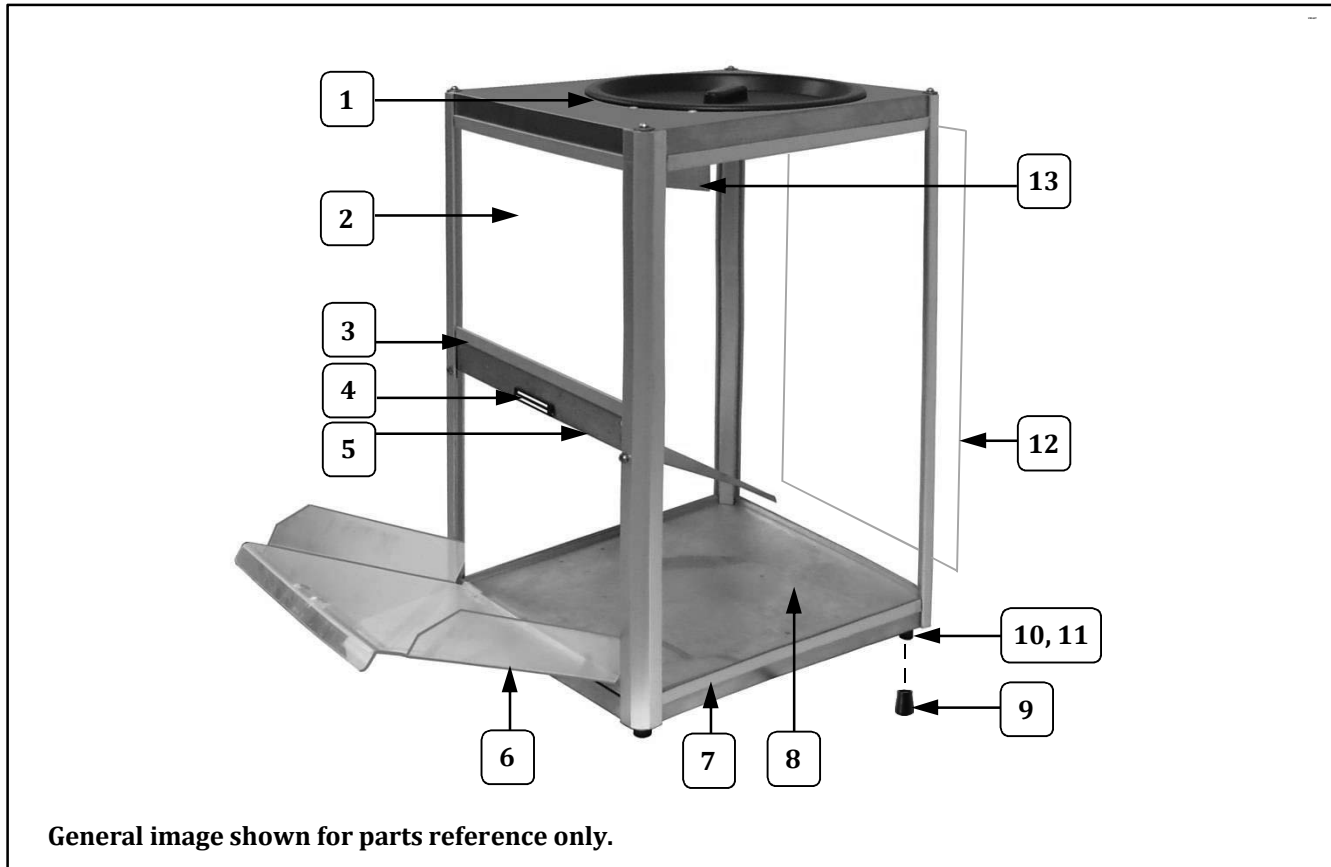

Item	Part Description	Part Number		
		2185ST	2187ST	2189
1	LID	100288	100288	100288
2	PLEXIGLASS PANEL (13 15/16 X 8 17/64)	40015	40015	
3	RETAINING EXTRUSION	40039	40039	49004
4	MAGNETIC CATCH	47561	47561	47561
5	BAFFLE	40009	40009	40065
6	DROP PANEL	40118	40118	40123
7	RETAINING EXTRUSION	40021	40021	40068
8	PLEXIGLAS PANEL	40014	40014	49019
9	CRUTCH TIP BLACK 70 DURO	49123	49123	49123
10	GLIDE	47328	47328	47328
11	SCREW, 10-24 X 3/4 HXHD	41314	41314	41314
12	PLEXIGLAS PANEL	40013	40013	49018
13	BULB PROTECTION L ANGLE	40050	40050	40050



Cabinet View

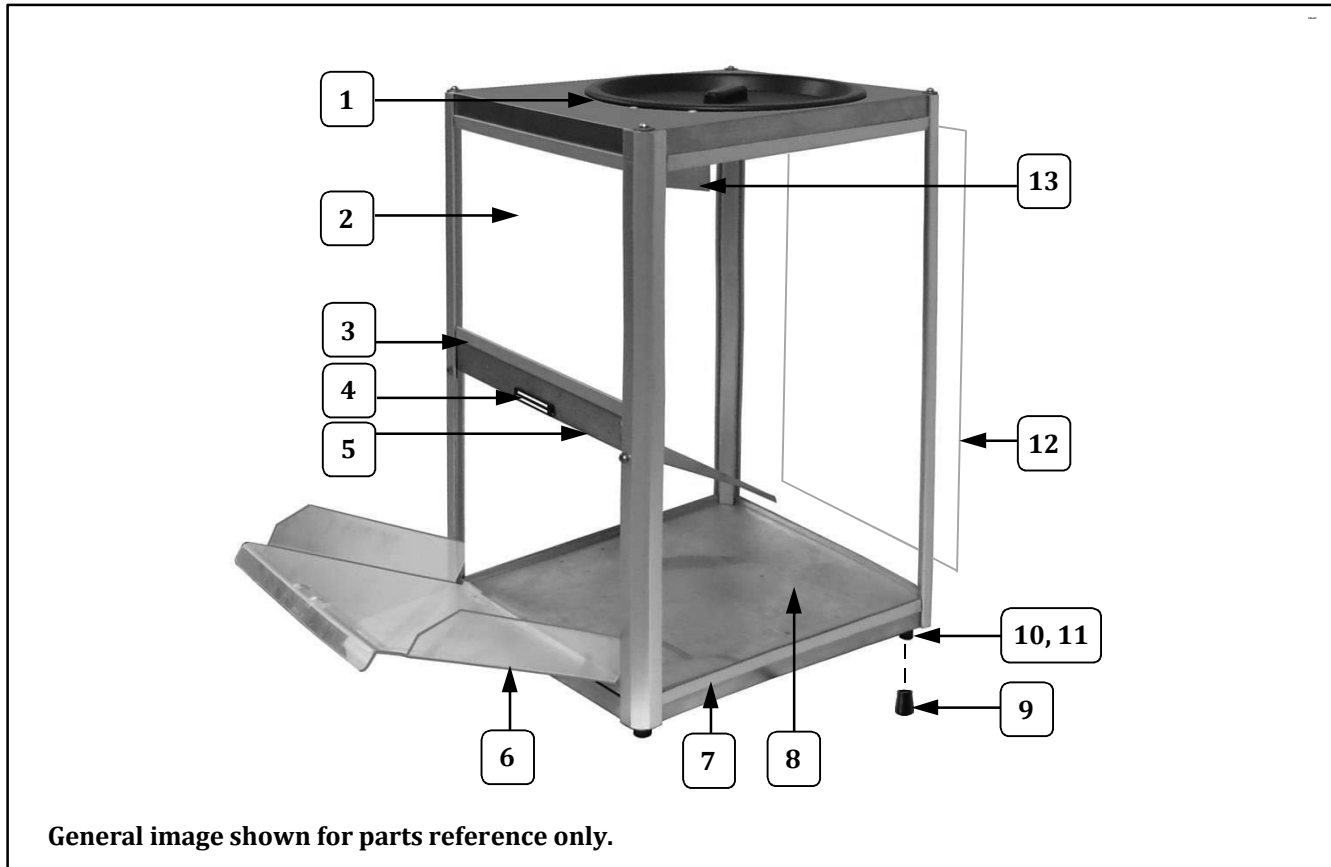

Item	Part Description	Part Number		
		2185ST	2187ST	2189
1	LID	100288	100288	100288
2	PLEXIGLASS PANEL (13 15/16 X 8 17/64)	40015	40015	
3	RETAINING EXTRUSION	40039	40039	49004
4	MAGNETIC CATCH	47561	47561	47561
5	BAFFLE	40009	40009	40065
6	DROP PANEL	40118	40118	40123
7	RETAINING EXTRUSION	40021	40021	40068
8	PLEXIGLAS PANEL	40014	40014	49019
9	CRUTCH TIP BLACK 70 DURO	49123	49123	49123
10	GLIDE	47328	47328	47328
11	SCREW, 10-24 X 3/4 HXHD	41314	41314	41314
12	PLEXIGLAS PANEL	40013	40013	49018
13	BULB PROTECTION L ANGLE	40050	40050	40050



Cabinet View

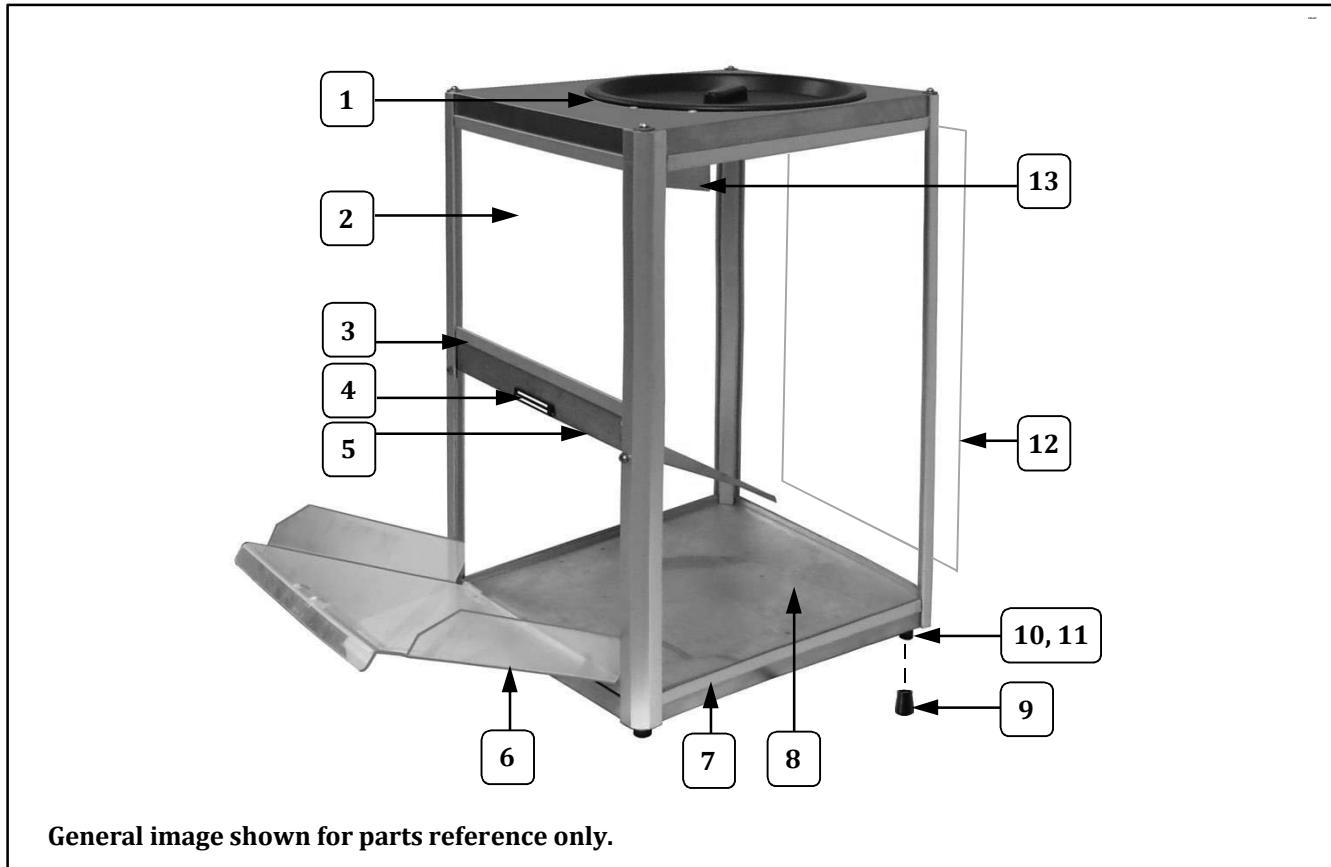

Item	Part Description	Part Number		
		2185ST	2187ST	2189
1	LID	100288	100288	100288
2	PLEXIGLASS PANEL (13 15/16 X 8 17/64)	40015	40015	
3	RETAINING EXTRUSION	40039	40039	49004
4	MAGNETIC CATCH	47561	47561	47561
5	BAFFLE	40009	40009	40065
6	DROP PANEL	40118	40118	40123
7	RETAINING EXTRUSION	40021	40021	40068
8	PLEXIGLAS PANEL	40014	40014	49019
9	CRUTCH TIP BLACK 70 DURO	49123	49123	49123
10	GLIDE	47328	47328	47328
11	SCREW, 10-24 X 3/4 HXHD	41314	41314	41314
12	PLEXIGLAS PANEL	40013	40013	49018
13	BULB PROTECTION L ANGLE	40050	40050	40050



Cabinet View

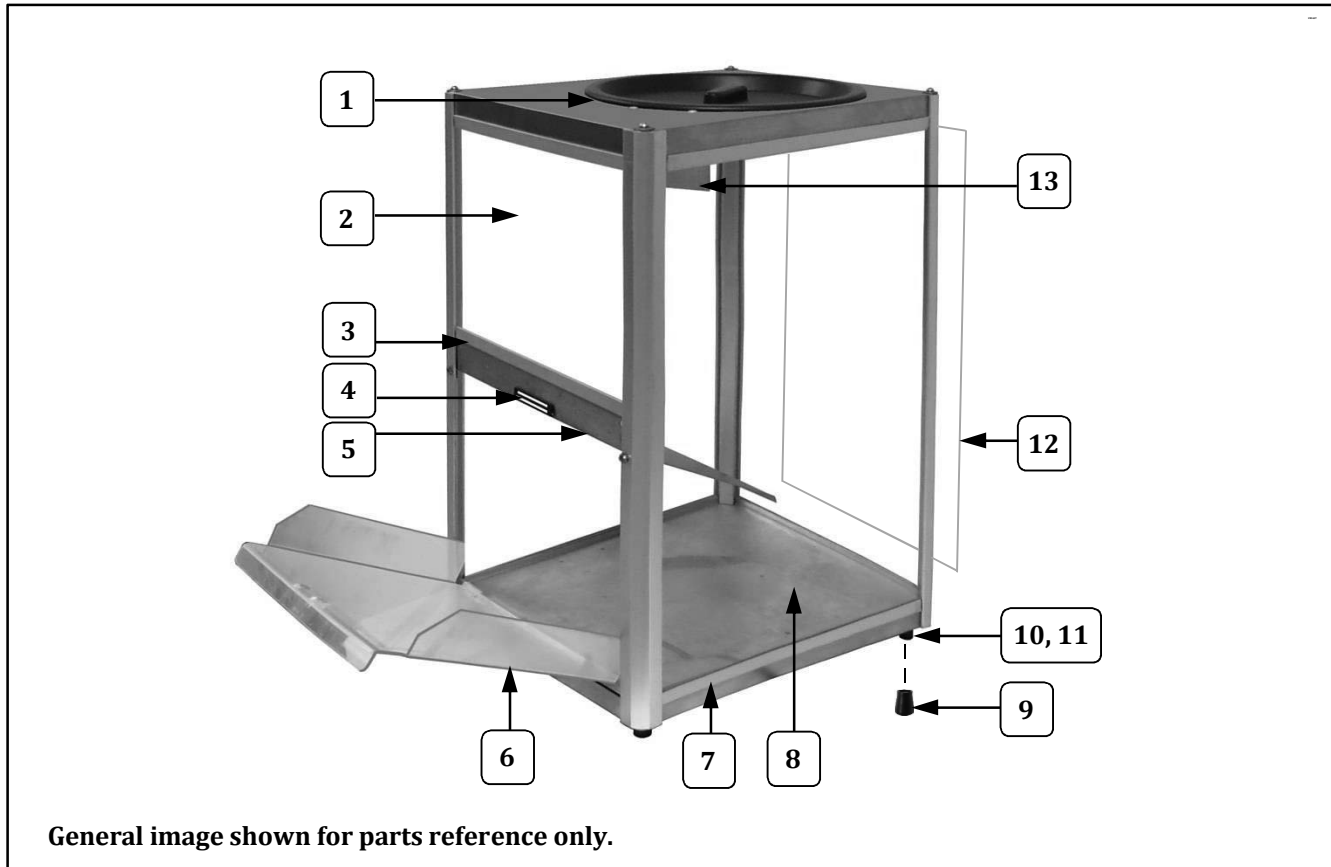

Item	Part Description	Part Number		
		2185ST	2187ST	2189
1	LID	100288	100288	100288
2	PLEXIGLASS PANEL (13 15/16 X 8 17/64)	40015	40015	
3	RETAINING EXTRUSION	40039	40039	49004
4	MAGNETIC CATCH	47561	47561	47561
5	BAFFLE	40009	40009	40065
6	DROP PANEL	40118	40118	40123
7	RETAINING EXTRUSION	40021	40021	40068
8	PLEXIGLAS PANEL	40014	40014	49019
9	CRUTCH TIP BLACK 70 DURO	49123	49123	49123
10	GLIDE	47328	47328	47328
11	SCREW, 10-24 X 3/4 HXHD	41314	41314	41314
12	PLEXIGLAS PANEL	40013	40013	49018
13	BULB PROTECTION L ANGLE	40050	40050	40050



Cabinet View

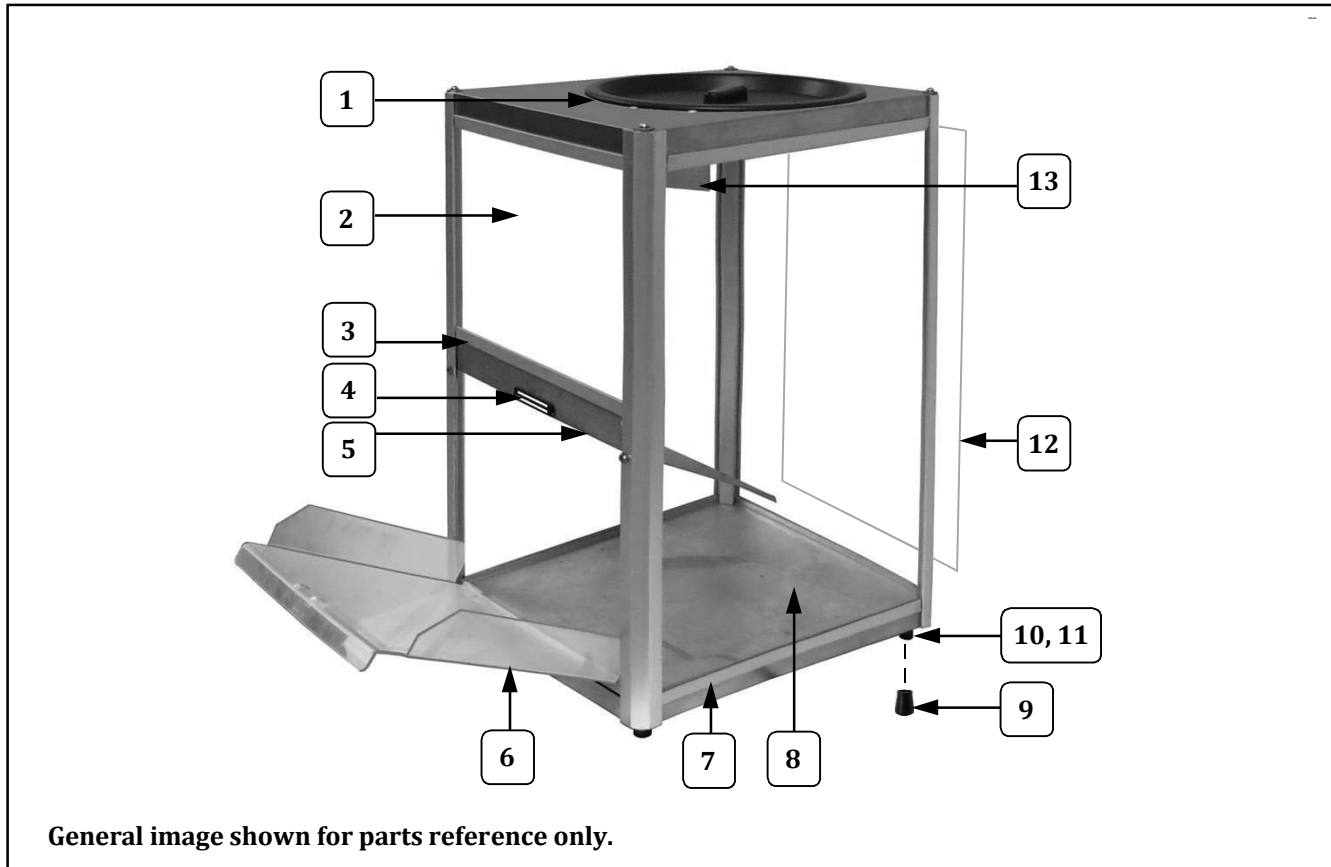

Item	Part Description	Part Number		
		2185ST	2187ST	2189
1	LID	100288	100288	100288
2	PLEXIGLASS PANEL (13 15/16 X 8 17/64)	40015	40015	
3	RETAINING EXTRUSION	40039	40039	49004
4	MAGNETIC CATCH	47561	47561	47561
5	BAFFLE	40009	40009	40065
6	DROP PANEL	40118	40118	40123
7	RETAINING EXTRUSION	40021	40021	40068
8	PLEXIGLAS PANEL	40014	40014	49019
9	CRUTCH TIP BLACK 70 DURO	49123	49123	49123
10	GLIDE	47328	47328	47328
11	SCREW, 10-24 X 3/4 HXHD	41314	41314	41314
12	PLEXIGLAS PANEL	40013	40013	49018
13	BULB PROTECTION L ANGLE	40050	40050	40050



Cabinet View

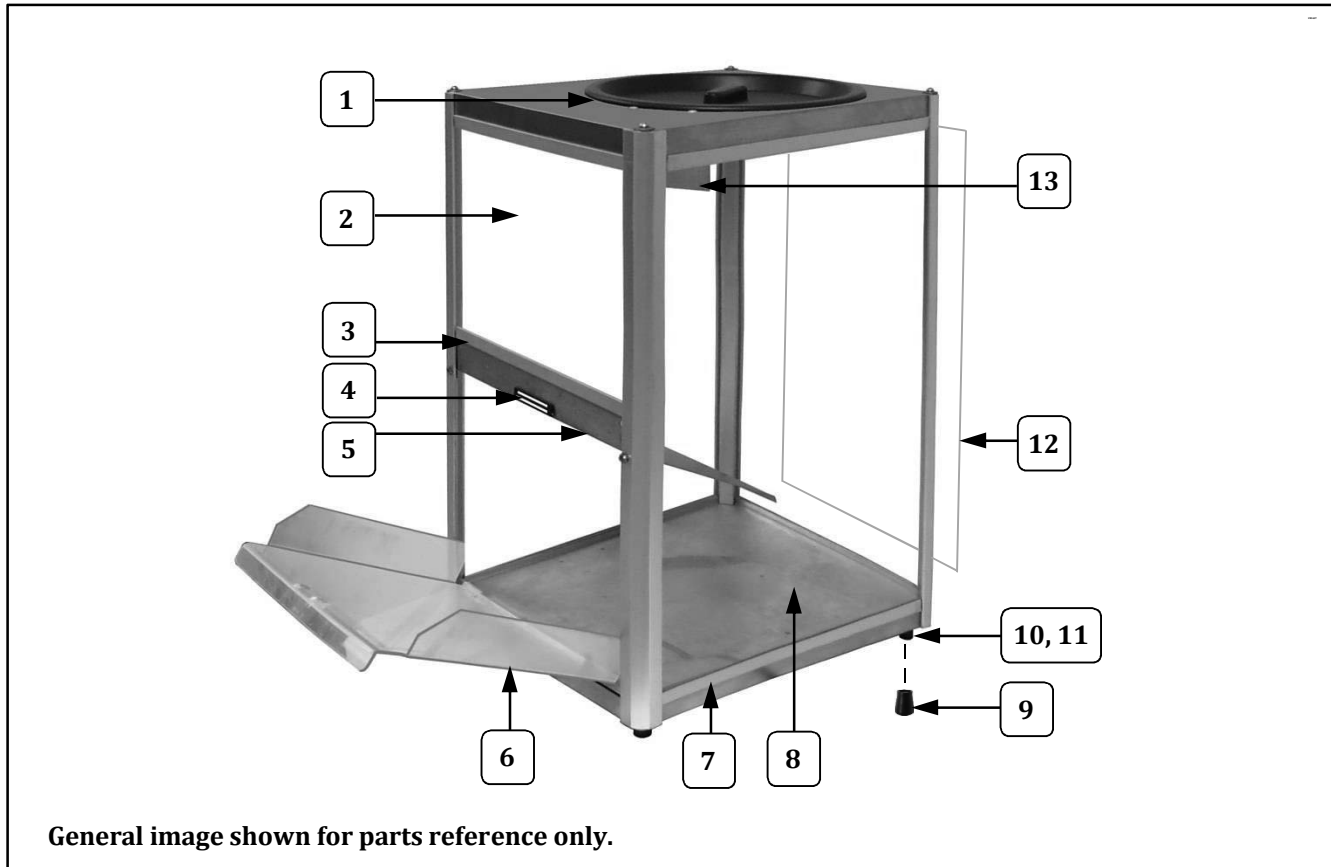

Item	Part Description	Part Number		
		2185ST	2187ST	2189
1	LID	100288	100288	100288
2	PLEXIGLASS PANEL (13 15/16 X 8 17/64)	40015	40015	
3	RETAINING EXTRUSION	40039	40039	49004
4	MAGNETIC CATCH	47561	47561	47561
5	BAFFLE	40009	40009	40065
6	DROP PANEL	40118	40118	40123
7	RETAINING EXTRUSION	40021	40021	40068
8	PLEXIGLAS PANEL	40014	40014	49019
9	CRUTCH TIP BLACK 70 DURO	49123	49123	49123
10	GLIDE	47328	47328	47328
11	SCREW, 10-24 X 3/4 HXHD	41314	41314	41314
12	PLEXIGLAS PANEL	40013	40013	49018
13	BULB PROTECTION L ANGLE	40050	40050	40050



Cabinet View

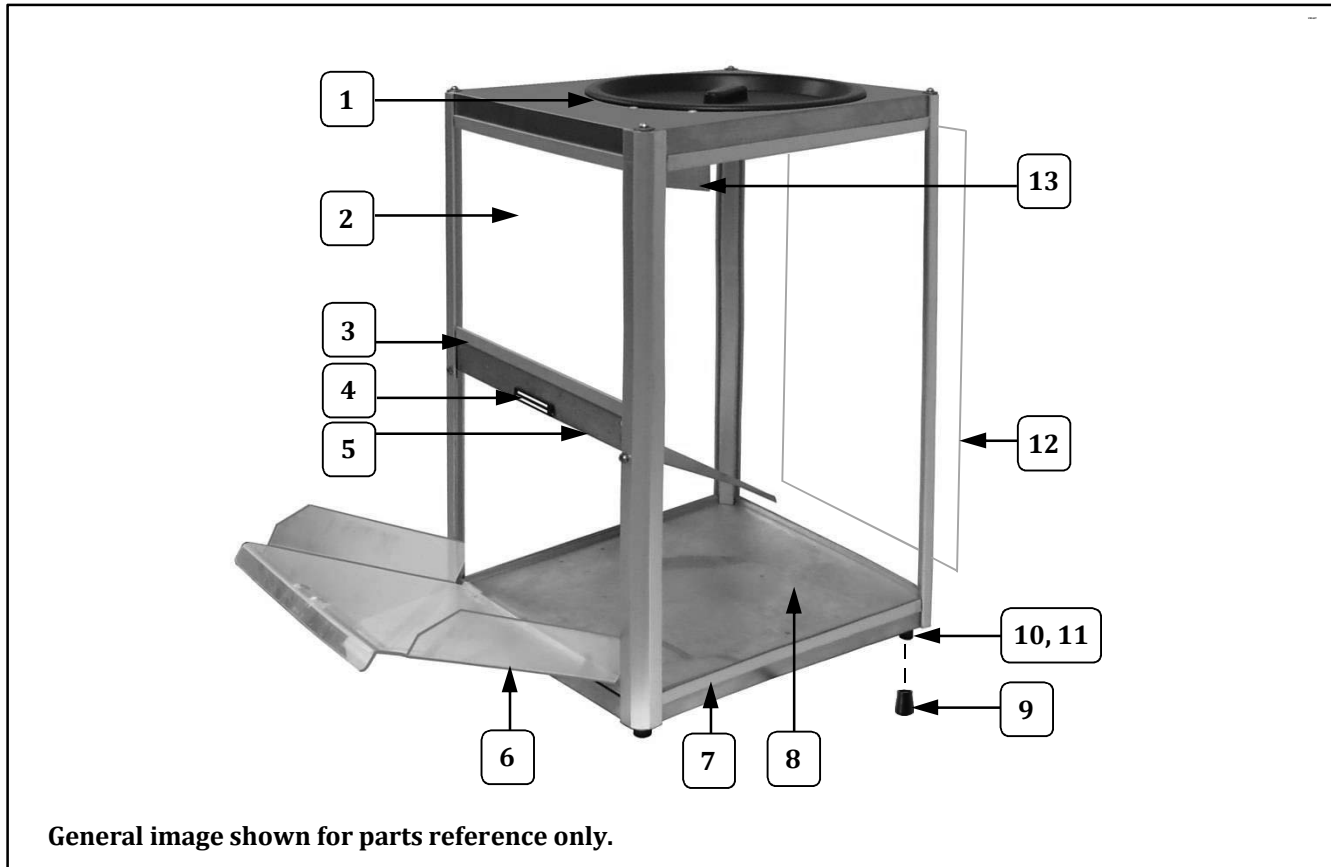

Item	Part Description	Part Number		
		2185ST	2187ST	2189
1	LID	100288	100288	100288
2	PLEXIGLASS PANEL (13 15/16 X 8 17/64)	40015	40015	
3	RETAINING EXTRUSION	40039	40039	49004
4	MAGNETIC CATCH	47561	47561	47561
5	BAFFLE	40009	40009	40065
6	DROP PANEL	40118	40118	40123
7	RETAINING EXTRUSION	40021	40021	40068
8	PLEXIGLAS PANEL	40014	40014	49019
9	CRUTCH TIP BLACK 70 DURO	49123	49123	49123
10	GLIDE	47328	47328	47328
11	SCREW, 10-24 X 3/4 HXHD	41314	41314	41314
12	PLEXIGLAS PANEL	40013	40013	49018
13	BULB PROTECTION L ANGLE	40050	40050	40050



Cabinet View

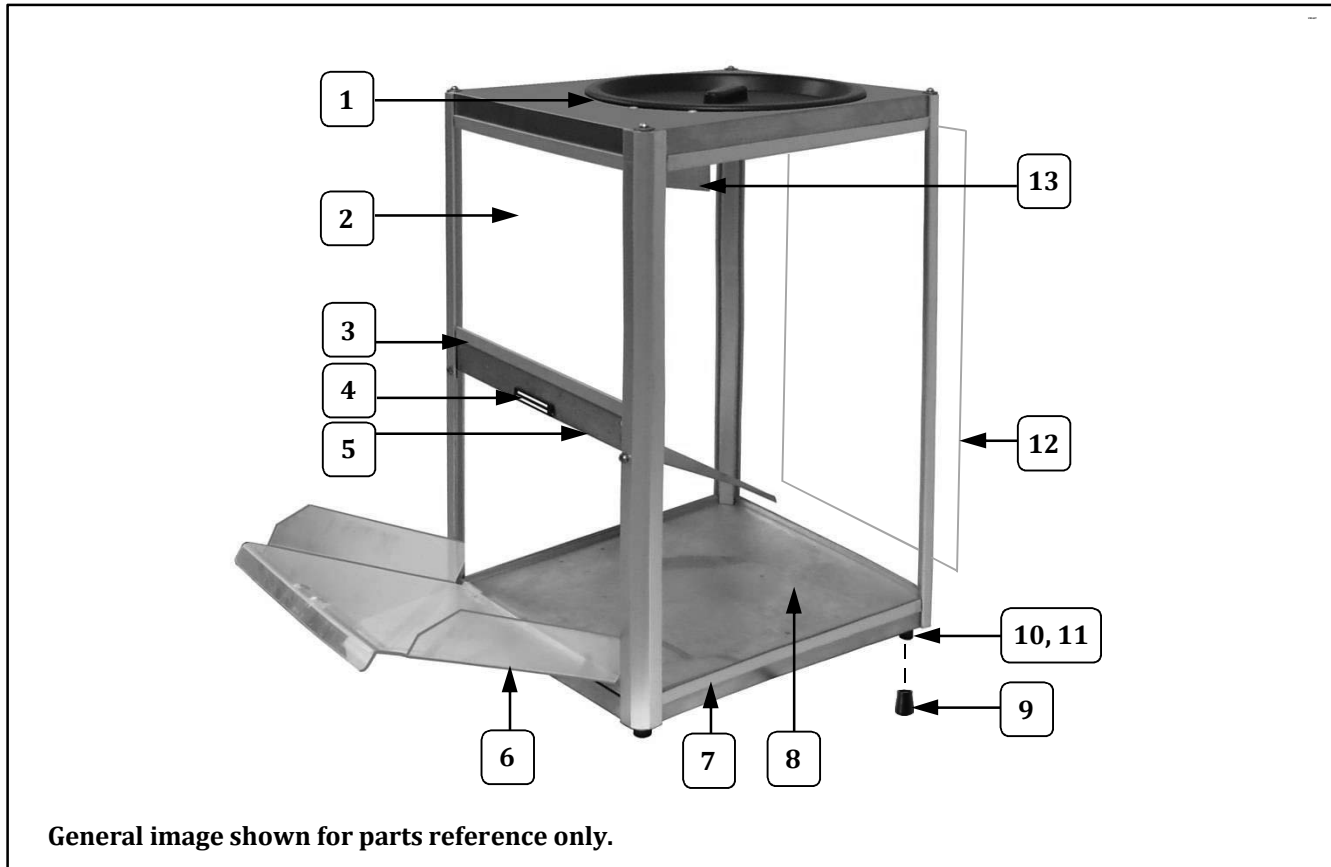

Item	Part Description	Part Number		
		2185ST	2187ST	2189
1	LID	100288	100288	100288
2	PLEXIGLASS PANEL (13 15/16 X 8 17/64)	40015	40015	
3	RETAINING EXTRUSION	40039	40039	49004
4	MAGNETIC CATCH	47561	47561	47561
5	BAFFLE	40009	40009	40065
6	DROP PANEL	40118	40118	40123
7	RETAINING EXTRUSION	40021	40021	40068
8	PLEXIGLAS PANEL	40014	40014	49019
9	CRUTCH TIP BLACK 70 DURO	49123	49123	49123
10	GLIDE	47328	47328	47328
11	SCREW, 10-24 X 3/4 HXHD	41314	41314	41314
12	PLEXIGLAS PANEL	40013	40013	49018
13	BULB PROTECTION L ANGLE	40050	40050	40050



Cabinet View

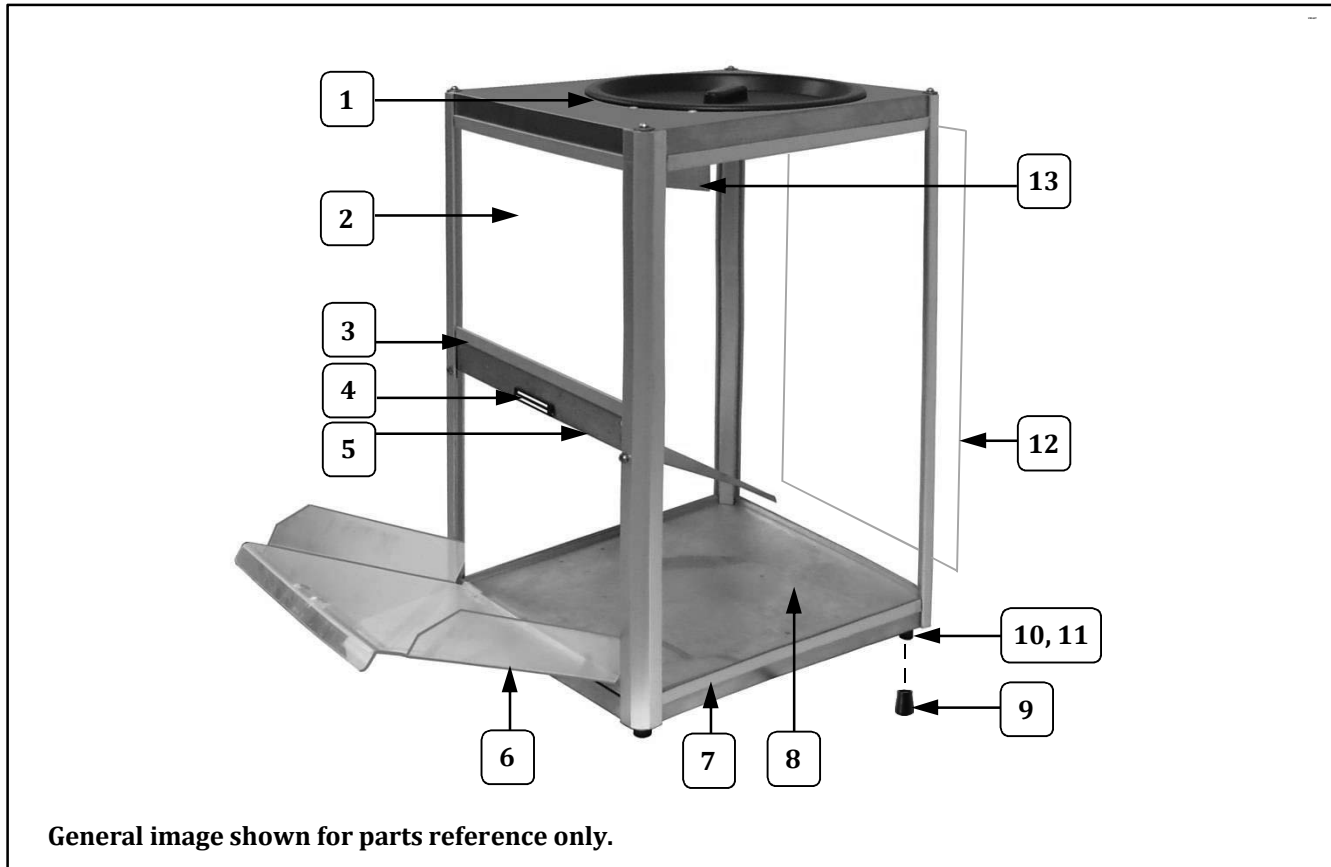

Item	Part Description	Part Number		
		2185ST	2187ST	2189
1	LID	100288	100288	100288
2	PLEXIGLASS PANEL (13 15/16 X 8 17/64)	40015	40015	
3	RETAINING EXTRUSION	40039	40039	49004
4	MAGNETIC CATCH	47561	47561	47561
5	BAFFLE	40009	40009	40065
6	DROP PANEL	40118	40118	40123
7	RETAINING EXTRUSION	40021	40021	40068
8	PLEXIGLAS PANEL	40014	40014	49019
9	CRUTCH TIP BLACK 70 DURO	49123	49123	49123
10	GLIDE	47328	47328	47328
11	SCREW, 10-24 X 3/4 HXHD	41314	41314	41314
12	PLEXIGLAS PANEL	40013	40013	49018
13	BULB PROTECTION L ANGLE	40050	40050	40050



Cabinet View

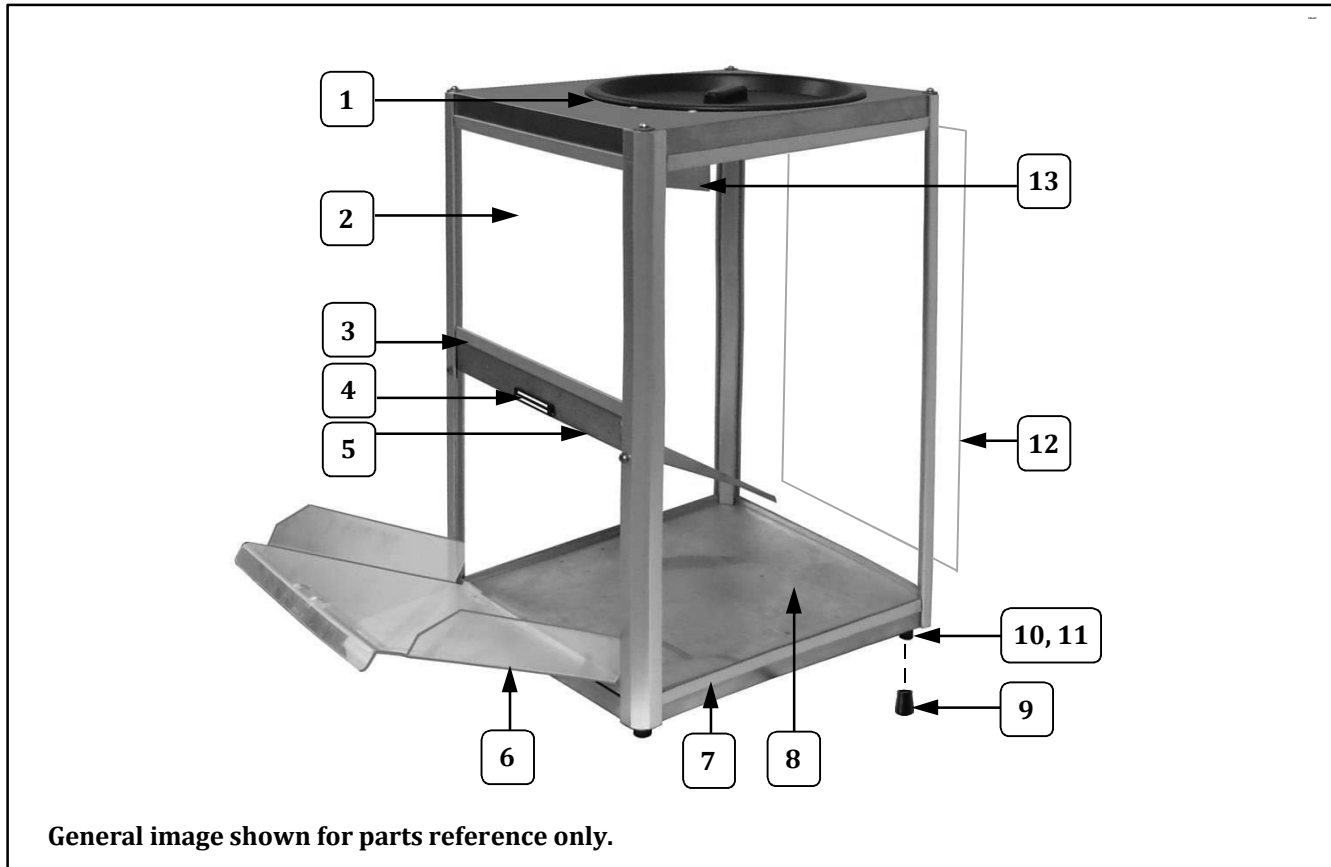

Item	Part Description	Part Number		
		2185ST	2187ST	2189
1	LID	100288	100288	100288
2	PLEXIGLASS PANEL (13 15/16 X 8 17/64)	40015	40015	
3	RETAINING EXTRUSION	40039	40039	49004
4	MAGNETIC CATCH	47561	47561	47561
5	BAFFLE	40009	40009	40065
6	DROP PANEL	40118	40118	40123
7	RETAINING EXTRUSION	40021	40021	40068
8	PLEXIGLAS PANEL	40014	40014	49019
9	CRUTCH TIP BLACK 70 DURO	49123	49123	49123
10	GLIDE	47328	47328	47328
11	SCREW, 10-24 X 3/4 HXHD	41314	41314	41314
12	PLEXIGLAS PANEL	40013	40013	49018
13	BULB PROTECTION L ANGLE	40050	40050	40050



Cabinet View

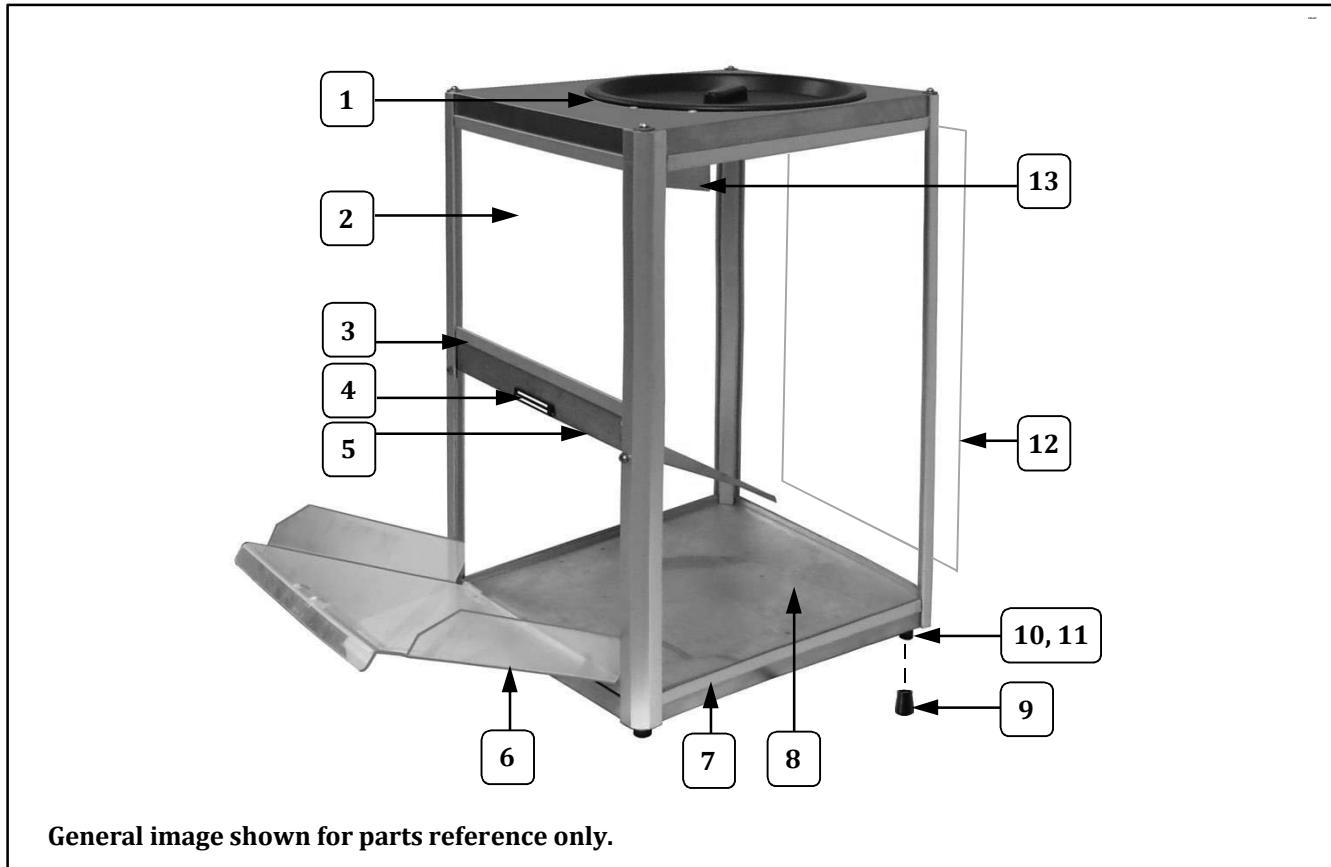

Item	Part Description	Part Number		
		2185ST	2187ST	2189
1	LID	100288	100288	100288
2	PLEXIGLASS PANEL (13 15/16 X 8 17/64)	40015	40015	
3	RETAINING EXTRUSION	40039	40039	49004
4	MAGNETIC CATCH	47561	47561	47561
5	BAFFLE	40009	40009	40065
6	DROP PANEL	40118	40118	40123
7	RETAINING EXTRUSION	40021	40021	40068
8	PLEXIGLAS PANEL	40014	40014	49019
9	CRUTCH TIP BLACK 70 DURO	49123	49123	49123
10	GLIDE	47328	47328	47328
11	SCREW, 10-24 X 3/4 HXHD	41314	41314	41314
12	PLEXIGLAS PANEL	40013	40013	49018
13	BULB PROTECTION L ANGLE	40050	40050	40050



Cabinet View

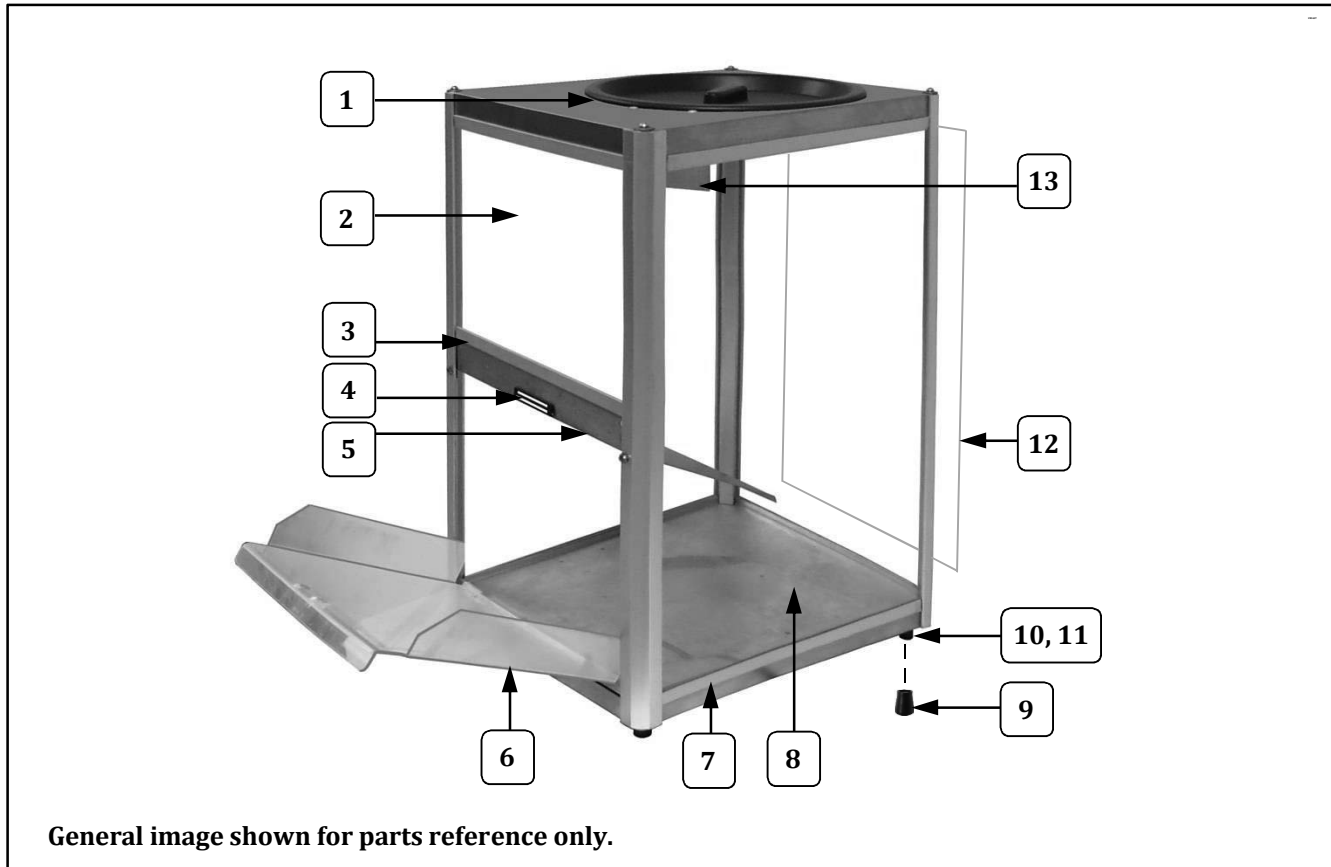

Item	Part Description	Part Number		
		2185ST	2187ST	2189
1	LID	100288	100288	100288
2	PLEXIGLASS PANEL (13 15/16 X 8 17/64)	40015	40015	
3	RETAINING EXTRUSION	40039	40039	49004
4	MAGNETIC CATCH	47561	47561	47561
5	BAFFLE	40009	40009	40065
6	DROP PANEL	40118	40118	40123
7	RETAINING EXTRUSION	40021	40021	40068
8	PLEXIGLAS PANEL	40014	40014	49019
9	CRUTCH TIP BLACK 70 DURO	49123	49123	49123
10	GLIDE	47328	47328	47328
11	SCREW, 10-24 X 3/4 HXHD	41314	41314	41314
12	PLEXIGLAS PANEL	40013	40013	49018
13	BULB PROTECTION L ANGLE	40050	40050	40050



Cabinet View

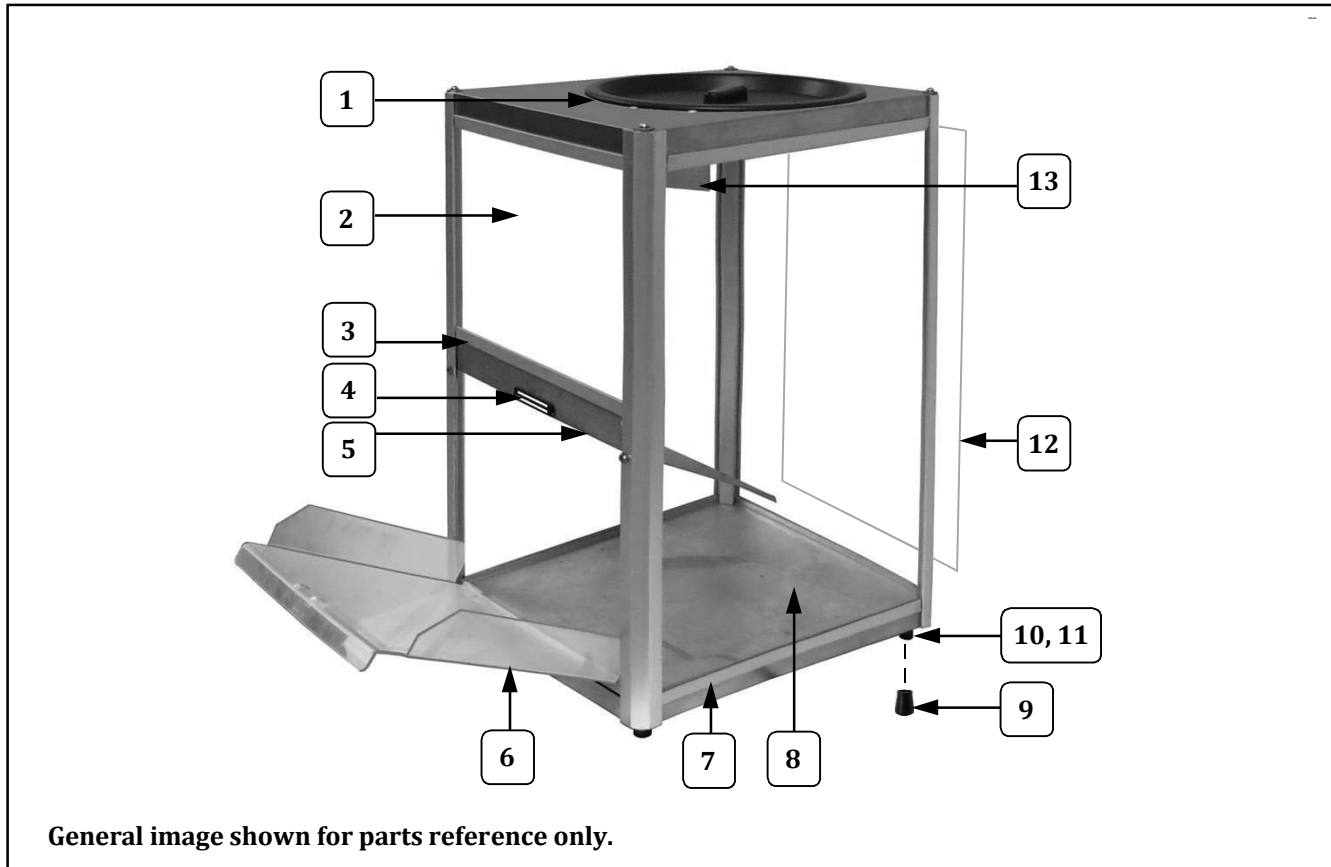

Item	Part Description	Part Number		
		2185ST	2187ST	2189
1	LID	100288	100288	100288
2	PLEXIGLASS PANEL (13 15/16 X 8 17/64)	40015	40015	
3	RETAINING EXTRUSION	40039	40039	49004
4	MAGNETIC CATCH	47561	47561	47561
5	BAFFLE	40009	40009	40065
6	DROP PANEL	40118	40118	40123
7	RETAINING EXTRUSION	40021	40021	40068
8	PLEXIGLAS PANEL	40014	40014	49019
9	CRUTCH TIP BLACK 70 DURO	49123	49123	49123
10	GLIDE	47328	47328	47328
11	SCREW, 10-24 X 3/4 HXHD	41314	41314	41314
12	PLEXIGLAS PANEL	40013	40013	49018
13	BULB PROTECTION L ANGLE	40050	40050	40050



Cabinet View

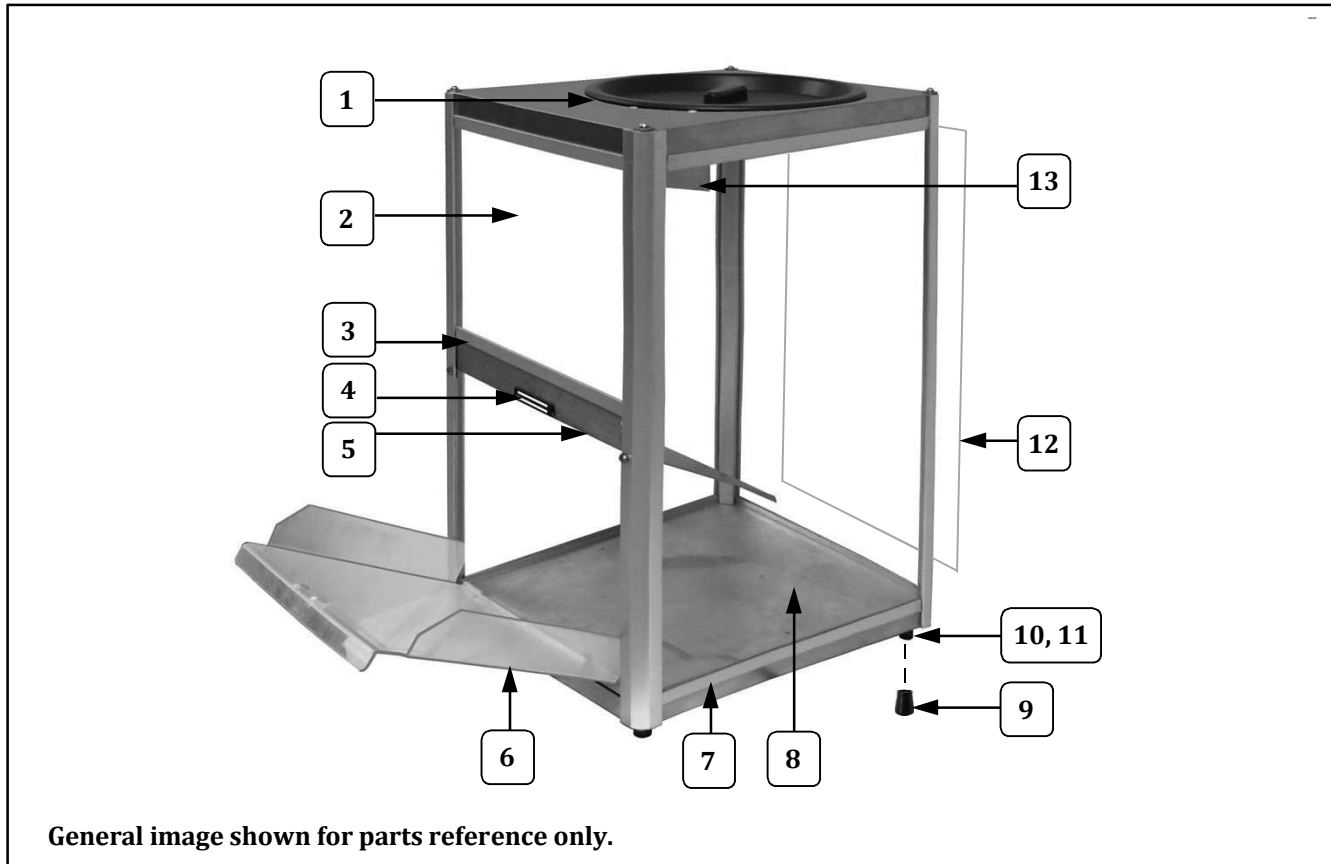

Item	Part Description	Part Number		
		2185ST	2187ST	2189
1	LID	100288	100288	100288
2	PLEXIGLASS PANEL (13 15/16 X 8 17/64)	40015	40015	
3	RETAINING EXTRUSION	40039	40039	49004
4	MAGNETIC CATCH	47561	47561	47561
5	BAFFLE	40009	40009	40065
6	DROP PANEL	40118	40118	40123
7	RETAINING EXTRUSION	40021	40021	40068
8	PLEXIGLAS PANEL	40014	40014	49019
9	CRUTCH TIP BLACK 70 DURO	49123	49123	49123
10	GLIDE	47328	47328	47328
11	SCREW, 10-24 X 3/4 HXHD	41314	41314	41314
12	PLEXIGLAS PANEL	40013	40013	49018
13	BULB PROTECTION L ANGLE	40050	40050	40050



Cabinet View

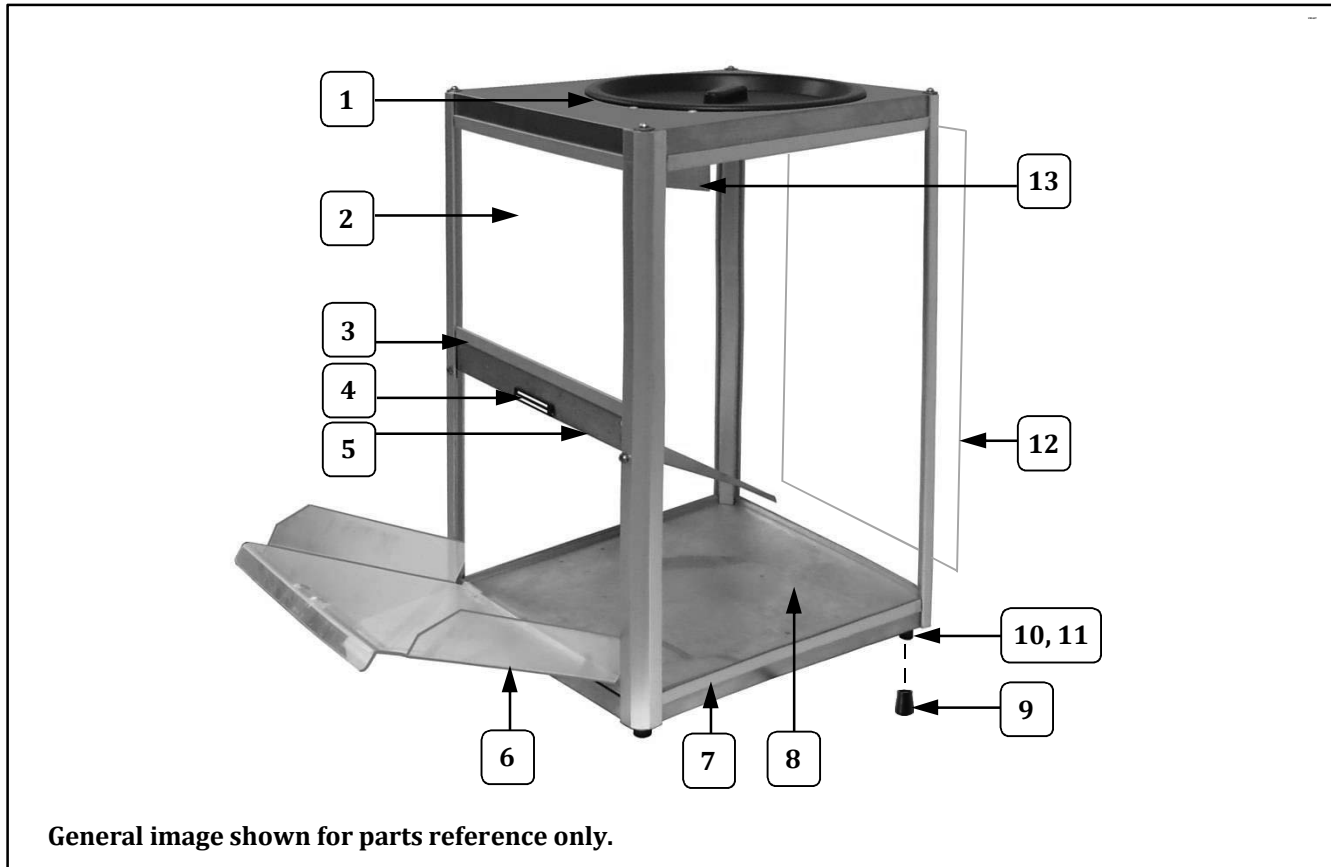

Item	Part Description	Part Number		
		2185ST	2187ST	2189
1	LID	100288	100288	100288
2	PLEXIGLASS PANEL (13 15/16 X 8 17/64)	40015	40015	
3	RETAINING EXTRUSION	40039	40039	49004
4	MAGNETIC CATCH	47561	47561	47561
5	BAFFLE	40009	40009	40065
6	DROP PANEL	40118	40118	40123
7	RETAINING EXTRUSION	40021	40021	40068
8	PLEXIGLAS PANEL	40014	40014	49019
9	CRUTCH TIP BLACK 70 DURO	49123	49123	49123
10	GLIDE	47328	47328	47328
11	SCREW, 10-24 X 3/4 HXHD	41314	41314	41314
12	PLEXIGLAS PANEL	40013	40013	49018
13	BULB PROTECTION L ANGLE	40050	40050	40050



Cabinet View

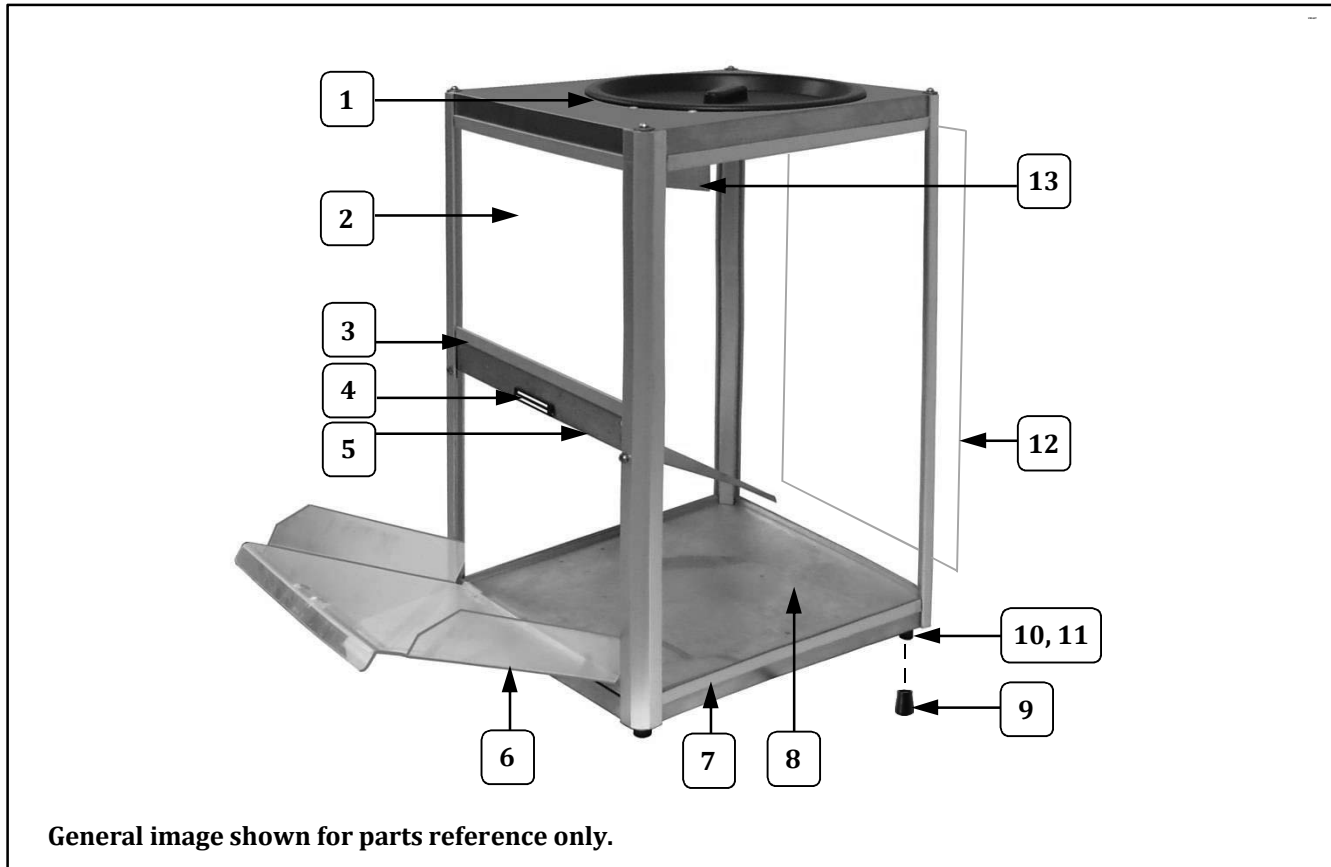

Item	Part Description	Part Number		
		2185ST	2187ST	2189
1	LID	100288	100288	100288
2	PLEXIGLASS PANEL (13 15/16 X 8 17/64)	40015	40015	
3	RETAINING EXTRUSION	40039	40039	49004
4	MAGNETIC CATCH	47561	47561	47561
5	BAFFLE	40009	40009	40065
6	DROP PANEL	40118	40118	40123
7	RETAINING EXTRUSION	40021	40021	40068
8	PLEXIGLAS PANEL	40014	40014	49019
9	CRUTCH TIP BLACK 70 DURO	49123	49123	49123
10	GLIDE	47328	47328	47328
11	SCREW, 10-24 X 3/4 HXHD	41314	41314	41314
12	PLEXIGLAS PANEL	40013	40013	49018
13	BULB PROTECTION L ANGLE	40050	40050	40050



Cabinet View

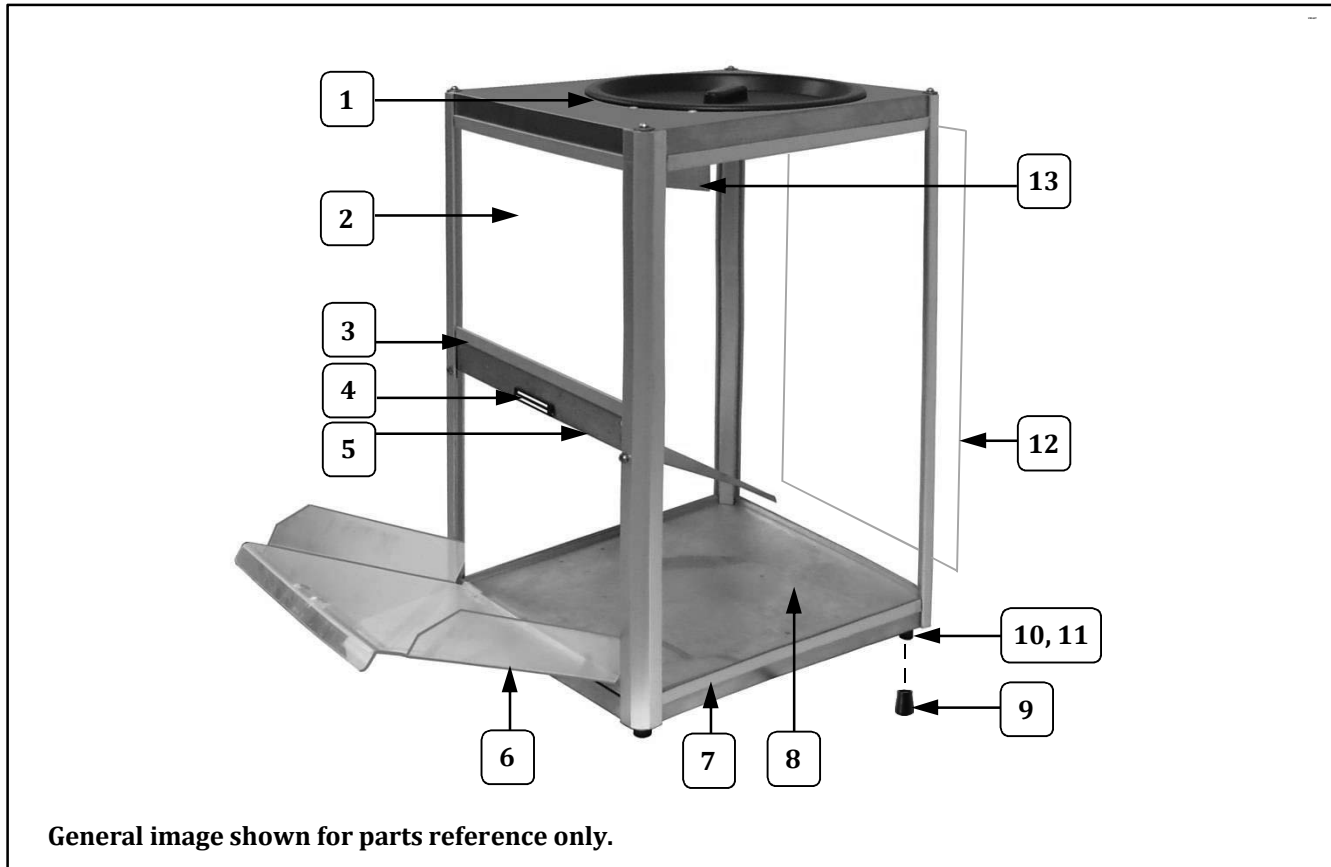

Item	Part Description	Part Number		
		2185ST	2187ST	2189
1	LID	100288	100288	100288
2	PLEXIGLASS PANEL (13 15/16 X 8 17/64)	40015	40015	
3	RETAINING EXTRUSION	40039	40039	49004
4	MAGNETIC CATCH	47561	47561	47561
5	BAFFLE	40009	40009	40065
6	DROP PANEL	40118	40118	40123
7	RETAINING EXTRUSION	40021	40021	40068
8	PLEXIGLAS PANEL	40014	40014	49019
9	CRUTCH TIP BLACK 70 DURO	49123	49123	49123
10	GLIDE	47328	47328	47328
11	SCREW, 10-24 X 3/4 HXHD	41314	41314	41314
12	PLEXIGLAS PANEL	40013	40013	49018
13	BULB PROTECTION L ANGLE	40050	40050	40050



Cabinet View

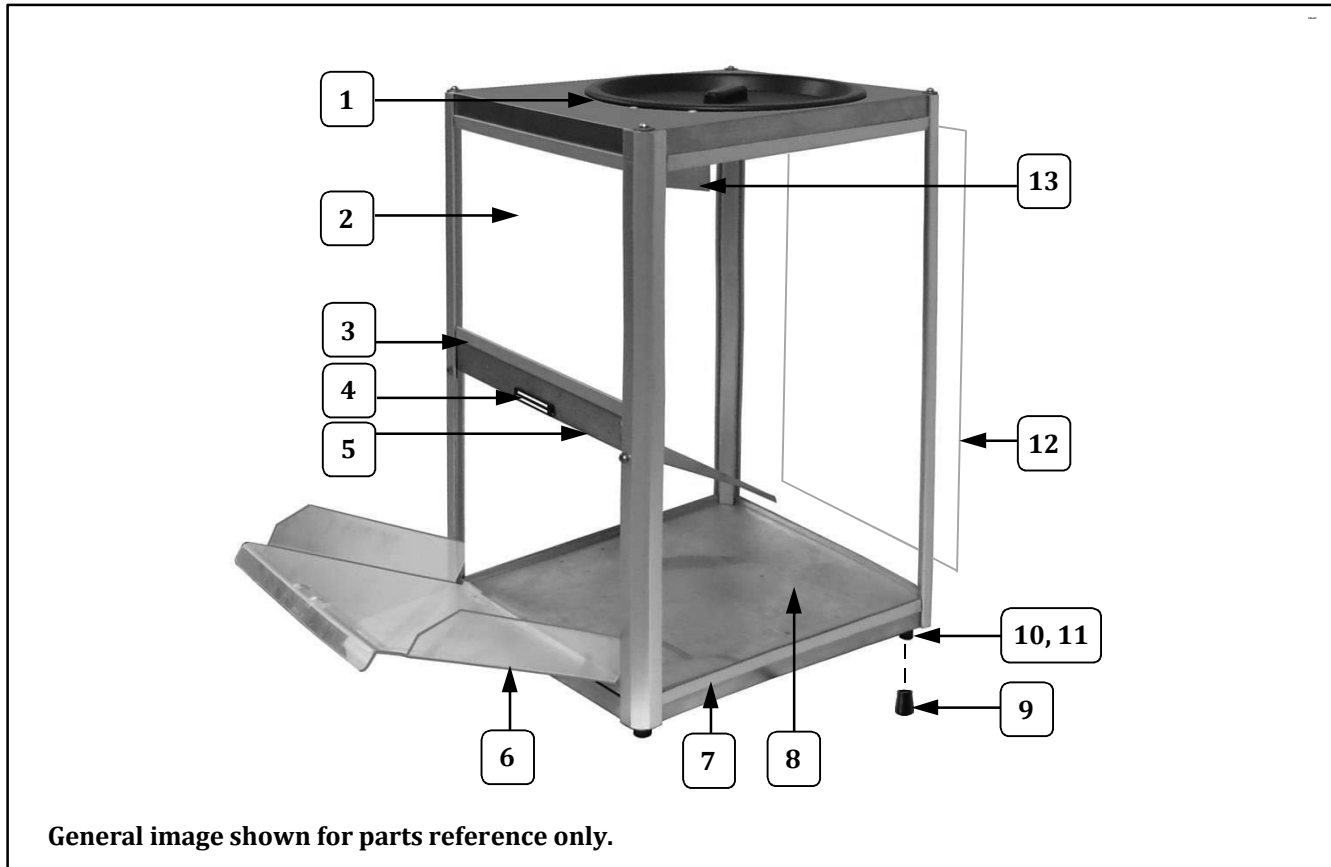

Item	Part Description	Part Number		
		2185ST	2187ST	2189
1	LID	100288	100288	100288
2	PLEXIGLASS PANEL (13 15/16 X 8 17/64)	40015	40015	
3	RETAINING EXTRUSION	40039	40039	49004
4	MAGNETIC CATCH	47561	47561	47561
5	BAFFLE	40009	40009	40065
6	DROP PANEL	40118	40118	40123
7	RETAINING EXTRUSION	40021	40021	40068
8	PLEXIGLAS PANEL	40014	40014	49019
9	CRUTCH TIP BLACK 70 DURO	49123	49123	49123
10	GLIDE	47328	47328	47328
11	SCREW, 10-24 X 3/4 HXHD	41314	41314	41314
12	PLEXIGLAS PANEL	40013	40013	49018
13	BULB PROTECTION L ANGLE	40050	40050	40050



Cabinet View

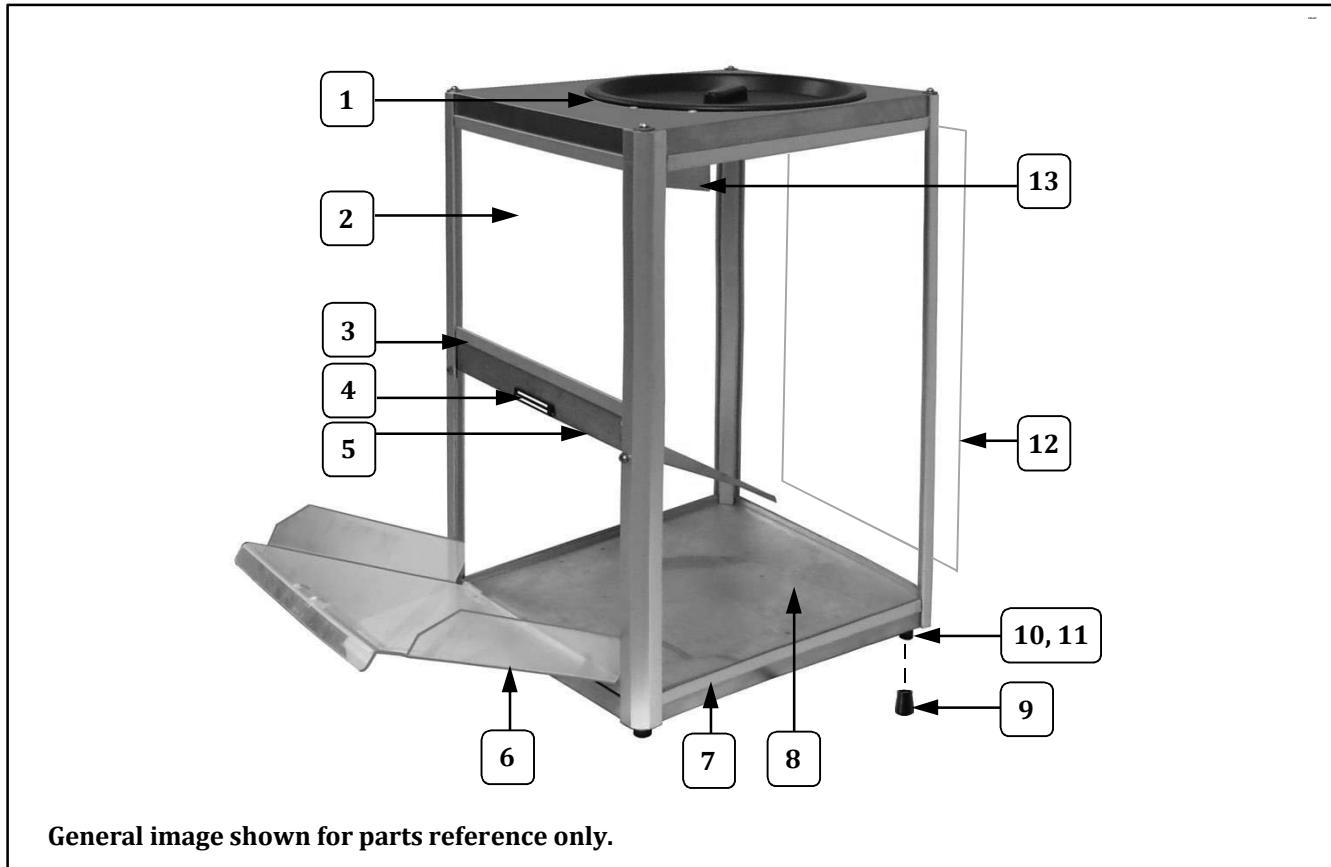

Item	Part Description	Part Number		
		2185ST	2187ST	2189
1	LID	100288	100288	100288
2	PLEXIGLASS PANEL (13 15/16 X 8 17/64)	40015	40015	
3	RETAINING EXTRUSION	40039	40039	49004
4	MAGNETIC CATCH	47561	47561	47561
5	BAFFLE	40009	40009	40065
6	DROP PANEL	40118	40118	40123
7	RETAINING EXTRUSION	40021	40021	40068
8	PLEXIGLAS PANEL	40014	40014	49019
9	CRUTCH TIP BLACK 70 DURO	49123	49123	49123
10	GLIDE	47328	47328	47328
11	SCREW, 10-24 X 3/4 HXHD	41314	41314	41314
12	PLEXIGLAS PANEL	40013	40013	49018
13	BULB PROTECTION L ANGLE	40050	40050	40050



Cabinet View

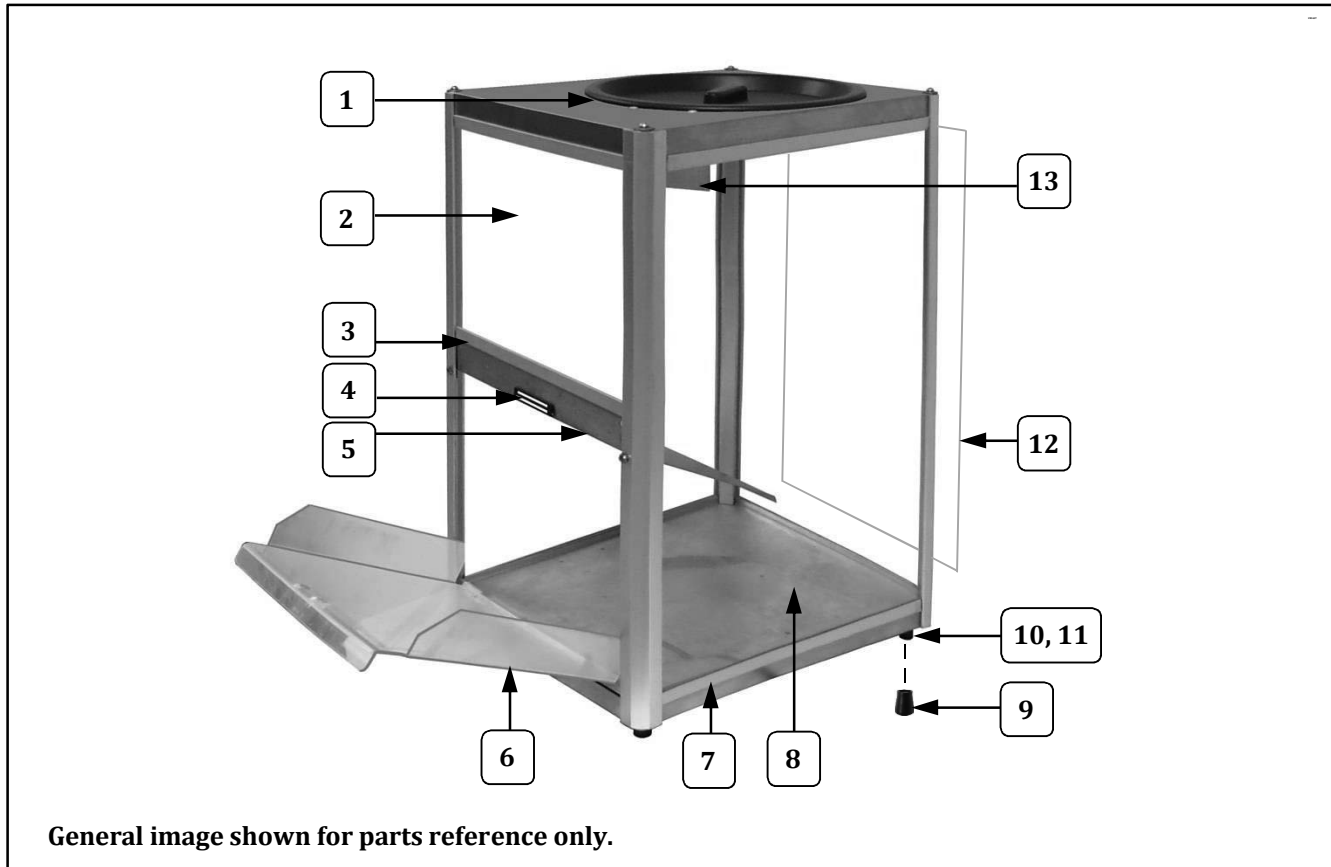

Item	Part Description	Part Number		
		2185ST	2187ST	2189
1	LID	100288	100288	100288
2	PLEXIGLASS PANEL (13 15/16 X 8 17/64)	40015	40015	
3	RETAINING EXTRUSION	40039	40039	49004
4	MAGNETIC CATCH	47561	47561	47561
5	BAFFLE	40009	40009	40065
6	DROP PANEL	40118	40118	40123
7	RETAINING EXTRUSION	40021	40021	40068
8	PLEXIGLAS PANEL	40014	40014	49019
9	CRUTCH TIP BLACK 70 DURO	49123	49123	49123
10	GLIDE	47328	47328	47328
11	SCREW, 10-24 X 3/4 HXHD	41314	41314	41314
12	PLEXIGLAS PANEL	40013	40013	49018
13	BULB PROTECTION L ANGLE	40050	40050	40050



Cabinet View

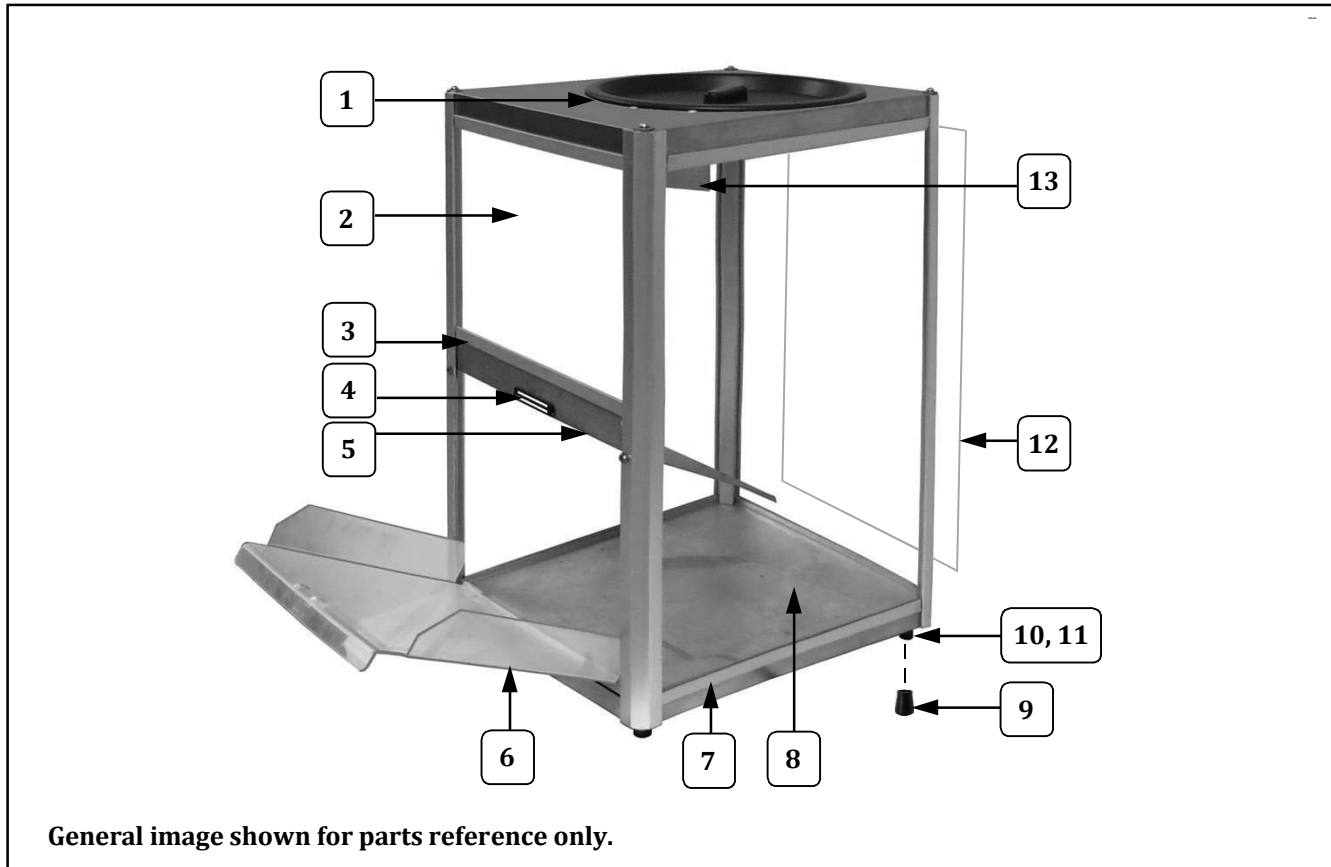

Item	Part Description	Part Number		
		2185ST	2187ST	2189
1	LID	100288	100288	100288
2	PLEXIGLASS PANEL (13 15/16 X 8 17/64)	40015	40015	
3	RETAINING EXTRUSION	40039	40039	49004
4	MAGNETIC CATCH	47561	47561	47561
5	BAFFLE	40009	40009	40065
6	DROP PANEL	40118	40118	40123
7	RETAINING EXTRUSION	40021	40021	40068
8	PLEXIGLAS PANEL	40014	40014	49019
9	CRUTCH TIP BLACK 70 DURO	49123	49123	49123
10	GLIDE	47328	47328	47328
11	SCREW, 10-24 X 3/4 HXHD	41314	41314	41314
12	PLEXIGLAS PANEL	40013	40013	49018
13	BULB PROTECTION L ANGLE	40050	40050	40050



Cabinet View

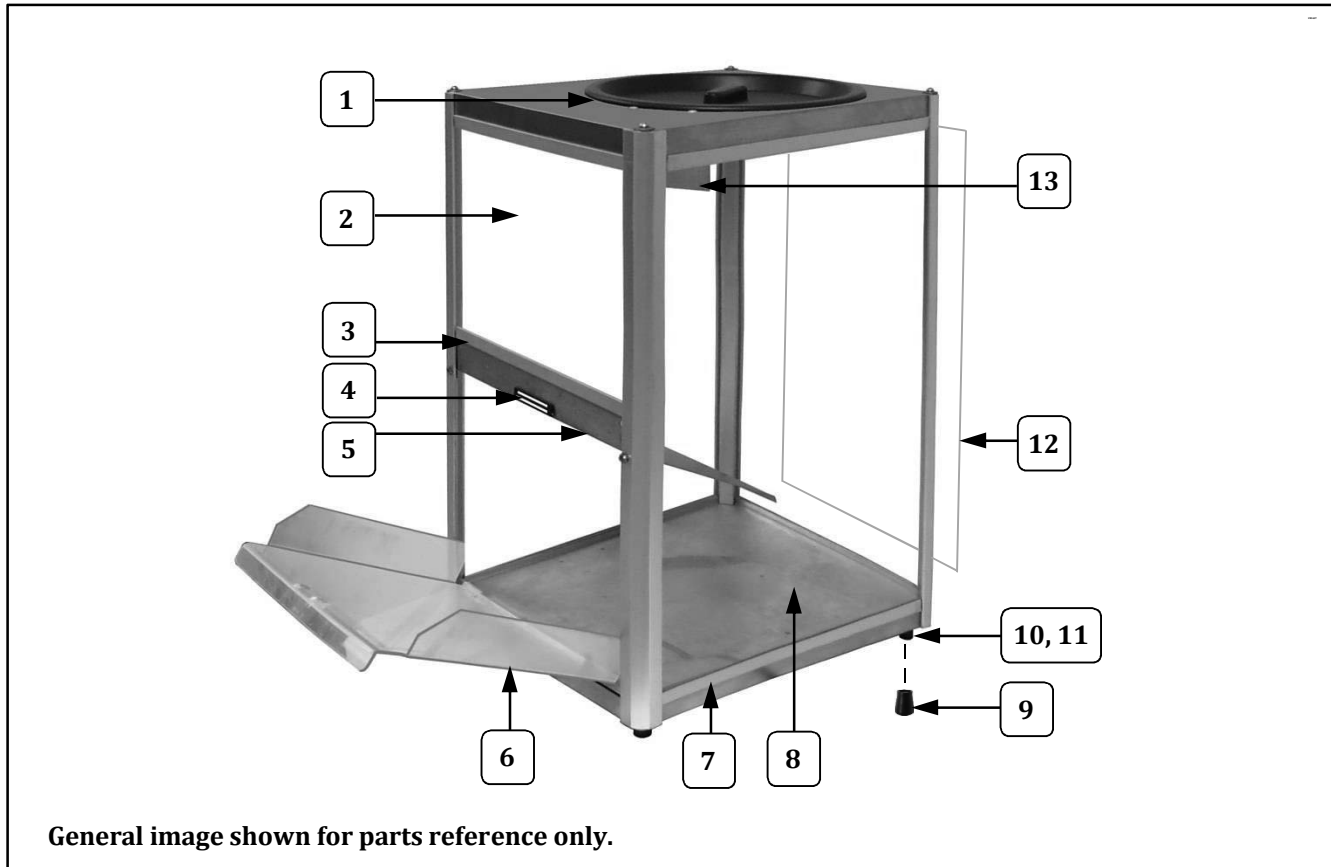

Item	Part Description	Part Number		
		2185ST	2187ST	2189
1	LID	100288	100288	100288
2	PLEXIGLASS PANEL (13 15/16 X 8 17/64)	40015	40015	
3	RETAINING EXTRUSION	40039	40039	49004
4	MAGNETIC CATCH	47561	47561	47561
5	BAFFLE	40009	40009	40065
6	DROP PANEL	40118	40118	40123
7	RETAINING EXTRUSION	40021	40021	40068
8	PLEXIGLAS PANEL	40014	40014	49019
9	CRUTCH TIP BLACK 70 DURO	49123	49123	49123
10	GLIDE	47328	47328	47328
11	SCREW, 10-24 X 3/4 HXHD	41314	41314	41314
12	PLEXIGLAS PANEL	40013	40013	49018
13	BULB PROTECTION L ANGLE	40050	40050	40050



Cabinet View

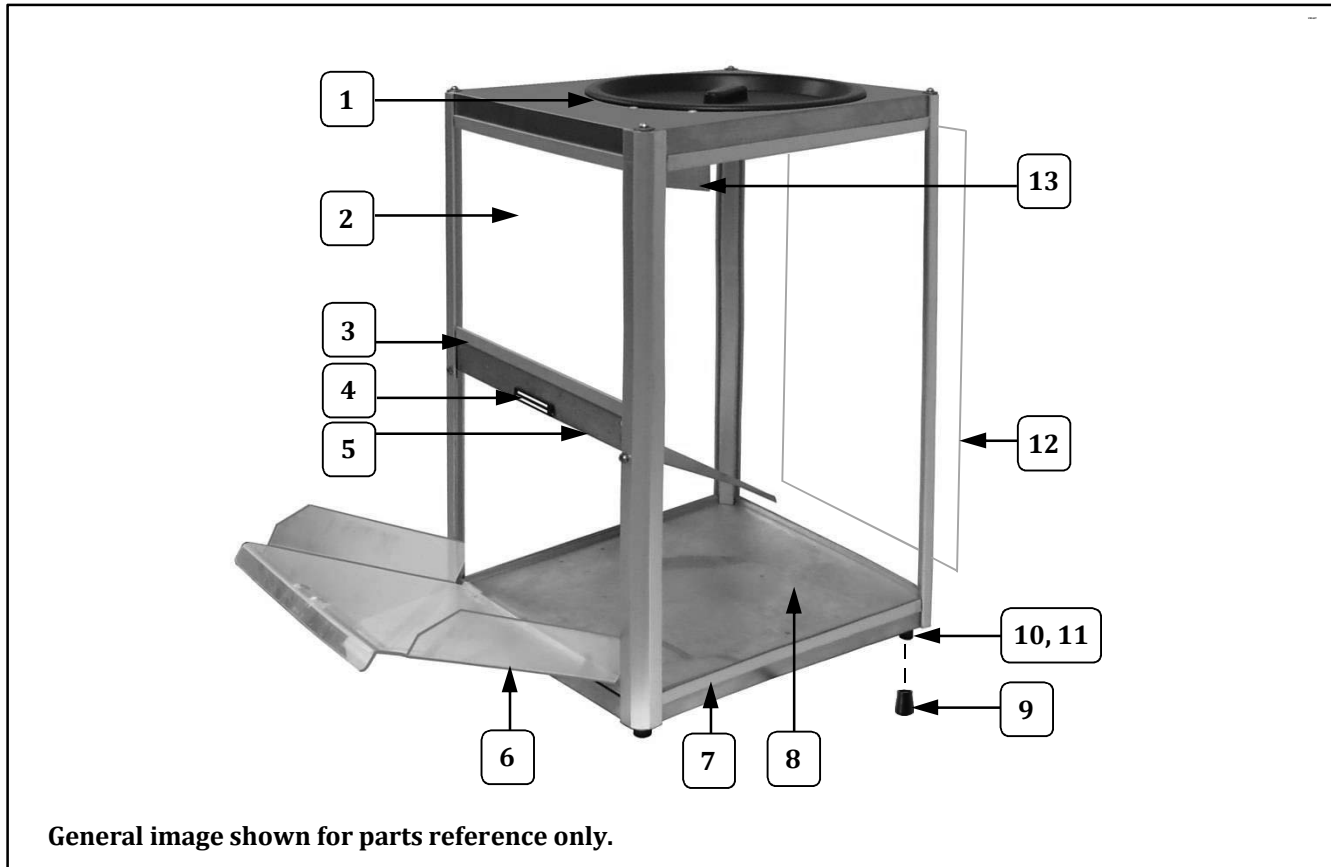

Item	Part Description	Part Number		
		2185ST	2187ST	2189
1	LID	100288	100288	100288
2	PLEXIGLASS PANEL (13 15/16 X 8 17/64)	40015	40015	
3	RETAINING EXTRUSION	40039	40039	49004
4	MAGNETIC CATCH	47561	47561	47561
5	BAFFLE	40009	40009	40065
6	DROP PANEL	40118	40118	40123
7	RETAINING EXTRUSION	40021	40021	40068
8	PLEXIGLAS PANEL	40014	40014	49019
9	CRUTCH TIP BLACK 70 DURO	49123	49123	49123
10	GLIDE	47328	47328	47328
11	SCREW, 10-24 X 3/4 HXHD	41314	41314	41314
12	PLEXIGLAS PANEL	40013	40013	49018
13	BULB PROTECTION L ANGLE	40050	40050	40050



Cabinet View

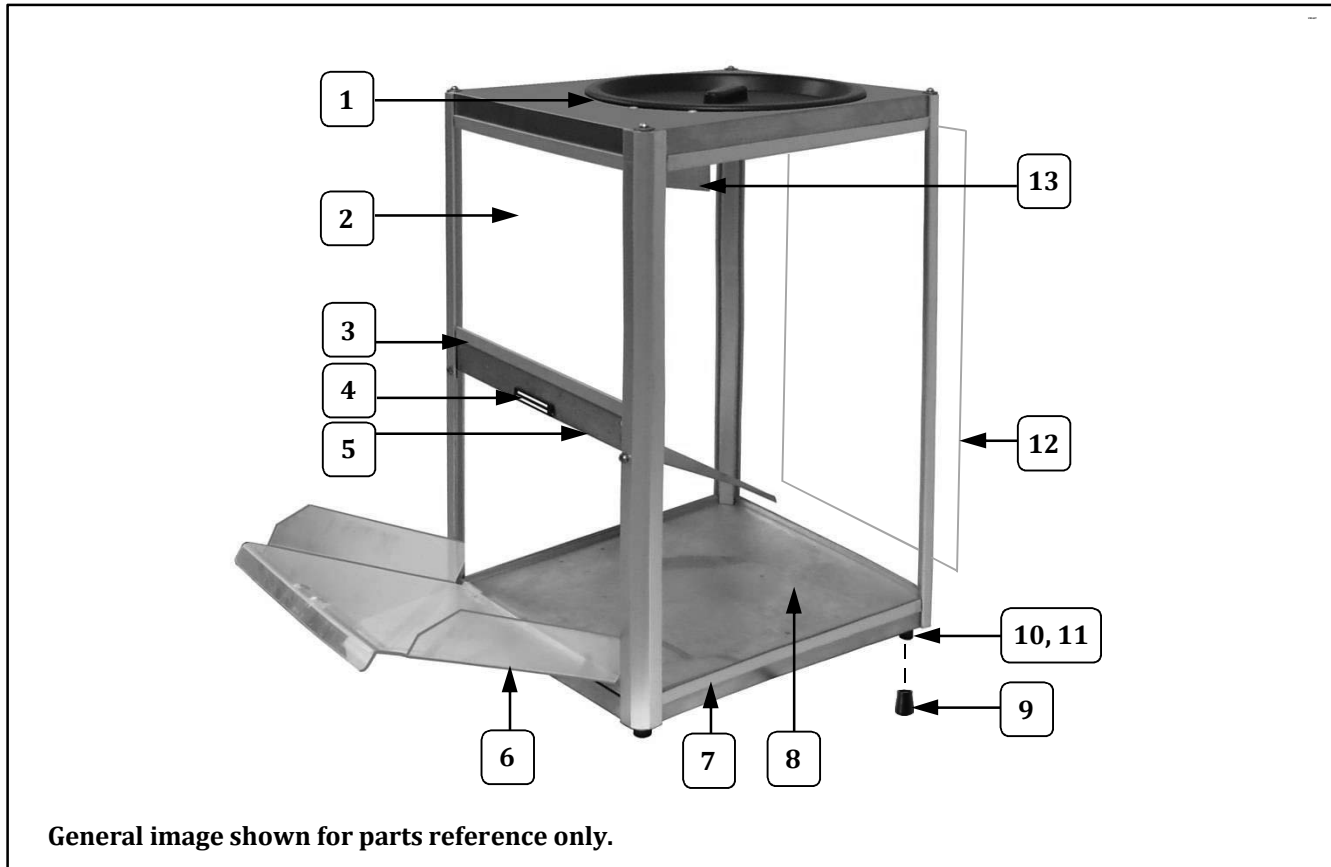

Item	Part Description	Part Number		
		2185ST	2187ST	2189
1	LID	100288	100288	100288
2	PLEXIGLASS PANEL (13 15/16 X 8 17/64)	40015	40015	
3	RETAINING EXTRUSION	40039	40039	49004
4	MAGNETIC CATCH	47561	47561	47561
5	BAFFLE	40009	40009	40065
6	DROP PANEL	40118	40118	40123
7	RETAINING EXTRUSION	40021	40021	40068
8	PLEXIGLAS PANEL	40014	40014	49019
9	CRUTCH TIP BLACK 70 DURO	49123	49123	49123
10	GLIDE	47328	47328	47328
11	SCREW, 10-24 X 3/4 HXHD	41314	41314	41314
12	PLEXIGLAS PANEL	40013	40013	49018
13	BULB PROTECTION L ANGLE	40050	40050	40050



Cabinet View

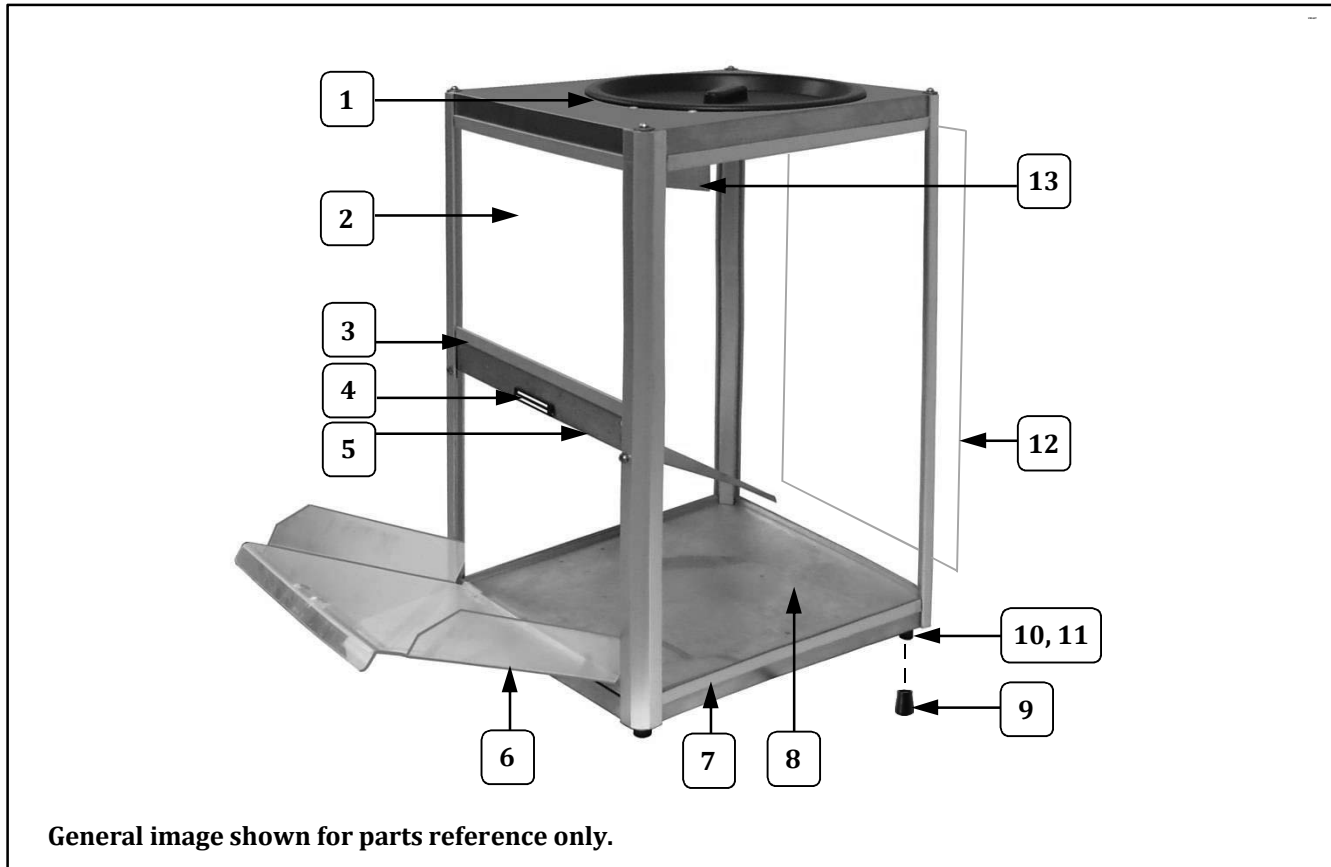

Item	Part Description	Part Number		
		2185ST	2187ST	2189
1	LID	100288	100288	100288
2	PLEXIGLASS PANEL (13 15/16 X 8 17/64)	40015	40015	
3	RETAINING EXTRUSION	40039	40039	49004
4	MAGNETIC CATCH	47561	47561	47561
5	BAFFLE	40009	40009	40065
6	DROP PANEL	40118	40118	40123
7	RETAINING EXTRUSION	40021	40021	40068
8	PLEXIGLAS PANEL	40014	40014	49019
9	CRUTCH TIP BLACK 70 DURO	49123	49123	49123
10	GLIDE	47328	47328	47328
11	SCREW, 10-24 X 3/4 HXHD	41314	41314	41314
12	PLEXIGLAS PANEL	40013	40013	49018
13	BULB PROTECTION L ANGLE	40050	40050	40050



Cabinet View

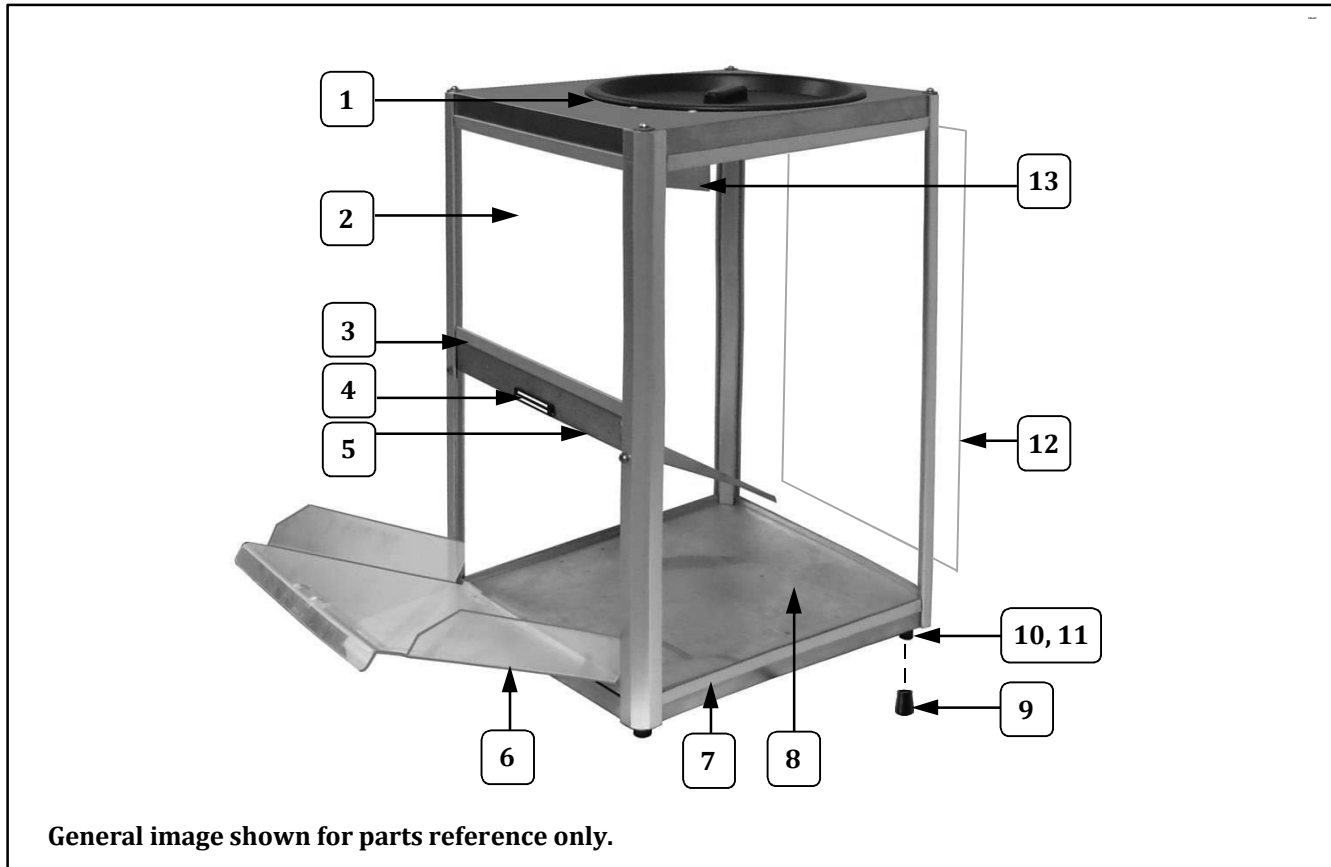

Item	Part Description	Part Number		
		2185ST	2187ST	2189
1	LID	100288	100288	100288
2	PLEXIGLASS PANEL (13 15/16 X 8 17/64)	40015	40015	
3	RETAINING EXTRUSION	40039	40039	49004
4	MAGNETIC CATCH	47561	47561	47561
5	BAFFLE	40009	40009	40065
6	DROP PANEL	40118	40118	40123
7	RETAINING EXTRUSION	40021	40021	40068
8	PLEXIGLAS PANEL	40014	40014	49019
9	CRUTCH TIP BLACK 70 DURO	49123	49123	49123
10	GLIDE	47328	47328	47328
11	SCREW, 10-24 X 3/4 HXHD	41314	41314	41314
12	PLEXIGLAS PANEL	40013	40013	49018
13	BULB PROTECTION L ANGLE	40050	40050	40050



Cabinet View

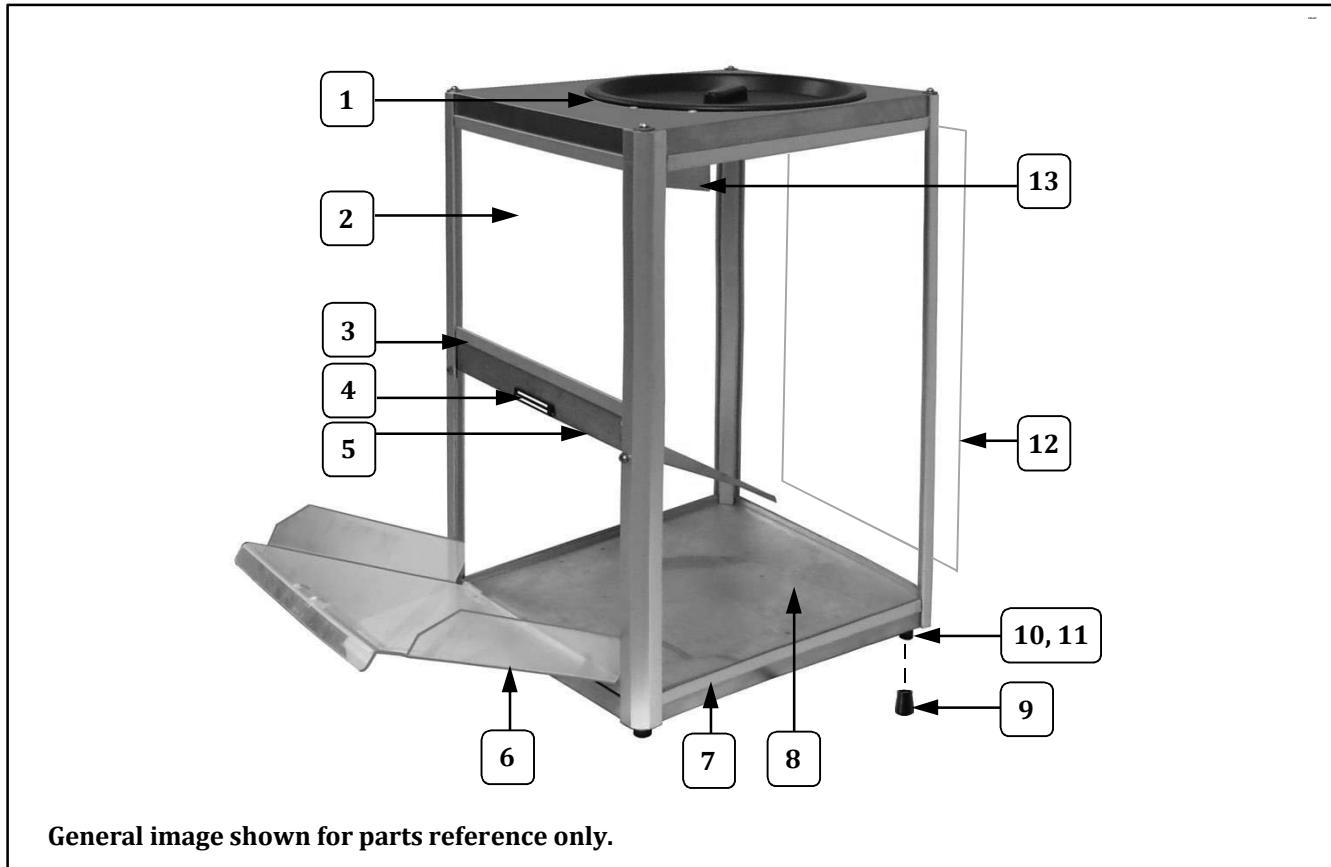

Item	Part Description	Part Number		
		2185ST	2187ST	2189
1	LID	100288	100288	100288
2	PLEXIGLASS PANEL (13 15/16 X 8 17/64)	40015	40015	
3	RETAINING EXTRUSION	40039	40039	49004
4	MAGNETIC CATCH	47561	47561	47561
5	BAFFLE	40009	40009	40065
6	DROP PANEL	40118	40118	40123
7	RETAINING EXTRUSION	40021	40021	40068
8	PLEXIGLAS PANEL	40014	40014	49019
9	CRUTCH TIP BLACK 70 DURO	49123	49123	49123
10	GLIDE	47328	47328	47328
11	SCREW, 10-24 X 3/4 HXHD	41314	41314	41314
12	PLEXIGLAS PANEL	40013	40013	49018
13	BULB PROTECTION L ANGLE	40050	40050	40050



Cabinet View

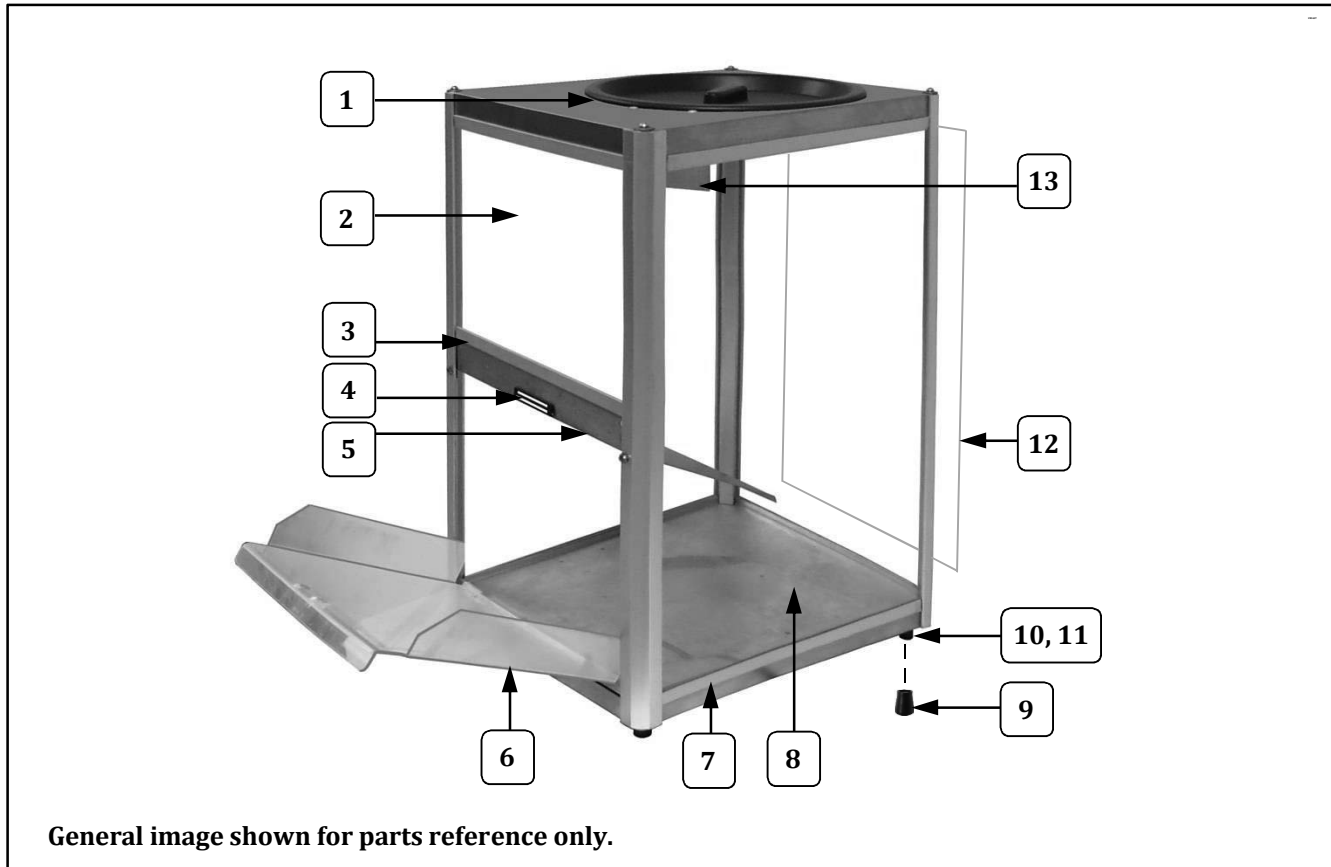

Item	Part Description	Part Number		
		2185ST	2187ST	2189
1	LID	100288	100288	100288
2	PLEXIGLASS PANEL (13 15/16 X 8 17/64)	40015	40015	
3	RETAINING EXTRUSION	40039	40039	49004
4	MAGNETIC CATCH	47561	47561	47561
5	BAFFLE	40009	40009	40065
6	DROP PANEL	40118	40118	40123
7	RETAINING EXTRUSION	40021	40021	40068
8	PLEXIGLAS PANEL	40014	40014	49019
9	CRUTCH TIP BLACK 70 DURO	49123	49123	49123
10	GLIDE	47328	47328	47328
11	SCREW, 10-24 X 3/4 HXHD	41314	41314	41314
12	PLEXIGLAS PANEL	40013	40013	49018
13	BULB PROTECTION L ANGLE	40050	40050	40050



Cabinet View

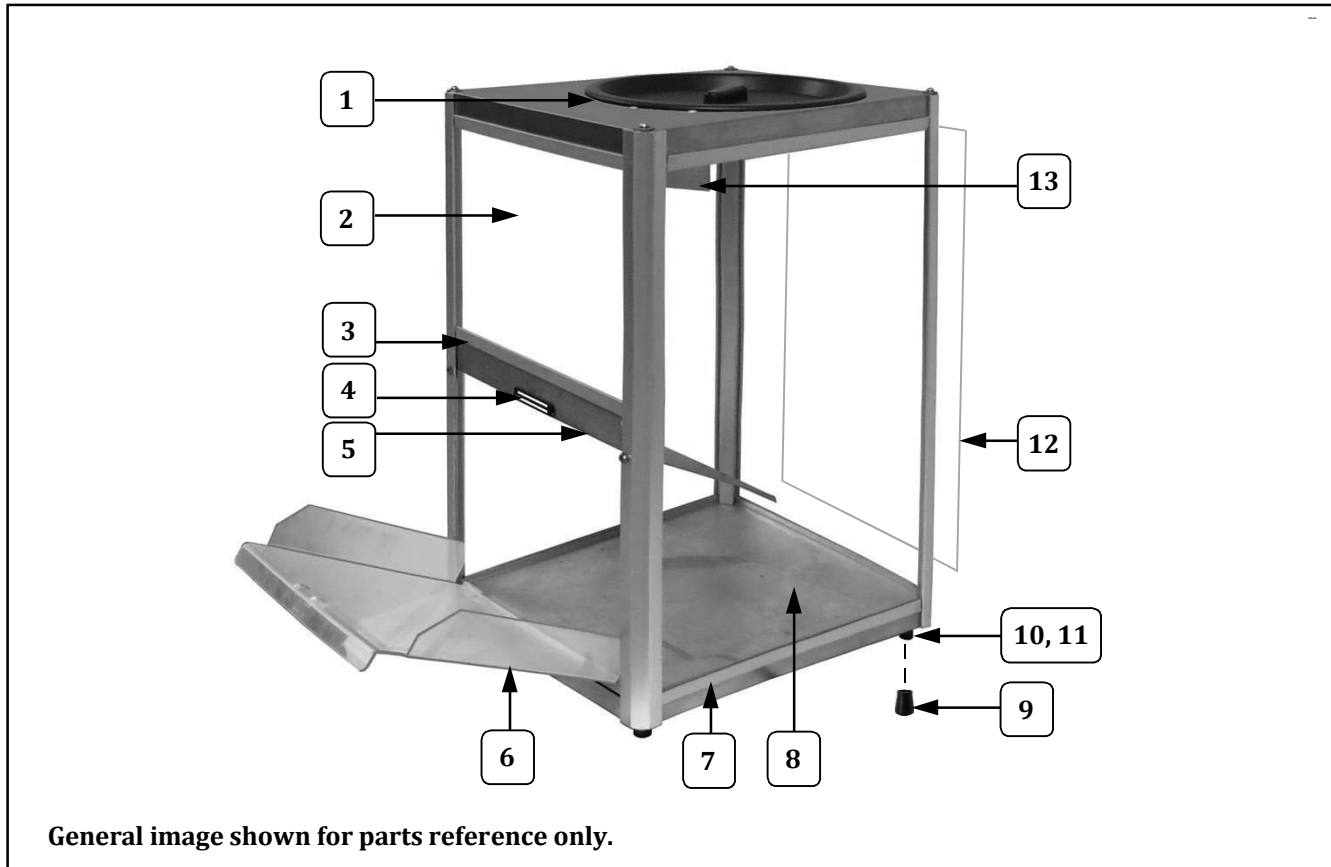

Item	Part Description	Part Number		
		2185ST	2187ST	2189
1	LID	100288	100288	100288
2	PLEXIGLASS PANEL (13 15/16 X 8 17/64)	40015	40015	
3	RETAINING EXTRUSION	40039	40039	49004
4	MAGNETIC CATCH	47561	47561	47561
5	BAFFLE	40009	40009	40065
6	DROP PANEL	40118	40118	40123
7	RETAINING EXTRUSION	40021	40021	40068
8	PLEXIGLAS PANEL	40014	40014	49019
9	CRUTCH TIP BLACK 70 DURO	49123	49123	49123
10	GLIDE	47328	47328	47328
11	SCREW, 10-24 X 3/4 HXHD	41314	41314	41314
12	PLEXIGLAS PANEL	40013	40013	49018
13	BULB PROTECTION L ANGLE	40050	40050	40050



Cabinet View

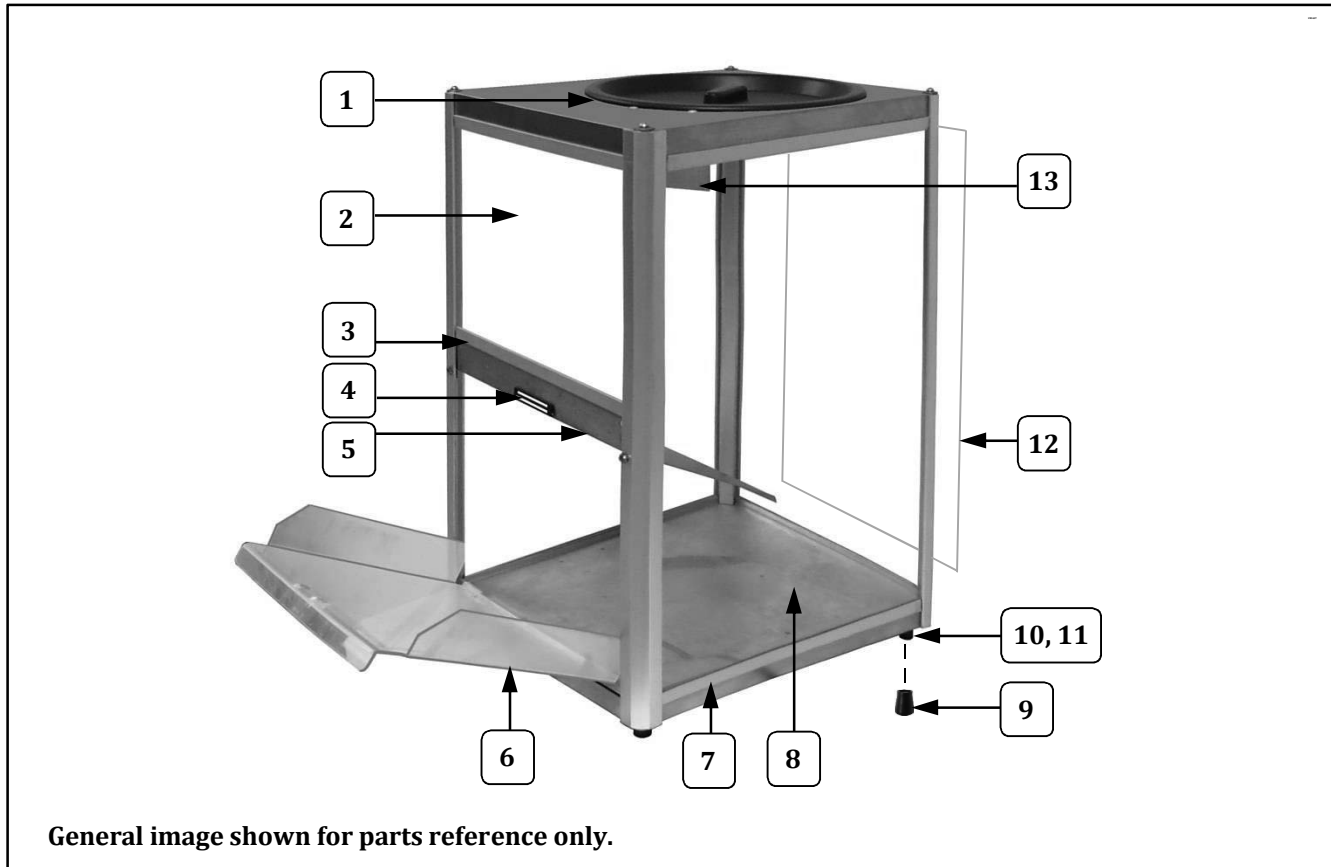

Item	Part Description	Part Number		
		2185ST	2187ST	2189
1	LID	100288	100288	100288
2	PLEXIGLASS PANEL (13 15/16 X 8 17/64)	40015	40015	
3	RETAINING EXTRUSION	40039	40039	49004
4	MAGNETIC CATCH	47561	47561	47561
5	BAFFLE	40009	40009	40065
6	DROP PANEL	40118	40118	40123
7	RETAINING EXTRUSION	40021	40021	40068
8	PLEXIGLAS PANEL	40014	40014	49019
9	CRUTCH TIP BLACK 70 DURO	49123	49123	49123
10	GLIDE	47328	47328	47328
11	SCREW, 10-24 X 3/4 HXHD	41314	41314	41314
12	PLEXIGLAS PANEL	40013	40013	49018
13	BULB PROTECTION L ANGLE	40050	40050	40050



Cabinet View

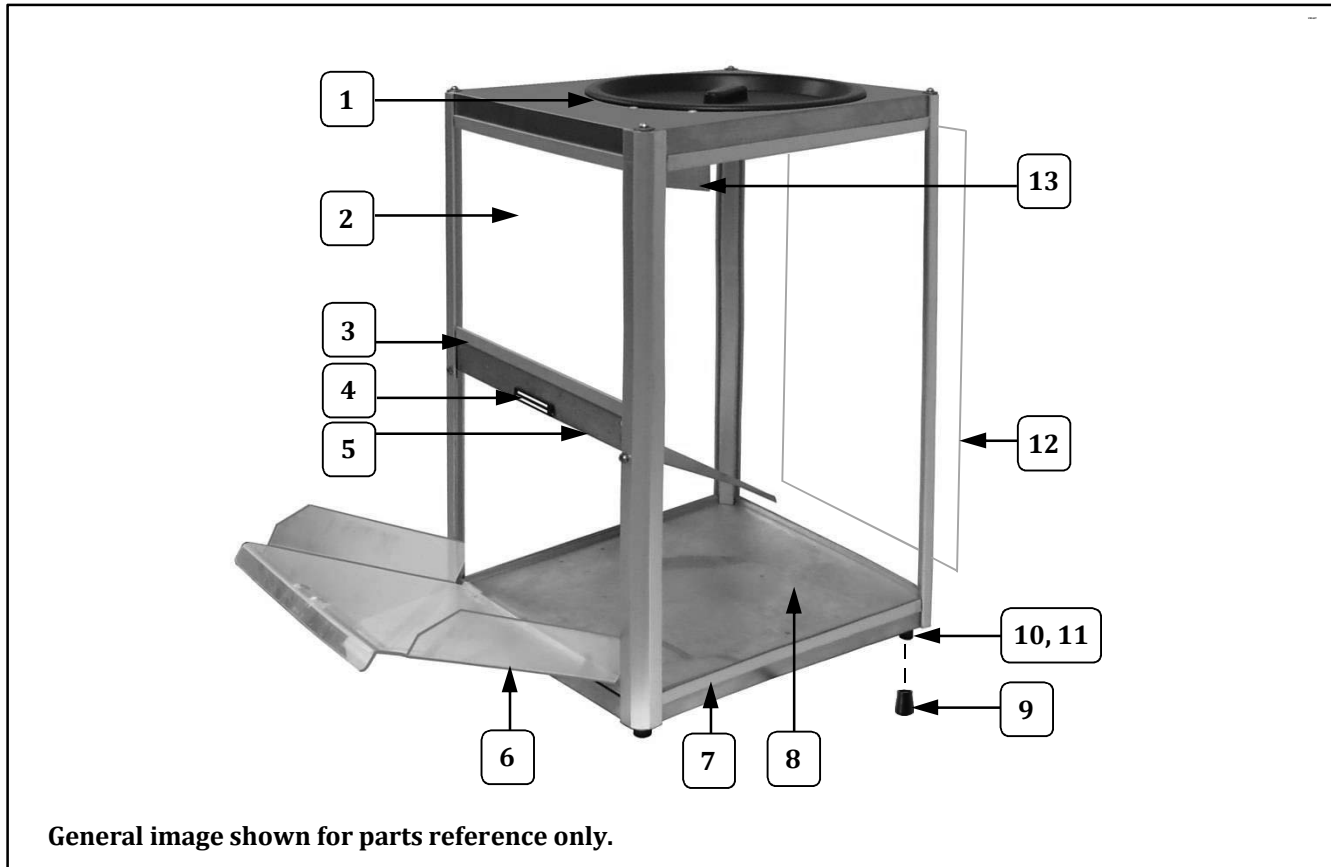

Item	Part Description	Part Number		
		2185ST	2187ST	2189
1	LID	100288	100288	100288
2	PLEXIGLASS PANEL (13 15/16 X 8 17/64)	40015	40015	
3	RETAINING EXTRUSION	40039	40039	49004
4	MAGNETIC CATCH	47561	47561	47561
5	BAFFLE	40009	40009	40065
6	DROP PANEL	40118	40118	40123
7	RETAINING EXTRUSION	40021	40021	40068
8	PLEXIGLAS PANEL	40014	40014	49019
9	CRUTCH TIP BLACK 70 DURO	49123	49123	49123
10	GLIDE	47328	47328	47328
11	SCREW, 10-24 X 3/4 HXHD	41314	41314	41314
12	PLEXIGLAS PANEL	40013	40013	49018
13	BULB PROTECTION L ANGLE	40050	40050	40050



Cabinet View

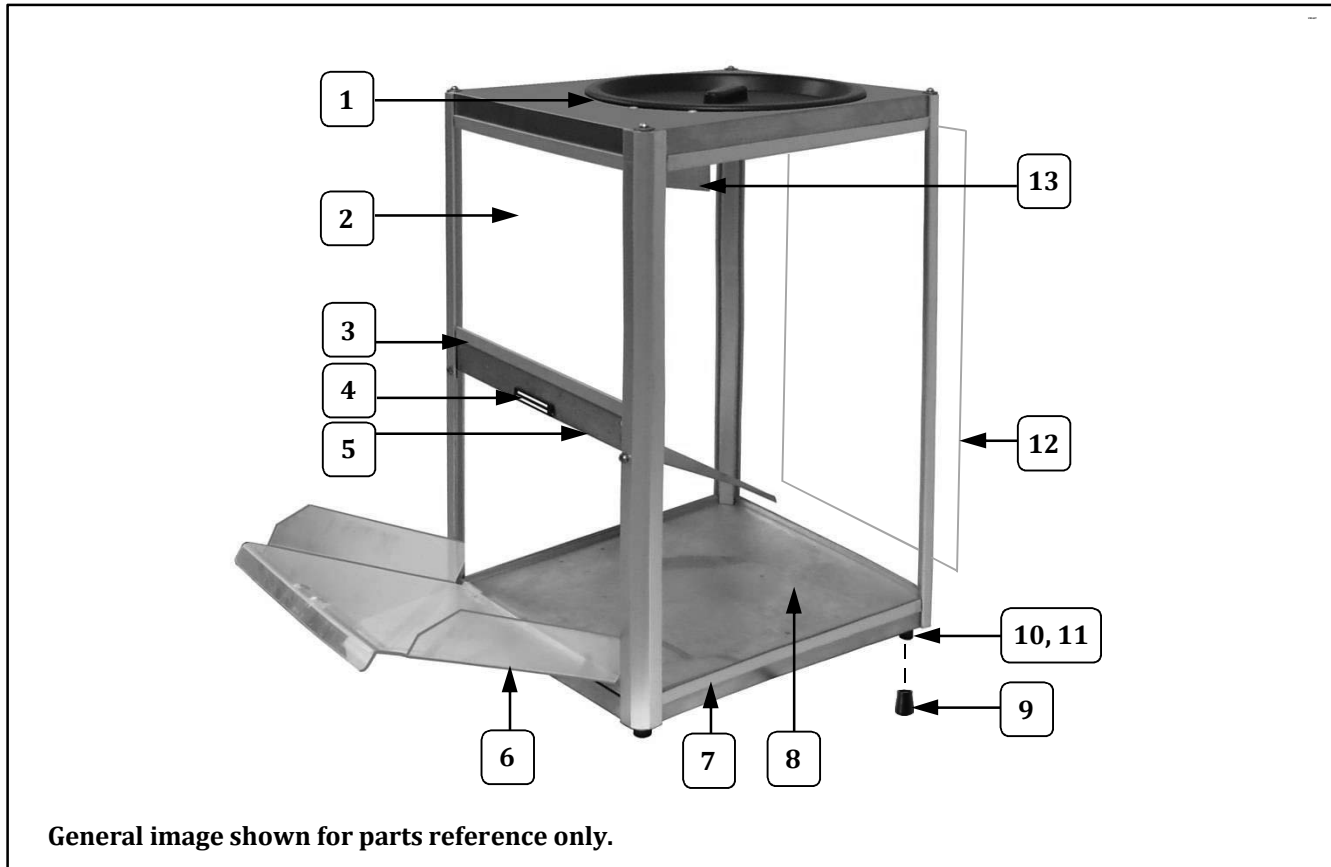

Item	Part Description	Part Number		
		2185ST	2187ST	2189
1	LID	100288	100288	100288
2	PLEXIGLASS PANEL (13 15/16 X 8 17/64)	40015	40015	
3	RETAINING EXTRUSION	40039	40039	49004
4	MAGNETIC CATCH	47561	47561	47561
5	BAFFLE	40009	40009	40065
6	DROP PANEL	40118	40118	40123
7	RETAINING EXTRUSION	40021	40021	40068
8	PLEXIGLAS PANEL	40014	40014	49019
9	CRUTCH TIP BLACK 70 DURO	49123	49123	49123
10	GLIDE	47328	47328	47328
11	SCREW, 10-24 X 3/4 HXHD	41314	41314	41314
12	PLEXIGLAS PANEL	40013	40013	49018
13	BULB PROTECTION L ANGLE	40050	40050	40050

Cabinet - Light and Warmer View

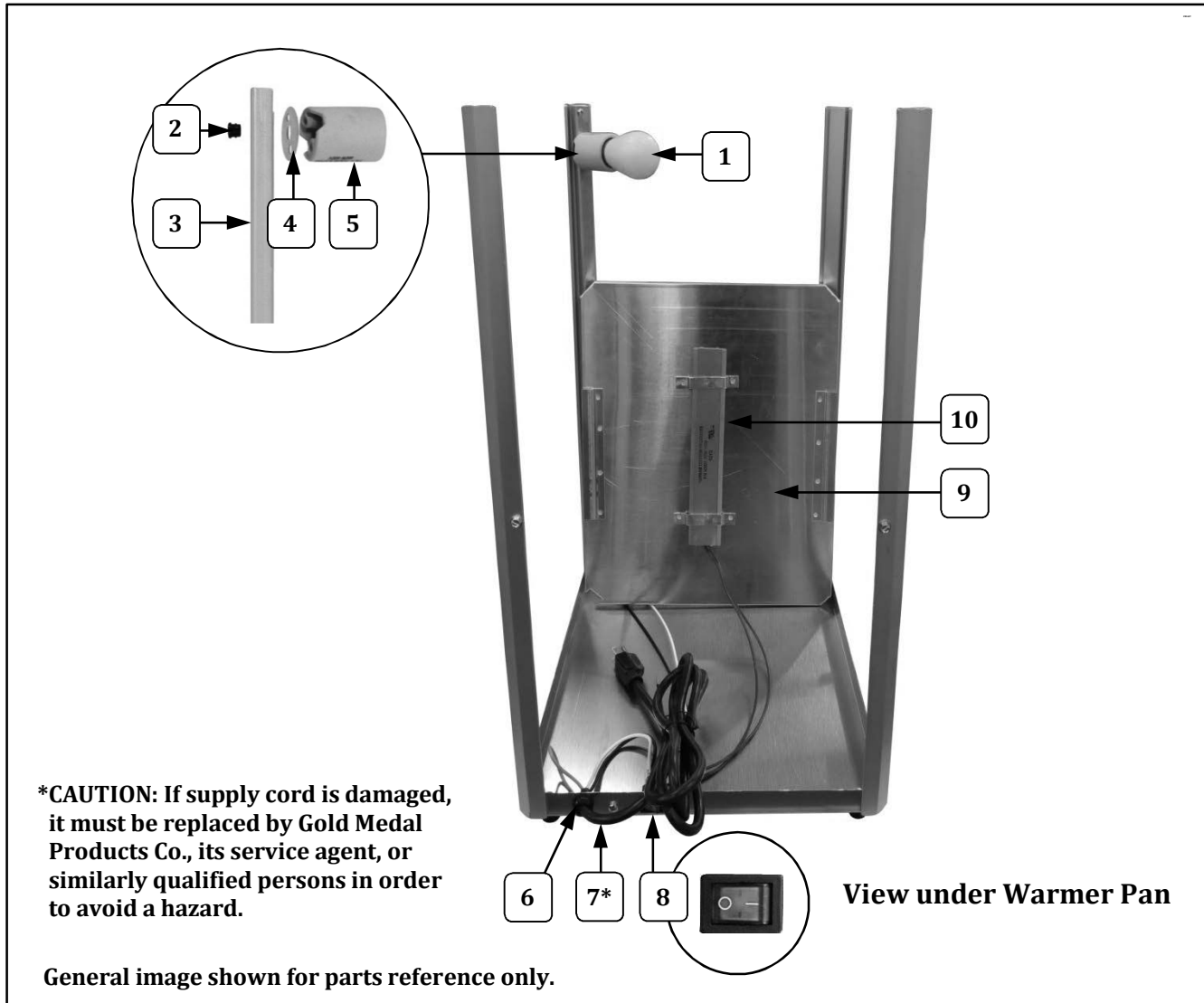

Item	Part Description	Part Number		
		2185ST	2187ST	2189
1	YELLOW LIGHT BULB (shatterproof bulb)	11035	11035	11035
2	.312" SNAP BUSHING	75328	75328	75328
3	LIGHT SUPPORT CHANEL	40011	40011	40064
4	LAMP HOLDER GASKET	40381	40381	40381
5	LAMP HOLDER	40141	40141	40141
6	#SR-6P3-4 STRAIN RELIEF	76026	76026	76026
7	LEAD-IN CORD 15 AMP PLUG	22038	22038	22038
8	DPST ROCKER SWITCH	42532	42532	42532
9	WARMER PAN ASSEMBLY	40117	40117	40124
10	120 VOLT 50 WATT HEAT ELEMENT	40031		40031
	115 VOLT 75 WATT HEAT ELEMENT		44026	

Cabinet - Light and Warmer View

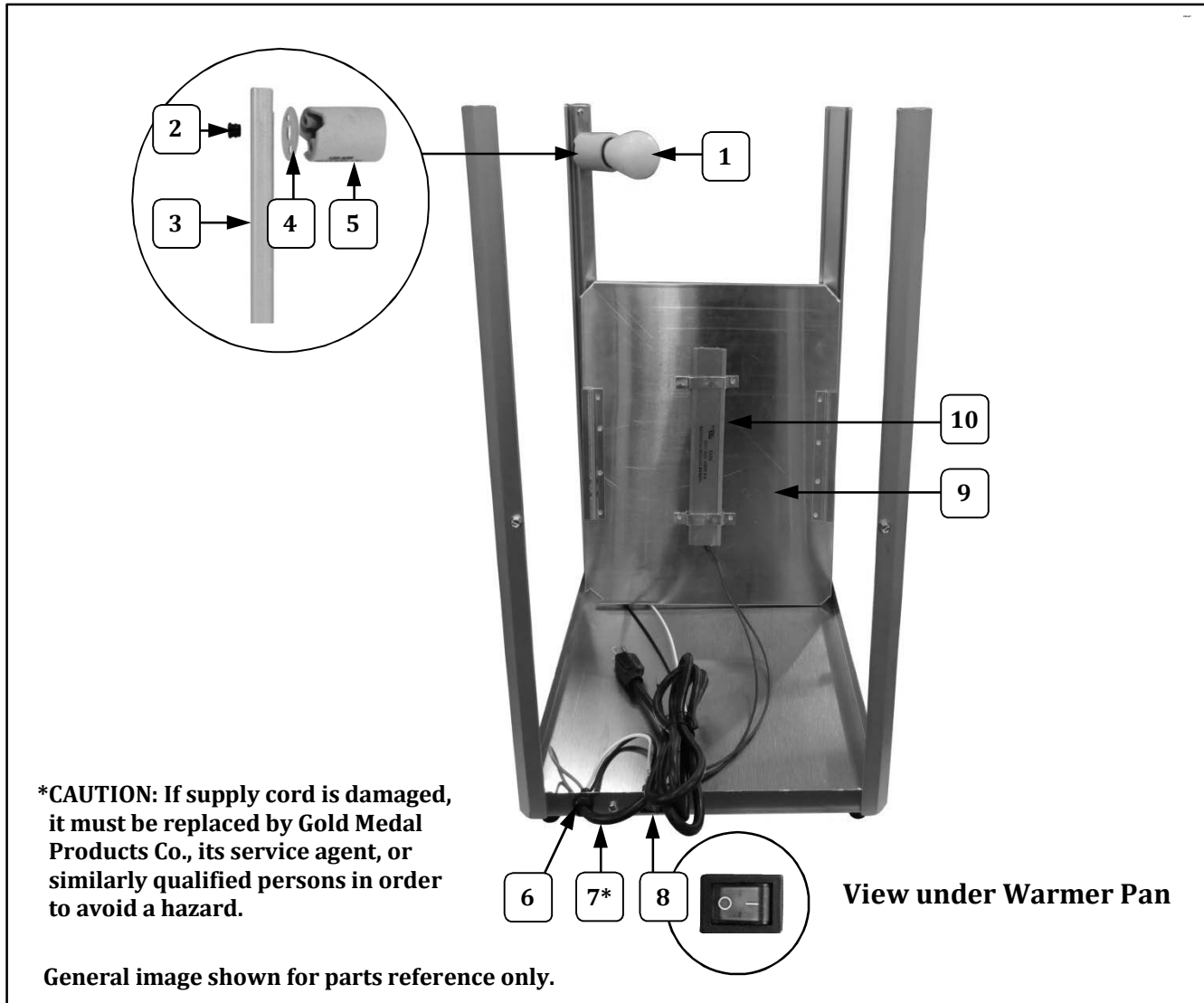

Item	Part Description	Part Number		
		2185ST	2187ST	2189
1	YELLOW LIGHT BULB (shatterproof bulb)	11035	11035	11035
2	.312" SNAP BUSHING	75328	75328	75328
3	LIGHT SUPPORT CHANNEL	40011	40011	40064
4	LAMP HOLDER GASKET	40381	40381	40381
5	LAMP HOLDER	40141	40141	40141
6	#SR-6P3-4 STRAIN RELIEF	76026	76026	76026
7	LEAD-IN CORD 15 AMP PLUG	22038	22038	22038
8	DPST ROCKER SWITCH	42532	42532	42532
9	WARMER PAN ASSEMBLY	40117	40117	40124
10	120 VOLT 50 WATT HEAT ELEMENT	40031		40031
	115 VOLT 75 WATT HEAT ELEMENT		44026	

Cabinet - Light and Warmer View

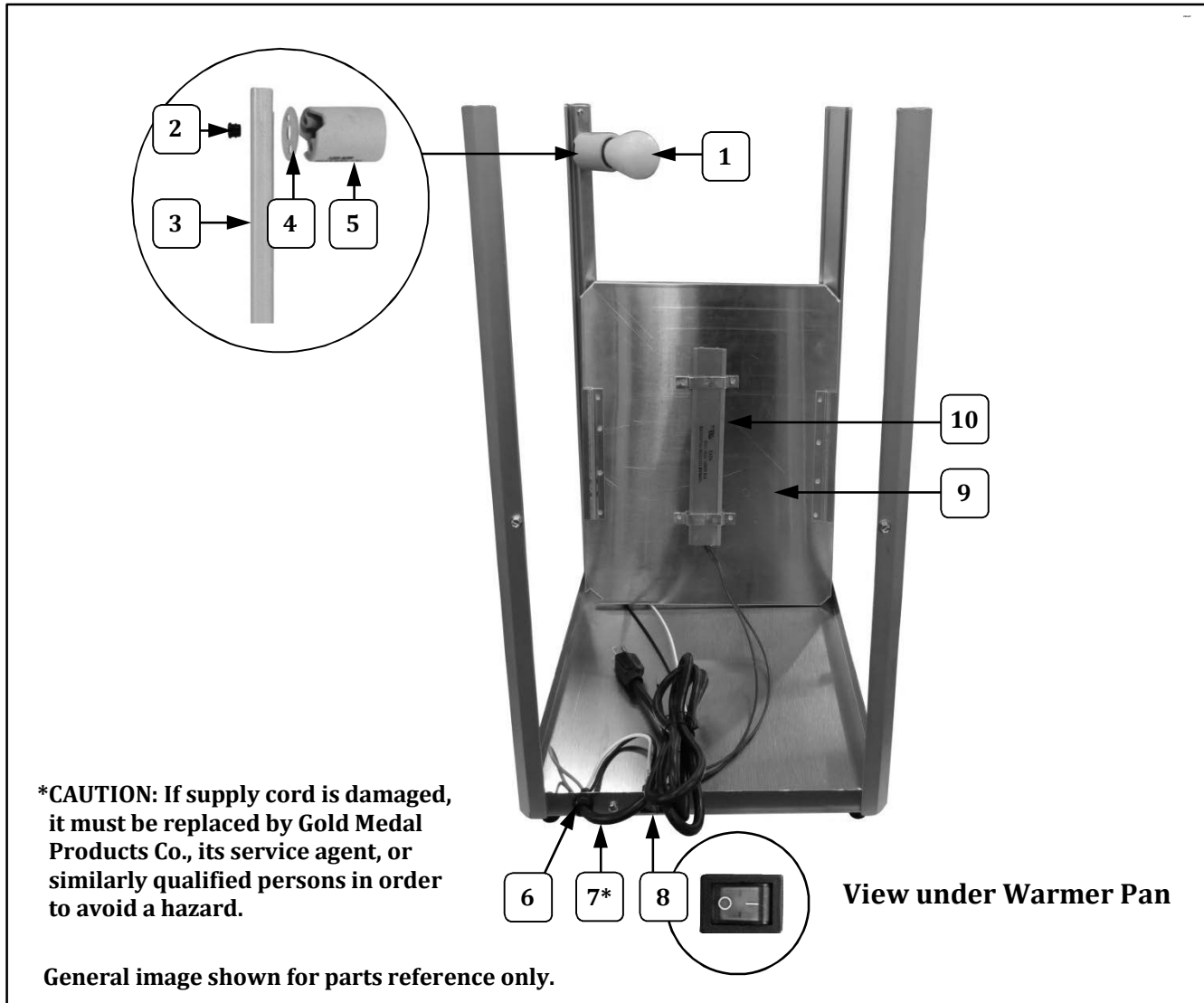

Item	Part Description	Part Number		
		2185ST	2187ST	2189
1	YELLOW LIGHT BULB (shatterproof bulb)	11035	11035	11035
2	.312" SNAP BUSHING	75328	75328	75328
3	LIGHT SUPPORT CHANNEL	40011	40011	40064
4	LAMP HOLDER GASKET	40381	40381	40381
5	LAMP HOLDER	40141	40141	40141
6	#SR-6P3-4 STRAIN RELIEF	76026	76026	76026
7	LEAD-IN CORD 15 AMP PLUG	22038	22038	22038
8	DPST ROCKER SWITCH	42532	42532	42532
9	WARMER PAN ASSEMBLY	40117	40117	40124
10	120 VOLT 50 WATT HEAT ELEMENT	40031		40031
	115 VOLT 75 WATT HEAT ELEMENT		44026	



Cabinet - Light and Warmer View

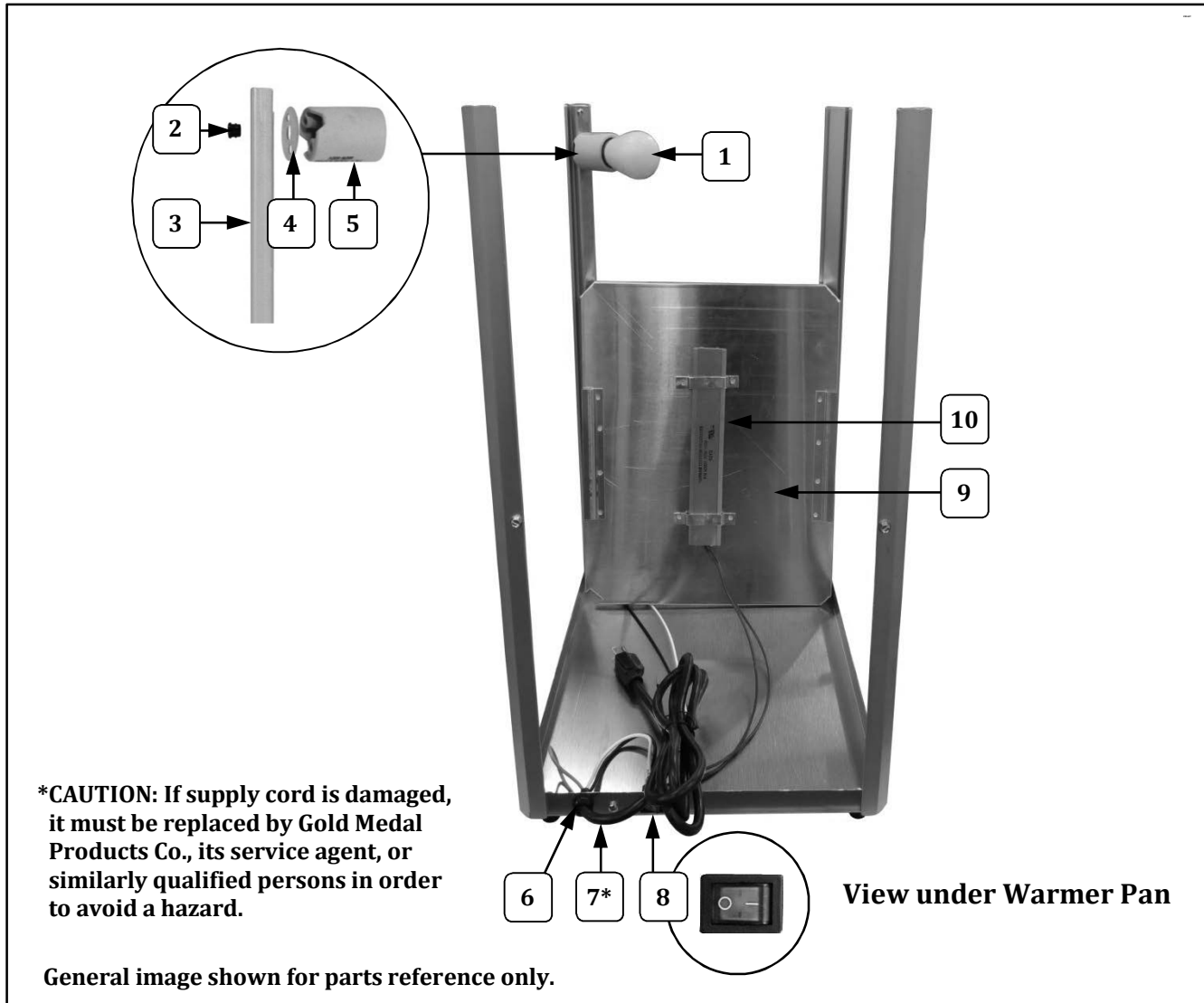

Item	Part Description	Part Number		
		2185ST	2187ST	2189
1	YELLOW LIGHT BULB (shatterproof bulb)	11035	11035	11035
2	.312" SNAP BUSHING	75328	75328	75328
3	LIGHT SUPPORT CHANEL	40011	40011	40064
4	LAMP HOLDER GASKET	40381	40381	40381
5	LAMP HOLDER	40141	40141	40141
6	#SR-6P3-4 STRAIN RELIEF	76026	76026	76026
7	LEAD-IN CORD 15 AMP PLUG	22038	22038	22038
8	DPST ROCKER SWITCH	42532	42532	42532
9	WARMER PAN ASSEMBLY	40117	40117	40124
10	120 VOLT 50 WATT HEAT ELEMENT	40031		40031
	115 VOLT 75 WATT HEAT ELEMENT		44026	

Cabinet - Light and Warmer View

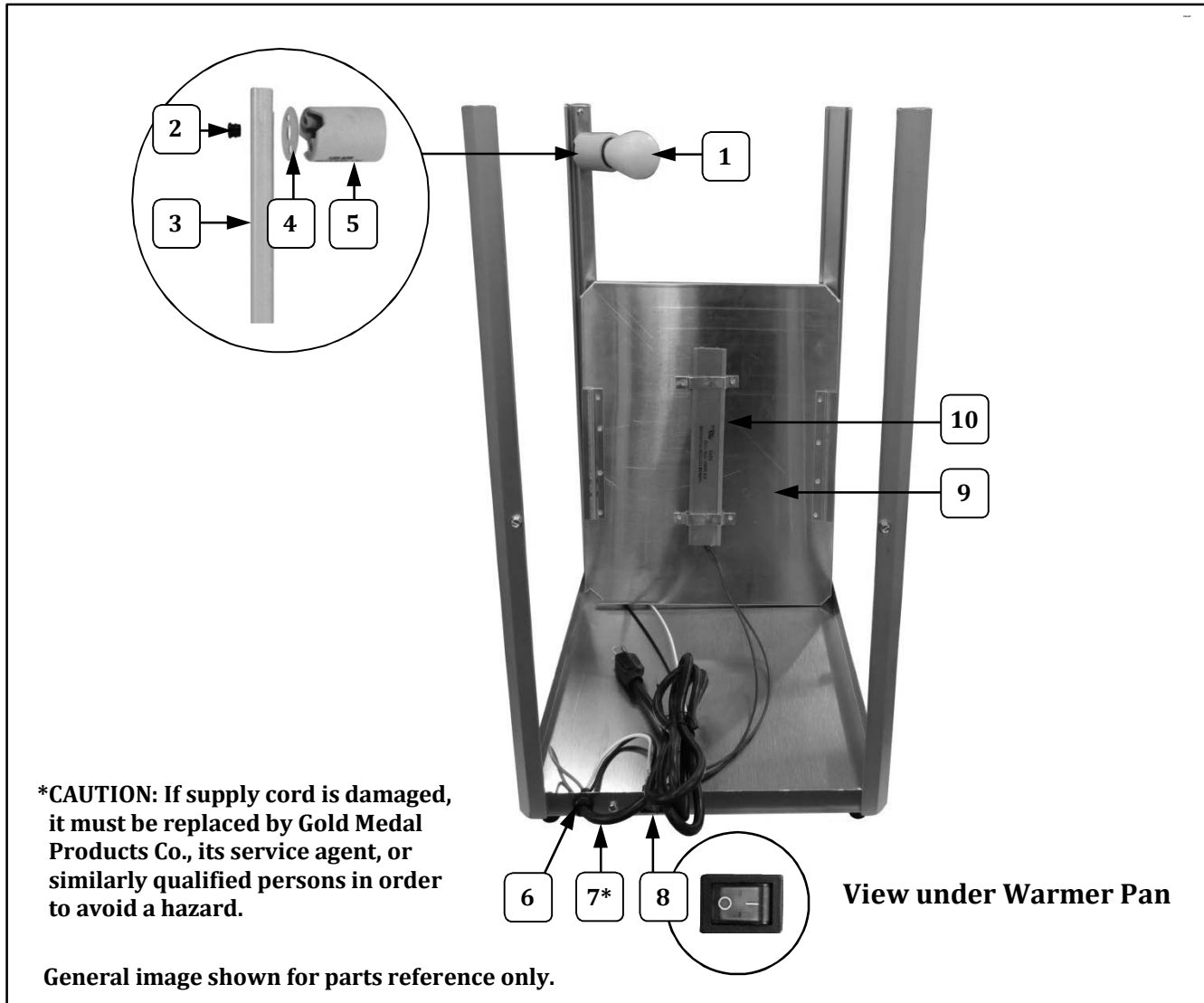

Item	Part Description	Part Number		
		2185ST	2187ST	2189
1	YELLOW LIGHT BULB (shatterproof bulb)	11035	11035	11035
2	.312" SNAP BUSHING	75328	75328	75328
3	LIGHT SUPPORT CHANEL	40011	40011	40064
4	LAMP HOLDER GASKET	40381	40381	40381
5	LAMP HOLDER	40141	40141	40141
6	#SR-6P3-4 STRAIN RELIEF	76026	76026	76026
7	LEAD-IN CORD 15 AMP PLUG	22038	22038	22038
8	DPST ROCKER SWITCH	42532	42532	42532
9	WARMER PAN ASSEMBLY	40117	40117	40124
10	120 VOLT 50 WATT HEAT ELEMENT	40031		40031
	115 VOLT 75 WATT HEAT ELEMENT		44026	

Cabinet - Light and Warmer View

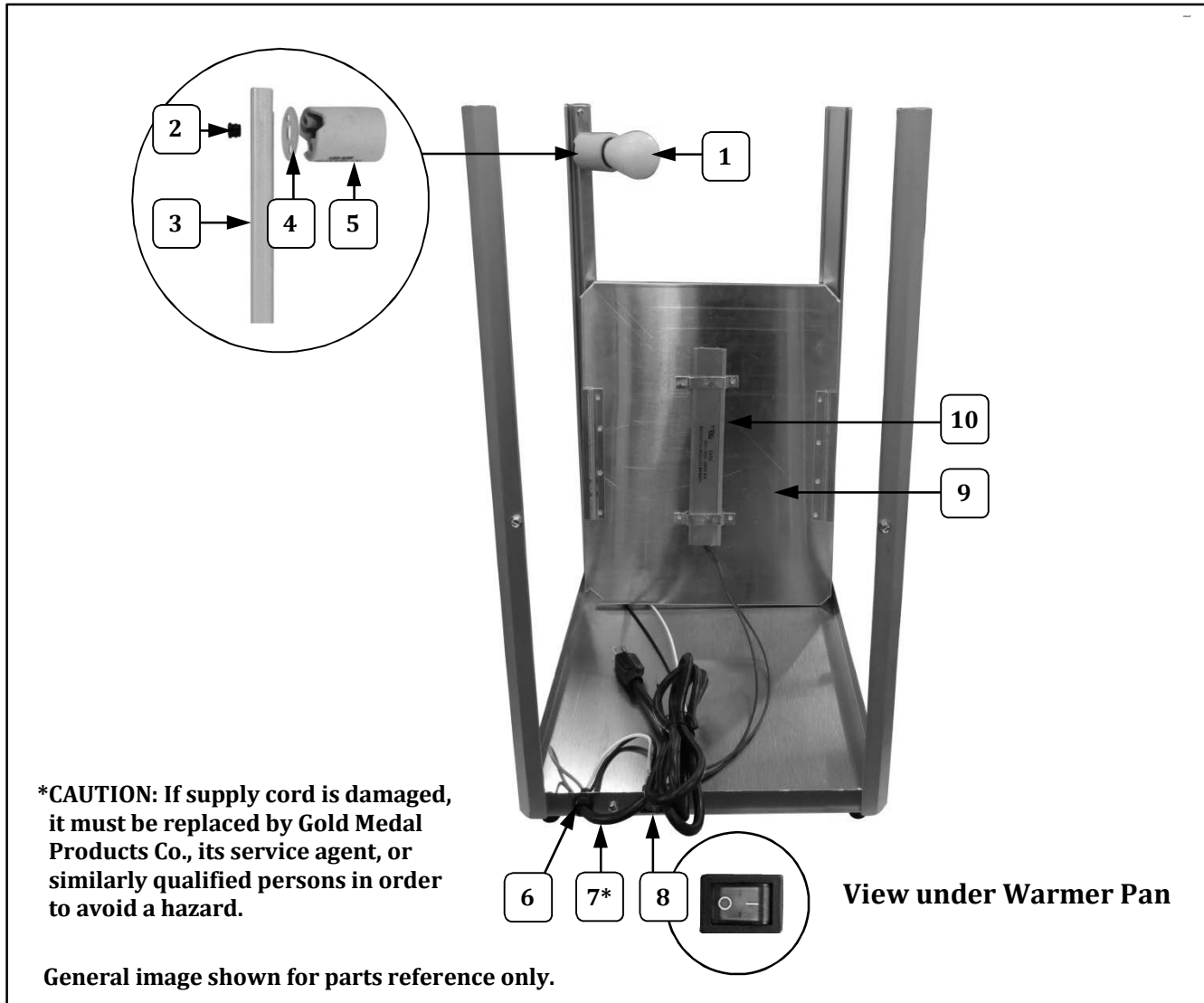

Item	Part Description	Part Number		
		2185ST	2187ST	2189
1	YELLOW LIGHT BULB (shatterproof bulb)	11035	11035	11035
2	.312" SNAP BUSHING	75328	75328	75328
3	LIGHT SUPPORT CHANNEL	40011	40011	40064
4	LAMP HOLDER GASKET	40381	40381	40381
5	LAMP HOLDER	40141	40141	40141
6	#SR-6P3-4 STRAIN RELIEF	76026	76026	76026
7	LEAD-IN CORD 15 AMP PLUG	22038	22038	22038
8	DPST ROCKER SWITCH	42532	42532	42532
9	WARMER PAN ASSEMBLY	40117	40117	40124
10	120 VOLT 50 WATT HEAT ELEMENT	40031		40031
	115 VOLT 75 WATT HEAT ELEMENT		44026	

Cabinet - Light and Warmer View

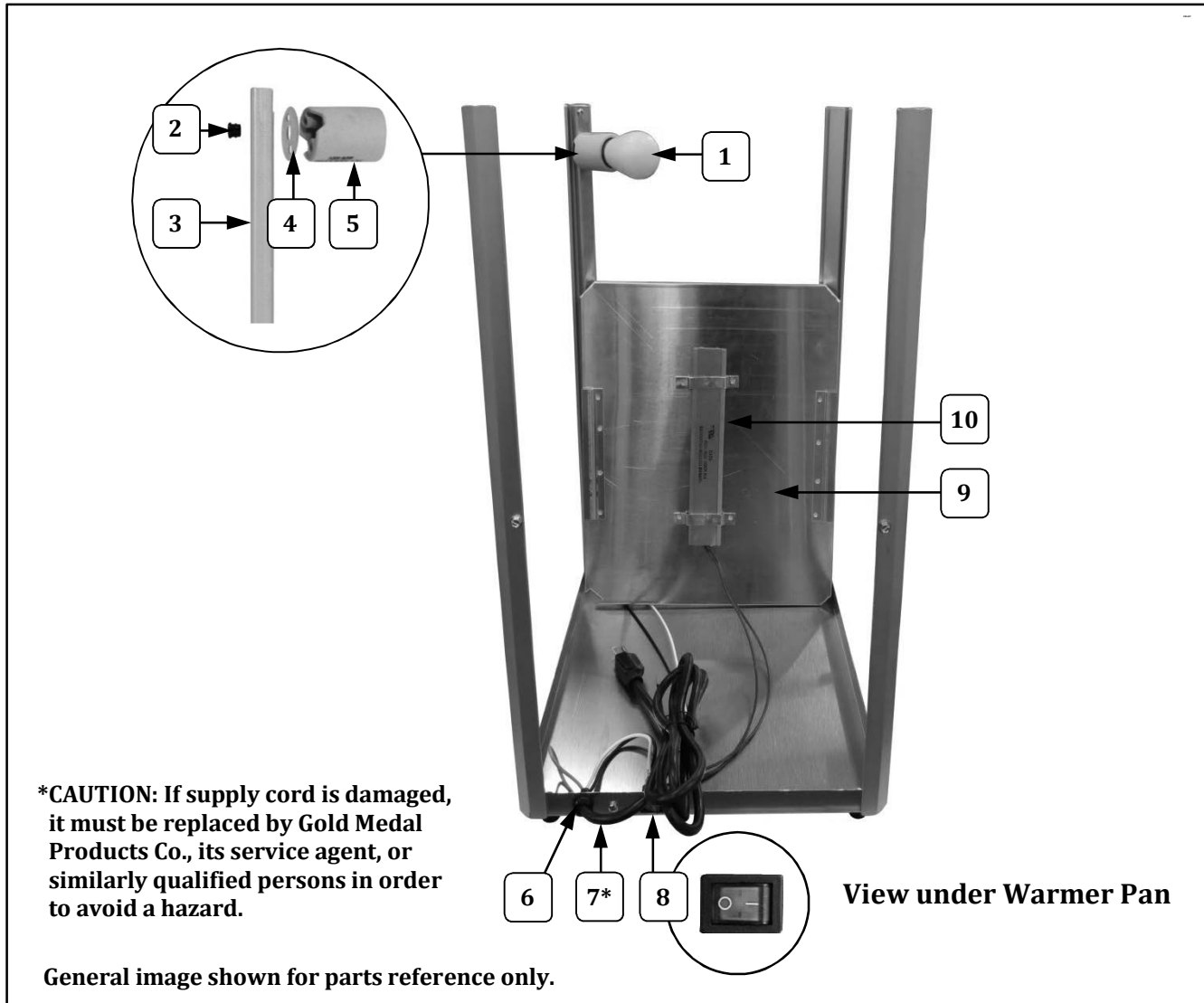

Item	Part Description	Part Number		
		2185ST	2187ST	2189
1	YELLOW LIGHT BULB (shatterproof bulb)	11035	11035	11035
2	.312" SNAP BUSHING	75328	75328	75328
3	LIGHT SUPPORT CHANNEL	40011	40011	40064
4	LAMP HOLDER GASKET	40381	40381	40381
5	LAMP HOLDER	40141	40141	40141
6	#SR-6P3-4 STRAIN RELIEF	76026	76026	76026
7	LEAD-IN CORD 15 AMP PLUG	22038	22038	22038
8	DPST ROCKER SWITCH	42532	42532	42532
9	WARMER PAN ASSEMBLY	40117	40117	40124
10	120 VOLT 50 WATT HEAT ELEMENT	40031		40031
	115 VOLT 75 WATT HEAT ELEMENT		44026	

Cabinet - Light and Warmer View

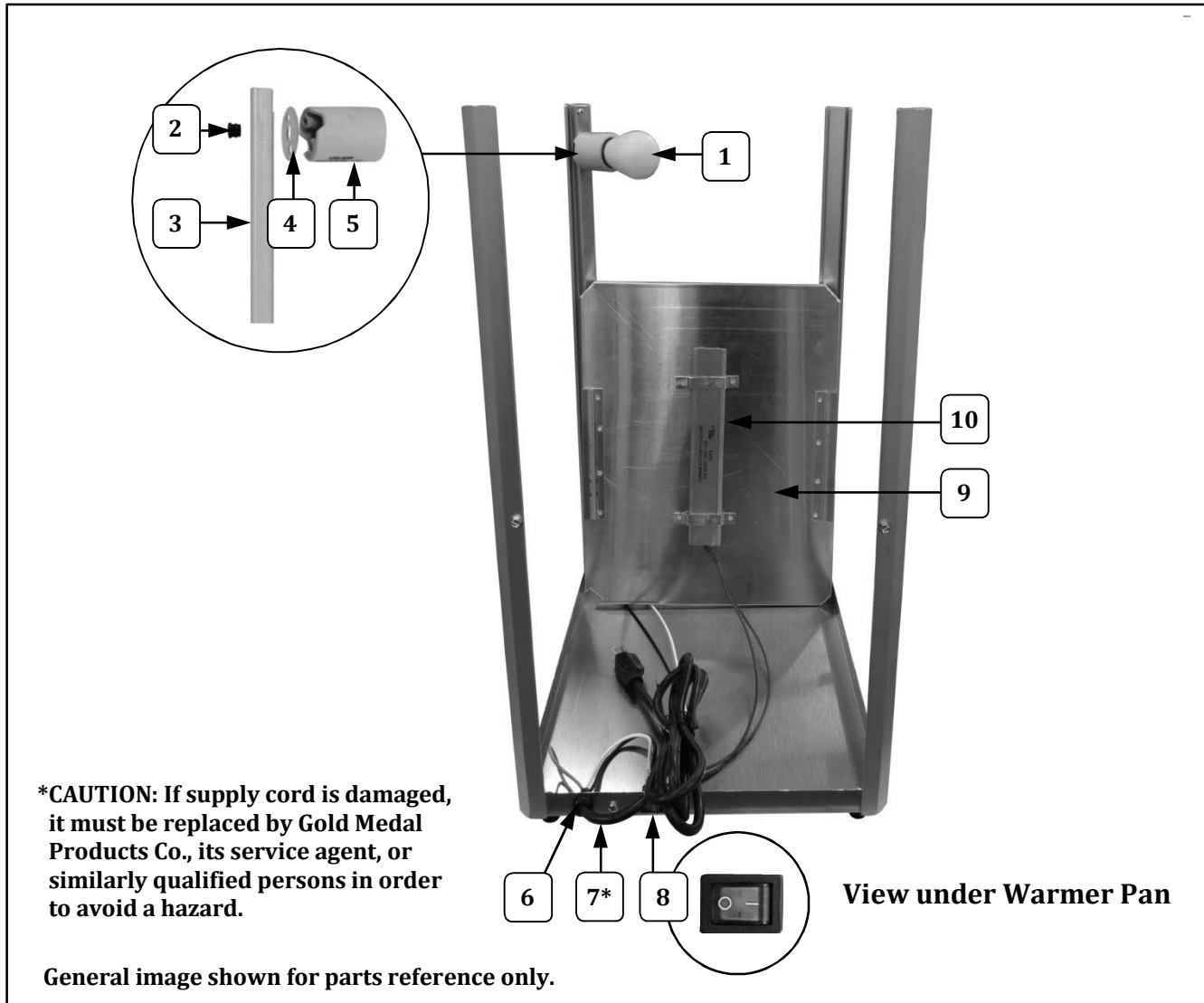

Item	Part Description	Part Number		
		2185ST	2187ST	2189
1	YELLOW LIGHT BULB (shatterproof bulb)	11035	11035	11035
2	.312" SNAP BUSHING	75328	75328	75328
3	LIGHT SUPPORT CHANEL	40011	40011	40064
4	LAMP HOLDER GASKET	40381	40381	40381
5	LAMP HOLDER	40141	40141	40141
6	#SR-6P3-4 STRAIN RELIEF	76026	76026	76026
7	LEAD-IN CORD 15 AMP PLUG	22038	22038	22038
8	DPST ROCKER SWITCH	42532	42532	42532
9	WARMER PAN ASSEMBLY	40117	40117	40124
10	120 VOLT 50 WATT HEAT ELEMENT	40031		40031
	115 VOLT 75 WATT HEAT ELEMENT		44026	

Cabinet - Light and Warmer View

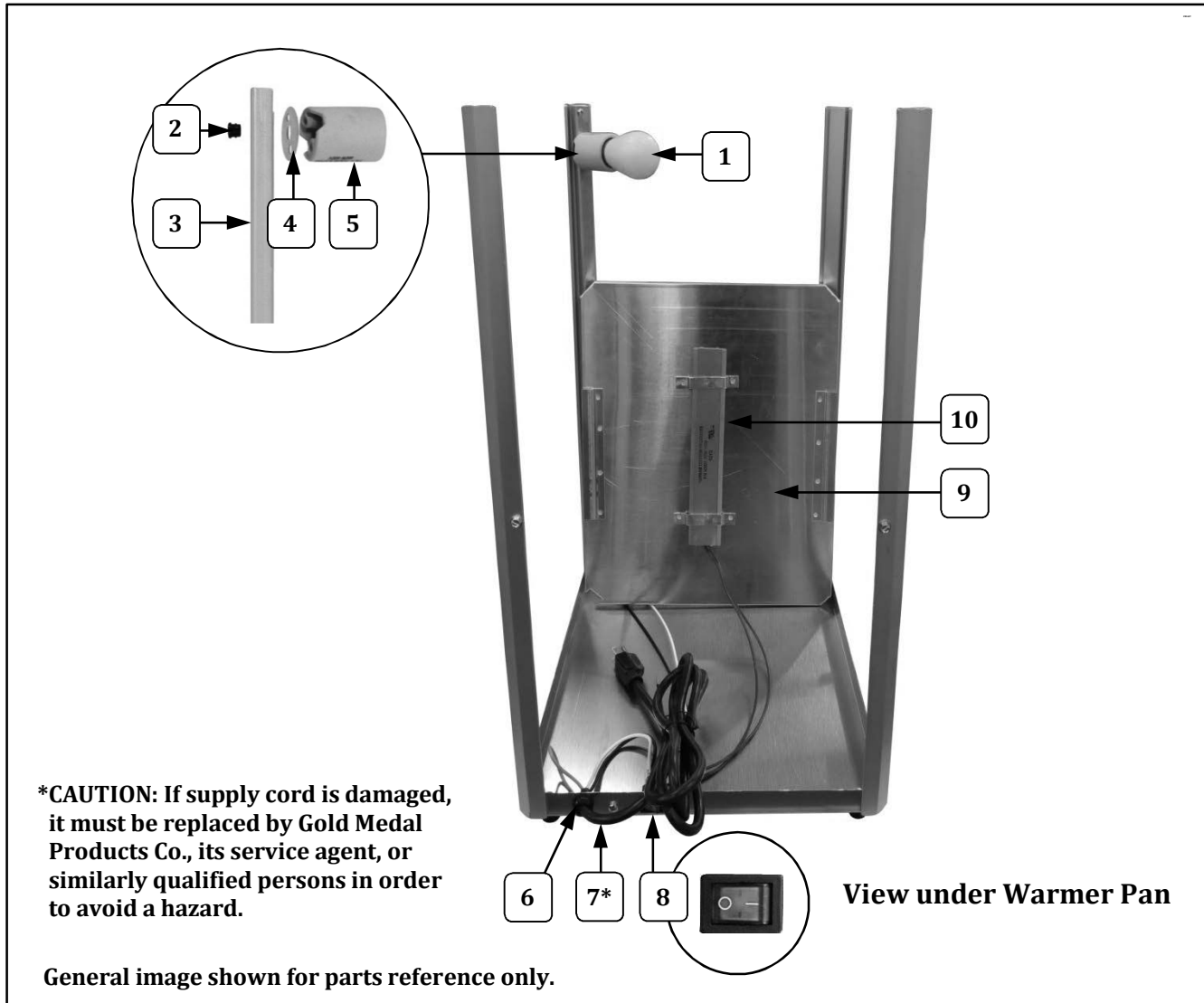

Item	Part Description	Part Number		
		2185ST	2187ST	2189
1	YELLOW LIGHT BULB (shatterproof bulb)	11035	11035	11035
2	.312" SNAP BUSHING	75328	75328	75328
3	LIGHT SUPPORT CHANEL	40011	40011	40064
4	LAMP HOLDER GASKET	40381	40381	40381
5	LAMP HOLDER	40141	40141	40141
6	#SR-6P3-4 STRAIN RELIEF	76026	76026	76026
7	LEAD-IN CORD 15 AMP PLUG	22038	22038	22038
8	DPST ROCKER SWITCH	42532	42532	42532
9	WARMER PAN ASSEMBLY	40117	40117	40124
10	120 VOLT 50 WATT HEAT ELEMENT	40031		40031
	115 VOLT 75 WATT HEAT ELEMENT		44026	

Cabinet - Light and Warmer View

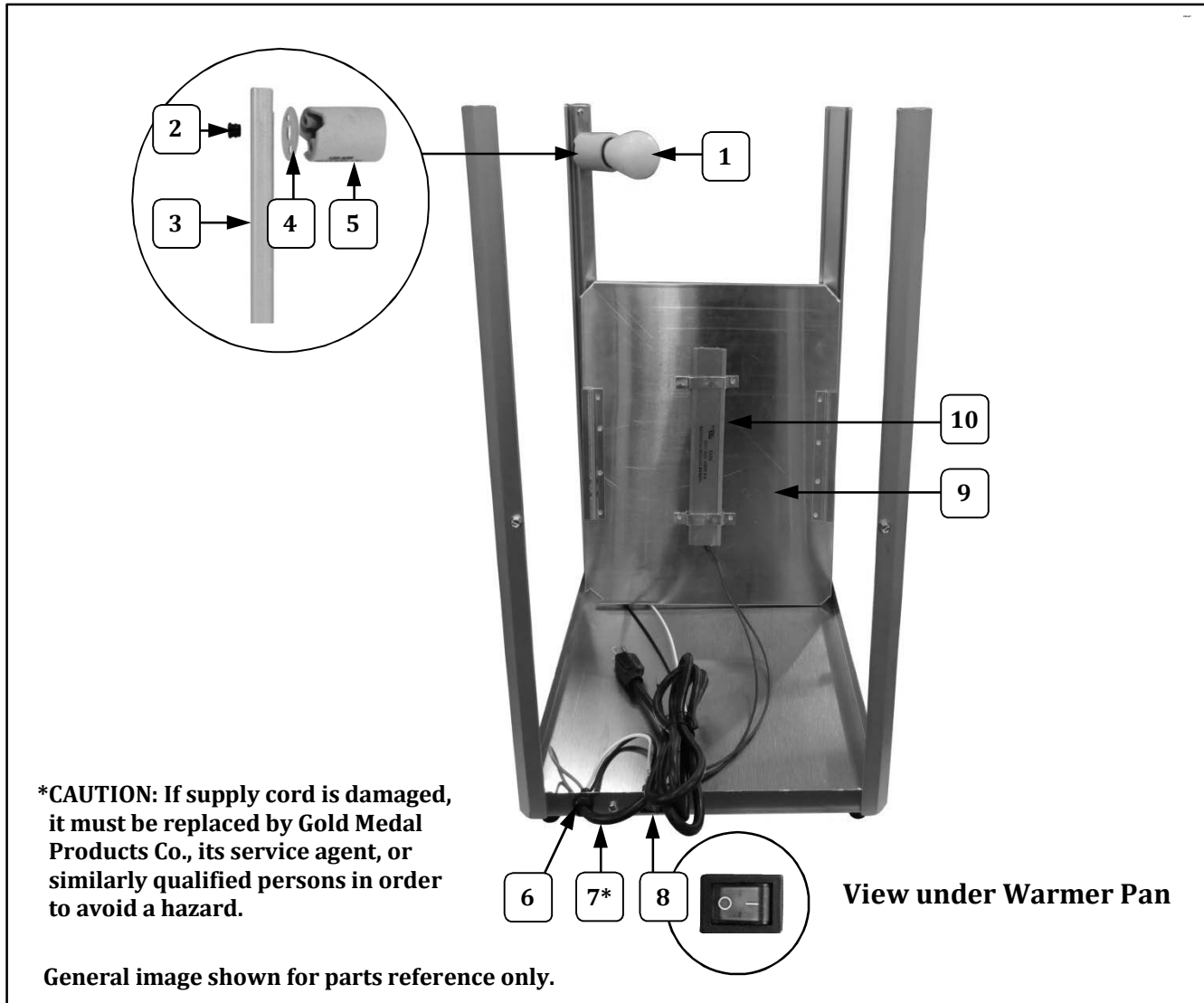

Item	Part Description	Part Number		
		2185ST	2187ST	2189
1	YELLOW LIGHT BULB (shatterproof bulb)	11035	11035	11035
2	.312" SNAP BUSHING	75328	75328	75328
3	LIGHT SUPPORT CHANEL	40011	40011	40064
4	LAMP HOLDER GASKET	40381	40381	40381
5	LAMP HOLDER	40141	40141	40141
6	#SR-6P3-4 STRAIN RELIEF	76026	76026	76026
7	LEAD-IN CORD 15 AMP PLUG	22038	22038	22038
8	DPST ROCKER SWITCH	42532	42532	42532
9	WARMER PAN ASSEMBLY	40117	40117	40124
10	120 VOLT 50 WATT HEAT ELEMENT	40031		40031
	115 VOLT 75 WATT HEAT ELEMENT		44026	

Cabinet - Light and Warmer View

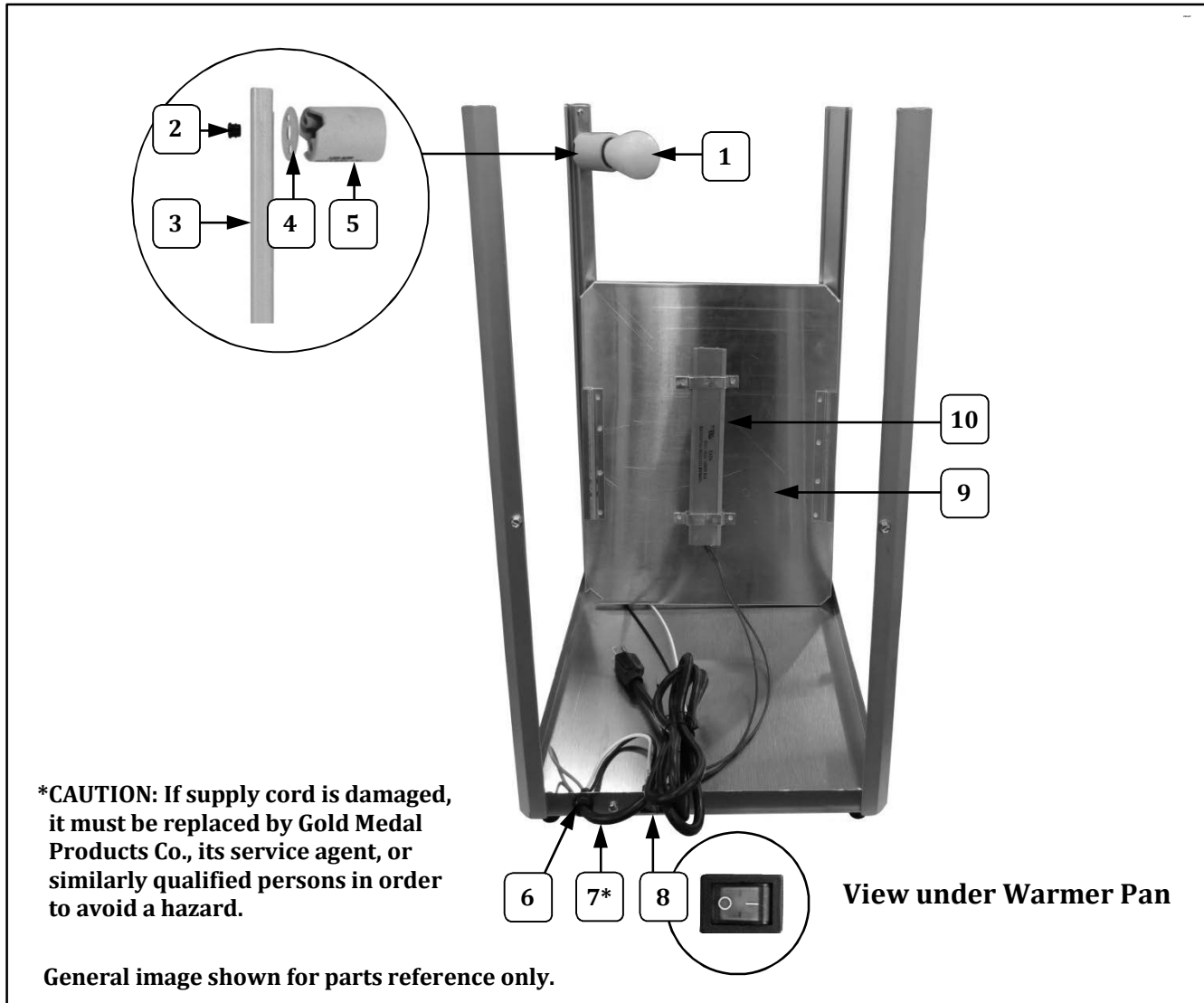

Item	Part Description	Part Number		
		2185ST	2187ST	2189
1	YELLOW LIGHT BULB (shatterproof bulb)	11035	11035	11035
2	.312" SNAP BUSHING	75328	75328	75328
3	LIGHT SUPPORT CHANEL	40011	40011	40064
4	LAMP HOLDER GASKET	40381	40381	40381
5	LAMP HOLDER	40141	40141	40141
6	#SR-6P3-4 STRAIN RELIEF	76026	76026	76026
7	LEAD-IN CORD 15 AMP PLUG	22038	22038	22038
8	DPST ROCKER SWITCH	42532	42532	42532
9	WARMER PAN ASSEMBLY	40117	40117	40124
10	120 VOLT 50 WATT HEAT ELEMENT	40031		40031
	115 VOLT 75 WATT HEAT ELEMENT		44026	

Cabinet - Light and Warmer View

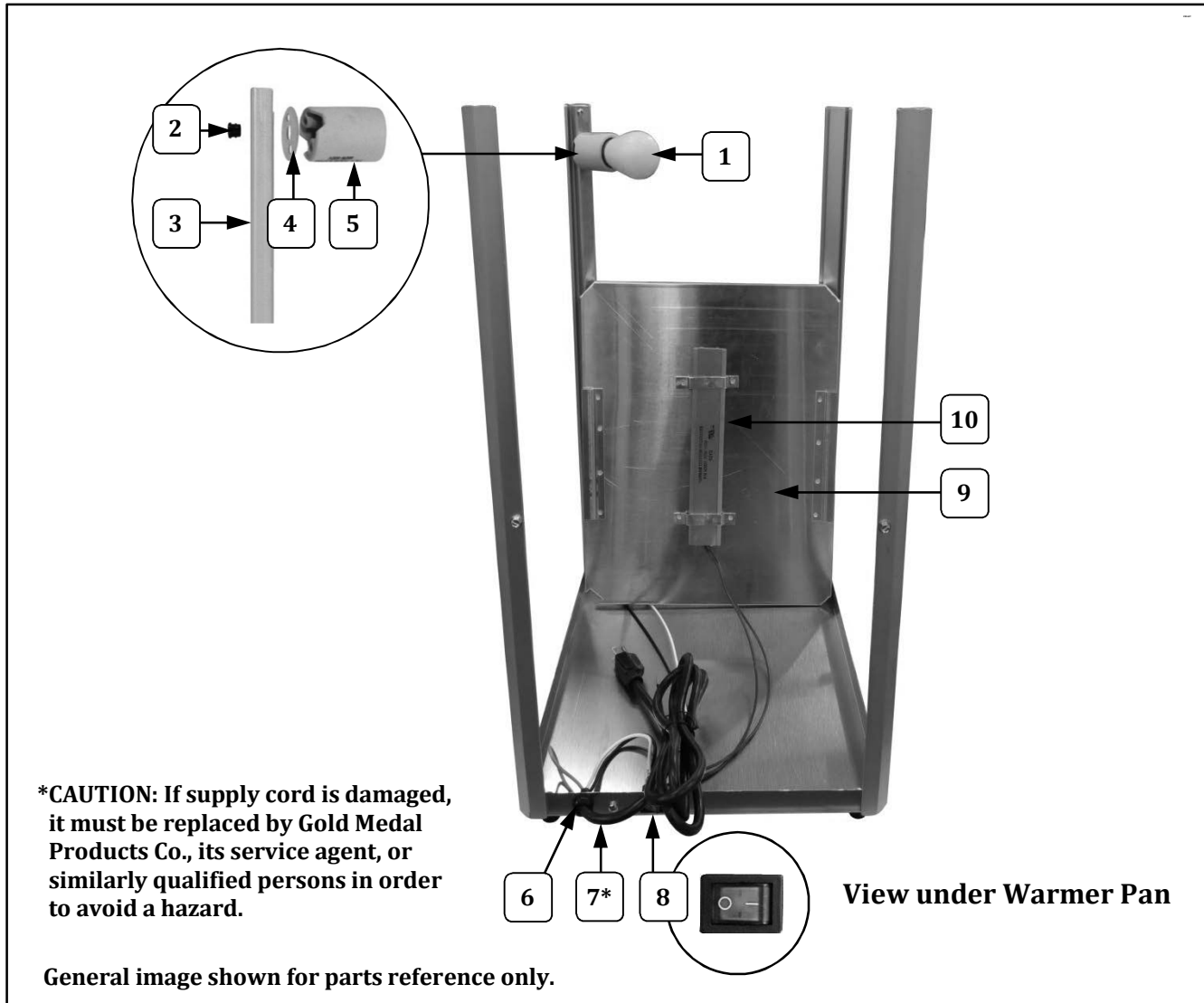

Item	Part Description	Part Number		
		2185ST	2187ST	2189
1	YELLOW LIGHT BULB (shatterproof bulb)	11035	11035	11035
2	.312" SNAP BUSHING	75328	75328	75328
3	LIGHT SUPPORT CHANNEL	40011	40011	40064
4	LAMP HOLDER GASKET	40381	40381	40381
5	LAMP HOLDER	40141	40141	40141
6	#SR-6P3-4 STRAIN RELIEF	76026	76026	76026
7	LEAD-IN CORD 15 AMP PLUG	22038	22038	22038
8	DPST ROCKER SWITCH	42532	42532	42532
9	WARMER PAN ASSEMBLY	40117	40117	40124
10	120 VOLT 50 WATT HEAT ELEMENT	40031		40031
	115 VOLT 75 WATT HEAT ELEMENT		44026	

Cabinet - Light and Warmer View

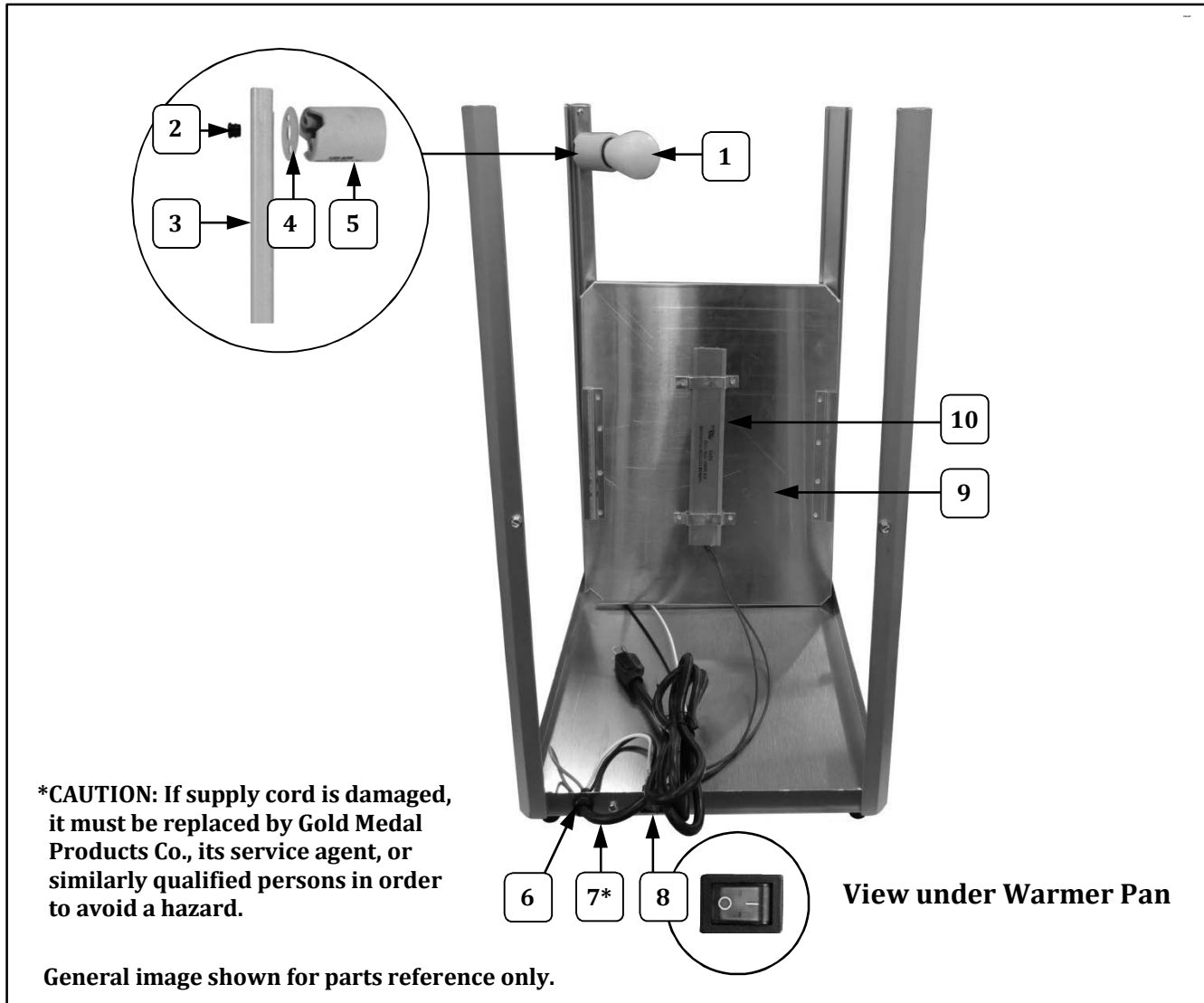

Item	Part Description	Part Number		
		2185ST	2187ST	2189
1	YELLOW LIGHT BULB (shatterproof bulb)	11035	11035	11035
2	.312" SNAP BUSHING	75328	75328	75328
3	LIGHT SUPPORT CHANNEL	40011	40011	40064
4	LAMP HOLDER GASKET	40381	40381	40381
5	LAMP HOLDER	40141	40141	40141
6	#SR-6P3-4 STRAIN RELIEF	76026	76026	76026
7	LEAD-IN CORD 15 AMP PLUG	22038	22038	22038
8	DPST ROCKER SWITCH	42532	42532	42532
9	WARMER PAN ASSEMBLY	40117	40117	40124
10	120 VOLT 50 WATT HEAT ELEMENT	40031		40031
	115 VOLT 75 WATT HEAT ELEMENT		44026	

Cabinet - Light and Warmer View

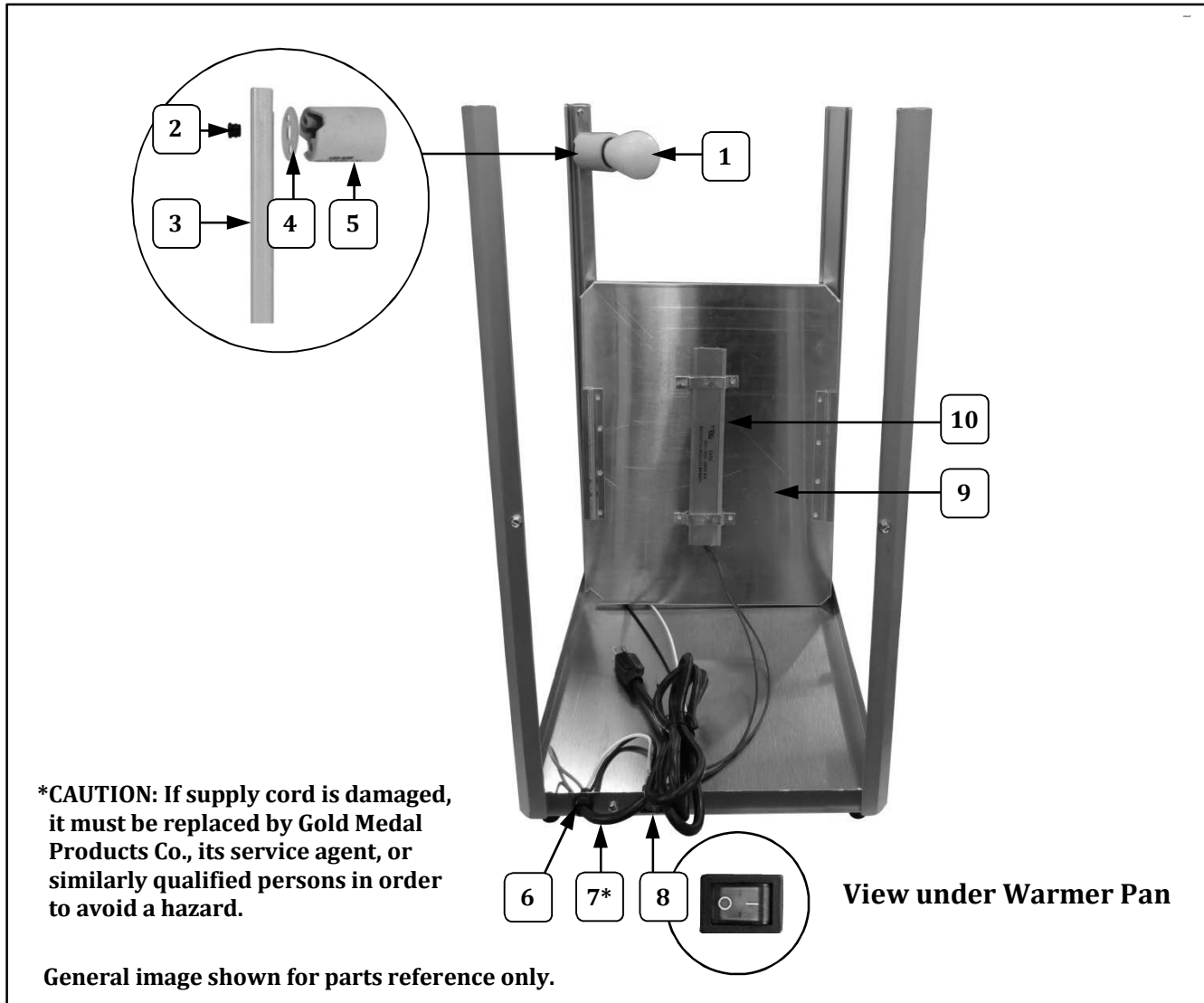

Item	Part Description	Part Number		
		2185ST	2187ST	2189
1	YELLOW LIGHT BULB (shatterproof bulb)	11035	11035	11035
2	.312" SNAP BUSHING	75328	75328	75328
3	LIGHT SUPPORT CHANEL	40011	40011	40064
4	LAMP HOLDER GASKET	40381	40381	40381
5	LAMP HOLDER	40141	40141	40141
6	#SR-6P3-4 STRAIN RELIEF	76026	76026	76026
7	LEAD-IN CORD 15 AMP PLUG	22038	22038	22038
8	DPST ROCKER SWITCH	42532	42532	42532
9	WARMER PAN ASSEMBLY	40117	40117	40124
10	120 VOLT 50 WATT HEAT ELEMENT	40031		40031
	115 VOLT 75 WATT HEAT ELEMENT		44026	

Cabinet - Light and Warmer View

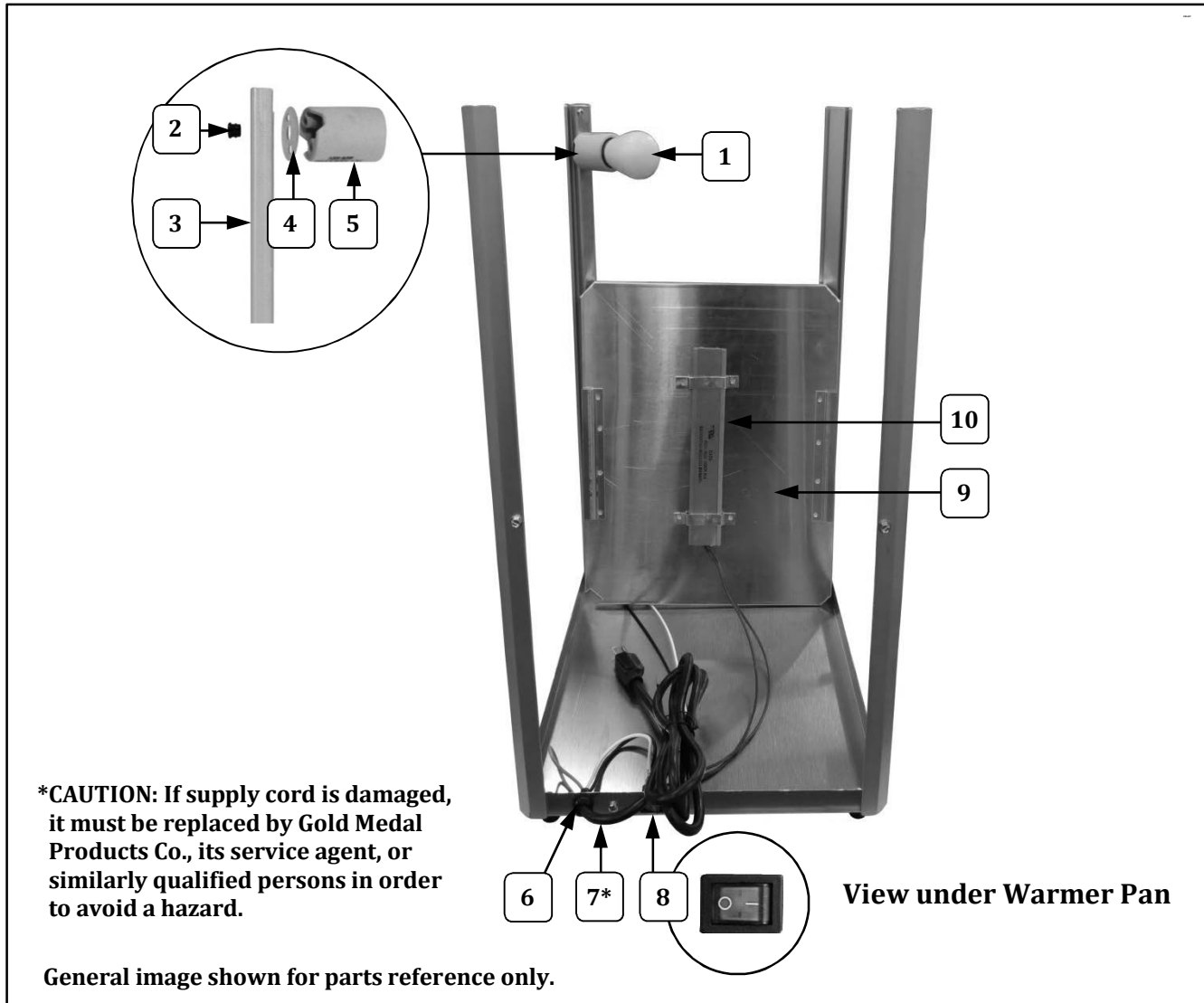

Item	Part Description	Part Number		
		2185ST	2187ST	2189
1	YELLOW LIGHT BULB (shatterproof bulb)	11035	11035	11035
2	.312" SNAP BUSHING	75328	75328	75328
3	LIGHT SUPPORT CHANNEL	40011	40011	40064
4	LAMP HOLDER GASKET	40381	40381	40381
5	LAMP HOLDER	40141	40141	40141
6	#SR-6P3-4 STRAIN RELIEF	76026	76026	76026
7	LEAD-IN CORD 15 AMP PLUG	22038	22038	22038
8	DPST ROCKER SWITCH	42532	42532	42532
9	WARMER PAN ASSEMBLY	40117	40117	40124
10	120 VOLT 50 WATT HEAT ELEMENT	40031		40031
	115 VOLT 75 WATT HEAT ELEMENT		44026	

Cabinet - Light and Warmer View

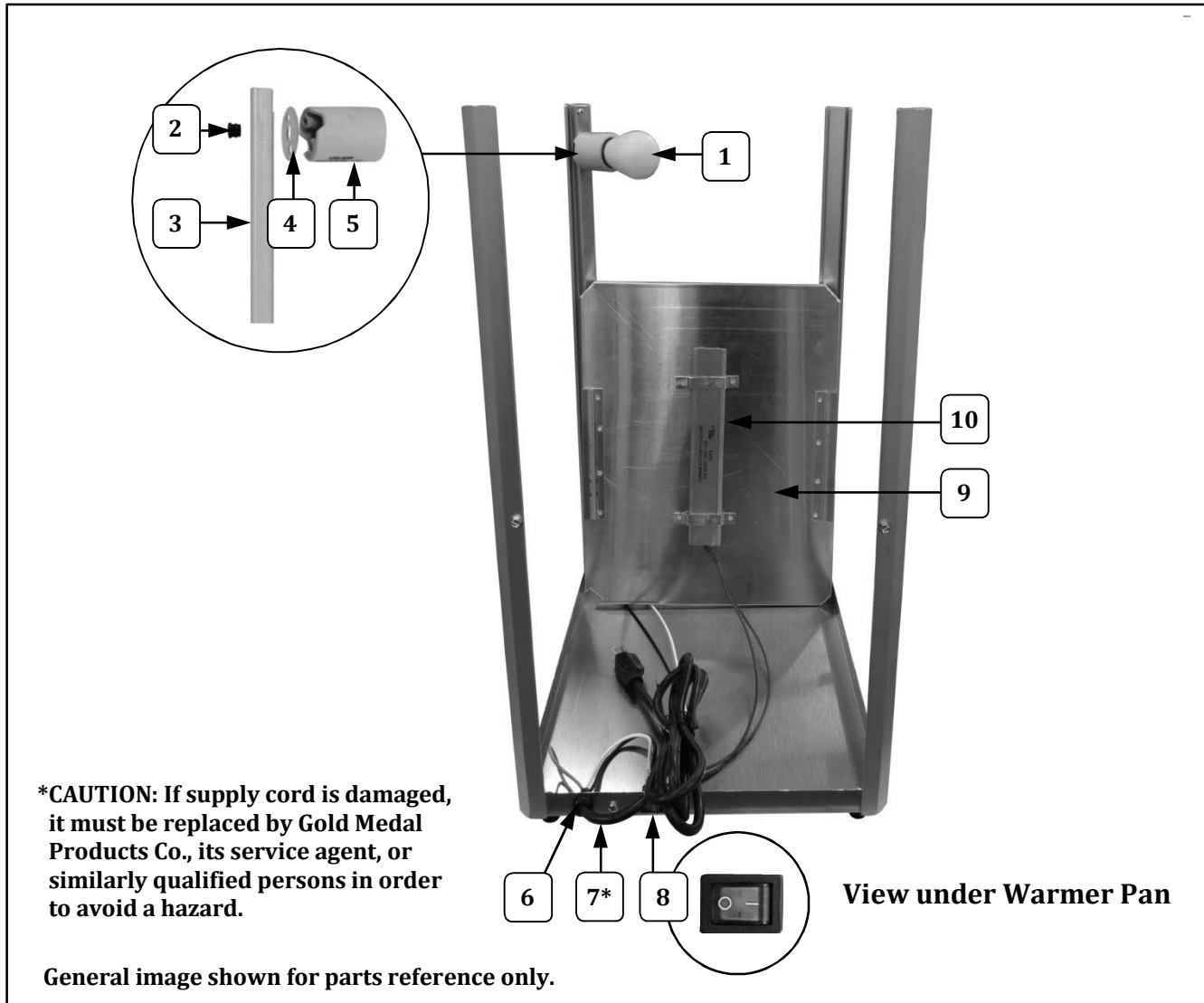

Item	Part Description	Part Number		
		2185ST	2187ST	2189
1	YELLOW LIGHT BULB (shatterproof bulb)	11035	11035	11035
2	.312" SNAP BUSHING	75328	75328	75328
3	LIGHT SUPPORT CHANNEL	40011	40011	40064
4	LAMP HOLDER GASKET	40381	40381	40381
5	LAMP HOLDER	40141	40141	40141
6	#SR-6P3-4 STRAIN RELIEF	76026	76026	76026
7	LEAD-IN CORD 15 AMP PLUG	22038	22038	22038
8	DPST ROCKER SWITCH	42532	42532	42532
9	WARMER PAN ASSEMBLY	40117	40117	40124
10	120 VOLT 50 WATT HEAT ELEMENT	40031		40031
	115 VOLT 75 WATT HEAT ELEMENT		44026	

Cabinet - Light and Warmer View

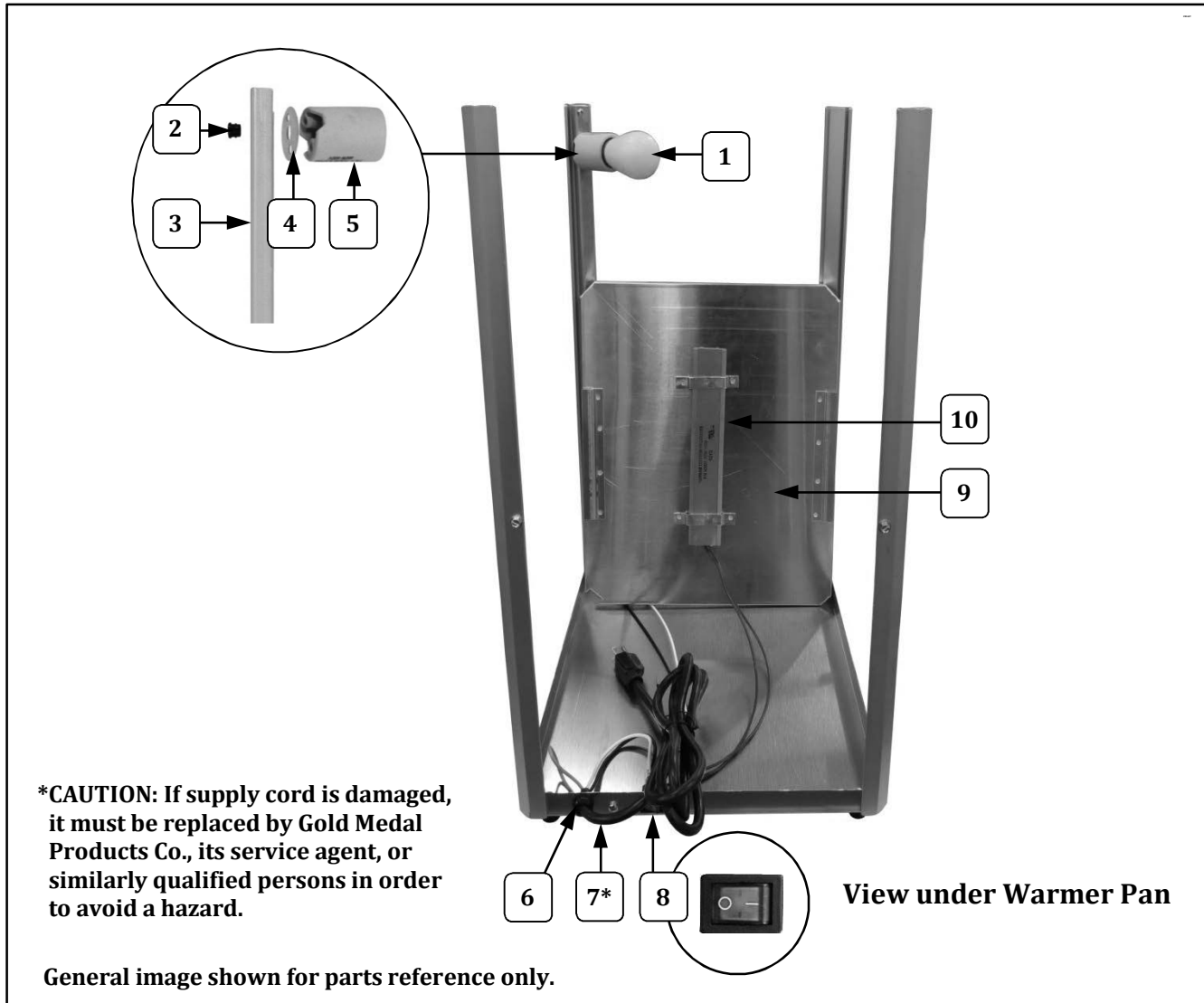

Item	Part Description	Part Number		
		2185ST	2187ST	2189
1	YELLOW LIGHT BULB (shatterproof bulb)	11035	11035	11035
2	.312" SNAP BUSHING	75328	75328	75328
3	LIGHT SUPPORT CHANEL	40011	40011	40064
4	LAMP HOLDER GASKET	40381	40381	40381
5	LAMP HOLDER	40141	40141	40141
6	#SR-6P3-4 STRAIN RELIEF	76026	76026	76026
7	LEAD-IN CORD 15 AMP PLUG	22038	22038	22038
8	DPST ROCKER SWITCH	42532	42532	42532
9	WARMER PAN ASSEMBLY	40117	40117	40124
10	120 VOLT 50 WATT HEAT ELEMENT	40031		40031
	115 VOLT 75 WATT HEAT ELEMENT		44026	

Cabinet - Light and Warmer View

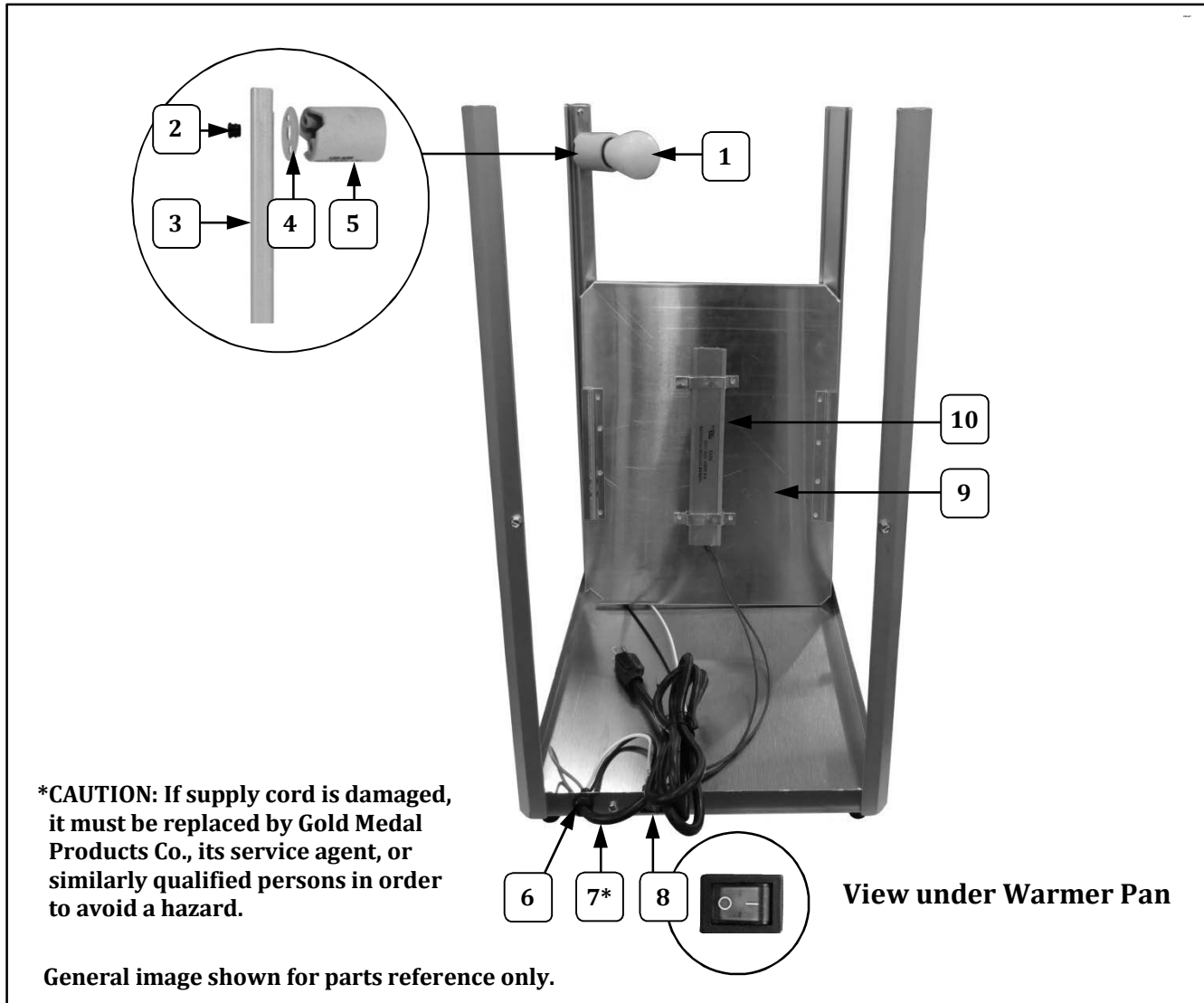

Item	Part Description	Part Number		
		2185ST	2187ST	2189
1	YELLOW LIGHT BULB (shatterproof bulb)	11035	11035	11035
2	.312" SNAP BUSHING	75328	75328	75328
3	LIGHT SUPPORT CHANNEL	40011	40011	40064
4	LAMP HOLDER GASKET	40381	40381	40381
5	LAMP HOLDER	40141	40141	40141
6	#SR-6P3-4 STRAIN RELIEF	76026	76026	76026
7	LEAD-IN CORD 15 AMP PLUG	22038	22038	22038
8	DPST ROCKER SWITCH	42532	42532	42532
9	WARMER PAN ASSEMBLY	40117	40117	40124
10	120 VOLT 50 WATT HEAT ELEMENT	40031		40031
	115 VOLT 75 WATT HEAT ELEMENT		44026	

Cabinet - Light and Warmer View

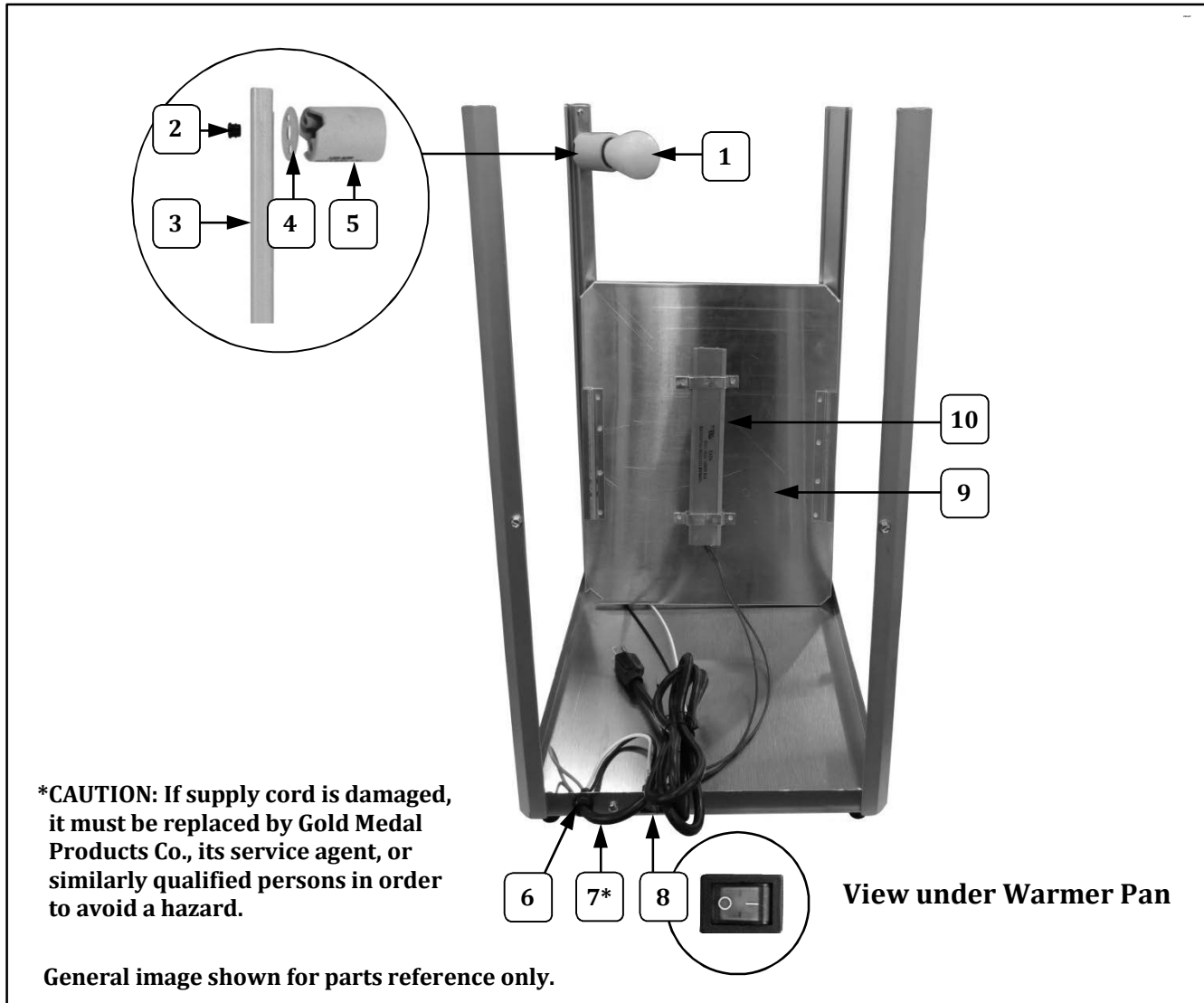

Item	Part Description	Part Number		
		2185ST	2187ST	2189
1	YELLOW LIGHT BULB (shatterproof bulb)	11035	11035	11035
2	.312" SNAP BUSHING	75328	75328	75328
3	LIGHT SUPPORT CHANNEL	40011	40011	40064
4	LAMP HOLDER GASKET	40381	40381	40381
5	LAMP HOLDER	40141	40141	40141
6	#SR-6P3-4 STRAIN RELIEF	76026	76026	76026
7	LEAD-IN CORD 15 AMP PLUG	22038	22038	22038
8	DPST ROCKER SWITCH	42532	42532	42532
9	WARMER PAN ASSEMBLY	40117	40117	40124
10	120 VOLT 50 WATT HEAT ELEMENT	40031		40031
	115 VOLT 75 WATT HEAT ELEMENT		44026	



Cabinet - Light and Warmer View

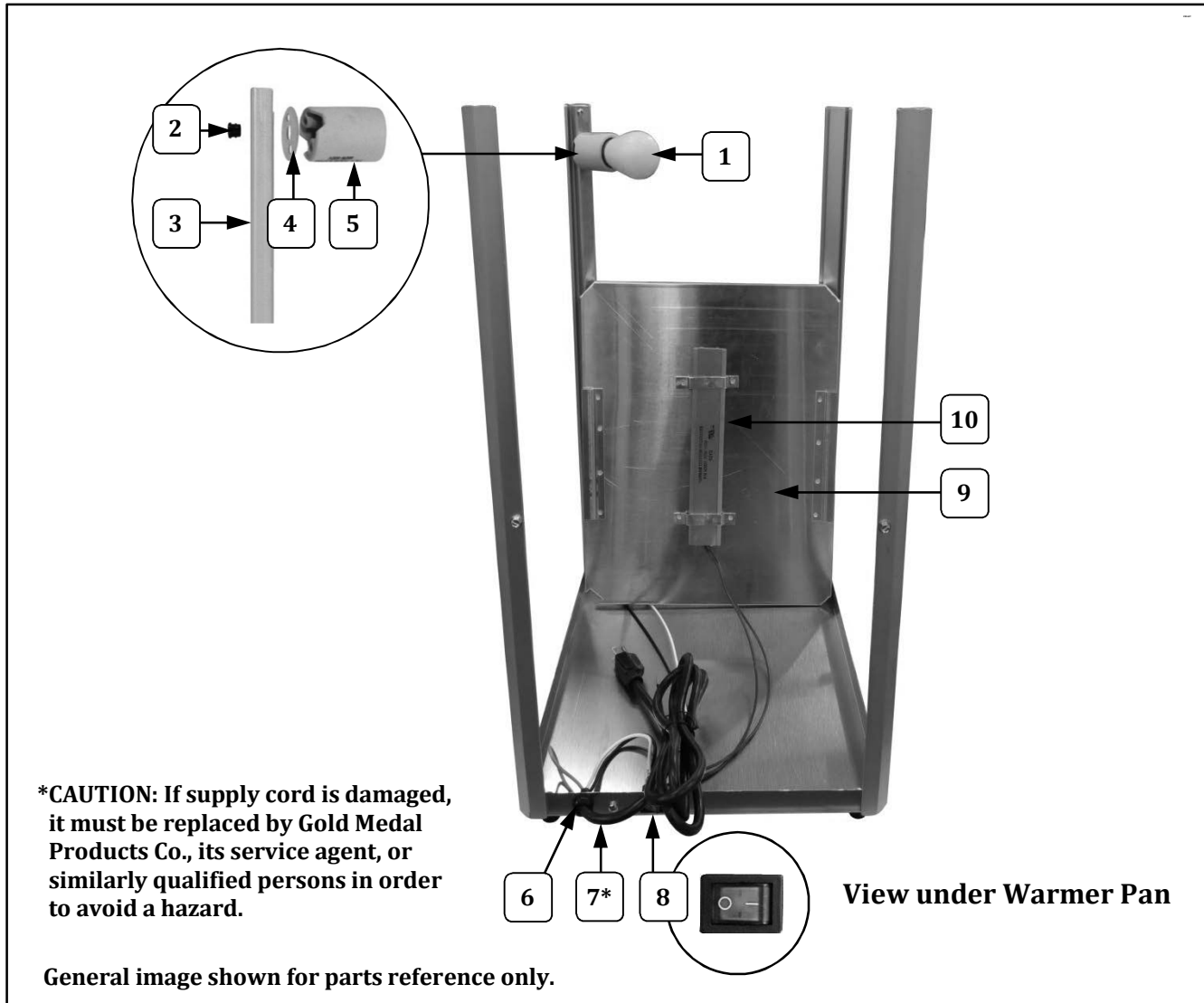

Item	Part Description	Part Number		
		2185ST	2187ST	2189
1	YELLOW LIGHT BULB (shatterproof bulb)	11035	11035	11035
2	.312" SNAP BUSHING	75328	75328	75328
3	LIGHT SUPPORT CHANNEL	40011	40011	40064
4	LAMP HOLDER GASKET	40381	40381	40381
5	LAMP HOLDER	40141	40141	40141
6	#SR-6P3-4 STRAIN RELIEF	76026	76026	76026
7	LEAD-IN CORD 15 AMP PLUG	22038	22038	22038
8	DPST ROCKER SWITCH	42532	42532	42532
9	WARMER PAN ASSEMBLY	40117	40117	40124
10	120 VOLT 50 WATT HEAT ELEMENT	40031		40031
	115 VOLT 75 WATT HEAT ELEMENT		44026	



Cabinet - Light and Warmer View

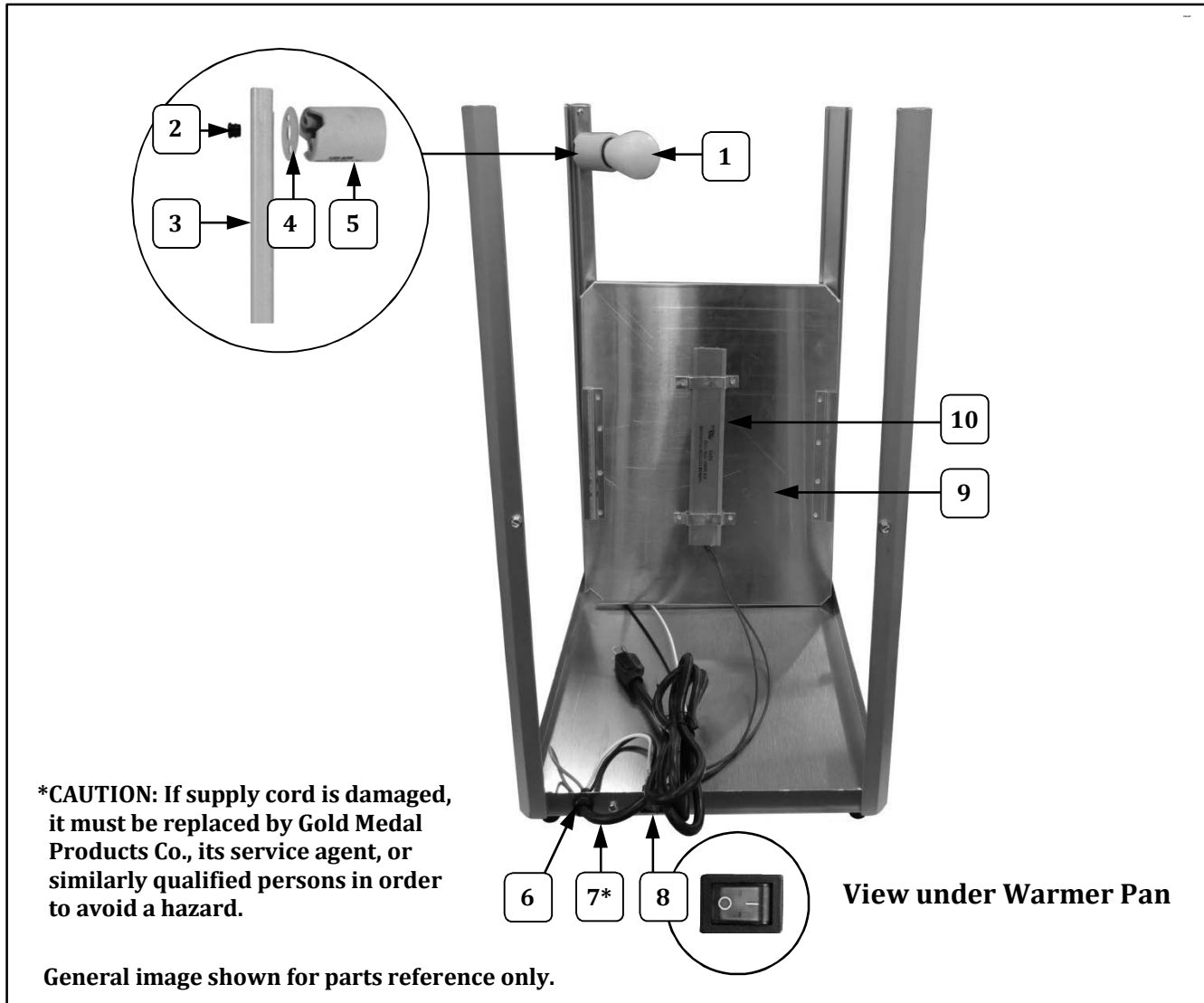

Item	Part Description	Part Number		
		2185ST	2187ST	2189
1	YELLOW LIGHT BULB (shatterproof bulb)	11035	11035	11035
2	.312" SNAP BUSHING	75328	75328	75328
3	LIGHT SUPPORT CHANEL	40011	40011	40064
4	LAMP HOLDER GASKET	40381	40381	40381
5	LAMP HOLDER	40141	40141	40141
6	#SR-6P3-4 STRAIN RELIEF	76026	76026	76026
7	LEAD-IN CORD 15 AMP PLUG	22038	22038	22038
8	DPST ROCKER SWITCH	42532	42532	42532
9	WARMER PAN ASSEMBLY	40117	40117	40124
10	120 VOLT 50 WATT HEAT ELEMENT	40031		40031
	115 VOLT 75 WATT HEAT ELEMENT		44026	

Cabinet - Light and Warmer View

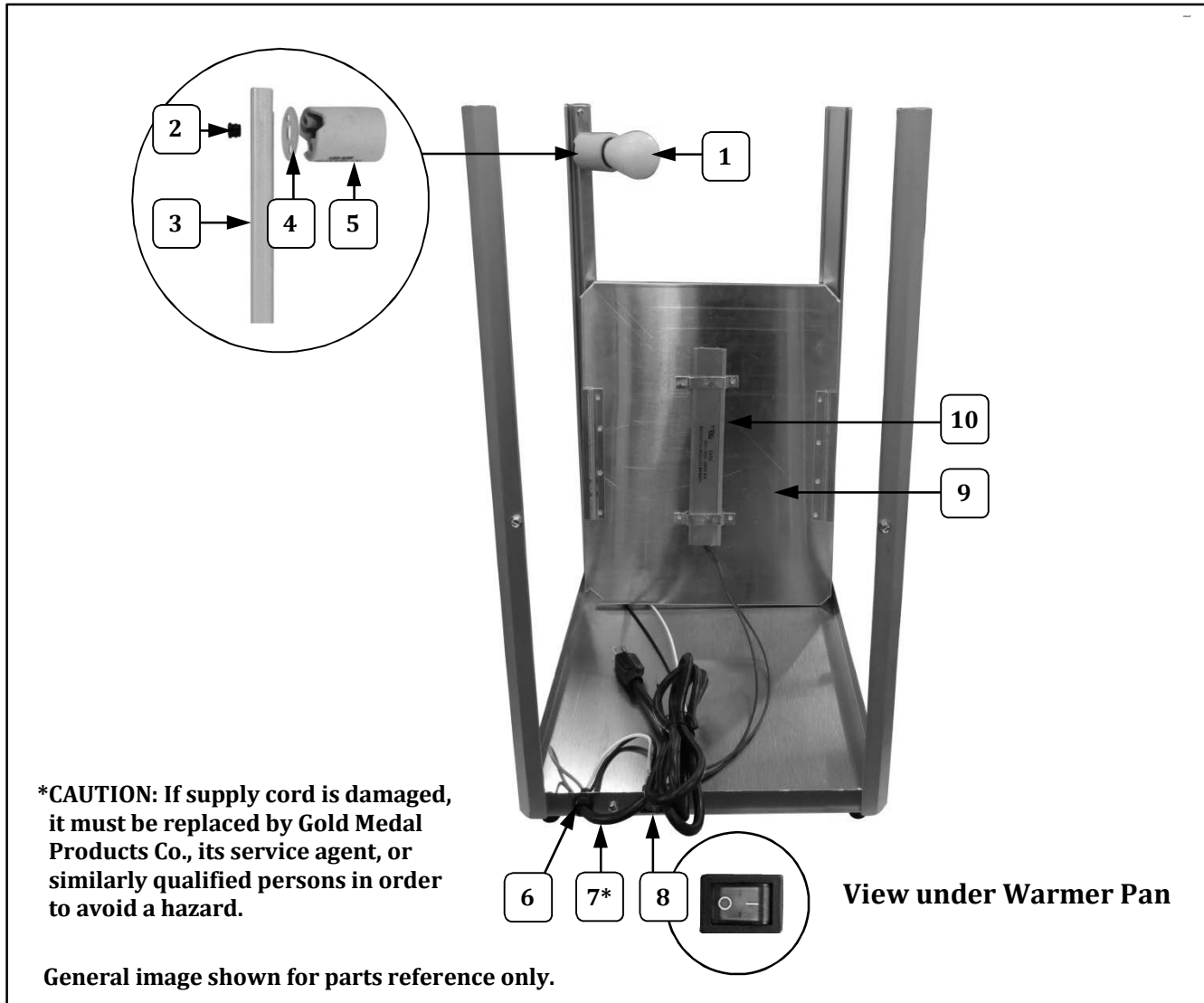

Item	Part Description	Part Number		
		2185ST	2187ST	2189
1	YELLOW LIGHT BULB (shatterproof bulb)	11035	11035	11035
2	.312" SNAP BUSHING	75328	75328	75328
3	LIGHT SUPPORT CHANNEL	40011	40011	40064
4	LAMP HOLDER GASKET	40381	40381	40381
5	LAMP HOLDER	40141	40141	40141
6	#SR-6P3-4 STRAIN RELIEF	76026	76026	76026
7	LEAD-IN CORD 15 AMP PLUG	22038	22038	22038
8	DPST ROCKER SWITCH	42532	42532	42532
9	WARMER PAN ASSEMBLY	40117	40117	40124
10	120 VOLT 50 WATT HEAT ELEMENT	40031		40031
	115 VOLT 75 WATT HEAT ELEMENT		44026	

Cabinet - Light and Warmer View

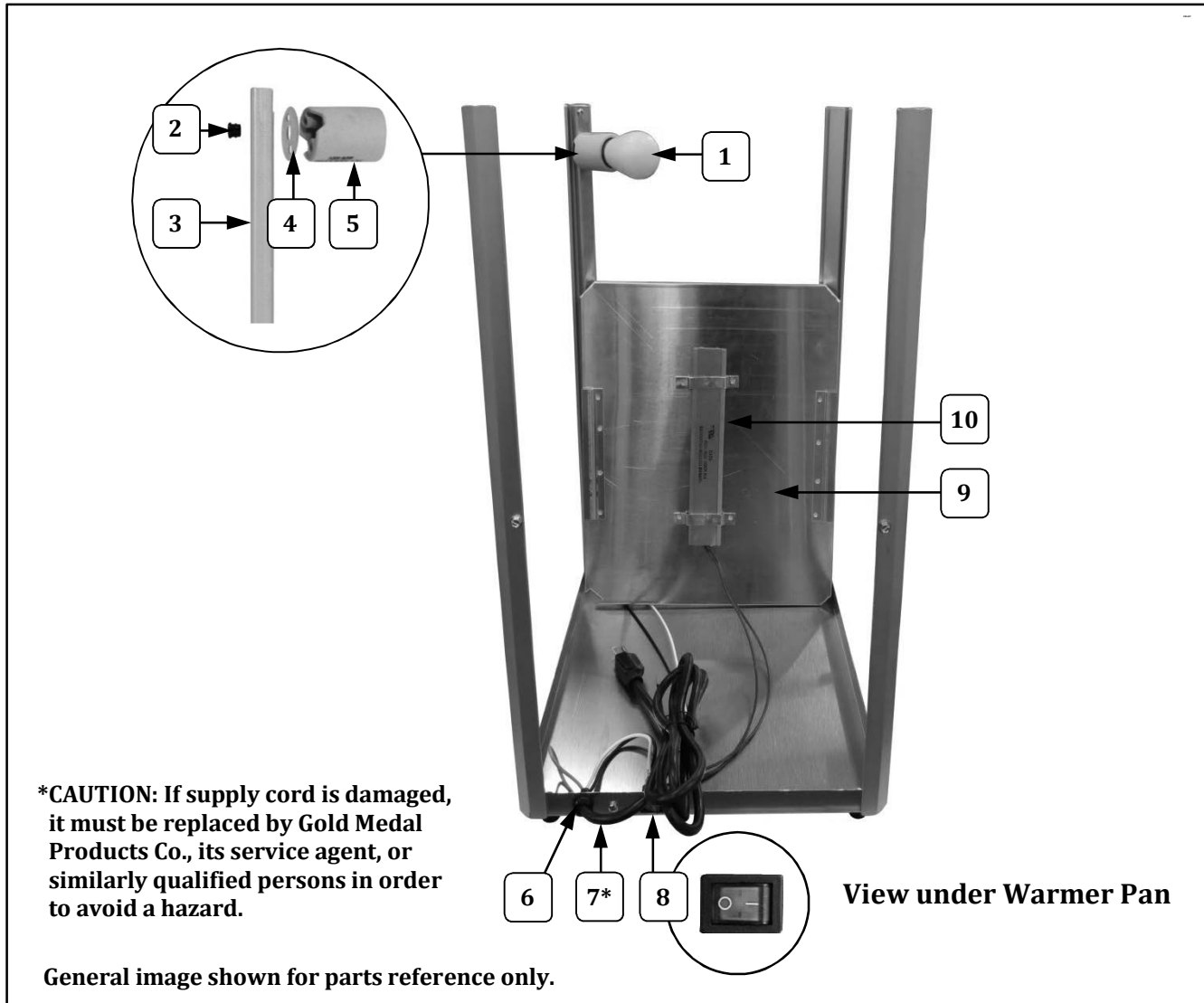

Item	Part Description	Part Number		
		2185ST	2187ST	2189
1	YELLOW LIGHT BULB (shatterproof bulb)	11035	11035	11035
2	.312" SNAP BUSHING	75328	75328	75328
3	LIGHT SUPPORT CHANNEL	40011	40011	40064
4	LAMP HOLDER GASKET	40381	40381	40381
5	LAMP HOLDER	40141	40141	40141
6	#SR-6P3-4 STRAIN RELIEF	76026	76026	76026
7	LEAD-IN CORD 15 AMP PLUG	22038	22038	22038
8	DPST ROCKER SWITCH	42532	42532	42532
9	WARMER PAN ASSEMBLY	40117	40117	40124
10	120 VOLT 50 WATT HEAT ELEMENT	40031		40031
	115 VOLT 75 WATT HEAT ELEMENT		44026	



Cabinet - Light and Warmer View

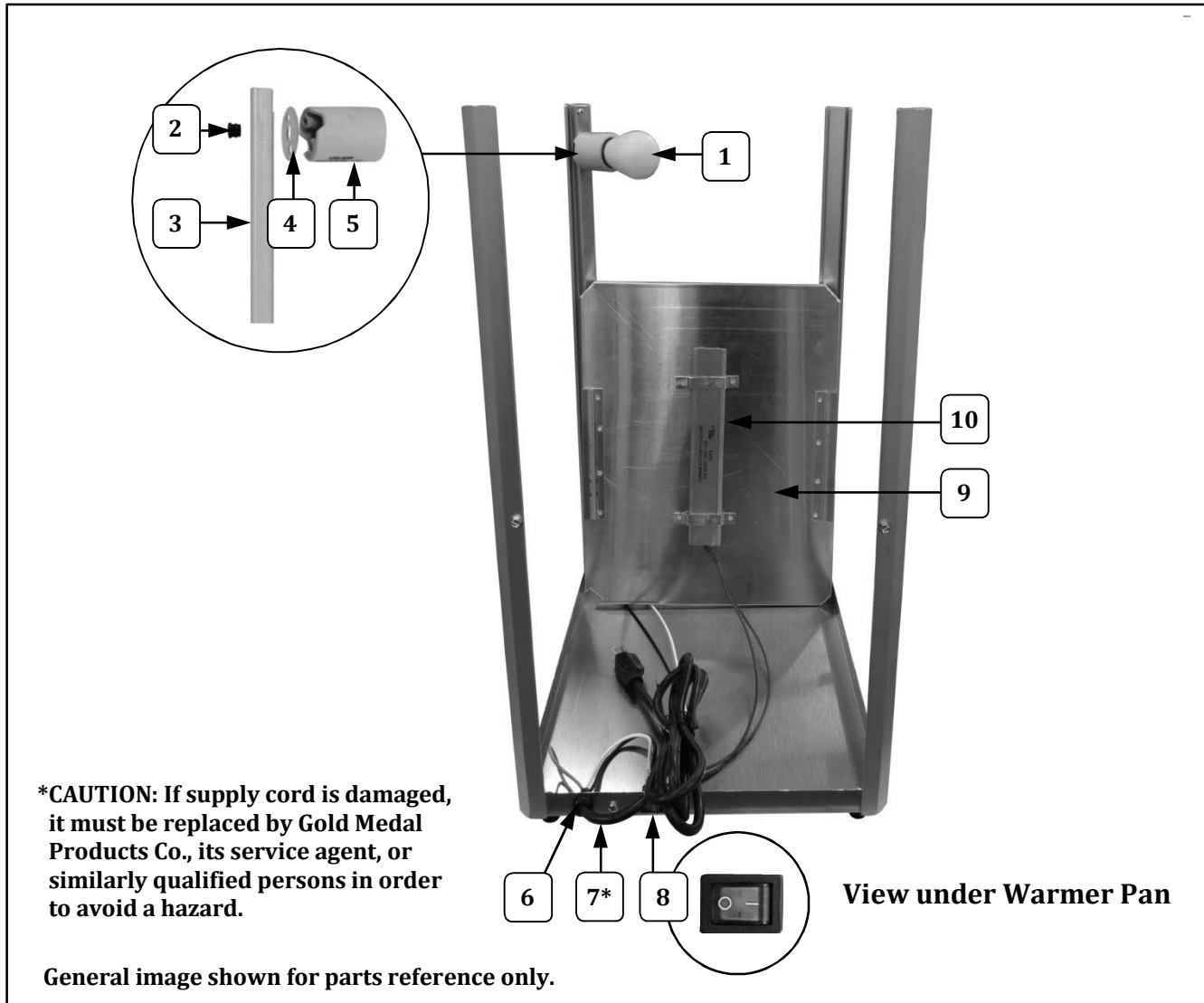

Item	Part Description	Part Number		
		2185ST	2187ST	2189
1	YELLOW LIGHT BULB (shatterproof bulb)	11035	11035	11035
2	.312" SNAP BUSHING	75328	75328	75328
3	LIGHT SUPPORT CHANNEL	40011	40011	40064
4	LAMP HOLDER GASKET	40381	40381	40381
5	LAMP HOLDER	40141	40141	40141
6	#SR-6P3-4 STRAIN RELIEF	76026	76026	76026
7	LEAD-IN CORD 15 AMP PLUG	22038	22038	22038
8	DPST ROCKER SWITCH	42532	42532	42532
9	WARMER PAN ASSEMBLY	40117	40117	40124
10	120 VOLT 50 WATT HEAT ELEMENT	40031		40031
	115 VOLT 75 WATT HEAT ELEMENT		44026	

Cabinet - Light and Warmer View

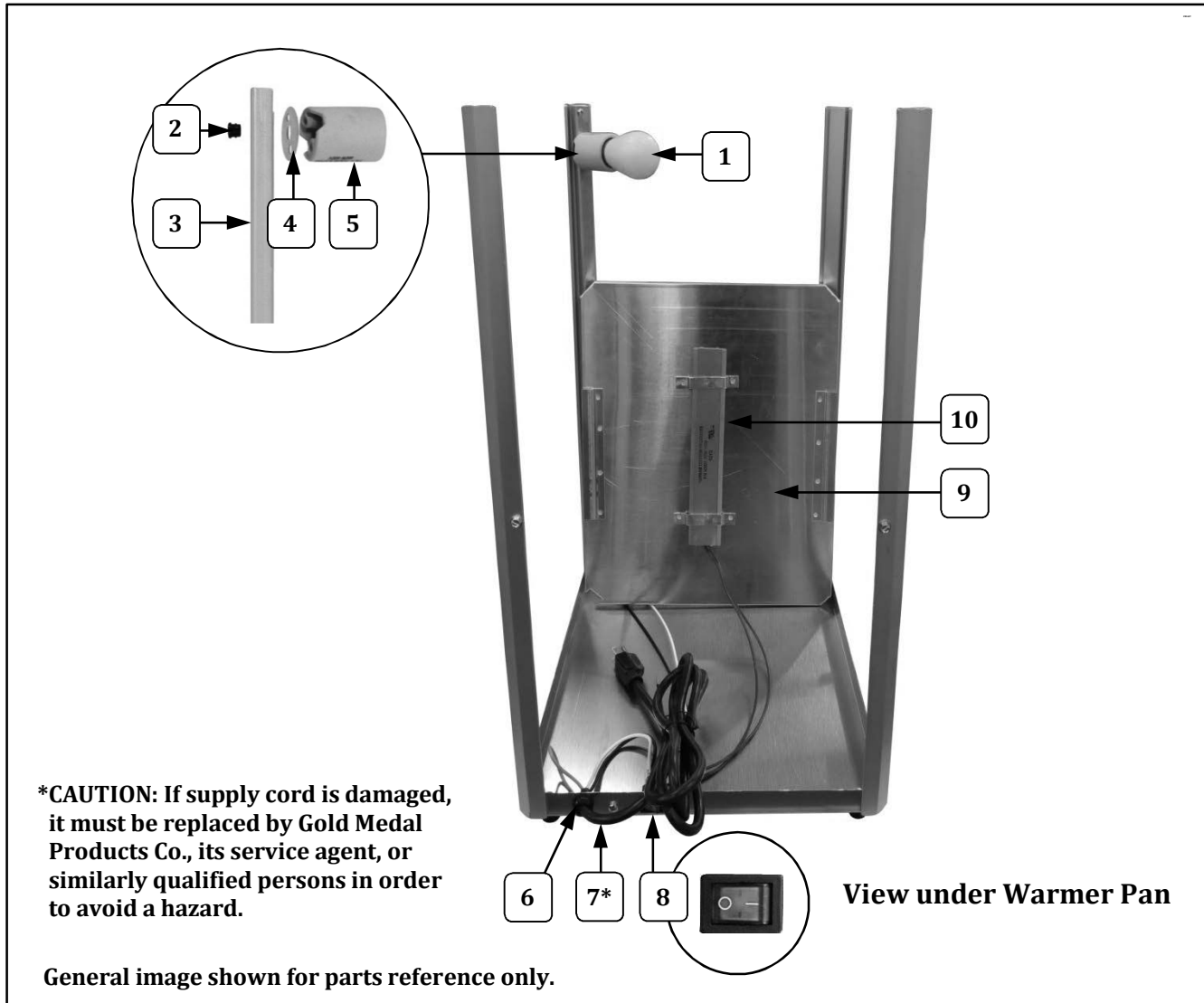

Item	Part Description	Part Number		
		2185ST	2187ST	2189
1	YELLOW LIGHT BULB (shatterproof bulb)	11035	11035	11035
2	.312" SNAP BUSHING	75328	75328	75328
3	LIGHT SUPPORT CHANNEL	40011	40011	40064
4	LAMP HOLDER GASKET	40381	40381	40381
5	LAMP HOLDER	40141	40141	40141
6	#SR-6P3-4 STRAIN RELIEF	76026	76026	76026
7	LEAD-IN CORD 15 AMP PLUG	22038	22038	22038
8	DPST ROCKER SWITCH	42532	42532	42532
9	WARMER PAN ASSEMBLY	40117	40117	40124
10	120 VOLT 50 WATT HEAT ELEMENT	40031		40031
	115 VOLT 75 WATT HEAT ELEMENT		44026	

Cabinet - Light and Warmer View

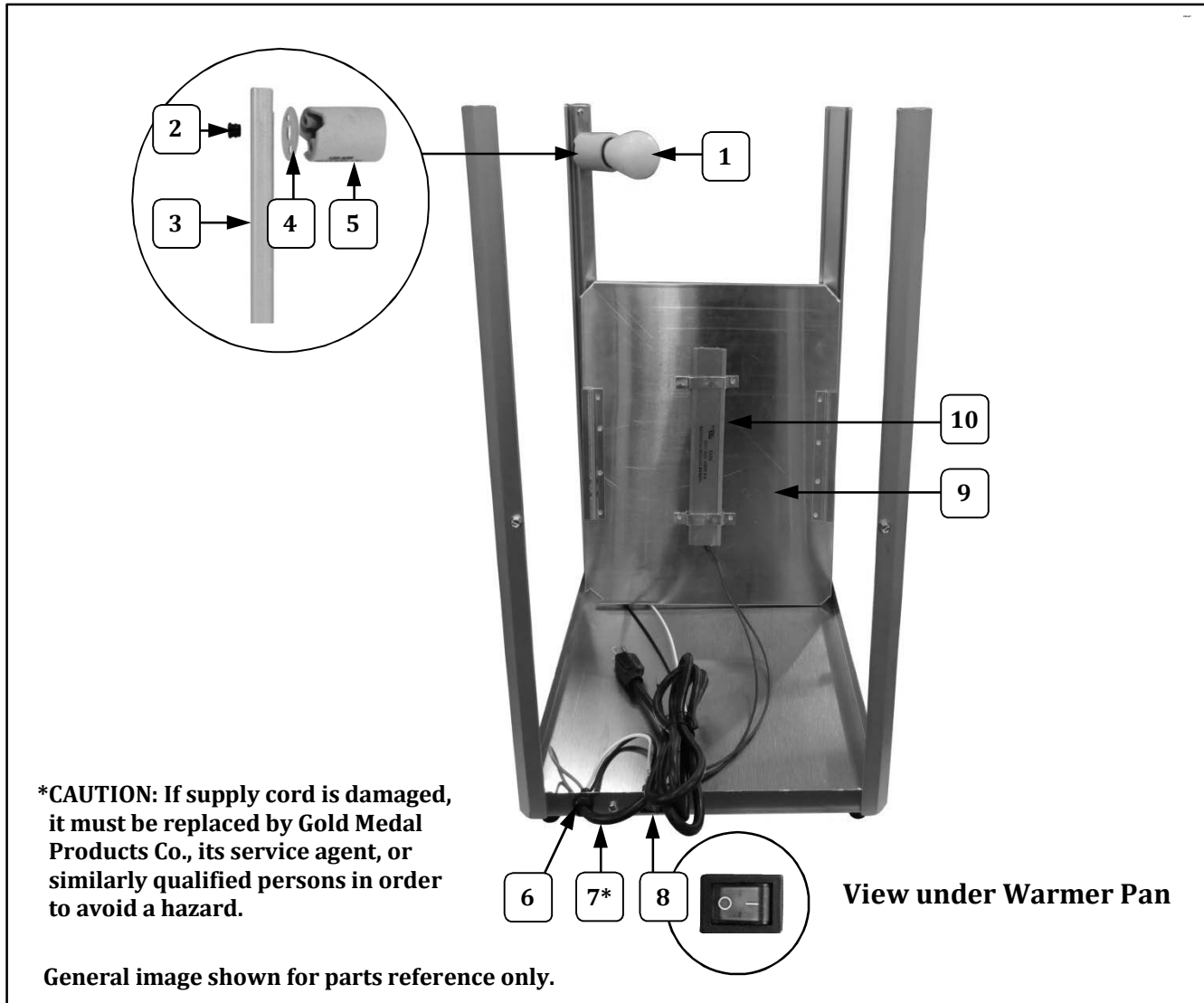

Item	Part Description	Part Number		
		2185ST	2187ST	2189
1	YELLOW LIGHT BULB (shatterproof bulb)	11035	11035	11035
2	.312" SNAP BUSHING	75328	75328	75328
3	LIGHT SUPPORT CHANNEL	40011	40011	40064
4	LAMP HOLDER GASKET	40381	40381	40381
5	LAMP HOLDER	40141	40141	40141
6	#SR-6P3-4 STRAIN RELIEF	76026	76026	76026
7	LEAD-IN CORD 15 AMP PLUG	22038	22038	22038
8	DPST ROCKER SWITCH	42532	42532	42532
9	WARMER PAN ASSEMBLY	40117	40117	40124
10	120 VOLT 50 WATT HEAT ELEMENT	40031		40031
	115 VOLT 75 WATT HEAT ELEMENT		44026	



Cabinet - Light and Warmer View

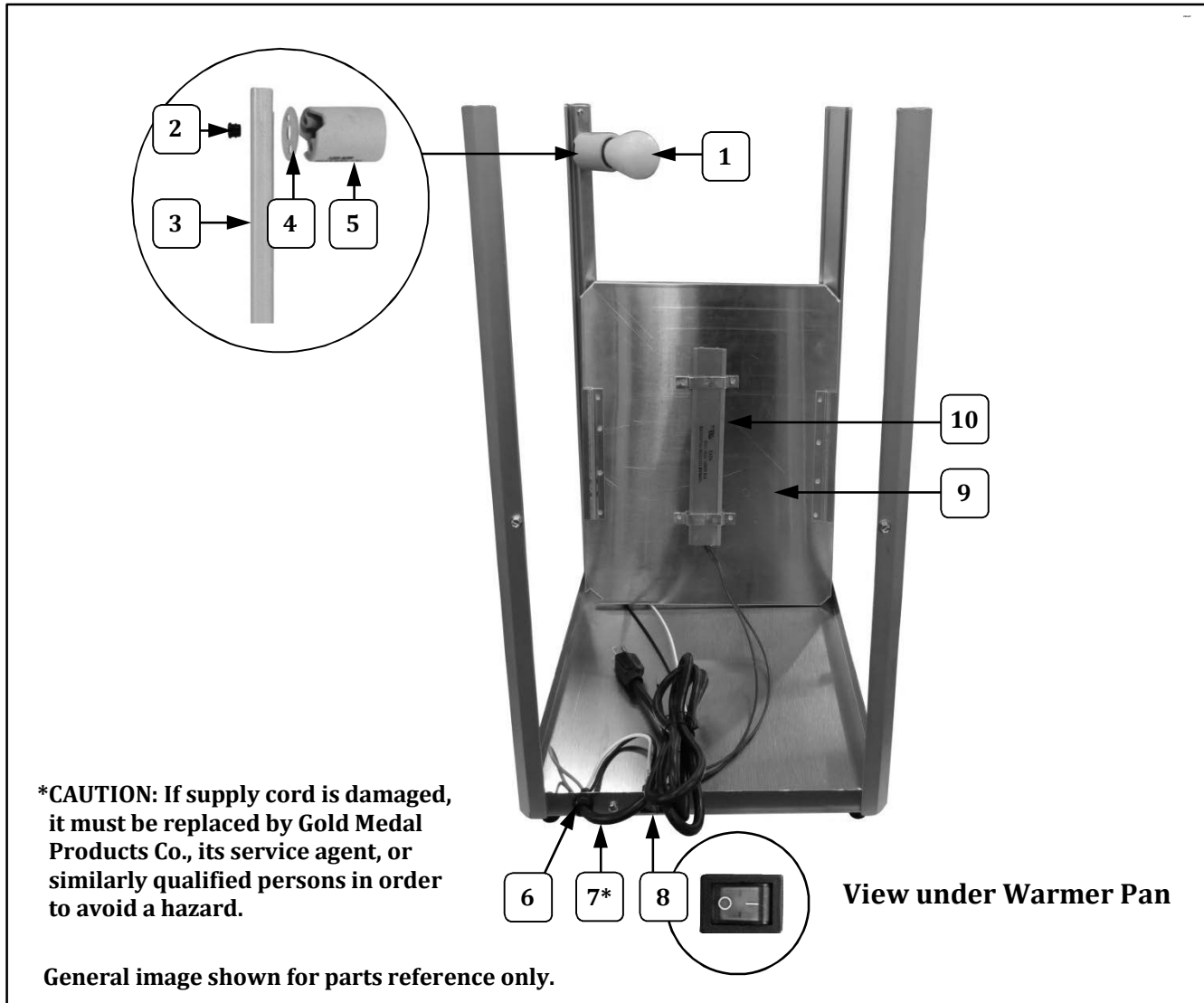

Item	Part Description	Part Number		
		2185ST	2187ST	2189
1	YELLOW LIGHT BULB (shatterproof bulb)	11035	11035	11035
2	.312" SNAP BUSHING	75328	75328	75328
3	LIGHT SUPPORT CHANEL	40011	40011	40064
4	LAMP HOLDER GASKET	40381	40381	40381
5	LAMP HOLDER	40141	40141	40141
6	#SR-6P3-4 STRAIN RELIEF	76026	76026	76026
7	LEAD-IN CORD 15 AMP PLUG	22038	22038	22038
8	DPST ROCKER SWITCH	42532	42532	42532
9	WARMER PAN ASSEMBLY	40117	40117	40124
10	120 VOLT 50 WATT HEAT ELEMENT	40031		40031
	115 VOLT 75 WATT HEAT ELEMENT		44026	



Cabinet - Light and Warmer View

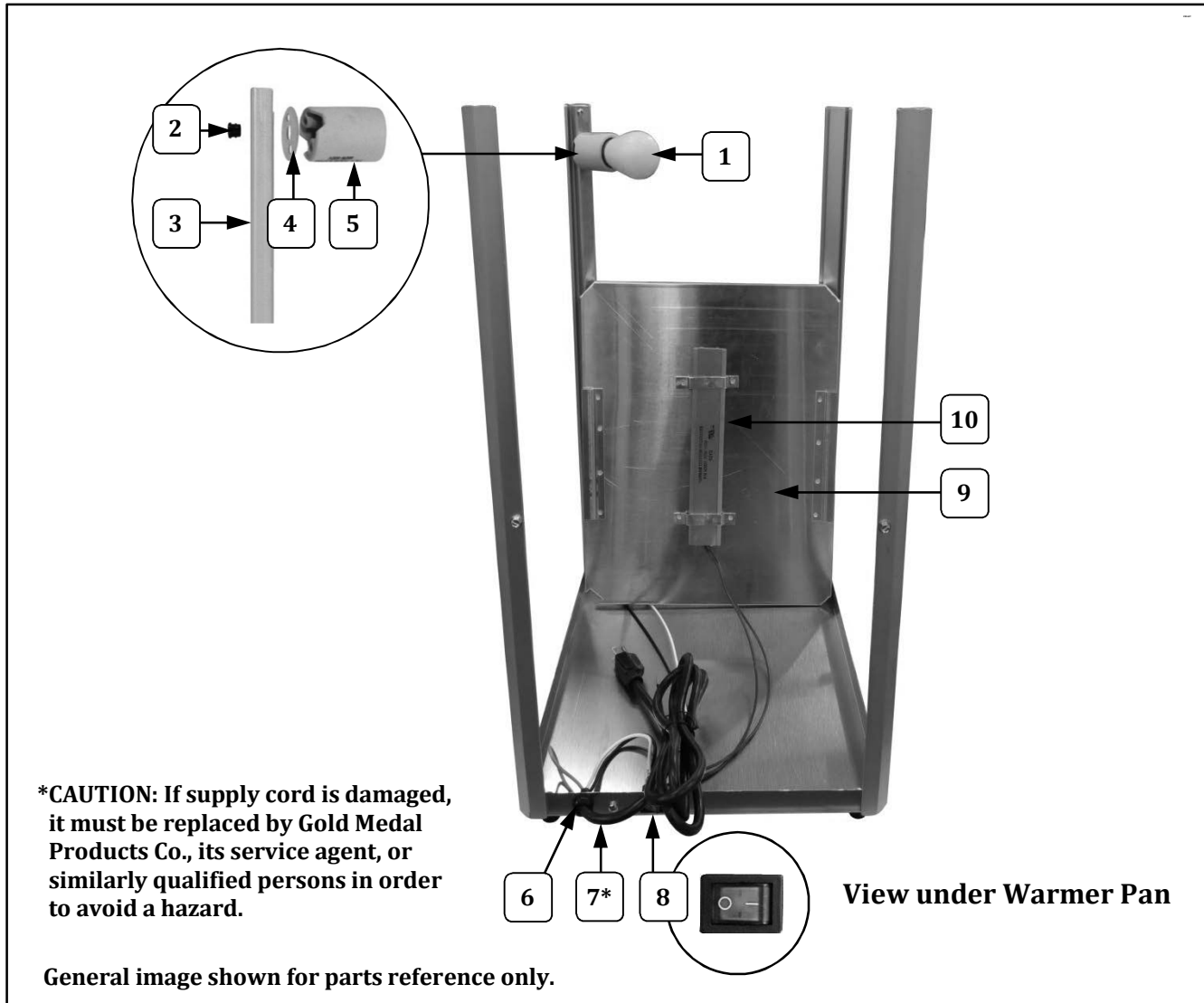

Item	Part Description	Part Number		
		2185ST	2187ST	2189
1	YELLOW LIGHT BULB (shatterproof bulb)	11035	11035	11035
2	.312" SNAP BUSHING	75328	75328	75328
3	LIGHT SUPPORT CHANNEL	40011	40011	40064
4	LAMP HOLDER GASKET	40381	40381	40381
5	LAMP HOLDER	40141	40141	40141
6	#SR-6P3-4 STRAIN RELIEF	76026	76026	76026
7	LEAD-IN CORD 15 AMP PLUG	22038	22038	22038
8	DPST ROCKER SWITCH	42532	42532	42532
9	WARMER PAN ASSEMBLY	40117	40117	40124
10	120 VOLT 50 WATT HEAT ELEMENT	40031		40031
	115 VOLT 75 WATT HEAT ELEMENT		44026	



Cabinet - Light and Warmer View

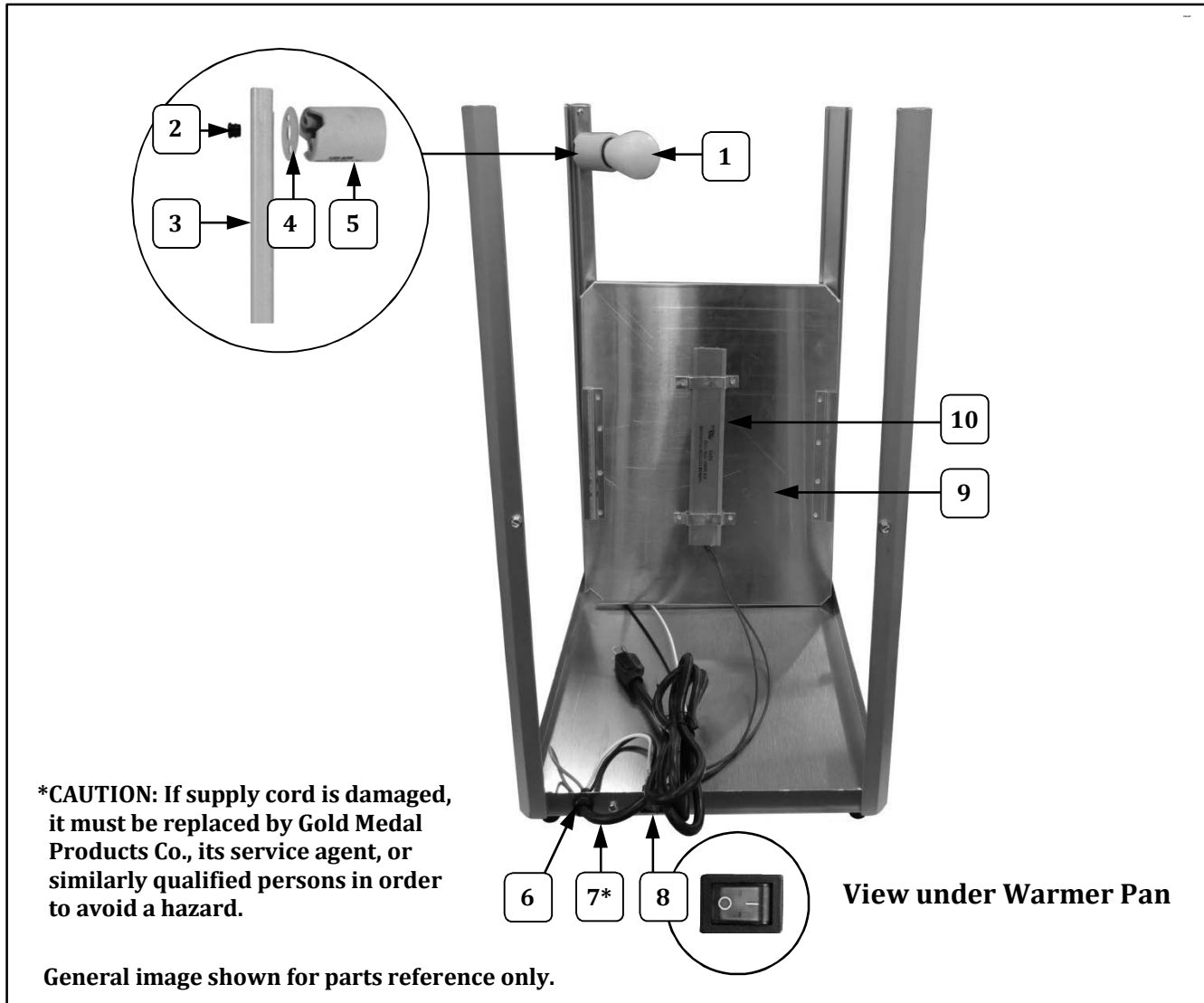

Item	Part Description	Part Number		
		2185ST	2187ST	2189
1	YELLOW LIGHT BULB (shatterproof bulb)	11035	11035	11035
2	.312" SNAP BUSHING	75328	75328	75328
3	LIGHT SUPPORT CHANNEL	40011	40011	40064
4	LAMP HOLDER GASKET	40381	40381	40381
5	LAMP HOLDER	40141	40141	40141
6	#SR-6P3-4 STRAIN RELIEF	76026	76026	76026
7	LEAD-IN CORD 15 AMP PLUG	22038	22038	22038
8	DPST ROCKER SWITCH	42532	42532	42532
9	WARMER PAN ASSEMBLY	40117	40117	40124
10	120 VOLT 50 WATT HEAT ELEMENT	40031		40031
	115 VOLT 75 WATT HEAT ELEMENT		44026	

Cabinet View

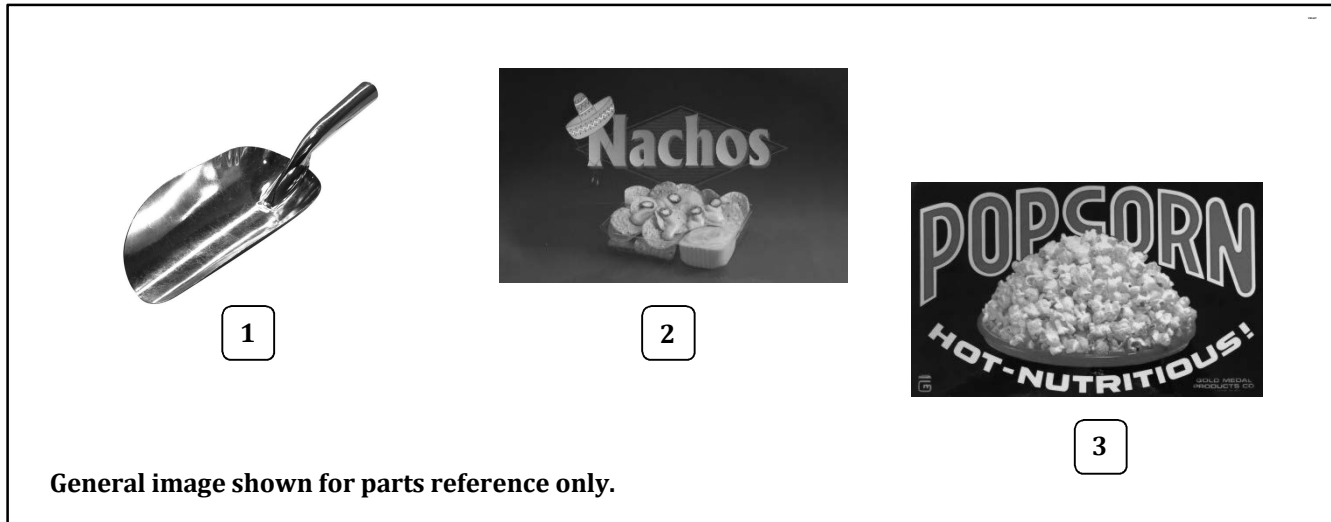

Item	Part Description	Part Number		
		2185ST	2187ST	2189
1	STAMPED ALUMINUM SCOOP	2071	2071	2071
2	DECAL (NACHOS)	40043		40066
3	POPCORN BOWL DECAL		40052	

Cabinet View

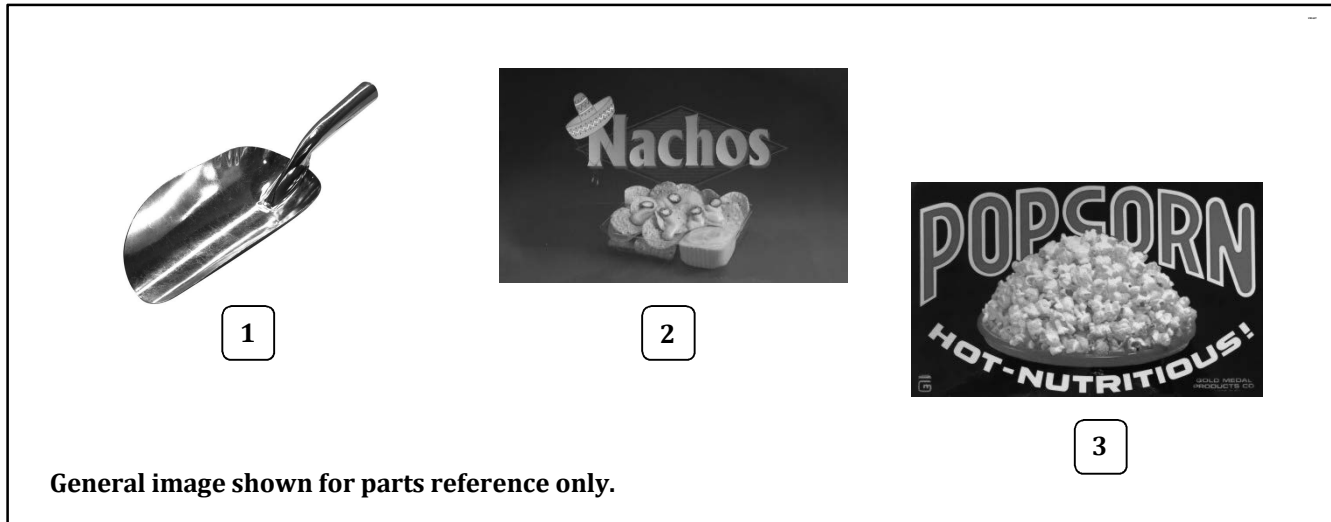

Item	Part Description	Part Number		
		2185ST	2187ST	2189
1	STAMPED ALUMINUM SCOOP	2071	2071	2071
2	DECAL (NACHOS)	40043		40066
3	POPCORN BOWL DECAL		40052	

Cabinet View

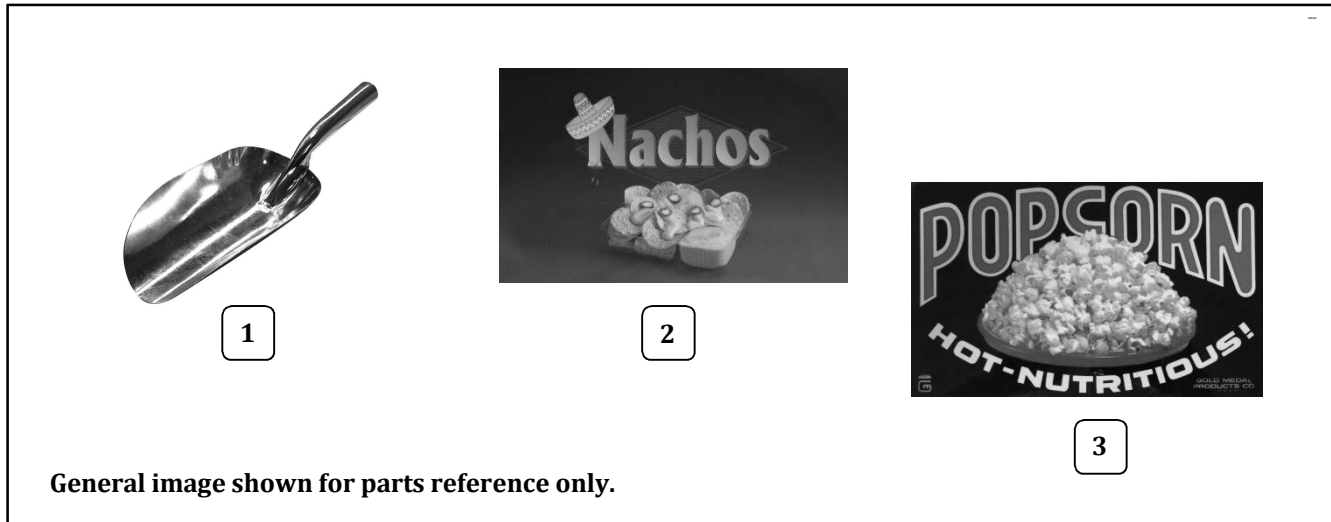

Item	Part Description	Part Number		
		2185ST	2187ST	2189
1	STAMPED ALUMINUM SCOOP	2071	2071	2071
2	DECAL (NACHOS)	40043		40066
3	POPCORN BOWL DECAL		40052	