



Unit Exterior



Item	Part Description	Qty.	Part No. 2494
1	TOP COVER	1	39974
2	TOWER BACK PLATE	1	39962
3	TOWER TOP PLATE	1	39963
4	MOMENTARY SWITCH	1	38971
5	TOPPING SIGN	1	39971
6	FRONT PLATE WELD ASSY	1	39966
7	DRIP PAN BOTTOM	1	39977
8	DRIP PAN INSERT	1	39978
9	CONTROL COVER PLATE	1	39980
10	8-32 X 3/8 PAN HD PH M/S	12	12389



Unit Exterior



Item	Part Description	Qty.	Part No. 2494
1	TOP COVER	1	39974
2	TOWER BACK PLATE	1	39962
3	TOWER TOP PLATE	1	39963
4	MOMENTARY SWITCH	1	38971
5	TOPPING SIGN	1	39971
6	FRONT PLATE WELD ASSY	1	39966
7	DRIP PAN BOTTOM	1	39977
8	DRIP PAN INSERT	1	39978
9	CONTROL COVER PLATE	1	39980
10	8-32 X 3/8 PAN HD PH M/S	12	12389



Unit Exterior



Item	Part Description	Qty.	Part No. 2494
1	TOP COVER	1	39974
2	TOWER BACK PLATE	1	39962
3	TOWER TOP PLATE	1	39963
4	MOMENTARY SWITCH	1	38971
5	TOPPING SIGN	1	39971
6	FRONT PLATE WELD ASSY	1	39966
7	DRIP PAN BOTTOM	1	39977
8	DRIP PAN INSERT	1	39978
9	CONTROL COVER PLATE	1	39980
10	8-32 X 3/8 PAN HD PH M/S	12	12389



Unit Exterior



Item	Part Description	Qty.	Part No. 2494
1	TOP COVER	1	39974
2	TOWER BACK PLATE	1	39962
3	TOWER TOP PLATE	1	39963
4	MOMENTARY SWITCH	1	38971
5	TOPPING SIGN	1	39971
6	FRONT PLATE WELD ASSY	1	39966
7	DRIP PAN BOTTOM	1	39977
8	DRIP PAN INSERT	1	39978
9	CONTROL COVER PLATE	1	39980
10	8-32 X 3/8 PAN HD PH M/S	12	12389



Unit Exterior



Item	Part Description	Qty.	Part No.
			2494
1	TOP COVER	1	39974
2	TOWER BACK PLATE	1	39962
3	TOWER TOP PLATE	1	39963
4	MOMENTARY SWITCH	1	38971
5	TOPPING SIGN	1	39971
6	FRONT PLATE WELD ASSY	1	39966
7	DRIP PAN BOTTOM	1	39977
8	DRIP PAN INSERT	1	39978
9	CONTROL COVER PLATE	1	39980
10	8-32 X 3/8 PAN HD PH M/S	12	12389



Unit Exterior – Bottom View

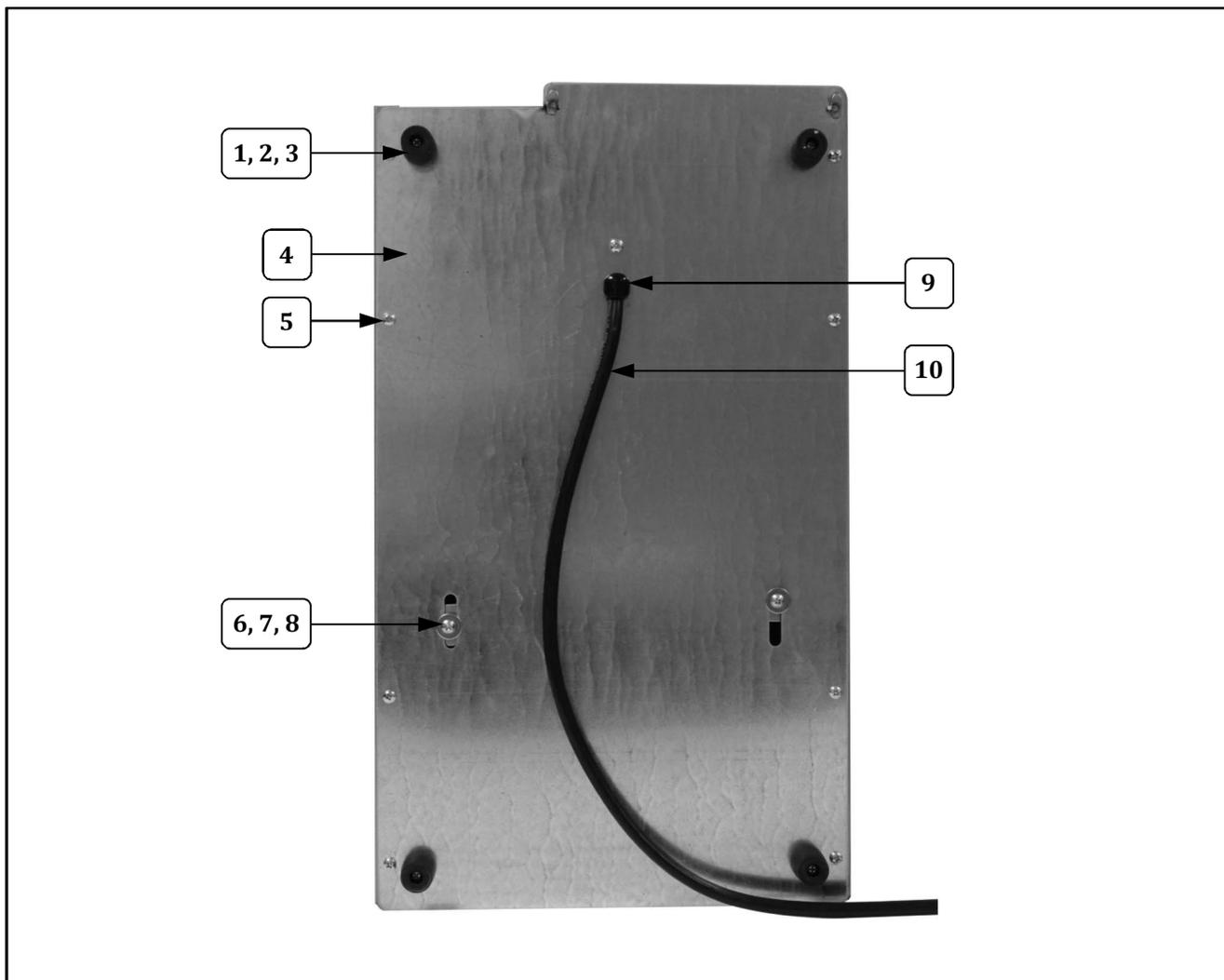

Item	Part Description	Qty.	Part No.
			2494
1	RUBBER FEET 3/4IN HIGH	4	47155
2	8-32 X 3/4 PHIL PAN M/S	4	39007
3	8-32 HEX M/S NUT	4	74149
4	BOTTOM PLATE WELD ASSY	1	39979
5	8-32 X 1/2 PH PAN T/S	8	87245
6	1/4-20 X 5/8 P/H PHIL	2	12472
7	1/4 FLAT WASHER ALUMINUM	2	10000
8	TINNERMAN NUT 1/4-20	2	42125
9	STRAIN RELIEF #SR-10-2	1	87163
10	LEAD-IN CORD 15 AMP PLUG	1	39982



Unit Exterior – Bottom View

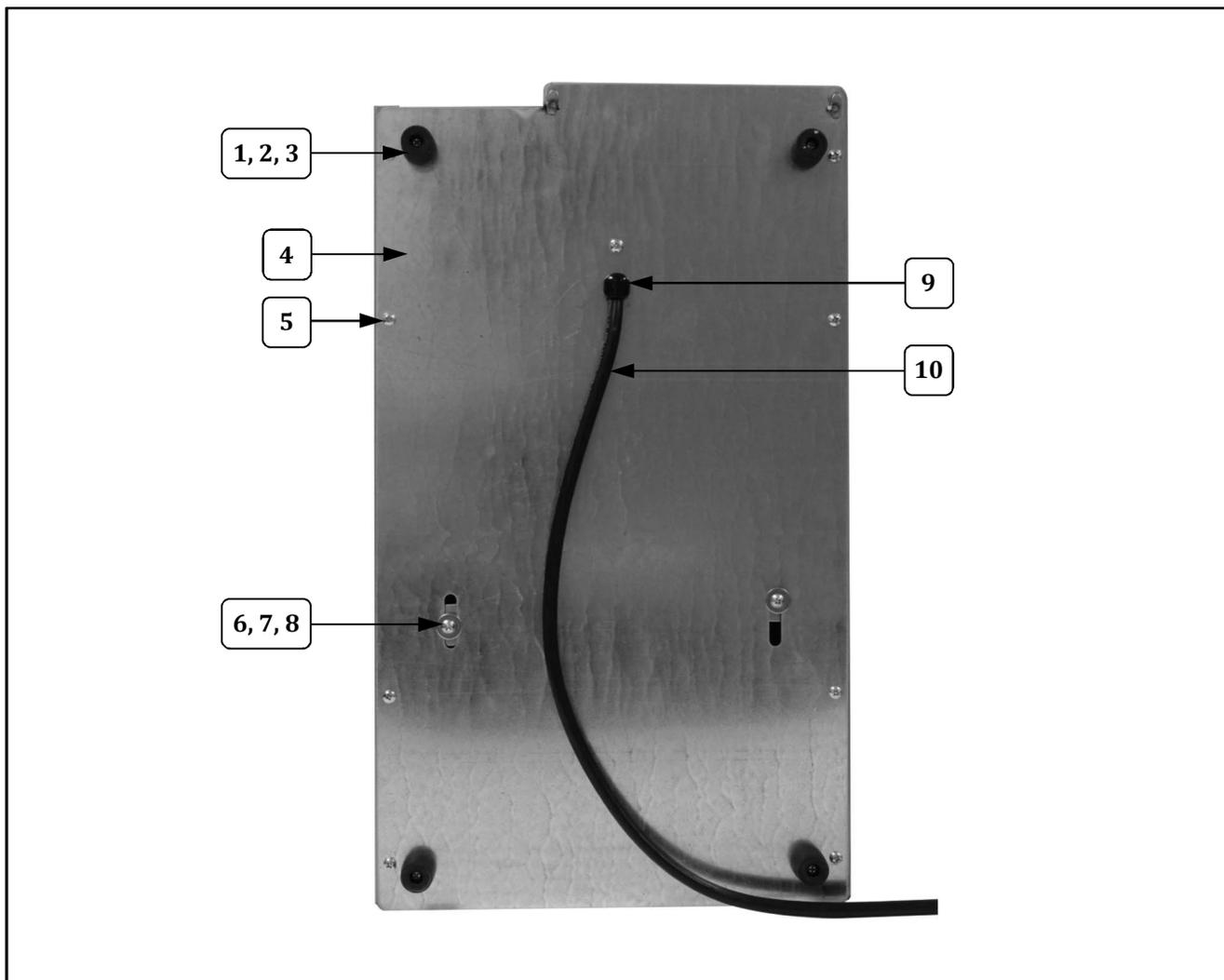

Item	Part Description	Qty.	Part No.
			2494
1	RUBBER FEET 3/4IN HIGH	4	47155
2	8-32 X 3/4 PHIL PAN M/S	4	39007
3	8-32 HEX M/S NUT	4	74149
4	BOTTOM PLATE WELD ASSY	1	39979
5	8-32 X 1/2 PH PAN T/S	8	87245
6	1/4-20 X 5/8 P/H PHIL	2	12472
7	1/4 FLAT WASHER ALUMINUM	2	10000
8	TINNERMAN NUT 1/4-20	2	42125
9	STRAIN RELIEF #SR-10-2	1	87163
10	LEAD-IN CORD 15 AMP PLUG	1	39982



Unit Exterior – Bottom View

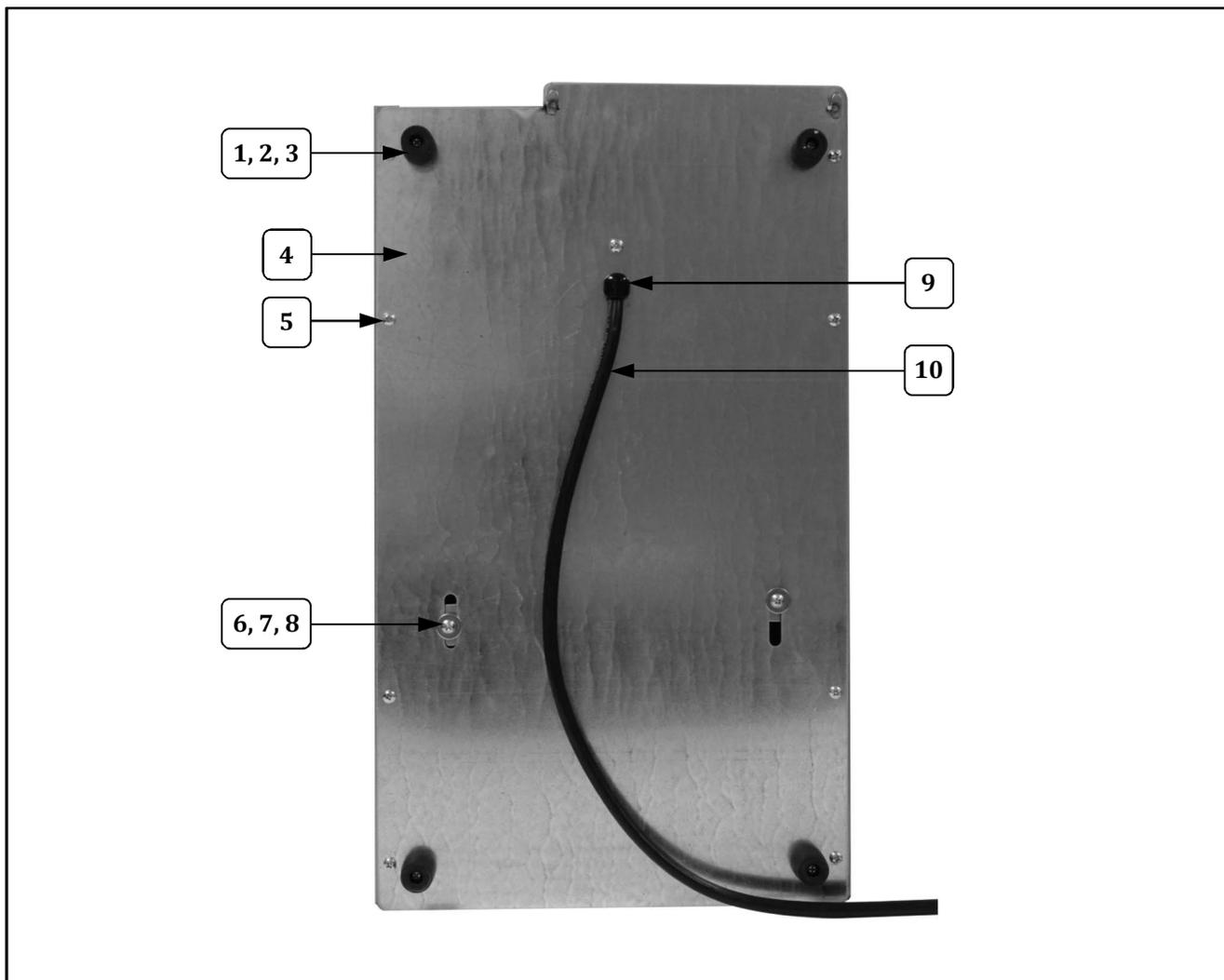

Item	Part Description	Qty.	Part No.
			2494
1	RUBBER FEET 3/4IN HIGH	4	47155
2	8-32 X 3/4 PHIL PAN M/S	4	39007
3	8-32 HEX M/S NUT	4	74149
4	BOTTOM PLATE WELD ASSY	1	39979
5	8-32 X 1/2 PH PAN T/S	8	87245
6	1/4-20 X 5/8 P/H PHIL	2	12472
7	1/4 FLAT WASHER ALUMINUM	2	10000
8	TINNERMAN NUT 1/4-20	2	42125
9	STRAIN RELIEF #SR-10-2	1	87163
10	LEAD-IN CORD 15 AMP PLUG	1	39982



Unit Exterior – Bottom View

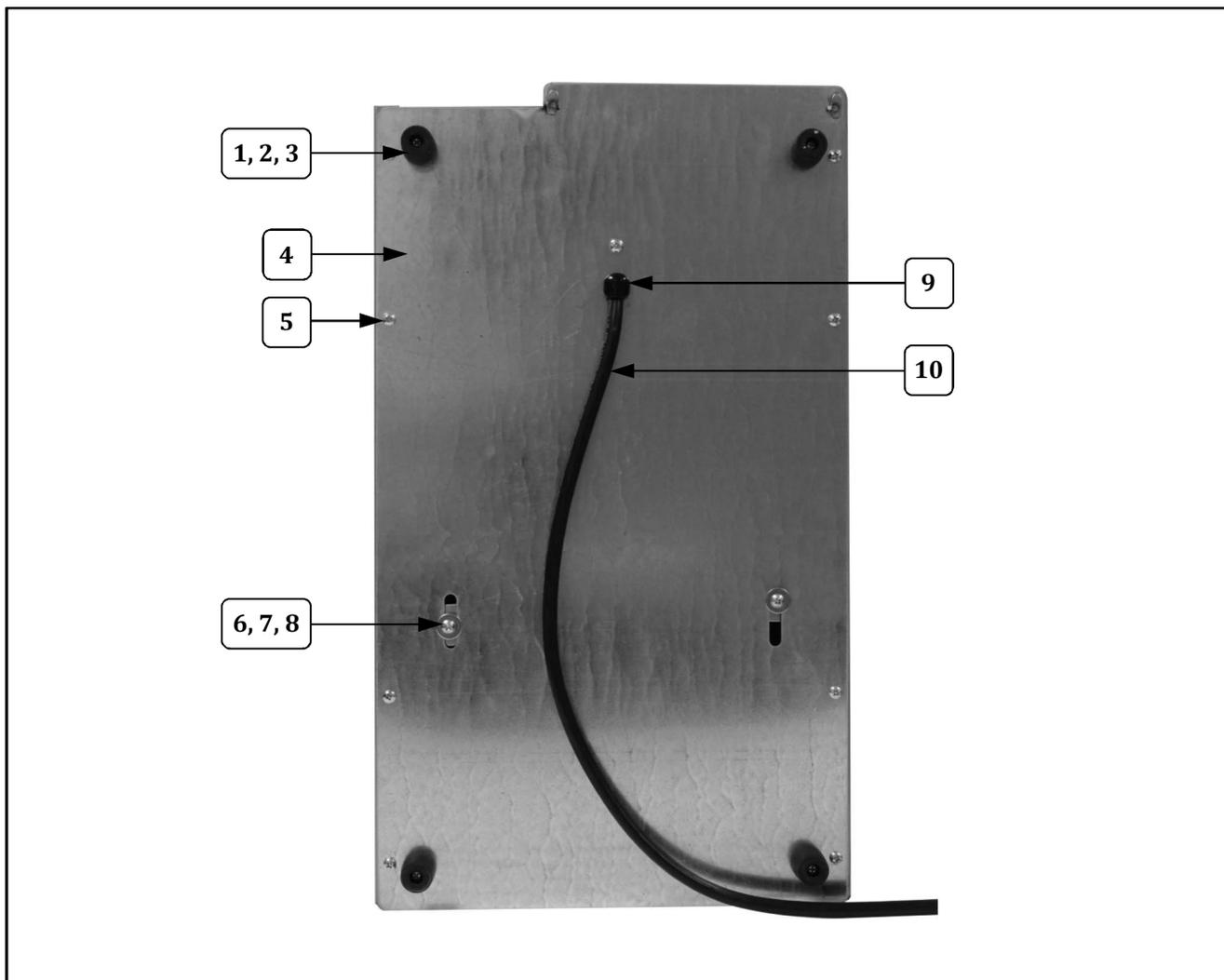

Item	Part Description	Qty.	Part No.
			2494
1	RUBBER FEET 3/4IN HIGH	4	47155
2	8-32 X 3/4 PHIL PAN M/S	4	39007
3	8-32 HEX M/S NUT	4	74149
4	BOTTOM PLATE WELD ASSY	1	39979
5	8-32 X 1/2 PH PAN T/S	8	87245
6	1/4-20 X 5/8 P/H PHIL	2	12472
7	1/4 FLAT WASHER ALUMINUM	2	10000
8	TINNERMAN NUT 1/4-20	2	42125
9	STRAIN RELIEF #SR-10-2	1	87163
10	LEAD-IN CORD 15 AMP PLUG	1	39982



Unit Exterior – Bottom View

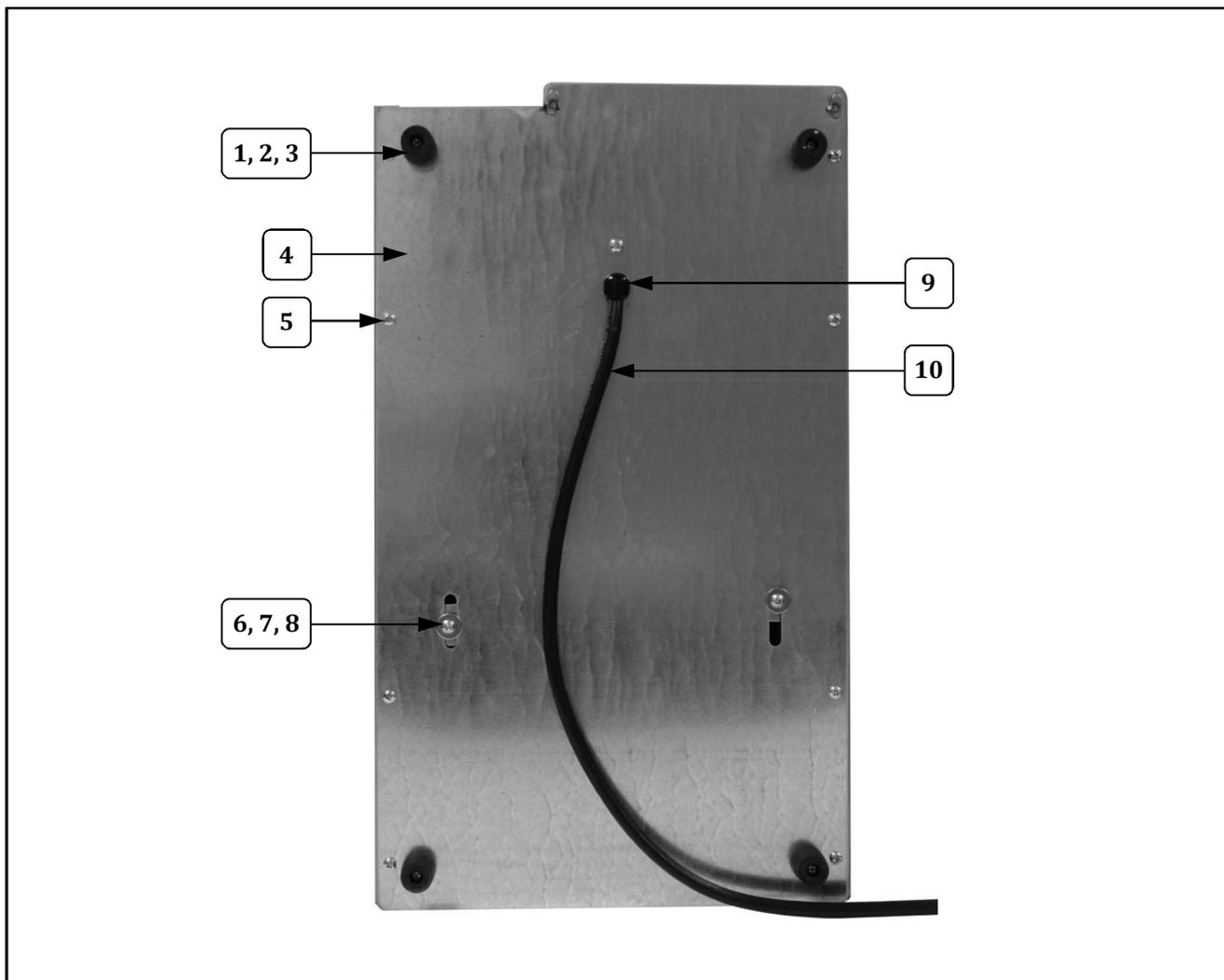

Item	Part Description	Qty.	Part No.
			2494
1	RUBBER FEET 3/4IN HIGH	4	47155
2	8-32 X 3/4 PHIL PAN M/S	4	39007
3	8-32 HEX M/S NUT	4	74149
4	BOTTOM PLATE WELD ASSY	1	39979
5	8-32 X 1/2 PH PAN T/S	8	87245
6	1/4-20 X 5/8 P/H PHIL	2	12472
7	1/4 FLAT WASHER ALUMINUM	2	10000
8	TINNERMAN NUT 1/4-20	2	42125
9	STRAIN RELIEF #SR-10-2	1	87163
10	LEAD-IN CORD 15 AMP PLUG	1	39982



Unit Exterior – Bottom View

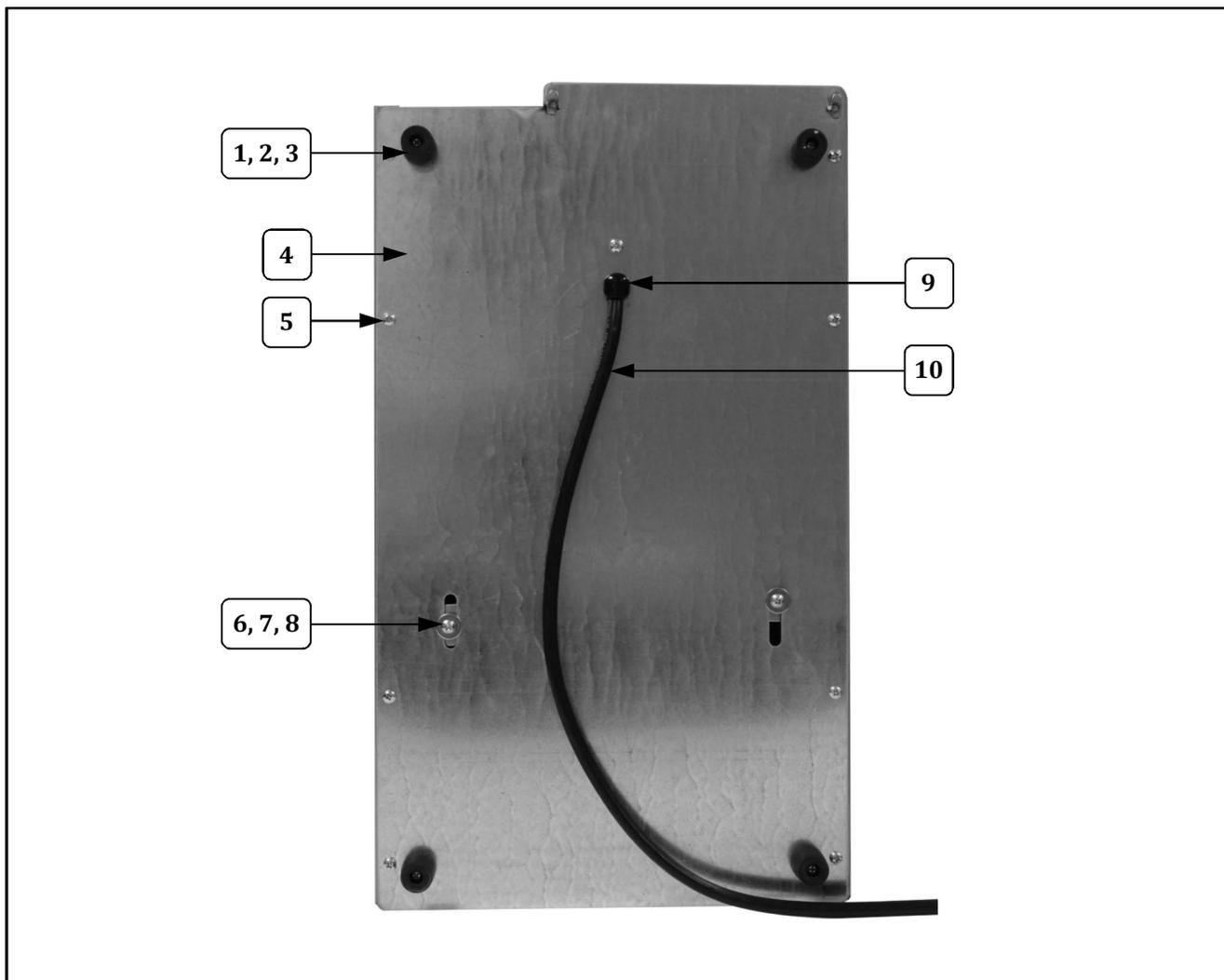

Item	Part Description	Qty.	Part No.
			2494
1	RUBBER FEET 3/4IN HIGH	4	47155
2	8-32 X 3/4 PHIL PAN M/S	4	39007
3	8-32 HEX M/S NUT	4	74149
4	BOTTOM PLATE WELD ASSY	1	39979
5	8-32 X 1/2 PH PAN T/S	8	87245
6	1/4-20 X 5/8 P/H PHIL	2	12472
7	1/4 FLAT WASHER ALUMINUM	2	10000
8	TINNERMAN NUT 1/4-20	2	42125
9	STRAIN RELIEF #SR-10-2	1	87163
10	LEAD-IN CORD 15 AMP PLUG	1	39982



Unit Exterior – Bottom View

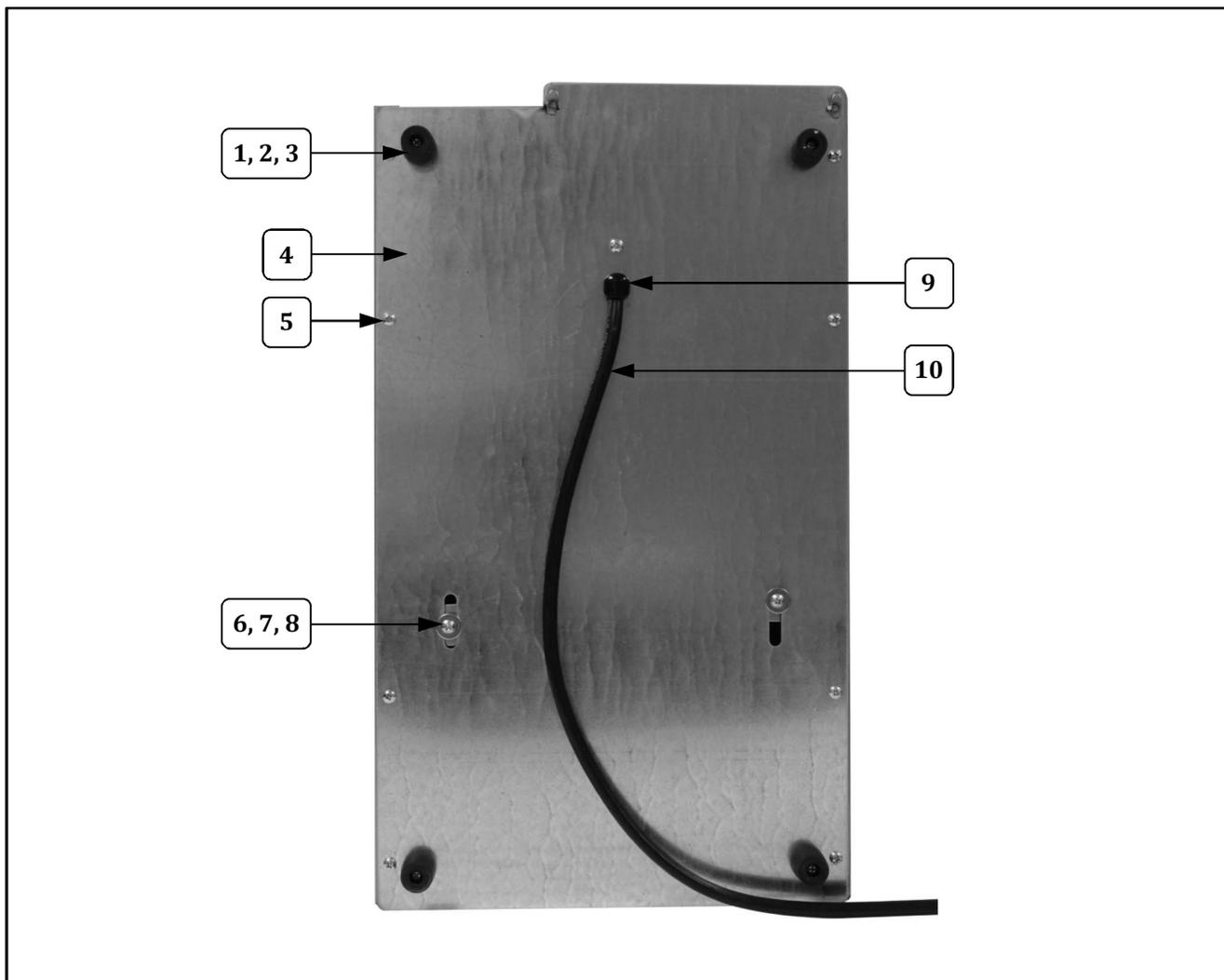

Item	Part Description	Qty.	Part No.
			2494
1	RUBBER FEET 3/4IN HIGH	4	47155
2	8-32 X 3/4 PHIL PAN M/S	4	39007
3	8-32 HEX M/S NUT	4	74149
4	BOTTOM PLATE WELD ASSY	1	39979
5	8-32 X 1/2 PH PAN T/S	8	87245
6	1/4-20 X 5/8 P/H PHIL	2	12472
7	1/4 FLAT WASHER ALUMINUM	2	10000
8	TINNERMAN NUT 1/4-20	2	42125
9	STRAIN RELIEF #SR-10-2	1	87163
10	LEAD-IN CORD 15 AMP PLUG	1	39982



Unit Exterior – Bottom View

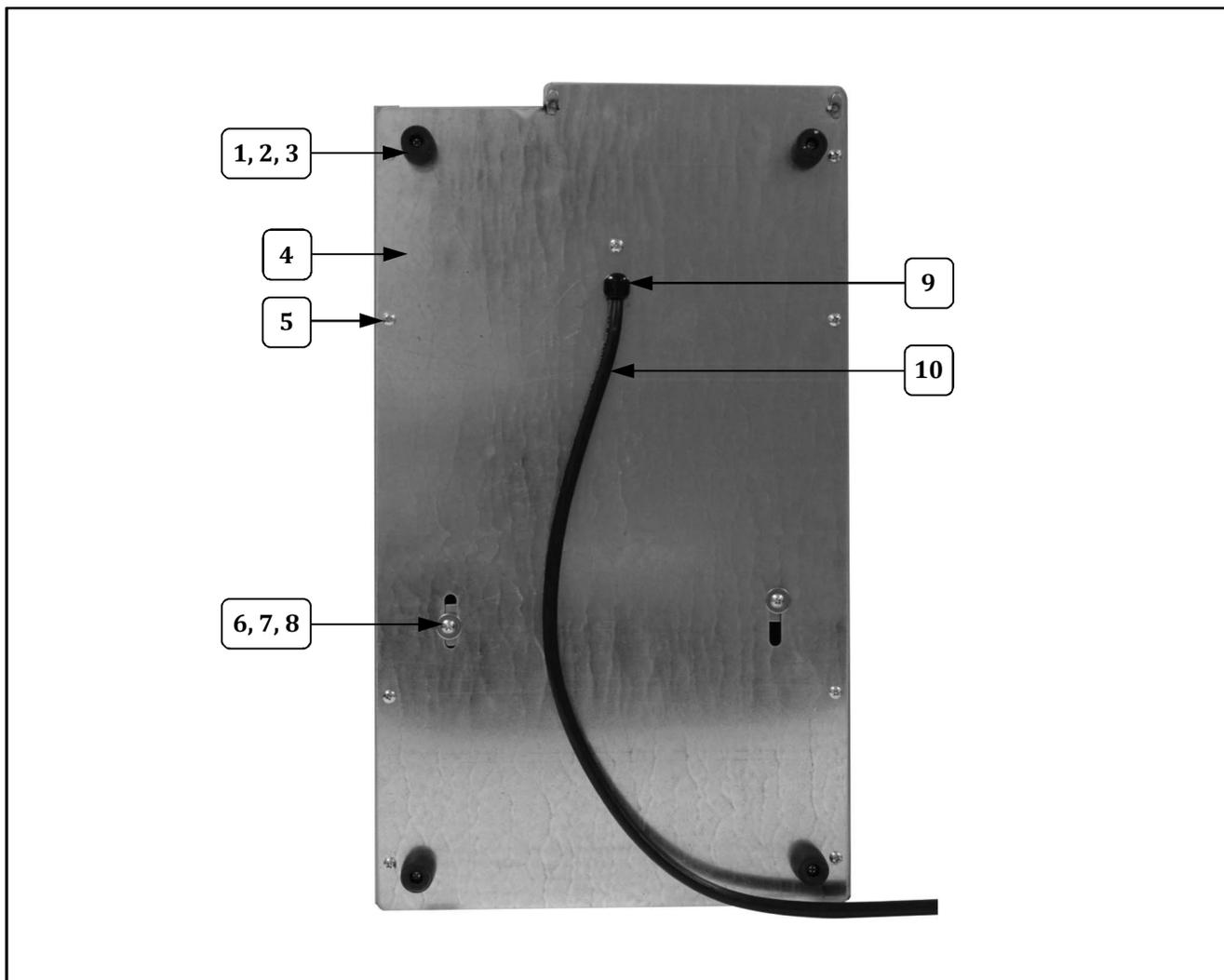

Item	Part Description	Qty.	Part No.
			2494
1	RUBBER FEET 3/4IN HIGH	4	47155
2	8-32 X 3/4 PHIL PAN M/S	4	39007
3	8-32 HEX M/S NUT	4	74149
4	BOTTOM PLATE WELD ASSY	1	39979
5	8-32 X 1/2 PH PAN T/S	8	87245
6	1/4-20 X 5/8 P/H PHIL	2	12472
7	1/4 FLAT WASHER ALUMINUM	2	10000
8	TINNERMAN NUT 1/4-20	2	42125
9	STRAIN RELIEF #SR-10-2	1	87163
10	LEAD-IN CORD 15 AMP PLUG	1	39982



Unit Exterior – Bottom View

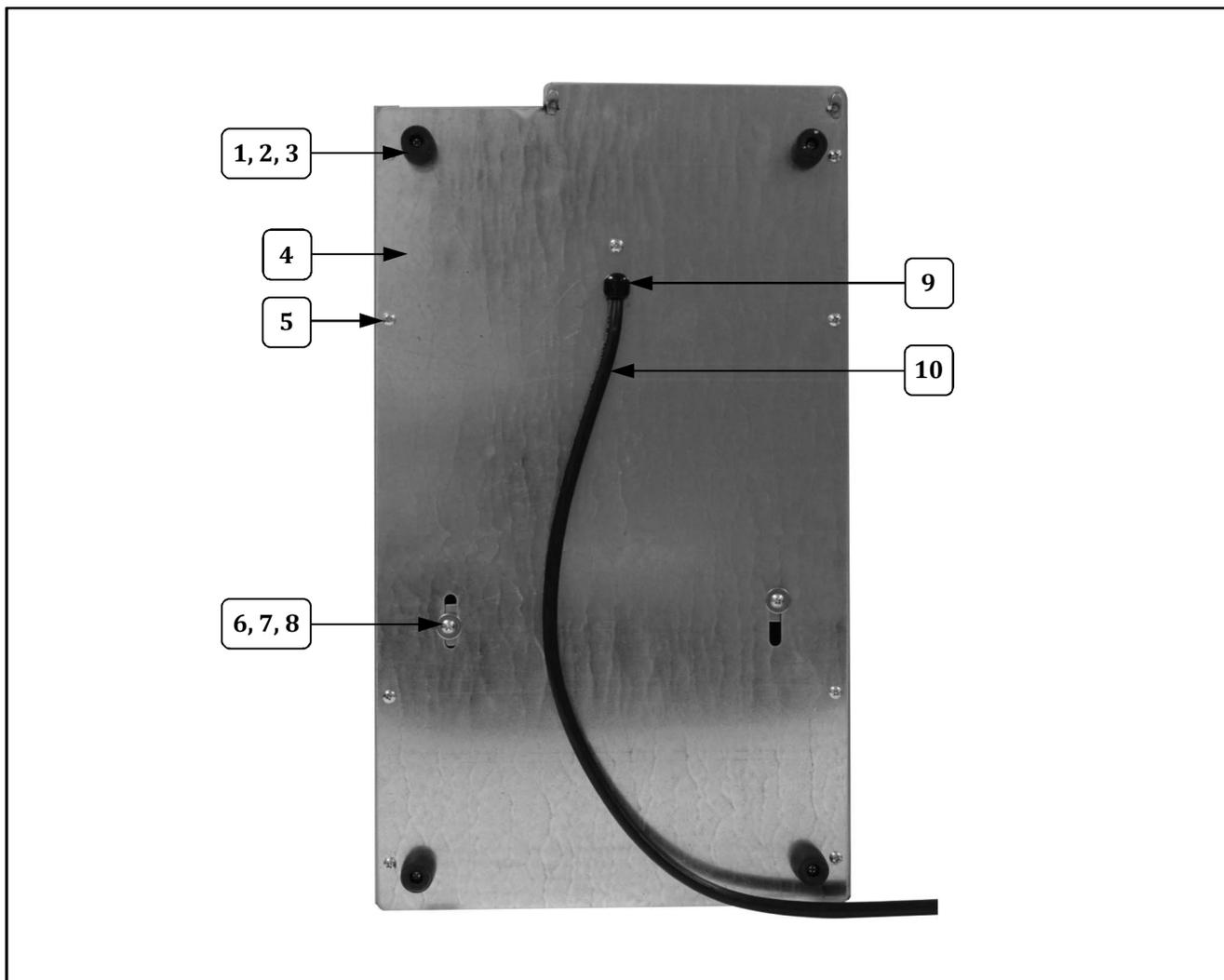

Item	Part Description	Qty.	Part No.
			2494
1	RUBBER FEET 3/4IN HIGH	4	47155
2	8-32 X 3/4 PHIL PAN M/S	4	39007
3	8-32 HEX M/S NUT	4	74149
4	BOTTOM PLATE WELD ASSY	1	39979
5	8-32 X 1/2 PH PAN T/S	8	87245
6	1/4-20 X 5/8 P/H PHIL	2	12472
7	1/4 FLAT WASHER ALUMINUM	2	10000
8	TINNERMAN NUT 1/4-20	2	42125
9	STRAIN RELIEF #SR-10-2	1	87163
10	LEAD-IN CORD 15 AMP PLUG	1	39982



Unit Interior – Pump View Parts List

Item	Part Description	Qty.	Part No.
			2494
1	SLIDING PUMP BLOCK	1	36031
2	PUMP CAM LOCK	1	36032
3	M5 SLOTTED SCREW - CAM	1	77125
4	PUMP PLATE	1	39953
5	FOOD TUBING (replacement tubing sold by the foot)		91375
6	PUMP COVER	1	39988
7	HOSE CLAMP 7/16`` - 1/2``	3	67843
8	TUBING CONNECTOR	1	39990
9	TUBING BRACKET (metal bracket)	1	39989
10	HEYCO/BREAK THROUGH PLUG	1	102008
11	PUMP HEAD ASSY 5 ROLLER	1	36105
12	THUMB SCREW PUMP MOUNT	1	77122
13	UNIVERSAL BAG CONNECTOR	1	79100G
14	SINGLE WIRE HOSE CLAMP	2	75110
15	PAN WELD ASSY	1	39973
16	FOIL ELEMENT 300W 120V	1	39949
17	SET COLLAR 5/16 ID 5/8 OD	1	46649



Unit Interior – Pump View Parts List

Item	Part Description	Qty.	Part No.
			2494
1	SLIDING PUMP BLOCK	1	36031
2	PUMP CAM LOCK	1	36032
3	M5 SLOTTED SCREW - CAM	1	77125
4	PUMP PLATE	1	39953
5	FOOD TUBING (replacement tubing sold by the foot)		91375
6	PUMP COVER	1	39988
7	HOSE CLAMP 7/16``- 1/2``	3	67843
8	TUBING CONNECTOR	1	39990
9	TUBING BRACKET (metal bracket)	1	39989
10	HEYCO/BREAK THROUGH PLUG	1	102008
11	PUMP HEAD ASSY 5 ROLLER	1	36105
12	THUMB SCREW PUMP MOUNT	1	77122
13	UNIVERSAL BAG CONNECTOR	1	79100G
14	SINGLE WIRE HOSE CLAMP	2	75110
15	PAN WELD ASSY	1	39973
16	FOIL ELEMENT 300W 120V	1	39949
17	SET COLLAR 5/16 ID 5/8 OD	1	46649



Unit Interior – Pump View Parts List

Item	Part Description	Qty.	Part No.
			2494
1	SLIDING PUMP BLOCK	1	36031
2	PUMP CAM LOCK	1	36032
3	M5 SLOTTED SCREW - CAM	1	77125
4	PUMP PLATE	1	39953
5	FOOD TUBING (replacement tubing sold by the foot)		91375
6	PUMP COVER	1	39988
7	HOSE CLAMP 7/16" - 1/2"	3	67843
8	TUBING CONNECTOR	1	39990
9	TUBING BRACKET (metal bracket)	1	39989
10	HEYCO/BREAK THROUGH PLUG	1	102008
11	PUMP HEAD ASSY 5 ROLLER	1	36105
12	THUMB SCREW PUMP MOUNT	1	77122
13	UNIVERSAL BAG CONNECTOR	1	79100G
14	SINGLE WIRE HOSE CLAMP	2	75110
15	PAN WELD ASSY	1	39973
16	FOIL ELEMENT 300W 120V	1	39949
17	SET COLLAR 5/16 ID 5/8 OD	1	46649



Unit Interior – Pump View Parts List

Item	Part Description	Qty.	Part No.
			2494
1	SLIDING PUMP BLOCK	1	36031
2	PUMP CAM LOCK	1	36032
3	M5 SLOTTED SCREW - CAM	1	77125
4	PUMP PLATE	1	39953
5	FOOD TUBING (replacement tubing sold by the foot)		91375
6	PUMP COVER	1	39988
7	HOSE CLAMP 7/16`` - 1/2``	3	67843
8	TUBING CONNECTOR	1	39990
9	TUBING BRACKET (metal bracket)	1	39989
10	HEYCO/BREAK THROUGH PLUG	1	102008
11	PUMP HEAD ASSY 5 ROLLER	1	36105
12	THUMB SCREW PUMP MOUNT	1	77122
13	UNIVERSAL BAG CONNECTOR	1	79100G
14	SINGLE WIRE HOSE CLAMP	2	75110
15	PAN WELD ASSY	1	39973
16	FOIL ELEMENT 300W 120V	1	39949
17	SET COLLAR 5/16 ID 5/8 OD	1	46649



Unit Interior – Pump View Parts List

Item	Part Description	Qty.	Part No.
			2494
1	SLIDING PUMP BLOCK	1	36031
2	PUMP CAM LOCK	1	36032
3	M5 SLOTTED SCREW - CAM	1	77125
4	PUMP PLATE	1	39953
5	FOOD TUBING (replacement tubing sold by the foot)		91375
6	PUMP COVER	1	39988
7	HOSE CLAMP 7/16`` - 1/2``	3	67843
8	TUBING CONNECTOR	1	39990
9	TUBING BRACKET (metal bracket)	1	39989
10	HEYCO/BREAK THROUGH PLUG	1	102008
11	PUMP HEAD ASSY 5 ROLLER	1	36105
12	THUMB SCREW PUMP MOUNT	1	77122
13	UNIVERSAL BAG CONNECTOR	1	79100G
14	SINGLE WIRE HOSE CLAMP	2	75110
15	PAN WELD ASSY	1	39973
16	FOIL ELEMENT 300W 120V	1	39949
17	SET COLLAR 5/16 ID 5/8 OD	1	46649



Unit Interior – Pump View Parts List

Item	Part Description	Qty.	Part No.
			2494
1	SLIDING PUMP BLOCK	1	36031
2	PUMP CAM LOCK	1	36032
3	M5 SLOTTED SCREW - CAM	1	77125
4	PUMP PLATE	1	39953
5	FOOD TUBING (replacement tubing sold by the foot)		91375
6	PUMP COVER	1	39988
7	HOSE CLAMP 7/16`` - 1/2``	3	67843
8	TUBING CONNECTOR	1	39990
9	TUBING BRACKET (metal bracket)	1	39989
10	HEYCO/BREAK THROUGH PLUG	1	102008
11	PUMP HEAD ASSY 5 ROLLER	1	36105
12	THUMB SCREW PUMP MOUNT	1	77122
13	UNIVERSAL BAG CONNECTOR	1	79100G
14	SINGLE WIRE HOSE CLAMP	2	75110
15	PAN WELD ASSY	1	39973
16	FOIL ELEMENT 300W 120V	1	39949
17	SET COLLAR 5/16 ID 5/8 OD	1	46649



Unit Interior – Pump View Parts List

Item	Part Description	Qty.	Part No.
			2494
1	SLIDING PUMP BLOCK	1	36031
2	PUMP CAM LOCK	1	36032
3	M5 SLOTTED SCREW - CAM	1	77125
4	PUMP PLATE	1	39953
5	FOOD TUBING (replacement tubing sold by the foot)		91375
6	PUMP COVER	1	39988
7	HOSE CLAMP 7/16`` - 1/2``	3	67843
8	TUBING CONNECTOR	1	39990
9	TUBING BRACKET (metal bracket)	1	39989
10	HEYCO/BREAK THROUGH PLUG	1	102008
11	PUMP HEAD ASSY 5 ROLLER	1	36105
12	THUMB SCREW PUMP MOUNT	1	77122
13	UNIVERSAL BAG CONNECTOR	1	79100G
14	SINGLE WIRE HOSE CLAMP	2	75110
15	PAN WELD ASSY	1	39973
16	FOIL ELEMENT 300W 120V	1	39949
17	SET COLLAR 5/16 ID 5/8 OD	1	46649



Unit Interior – Pump View Parts List

Item	Part Description	Qty.	Part No.
			2494
1	SLIDING PUMP BLOCK	1	36031
2	PUMP CAM LOCK	1	36032
3	M5 SLOTTED SCREW - CAM	1	77125
4	PUMP PLATE	1	39953
5	FOOD TUBING (replacement tubing sold by the foot)		91375
6	PUMP COVER	1	39988
7	HOSE CLAMP 7/16``- 1/2``	3	67843
8	TUBING CONNECTOR	1	39990
9	TUBING BRACKET (metal bracket)	1	39989
10	HEYCO/BREAK THROUGH PLUG	1	102008
11	PUMP HEAD ASSY 5 ROLLER	1	36105
12	THUMB SCREW PUMP MOUNT	1	77122
13	UNIVERSAL BAG CONNECTOR	1	79100G
14	SINGLE WIRE HOSE CLAMP	2	75110
15	PAN WELD ASSY	1	39973
16	FOIL ELEMENT 300W 120V	1	39949
17	SET COLLAR 5/16 ID 5/8 OD	1	46649



Unit Interior – Pump View Parts List

Item	Part Description	Qty.	Part No.
			2494
1	SLIDING PUMP BLOCK	1	36031
2	PUMP CAM LOCK	1	36032
3	M5 SLOTTED SCREW - CAM	1	77125
4	PUMP PLATE	1	39953
5	FOOD TUBING (replacement tubing sold by the foot)		91375
6	PUMP COVER	1	39988
7	HOSE CLAMP 7/16`` - 1/2``	3	67843
8	TUBING CONNECTOR	1	39990
9	TUBING BRACKET (metal bracket)	1	39989
10	HEYCO/BREAK THROUGH PLUG	1	102008
11	PUMP HEAD ASSY 5 ROLLER	1	36105
12	THUMB SCREW PUMP MOUNT	1	77122
13	UNIVERSAL BAG CONNECTOR	1	79100G
14	SINGLE WIRE HOSE CLAMP	2	75110
15	PAN WELD ASSY	1	39973
16	FOIL ELEMENT 300W 120V	1	39949
17	SET COLLAR 5/16 ID 5/8 OD	1	46649



Unit Interior – Pump View Parts List

Item	Part Description	Qty.	Part No.
			2494
1	SLIDING PUMP BLOCK	1	36031
2	PUMP CAM LOCK	1	36032
3	M5 SLOTTED SCREW - CAM	1	77125
4	PUMP PLATE	1	39953
5	FOOD TUBING (replacement tubing sold by the foot)		91375
6	PUMP COVER	1	39988
7	HOSE CLAMP 7/16`` - 1/2``	3	67843
8	TUBING CONNECTOR	1	39990
9	TUBING BRACKET (metal bracket)	1	39989
10	HEYCO/BREAK THROUGH PLUG	1	102008
11	PUMP HEAD ASSY 5 ROLLER	1	36105
12	THUMB SCREW PUMP MOUNT	1	77122
13	UNIVERSAL BAG CONNECTOR	1	79100G
14	SINGLE WIRE HOSE CLAMP	2	75110
15	PAN WELD ASSY	1	39973
16	FOIL ELEMENT 300W 120V	1	39949
17	SET COLLAR 5/16 ID 5/8 OD	1	46649



Unit Interior – Pump View Parts List

Item	Part Description	Qty.	Part No.
			2494
1	SLIDING PUMP BLOCK	1	36031
2	PUMP CAM LOCK	1	36032
3	M5 SLOTTED SCREW - CAM	1	77125
4	PUMP PLATE	1	39953
5	FOOD TUBING (replacement tubing sold by the foot)		91375
6	PUMP COVER	1	39988
7	HOSE CLAMP 7/16`` - 1/2``	3	67843
8	TUBING CONNECTOR	1	39990
9	TUBING BRACKET (metal bracket)	1	39989
10	HEYCO/BREAK THROUGH PLUG	1	102008
11	PUMP HEAD ASSY 5 ROLLER	1	36105
12	THUMB SCREW PUMP MOUNT	1	77122
13	UNIVERSAL BAG CONNECTOR	1	79100G
14	SINGLE WIRE HOSE CLAMP	2	75110
15	PAN WELD ASSY	1	39973
16	FOIL ELEMENT 300W 120V	1	39949
17	SET COLLAR 5/16 ID 5/8 OD	1	46649



Unit Interior – Pump View Parts List

Item	Part Description	Qty.	Part No.
			2494
1	SLIDING PUMP BLOCK	1	36031
2	PUMP CAM LOCK	1	36032
3	M5 SLOTTED SCREW - CAM	1	77125
4	PUMP PLATE	1	39953
5	FOOD TUBING (replacement tubing sold by the foot)		91375
6	PUMP COVER	1	39988
7	HOSE CLAMP 7/16`` - 1/2``	3	67843
8	TUBING CONNECTOR	1	39990
9	TUBING BRACKET (metal bracket)	1	39989
10	HEYCO/BREAK THROUGH PLUG	1	102008
11	PUMP HEAD ASSY 5 ROLLER	1	36105
12	THUMB SCREW PUMP MOUNT	1	77122
13	UNIVERSAL BAG CONNECTOR	1	79100G
14	SINGLE WIRE HOSE CLAMP	2	75110
15	PAN WELD ASSY	1	39973
16	FOIL ELEMENT 300W 120V	1	39949
17	SET COLLAR 5/16 ID 5/8 OD	1	46649

Unit Interior – Pedestal View

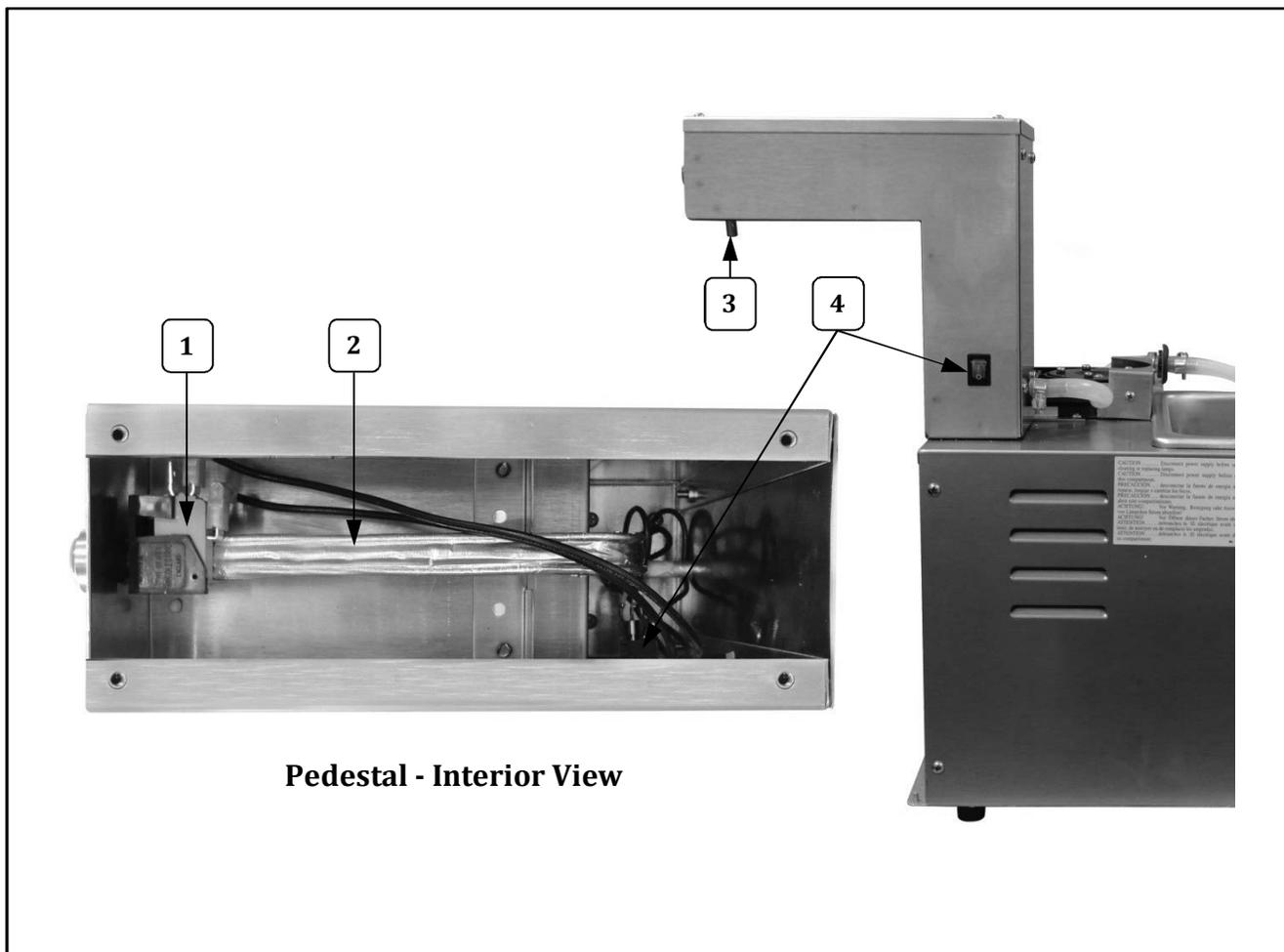

Pedestal - Interior View

Item	Part Description	Qty.	Part No.
			2494
1	MOMENTARY SWITCH	1	38971
2	FOIL HEAT ELEMENT 5W 120V	1	39948
3	SPOUT	1	39957
4	SWITCH, DPST ROCKER	1	42532



Unit Interior – Pedestal View

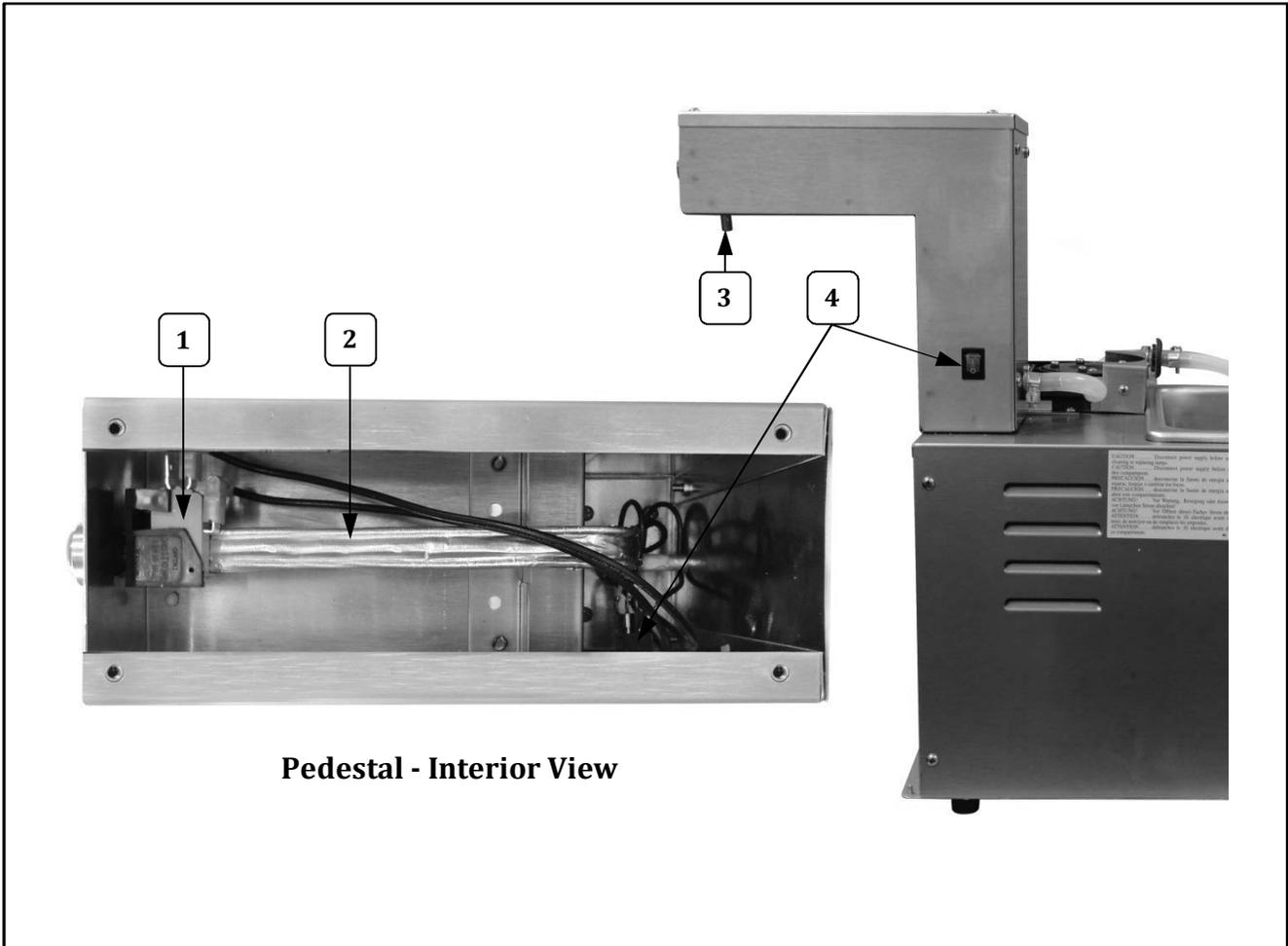

Pedestal - Interior View

Item	Part Description	Qty.	Part No.
			2494
1	MOMENTARY SWITCH	1	38971
2	FOIL HEAT ELEMENT 5W 120V	1	39948
3	SPOUT	1	39957
4	SWITCH, DPST ROCKER	1	42532

Unit Interior – Pedestal View

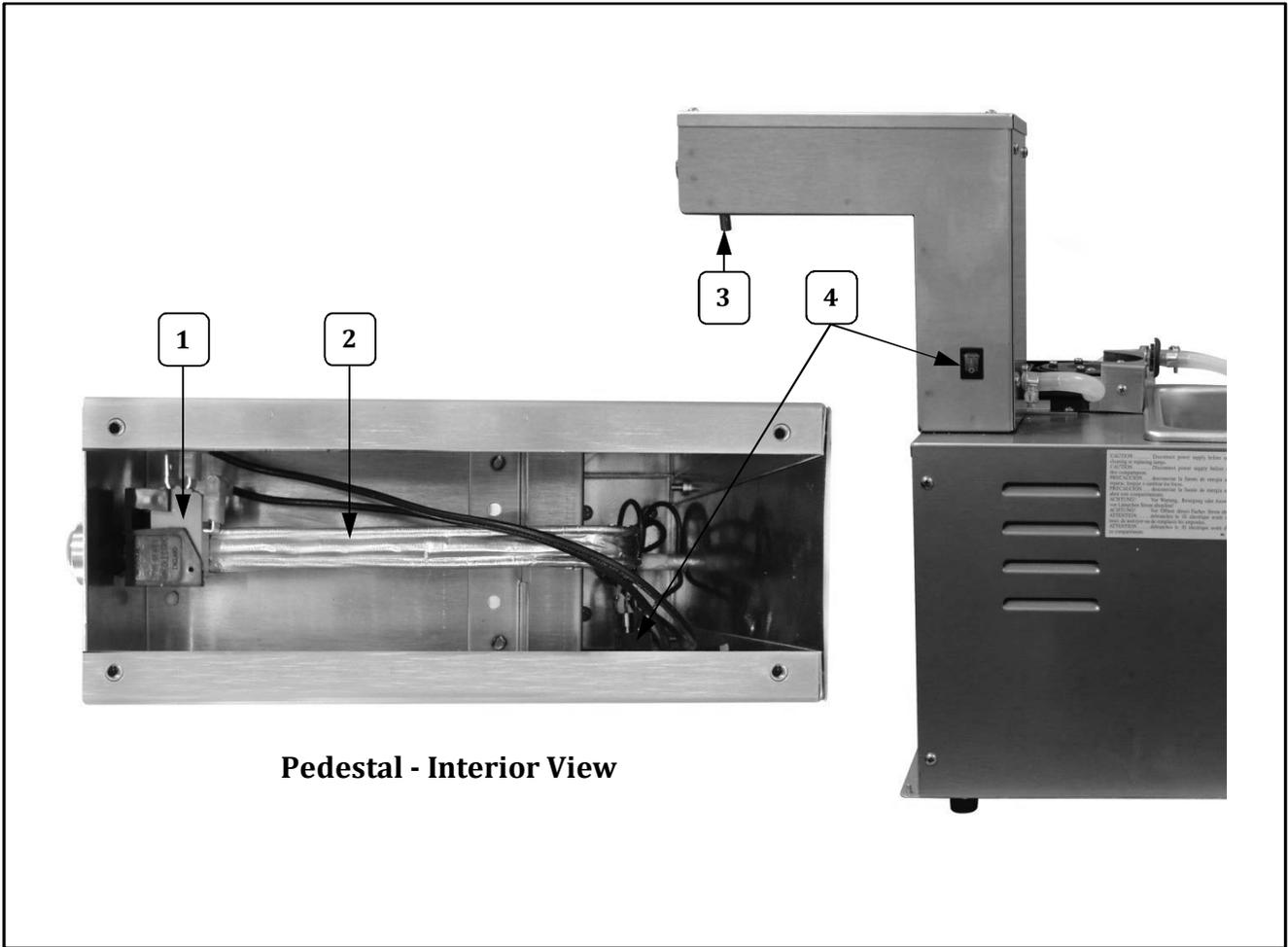

Pedestal - Interior View

Item	Part Description	Qty.	Part No.
			2494
1	MOMENTARY SWITCH	1	38971
2	FOIL HEAT ELEMENT 5W 120V	1	39948
3	SPOUT	1	39957
4	SWITCH, DPST ROCKER	1	42532



Control Panel - Interior and Lighting View

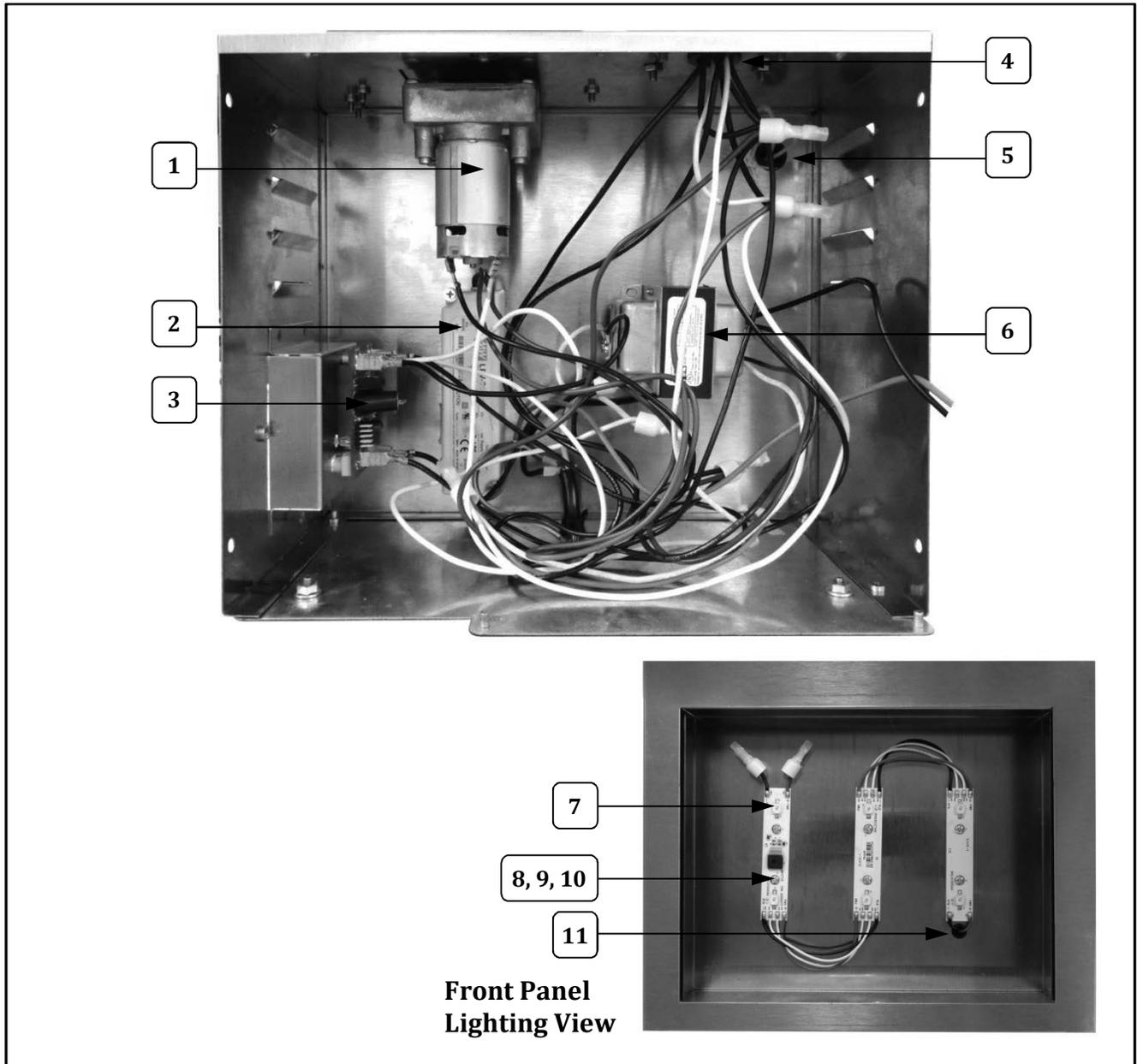

Item	Part Description	Qty.	Part No.
			2494
1	MOTOR 24 V DC	1	36043
2	POWER SUPPLY 24VDC 20W	1	55394
3	DISPENSER CONTROL BOARD	1	39976
4	BUSHING, SNAP .875 IN	1	45396
5	BUSHING, SNAP .625 IN	1	47282
6	TRANSFORMER, 12/24 VOLT	1	39459
7	3 LED MODULES	3	55349-3
8	6-32 X 3/8 PHIL PAN M/S	6	39000
9	#6 INT. TOOTH L/W 410SS	6	39001
10	6-32 M/S NUT 18-8	6	14221
11	BUSHING, SNAP .500 IN	1	47236



Control Panel - Interior and Lighting View

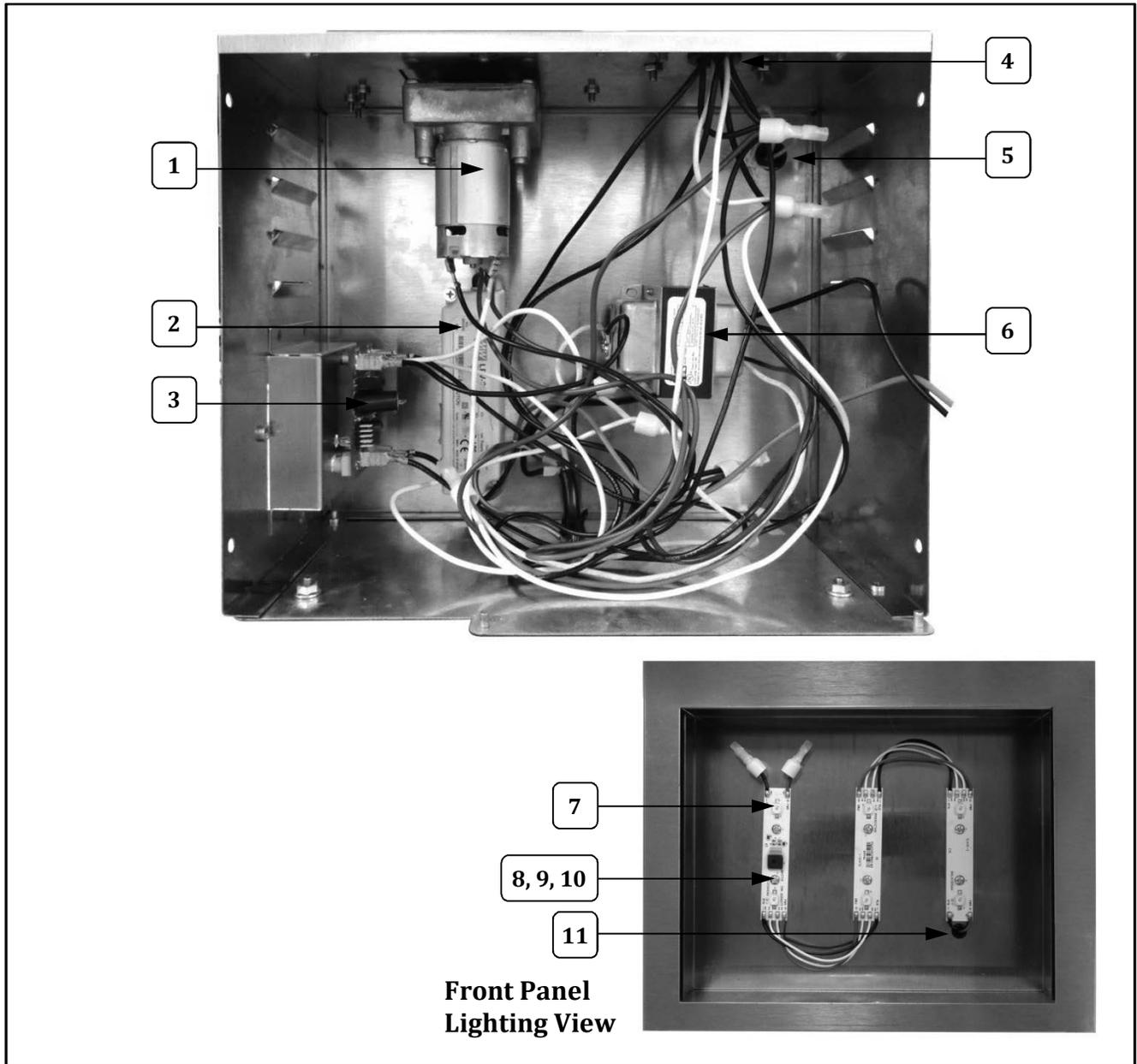

Item	Part Description	Qty.	Part No.
			2494
1	MOTOR 24 V DC	1	36043
2	POWER SUPPLY 24VDC 20W	1	55394
3	DISPENSER CONTROL BOARD	1	39976
4	BUSHING, SNAP .875 IN	1	45396
5	BUSHING, SNAP .625 IN	1	47282
6	TRANSFORMER, 12/24 VOLT	1	39459
7	3 LED MODULES	3	55349-3
8	6-32 X 3/8 PHIL PAN M/S	6	39000
9	#6 INT. TOOTH L/W 410SS	6	39001
10	6-32 M/S NUT 18-8	6	14221
11	BUSHING, SNAP .500 IN	1	47236



Control Panel - Interior and Lighting View

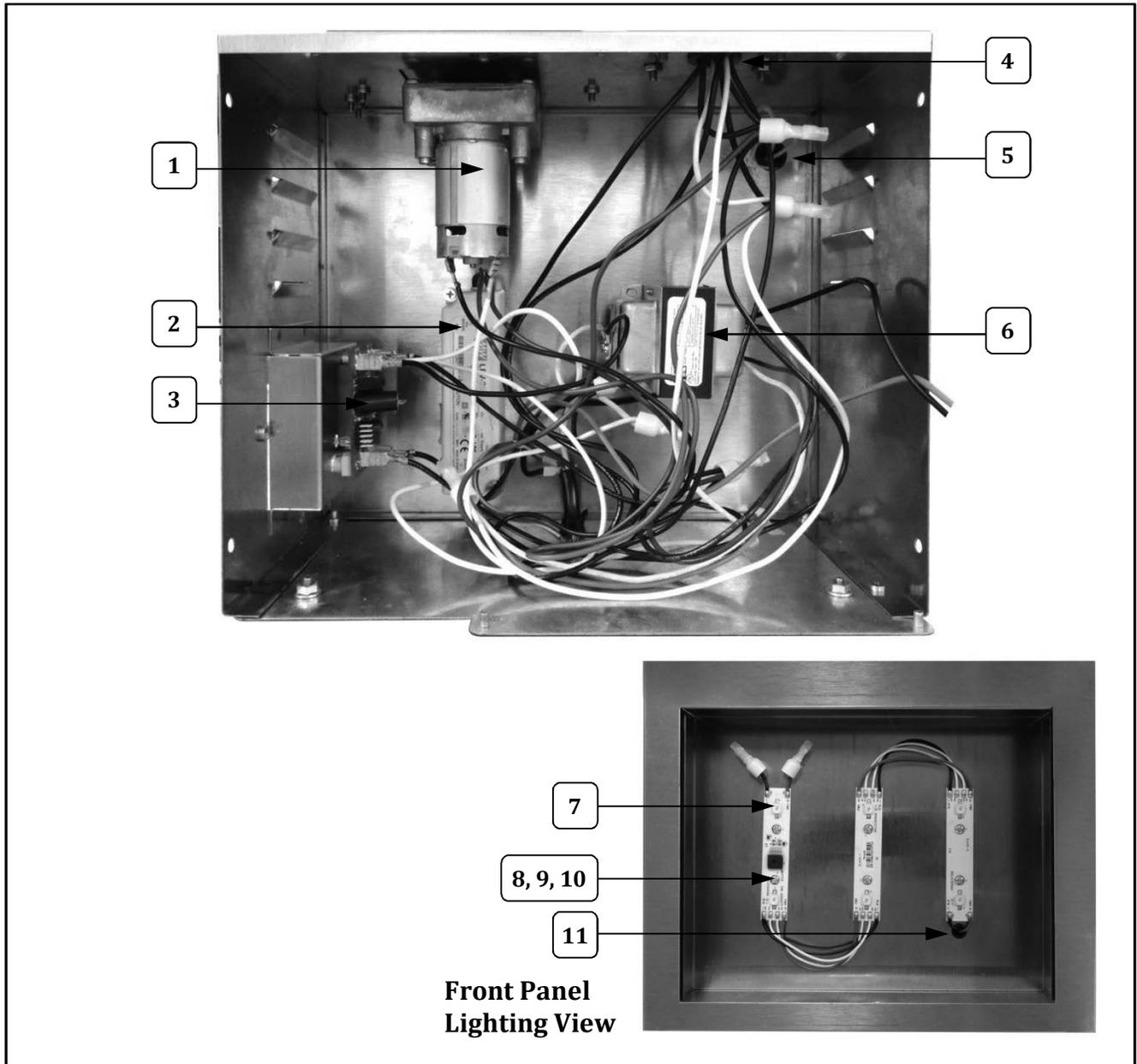

Item	Part Description	Qty.	Part No.
			2494
1	MOTOR 24 V DC	1	36043
2	POWER SUPPLY 24VDC 20W	1	55394
3	DISPENSER CONTROL BOARD	1	39976
4	BUSHING, SNAP .875 IN	1	45396
5	BUSHING, SNAP .625 IN	1	47282
6	TRANSFORMER, 12/24 VOLT	1	39459
7	3 LED MODULES	3	55349-3
8	6-32 X 3/8 PHIL PAN M/S	6	39000
9	#6 INT. TOOTH L/W 410SS	6	39001
10	6-32 M/S NUT 18-8	6	14221
11	BUSHING, SNAP .500 IN	1	47236



Control Panel - Interior and Lighting View

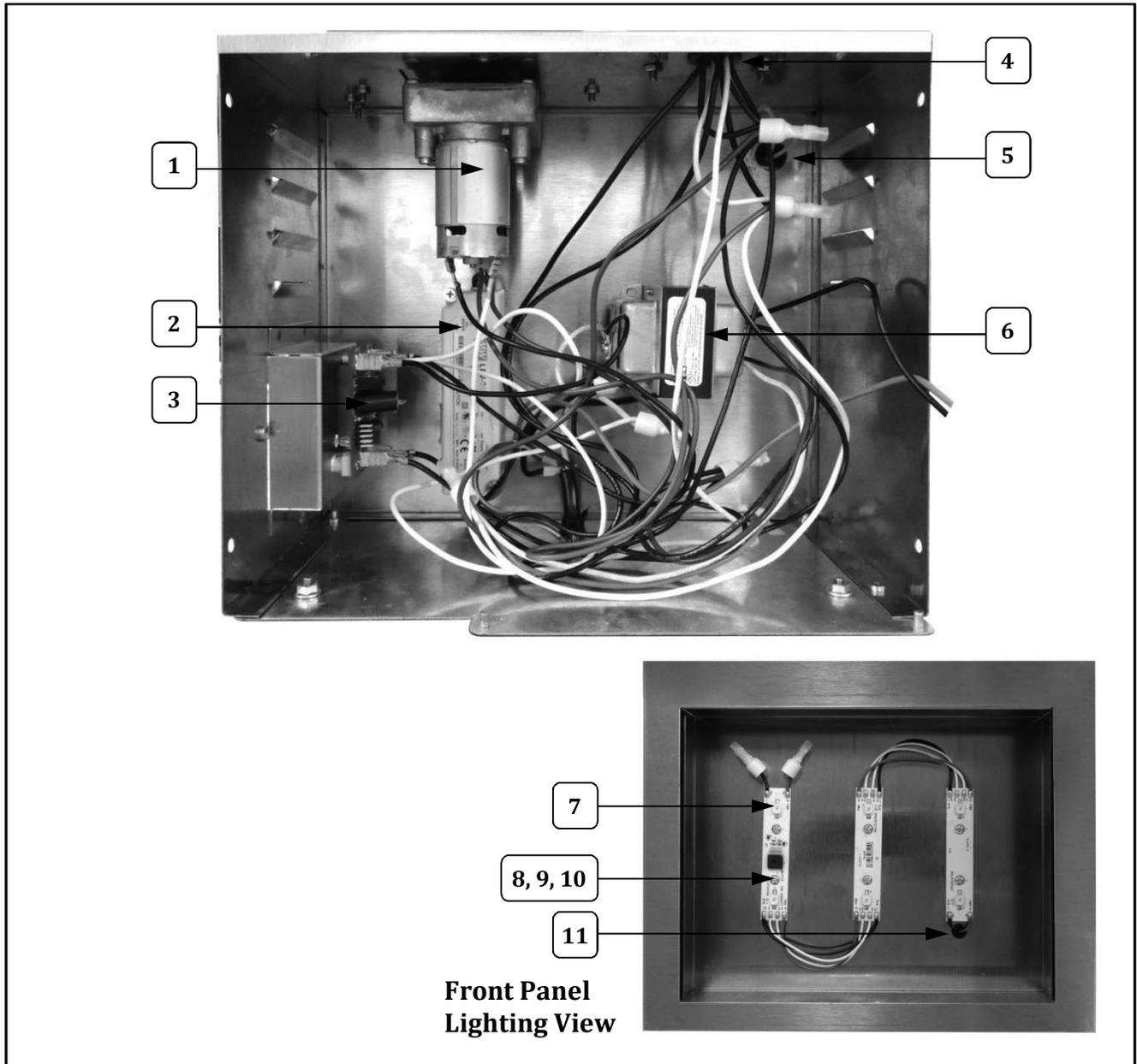

Item	Part Description	Qty.	Part No.
			2494
1	MOTOR 24 V DC	1	36043
2	POWER SUPPLY 24VDC 20W	1	55394
3	DISPENSER CONTROL BOARD	1	39976
4	BUSHING, SNAP .875 IN	1	45396
5	BUSHING, SNAP .625 IN	1	47282
6	TRANSFORMER, 12/24 VOLT	1	39459
7	3 LED MODULES	3	55349-3
8	6-32 X 3/8 PHIL PAN M/S	6	39000
9	#6 INT. TOOTH L/W 410SS	6	39001
10	6-32 M/S NUT 18-8	6	14221
11	BUSHING, SNAP .500 IN	1	47236



Control Panel - Interior and Lighting View

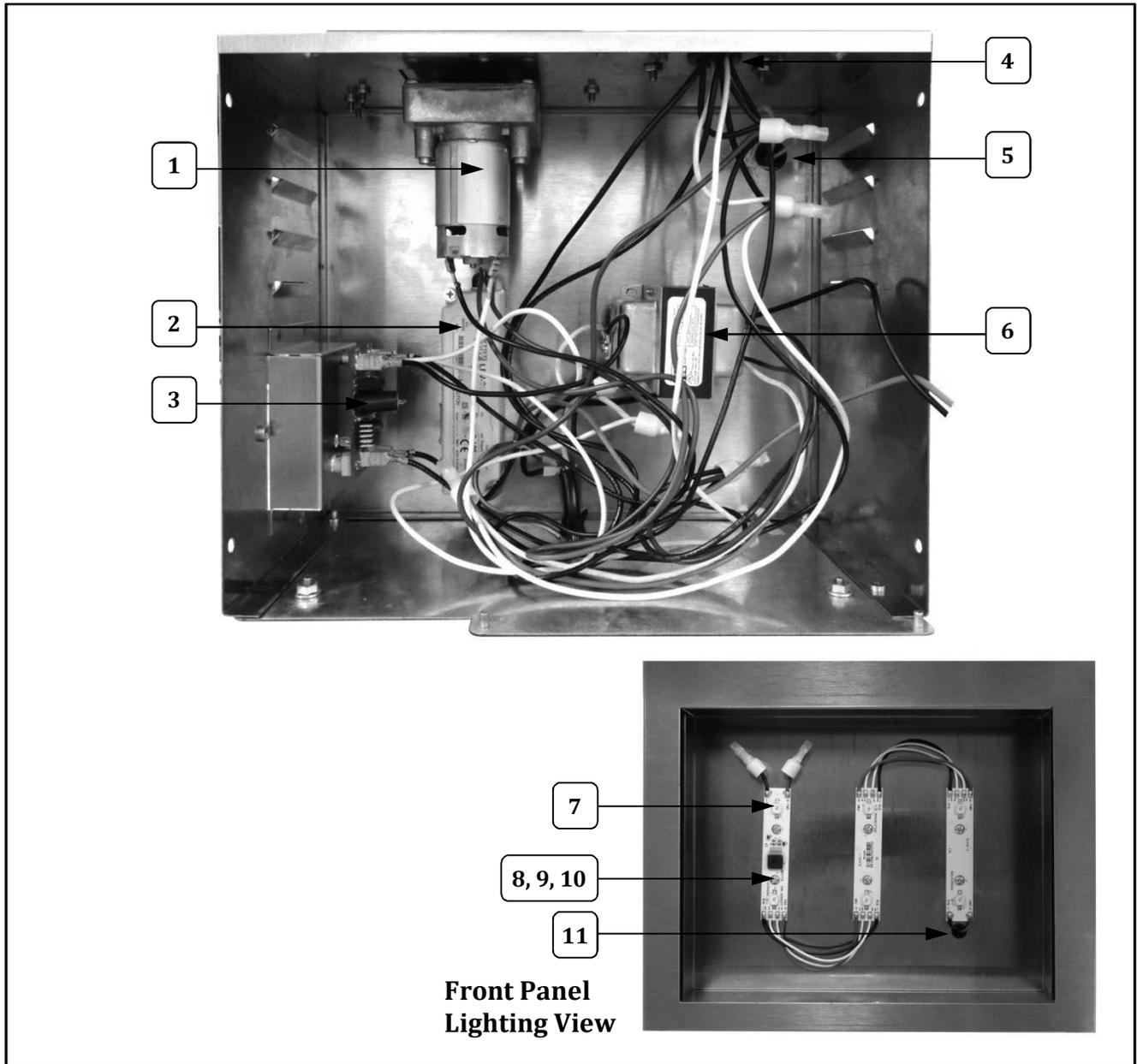

Item	Part Description	Qty.	Part No.
			2494
1	MOTOR 24 V DC	1	36043
2	POWER SUPPLY 24VDC 20W	1	55394
3	DISPENSER CONTROL BOARD	1	39976
4	BUSHING, SNAP .875 IN	1	45396
5	BUSHING, SNAP .625 IN	1	47282
6	TRANSFORMER, 12/24 VOLT	1	39459
7	3 LED MODULES	3	55349-3
8	6-32 X 3/8 PHIL PAN M/S	6	39000
9	#6 INT. TOOTH L/W 410SS	6	39001
10	6-32 M/S NUT 18-8	6	14221
11	BUSHING, SNAP .500 IN	1	47236



Control Panel - Interior and Lighting View

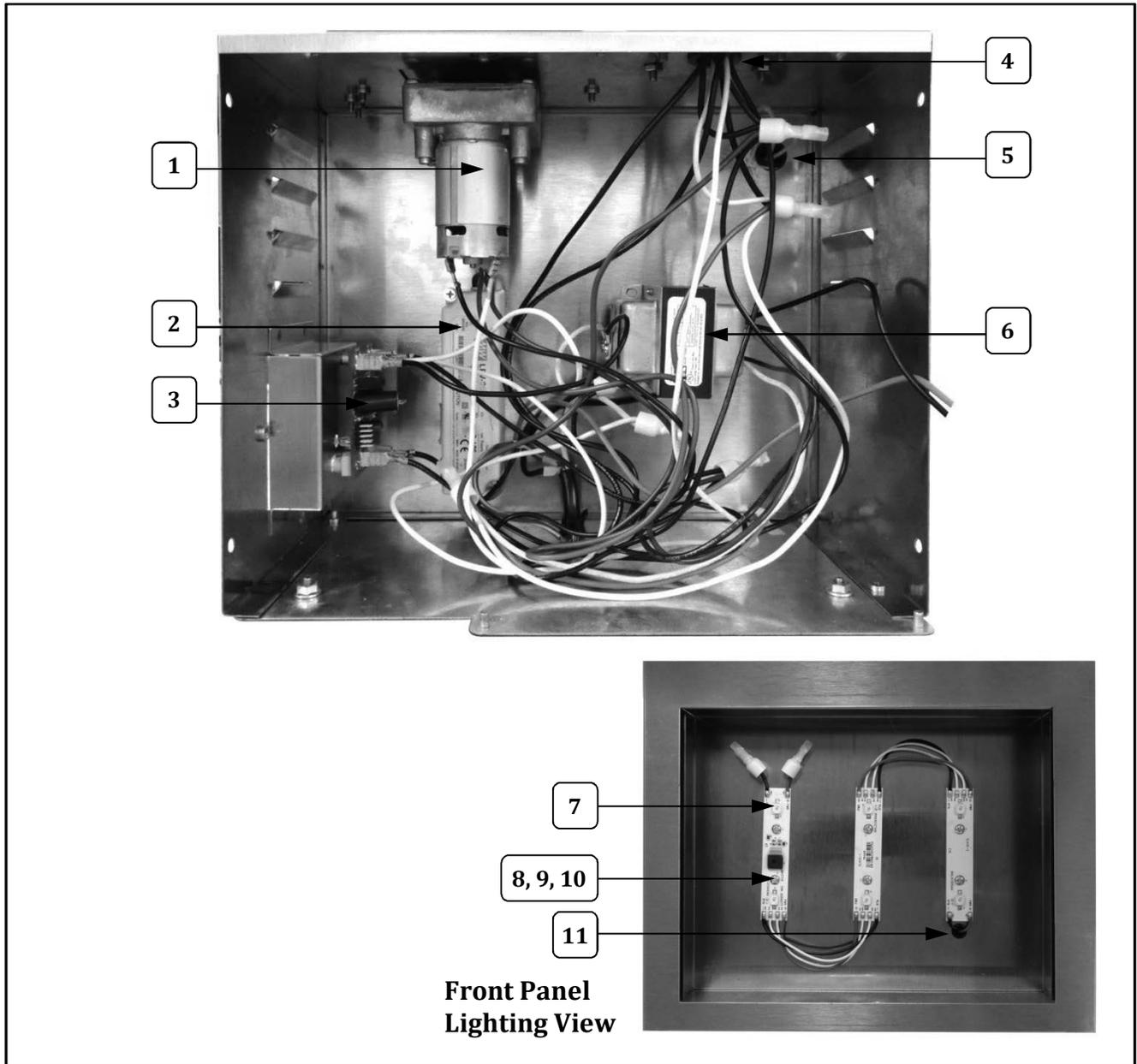

Item	Part Description	Qty.	Part No.
			2494
1	MOTOR 24 V DC	1	36043
2	POWER SUPPLY 24VDC 20W	1	55394
3	DISPENSER CONTROL BOARD	1	39976
4	BUSHING, SNAP .875 IN	1	45396
5	BUSHING, SNAP .625 IN	1	47282
6	TRANSFORMER, 12/24 VOLT	1	39459
7	3 LED MODULES	3	55349-3
8	6-32 X 3/8 PHIL PAN M/S	6	39000
9	#6 INT. TOOTH L/W 410SS	6	39001
10	6-32 M/S NUT 18-8	6	14221
11	BUSHING, SNAP .500 IN	1	47236



Control Panel - Interior and Lighting View

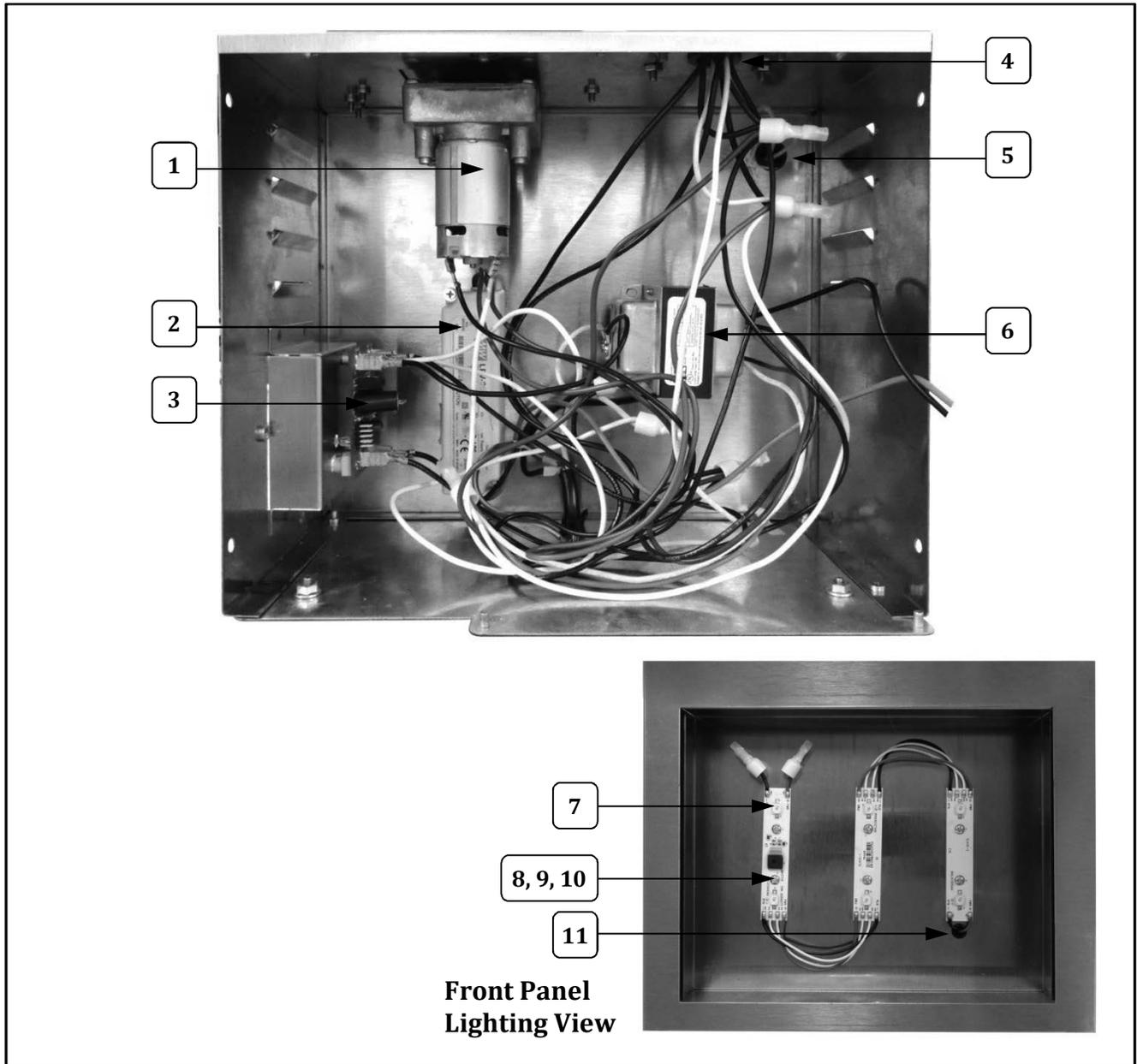

Item	Part Description	Qty.	Part No.
			2494
1	MOTOR 24 V DC	1	36043
2	POWER SUPPLY 24VDC 20W	1	55394
3	DISPENSER CONTROL BOARD	1	39976
4	BUSHING, SNAP .875 IN	1	45396
5	BUSHING, SNAP .625 IN	1	47282
6	TRANSFORMER, 12/24 VOLT	1	39459
7	3 LED MODULES	3	55349-3
8	6-32 X 3/8 PHIL PAN M/S	6	39000
9	#6 INT. TOOTH L/W 410SS	6	39001
10	6-32 M/S NUT 18-8	6	14221
11	BUSHING, SNAP .500 IN	1	47236



Control Panel - Interior and Lighting View

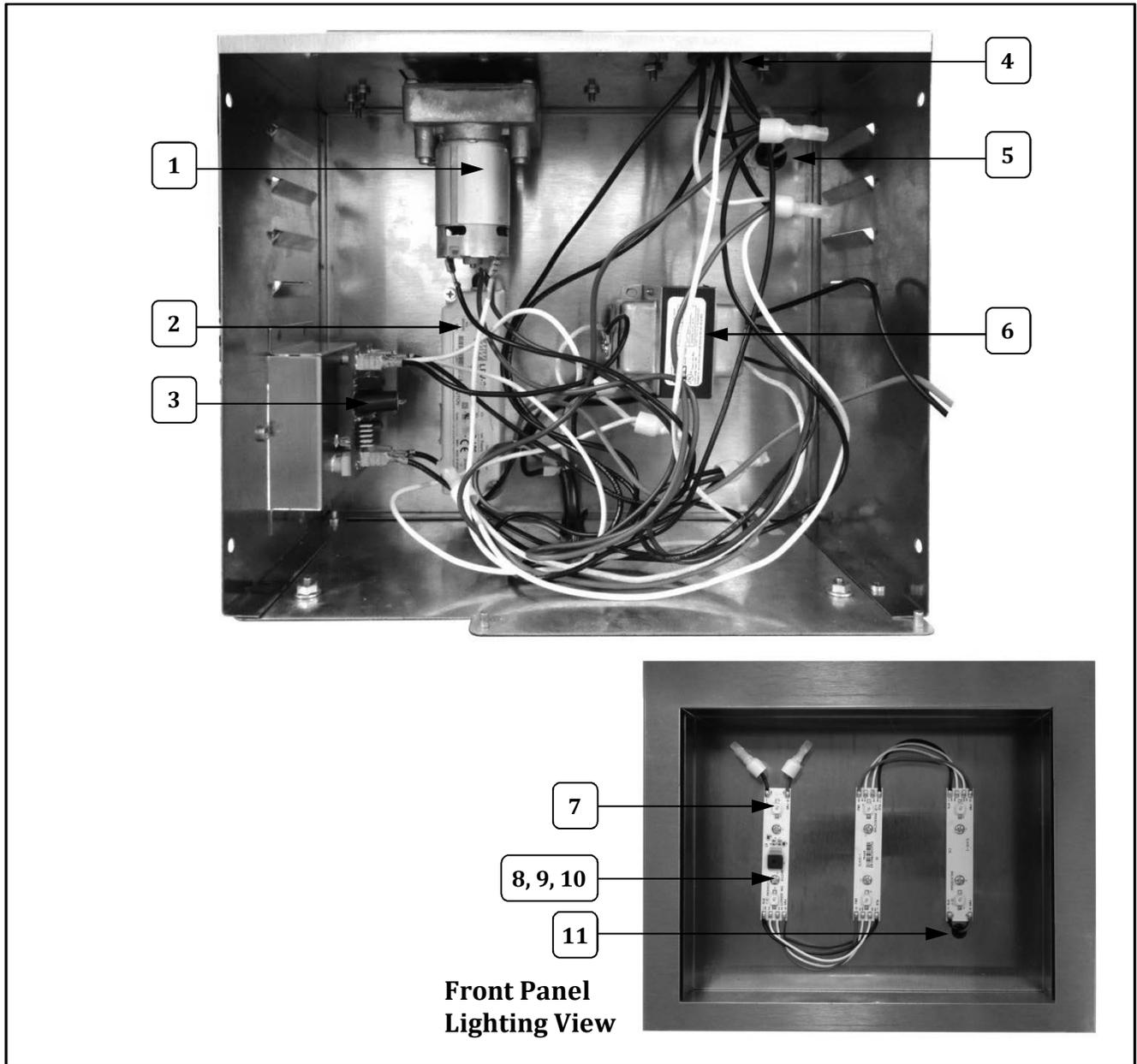

Item	Part Description	Qty.	Part No.
			2494
1	MOTOR 24 V DC	1	36043
2	POWER SUPPLY 24VDC 20W	1	55394
3	DISPENSER CONTROL BOARD	1	39976
4	BUSHING, SNAP .875 IN	1	45396
5	BUSHING, SNAP .625 IN	1	47282
6	TRANSFORMER, 12/24 VOLT	1	39459
7	3 LED MODULES	3	55349-3
8	6-32 X 3/8 PHIL PAN M/S	6	39000
9	#6 INT. TOOTH L/W 410SS	6	39001
10	6-32 M/S NUT 18-8	6	14221
11	BUSHING, SNAP .500 IN	1	47236



Control Panel - Interior and Lighting View

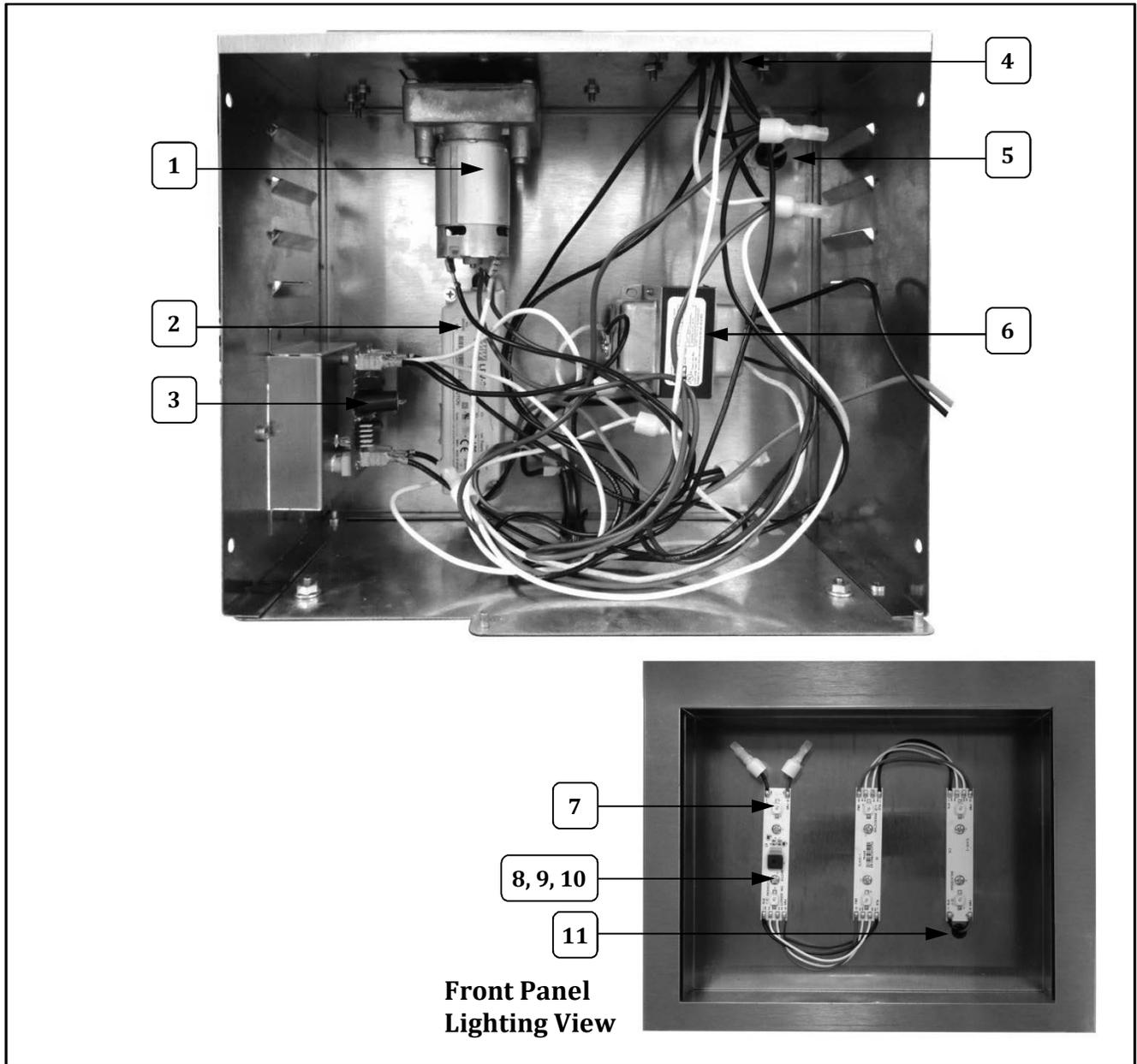

Item	Part Description	Qty.	Part No.
			2494
1	MOTOR 24 V DC	1	36043
2	POWER SUPPLY 24VDC 20W	1	55394
3	DISPENSER CONTROL BOARD	1	39976
4	BUSHING, SNAP .875 IN	1	45396
5	BUSHING, SNAP .625 IN	1	47282
6	TRANSFORMER, 12/24 VOLT	1	39459
7	3 LED MODULES	3	55349-3
8	6-32 X 3/8 PHIL PAN M/S	6	39000
9	#6 INT. TOOTH L/W 410SS	6	39001
10	6-32 M/S NUT 18-8	6	14221
11	BUSHING, SNAP .500 IN	1	47236