

INSTALLATION INSTRUCTIONS

Inspection of Shipment

After unpacking, check thoroughly for any damage which may have occurred in transit. Claims should be filed immediately with the transportation company. The warranty does not cover damage that occurs in transit, or damage caused by abuse, or consequential damage due to the operation of this machine, since it is beyond our control (reference warranty in back of manual).

Manual

Read and understand the operator's manual and all other safety instructions before using this equipment. To order copies of the operator's manual go to gmpopcorn.com or write to Gold Medal Products Co., 10700 Medallion Drive, Cincinnati, OH 45241 USA 1-(800)-543-0862.

Model Description











2600: Super Pop Maxx, 16 oz. popper with Popcorn Graphics

2600A: Super Pop Maxx, 16 oz. popper with Popcorn Graphics and a PowerOff Control

2600-00-003: Super Pop Maxx, 16 oz. popper with Kettle Corn Graphics and reduced temperature kettle for popping kettle corn.

2600-00-000: Super Pop Maxx, 16 oz. popper with an LED lighted sign

Items Included with this Unit

				
Aluminum Scoop (PN 2071)	Measure 20 cc (PN 47680)	6 oz. Measure (PN 49049)	16 oz. Corn Measure (PN 68050)	
				
Instruction Manual	Registration Warranty Card	Bulb for Cabinet Interior (PN 42947)	Black Crutch Tips (PN 49123) 4 req'd.	Knob (PN 47120) & Screw for Old Maid Pan
				
Decal (Models 2600 & 2600A) (PN 49777)		Decal (Model 2600-00-003) (PN 49158KC)		

INSTALLATION INSTRUCTIONS

Inspection of Shipment

After unpacking, check thoroughly for any damage which may have occurred in transit. Claims should be filed immediately with the transportation company. The warranty does not cover damage that occurs in transit, or damage caused by abuse, or consequential damage due to the operation of this machine, since it is beyond our control (reference warranty in back of manual).

Manual

Read and understand the operator's manual and all other safety instructions before using this equipment. To order copies of the operator's manual go to gmpopcorn.com or write to Gold Medal Products Co., 10700 Medallion Drive, Cincinnati, OH 45241 USA 1-(800)-543-0862.

Model Description











2600: Super Pop Maxx, 16 oz. popper with Popcorn Graphics

2600A: Super Pop Maxx, 16 oz. popper with Popcorn Graphics and a PowerOff Control

2600-00-003: Super Pop Maxx, 16 oz. popper with Kettle Corn Graphics and reduced temperature kettle for popping kettle corn.

2600-00-000: Super Pop Maxx, 16 oz. popper with an LED lighted sign

Items Included with this Unit

				
Aluminum Scoop (PN 2071)	Measure 20 cc (PN 47680)	6 oz. Measure (PN 49049)	16 oz. Corn Measure (PN 68050)	
				
Instruction Manual	Registration Warranty Card	Bulb for Cabinet Interior (PN 42947)	Black Crutch Tips (PN 49123) 4 req'd.	Knob (PN 47120) & Screw for Old Maid Pan
				
Decal (Models 2600 & 2600A) (PN 49777)		Decal (Model 2600-00-003) (PN 49158KC)		

INSTALLATION INSTRUCTIONS

Inspection of Shipment

After unpacking, check thoroughly for any damage which may have occurred in transit. Claims should be filed immediately with the transportation company. The warranty does not cover damage that occurs in transit, or damage caused by abuse, or consequential damage due to the operation of this machine, since it is beyond our control (reference warranty in back of manual).

Manual

Read and understand the operator's manual and all other safety instructions before using this equipment. To order copies of the operator's manual go to gmpopcorn.com or write to Gold Medal Products Co., 10700 Medallion Drive, Cincinnati, OH 45241 USA 1-(800)-543-0862.

Model Description











2600: Super Pop Maxx, 16 oz. popper with Popcorn Graphics

2600A: Super Pop Maxx, 16 oz. popper with Popcorn Graphics and a PowerOff Control

2600-00-003: Super Pop Maxx, 16 oz. popper with Kettle Corn Graphics and reduced temperature kettle for popping kettle corn.

2600-00-000: Super Pop Maxx, 16 oz. popper with an LED lighted sign

Items Included with this Unit

				
Aluminum Scoop (PN 2071)	Measure 20 cc (PN 47680)	6 oz. Measure (PN 49049)	16 oz. Corn Measure (PN 68050)	
				
Instruction Manual	Registration Warranty Card	Bulb for Cabinet Interior (PN 42947)	Black Crutch Tips (PN 49123) 4 req'd.	Knob (PN 47120) & Screw for Old Maid Pan
				
Decal (Models 2600 & 2600A) (PN 49777)		Decal (Model 2600-00-003) (PN 49158KC)		

INSTALLATION INSTRUCTIONS

Inspection of Shipment

After unpacking, check thoroughly for any damage which may have occurred in transit. Claims should be filed immediately with the transportation company. The warranty does not cover damage that occurs in transit, or damage caused by abuse, or consequential damage due to the operation of this machine, since it is beyond our control (reference warranty in back of manual).

Manual

Read and understand the operator's manual and all other safety instructions before using this equipment. To order copies of the operator's manual go to gmpopcorn.com or write to Gold Medal Products Co., 10700 Medallion Drive, Cincinnati, OH 45241 USA 1-(800)-543-0862.

Model Description









2600: Super Pop Maxx, 16 oz. popper with Popcorn Graphics

2600A: Super Pop Maxx, 16 oz. popper with Popcorn Graphics and a PowerOff Control

2600-00-003: Super Pop Maxx, 16 oz. popper with Kettle Corn Graphics and reduced temperature kettle for popping kettle corn.

2600-00-000: Super Pop Maxx, 16 oz. popper with an LED lighted sign

Items Included with this Unit

				
Aluminum Scoop (PN 2071)	Measure 20 cc (PN 47680)	6 oz. Measure (PN 49049)	16 oz. Corn Measure (PN 68050)	
				
Instruction Manual	Registration Warranty Card	Bulb for Cabinet Interior (PN 42947)	Black Crutch Tips (PN 49123) 4 req'd.	Knob (PN 47120) & Screw for Old Maid Pan
				
Decal (Models 2600 & 2600A) (PN 49777)		Decal (Model 2600-00-003) (PN 49158KC)		

INSTALLATION INSTRUCTIONS

Inspection of Shipment

After unpacking, check thoroughly for any damage which may have occurred in transit. Claims should be filed immediately with the transportation company. The warranty does not cover damage that occurs in transit, or damage caused by abuse, or consequential damage due to the operation of this machine, since it is beyond our control (reference warranty in back of manual).

Manual

Read and understand the operator's manual and all other safety instructions before using this equipment. To order copies of the operator's manual go to gmpopcorn.com or write to Gold Medal Products Co., 10700 Medallion Drive, Cincinnati, OH 45241 USA 1-(800)-543-0862.

Model Description









2600: Super Pop Maxx, 16 oz. popper with Popcorn Graphics

2600A: Super Pop Maxx, 16 oz. popper with Popcorn Graphics and a PowerOff Control

2600-00-003: Super Pop Maxx, 16 oz. popper with Kettle Corn Graphics and reduced temperature kettle for popping kettle corn.

2600-00-000: Super Pop Maxx, 16 oz. popper with an LED lighted sign

Items Included with this Unit

				
Aluminum Scoop (PN 2071)	Measure 20 cc (PN 47680)	6 oz. Measure (PN 49049)	16 oz. Corn Measure (PN 68050)	
				
Instruction Manual	Registration Warranty Card	Bulb for Cabinet Interior (PN 42947)	Black Crutch Tips (PN 49123) 4 req'd.	Knob (PN 47120) & Screw for Old Maid Pan
				
Decal (Models 2600 & 2600A) (PN 49777)		Decal (Model 2600-00-003) (PN 49158KC)		

INSTALLATION INSTRUCTIONS

Inspection of Shipment

After unpacking, check thoroughly for any damage which may have occurred in transit. Claims should be filed immediately with the transportation company. The warranty does not cover damage that occurs in transit, or damage caused by abuse, or consequential damage due to the operation of this machine, since it is beyond our control (reference warranty in back of manual).

Manual

Read and understand the operator's manual and all other safety instructions before using this equipment. To order copies of the operator's manual go to gmpopcorn.com or write to Gold Medal Products Co., 10700 Medallion Drive, Cincinnati, OH 45241 USA 1-(800)-543-0862.

Model Description









2600: Super Pop Maxx, 16 oz. popper with Popcorn Graphics

2600A: Super Pop Maxx, 16 oz. popper with Popcorn Graphics and a PowerOff Control

2600-00-003: Super Pop Maxx, 16 oz. popper with Kettle Corn Graphics and reduced temperature kettle for popping kettle corn.

2600-00-000: Super Pop Maxx, 16 oz. popper with an LED lighted sign

Items Included with this Unit

				
Aluminum Scoop (PN 2071)	Measure 20 cc (PN 47680)	6 oz. Measure (PN 49049)	16 oz. Corn Measure (PN 68050)	
				
Instruction Manual	Registration Warranty Card	Bulb for Cabinet Interior (PN 42947)	Black Crutch Tips (PN 49123) 4 req'd.	Knob (PN 47120) & Screw for Old Maid Pan
				
Decal (Models 2600 & 2600A) (PN 49777)		Decal (Model 2600-00-003) (PN 49158KC)		

INSTALLATION INSTRUCTIONS

Inspection of Shipment

After unpacking, check thoroughly for any damage which may have occurred in transit. Claims should be filed immediately with the transportation company. The warranty does not cover damage that occurs in transit, or damage caused by abuse, or consequential damage due to the operation of this machine, since it is beyond our control (reference warranty in back of manual).

Manual

Read and understand the operator's manual and all other safety instructions before using this equipment. To order copies of the operator's manual go to gmpopcorn.com or write to Gold Medal Products Co., 10700 Medallion Drive, Cincinnati, OH 45241 USA 1-(800)-543-0862.

Model Description











2600: Super Pop Maxx, 16 oz. popper with Popcorn Graphics

2600A: Super Pop Maxx, 16 oz. popper with Popcorn Graphics and a PowerOff Control

2600-00-003: Super Pop Maxx, 16 oz. popper with Kettle Corn Graphics and reduced temperature kettle for popping kettle corn.

2600-00-000: Super Pop Maxx, 16 oz. popper with an LED lighted sign

Items Included with this Unit

				
Aluminum Scoop (PN 2071)	Measure 20 cc (PN 47680)	6 oz. Measure (PN 49049)	16 oz. Corn Measure (PN 68050)	
				
Instruction Manual	Registration Warranty Card	Bulb for Cabinet Interior (PN 42947)	Black Crutch Tips (PN 49123) 4 req'd.	Knob (PN 47120) & Screw for Old Maid Pan
				
Decal (Models 2600 & 2600A) (PN 49777)		Decal (Model 2600-00-003) (PN 49158KC)		

INSTALLATION INSTRUCTIONS

Inspection of Shipment

After unpacking, check thoroughly for any damage which may have occurred in transit. Claims should be filed immediately with the transportation company. The warranty does not cover damage that occurs in transit, or damage caused by abuse, or consequential damage due to the operation of this machine, since it is beyond our control (reference warranty in back of manual).

Manual

Read and understand the operator's manual and all other safety instructions before using this equipment. To order copies of the operator's manual go to gmpopcorn.com or write to Gold Medal Products Co., 10700 Medallion Drive, Cincinnati, OH 45241 USA 1-(800)-543-0862.

Model Description









2600: Super Pop Maxx, 16 oz. popper with Popcorn Graphics

2600A: Super Pop Maxx, 16 oz. popper with Popcorn Graphics and a PowerOff Control

2600-00-003: Super Pop Maxx, 16 oz. popper with Kettle Corn Graphics and reduced temperature kettle for popping kettle corn.

2600-00-000: Super Pop Maxx, 16 oz. popper with an LED lighted sign

Items Included with this Unit

				
Aluminum Scoop (PN 2071)	Measure 20 cc (PN 47680)	6 oz. Measure (PN 49049)	16 oz. Corn Measure (PN 68050)	
				
Instruction Manual	Registration Warranty Card	Bulb for Cabinet Interior (PN 42947)	Black Crutch Tips (PN 49123) 4 req'd.	Knob (PN 47120) & Screw for Old Maid Pan
				
Decal (Models 2600 & 2600A) (PN 49777)		Decal (Model 2600-00-003) (PN 49158KC)		



16 oz. Kettle Assembly (55199, 55199KC) – Agitator Assy. View

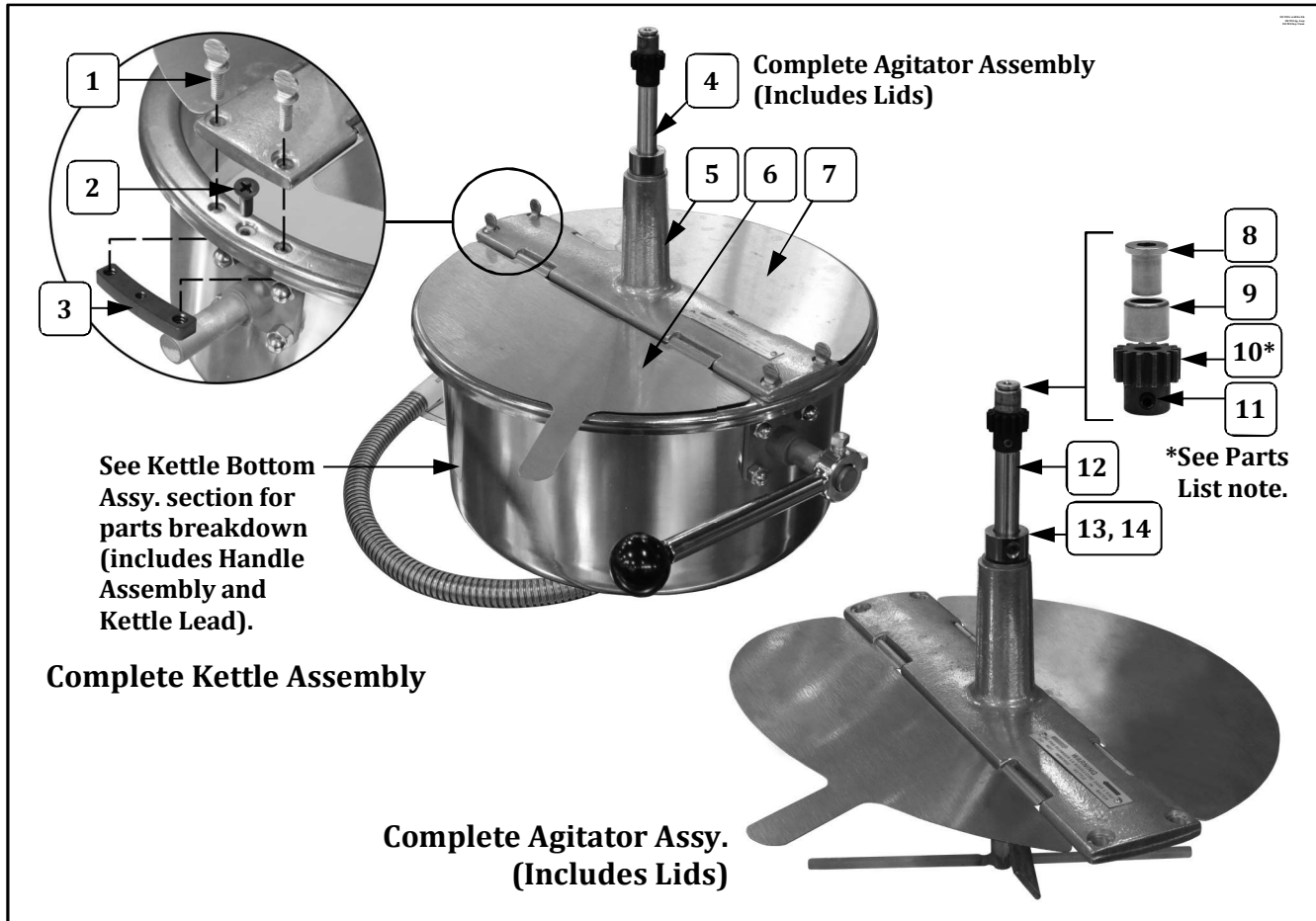

Item	Part Description	Part Number
		55199 55199KC
1	1/4-20 X 1 THUMB SCREW	47691
2	8-32 X 1/2 PHILL FLAT M/S ZINC	20066
3	THREADED BLOCK	61167
4	LID & AGITATOR ASSEMBLY (Complete Assy.)	41181
5	CROSSBAR ASSEMBLY	41180
6	FRONT LID	41123
7	REAR LID	41120
8	AGITATOR BEARING HUB	43434
9	NEEDLE BEARING	47106
10*	SPUR GEAR KIT (Includes 2 gears with set screws. Always replace Agitator Spur Gear and Kettle Drive Motor Gear as a set.)	47059K
11	10-32 X 3/16 SET SCREW	41742
12	AGITATOR SHAFT ASSEMBLY	41093
13	1/2 ID X 7/8 OD SET COLLAR	47326
14	1/4-20 X 3/16 SET SCREW	47751



16 oz. Kettle Assembly (55199, 55199KC) – Agitator Assy. View

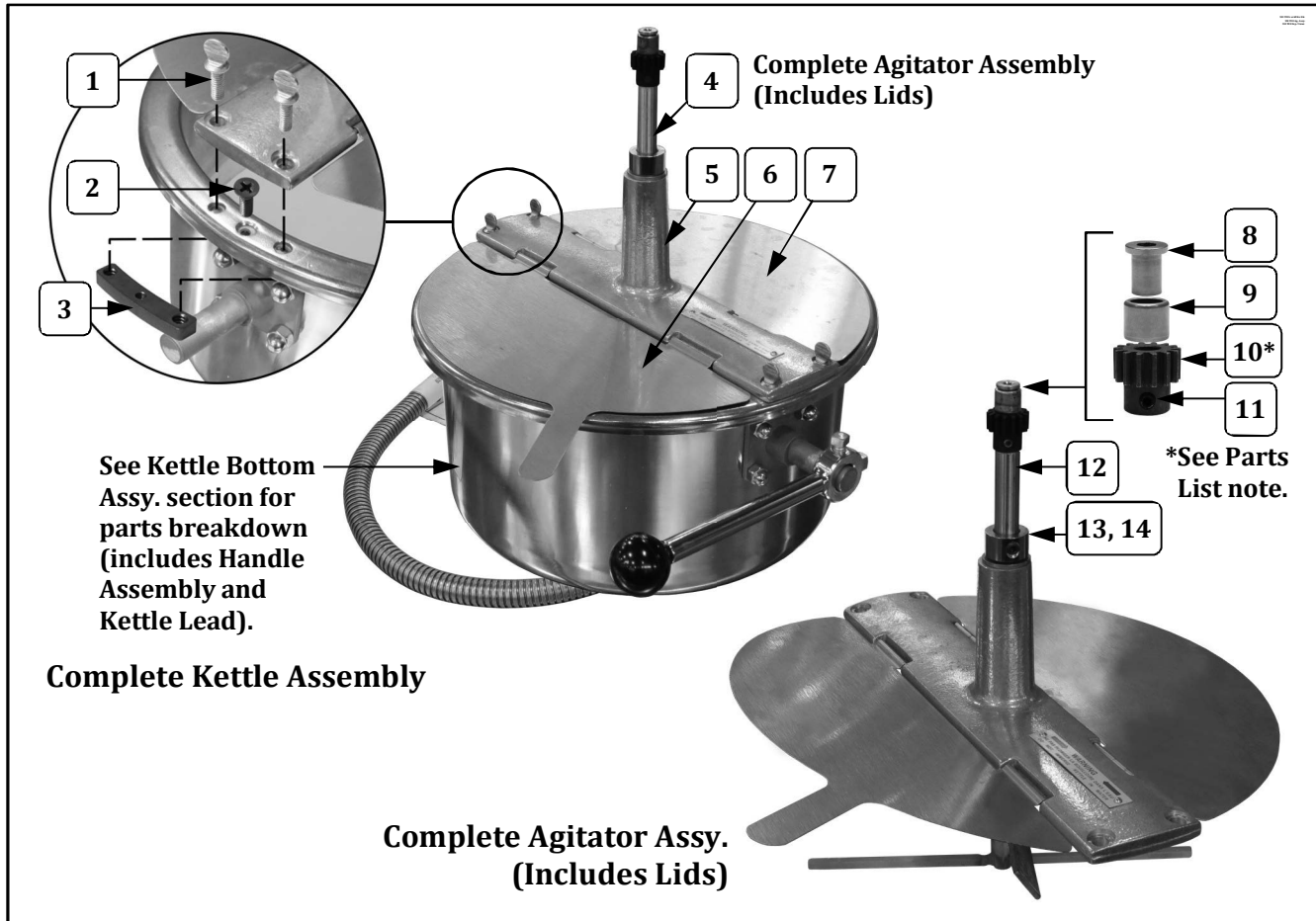

Item	Part Description	Part Number
		55199 55199KC
1	1/4-20 X 1 THUMB SCREW	47691
2	8-32 X 1/2 PHILL FLAT M/S ZINC	20066
3	THREADED BLOCK	61167
4	LID & AGITATOR ASSEMBLY (Complete Assy.)	41181
5	CROSSBAR ASSEMBLY	41180
6	FRONT LID	41123
7	REAR LID	41120
8	AGITATOR BEARING HUB	43434
9	NEEDLE BEARING	47106
10*	SPUR GEAR KIT (Includes 2 gears with set screws. Always replace Agitator Spur Gear and Kettle Drive Motor Gear as a set.)	47059K
11	10-32 X 3/16 SET SCREW	41742
12	AGITATOR SHAFT ASSEMBLY	41093
13	1/2 ID X 7/8 OD SET COLLAR	47326
14	1/4-20 X 3/16 SET SCREW	47751



16 oz. Kettle Assembly (55199, 55199KC) – Agitator Assy. View

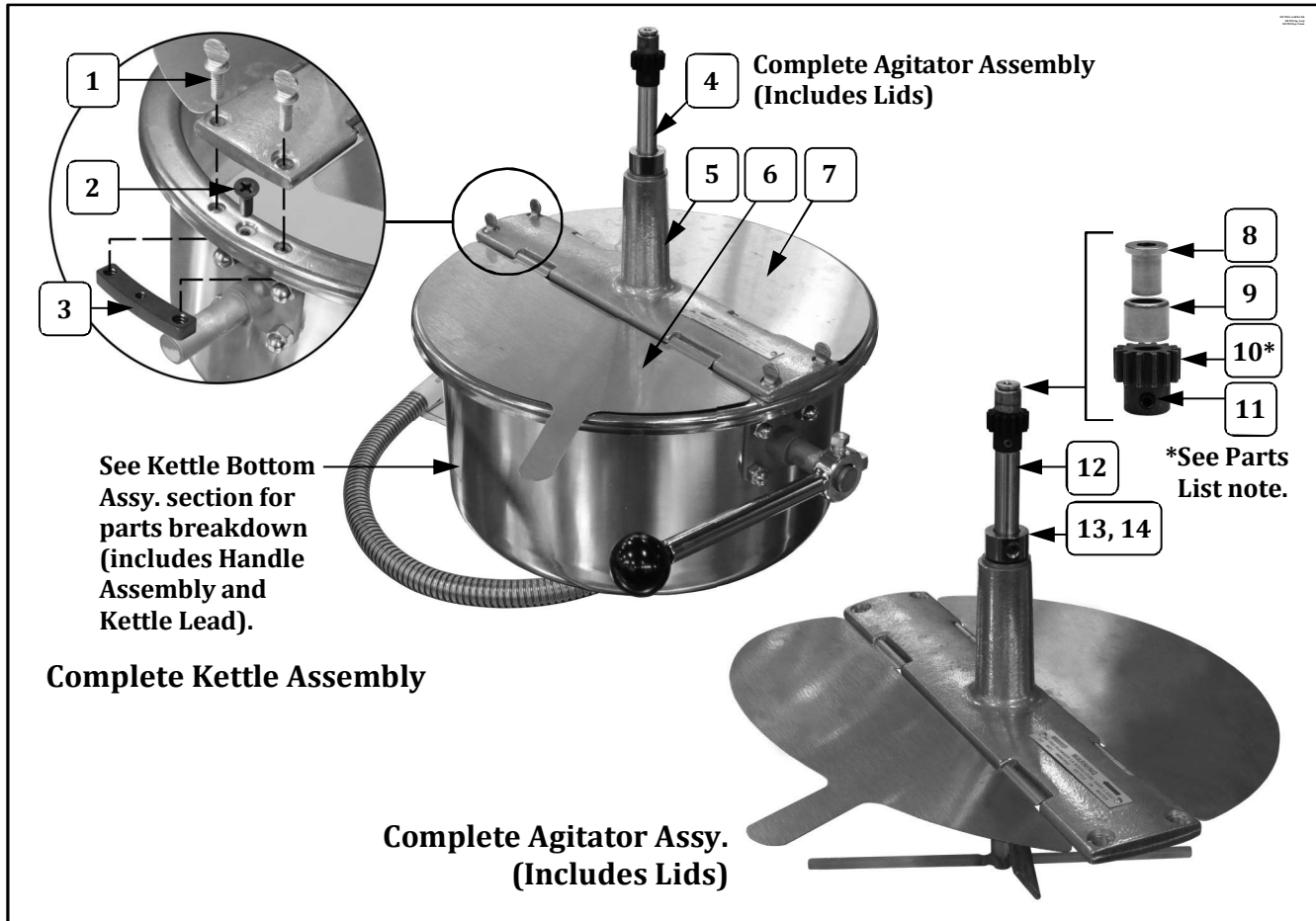

Item	Part Description	Part Number
		55199 55199KC
1	1/4-20 X 1 THUMB SCREW	47691
2	8-32 X 1/2 PHILL FLAT M/S ZINC	20066
3	THREADED BLOCK	61167
4	LID & AGITATOR ASSEMBLY (Complete Assy.)	41181
5	CROSSBAR ASSEMBLY	41180
6	FRONT LID	41123
7	REAR LID	41120
8	AGITATOR BEARING HUB	43434
9	NEEDLE BEARING	47106
10*	SPUR GEAR KIT (Includes 2 gears with set screws. Always replace Agitator Spur Gear and Kettle Drive Motor Gear as a set.)	47059K
11	10-32 X 3/16 SET SCREW	41742
12	AGITATOR SHAFT ASSEMBLY	41093
13	1/2 ID X 7/8 OD SET COLLAR	47326
14	1/4-20 X 3/16 SET SCREW	47751



16 oz. Kettle Assembly (55199, 55199KC) – Agitator Assy. View

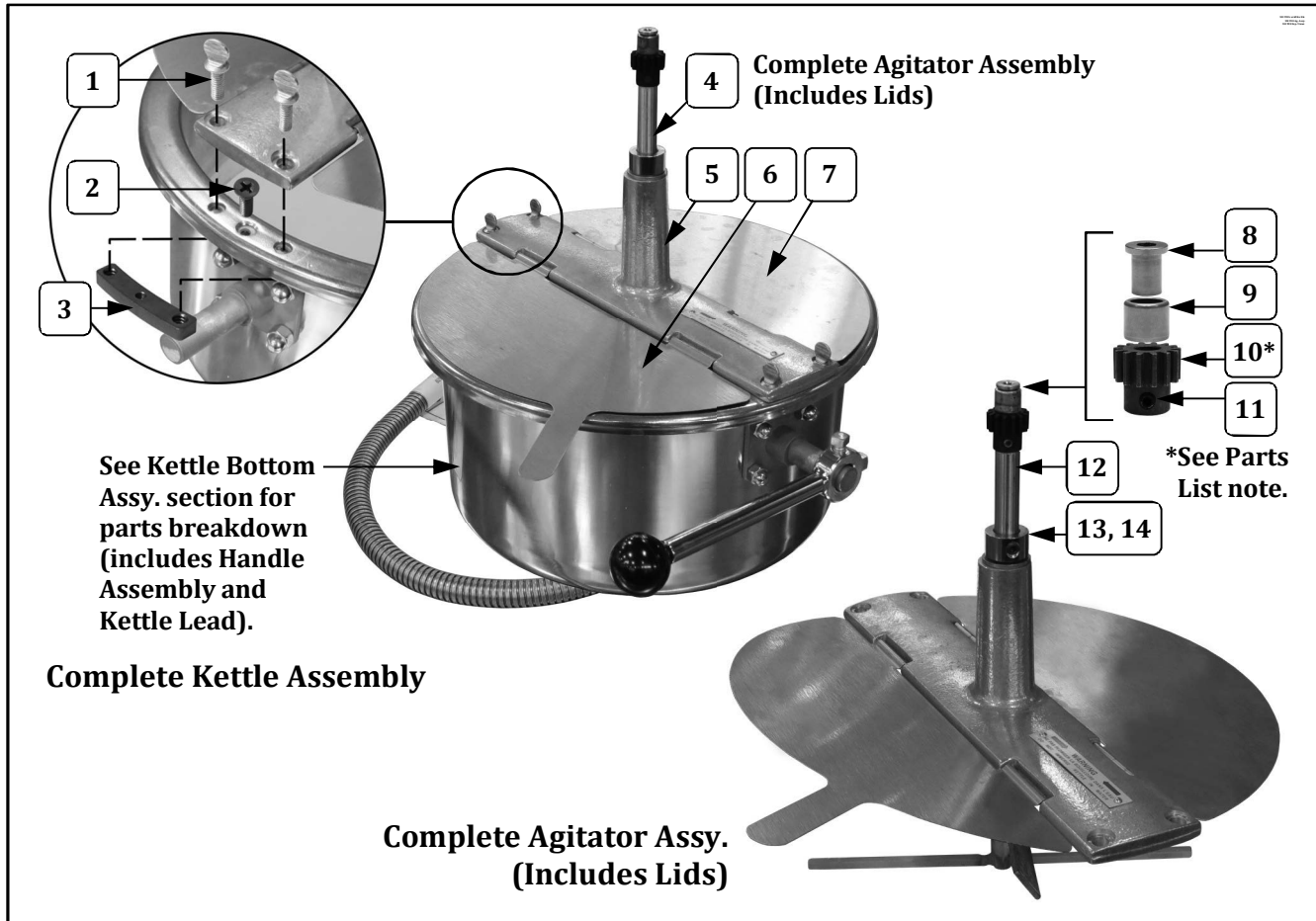

Item	Part Description	Part Number
		55199 55199KC
1	1/4-20 X 1 THUMB SCREW	47691
2	8-32 X 1/2 PHILL FLAT M/S ZINC	20066
3	THREADED BLOCK	61167
4	LID & AGITATOR ASSEMBLY (Complete Assy.)	41181
5	CROSSBAR ASSEMBLY	41180
6	FRONT LID	41123
7	REAR LID	41120
8	AGITATOR BEARING HUB	43434
9	NEEDLE BEARING	47106
10*	SPUR GEAR KIT (Includes 2 gears with set screws. Always replace Agitator Spur Gear and Kettle Drive Motor Gear as a set.)	47059K
11	10-32 X 3/16 SET SCREW	41742
12	AGITATOR SHAFT ASSEMBLY	41093
13	1/2 ID X 7/8 OD SET COLLAR	47326
14	1/4-20 X 3/16 SET SCREW	47751



16 oz. Kettle Assembly (55199, 55199KC) – Agitator Assy. View

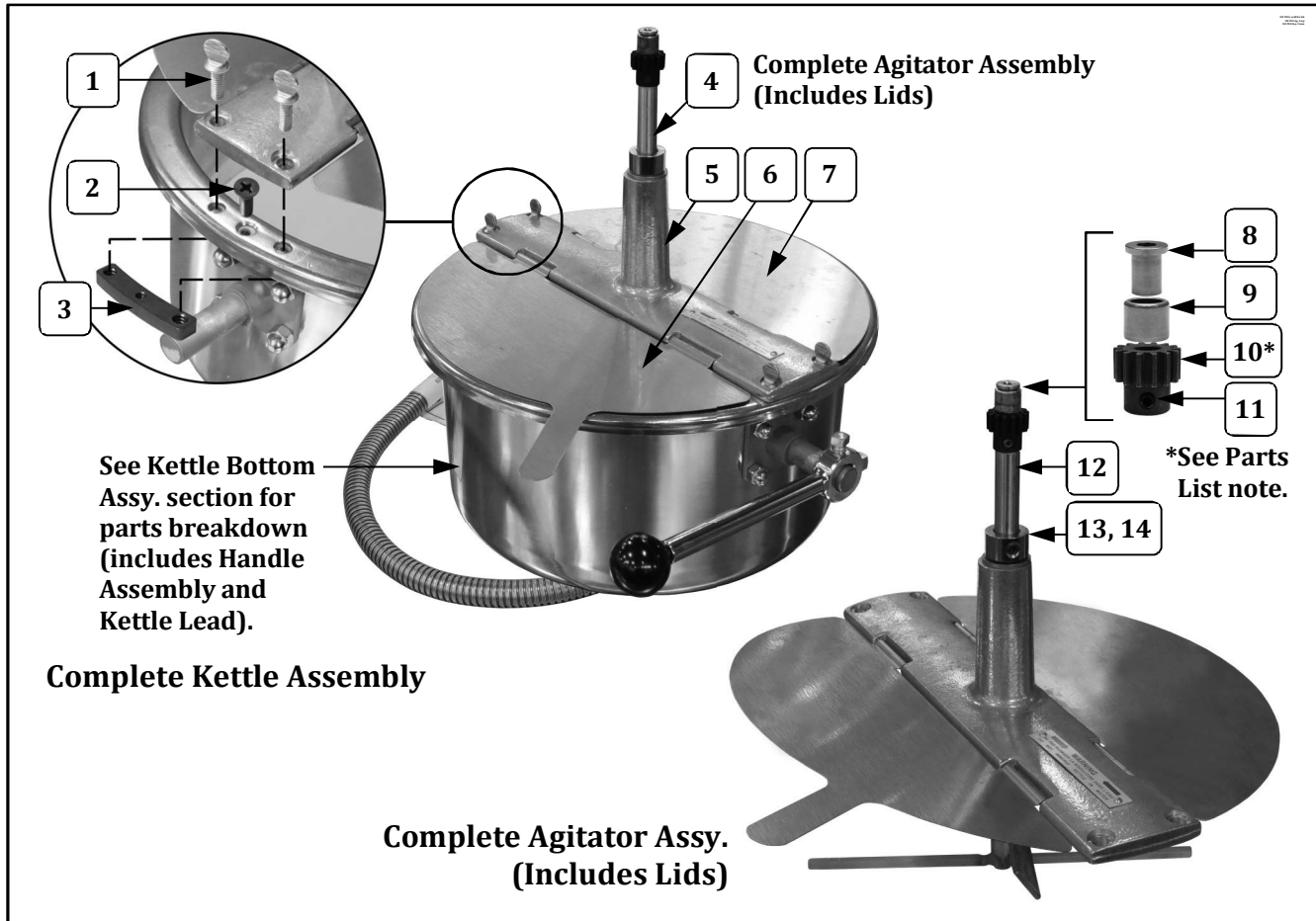

Item	Part Description	Part Number
		55199 55199KC
1	1/4-20 X 1 THUMB SCREW	47691
2	8-32 X 1/2 PHILL FLAT M/S ZINC	20066
3	THREADED BLOCK	61167
4	LID & AGITATOR ASSEMBLY (Complete Assy.)	41181
5	CROSSBAR ASSEMBLY	41180
6	FRONT LID	41123
7	REAR LID	41120
8	AGITATOR BEARING HUB	43434
9	NEEDLE BEARING	47106
10*	SPUR GEAR KIT (Includes 2 gears with set screws. Always replace Agitator Spur Gear and Kettle Drive Motor Gear as a set.)	47059K
11	10-32 X 3/16 SET SCREW	41742
12	AGITATOR SHAFT ASSEMBLY	41093
13	1/2 ID X 7/8 OD SET COLLAR	47326
14	1/4-20 X 3/16 SET SCREW	47751



16 oz. Kettle Assembly (55199, 55199KC) – Agitator Assy. View

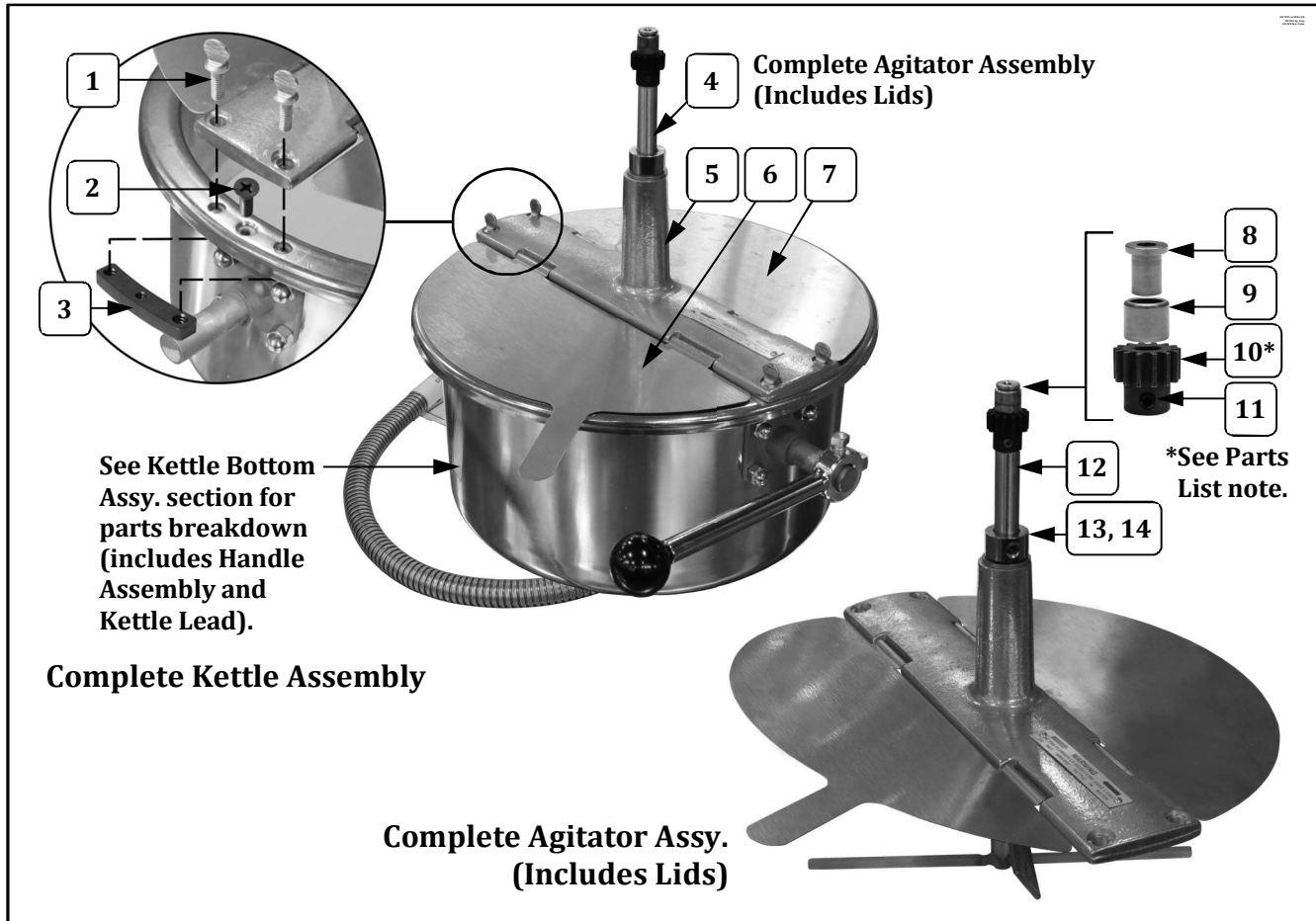

Item	Part Description	Part Number
		55199 55199KC
1	1/4-20 X 1 THUMB SCREW	47691
2	8-32 X 1/2 PHILL FLAT M/S ZINC	20066
3	THREADED BLOCK	61167
4	LID & AGITATOR ASSEMBLY (Complete Assy.)	41181
5	CROSSBAR ASSEMBLY	41180
6	FRONT LID	41123
7	REAR LID	41120
8	AGITATOR BEARING HUB	43434
9	NEEDLE BEARING	47106
10*	SPUR GEAR KIT (Includes 2 gears with set screws. Always replace Agitator Spur Gear and Kettle Drive Motor Gear as a set.)	47059K
11	10-32 X 3/16 SET SCREW	41742
12	AGITATOR SHAFT ASSEMBLY	41093
13	1/2 ID X 7/8 OD SET COLLAR	47326
14	1/4-20 X 3/16 SET SCREW	47751



16 oz. Kettle Assembly (55199, 55199KC) – Agitator Assy. View

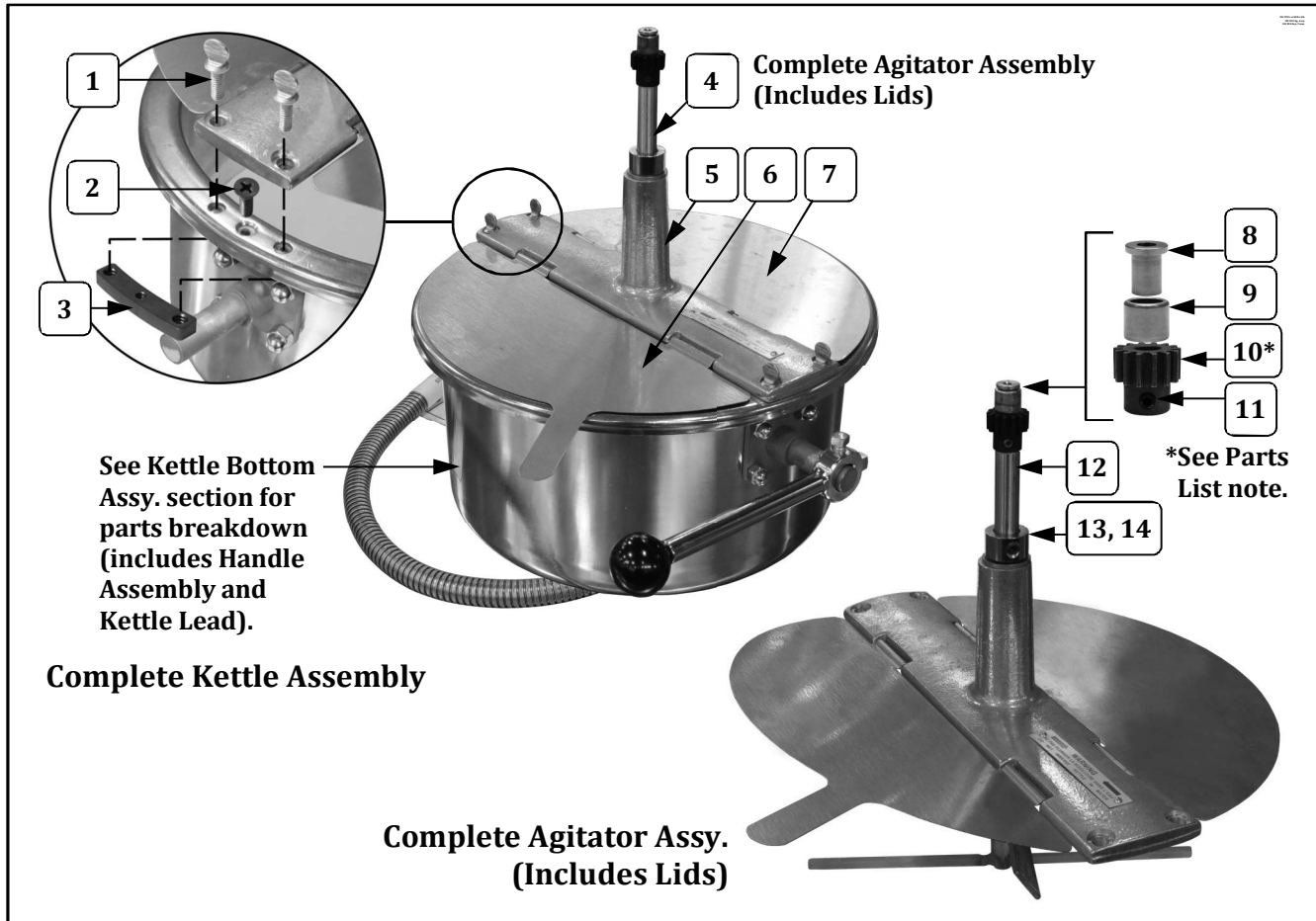

Item	Part Description	Part Number
		55199 55199KC
1	1/4-20 X 1 THUMB SCREW	47691
2	8-32 X 1/2 PHILL FLAT M/S ZINC	20066
3	THREADED BLOCK	61167
4	LID & AGITATOR ASSEMBLY (Complete Assy.)	41181
5	CROSSBAR ASSEMBLY	41180
6	FRONT LID	41123
7	REAR LID	41120
8	AGITATOR BEARING HUB	43434
9	NEEDLE BEARING	47106
10*	SPUR GEAR KIT (Includes 2 gears with set screws. Always replace Agitator Spur Gear and Kettle Drive Motor Gear as a set.)	47059K
11	10-32 X 3/16 SET SCREW	41742
12	AGITATOR SHAFT ASSEMBLY	41093
13	1/2 ID X 7/8 OD SET COLLAR	47326
14	1/4-20 X 3/16 SET SCREW	47751



16 oz. Kettle Assembly (55199, 55199KC) – Agitator Assy. View

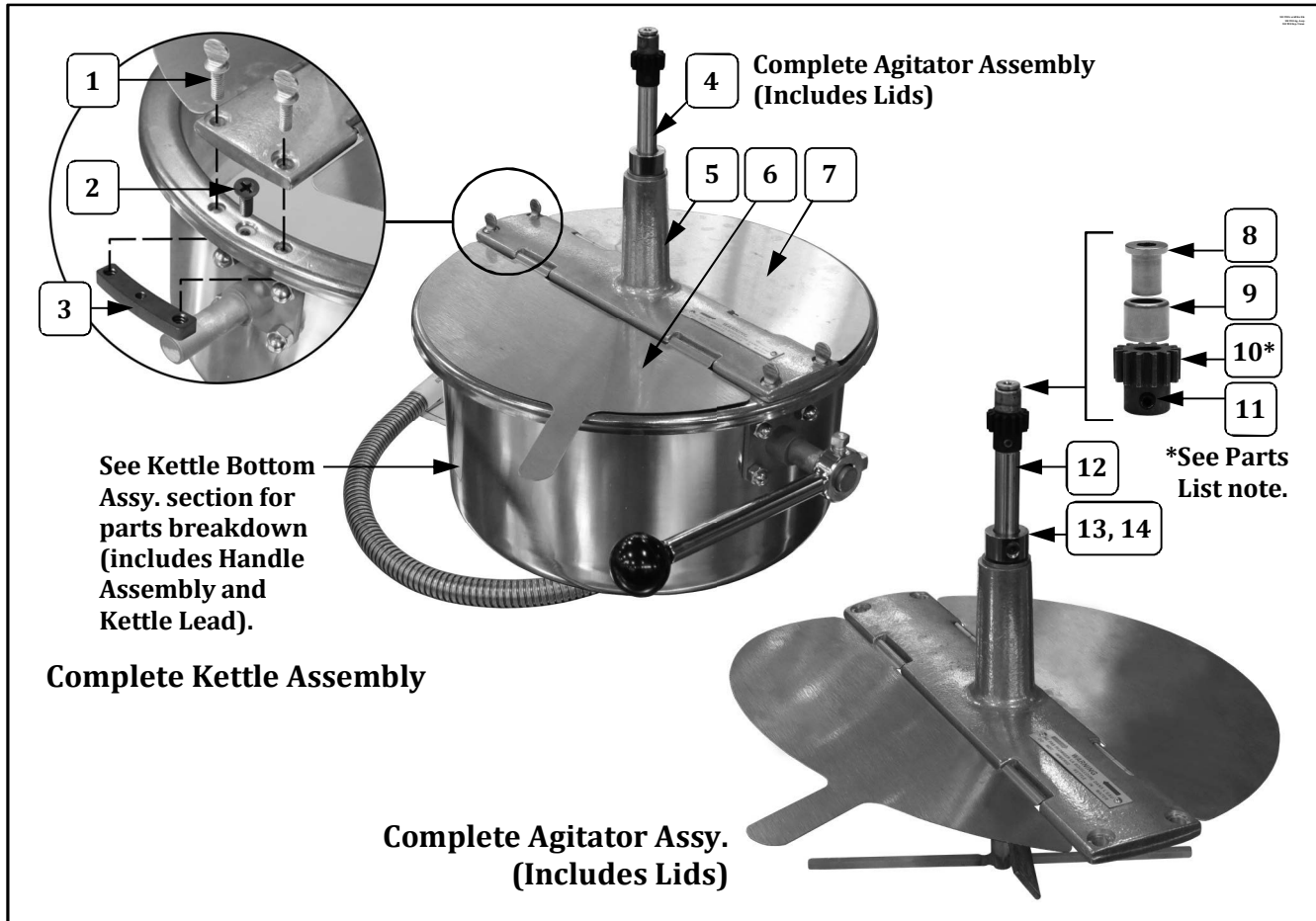

Item	Part Description	Part Number
		55199 55199KC
1	1/4-20 X 1 THUMB SCREW	47691
2	8-32 X 1/2 PHILL FLAT M/S ZINC	20066
3	THREADED BLOCK	61167
4	LID & AGITATOR ASSEMBLY (Complete Assy.)	41181
5	CROSSBAR ASSEMBLY	41180
6	FRONT LID	41123
7	REAR LID	41120
8	AGITATOR BEARING HUB	43434
9	NEEDLE BEARING	47106
10*	SPUR GEAR KIT (Includes 2 gears with set screws. Always replace Agitator Spur Gear and Kettle Drive Motor Gear as a set.)	47059K
11	10-32 X 3/16 SET SCREW	41742
12	AGITATOR SHAFT ASSEMBLY	41093
13	1/2 ID X 7/8 OD SET COLLAR	47326
14	1/4-20 X 3/16 SET SCREW	47751



16 oz. Kettle Assembly (55199, 55199KC) – Agitator Assy. View

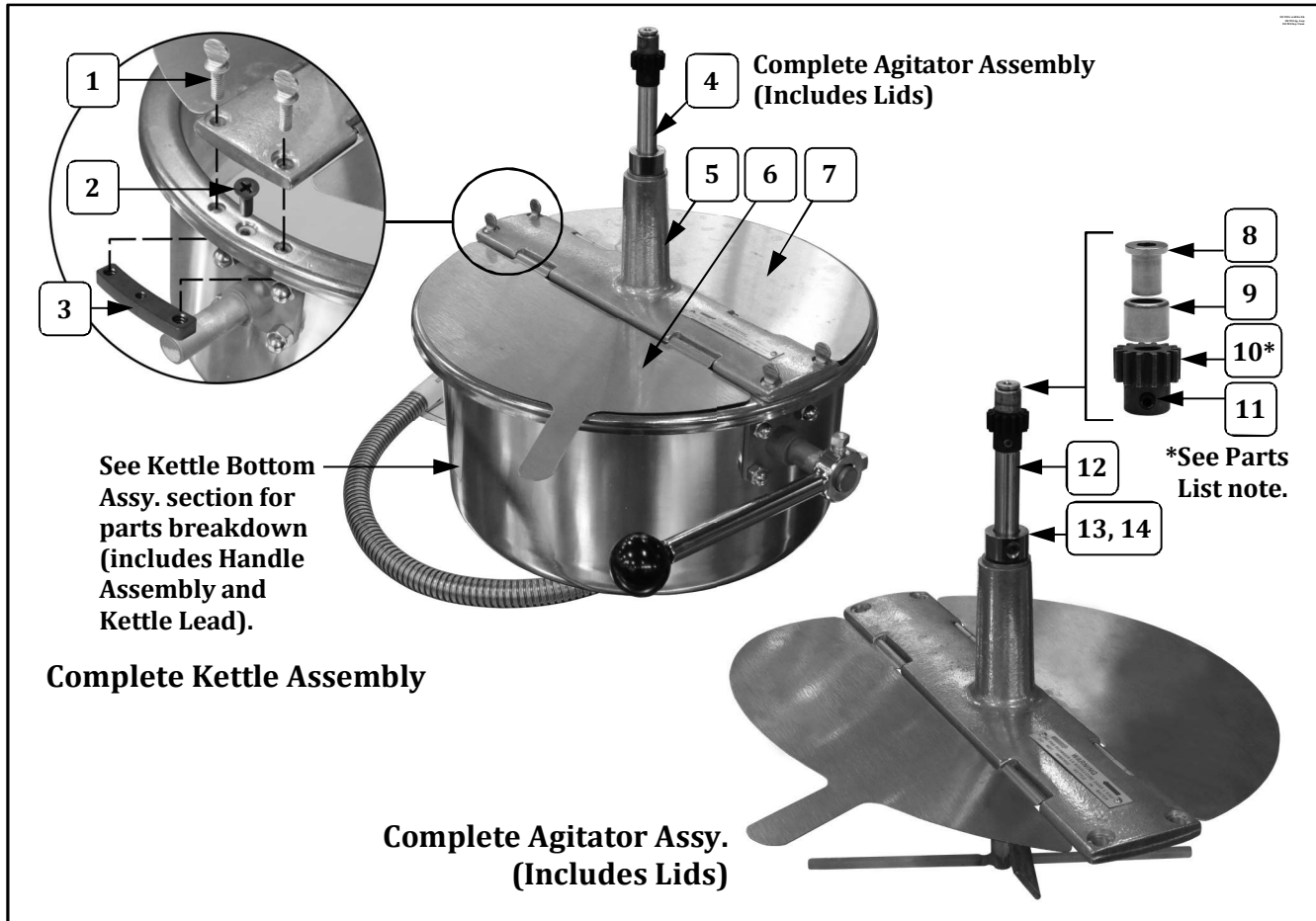

Item	Part Description	Part Number
		55199 55199KC
1	1/4-20 X 1 THUMB SCREW	47691
2	8-32 X 1/2 PHILL FLAT M/S ZINC	20066
3	THREADED BLOCK	61167
4	LID & AGITATOR ASSEMBLY (Complete Assy.)	41181
5	CROSSBAR ASSEMBLY	41180
6	FRONT LID	41123
7	REAR LID	41120
8	AGITATOR BEARING HUB	43434
9	NEEDLE BEARING	47106
10*	SPUR GEAR KIT (Includes 2 gears with set screws. Always replace Agitator Spur Gear and Kettle Drive Motor Gear as a set.)	47059K
11	10-32 X 3/16 SET SCREW	41742
12	AGITATOR SHAFT ASSEMBLY	41093
13	1/2 ID X 7/8 OD SET COLLAR	47326
14	1/4-20 X 3/16 SET SCREW	47751



16 oz. Kettle Assembly (55199, 55199KC) – Agitator Assy. View

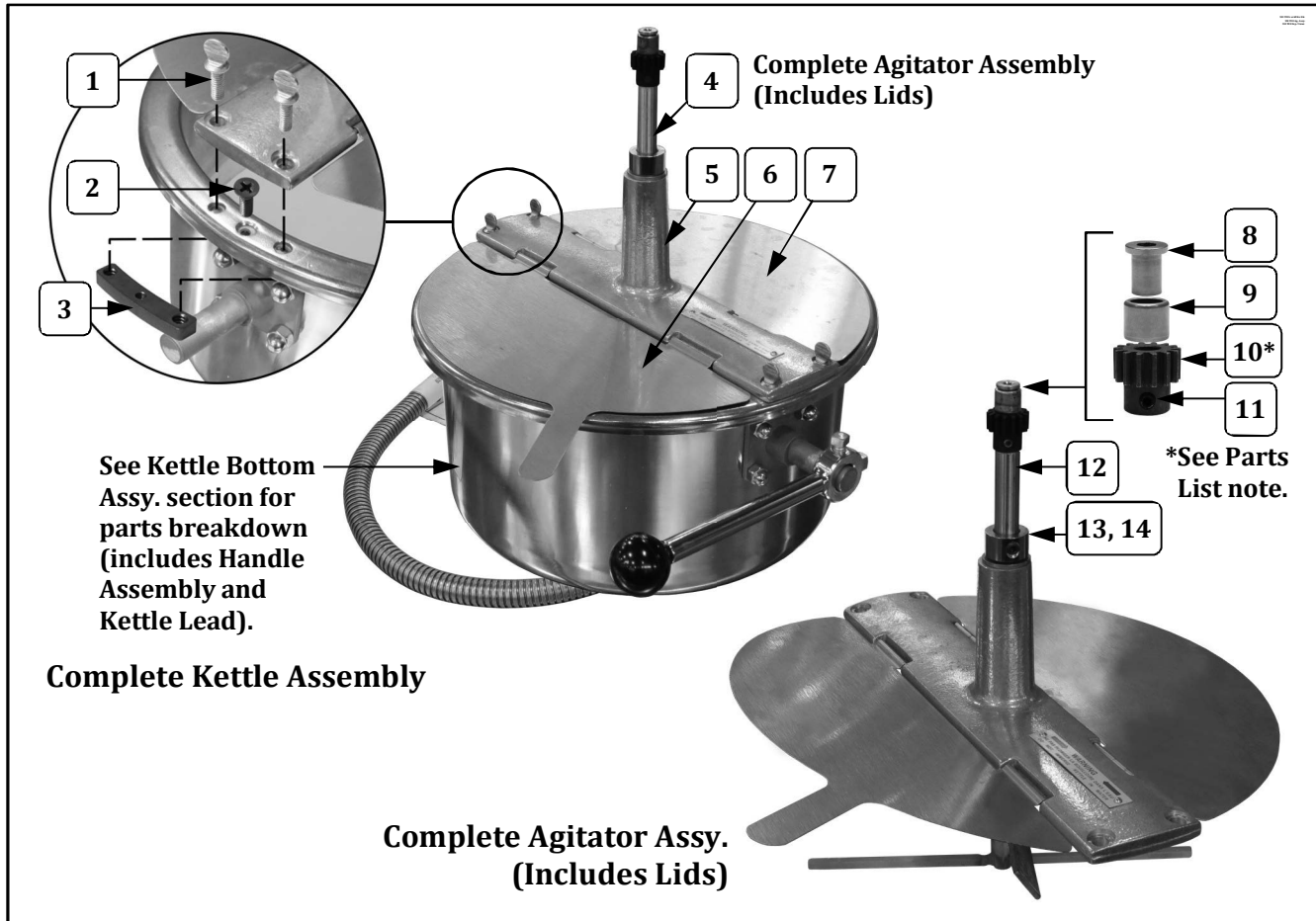

Item	Part Description	Part Number
		55199 55199KC
1	1/4-20 X 1 THUMB SCREW	47691
2	8-32 X 1/2 PHILL FLAT M/S ZINC	20066
3	THREADED BLOCK	61167
4	LID & AGITATOR ASSEMBLY (Complete Assy.)	41181
5	CROSSBAR ASSEMBLY	41180
6	FRONT LID	41123
7	REAR LID	41120
8	AGITATOR BEARING HUB	43434
9	NEEDLE BEARING	47106
10*	SPUR GEAR KIT (Includes 2 gears with set screws. Always replace Agitator Spur Gear and Kettle Drive Motor Gear as a set.)	47059K
11	10-32 X 3/16 SET SCREW	41742
12	AGITATOR SHAFT ASSEMBLY	41093
13	1/2 ID X 7/8 OD SET COLLAR	47326
14	1/4-20 X 3/16 SET SCREW	47751



16 oz. Kettle Assembly (55199, 55199KC) – Agitator Assy. View

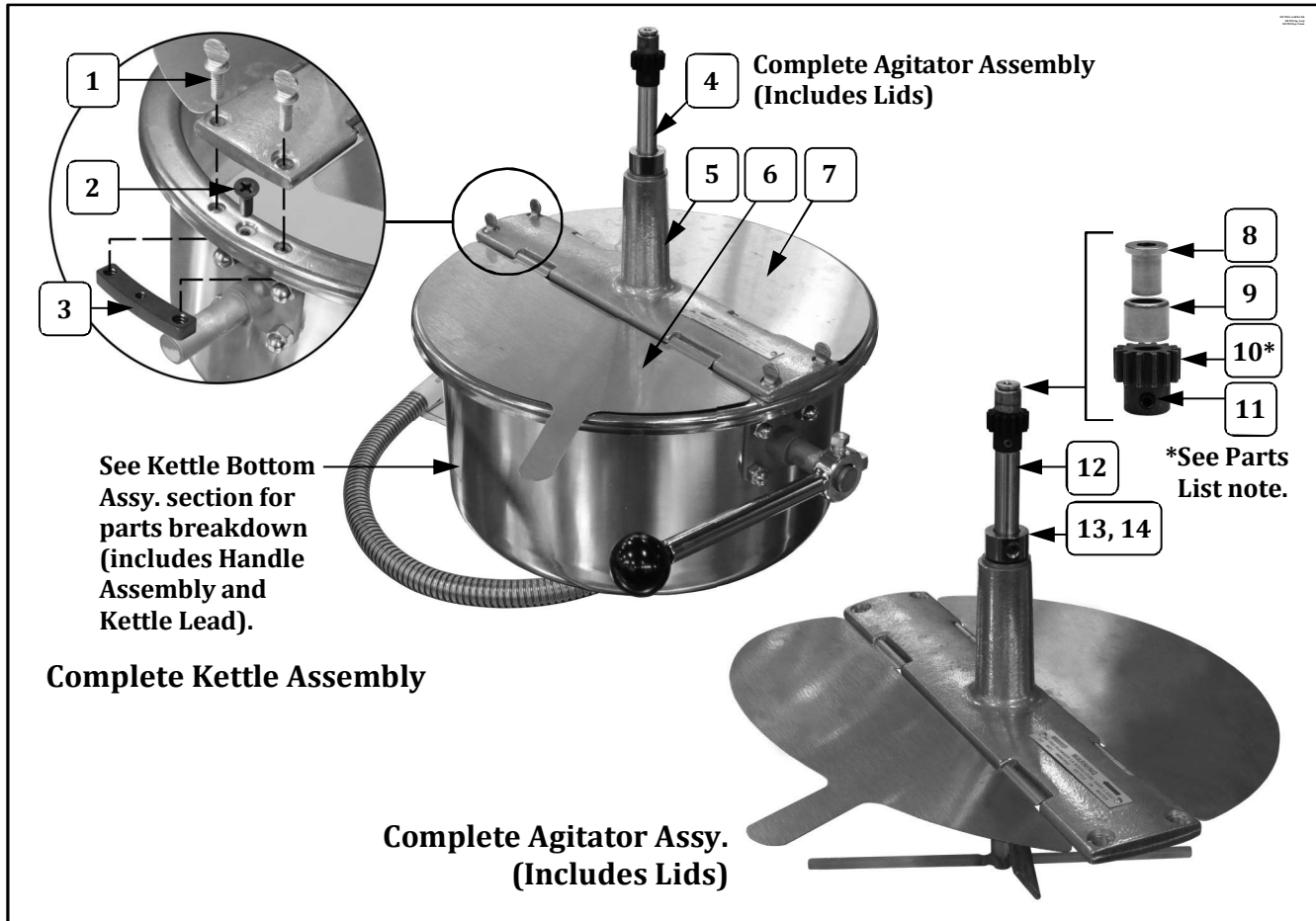

Item	Part Description	Part Number
		55199 55199KC
1	1/4-20 X 1 THUMB SCREW	47691
2	8-32 X 1/2 PHILL FLAT M/S ZINC	20066
3	THREADED BLOCK	61167
4	LID & AGITATOR ASSEMBLY (Complete Assy.)	41181
5	CROSSBAR ASSEMBLY	41180
6	FRONT LID	41123
7	REAR LID	41120
8	AGITATOR BEARING HUB	43434
9	NEEDLE BEARING	47106
10*	SPUR GEAR KIT (Includes 2 gears with set screws. Always replace Agitator Spur Gear and Kettle Drive Motor Gear as a set.)	47059K
11	10-32 X 3/16 SET SCREW	41742
12	AGITATOR SHAFT ASSEMBLY	41093
13	1/2 ID X 7/8 OD SET COLLAR	47326
14	1/4-20 X 3/16 SET SCREW	47751



16 oz. Kettle Assembly (55199, 55199KC) – Agitator Assy. View

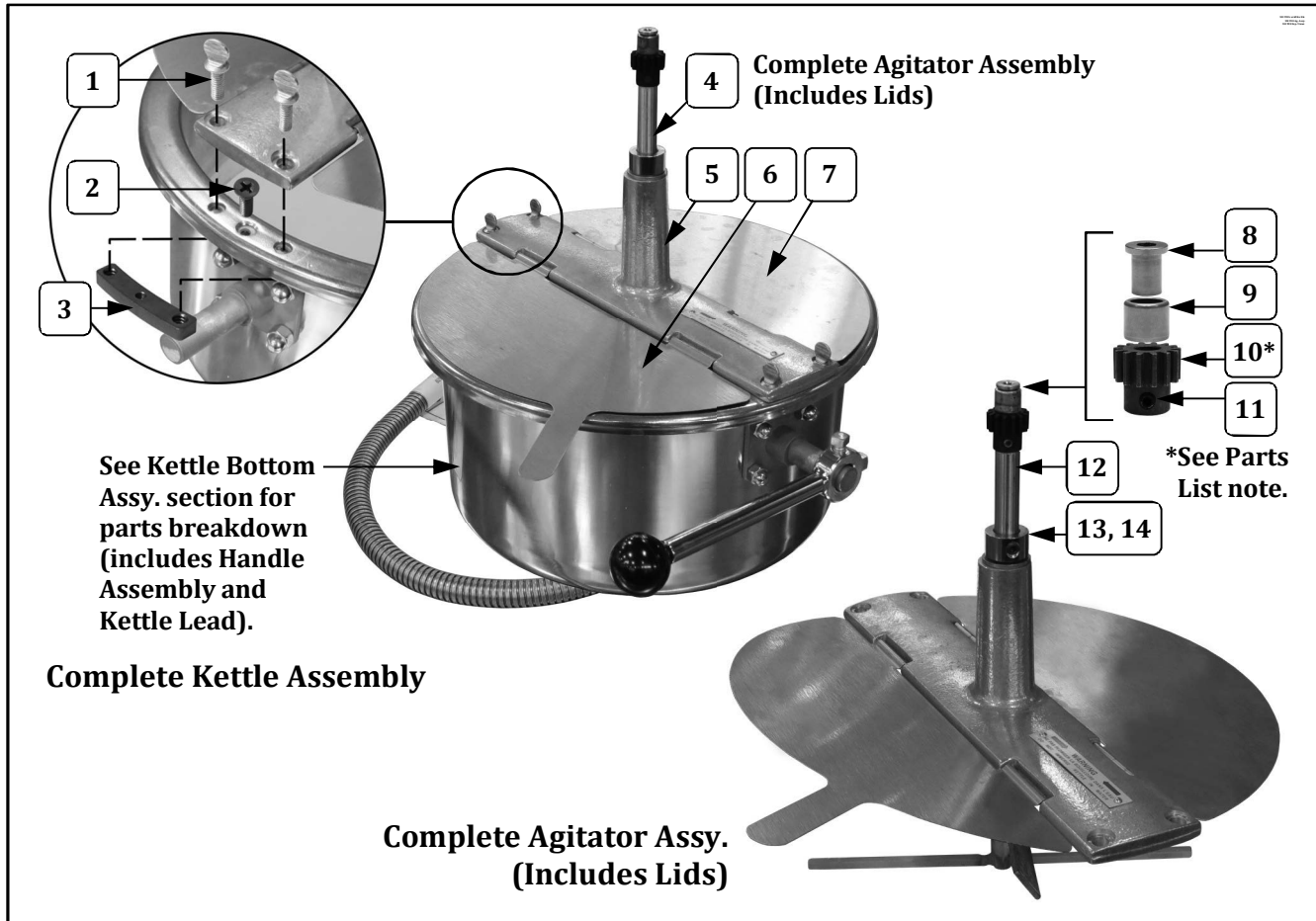

Item	Part Description	Part Number
		55199 55199KC
1	1/4-20 X 1 THUMB SCREW	47691
2	8-32 X 1/2 PHILL FLAT M/S ZINC	20066
3	THREADED BLOCK	61167
4	LID & AGITATOR ASSEMBLY (Complete Assy.)	41181
5	CROSSBAR ASSEMBLY	41180
6	FRONT LID	41123
7	REAR LID	41120
8	AGITATOR BEARING HUB	43434
9	NEEDLE BEARING	47106
10*	SPUR GEAR KIT (Includes 2 gears with set screws. Always replace Agitator Spur Gear and Kettle Drive Motor Gear as a set.)	47059K
11	10-32 X 3/16 SET SCREW	41742
12	AGITATOR SHAFT ASSEMBLY	41093
13	1/2 ID X 7/8 OD SET COLLAR	47326
14	1/4-20 X 3/16 SET SCREW	47751



16 oz. Kettle Assembly (55199, 55199KC) – Agitator Assy. View

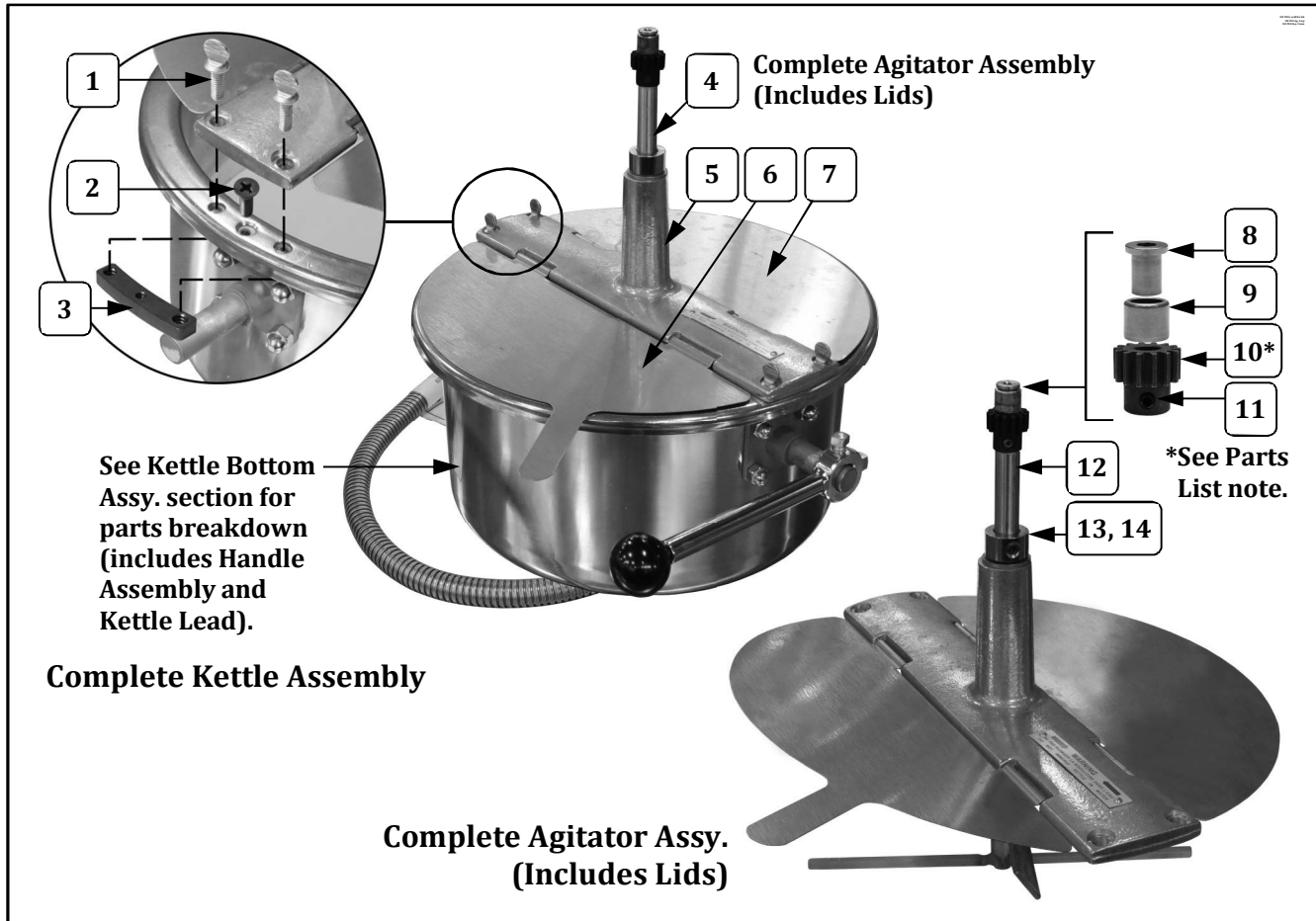

Item	Part Description	Part Number
		55199 55199KC
1	1/4-20 X 1 THUMB SCREW	47691
2	8-32 X 1/2 PHILL FLAT M/S ZINC	20066
3	THREADED BLOCK	61167
4	LID & AGITATOR ASSEMBLY (Complete Assy.)	41181
5	CROSSBAR ASSEMBLY	41180
6	FRONT LID	41123
7	REAR LID	41120
8	AGITATOR BEARING HUB	43434
9	NEEDLE BEARING	47106
10*	SPUR GEAR KIT (Includes 2 gears with set screws. Always replace Agitator Spur Gear and Kettle Drive Motor Gear as a set.)	47059K
11	10-32 X 3/16 SET SCREW	41742
12	AGITATOR SHAFT ASSEMBLY	41093
13	1/2 ID X 7/8 OD SET COLLAR	47326
14	1/4-20 X 3/16 SET SCREW	47751



16 oz. Kettle Assembly (55199, 55199KC) – Agitator Assy. View

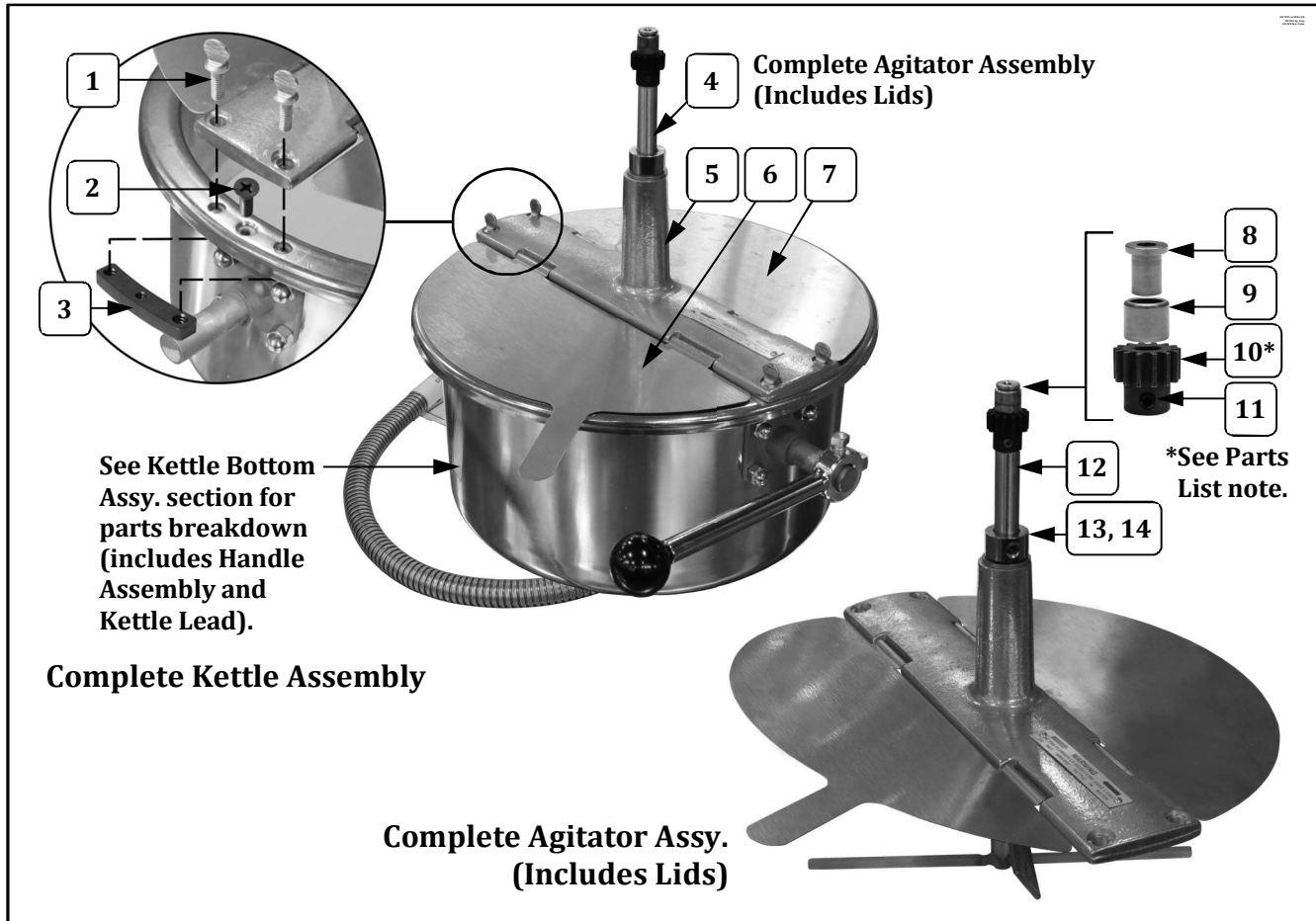

Item	Part Description	Part Number
		55199 55199KC
1	1/4-20 X 1 THUMB SCREW	47691
2	8-32 X 1/2 PHILL FLAT M/S ZINC	20066
3	THREADED BLOCK	61167
4	LID & AGITATOR ASSEMBLY (Complete Assy.)	41181
5	CROSSBAR ASSEMBLY	41180
6	FRONT LID	41123
7	REAR LID	41120
8	AGITATOR BEARING HUB	43434
9	NEEDLE BEARING	47106
10*	SPUR GEAR KIT (Includes 2 gears with set screws. Always replace Agitator Spur Gear and Kettle Drive Motor Gear as a set.)	47059K
11	10-32 X 3/16 SET SCREW	41742
12	AGITATOR SHAFT ASSEMBLY	41093
13	1/2 ID X 7/8 OD SET COLLAR	47326
14	1/4-20 X 3/16 SET SCREW	47751



16 oz. Kettle Assembly (55199, 55199KC) – Agitator Assy. View

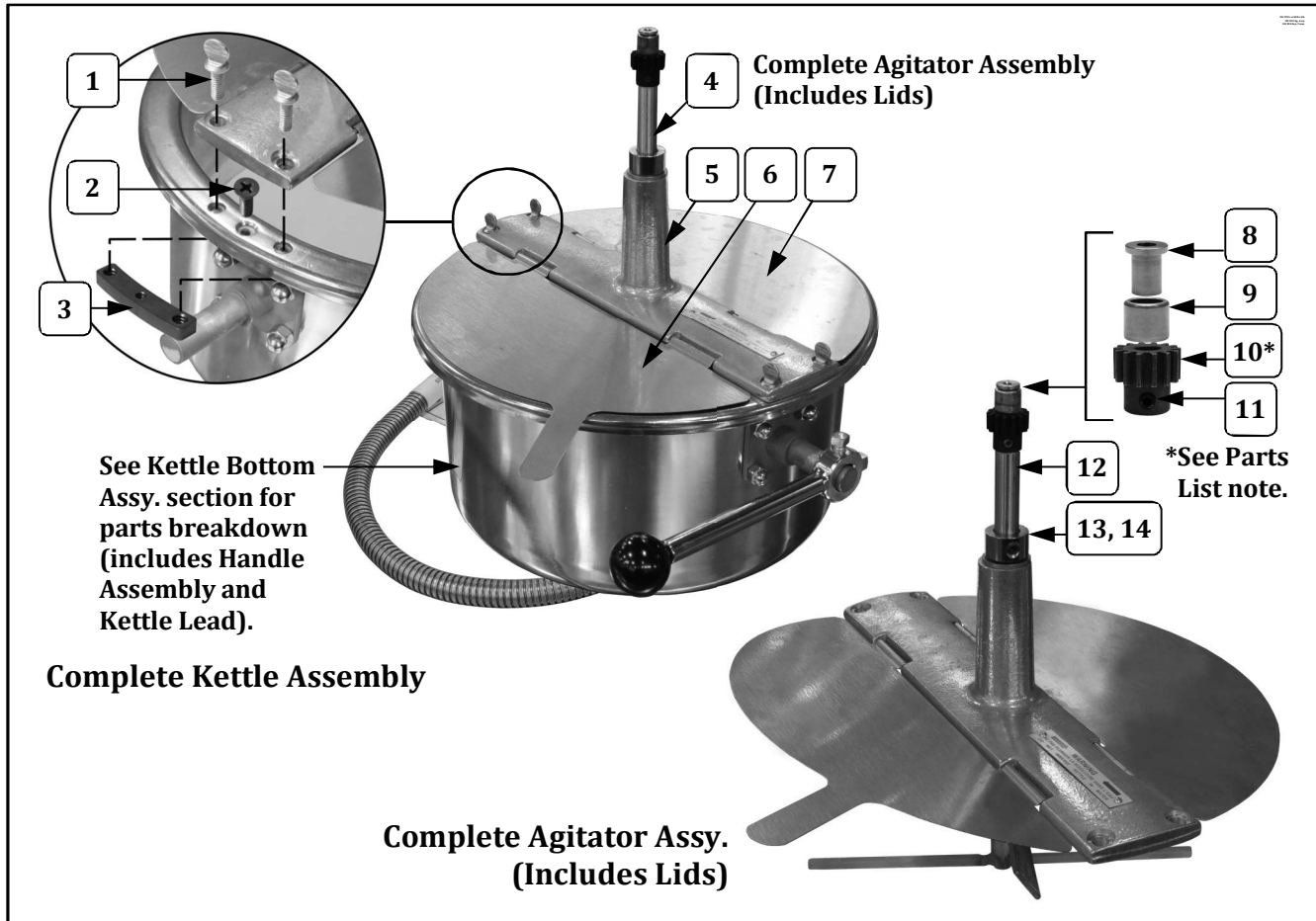

Item	Part Description	Part Number
		55199 55199KC
1	1/4-20 X 1 THUMB SCREW	47691
2	8-32 X 1/2 PHILL FLAT M/S ZINC	20066
3	THREADED BLOCK	61167
4	LID & AGITATOR ASSEMBLY (Complete Assy.)	41181
5	CROSSBAR ASSEMBLY	41180
6	FRONT LID	41123
7	REAR LID	41120
8	AGITATOR BEARING HUB	43434
9	NEEDLE BEARING	47106
10*	SPUR GEAR KIT (Includes 2 gears with set screws. Always replace Agitator Spur Gear and Kettle Drive Motor Gear as a set.)	47059K
11	10-32 X 3/16 SET SCREW	41742
12	AGITATOR SHAFT ASSEMBLY	41093
13	1/2 ID X 7/8 OD SET COLLAR	47326
14	1/4-20 X 3/16 SET SCREW	47751



16 oz. Kettle Assembly (55199, 55199KC) – Agitator Assy. View

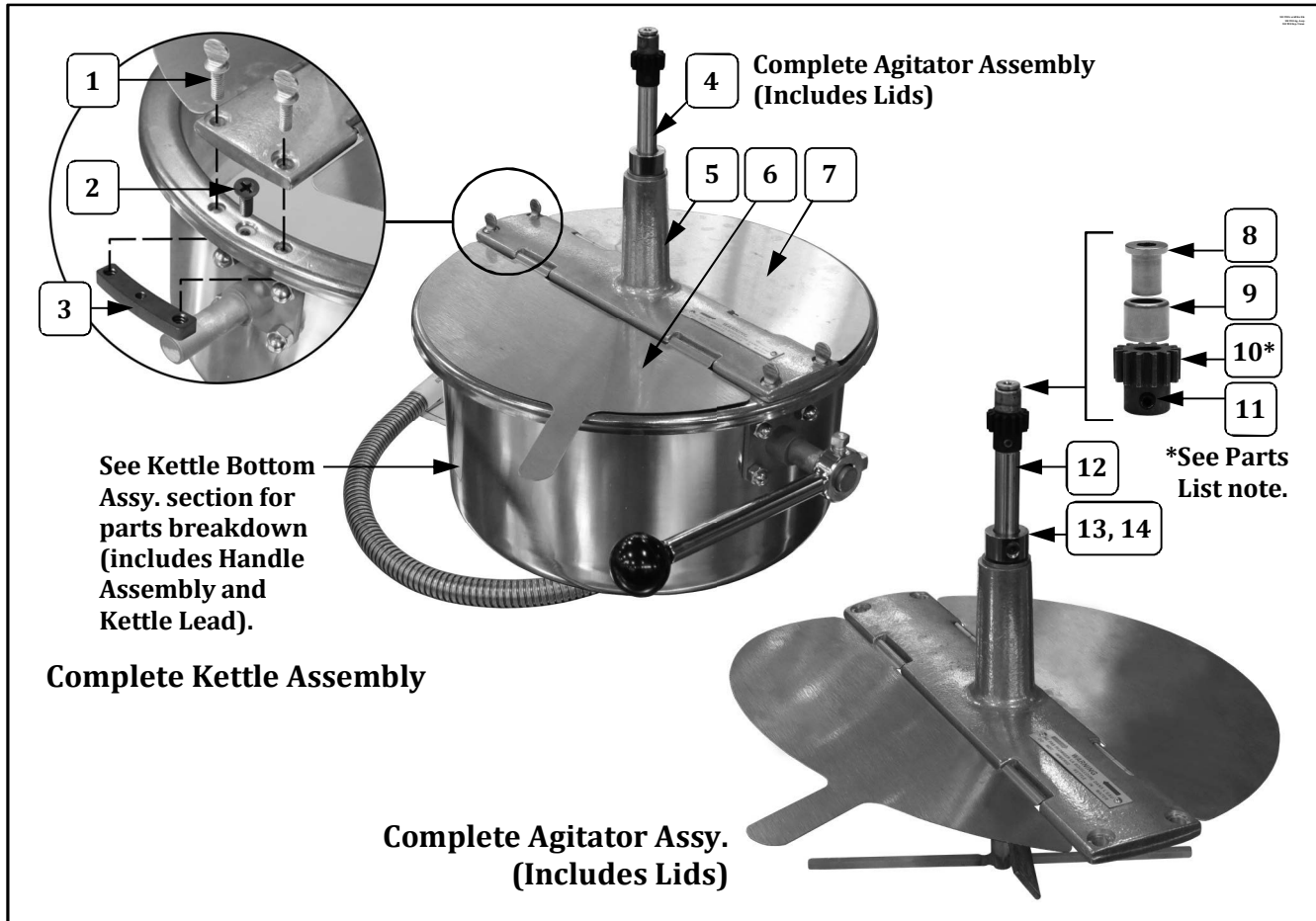

Item	Part Description	Part Number
		55199 55199KC
1	1/4-20 X 1 THUMB SCREW	47691
2	8-32 X 1/2 PHILL FLAT M/S ZINC	20066
3	THREADED BLOCK	61167
4	LID & AGITATOR ASSEMBLY (Complete Assy.)	41181
5	CROSSBAR ASSEMBLY	41180
6	FRONT LID	41123
7	REAR LID	41120
8	AGITATOR BEARING HUB	43434
9	NEEDLE BEARING	47106
10*	SPUR GEAR KIT (Includes 2 gears with set screws. Always replace Agitator Spur Gear and Kettle Drive Motor Gear as a set.)	47059K
11	10-32 X 3/16 SET SCREW	41742
12	AGITATOR SHAFT ASSEMBLY	41093
13	1/2 ID X 7/8 OD SET COLLAR	47326
14	1/4-20 X 3/16 SET SCREW	47751



16 oz. Kettle Assembly (55199, 55199KC) – Agitator Assy. View

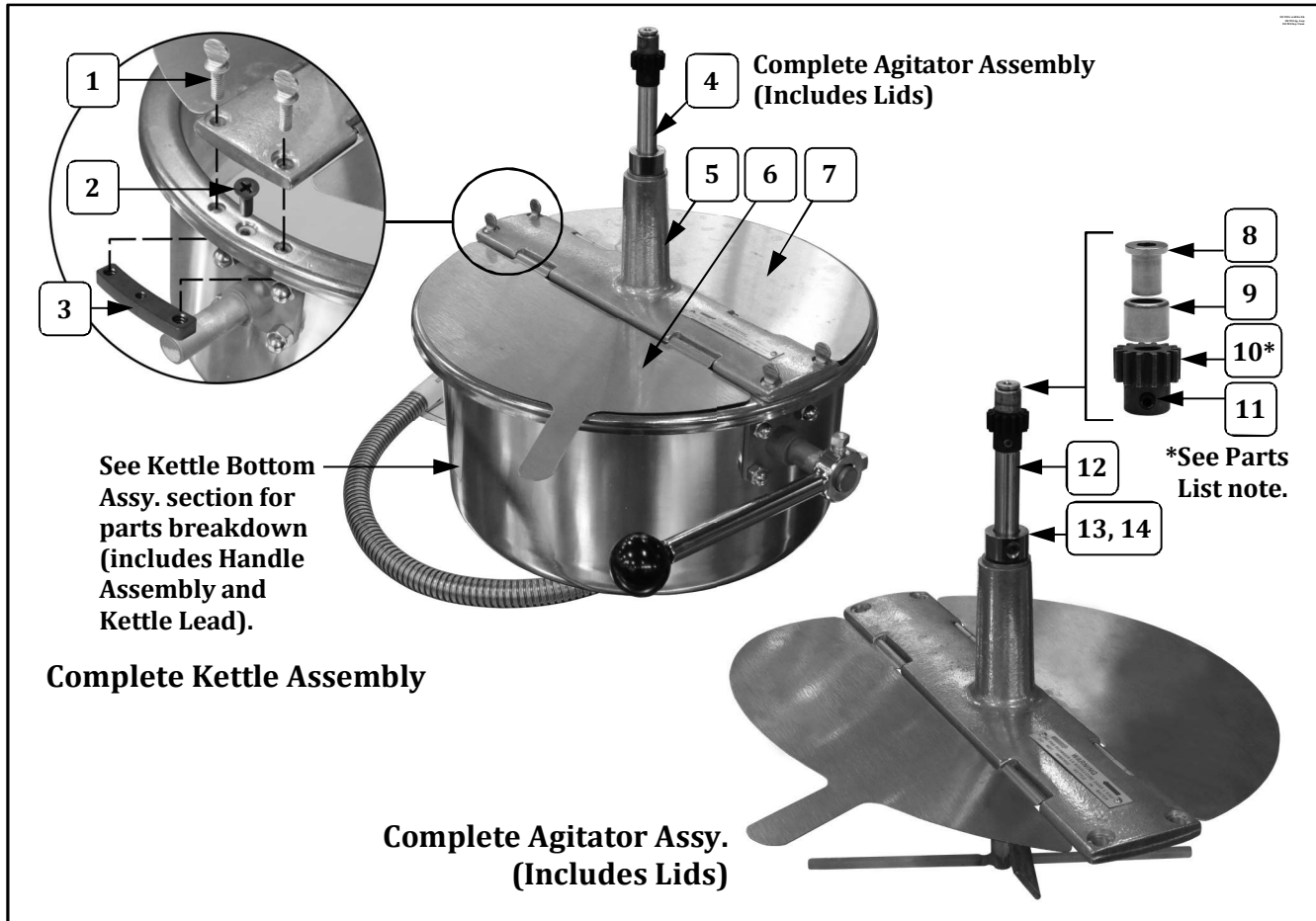

Item	Part Description	Part Number
		55199 55199KC
1	1/4-20 X 1 THUMB SCREW	47691
2	8-32 X 1/2 PHILL FLAT M/S ZINC	20066
3	THREADED BLOCK	61167
4	LID & AGITATOR ASSEMBLY (Complete Assy.)	41181
5	CROSSBAR ASSEMBLY	41180
6	FRONT LID	41123
7	REAR LID	41120
8	AGITATOR BEARING HUB	43434
9	NEEDLE BEARING	47106
10*	SPUR GEAR KIT (Includes 2 gears with set screws. Always replace Agitator Spur Gear and Kettle Drive Motor Gear as a set.)	47059K
11	10-32 X 3/16 SET SCREW	41742
12	AGITATOR SHAFT ASSEMBLY	41093
13	1/2 ID X 7/8 OD SET COLLAR	47326
14	1/4-20 X 3/16 SET SCREW	47751



16 oz. Kettle Assembly (55199, 55199KC) – Agitator Assy. View

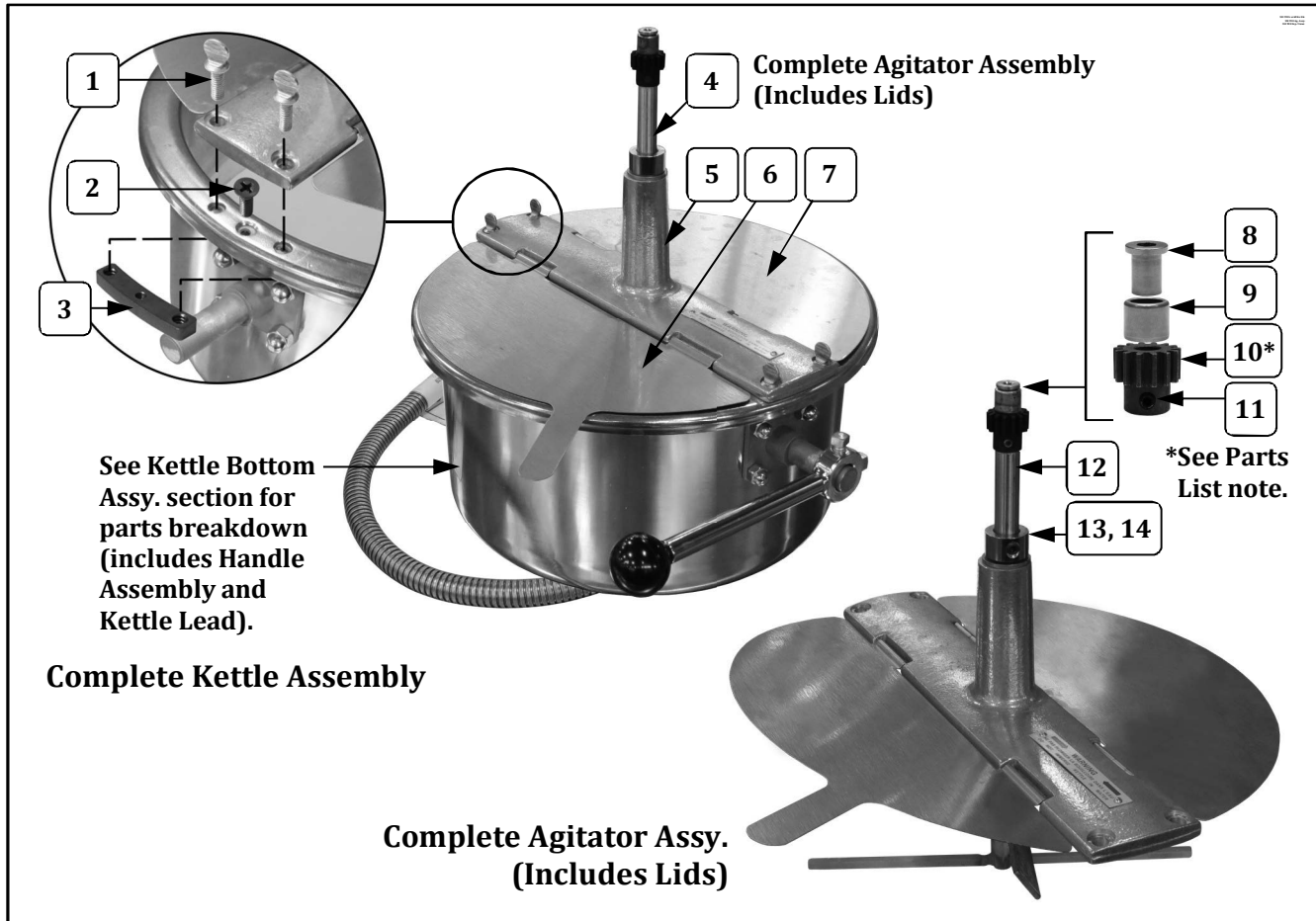

Item	Part Description	Part Number
		55199 55199KC
1	1/4-20 X 1 THUMB SCREW	47691
2	8-32 X 1/2 PHILL FLAT M/S ZINC	20066
3	THREADED BLOCK	61167
4	LID & AGITATOR ASSEMBLY (Complete Assy.)	41181
5	CROSSBAR ASSEMBLY	41180
6	FRONT LID	41123
7	REAR LID	41120
8	AGITATOR BEARING HUB	43434
9	NEEDLE BEARING	47106
10*	SPUR GEAR KIT (Includes 2 gears with set screws. Always replace Agitator Spur Gear and Kettle Drive Motor Gear as a set.)	47059K
11	10-32 X 3/16 SET SCREW	41742
12	AGITATOR SHAFT ASSEMBLY	41093
13	1/2 ID X 7/8 OD SET COLLAR	47326
14	1/4-20 X 3/16 SET SCREW	47751



16 oz. Kettle Assembly (55199, 55199KC) – Kettle Bottom Assy.

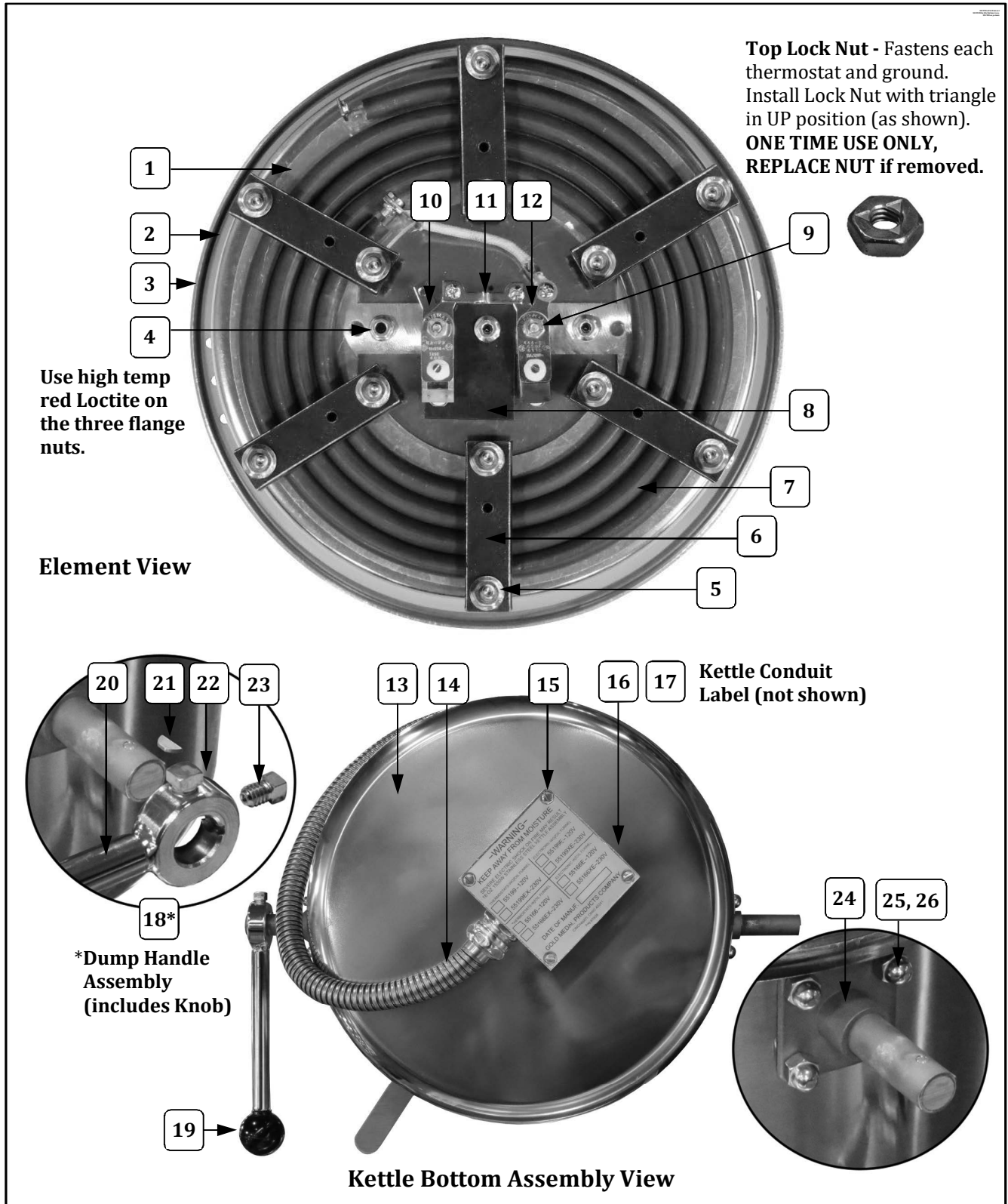

16 oz. Kettle Assembly (55199, 55199KC) – Kettle Bottom Assy.

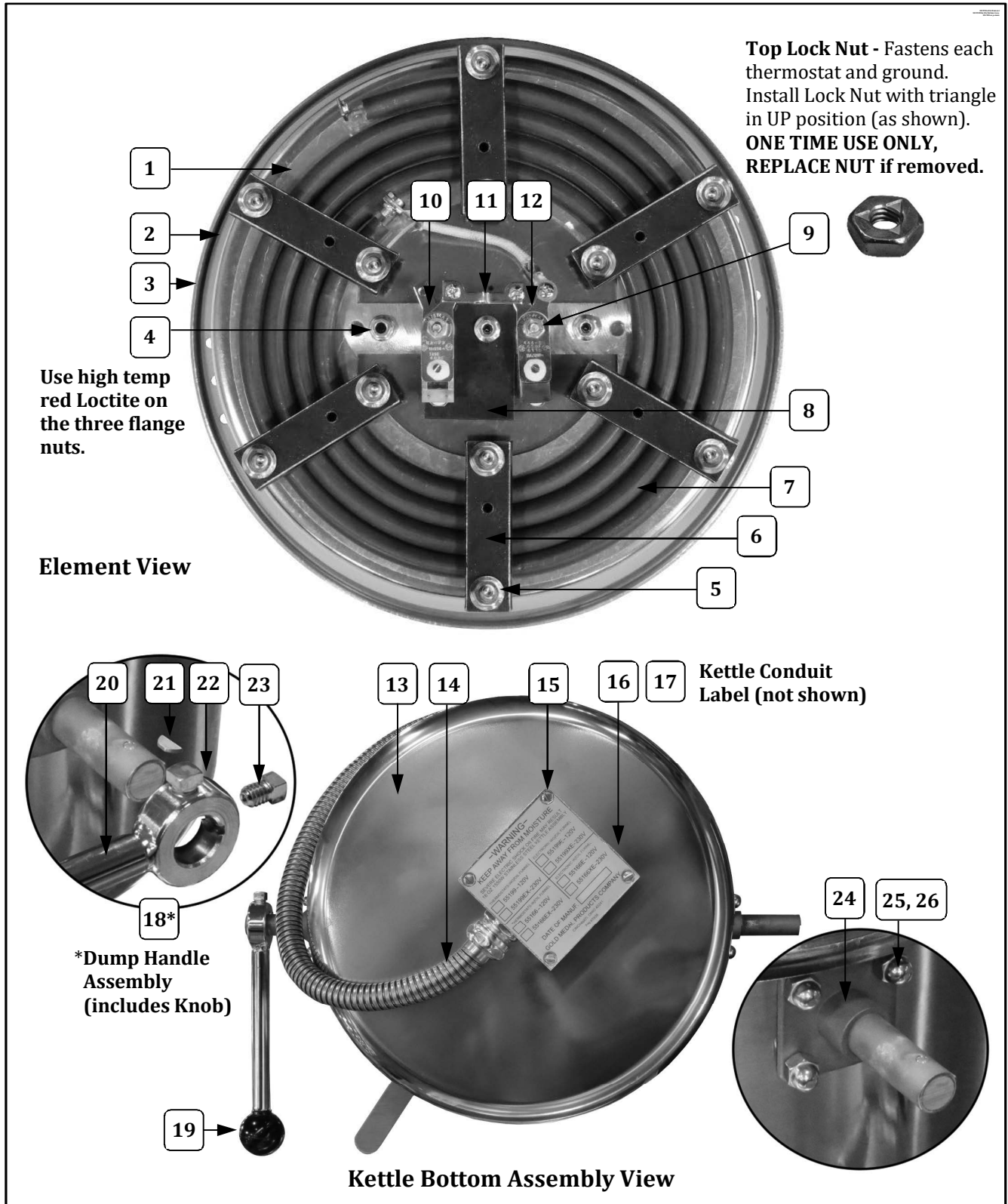



16 oz. Kettle Assembly (55199, 55199KC) – Kettle Bottom Assembly – Parts List

Item	Part Description	Part Number	
		55199	55199KC
	16OZ KETTLE BOTTOM ASSY (Complete Assy.)	55200	55200KC
1	TRANSFER PLATE ASSY (beneath heat element)	67944	67944
2	KETTLE GASKET	41598	41598
3	KETTLE WELDMENT	67892	67892
4	8-32 SERRATED FLANGE NUT		
5	¼ - 20 SERRATED LOCK NUT	46311	46311
6	ELEMENT CLAMP (6 required)	67894	67894
7	1550 TUBULAR HEAT ELEMENT	67014	67014
8	LIMIT THERMOSTAT SHIELD	67959	67959
9	8-32 TOP LOCK NUT (always replace if removed)	67943	67943
10	482 F THERMOSTAT (includes two 6-32 screws)	76708	
10	420 F THERMOSTAT (includes two 6-32 screws)		76707
11	THERMOSTAT SHUNT BAR	47193	47193
12	550 F THERMOSTAT (includes two 6-32 screws)	77108	77108
13	KETTLE SHELL ASSEMBLY (has Pivot Pins attached)	41081	41081
14	KETTLE LEAD ASSEMBLY	47361	47361
15	8-32 x 3/8 SLT HWHW M/S (fastens Nameplate to Jct. Box, and fastens Jct. Box to Kettle)	42044	42044
16	JUNCTION BOX	47393	47393
17	KETTLE CONDUIT LABEL	82840	82840
18	DUMP HANDLE ASSEMBLY (assembly includes Handle, Knob, 2 SQ HD Screws, and Key)	47102	47102
19	DUMP HANDLE KNOB	47110	47110
20	DUMP HANDLE	47707	47707
21	3 1/8 X ½ WOODRUFF KEY	41730	41730
22	5/16 - 18 X ½ SQ HD SCREW	47725	47725
23	5/16 - 18 X 3/8 SQ HD SCREW (holds key)	47662	47662
24	PIVOT PIN	41426	41426
25	1/4-20 ACORN NUT	42229	42229
26	1/4-20 X 3/8 BUTTON HEAD	12492	12492



16 oz. Kettle Assembly (55199, 55199KC) – Kettle Bottom Assembly – Parts List

Item	Part Description	Part Number	
		55199	55199KC
	16OZ KETTLE BOTTOM ASSY (Complete Assy.)	55200	55200KC
1	TRANSFER PLATE ASSY (beneath heat element)	67944	67944
2	KETTLE GASKET	41598	41598
3	KETTLE WELDMENT	67892	67892
4	8-32 SERRATED FLANGE NUT		
5	¼ - 20 SERRATED LOCK NUT	46311	46311
6	ELEMENT CLAMP (6 required)	67894	67894
7	1550 TUBULAR HEAT ELEMENT	67014	67014
8	LIMIT THERMOSTAT SHIELD	67959	67959
9	8-32 TOP LOCK NUT (always replace if removed)	67943	67943
10	482 F THERMOSTAT (includes two 6-32 screws)	76708	
10	420 F THERMOSTAT (includes two 6-32 screws)		76707
11	THERMOSTAT SHUNT BAR	47193	47193
12	550 F THERMOSTAT (includes two 6-32 screws)	77108	77108
13	KETTLE SHELL ASSEMBLY (has Pivot Pins attached)	41081	41081
14	KETTLE LEAD ASSEMBLY	47361	47361
15	8-32 x 3/8 SLT HWHW M/S (fastens Nameplate to Jct. Box, and fastens Jct. Box to Kettle)	42044	42044
16	JUNCTION BOX	47393	47393
17	KETTLE CONDUIT LABEL	82840	82840
18	DUMP HANDLE ASSEMBLY (assembly includes Handle, Knob, 2 SQ HD Screws, and Key)	47102	47102
19	DUMP HANDLE KNOB	47110	47110
20	DUMP HANDLE	47707	47707
21	3 1/8 X ½ WOODRUFF KEY	41730	41730
22	5/16 - 18 X ½ SQ HD SCREW	47725	47725
23	5/16 - 18 X 3/8 SQ HD SCREW (holds key)	47662	47662
24	PIVOT PIN	41426	41426
25	1/4-20 ACORN NUT	42229	42229
26	1/4-20 X 3/8 BUTTON HEAD	12492	12492



16 oz. Kettle Assembly (55199, 55199KC) – Kettle Bottom Assembly – Parts List

Item	Part Description	Part Number	
		55199	55199KC
	16OZ KETTLE BOTTOM ASSY (Complete Assy.)	55200	55200KC
1	TRANSFER PLATE ASSY (beneath heat element)	67944	67944
2	KETTLE GASKET	41598	41598
3	KETTLE WELDMENT	67892	67892
4	8-32 SERRATED FLANGE NUT		
5	¼ - 20 SERRATED LOCK NUT	46311	46311
6	ELEMENT CLAMP (6 required)	67894	67894
7	1550 TUBULAR HEAT ELEMENT	67014	67014
8	LIMIT THERMOSTAT SHIELD	67959	67959
9	8-32 TOP LOCK NUT (always replace if removed)	67943	67943
10	482 F THERMOSTAT (includes two 6-32 screws)	76708	
10	420 F THERMOSTAT (includes two 6-32 screws)		76707
11	THERMOSTAT SHUNT BAR	47193	47193
12	550 F THERMOSTAT (includes two 6-32 screws)	77108	77108
13	KETTLE SHELL ASSEMBLY (has Pivot Pins attached)	41081	41081
14	KETTLE LEAD ASSEMBLY	47361	47361
15	8-32 x 3/8 SLT HWHW M/S (fastens Nameplate to Jct. Box, and fastens Jct. Box to Kettle)	42044	42044
16	JUNCTION BOX	47393	47393
17	KETTLE CONDUIT LABEL	82840	82840
18	DUMP HANDLE ASSEMBLY (assembly includes Handle, Knob, 2 SQ HD Screws, and Key)	47102	47102
19	DUMP HANDLE KNOB	47110	47110
20	DUMP HANDLE	47707	47707
21	3 1/8 X ½ WOODRUFF KEY	41730	41730
22	5/16 - 18 X ½ SQ HD SCREW	47725	47725
23	5/16 - 18 X 3/8 SQ HD SCREW (holds key)	47662	47662
24	PIVOT PIN	41426	41426
25	1/4-20 ACORN NUT	42229	42229
26	1/4-20 X 3/8 BUTTON HEAD	12492	12492



16 oz. Kettle Assembly (55199, 55199KC) – Kettle Bottom Assembly – Parts List

Item	Part Description	Part Number	
		55199	55199KC
	16OZ KETTLE BOTTOM ASSY (Complete Assy.)	55200	55200KC
1	TRANSFER PLATE ASSY (beneath heat element)	67944	67944
2	KETTLE GASKET	41598	41598
3	KETTLE WELDMENT	67892	67892
4	8-32 SERRATED FLANGE NUT		
5	¼ - 20 SERRATED LOCK NUT	46311	46311
6	ELEMENT CLAMP (6 required)	67894	67894
7	1550 TUBULAR HEAT ELEMENT	67014	67014
8	LIMIT THERMOSTAT SHIELD	67959	67959
9	8-32 TOP LOCK NUT (always replace if removed)	67943	67943
10	482 F THERMOSTAT (includes two 6-32 screws)	76708	
10	420 F THERMOSTAT (includes two 6-32 screws)		76707
11	THERMOSTAT SHUNT BAR	47193	47193
12	550 F THERMOSTAT (includes two 6-32 screws)	77108	77108
13	KETTLE SHELL ASSEMBLY (has Pivot Pins attached)	41081	41081
14	KETTLE LEAD ASSEMBLY	47361	47361
15	8-32 x 3/8 SLT HWHW M/S (fastens Nameplate to Jct. Box, and fastens Jct. Box to Kettle)	42044	42044
16	JUNCTION BOX	47393	47393
17	KETTLE CONDUIT LABEL	82840	82840
18	DUMP HANDLE ASSEMBLY (assembly includes Handle, Knob, 2 SQ HD Screws, and Key)	47102	47102
19	DUMP HANDLE KNOB	47110	47110
20	DUMP HANDLE	47707	47707
21	3 1/8 X ½ WOODRUFF KEY	41730	41730
22	5/16 - 18 X ½ SQ HD SCREW	47725	47725
23	5/16 - 18 X 3/8 SQ HD SCREW (holds key)	47662	47662
24	PIVOT PIN	41426	41426
25	1/4-20 ACORN NUT	42229	42229
26	1/4-20 X 3/8 BUTTON HEAD	12492	12492



16 oz. Kettle Assembly (55199, 55199KC) – Kettle Bottom Assembly – Parts List

Item	Part Description	Part Number	
		55199	55199KC
	16OZ KETTLE BOTTOM ASSY (Complete Assy.)	55200	55200KC
1	TRANSFER PLATE ASSY (beneath heat element)	67944	67944
2	KETTLE GASKET	41598	41598
3	KETTLE WELDMENT	67892	67892
4	8-32 SERRATED FLANGE NUT		
5	¼ - 20 SERRATED LOCK NUT	46311	46311
6	ELEMENT CLAMP (6 required)	67894	67894
7	1550 TUBULAR HEAT ELEMENT	67014	67014
8	LIMIT THERMOSTAT SHIELD	67959	67959
9	8-32 TOP LOCK NUT (always replace if removed)	67943	67943
10	482 F THERMOSTAT (includes two 6-32 screws)	76708	
10	420 F THERMOSTAT (includes two 6-32 screws)		76707
11	THERMOSTAT SHUNT BAR	47193	47193
12	550 F THERMOSTAT (includes two 6-32 screws)	77108	77108
13	KETTLE SHELL ASSEMBLY (has Pivot Pins attached)	41081	41081
14	KETTLE LEAD ASSEMBLY	47361	47361
15	8-32 x 3/8 SLT HWHW M/S (fastens Nameplate to Jct. Box, and fastens Jct. Box to Kettle)	42044	42044
16	JUNCTION BOX	47393	47393
17	KETTLE CONDUIT LABEL	82840	82840
18	DUMP HANDLE ASSEMBLY (assembly includes Handle, Knob, 2 SQ HD Screws, and Key)	47102	47102
19	DUMP HANDLE KNOB	47110	47110
20	DUMP HANDLE	47707	47707
21	3 1/8 X ½ WOODRUFF KEY	41730	41730
22	5/16 - 18 X ½ SQ HD SCREW	47725	47725
23	5/16 - 18 X 3/8 SQ HD SCREW (holds key)	47662	47662
24	PIVOT PIN	41426	41426
25	1/4-20 ACORN NUT	42229	42229
26	1/4-20 X 3/8 BUTTON HEAD	12492	12492



16 oz. Kettle Assembly (55199, 55199KC) – Kettle Bottom Assembly – Parts List

Item	Part Description	Part Number	
		55199	55199KC
	16OZ KETTLE BOTTOM ASSY (Complete Assy.)	55200	55200KC
1	TRANSFER PLATE ASSY (beneath heat element)	67944	67944
2	KETTLE GASKET	41598	41598
3	KETTLE WELDMENT	67892	67892
4	8-32 SERRATED FLANGE NUT		
5	¼ - 20 SERRATED LOCK NUT	46311	46311
6	ELEMENT CLAMP (6 required)	67894	67894
7	1550 TUBULAR HEAT ELEMENT	67014	67014
8	LIMIT THERMOSTAT SHIELD	67959	67959
9	8-32 TOP LOCK NUT (always replace if removed)	67943	67943
10	482 F THERMOSTAT (includes two 6-32 screws)	76708	
10	420 F THERMOSTAT (includes two 6-32 screws)		76707
11	THERMOSTAT SHUNT BAR	47193	47193
12	550 F THERMOSTAT (includes two 6-32 screws)	77108	77108
13	KETTLE SHELL ASSEMBLY (has Pivot Pins attached)	41081	41081
14	KETTLE LEAD ASSEMBLY	47361	47361
15	8-32 x 3/8 SLT HWHW M/S (fastens Nameplate to Jct. Box, and fastens Jct. Box to Kettle)	42044	42044
16	JUNCTION BOX	47393	47393
17	KETTLE CONDUIT LABEL	82840	82840
18	DUMP HANDLE ASSEMBLY (assembly includes Handle, Knob, 2 SQ HD Screws, and Key)	47102	47102
19	DUMP HANDLE KNOB	47110	47110
20	DUMP HANDLE	47707	47707
21	3 1/8 X ½ WOODRUFF KEY	41730	41730
22	5/16 - 18 X ½ SQ HD SCREW	47725	47725
23	5/16 - 18 X 3/8 SQ HD SCREW (holds key)	47662	47662
24	PIVOT PIN	41426	41426
25	1/4-20 ACORN NUT	42229	42229
26	1/4-20 X 3/8 BUTTON HEAD	12492	12492



16 oz. Kettle Assembly (55199, 55199KC) – Kettle Bottom Assembly – Parts List

Item	Part Description	Part Number	
		55199	55199KC
	16OZ KETTLE BOTTOM ASSY (Complete Assy.)	55200	55200KC
1	TRANSFER PLATE ASSY (beneath heat element)	67944	67944
2	KETTLE GASKET	41598	41598
3	KETTLE WELDMENT	67892	67892
4	8-32 SERRATED FLANGE NUT		
5	¼ - 20 SERRATED LOCK NUT	46311	46311
6	ELEMENT CLAMP (6 required)	67894	67894
7	1550 TUBULAR HEAT ELEMENT	67014	67014
8	LIMIT THERMOSTAT SHIELD	67959	67959
9	8-32 TOP LOCK NUT (always replace if removed)	67943	67943
10	482 F THERMOSTAT (includes two 6-32 screws)	76708	
10	420 F THERMOSTAT (includes two 6-32 screws)		76707
11	THERMOSTAT SHUNT BAR	47193	47193
12	550 F THERMOSTAT (includes two 6-32 screws)	77108	77108
13	KETTLE SHELL ASSEMBLY (has Pivot Pins attached)	41081	41081
14	KETTLE LEAD ASSEMBLY	47361	47361
15	8-32 x 3/8 SLT HWHW M/S (fastens Nameplate to Jct. Box, and fastens Jct. Box to Kettle)	42044	42044
16	JUNCTION BOX	47393	47393
17	KETTLE CONDUIT LABEL	82840	82840
18	DUMP HANDLE ASSEMBLY (assembly includes Handle, Knob, 2 SQ HD Screws, and Key)	47102	47102
19	DUMP HANDLE KNOB	47110	47110
20	DUMP HANDLE	47707	47707
21	3 1/8 X ½ WOODRUFF KEY	41730	41730
22	5/16 - 18 X ½ SQ HD SCREW	47725	47725
23	5/16 - 18 X 3/8 SQ HD SCREW (holds key)	47662	47662
24	PIVOT PIN	41426	41426
25	1/4-20 ACORN NUT	42229	42229
26	1/4-20 X 3/8 BUTTON HEAD	12492	12492



16 oz. Kettle Assembly (55199, 55199KC) – Kettle Bottom Assembly – Parts List

Item	Part Description	Part Number	
		55199	55199KC
	16OZ KETTLE BOTTOM ASSY (Complete Assy.)	55200	55200KC
1	TRANSFER PLATE ASSY (beneath heat element)	67944	67944
2	KETTLE GASKET	41598	41598
3	KETTLE WELDMENT	67892	67892
4	8-32 SERRATED FLANGE NUT		
5	¼ - 20 SERRATED LOCK NUT	46311	46311
6	ELEMENT CLAMP (6 required)	67894	67894
7	1550 TUBULAR HEAT ELEMENT	67014	67014
8	LIMIT THERMOSTAT SHIELD	67959	67959
9	8-32 TOP LOCK NUT (always replace if removed)	67943	67943
10	482 F THERMOSTAT (includes two 6-32 screws)	76708	
10	420 F THERMOSTAT (includes two 6-32 screws)		76707
11	THERMOSTAT SHUNT BAR	47193	47193
12	550 F THERMOSTAT (includes two 6-32 screws)	77108	77108
13	KETTLE SHELL ASSEMBLY (has Pivot Pins attached)	41081	41081
14	KETTLE LEAD ASSEMBLY	47361	47361
15	8-32 x 3/8 SLT HWHW M/S (fastens Nameplate to Jct. Box, and fastens Jct. Box to Kettle)	42044	42044
16	JUNCTION BOX	47393	47393
17	KETTLE CONDUIT LABEL	82840	82840
18	DUMP HANDLE ASSEMBLY (assembly includes Handle, Knob, 2 SQ HD Screws, and Key)	47102	47102
19	DUMP HANDLE KNOB	47110	47110
20	DUMP HANDLE	47707	47707
21	3 1/8 X ½ WOODRUFF KEY	41730	41730
22	5/16 - 18 X ½ SQ HD SCREW	47725	47725
23	5/16 - 18 X 3/8 SQ HD SCREW (holds key)	47662	47662
24	PIVOT PIN	41426	41426
25	1/4-20 ACORN NUT	42229	42229
26	1/4-20 X 3/8 BUTTON HEAD	12492	12492



16 oz. Kettle Assembly (55199, 55199KC) – Kettle Bottom Assembly – Parts List

Item	Part Description	Part Number	
		55199	55199KC
	16OZ KETTLE BOTTOM ASSY (Complete Assy.)	55200	55200KC
1	TRANSFER PLATE ASSY (beneath heat element)	67944	67944
2	KETTLE GASKET	41598	41598
3	KETTLE WELDMENT	67892	67892
4	8-32 SERRATED FLANGE NUT		
5	¼ - 20 SERRATED LOCK NUT	46311	46311
6	ELEMENT CLAMP (6 required)	67894	67894
7	1550 TUBULAR HEAT ELEMENT	67014	67014
8	LIMIT THERMOSTAT SHIELD	67959	67959
9	8-32 TOP LOCK NUT (always replace if removed)	67943	67943
10	482 F THERMOSTAT (includes two 6-32 screws)	76708	
10	420 F THERMOSTAT (includes two 6-32 screws)		76707
11	THERMOSTAT SHUNT BAR	47193	47193
12	550 F THERMOSTAT (includes two 6-32 screws)	77108	77108
13	KETTLE SHELL ASSEMBLY (has Pivot Pins attached)	41081	41081
14	KETTLE LEAD ASSEMBLY	47361	47361
15	8-32 x 3/8 SLT HWHW M/S (fastens Nameplate to Jct. Box, and fastens Jct. Box to Kettle)	42044	42044
16	JUNCTION BOX	47393	47393
17	KETTLE CONDUIT LABEL	82840	82840
18	DUMP HANDLE ASSEMBLY (assembly includes Handle, Knob, 2 SQ HD Screws, and Key)	47102	47102
19	DUMP HANDLE KNOB	47110	47110
20	DUMP HANDLE	47707	47707
21	3 1/8 X ½ WOODRUFF KEY	41730	41730
22	5/16 - 18 X ½ SQ HD SCREW	47725	47725
23	5/16 - 18 X 3/8 SQ HD SCREW (holds key)	47662	47662
24	PIVOT PIN	41426	41426
25	1/4-20 ACORN NUT	42229	42229
26	1/4-20 X 3/8 BUTTON HEAD	12492	12492



16 oz. Kettle Assembly (55199, 55199KC) – Kettle Bottom Assembly – Parts List

Item	Part Description	Part Number	
		55199	55199KC
	16OZ KETTLE BOTTOM ASSY (Complete Assy.)	55200	55200KC
1	TRANSFER PLATE ASSY (beneath heat element)	67944	67944
2	KETTLE GASKET	41598	41598
3	KETTLE WELDMENT	67892	67892
4	8-32 SERRATED FLANGE NUT		
5	¼ - 20 SERRATED LOCK NUT	46311	46311
6	ELEMENT CLAMP (6 required)	67894	67894
7	1550 TUBULAR HEAT ELEMENT	67014	67014
8	LIMIT THERMOSTAT SHIELD	67959	67959
9	8-32 TOP LOCK NUT (always replace if removed)	67943	67943
10	482 F THERMOSTAT (includes two 6-32 screws)	76708	
10	420 F THERMOSTAT (includes two 6-32 screws)		76707
11	THERMOSTAT SHUNT BAR	47193	47193
12	550 F THERMOSTAT (includes two 6-32 screws)	77108	77108
13	KETTLE SHELL ASSEMBLY (has Pivot Pins attached)	41081	41081
14	KETTLE LEAD ASSEMBLY	47361	47361
15	8-32 x 3/8 SLT HWHW M/S (fastens Nameplate to Jct. Box, and fastens Jct. Box to Kettle)	42044	42044
16	JUNCTION BOX	47393	47393
17	KETTLE CONDUIT LABEL	82840	82840
18	DUMP HANDLE ASSEMBLY (assembly includes Handle, Knob, 2 SQ HD Screws, and Key)	47102	47102
19	DUMP HANDLE KNOB	47110	47110
20	DUMP HANDLE	47707	47707
21	3 1/8 X ½ WOODRUFF KEY	41730	41730
22	5/16 - 18 X ½ SQ HD SCREW	47725	47725
23	5/16 - 18 X 3/8 SQ HD SCREW (holds key)	47662	47662
24	PIVOT PIN	41426	41426
25	1/4-20 ACORN NUT	42229	42229
26	1/4-20 X 3/8 BUTTON HEAD	12492	12492



16 oz. Kettle Assembly (55199, 55199KC) – Kettle Bottom Assembly – Parts List

Item	Part Description	Part Number	
		55199	55199KC
	16OZ KETTLE BOTTOM ASSY (Complete Assy.)	55200	55200KC
1	TRANSFER PLATE ASSY (beneath heat element)	67944	67944
2	KETTLE GASKET	41598	41598
3	KETTLE WELDMENT	67892	67892
4	8-32 SERRATED FLANGE NUT		
5	¼ - 20 SERRATED LOCK NUT	46311	46311
6	ELEMENT CLAMP (6 required)	67894	67894
7	1550 TUBULAR HEAT ELEMENT	67014	67014
8	LIMIT THERMOSTAT SHIELD	67959	67959
9	8-32 TOP LOCK NUT (always replace if removed)	67943	67943
10	482 F THERMOSTAT (includes two 6-32 screws)	76708	
10	420 F THERMOSTAT (includes two 6-32 screws)		76707
11	THERMOSTAT SHUNT BAR	47193	47193
12	550 F THERMOSTAT (includes two 6-32 screws)	77108	77108
13	KETTLE SHELL ASSEMBLY (has Pivot Pins attached)	41081	41081
14	KETTLE LEAD ASSEMBLY	47361	47361
15	8-32 x 3/8 SLT HWHW M/S (fastens Nameplate to Jct. Box, and fastens Jct. Box to Kettle)	42044	42044
16	JUNCTION BOX	47393	47393
17	KETTLE CONDUIT LABEL	82840	82840
18	DUMP HANDLE ASSEMBLY (assembly includes Handle, Knob, 2 SQ HD Screws, and Key)	47102	47102
19	DUMP HANDLE KNOB	47110	47110
20	DUMP HANDLE	47707	47707
21	3 1/8 X ½ WOODRUFF KEY	41730	41730
22	5/16 - 18 X ½ SQ HD SCREW	47725	47725
23	5/16 - 18 X 3/8 SQ HD SCREW (holds key)	47662	47662
24	PIVOT PIN	41426	41426
25	1/4-20 ACORN NUT	42229	42229
26	1/4-20 X 3/8 BUTTON HEAD	12492	12492



16 oz. Kettle Assembly (55199, 55199KC) – Kettle Bottom Assembly – Parts List

Item	Part Description	Part Number	
		55199	55199KC
	16OZ KETTLE BOTTOM ASSY (Complete Assy.)	55200	55200KC
1	TRANSFER PLATE ASSY (beneath heat element)	67944	67944
2	KETTLE GASKET	41598	41598
3	KETTLE WELDMENT	67892	67892
4	8-32 SERRATED FLANGE NUT		
5	¼ - 20 SERRATED LOCK NUT	46311	46311
6	ELEMENT CLAMP (6 required)	67894	67894
7	1550 TUBULAR HEAT ELEMENT	67014	67014
8	LIMIT THERMOSTAT SHIELD	67959	67959
9	8-32 TOP LOCK NUT (always replace if removed)	67943	67943
10	482 F THERMOSTAT (includes two 6-32 screws)	76708	
10	420 F THERMOSTAT (includes two 6-32 screws)		76707
11	THERMOSTAT SHUNT BAR	47193	47193
12	550 F THERMOSTAT (includes two 6-32 screws)	77108	77108
13	KETTLE SHELL ASSEMBLY (has Pivot Pins attached)	41081	41081
14	KETTLE LEAD ASSEMBLY	47361	47361
15	8-32 x 3/8 SLT HWHW M/S (fastens Nameplate to Jct. Box, and fastens Jct. Box to Kettle)	42044	42044
16	JUNCTION BOX	47393	47393
17	KETTLE CONDUIT LABEL	82840	82840
18	DUMP HANDLE ASSEMBLY (assembly includes Handle, Knob, 2 SQ HD Screws, and Key)	47102	47102
19	DUMP HANDLE KNOB	47110	47110
20	DUMP HANDLE	47707	47707
21	3 1/8 X ½ WOODRUFF KEY	41730	41730
22	5/16 - 18 X ½ SQ HD SCREW	47725	47725
23	5/16 - 18 X 3/8 SQ HD SCREW (holds key)	47662	47662
24	PIVOT PIN	41426	41426
25	1/4-20 ACORN NUT	42229	42229
26	1/4-20 X 3/8 BUTTON HEAD	12492	12492



16 oz. Kettle Assembly (55199, 55199KC) – Kettle Bottom Assembly – Parts List

Item	Part Description	Part Number	
		55199	55199KC
	16OZ KETTLE BOTTOM ASSY (Complete Assy.)	55200	55200KC
1	TRANSFER PLATE ASSY (beneath heat element)	67944	67944
2	KETTLE GASKET	41598	41598
3	KETTLE WELDMENT	67892	67892
4	8-32 SERRATED FLANGE NUT		
5	¼ - 20 SERRATED LOCK NUT	46311	46311
6	ELEMENT CLAMP (6 required)	67894	67894
7	1550 TUBULAR HEAT ELEMENT	67014	67014
8	LIMIT THERMOSTAT SHIELD	67959	67959
9	8-32 TOP LOCK NUT (always replace if removed)	67943	67943
10	482 F THERMOSTAT (includes two 6-32 screws)	76708	
10	420 F THERMOSTAT (includes two 6-32 screws)		76707
11	THERMOSTAT SHUNT BAR	47193	47193
12	550 F THERMOSTAT (includes two 6-32 screws)	77108	77108
13	KETTLE SHELL ASSEMBLY (has Pivot Pins attached)	41081	41081
14	KETTLE LEAD ASSEMBLY	47361	47361
15	8-32 x 3/8 SLT HWHW M/S (fastens Nameplate to Jct. Box, and fastens Jct. Box to Kettle)	42044	42044
16	JUNCTION BOX	47393	47393
17	KETTLE CONDUIT LABEL	82840	82840
18	DUMP HANDLE ASSEMBLY (assembly includes Handle, Knob, 2 SQ HD Screws, and Key)	47102	47102
19	DUMP HANDLE KNOB	47110	47110
20	DUMP HANDLE	47707	47707
21	3 1/8 X ½ WOODRUFF KEY	41730	41730
22	5/16 - 18 X ½ SQ HD SCREW	47725	47725
23	5/16 - 18 X 3/8 SQ HD SCREW (holds key)	47662	47662
24	PIVOT PIN	41426	41426
25	1/4-20 ACORN NUT	42229	42229
26	1/4-20 X 3/8 BUTTON HEAD	12492	12492



16 oz. Kettle Assembly (55199, 55199KC) – Kettle Bottom Assembly – Parts List

Item	Part Description	Part Number	
		55199	55199KC
	16OZ KETTLE BOTTOM ASSY (Complete Assy.)	55200	55200KC
1	TRANSFER PLATE ASSY (beneath heat element)	67944	67944
2	KETTLE GASKET	41598	41598
3	KETTLE WELDMENT	67892	67892
4	8-32 SERRATED FLANGE NUT		
5	¼ - 20 SERRATED LOCK NUT	46311	46311
6	ELEMENT CLAMP (6 required)	67894	67894
7	1550 TUBULAR HEAT ELEMENT	67014	67014
8	LIMIT THERMOSTAT SHIELD	67959	67959
9	8-32 TOP LOCK NUT (always replace if removed)	67943	67943
10	482 F THERMOSTAT (includes two 6-32 screws)	76708	
10	420 F THERMOSTAT (includes two 6-32 screws)		76707
11	THERMOSTAT SHUNT BAR	47193	47193
12	550 F THERMOSTAT (includes two 6-32 screws)	77108	77108
13	KETTLE SHELL ASSEMBLY (has Pivot Pins attached)	41081	41081
14	KETTLE LEAD ASSEMBLY	47361	47361
15	8-32 x 3/8 SLT HWHW M/S (fastens Nameplate to Jct. Box, and fastens Jct. Box to Kettle)	42044	42044
16	JUNCTION BOX	47393	47393
17	KETTLE CONDUIT LABEL	82840	82840
18	DUMP HANDLE ASSEMBLY (assembly includes Handle, Knob, 2 SQ HD Screws, and Key)	47102	47102
19	DUMP HANDLE KNOB	47110	47110
20	DUMP HANDLE	47707	47707
21	3 1/8 X ½ WOODRUFF KEY	41730	41730
22	5/16 - 18 X ½ SQ HD SCREW	47725	47725
23	5/16 - 18 X 3/8 SQ HD SCREW (holds key)	47662	47662
24	PIVOT PIN	41426	41426
25	1/4-20 ACORN NUT	42229	42229
26	1/4-20 X 3/8 BUTTON HEAD	12492	12492



16 oz. Kettle Assembly (55199, 55199KC) – Kettle Bottom Assembly – Parts List

Item	Part Description	Part Number	
		55199	55199KC
	16OZ KETTLE BOTTOM ASSY (Complete Assy.)	55200	55200KC
1	TRANSFER PLATE ASSY (beneath heat element)	67944	67944
2	KETTLE GASKET	41598	41598
3	KETTLE WELDMENT	67892	67892
4	8-32 SERRATED FLANGE NUT		
5	¼ - 20 SERRATED LOCK NUT	46311	46311
6	ELEMENT CLAMP (6 required)	67894	67894
7	1550 TUBULAR HEAT ELEMENT	67014	67014
8	LIMIT THERMOSTAT SHIELD	67959	67959
9	8-32 TOP LOCK NUT (always replace if removed)	67943	67943
10	482 F THERMOSTAT (includes two 6-32 screws)	76708	
10	420 F THERMOSTAT (includes two 6-32 screws)		76707
11	THERMOSTAT SHUNT BAR	47193	47193
12	550 F THERMOSTAT (includes two 6-32 screws)	77108	77108
13	KETTLE SHELL ASSEMBLY (has Pivot Pins attached)	41081	41081
14	KETTLE LEAD ASSEMBLY	47361	47361
15	8-32 x 3/8 SLT HWHW M/S (fastens Nameplate to Jct. Box, and fastens Jct. Box to Kettle)	42044	42044
16	JUNCTION BOX	47393	47393
17	KETTLE CONDUIT LABEL	82840	82840
18	DUMP HANDLE ASSEMBLY (assembly includes Handle, Knob, 2 SQ HD Screws, and Key)	47102	47102
19	DUMP HANDLE KNOB	47110	47110
20	DUMP HANDLE	47707	47707
21	3 1/8 X ½ WOODRUFF KEY	41730	41730
22	5/16 - 18 X ½ SQ HD SCREW	47725	47725
23	5/16 - 18 X 3/8 SQ HD SCREW (holds key)	47662	47662
24	PIVOT PIN	41426	41426
25	1/4-20 ACORN NUT	42229	42229
26	1/4-20 X 3/8 BUTTON HEAD	12492	12492



16 oz. Kettle Assembly (55199, 55199KC) – Kettle Bottom Assembly – Parts List

Item	Part Description	Part Number	
		55199	55199KC
	16OZ KETTLE BOTTOM ASSY (Complete Assy.)	55200	55200KC
1	TRANSFER PLATE ASSY (beneath heat element)	67944	67944
2	KETTLE GASKET	41598	41598
3	KETTLE WELDMENT	67892	67892
4	8-32 SERRATED FLANGE NUT		
5	¼ - 20 SERRATED LOCK NUT	46311	46311
6	ELEMENT CLAMP (6 required)	67894	67894
7	1550 TUBULAR HEAT ELEMENT	67014	67014
8	LIMIT THERMOSTAT SHIELD	67959	67959
9	8-32 TOP LOCK NUT (always replace if removed)	67943	67943
10	482 F THERMOSTAT (includes two 6-32 screws)	76708	
10	420 F THERMOSTAT (includes two 6-32 screws)		76707
11	THERMOSTAT SHUNT BAR	47193	47193
12	550 F THERMOSTAT (includes two 6-32 screws)	77108	77108
13	KETTLE SHELL ASSEMBLY (has Pivot Pins attached)	41081	41081
14	KETTLE LEAD ASSEMBLY	47361	47361
15	8-32 x 3/8 SLT HWHW M/S (fastens Nameplate to Jct. Box, and fastens Jct. Box to Kettle)	42044	42044
16	JUNCTION BOX	47393	47393
17	KETTLE CONDUIT LABEL	82840	82840
18	DUMP HANDLE ASSEMBLY (assembly includes Handle, Knob, 2 SQ HD Screws, and Key)	47102	47102
19	DUMP HANDLE KNOB	47110	47110
20	DUMP HANDLE	47707	47707
21	3 1/8 X ½ WOODRUFF KEY	41730	41730
22	5/16 - 18 X ½ SQ HD SCREW	47725	47725
23	5/16 - 18 X 3/8 SQ HD SCREW (holds key)	47662	47662
24	PIVOT PIN	41426	41426
25	1/4-20 ACORN NUT	42229	42229
26	1/4-20 X 3/8 BUTTON HEAD	12492	12492



16 oz. Kettle Assembly (55199, 55199KC) – Kettle Bottom Assembly – Parts List

Item	Part Description	Part Number	
		55199	55199KC
	16OZ KETTLE BOTTOM ASSY (Complete Assy.)	55200	55200KC
1	TRANSFER PLATE ASSY (beneath heat element)	67944	67944
2	KETTLE GASKET	41598	41598
3	KETTLE WELDMENT	67892	67892
4	8-32 SERRATED FLANGE NUT		
5	¼ - 20 SERRATED LOCK NUT	46311	46311
6	ELEMENT CLAMP (6 required)	67894	67894
7	1550 TUBULAR HEAT ELEMENT	67014	67014
8	LIMIT THERMOSTAT SHIELD	67959	67959
9	8-32 TOP LOCK NUT (always replace if removed)	67943	67943
10	482 F THERMOSTAT (includes two 6-32 screws)	76708	
10	420 F THERMOSTAT (includes two 6-32 screws)		76707
11	THERMOSTAT SHUNT BAR	47193	47193
12	550 F THERMOSTAT (includes two 6-32 screws)	77108	77108
13	KETTLE SHELL ASSEMBLY (has Pivot Pins attached)	41081	41081
14	KETTLE LEAD ASSEMBLY	47361	47361
15	8-32 x 3/8 SLT HWHW M/S (fastens Nameplate to Jct. Box, and fastens Jct. Box to Kettle)	42044	42044
16	JUNCTION BOX	47393	47393
17	KETTLE CONDUIT LABEL	82840	82840
18	DUMP HANDLE ASSEMBLY (assembly includes Handle, Knob, 2 SQ HD Screws, and Key)	47102	47102
19	DUMP HANDLE KNOB	47110	47110
20	DUMP HANDLE	47707	47707
21	3 1/8 X ½ WOODRUFF KEY	41730	41730
22	5/16 - 18 X ½ SQ HD SCREW	47725	47725
23	5/16 - 18 X 3/8 SQ HD SCREW (holds key)	47662	47662
24	PIVOT PIN	41426	41426
25	1/4-20 ACORN NUT	42229	42229
26	1/4-20 X 3/8 BUTTON HEAD	12492	12492



16 oz. Kettle Assembly (55199, 55199KC) – Kettle Bottom Assembly – Parts List

Item	Part Description	Part Number	
		55199	55199KC
	16OZ KETTLE BOTTOM ASSY (Complete Assy.)	55200	55200KC
1	TRANSFER PLATE ASSY (beneath heat element)	67944	67944
2	KETTLE GASKET	41598	41598
3	KETTLE WELDMENT	67892	67892
4	8-32 SERRATED FLANGE NUT		
5	¼ - 20 SERRATED LOCK NUT	46311	46311
6	ELEMENT CLAMP (6 required)	67894	67894
7	1550 TUBULAR HEAT ELEMENT	67014	67014
8	LIMIT THERMOSTAT SHIELD	67959	67959
9	8-32 TOP LOCK NUT (always replace if removed)	67943	67943
10	482 F THERMOSTAT (includes two 6-32 screws)	76708	
10	420 F THERMOSTAT (includes two 6-32 screws)		76707
11	THERMOSTAT SHUNT BAR	47193	47193
12	550 F THERMOSTAT (includes two 6-32 screws)	77108	77108
13	KETTLE SHELL ASSEMBLY (has Pivot Pins attached)	41081	41081
14	KETTLE LEAD ASSEMBLY	47361	47361
15	8-32 x 3/8 SLT HWHW M/S (fastens Nameplate to Jct. Box, and fastens Jct. Box to Kettle)	42044	42044
16	JUNCTION BOX	47393	47393
17	KETTLE CONDUIT LABEL	82840	82840
18	DUMP HANDLE ASSEMBLY (assembly includes Handle, Knob, 2 SQ HD Screws, and Key)	47102	47102
19	DUMP HANDLE KNOB	47110	47110
20	DUMP HANDLE	47707	47707
21	3 1/8 X ½ WOODRUFF KEY	41730	41730
22	5/16 - 18 X ½ SQ HD SCREW	47725	47725
23	5/16 - 18 X 3/8 SQ HD SCREW (holds key)	47662	47662
24	PIVOT PIN	41426	41426
25	1/4-20 ACORN NUT	42229	42229
26	1/4-20 X 3/8 BUTTON HEAD	12492	12492



16 oz. Kettle Assembly (55199, 55199KC) – Kettle Bottom Assembly – Parts List

Item	Part Description	Part Number	
		55199	55199KC
	16OZ KETTLE BOTTOM ASSY (Complete Assy.)	55200	55200KC
1	TRANSFER PLATE ASSY (beneath heat element)	67944	67944
2	KETTLE GASKET	41598	41598
3	KETTLE WELDMENT	67892	67892
4	8-32 SERRATED FLANGE NUT		
5	¼ - 20 SERRATED LOCK NUT	46311	46311
6	ELEMENT CLAMP (6 required)	67894	67894
7	1550 TUBULAR HEAT ELEMENT	67014	67014
8	LIMIT THERMOSTAT SHIELD	67959	67959
9	8-32 TOP LOCK NUT (always replace if removed)	67943	67943
10	482 F THERMOSTAT (includes two 6-32 screws)	76708	
10	420 F THERMOSTAT (includes two 6-32 screws)		76707
11	THERMOSTAT SHUNT BAR	47193	47193
12	550 F THERMOSTAT (includes two 6-32 screws)	77108	77108
13	KETTLE SHELL ASSEMBLY (has Pivot Pins attached)	41081	41081
14	KETTLE LEAD ASSEMBLY	47361	47361
15	8-32 x 3/8 SLT HWHW M/S (fastens Nameplate to Jct. Box, and fastens Jct. Box to Kettle)	42044	42044
16	JUNCTION BOX	47393	47393
17	KETTLE CONDUIT LABEL	82840	82840
18	DUMP HANDLE ASSEMBLY (assembly includes Handle, Knob, 2 SQ HD Screws, and Key)	47102	47102
19	DUMP HANDLE KNOB	47110	47110
20	DUMP HANDLE	47707	47707
21	3 1/8 X ½ WOODRUFF KEY	41730	41730
22	5/16 - 18 X ½ SQ HD SCREW	47725	47725
23	5/16 - 18 X 3/8 SQ HD SCREW (holds key)	47662	47662
24	PIVOT PIN	41426	41426
25	1/4-20 ACORN NUT	42229	42229
26	1/4-20 X 3/8 BUTTON HEAD	12492	12492



16 oz. Kettle Assembly (55199, 55199KC) – Kettle Bottom Assembly – Parts List

Item	Part Description	Part Number	
		55199	55199KC
	16OZ KETTLE BOTTOM ASSY (Complete Assy.)	55200	55200KC
1	TRANSFER PLATE ASSY (beneath heat element)	67944	67944
2	KETTLE GASKET	41598	41598
3	KETTLE WELDMENT	67892	67892
4	8-32 SERRATED FLANGE NUT		
5	¼ - 20 SERRATED LOCK NUT	46311	46311
6	ELEMENT CLAMP (6 required)	67894	67894
7	1550 TUBULAR HEAT ELEMENT	67014	67014
8	LIMIT THERMOSTAT SHIELD	67959	67959
9	8-32 TOP LOCK NUT (always replace if removed)	67943	67943
10	482 F THERMOSTAT (includes two 6-32 screws)	76708	
10	420 F THERMOSTAT (includes two 6-32 screws)		76707
11	THERMOSTAT SHUNT BAR	47193	47193
12	550 F THERMOSTAT (includes two 6-32 screws)	77108	77108
13	KETTLE SHELL ASSEMBLY (has Pivot Pins attached)	41081	41081
14	KETTLE LEAD ASSEMBLY	47361	47361
15	8-32 x 3/8 SLT HWHW M/S (fastens Nameplate to Jct. Box, and fastens Jct. Box to Kettle)	42044	42044
16	JUNCTION BOX	47393	47393
17	KETTLE CONDUIT LABEL	82840	82840
18	DUMP HANDLE ASSEMBLY (assembly includes Handle, Knob, 2 SQ HD Screws, and Key)	47102	47102
19	DUMP HANDLE KNOB	47110	47110
20	DUMP HANDLE	47707	47707
21	3 1/8 X ½ WOODRUFF KEY	41730	41730
22	5/16 - 18 X ½ SQ HD SCREW	47725	47725
23	5/16 - 18 X 3/8 SQ HD SCREW (holds key)	47662	47662
24	PIVOT PIN	41426	41426
25	1/4-20 ACORN NUT	42229	42229
26	1/4-20 X 3/8 BUTTON HEAD	12492	12492



16 oz. Kettle Assembly (55199, 55199KC) – Kettle Bottom Assembly – Parts List

Item	Part Description	Part Number	
		55199	55199KC
	16OZ KETTLE BOTTOM ASSY (Complete Assy.)	55200	55200KC
1	TRANSFER PLATE ASSY (beneath heat element)	67944	67944
2	KETTLE GASKET	41598	41598
3	KETTLE WELDMENT	67892	67892
4	8-32 SERRATED FLANGE NUT		
5	¼ - 20 SERRATED LOCK NUT	46311	46311
6	ELEMENT CLAMP (6 required)	67894	67894
7	1550 TUBULAR HEAT ELEMENT	67014	67014
8	LIMIT THERMOSTAT SHIELD	67959	67959
9	8-32 TOP LOCK NUT (always replace if removed)	67943	67943
10	482 F THERMOSTAT (includes two 6-32 screws)	76708	
10	420 F THERMOSTAT (includes two 6-32 screws)		76707
11	THERMOSTAT SHUNT BAR	47193	47193
12	550 F THERMOSTAT (includes two 6-32 screws)	77108	77108
13	KETTLE SHELL ASSEMBLY (has Pivot Pins attached)	41081	41081
14	KETTLE LEAD ASSEMBLY	47361	47361
15	8-32 x 3/8 SLT HWHW M/S (fastens Nameplate to Jct. Box, and fastens Jct. Box to Kettle)	42044	42044
16	JUNCTION BOX	47393	47393
17	KETTLE CONDUIT LABEL	82840	82840
18	DUMP HANDLE ASSEMBLY (assembly includes Handle, Knob, 2 SQ HD Screws, and Key)	47102	47102
19	DUMP HANDLE KNOB	47110	47110
20	DUMP HANDLE	47707	47707
21	3 1/8 X ½ WOODRUFF KEY	41730	41730
22	5/16 - 18 X ½ SQ HD SCREW	47725	47725
23	5/16 - 18 X 3/8 SQ HD SCREW (holds key)	47662	47662
24	PIVOT PIN	41426	41426
25	1/4-20 ACORN NUT	42229	42229
26	1/4-20 X 3/8 BUTTON HEAD	12492	12492



16 oz. Kettle Assembly (55199, 55199KC) – Kettle Bottom Assembly – Parts List

Item	Part Description	Part Number	
		55199	55199KC
	16OZ KETTLE BOTTOM ASSY (Complete Assy.)	55200	55200KC
1	TRANSFER PLATE ASSY (beneath heat element)	67944	67944
2	KETTLE GASKET	41598	41598
3	KETTLE WELDMENT	67892	67892
4	8-32 SERRATED FLANGE NUT		
5	¼ - 20 SERRATED LOCK NUT	46311	46311
6	ELEMENT CLAMP (6 required)	67894	67894
7	1550 TUBULAR HEAT ELEMENT	67014	67014
8	LIMIT THERMOSTAT SHIELD	67959	67959
9	8-32 TOP LOCK NUT (always replace if removed)	67943	67943
10	482 F THERMOSTAT (includes two 6-32 screws)	76708	
10	420 F THERMOSTAT (includes two 6-32 screws)		76707
11	THERMOSTAT SHUNT BAR	47193	47193
12	550 F THERMOSTAT (includes two 6-32 screws)	77108	77108
13	KETTLE SHELL ASSEMBLY (has Pivot Pins attached)	41081	41081
14	KETTLE LEAD ASSEMBLY	47361	47361
15	8-32 x 3/8 SLT HWHW M/S (fastens Nameplate to Jct. Box, and fastens Jct. Box to Kettle)	42044	42044
16	JUNCTION BOX	47393	47393
17	KETTLE CONDUIT LABEL	82840	82840
18	DUMP HANDLE ASSEMBLY (assembly includes Handle, Knob, 2 SQ HD Screws, and Key)	47102	47102
19	DUMP HANDLE KNOB	47110	47110
20	DUMP HANDLE	47707	47707
21	3 1/8 X ½ WOODRUFF KEY	41730	41730
22	5/16 - 18 X ½ SQ HD SCREW	47725	47725
23	5/16 - 18 X 3/8 SQ HD SCREW (holds key)	47662	47662
24	PIVOT PIN	41426	41426
25	1/4-20 ACORN NUT	42229	42229
26	1/4-20 X 3/8 BUTTON HEAD	12492	12492



16 oz. Kettle Assembly (55199, 55199KC) – Kettle Bottom Assembly – Parts List

Item	Part Description	Part Number	
		55199	55199KC
	16OZ KETTLE BOTTOM ASSY (Complete Assy.)	55200	55200KC
1	TRANSFER PLATE ASSY (beneath heat element)	67944	67944
2	KETTLE GASKET	41598	41598
3	KETTLE WELDMENT	67892	67892
4	8-32 SERRATED FLANGE NUT		
5	¼ - 20 SERRATED LOCK NUT	46311	46311
6	ELEMENT CLAMP (6 required)	67894	67894
7	1550 TUBULAR HEAT ELEMENT	67014	67014
8	LIMIT THERMOSTAT SHIELD	67959	67959
9	8-32 TOP LOCK NUT (always replace if removed)	67943	67943
10	482 F THERMOSTAT (includes two 6-32 screws)	76708	
10	420 F THERMOSTAT (includes two 6-32 screws)		76707
11	THERMOSTAT SHUNT BAR	47193	47193
12	550 F THERMOSTAT (includes two 6-32 screws)	77108	77108
13	KETTLE SHELL ASSEMBLY (has Pivot Pins attached)	41081	41081
14	KETTLE LEAD ASSEMBLY	47361	47361
15	8-32 x 3/8 SLT HWHW M/S (fastens Nameplate to Jct. Box, and fastens Jct. Box to Kettle)	42044	42044
16	JUNCTION BOX	47393	47393
17	KETTLE CONDUIT LABEL	82840	82840
18	DUMP HANDLE ASSEMBLY (assembly includes Handle, Knob, 2 SQ HD Screws, and Key)	47102	47102
19	DUMP HANDLE KNOB	47110	47110
20	DUMP HANDLE	47707	47707
21	3 1/8 X ½ WOODRUFF KEY	41730	41730
22	5/16 - 18 X ½ SQ HD SCREW	47725	47725
23	5/16 - 18 X 3/8 SQ HD SCREW (holds key)	47662	47662
24	PIVOT PIN	41426	41426
25	1/4-20 ACORN NUT	42229	42229
26	1/4-20 X 3/8 BUTTON HEAD	12492	12492



16 oz. Kettle Assembly (55199, 55199KC) – Kettle Bottom Assembly – Parts List

Item	Part Description	Part Number	
		55199	55199KC
	16OZ KETTLE BOTTOM ASSY (Complete Assy.)	55200	55200KC
1	TRANSFER PLATE ASSY (beneath heat element)	67944	67944
2	KETTLE GASKET	41598	41598
3	KETTLE WELDMENT	67892	67892
4	8-32 SERRATED FLANGE NUT		
5	¼ - 20 SERRATED LOCK NUT	46311	46311
6	ELEMENT CLAMP (6 required)	67894	67894
7	1550 TUBULAR HEAT ELEMENT	67014	67014
8	LIMIT THERMOSTAT SHIELD	67959	67959
9	8-32 TOP LOCK NUT (always replace if removed)	67943	67943
10	482 F THERMOSTAT (includes two 6-32 screws)	76708	
10	420 F THERMOSTAT (includes two 6-32 screws)		76707
11	THERMOSTAT SHUNT BAR	47193	47193
12	550 F THERMOSTAT (includes two 6-32 screws)	77108	77108
13	KETTLE SHELL ASSEMBLY (has Pivot Pins attached)	41081	41081
14	KETTLE LEAD ASSEMBLY	47361	47361
15	8-32 x 3/8 SLT HWHW M/S (fastens Nameplate to Jct. Box, and fastens Jct. Box to Kettle)	42044	42044
16	JUNCTION BOX	47393	47393
17	KETTLE CONDUIT LABEL	82840	82840
18	DUMP HANDLE ASSEMBLY (assembly includes Handle, Knob, 2 SQ HD Screws, and Key)	47102	47102
19	DUMP HANDLE KNOB	47110	47110
20	DUMP HANDLE	47707	47707
21	3 1/8 X ½ WOODRUFF KEY	41730	41730
22	5/16 - 18 X ½ SQ HD SCREW	47725	47725
23	5/16 - 18 X 3/8 SQ HD SCREW (holds key)	47662	47662
24	PIVOT PIN	41426	41426
25	1/4-20 ACORN NUT	42229	42229
26	1/4-20 X 3/8 BUTTON HEAD	12492	12492



16 oz. Kettle Assembly (55199, 55199KC) – Kettle Bottom Assembly – Parts List

Item	Part Description	Part Number	
		55199	55199KC
	16OZ KETTLE BOTTOM ASSY (Complete Assy.)	55200	55200KC
1	TRANSFER PLATE ASSY (beneath heat element)	67944	67944
2	KETTLE GASKET	41598	41598
3	KETTLE WELDMENT	67892	67892
4	8-32 SERRATED FLANGE NUT		
5	¼ - 20 SERRATED LOCK NUT	46311	46311
6	ELEMENT CLAMP (6 required)	67894	67894
7	1550 TUBULAR HEAT ELEMENT	67014	67014
8	LIMIT THERMOSTAT SHIELD	67959	67959
9	8-32 TOP LOCK NUT (always replace if removed)	67943	67943
10	482 F THERMOSTAT (includes two 6-32 screws)	76708	
10	420 F THERMOSTAT (includes two 6-32 screws)		76707
11	THERMOSTAT SHUNT BAR	47193	47193
12	550 F THERMOSTAT (includes two 6-32 screws)	77108	77108
13	KETTLE SHELL ASSEMBLY (has Pivot Pins attached)	41081	41081
14	KETTLE LEAD ASSEMBLY	47361	47361
15	8-32 x 3/8 SLT HWHW M/S (fastens Nameplate to Jct. Box, and fastens Jct. Box to Kettle)	42044	42044
16	JUNCTION BOX	47393	47393
17	KETTLE CONDUIT LABEL	82840	82840
18	DUMP HANDLE ASSEMBLY (assembly includes Handle, Knob, 2 SQ HD Screws, and Key)	47102	47102
19	DUMP HANDLE KNOB	47110	47110
20	DUMP HANDLE	47707	47707
21	3 1/8 X ½ WOODRUFF KEY	41730	41730
22	5/16 - 18 X ½ SQ HD SCREW	47725	47725
23	5/16 - 18 X 3/8 SQ HD SCREW (holds key)	47662	47662
24	PIVOT PIN	41426	41426
25	1/4-20 ACORN NUT	42229	42229
26	1/4-20 X 3/8 BUTTON HEAD	12492	12492



16 oz. Kettle Assembly (55199, 55199KC) – Kettle Bottom Assembly – Parts List

Item	Part Description	Part Number	
		55199	55199KC
	16OZ KETTLE BOTTOM ASSY (Complete Assy.)	55200	55200KC
1	TRANSFER PLATE ASSY (beneath heat element)	67944	67944
2	KETTLE GASKET	41598	41598
3	KETTLE WELDMENT	67892	67892
4	8-32 SERRATED FLANGE NUT		
5	¼ - 20 SERRATED LOCK NUT	46311	46311
6	ELEMENT CLAMP (6 required)	67894	67894
7	1550 TUBULAR HEAT ELEMENT	67014	67014
8	LIMIT THERMOSTAT SHIELD	67959	67959
9	8-32 TOP LOCK NUT (always replace if removed)	67943	67943
10	482 F THERMOSTAT (includes two 6-32 screws)	76708	
10	420 F THERMOSTAT (includes two 6-32 screws)		76707
11	THERMOSTAT SHUNT BAR	47193	47193
12	550 F THERMOSTAT (includes two 6-32 screws)	77108	77108
13	KETTLE SHELL ASSEMBLY (has Pivot Pins attached)	41081	41081
14	KETTLE LEAD ASSEMBLY	47361	47361
15	8-32 x 3/8 SLT HWHW M/S (fastens Nameplate to Jct. Box, and fastens Jct. Box to Kettle)	42044	42044
16	JUNCTION BOX	47393	47393
17	KETTLE CONDUIT LABEL	82840	82840
18	DUMP HANDLE ASSEMBLY (assembly includes Handle, Knob, 2 SQ HD Screws, and Key)	47102	47102
19	DUMP HANDLE KNOB	47110	47110
20	DUMP HANDLE	47707	47707
21	3 1/8 X ½ WOODRUFF KEY	41730	41730
22	5/16 - 18 X ½ SQ HD SCREW	47725	47725
23	5/16 - 18 X 3/8 SQ HD SCREW (holds key)	47662	47662
24	PIVOT PIN	41426	41426
25	1/4-20 ACORN NUT	42229	42229
26	1/4-20 X 3/8 BUTTON HEAD	12492	12492



16 oz. Kettle Assembly (55199, 55199KC) – Kettle Bottom Assembly – Parts List

Item	Part Description	Part Number	
		55199	55199KC
	16OZ KETTLE BOTTOM ASSY (Complete Assy.)	55200	55200KC
1	TRANSFER PLATE ASSY (beneath heat element)	67944	67944
2	KETTLE GASKET	41598	41598
3	KETTLE WELDMENT	67892	67892
4	8-32 SERRATED FLANGE NUT		
5	¼ - 20 SERRATED LOCK NUT	46311	46311
6	ELEMENT CLAMP (6 required)	67894	67894
7	1550 TUBULAR HEAT ELEMENT	67014	67014
8	LIMIT THERMOSTAT SHIELD	67959	67959
9	8-32 TOP LOCK NUT (always replace if removed)	67943	67943
10	482 F THERMOSTAT (includes two 6-32 screws)	76708	
10	420 F THERMOSTAT (includes two 6-32 screws)		76707
11	THERMOSTAT SHUNT BAR	47193	47193
12	550 F THERMOSTAT (includes two 6-32 screws)	77108	77108
13	KETTLE SHELL ASSEMBLY (has Pivot Pins attached)	41081	41081
14	KETTLE LEAD ASSEMBLY	47361	47361
15	8-32 x 3/8 SLT HWHW M/S (fastens Nameplate to Jct. Box, and fastens Jct. Box to Kettle)	42044	42044
16	JUNCTION BOX	47393	47393
17	KETTLE CONDUIT LABEL	82840	82840
18	DUMP HANDLE ASSEMBLY (assembly includes Handle, Knob, 2 SQ HD Screws, and Key)	47102	47102
19	DUMP HANDLE KNOB	47110	47110
20	DUMP HANDLE	47707	47707
21	3 1/8 X ½ WOODRUFF KEY	41730	41730
22	5/16 - 18 X ½ SQ HD SCREW	47725	47725
23	5/16 - 18 X 3/8 SQ HD SCREW (holds key)	47662	47662
24	PIVOT PIN	41426	41426
25	1/4-20 ACORN NUT	42229	42229
26	1/4-20 X 3/8 BUTTON HEAD	12492	12492



16 oz. Kettle Assembly (55199, 55199KC) – Kettle Bottom Assembly – Parts List

Item	Part Description	Part Number	
		55199	55199KC
	16OZ KETTLE BOTTOM ASSY (Complete Assy.)	55200	55200KC
1	TRANSFER PLATE ASSY (beneath heat element)	67944	67944
2	KETTLE GASKET	41598	41598
3	KETTLE WELDMENT	67892	67892
4	8-32 SERRATED FLANGE NUT		
5	¼ - 20 SERRATED LOCK NUT	46311	46311
6	ELEMENT CLAMP (6 required)	67894	67894
7	1550 TUBULAR HEAT ELEMENT	67014	67014
8	LIMIT THERMOSTAT SHIELD	67959	67959
9	8-32 TOP LOCK NUT (always replace if removed)	67943	67943
10	482 F THERMOSTAT (includes two 6-32 screws)	76708	
10	420 F THERMOSTAT (includes two 6-32 screws)		76707
11	THERMOSTAT SHUNT BAR	47193	47193
12	550 F THERMOSTAT (includes two 6-32 screws)	77108	77108
13	KETTLE SHELL ASSEMBLY (has Pivot Pins attached)	41081	41081
14	KETTLE LEAD ASSEMBLY	47361	47361
15	8-32 x 3/8 SLT HWHW M/S (fastens Nameplate to Jct. Box, and fastens Jct. Box to Kettle)	42044	42044
16	JUNCTION BOX	47393	47393
17	KETTLE CONDUIT LABEL	82840	82840
18	DUMP HANDLE ASSEMBLY (assembly includes Handle, Knob, 2 SQ HD Screws, and Key)	47102	47102
19	DUMP HANDLE KNOB	47110	47110
20	DUMP HANDLE	47707	47707
21	3 1/8 X ½ WOODRUFF KEY	41730	41730
22	5/16 - 18 X ½ SQ HD SCREW	47725	47725
23	5/16 - 18 X 3/8 SQ HD SCREW (holds key)	47662	47662
24	PIVOT PIN	41426	41426
25	1/4-20 ACORN NUT	42229	42229
26	1/4-20 X 3/8 BUTTON HEAD	12492	12492



16 oz. Kettle Assembly (55199, 55199KC) – Kettle Bottom Assembly – Parts List

Item	Part Description	Part Number	
		55199	55199KC
	16OZ KETTLE BOTTOM ASSY (Complete Assy.)	55200	55200KC
1	TRANSFER PLATE ASSY (beneath heat element)	67944	67944
2	KETTLE GASKET	41598	41598
3	KETTLE WELDMENT	67892	67892
4	8-32 SERRATED FLANGE NUT		
5	¼ - 20 SERRATED LOCK NUT	46311	46311
6	ELEMENT CLAMP (6 required)	67894	67894
7	1550 TUBULAR HEAT ELEMENT	67014	67014
8	LIMIT THERMOSTAT SHIELD	67959	67959
9	8-32 TOP LOCK NUT (always replace if removed)	67943	67943
10	482 F THERMOSTAT (includes two 6-32 screws)	76708	
10	420 F THERMOSTAT (includes two 6-32 screws)		76707
11	THERMOSTAT SHUNT BAR	47193	47193
12	550 F THERMOSTAT (includes two 6-32 screws)	77108	77108
13	KETTLE SHELL ASSEMBLY (has Pivot Pins attached)	41081	41081
14	KETTLE LEAD ASSEMBLY	47361	47361
15	8-32 x 3/8 SLT HWHW M/S (fastens Nameplate to Jct. Box, and fastens Jct. Box to Kettle)	42044	42044
16	JUNCTION BOX	47393	47393
17	KETTLE CONDUIT LABEL	82840	82840
18	DUMP HANDLE ASSEMBLY (assembly includes Handle, Knob, 2 SQ HD Screws, and Key)	47102	47102
19	DUMP HANDLE KNOB	47110	47110
20	DUMP HANDLE	47707	47707
21	3 1/8 X ½ WOODRUFF KEY	41730	41730
22	5/16 - 18 X ½ SQ HD SCREW	47725	47725
23	5/16 - 18 X 3/8 SQ HD SCREW (holds key)	47662	47662
24	PIVOT PIN	41426	41426
25	1/4-20 ACORN NUT	42229	42229
26	1/4-20 X 3/8 BUTTON HEAD	12492	12492



16 oz. Kettle Assembly (55199, 55199KC) – Kettle Bottom Assembly – Parts List

Item	Part Description	Part Number	
		55199	55199KC
	16OZ KETTLE BOTTOM ASSY (Complete Assy.)	55200	55200KC
1	TRANSFER PLATE ASSY (beneath heat element)	67944	67944
2	KETTLE GASKET	41598	41598
3	KETTLE WELDMENT	67892	67892
4	8-32 SERRATED FLANGE NUT		
5	¼ - 20 SERRATED LOCK NUT	46311	46311
6	ELEMENT CLAMP (6 required)	67894	67894
7	1550 TUBULAR HEAT ELEMENT	67014	67014
8	LIMIT THERMOSTAT SHIELD	67959	67959
9	8-32 TOP LOCK NUT (always replace if removed)	67943	67943
10	482 F THERMOSTAT (includes two 6-32 screws)	76708	
10	420 F THERMOSTAT (includes two 6-32 screws)		76707
11	THERMOSTAT SHUNT BAR	47193	47193
12	550 F THERMOSTAT (includes two 6-32 screws)	77108	77108
13	KETTLE SHELL ASSEMBLY (has Pivot Pins attached)	41081	41081
14	KETTLE LEAD ASSEMBLY	47361	47361
15	8-32 x 3/8 SLT HWHW M/S (fastens Nameplate to Jct. Box, and fastens Jct. Box to Kettle)	42044	42044
16	JUNCTION BOX	47393	47393
17	KETTLE CONDUIT LABEL	82840	82840
18	DUMP HANDLE ASSEMBLY (assembly includes Handle, Knob, 2 SQ HD Screws, and Key)	47102	47102
19	DUMP HANDLE KNOB	47110	47110
20	DUMP HANDLE	47707	47707
21	3 1/8 X ½ WOODRUFF KEY	41730	41730
22	5/16 - 18 X ½ SQ HD SCREW	47725	47725
23	5/16 - 18 X 3/8 SQ HD SCREW (holds key)	47662	47662
24	PIVOT PIN	41426	41426
25	1/4-20 ACORN NUT	42229	42229
26	1/4-20 X 3/8 BUTTON HEAD	12492	12492



16 oz. Kettle Assembly (55199, 55199KC) – Kettle Bottom Assembly – Parts List

Item	Part Description	Part Number	
		55199	55199KC
	16OZ KETTLE BOTTOM ASSY (Complete Assy.)	55200	55200KC
1	TRANSFER PLATE ASSY (beneath heat element)	67944	67944
2	KETTLE GASKET	41598	41598
3	KETTLE WELDMENT	67892	67892
4	8-32 SERRATED FLANGE NUT		
5	¼ - 20 SERRATED LOCK NUT	46311	46311
6	ELEMENT CLAMP (6 required)	67894	67894
7	1550 TUBULAR HEAT ELEMENT	67014	67014
8	LIMIT THERMOSTAT SHIELD	67959	67959
9	8-32 TOP LOCK NUT (always replace if removed)	67943	67943
10	482 F THERMOSTAT (includes two 6-32 screws)	76708	
10	420 F THERMOSTAT (includes two 6-32 screws)		76707
11	THERMOSTAT SHUNT BAR	47193	47193
12	550 F THERMOSTAT (includes two 6-32 screws)	77108	77108
13	KETTLE SHELL ASSEMBLY (has Pivot Pins attached)	41081	41081
14	KETTLE LEAD ASSEMBLY	47361	47361
15	8-32 x 3/8 SLT HWHW M/S (fastens Nameplate to Jct. Box, and fastens Jct. Box to Kettle)	42044	42044
16	JUNCTION BOX	47393	47393
17	KETTLE CONDUIT LABEL	82840	82840
18	DUMP HANDLE ASSEMBLY (assembly includes Handle, Knob, 2 SQ HD Screws, and Key)	47102	47102
19	DUMP HANDLE KNOB	47110	47110
20	DUMP HANDLE	47707	47707
21	3 1/8 X ½ WOODRUFF KEY	41730	41730
22	5/16 - 18 X ½ SQ HD SCREW	47725	47725
23	5/16 - 18 X 3/8 SQ HD SCREW (holds key)	47662	47662
24	PIVOT PIN	41426	41426
25	1/4-20 ACORN NUT	42229	42229
26	1/4-20 X 3/8 BUTTON HEAD	12492	12492



16 oz. Kettle Assembly (55199, 55199KC) – Kettle Bottom Assembly – Parts List

Item	Part Description	Part Number	
		55199	55199KC
	16OZ KETTLE BOTTOM ASSY (Complete Assy.)	55200	55200KC
1	TRANSFER PLATE ASSY (beneath heat element)	67944	67944
2	KETTLE GASKET	41598	41598
3	KETTLE WELDMENT	67892	67892
4	8-32 SERRATED FLANGE NUT		
5	¼ - 20 SERRATED LOCK NUT	46311	46311
6	ELEMENT CLAMP (6 required)	67894	67894
7	1550 TUBULAR HEAT ELEMENT	67014	67014
8	LIMIT THERMOSTAT SHIELD	67959	67959
9	8-32 TOP LOCK NUT (always replace if removed)	67943	67943
10	482 F THERMOSTAT (includes two 6-32 screws)	76708	
10	420 F THERMOSTAT (includes two 6-32 screws)		76707
11	THERMOSTAT SHUNT BAR	47193	47193
12	550 F THERMOSTAT (includes two 6-32 screws)	77108	77108
13	KETTLE SHELL ASSEMBLY (has Pivot Pins attached)	41081	41081
14	KETTLE LEAD ASSEMBLY	47361	47361
15	8-32 x 3/8 SLT HWHW M/S (fastens Nameplate to Jct. Box, and fastens Jct. Box to Kettle)	42044	42044
16	JUNCTION BOX	47393	47393
17	KETTLE CONDUIT LABEL	82840	82840
18	DUMP HANDLE ASSEMBLY (assembly includes Handle, Knob, 2 SQ HD Screws, and Key)	47102	47102
19	DUMP HANDLE KNOB	47110	47110
20	DUMP HANDLE	47707	47707
21	3 1/8 X ½ WOODRUFF KEY	41730	41730
22	5/16 - 18 X ½ SQ HD SCREW	47725	47725
23	5/16 - 18 X 3/8 SQ HD SCREW (holds key)	47662	47662
24	PIVOT PIN	41426	41426
25	1/4-20 ACORN NUT	42229	42229
26	1/4-20 X 3/8 BUTTON HEAD	12492	12492



16 oz. Kettle Assembly (55199, 55199KC) – Kettle Bottom Assembly – Parts List

Item	Part Description	Part Number	
		55199	55199KC
	16OZ KETTLE BOTTOM ASSY (Complete Assy.)	55200	55200KC
1	TRANSFER PLATE ASSY (beneath heat element)	67944	67944
2	KETTLE GASKET	41598	41598
3	KETTLE WELDMENT	67892	67892
4	8-32 SERRATED FLANGE NUT		
5	¼ - 20 SERRATED LOCK NUT	46311	46311
6	ELEMENT CLAMP (6 required)	67894	67894
7	1550 TUBULAR HEAT ELEMENT	67014	67014
8	LIMIT THERMOSTAT SHIELD	67959	67959
9	8-32 TOP LOCK NUT (always replace if removed)	67943	67943
10	482 F THERMOSTAT (includes two 6-32 screws)	76708	
10	420 F THERMOSTAT (includes two 6-32 screws)		76707
11	THERMOSTAT SHUNT BAR	47193	47193
12	550 F THERMOSTAT (includes two 6-32 screws)	77108	77108
13	KETTLE SHELL ASSEMBLY (has Pivot Pins attached)	41081	41081
14	KETTLE LEAD ASSEMBLY	47361	47361
15	8-32 x 3/8 SLT HWHW M/S (fastens Nameplate to Jct. Box, and fastens Jct. Box to Kettle)	42044	42044
16	JUNCTION BOX	47393	47393
17	KETTLE CONDUIT LABEL	82840	82840
18	DUMP HANDLE ASSEMBLY (assembly includes Handle, Knob, 2 SQ HD Screws, and Key)	47102	47102
19	DUMP HANDLE KNOB	47110	47110
20	DUMP HANDLE	47707	47707
21	3 1/8 X ½ WOODRUFF KEY	41730	41730
22	5/16 - 18 X ½ SQ HD SCREW	47725	47725
23	5/16 - 18 X 3/8 SQ HD SCREW (holds key)	47662	47662
24	PIVOT PIN	41426	41426
25	1/4-20 ACORN NUT	42229	42229
26	1/4-20 X 3/8 BUTTON HEAD	12492	12492



16 oz. Kettle Assembly (55199, 55199KC) – Kettle Bottom Assembly – Parts List

Item	Part Description	Part Number	
		55199	55199KC
	16OZ KETTLE BOTTOM ASSY (Complete Assy.)	55200	55200KC
1	TRANSFER PLATE ASSY (beneath heat element)	67944	67944
2	KETTLE GASKET	41598	41598
3	KETTLE WELDMENT	67892	67892
4	8-32 SERRATED FLANGE NUT		
5	¼ - 20 SERRATED LOCK NUT	46311	46311
6	ELEMENT CLAMP (6 required)	67894	67894
7	1550 TUBULAR HEAT ELEMENT	67014	67014
8	LIMIT THERMOSTAT SHIELD	67959	67959
9	8-32 TOP LOCK NUT (always replace if removed)	67943	67943
10	482 F THERMOSTAT (includes two 6-32 screws)	76708	
10	420 F THERMOSTAT (includes two 6-32 screws)		76707
11	THERMOSTAT SHUNT BAR	47193	47193
12	550 F THERMOSTAT (includes two 6-32 screws)	77108	77108
13	KETTLE SHELL ASSEMBLY (has Pivot Pins attached)	41081	41081
14	KETTLE LEAD ASSEMBLY	47361	47361
15	8-32 x 3/8 SLT HWHW M/S (fastens Nameplate to Jct. Box, and fastens Jct. Box to Kettle)	42044	42044
16	JUNCTION BOX	47393	47393
17	KETTLE CONDUIT LABEL	82840	82840
18	DUMP HANDLE ASSEMBLY (assembly includes Handle, Knob, 2 SQ HD Screws, and Key)	47102	47102
19	DUMP HANDLE KNOB	47110	47110
20	DUMP HANDLE	47707	47707
21	3 1/8 X ½ WOODRUFF KEY	41730	41730
22	5/16 - 18 X ½ SQ HD SCREW	47725	47725
23	5/16 - 18 X 3/8 SQ HD SCREW (holds key)	47662	47662
24	PIVOT PIN	41426	41426
25	1/4-20 ACORN NUT	42229	42229
26	1/4-20 X 3/8 BUTTON HEAD	12492	12492



16 oz. Kettle Assembly (55199, 55199KC) – Kettle Bottom Assembly – Parts List

Item	Part Description	Part Number	
		55199	55199KC
	16OZ KETTLE BOTTOM ASSY (Complete Assy.)	55200	55200KC
1	TRANSFER PLATE ASSY (beneath heat element)	67944	67944
2	KETTLE GASKET	41598	41598
3	KETTLE WELDMENT	67892	67892
4	8-32 SERRATED FLANGE NUT		
5	¼ - 20 SERRATED LOCK NUT	46311	46311
6	ELEMENT CLAMP (6 required)	67894	67894
7	1550 TUBULAR HEAT ELEMENT	67014	67014
8	LIMIT THERMOSTAT SHIELD	67959	67959
9	8-32 TOP LOCK NUT (always replace if removed)	67943	67943
10	482 F THERMOSTAT (includes two 6-32 screws)	76708	
10	420 F THERMOSTAT (includes two 6-32 screws)		76707
11	THERMOSTAT SHUNT BAR	47193	47193
12	550 F THERMOSTAT (includes two 6-32 screws)	77108	77108
13	KETTLE SHELL ASSEMBLY (has Pivot Pins attached)	41081	41081
14	KETTLE LEAD ASSEMBLY	47361	47361
15	8-32 x 3/8 SLT HWHW M/S (fastens Nameplate to Jct. Box, and fastens Jct. Box to Kettle)	42044	42044
16	JUNCTION BOX	47393	47393
17	KETTLE CONDUIT LABEL	82840	82840
18	DUMP HANDLE ASSEMBLY (assembly includes Handle, Knob, 2 SQ HD Screws, and Key)	47102	47102
19	DUMP HANDLE KNOB	47110	47110
20	DUMP HANDLE	47707	47707
21	3 1/8 X ½ WOODRUFF KEY	41730	41730
22	5/16 - 18 X ½ SQ HD SCREW	47725	47725
23	5/16 - 18 X 3/8 SQ HD SCREW (holds key)	47662	47662
24	PIVOT PIN	41426	41426
25	1/4-20 ACORN NUT	42229	42229
26	1/4-20 X 3/8 BUTTON HEAD	12492	12492



16 oz. Kettle Assembly (55199, 55199KC) – Kettle Bottom Assembly – Parts List

Item	Part Description	Part Number	
		55199	55199KC
	16OZ KETTLE BOTTOM ASSY (Complete Assy.)	55200	55200KC
1	TRANSFER PLATE ASSY (beneath heat element)	67944	67944
2	KETTLE GASKET	41598	41598
3	KETTLE WELDMENT	67892	67892
4	8-32 SERRATED FLANGE NUT		
5	¼ - 20 SERRATED LOCK NUT	46311	46311
6	ELEMENT CLAMP (6 required)	67894	67894
7	1550 TUBULAR HEAT ELEMENT	67014	67014
8	LIMIT THERMOSTAT SHIELD	67959	67959
9	8-32 TOP LOCK NUT (always replace if removed)	67943	67943
10	482 F THERMOSTAT (includes two 6-32 screws)	76708	
10	420 F THERMOSTAT (includes two 6-32 screws)		76707
11	THERMOSTAT SHUNT BAR	47193	47193
12	550 F THERMOSTAT (includes two 6-32 screws)	77108	77108
13	KETTLE SHELL ASSEMBLY (has Pivot Pins attached)	41081	41081
14	KETTLE LEAD ASSEMBLY	47361	47361
15	8-32 x 3/8 SLT HWHW M/S (fastens Nameplate to Jct. Box, and fastens Jct. Box to Kettle)	42044	42044
16	JUNCTION BOX	47393	47393
17	KETTLE CONDUIT LABEL	82840	82840
18	DUMP HANDLE ASSEMBLY (assembly includes Handle, Knob, 2 SQ HD Screws, and Key)	47102	47102
19	DUMP HANDLE KNOB	47110	47110
20	DUMP HANDLE	47707	47707
21	3 1/8 X ½ WOODRUFF KEY	41730	41730
22	5/16 - 18 X ½ SQ HD SCREW	47725	47725
23	5/16 - 18 X 3/8 SQ HD SCREW (holds key)	47662	47662
24	PIVOT PIN	41426	41426
25	1/4-20 ACORN NUT	42229	42229
26	1/4-20 X 3/8 BUTTON HEAD	12492	12492



16 oz. Kettle Assembly (55199, 55199KC) – Kettle Bottom Assembly – Parts List

Item	Part Description	Part Number	
		55199	55199KC
	16OZ KETTLE BOTTOM ASSY (Complete Assy.)	55200	55200KC
1	TRANSFER PLATE ASSY (beneath heat element)	67944	67944
2	KETTLE GASKET	41598	41598
3	KETTLE WELDMENT	67892	67892
4	8-32 SERRATED FLANGE NUT		
5	¼ - 20 SERRATED LOCK NUT	46311	46311
6	ELEMENT CLAMP (6 required)	67894	67894
7	1550 TUBULAR HEAT ELEMENT	67014	67014
8	LIMIT THERMOSTAT SHIELD	67959	67959
9	8-32 TOP LOCK NUT (always replace if removed)	67943	67943
10	482 F THERMOSTAT (includes two 6-32 screws)	76708	
10	420 F THERMOSTAT (includes two 6-32 screws)		76707
11	THERMOSTAT SHUNT BAR	47193	47193
12	550 F THERMOSTAT (includes two 6-32 screws)	77108	77108
13	KETTLE SHELL ASSEMBLY (has Pivot Pins attached)	41081	41081
14	KETTLE LEAD ASSEMBLY	47361	47361
15	8-32 x 3/8 SLT HWHW M/S (fastens Nameplate to Jct. Box, and fastens Jct. Box to Kettle)	42044	42044
16	JUNCTION BOX	47393	47393
17	KETTLE CONDUIT LABEL	82840	82840
18	DUMP HANDLE ASSEMBLY (assembly includes Handle, Knob, 2 SQ HD Screws, and Key)	47102	47102
19	DUMP HANDLE KNOB	47110	47110
20	DUMP HANDLE	47707	47707
21	3 1/8 X ½ WOODRUFF KEY	41730	41730
22	5/16 - 18 X ½ SQ HD SCREW	47725	47725
23	5/16 - 18 X 3/8 SQ HD SCREW (holds key)	47662	47662
24	PIVOT PIN	41426	41426
25	1/4-20 ACORN NUT	42229	42229
26	1/4-20 X 3/8 BUTTON HEAD	12492	12492



16 oz. Kettle Assembly (55199, 55199KC) – Kettle Bottom Assembly – Parts List

Item	Part Description	Part Number	
		55199	55199KC
	16OZ KETTLE BOTTOM ASSY (Complete Assy.)	55200	55200KC
1	TRANSFER PLATE ASSY (beneath heat element)	67944	67944
2	KETTLE GASKET	41598	41598
3	KETTLE WELDMENT	67892	67892
4	8-32 SERRATED FLANGE NUT		
5	¼ - 20 SERRATED LOCK NUT	46311	46311
6	ELEMENT CLAMP (6 required)	67894	67894
7	1550 TUBULAR HEAT ELEMENT	67014	67014
8	LIMIT THERMOSTAT SHIELD	67959	67959
9	8-32 TOP LOCK NUT (always replace if removed)	67943	67943
10	482 F THERMOSTAT (includes two 6-32 screws)	76708	
10	420 F THERMOSTAT (includes two 6-32 screws)		76707
11	THERMOSTAT SHUNT BAR	47193	47193
12	550 F THERMOSTAT (includes two 6-32 screws)	77108	77108
13	KETTLE SHELL ASSEMBLY (has Pivot Pins attached)	41081	41081
14	KETTLE LEAD ASSEMBLY	47361	47361
15	8-32 x 3/8 SLT HWHW M/S (fastens Nameplate to Jct. Box, and fastens Jct. Box to Kettle)	42044	42044
16	JUNCTION BOX	47393	47393
17	KETTLE CONDUIT LABEL	82840	82840
18	DUMP HANDLE ASSEMBLY (assembly includes Handle, Knob, 2 SQ HD Screws, and Key)	47102	47102
19	DUMP HANDLE KNOB	47110	47110
20	DUMP HANDLE	47707	47707
21	3 1/8 X ½ WOODRUFF KEY	41730	41730
22	5/16 - 18 X ½ SQ HD SCREW	47725	47725
23	5/16 - 18 X 3/8 SQ HD SCREW (holds key)	47662	47662
24	PIVOT PIN	41426	41426
25	1/4-20 ACORN NUT	42229	42229
26	1/4-20 X 3/8 BUTTON HEAD	12492	12492



16 oz. Kettle Assembly (55199, 55199KC) – Kettle Bottom Assembly – Parts List

Item	Part Description	Part Number	
		55199	55199KC
	16OZ KETTLE BOTTOM ASSY (Complete Assy.)	55200	55200KC
1	TRANSFER PLATE ASSY (beneath heat element)	67944	67944
2	KETTLE GASKET	41598	41598
3	KETTLE WELDMENT	67892	67892
4	8-32 SERRATED FLANGE NUT		
5	¼ - 20 SERRATED LOCK NUT	46311	46311
6	ELEMENT CLAMP (6 required)	67894	67894
7	1550 TUBULAR HEAT ELEMENT	67014	67014
8	LIMIT THERMOSTAT SHIELD	67959	67959
9	8-32 TOP LOCK NUT (always replace if removed)	67943	67943
10	482 F THERMOSTAT (includes two 6-32 screws)	76708	
10	420 F THERMOSTAT (includes two 6-32 screws)		76707
11	THERMOSTAT SHUNT BAR	47193	47193
12	550 F THERMOSTAT (includes two 6-32 screws)	77108	77108
13	KETTLE SHELL ASSEMBLY (has Pivot Pins attached)	41081	41081
14	KETTLE LEAD ASSEMBLY	47361	47361
15	8-32 x 3/8 SLT HWHW M/S (fastens Nameplate to Jct. Box, and fastens Jct. Box to Kettle)	42044	42044
16	JUNCTION BOX	47393	47393
17	KETTLE CONDUIT LABEL	82840	82840
18	DUMP HANDLE ASSEMBLY (assembly includes Handle, Knob, 2 SQ HD Screws, and Key)	47102	47102
19	DUMP HANDLE KNOB	47110	47110
20	DUMP HANDLE	47707	47707
21	3 1/8 X ½ WOODRUFF KEY	41730	41730
22	5/16 - 18 X ½ SQ HD SCREW	47725	47725
23	5/16 - 18 X 3/8 SQ HD SCREW (holds key)	47662	47662
24	PIVOT PIN	41426	41426
25	1/4-20 ACORN NUT	42229	42229
26	1/4-20 X 3/8 BUTTON HEAD	12492	12492



16 oz. Kettle Assembly (55199, 55199KC) – Kettle Bottom Assembly – Parts List

Item	Part Description	Part Number	
		55199	55199KC
	16OZ KETTLE BOTTOM ASSY (Complete Assy.)	55200	55200KC
1	TRANSFER PLATE ASSY (beneath heat element)	67944	67944
2	KETTLE GASKET	41598	41598
3	KETTLE WELDMENT	67892	67892
4	8-32 SERRATED FLANGE NUT		
5	¼ - 20 SERRATED LOCK NUT	46311	46311
6	ELEMENT CLAMP (6 required)	67894	67894
7	1550 TUBULAR HEAT ELEMENT	67014	67014
8	LIMIT THERMOSTAT SHIELD	67959	67959
9	8-32 TOP LOCK NUT (always replace if removed)	67943	67943
10	482 F THERMOSTAT (includes two 6-32 screws)	76708	
10	420 F THERMOSTAT (includes two 6-32 screws)		76707
11	THERMOSTAT SHUNT BAR	47193	47193
12	550 F THERMOSTAT (includes two 6-32 screws)	77108	77108
13	KETTLE SHELL ASSEMBLY (has Pivot Pins attached)	41081	41081
14	KETTLE LEAD ASSEMBLY	47361	47361
15	8-32 x 3/8 SLT HWHW M/S (fastens Nameplate to Jct. Box, and fastens Jct. Box to Kettle)	42044	42044
16	JUNCTION BOX	47393	47393
17	KETTLE CONDUIT LABEL	82840	82840
18	DUMP HANDLE ASSEMBLY (assembly includes Handle, Knob, 2 SQ HD Screws, and Key)	47102	47102
19	DUMP HANDLE KNOB	47110	47110
20	DUMP HANDLE	47707	47707
21	3 1/8 X ½ WOODRUFF KEY	41730	41730
22	5/16 - 18 X ½ SQ HD SCREW	47725	47725
23	5/16 - 18 X 3/8 SQ HD SCREW (holds key)	47662	47662
24	PIVOT PIN	41426	41426
25	1/4-20 ACORN NUT	42229	42229
26	1/4-20 X 3/8 BUTTON HEAD	12492	12492



16 oz. Kettle Assembly (55199, 55199KC) – Kettle Bottom Assembly – Parts List

Item	Part Description	Part Number	
		55199	55199KC
	16OZ KETTLE BOTTOM ASSY (Complete Assy.)	55200	55200KC
1	TRANSFER PLATE ASSY (beneath heat element)	67944	67944
2	KETTLE GASKET	41598	41598
3	KETTLE WELDMENT	67892	67892
4	8-32 SERRATED FLANGE NUT		
5	¼ - 20 SERRATED LOCK NUT	46311	46311
6	ELEMENT CLAMP (6 required)	67894	67894
7	1550 TUBULAR HEAT ELEMENT	67014	67014
8	LIMIT THERMOSTAT SHIELD	67959	67959
9	8-32 TOP LOCK NUT (always replace if removed)	67943	67943
10	482 F THERMOSTAT (includes two 6-32 screws)	76708	
10	420 F THERMOSTAT (includes two 6-32 screws)		76707
11	THERMOSTAT SHUNT BAR	47193	47193
12	550 F THERMOSTAT (includes two 6-32 screws)	77108	77108
13	KETTLE SHELL ASSEMBLY (has Pivot Pins attached)	41081	41081
14	KETTLE LEAD ASSEMBLY	47361	47361
15	8-32 x 3/8 SLT HWHW M/S (fastens Nameplate to Jct. Box, and fastens Jct. Box to Kettle)	42044	42044
16	JUNCTION BOX	47393	47393
17	KETTLE CONDUIT LABEL	82840	82840
18	DUMP HANDLE ASSEMBLY (assembly includes Handle, Knob, 2 SQ HD Screws, and Key)	47102	47102
19	DUMP HANDLE KNOB	47110	47110
20	DUMP HANDLE	47707	47707
21	3 1/8 X ½ WOODRUFF KEY	41730	41730
22	5/16 - 18 X ½ SQ HD SCREW	47725	47725
23	5/16 - 18 X 3/8 SQ HD SCREW (holds key)	47662	47662
24	PIVOT PIN	41426	41426
25	1/4-20 ACORN NUT	42229	42229
26	1/4-20 X 3/8 BUTTON HEAD	12492	12492



16 oz. Kettle Assembly (55199, 55199KC) – Kettle Bottom Assembly – Parts List

Item	Part Description	Part Number	
		55199	55199KC
	16OZ KETTLE BOTTOM ASSY (Complete Assy.)	55200	55200KC
1	TRANSFER PLATE ASSY (beneath heat element)	67944	67944
2	KETTLE GASKET	41598	41598
3	KETTLE WELDMENT	67892	67892
4	8-32 SERRATED FLANGE NUT		
5	¼ - 20 SERRATED LOCK NUT	46311	46311
6	ELEMENT CLAMP (6 required)	67894	67894
7	1550 TUBULAR HEAT ELEMENT	67014	67014
8	LIMIT THERMOSTAT SHIELD	67959	67959
9	8-32 TOP LOCK NUT (always replace if removed)	67943	67943
10	482 F THERMOSTAT (includes two 6-32 screws)	76708	
10	420 F THERMOSTAT (includes two 6-32 screws)		76707
11	THERMOSTAT SHUNT BAR	47193	47193
12	550 F THERMOSTAT (includes two 6-32 screws)	77108	77108
13	KETTLE SHELL ASSEMBLY (has Pivot Pins attached)	41081	41081
14	KETTLE LEAD ASSEMBLY	47361	47361
15	8-32 x 3/8 SLT HWHW M/S (fastens Nameplate to Jct. Box, and fastens Jct. Box to Kettle)	42044	42044
16	JUNCTION BOX	47393	47393
17	KETTLE CONDUIT LABEL	82840	82840
18	DUMP HANDLE ASSEMBLY (assembly includes Handle, Knob, 2 SQ HD Screws, and Key)	47102	47102
19	DUMP HANDLE KNOB	47110	47110
20	DUMP HANDLE	47707	47707
21	3 1/8 X ½ WOODRUFF KEY	41730	41730
22	5/16 - 18 X ½ SQ HD SCREW	47725	47725
23	5/16 - 18 X 3/8 SQ HD SCREW (holds key)	47662	47662
24	PIVOT PIN	41426	41426
25	1/4-20 ACORN NUT	42229	42229
26	1/4-20 X 3/8 BUTTON HEAD	12492	12492



16 oz. Kettle Assembly (55199, 55199KC) – Kettle Bottom Assembly – Parts List

Item	Part Description	Part Number	
		55199	55199KC
	16OZ KETTLE BOTTOM ASSY (Complete Assy.)	55200	55200KC
1	TRANSFER PLATE ASSY (beneath heat element)	67944	67944
2	KETTLE GASKET	41598	41598
3	KETTLE WELDMENT	67892	67892
4	8-32 SERRATED FLANGE NUT		
5	¼ - 20 SERRATED LOCK NUT	46311	46311
6	ELEMENT CLAMP (6 required)	67894	67894
7	1550 TUBULAR HEAT ELEMENT	67014	67014
8	LIMIT THERMOSTAT SHIELD	67959	67959
9	8-32 TOP LOCK NUT (always replace if removed)	67943	67943
10	482 F THERMOSTAT (includes two 6-32 screws)	76708	
10	420 F THERMOSTAT (includes two 6-32 screws)		76707
11	THERMOSTAT SHUNT BAR	47193	47193
12	550 F THERMOSTAT (includes two 6-32 screws)	77108	77108
13	KETTLE SHELL ASSEMBLY (has Pivot Pins attached)	41081	41081
14	KETTLE LEAD ASSEMBLY	47361	47361
15	8-32 x 3/8 SLT HWHW M/S (fastens Nameplate to Jct. Box, and fastens Jct. Box to Kettle)	42044	42044
16	JUNCTION BOX	47393	47393
17	KETTLE CONDUIT LABEL	82840	82840
18	DUMP HANDLE ASSEMBLY (assembly includes Handle, Knob, 2 SQ HD Screws, and Key)	47102	47102
19	DUMP HANDLE KNOB	47110	47110
20	DUMP HANDLE	47707	47707
21	3 1/8 X ½ WOODRUFF KEY	41730	41730
22	5/16 - 18 X ½ SQ HD SCREW	47725	47725
23	5/16 - 18 X 3/8 SQ HD SCREW (holds key)	47662	47662
24	PIVOT PIN	41426	41426
25	1/4-20 ACORN NUT	42229	42229
26	1/4-20 X 3/8 BUTTON HEAD	12492	12492



16 oz. Kettle Assembly (55199, 55199KC) – Kettle Bottom Assembly – Parts List

Item	Part Description	Part Number	
		55199	55199KC
	16OZ KETTLE BOTTOM ASSY (Complete Assy.)	55200	55200KC
1	TRANSFER PLATE ASSY (beneath heat element)	67944	67944
2	KETTLE GASKET	41598	41598
3	KETTLE WELDMENT	67892	67892
4	8-32 SERRATED FLANGE NUT		
5	¼ - 20 SERRATED LOCK NUT	46311	46311
6	ELEMENT CLAMP (6 required)	67894	67894
7	1550 TUBULAR HEAT ELEMENT	67014	67014
8	LIMIT THERMOSTAT SHIELD	67959	67959
9	8-32 TOP LOCK NUT (always replace if removed)	67943	67943
10	482 F THERMOSTAT (includes two 6-32 screws)	76708	
10	420 F THERMOSTAT (includes two 6-32 screws)		76707
11	THERMOSTAT SHUNT BAR	47193	47193
12	550 F THERMOSTAT (includes two 6-32 screws)	77108	77108
13	KETTLE SHELL ASSEMBLY (has Pivot Pins attached)	41081	41081
14	KETTLE LEAD ASSEMBLY	47361	47361
15	8-32 x 3/8 SLT HWHW M/S (fastens Nameplate to Jct. Box, and fastens Jct. Box to Kettle)	42044	42044
16	JUNCTION BOX	47393	47393
17	KETTLE CONDUIT LABEL	82840	82840
18	DUMP HANDLE ASSEMBLY (assembly includes Handle, Knob, 2 SQ HD Screws, and Key)	47102	47102
19	DUMP HANDLE KNOB	47110	47110
20	DUMP HANDLE	47707	47707
21	3 1/8 X ½ WOODRUFF KEY	41730	41730
22	5/16 - 18 X ½ SQ HD SCREW	47725	47725
23	5/16 - 18 X 3/8 SQ HD SCREW (holds key)	47662	47662
24	PIVOT PIN	41426	41426
25	1/4-20 ACORN NUT	42229	42229
26	1/4-20 X 3/8 BUTTON HEAD	12492	12492



16 oz. Kettle Assembly (55199, 55199KC) – Kettle Bottom Assembly – Parts List

Item	Part Description	Part Number	
		55199	55199KC
	16OZ KETTLE BOTTOM ASSY (Complete Assy.)	55200	55200KC
1	TRANSFER PLATE ASSY (beneath heat element)	67944	67944
2	KETTLE GASKET	41598	41598
3	KETTLE WELDMENT	67892	67892
4	8-32 SERRATED FLANGE NUT		
5	¼ - 20 SERRATED LOCK NUT	46311	46311
6	ELEMENT CLAMP (6 required)	67894	67894
7	1550 TUBULAR HEAT ELEMENT	67014	67014
8	LIMIT THERMOSTAT SHIELD	67959	67959
9	8-32 TOP LOCK NUT (always replace if removed)	67943	67943
10	482 F THERMOSTAT (includes two 6-32 screws)	76708	
10	420 F THERMOSTAT (includes two 6-32 screws)		76707
11	THERMOSTAT SHUNT BAR	47193	47193
12	550 F THERMOSTAT (includes two 6-32 screws)	77108	77108
13	KETTLE SHELL ASSEMBLY (has Pivot Pins attached)	41081	41081
14	KETTLE LEAD ASSEMBLY	47361	47361
15	8-32 x 3/8 SLT HWHW M/S (fastens Nameplate to Jct. Box, and fastens Jct. Box to Kettle)	42044	42044
16	JUNCTION BOX	47393	47393
17	KETTLE CONDUIT LABEL	82840	82840
18	DUMP HANDLE ASSEMBLY (assembly includes Handle, Knob, 2 SQ HD Screws, and Key)	47102	47102
19	DUMP HANDLE KNOB	47110	47110
20	DUMP HANDLE	47707	47707
21	3 1/8 X ½ WOODRUFF KEY	41730	41730
22	5/16 - 18 X ½ SQ HD SCREW	47725	47725
23	5/16 - 18 X 3/8 SQ HD SCREW (holds key)	47662	47662
24	PIVOT PIN	41426	41426
25	1/4-20 ACORN NUT	42229	42229
26	1/4-20 X 3/8 BUTTON HEAD	12492	12492



16 oz. Kettle Assembly (55199, 55199KC) – Kettle Bottom Assembly – Parts List

Item	Part Description	Part Number	
		55199	55199KC
	16OZ KETTLE BOTTOM ASSY (Complete Assy.)	55200	55200KC
1	TRANSFER PLATE ASSY (beneath heat element)	67944	67944
2	KETTLE GASKET	41598	41598
3	KETTLE WELDMENT	67892	67892
4	8-32 SERRATED FLANGE NUT		
5	¼ - 20 SERRATED LOCK NUT	46311	46311
6	ELEMENT CLAMP (6 required)	67894	67894
7	1550 TUBULAR HEAT ELEMENT	67014	67014
8	LIMIT THERMOSTAT SHIELD	67959	67959
9	8-32 TOP LOCK NUT (always replace if removed)	67943	67943
10	482 F THERMOSTAT (includes two 6-32 screws)	76708	
10	420 F THERMOSTAT (includes two 6-32 screws)		76707
11	THERMOSTAT SHUNT BAR	47193	47193
12	550 F THERMOSTAT (includes two 6-32 screws)	77108	77108
13	KETTLE SHELL ASSEMBLY (has Pivot Pins attached)	41081	41081
14	KETTLE LEAD ASSEMBLY	47361	47361
15	8-32 x 3/8 SLT HWHW M/S (fastens Nameplate to Jct. Box, and fastens Jct. Box to Kettle)	42044	42044
16	JUNCTION BOX	47393	47393
17	KETTLE CONDUIT LABEL	82840	82840
18	DUMP HANDLE ASSEMBLY (assembly includes Handle, Knob, 2 SQ HD Screws, and Key)	47102	47102
19	DUMP HANDLE KNOB	47110	47110
20	DUMP HANDLE	47707	47707
21	3 1/8 X ½ WOODRUFF KEY	41730	41730
22	5/16 - 18 X ½ SQ HD SCREW	47725	47725
23	5/16 - 18 X 3/8 SQ HD SCREW (holds key)	47662	47662
24	PIVOT PIN	41426	41426
25	1/4-20 ACORN NUT	42229	42229
26	1/4-20 X 3/8 BUTTON HEAD	12492	12492



16 oz. Kettle Assembly (55199, 55199KC) – Kettle Bottom Assembly – Parts List

Item	Part Description	Part Number	
		55199	55199KC
	16OZ KETTLE BOTTOM ASSY (Complete Assy.)	55200	55200KC
1	TRANSFER PLATE ASSY (beneath heat element)	67944	67944
2	KETTLE GASKET	41598	41598
3	KETTLE WELDMENT	67892	67892
4	8-32 SERRATED FLANGE NUT		
5	¼ - 20 SERRATED LOCK NUT	46311	46311
6	ELEMENT CLAMP (6 required)	67894	67894
7	1550 TUBULAR HEAT ELEMENT	67014	67014
8	LIMIT THERMOSTAT SHIELD	67959	67959
9	8-32 TOP LOCK NUT (always replace if removed)	67943	67943
10	482 F THERMOSTAT (includes two 6-32 screws)	76708	
10	420 F THERMOSTAT (includes two 6-32 screws)		76707
11	THERMOSTAT SHUNT BAR	47193	47193
12	550 F THERMOSTAT (includes two 6-32 screws)	77108	77108
13	KETTLE SHELL ASSEMBLY (has Pivot Pins attached)	41081	41081
14	KETTLE LEAD ASSEMBLY	47361	47361
15	8-32 x 3/8 SLT HWHW M/S (fastens Nameplate to Jct. Box, and fastens Jct. Box to Kettle)	42044	42044
16	JUNCTION BOX	47393	47393
17	KETTLE CONDUIT LABEL	82840	82840
18	DUMP HANDLE ASSEMBLY (assembly includes Handle, Knob, 2 SQ HD Screws, and Key)	47102	47102
19	DUMP HANDLE KNOB	47110	47110
20	DUMP HANDLE	47707	47707
21	3 1/8 X ½ WOODRUFF KEY	41730	41730
22	5/16 - 18 X ½ SQ HD SCREW	47725	47725
23	5/16 - 18 X 3/8 SQ HD SCREW (holds key)	47662	47662
24	PIVOT PIN	41426	41426
25	1/4-20 ACORN NUT	42229	42229
26	1/4-20 X 3/8 BUTTON HEAD	12492	12492



16 oz. Kettle Assembly (55199, 55199KC) – Kettle Bottom Assembly – Parts List

Item	Part Description	Part Number	
		55199	55199KC
	16OZ KETTLE BOTTOM ASSY (Complete Assy.)	55200	55200KC
1	TRANSFER PLATE ASSY (beneath heat element)	67944	67944
2	KETTLE GASKET	41598	41598
3	KETTLE WELDMENT	67892	67892
4	8-32 SERRATED FLANGE NUT		
5	¼ - 20 SERRATED LOCK NUT	46311	46311
6	ELEMENT CLAMP (6 required)	67894	67894
7	1550 TUBULAR HEAT ELEMENT	67014	67014
8	LIMIT THERMOSTAT SHIELD	67959	67959
9	8-32 TOP LOCK NUT (always replace if removed)	67943	67943
10	482 F THERMOSTAT (includes two 6-32 screws)	76708	
10	420 F THERMOSTAT (includes two 6-32 screws)		76707
11	THERMOSTAT SHUNT BAR	47193	47193
12	550 F THERMOSTAT (includes two 6-32 screws)	77108	77108
13	KETTLE SHELL ASSEMBLY (has Pivot Pins attached)	41081	41081
14	KETTLE LEAD ASSEMBLY	47361	47361
15	8-32 x 3/8 SLT HWHW M/S (fastens Nameplate to Jct. Box, and fastens Jct. Box to Kettle)	42044	42044
16	JUNCTION BOX	47393	47393
17	KETTLE CONDUIT LABEL	82840	82840
18	DUMP HANDLE ASSEMBLY (assembly includes Handle, Knob, 2 SQ HD Screws, and Key)	47102	47102
19	DUMP HANDLE KNOB	47110	47110
20	DUMP HANDLE	47707	47707
21	3 1/8 X ½ WOODRUFF KEY	41730	41730
22	5/16 - 18 X ½ SQ HD SCREW	47725	47725
23	5/16 - 18 X 3/8 SQ HD SCREW (holds key)	47662	47662
24	PIVOT PIN	41426	41426
25	1/4-20 ACORN NUT	42229	42229
26	1/4-20 X 3/8 BUTTON HEAD	12492	12492



16 oz. Kettle Assembly (55199, 55199KC) – Kettle Bottom Assembly – Parts List

Item	Part Description	Part Number	
		55199	55199KC
	16OZ KETTLE BOTTOM ASSY (Complete Assy.)	55200	55200KC
1	TRANSFER PLATE ASSY (beneath heat element)	67944	67944
2	KETTLE GASKET	41598	41598
3	KETTLE WELDMENT	67892	67892
4	8-32 SERRATED FLANGE NUT		
5	¼ - 20 SERRATED LOCK NUT	46311	46311
6	ELEMENT CLAMP (6 required)	67894	67894
7	1550 TUBULAR HEAT ELEMENT	67014	67014
8	LIMIT THERMOSTAT SHIELD	67959	67959
9	8-32 TOP LOCK NUT (always replace if removed)	67943	67943
10	482 F THERMOSTAT (includes two 6-32 screws)	76708	
10	420 F THERMOSTAT (includes two 6-32 screws)		76707
11	THERMOSTAT SHUNT BAR	47193	47193
12	550 F THERMOSTAT (includes two 6-32 screws)	77108	77108
13	KETTLE SHELL ASSEMBLY (has Pivot Pins attached)	41081	41081
14	KETTLE LEAD ASSEMBLY	47361	47361
15	8-32 x 3/8 SLT HWHW M/S (fastens Nameplate to Jct. Box, and fastens Jct. Box to Kettle)	42044	42044
16	JUNCTION BOX	47393	47393
17	KETTLE CONDUIT LABEL	82840	82840
18	DUMP HANDLE ASSEMBLY (assembly includes Handle, Knob, 2 SQ HD Screws, and Key)	47102	47102
19	DUMP HANDLE KNOB	47110	47110
20	DUMP HANDLE	47707	47707
21	3 1/8 X ½ WOODRUFF KEY	41730	41730
22	5/16 - 18 X ½ SQ HD SCREW	47725	47725
23	5/16 - 18 X 3/8 SQ HD SCREW (holds key)	47662	47662
24	PIVOT PIN	41426	41426
25	1/4-20 ACORN NUT	42229	42229
26	1/4-20 X 3/8 BUTTON HEAD	12492	12492



16 oz. Kettle Assembly (55199, 55199KC) – Kettle Bottom Assembly – Parts List

Item	Part Description	Part Number	
		55199	55199KC
	16OZ KETTLE BOTTOM ASSY (Complete Assy.)	55200	55200KC
1	TRANSFER PLATE ASSY (beneath heat element)	67944	67944
2	KETTLE GASKET	41598	41598
3	KETTLE WELDMENT	67892	67892
4	8-32 SERRATED FLANGE NUT		
5	¼ - 20 SERRATED LOCK NUT	46311	46311
6	ELEMENT CLAMP (6 required)	67894	67894
7	1550 TUBULAR HEAT ELEMENT	67014	67014
8	LIMIT THERMOSTAT SHIELD	67959	67959
9	8-32 TOP LOCK NUT (always replace if removed)	67943	67943
10	482 F THERMOSTAT (includes two 6-32 screws)	76708	
10	420 F THERMOSTAT (includes two 6-32 screws)		76707
11	THERMOSTAT SHUNT BAR	47193	47193
12	550 F THERMOSTAT (includes two 6-32 screws)	77108	77108
13	KETTLE SHELL ASSEMBLY (has Pivot Pins attached)	41081	41081
14	KETTLE LEAD ASSEMBLY	47361	47361
15	8-32 x 3/8 SLT HWHW M/S (fastens Nameplate to Jct. Box, and fastens Jct. Box to Kettle)	42044	42044
16	JUNCTION BOX	47393	47393
17	KETTLE CONDUIT LABEL	82840	82840
18	DUMP HANDLE ASSEMBLY (assembly includes Handle, Knob, 2 SQ HD Screws, and Key)	47102	47102
19	DUMP HANDLE KNOB	47110	47110
20	DUMP HANDLE	47707	47707
21	3 1/8 X ½ WOODRUFF KEY	41730	41730
22	5/16 - 18 X ½ SQ HD SCREW	47725	47725
23	5/16 - 18 X 3/8 SQ HD SCREW (holds key)	47662	47662
24	PIVOT PIN	41426	41426
25	1/4-20 ACORN NUT	42229	42229
26	1/4-20 X 3/8 BUTTON HEAD	12492	12492



16 oz. Kettle Assembly (55199, 55199KC) – Kettle Bottom Assembly – Parts List

Item	Part Description	Part Number	
		55199	55199KC
	16OZ KETTLE BOTTOM ASSY (Complete Assy.)	55200	55200KC
1	TRANSFER PLATE ASSY (beneath heat element)	67944	67944
2	KETTLE GASKET	41598	41598
3	KETTLE WELDMENT	67892	67892
4	8-32 SERRATED FLANGE NUT		
5	¼ - 20 SERRATED LOCK NUT	46311	46311
6	ELEMENT CLAMP (6 required)	67894	67894
7	1550 TUBULAR HEAT ELEMENT	67014	67014
8	LIMIT THERMOSTAT SHIELD	67959	67959
9	8-32 TOP LOCK NUT (always replace if removed)	67943	67943
10	482 F THERMOSTAT (includes two 6-32 screws)	76708	
10	420 F THERMOSTAT (includes two 6-32 screws)		76707
11	THERMOSTAT SHUNT BAR	47193	47193
12	550 F THERMOSTAT (includes two 6-32 screws)	77108	77108
13	KETTLE SHELL ASSEMBLY (has Pivot Pins attached)	41081	41081
14	KETTLE LEAD ASSEMBLY	47361	47361
15	8-32 x 3/8 SLT HWHW M/S (fastens Nameplate to Jct. Box, and fastens Jct. Box to Kettle)	42044	42044
16	JUNCTION BOX	47393	47393
17	KETTLE CONDUIT LABEL	82840	82840
18	DUMP HANDLE ASSEMBLY (assembly includes Handle, Knob, 2 SQ HD Screws, and Key)	47102	47102
19	DUMP HANDLE KNOB	47110	47110
20	DUMP HANDLE	47707	47707
21	3 1/8 X ½ WOODRUFF KEY	41730	41730
22	5/16 - 18 X ½ SQ HD SCREW	47725	47725
23	5/16 - 18 X 3/8 SQ HD SCREW (holds key)	47662	47662
24	PIVOT PIN	41426	41426
25	1/4-20 ACORN NUT	42229	42229
26	1/4-20 X 3/8 BUTTON HEAD	12492	12492



16 oz. Kettle Assembly (55199, 55199KC) – Kettle Bottom Assembly – Parts List

Item	Part Description	Part Number	
		55199	55199KC
	16OZ KETTLE BOTTOM ASSY (Complete Assy.)	55200	55200KC
1	TRANSFER PLATE ASSY (beneath heat element)	67944	67944
2	KETTLE GASKET	41598	41598
3	KETTLE WELDMENT	67892	67892
4	8-32 SERRATED FLANGE NUT		
5	¼ - 20 SERRATED LOCK NUT	46311	46311
6	ELEMENT CLAMP (6 required)	67894	67894
7	1550 TUBULAR HEAT ELEMENT	67014	67014
8	LIMIT THERMOSTAT SHIELD	67959	67959
9	8-32 TOP LOCK NUT (always replace if removed)	67943	67943
10	482 F THERMOSTAT (includes two 6-32 screws)	76708	
10	420 F THERMOSTAT (includes two 6-32 screws)		76707
11	THERMOSTAT SHUNT BAR	47193	47193
12	550 F THERMOSTAT (includes two 6-32 screws)	77108	77108
13	KETTLE SHELL ASSEMBLY (has Pivot Pins attached)	41081	41081
14	KETTLE LEAD ASSEMBLY	47361	47361
15	8-32 x 3/8 SLT HWHW M/S (fastens Nameplate to Jct. Box, and fastens Jct. Box to Kettle)	42044	42044
16	JUNCTION BOX	47393	47393
17	KETTLE CONDUIT LABEL	82840	82840
18	DUMP HANDLE ASSEMBLY (assembly includes Handle, Knob, 2 SQ HD Screws, and Key)	47102	47102
19	DUMP HANDLE KNOB	47110	47110
20	DUMP HANDLE	47707	47707
21	3 1/8 X ½ WOODRUFF KEY	41730	41730
22	5/16 - 18 X ½ SQ HD SCREW	47725	47725
23	5/16 - 18 X 3/8 SQ HD SCREW (holds key)	47662	47662
24	PIVOT PIN	41426	41426
25	1/4-20 ACORN NUT	42229	42229
26	1/4-20 X 3/8 BUTTON HEAD	12492	12492



16 oz. Kettle Assembly (55199, 55199KC) – Kettle Bottom Assembly – Parts List

Item	Part Description	Part Number	
		55199	55199KC
	16OZ KETTLE BOTTOM ASSY (Complete Assy.)	55200	55200KC
1	TRANSFER PLATE ASSY (beneath heat element)	67944	67944
2	KETTLE GASKET	41598	41598
3	KETTLE WELDMENT	67892	67892
4	8-32 SERRATED FLANGE NUT		
5	¼ - 20 SERRATED LOCK NUT	46311	46311
6	ELEMENT CLAMP (6 required)	67894	67894
7	1550 TUBULAR HEAT ELEMENT	67014	67014
8	LIMIT THERMOSTAT SHIELD	67959	67959
9	8-32 TOP LOCK NUT (always replace if removed)	67943	67943
10	482 F THERMOSTAT (includes two 6-32 screws)	76708	
10	420 F THERMOSTAT (includes two 6-32 screws)		76707
11	THERMOSTAT SHUNT BAR	47193	47193
12	550 F THERMOSTAT (includes two 6-32 screws)	77108	77108
13	KETTLE SHELL ASSEMBLY (has Pivot Pins attached)	41081	41081
14	KETTLE LEAD ASSEMBLY	47361	47361
15	8-32 x 3/8 SLT HWHW M/S (fastens Nameplate to Jct. Box, and fastens Jct. Box to Kettle)	42044	42044
16	JUNCTION BOX	47393	47393
17	KETTLE CONDUIT LABEL	82840	82840
18	DUMP HANDLE ASSEMBLY (assembly includes Handle, Knob, 2 SQ HD Screws, and Key)	47102	47102
19	DUMP HANDLE KNOB	47110	47110
20	DUMP HANDLE	47707	47707
21	3 1/8 X ½ WOODRUFF KEY	41730	41730
22	5/16 - 18 X ½ SQ HD SCREW	47725	47725
23	5/16 - 18 X 3/8 SQ HD SCREW (holds key)	47662	47662
24	PIVOT PIN	41426	41426
25	1/4-20 ACORN NUT	42229	42229
26	1/4-20 X 3/8 BUTTON HEAD	12492	12492



16 oz. Kettle Assembly (55199, 55199KC) – Kettle Bottom Assembly – Parts List

Item	Part Description	Part Number	
		55199	55199KC
	16OZ KETTLE BOTTOM ASSY (Complete Assy.)	55200	55200KC
1	TRANSFER PLATE ASSY (beneath heat element)	67944	67944
2	KETTLE GASKET	41598	41598
3	KETTLE WELDMENT	67892	67892
4	8-32 SERRATED FLANGE NUT		
5	¼ - 20 SERRATED LOCK NUT	46311	46311
6	ELEMENT CLAMP (6 required)	67894	67894
7	1550 TUBULAR HEAT ELEMENT	67014	67014
8	LIMIT THERMOSTAT SHIELD	67959	67959
9	8-32 TOP LOCK NUT (always replace if removed)	67943	67943
10	482 F THERMOSTAT (includes two 6-32 screws)	76708	
10	420 F THERMOSTAT (includes two 6-32 screws)		76707
11	THERMOSTAT SHUNT BAR	47193	47193
12	550 F THERMOSTAT (includes two 6-32 screws)	77108	77108
13	KETTLE SHELL ASSEMBLY (has Pivot Pins attached)	41081	41081
14	KETTLE LEAD ASSEMBLY	47361	47361
15	8-32 x 3/8 SLT HWHW M/S (fastens Nameplate to Jct. Box, and fastens Jct. Box to Kettle)	42044	42044
16	JUNCTION BOX	47393	47393
17	KETTLE CONDUIT LABEL	82840	82840
18	DUMP HANDLE ASSEMBLY (assembly includes Handle, Knob, 2 SQ HD Screws, and Key)	47102	47102
19	DUMP HANDLE KNOB	47110	47110
20	DUMP HANDLE	47707	47707
21	3 1/8 X ½ WOODRUFF KEY	41730	41730
22	5/16 - 18 X ½ SQ HD SCREW	47725	47725
23	5/16 - 18 X 3/8 SQ HD SCREW (holds key)	47662	47662
24	PIVOT PIN	41426	41426
25	1/4-20 ACORN NUT	42229	42229
26	1/4-20 X 3/8 BUTTON HEAD	12492	12492



16 oz. Kettle Assembly (55199, 55199KC) – Kettle Bottom Assembly – Parts List

Item	Part Description	Part Number	
		55199	55199KC
	16OZ KETTLE BOTTOM ASSY (Complete Assy.)	55200	55200KC
1	TRANSFER PLATE ASSY (beneath heat element)	67944	67944
2	KETTLE GASKET	41598	41598
3	KETTLE WELDMENT	67892	67892
4	8-32 SERRATED FLANGE NUT		
5	¼ - 20 SERRATED LOCK NUT	46311	46311
6	ELEMENT CLAMP (6 required)	67894	67894
7	1550 TUBULAR HEAT ELEMENT	67014	67014
8	LIMIT THERMOSTAT SHIELD	67959	67959
9	8-32 TOP LOCK NUT (always replace if removed)	67943	67943
10	482 F THERMOSTAT (includes two 6-32 screws)	76708	
10	420 F THERMOSTAT (includes two 6-32 screws)		76707
11	THERMOSTAT SHUNT BAR	47193	47193
12	550 F THERMOSTAT (includes two 6-32 screws)	77108	77108
13	KETTLE SHELL ASSEMBLY (has Pivot Pins attached)	41081	41081
14	KETTLE LEAD ASSEMBLY	47361	47361
15	8-32 x 3/8 SLT HWHW M/S (fastens Nameplate to Jct. Box, and fastens Jct. Box to Kettle)	42044	42044
16	JUNCTION BOX	47393	47393
17	KETTLE CONDUIT LABEL	82840	82840
18	DUMP HANDLE ASSEMBLY (assembly includes Handle, Knob, 2 SQ HD Screws, and Key)	47102	47102
19	DUMP HANDLE KNOB	47110	47110
20	DUMP HANDLE	47707	47707
21	3 1/8 X ½ WOODRUFF KEY	41730	41730
22	5/16 - 18 X ½ SQ HD SCREW	47725	47725
23	5/16 - 18 X 3/8 SQ HD SCREW (holds key)	47662	47662
24	PIVOT PIN	41426	41426
25	1/4-20 ACORN NUT	42229	42229
26	1/4-20 X 3/8 BUTTON HEAD	12492	12492



16 oz. Kettle Assembly (55199, 55199KC) – Kettle Bottom Assembly – Parts List

Item	Part Description	Part Number	
		55199	55199KC
	16OZ KETTLE BOTTOM ASSY (Complete Assy.)	55200	55200KC
1	TRANSFER PLATE ASSY (beneath heat element)	67944	67944
2	KETTLE GASKET	41598	41598
3	KETTLE WELDMENT	67892	67892
4	8-32 SERRATED FLANGE NUT		
5	¼ - 20 SERRATED LOCK NUT	46311	46311
6	ELEMENT CLAMP (6 required)	67894	67894
7	1550 TUBULAR HEAT ELEMENT	67014	67014
8	LIMIT THERMOSTAT SHIELD	67959	67959
9	8-32 TOP LOCK NUT (always replace if removed)	67943	67943
10	482 F THERMOSTAT (includes two 6-32 screws)	76708	
10	420 F THERMOSTAT (includes two 6-32 screws)		76707
11	THERMOSTAT SHUNT BAR	47193	47193
12	550 F THERMOSTAT (includes two 6-32 screws)	77108	77108
13	KETTLE SHELL ASSEMBLY (has Pivot Pins attached)	41081	41081
14	KETTLE LEAD ASSEMBLY	47361	47361
15	8-32 x 3/8 SLT HWHW M/S (fastens Nameplate to Jct. Box, and fastens Jct. Box to Kettle)	42044	42044
16	JUNCTION BOX	47393	47393
17	KETTLE CONDUIT LABEL	82840	82840
18	DUMP HANDLE ASSEMBLY (assembly includes Handle, Knob, 2 SQ HD Screws, and Key)	47102	47102
19	DUMP HANDLE KNOB	47110	47110
20	DUMP HANDLE	47707	47707
21	3 1/8 X ½ WOODRUFF KEY	41730	41730
22	5/16 - 18 X ½ SQ HD SCREW	47725	47725
23	5/16 - 18 X 3/8 SQ HD SCREW (holds key)	47662	47662
24	PIVOT PIN	41426	41426
25	1/4-20 ACORN NUT	42229	42229
26	1/4-20 X 3/8 BUTTON HEAD	12492	12492

Cabinet Exterior – Front View

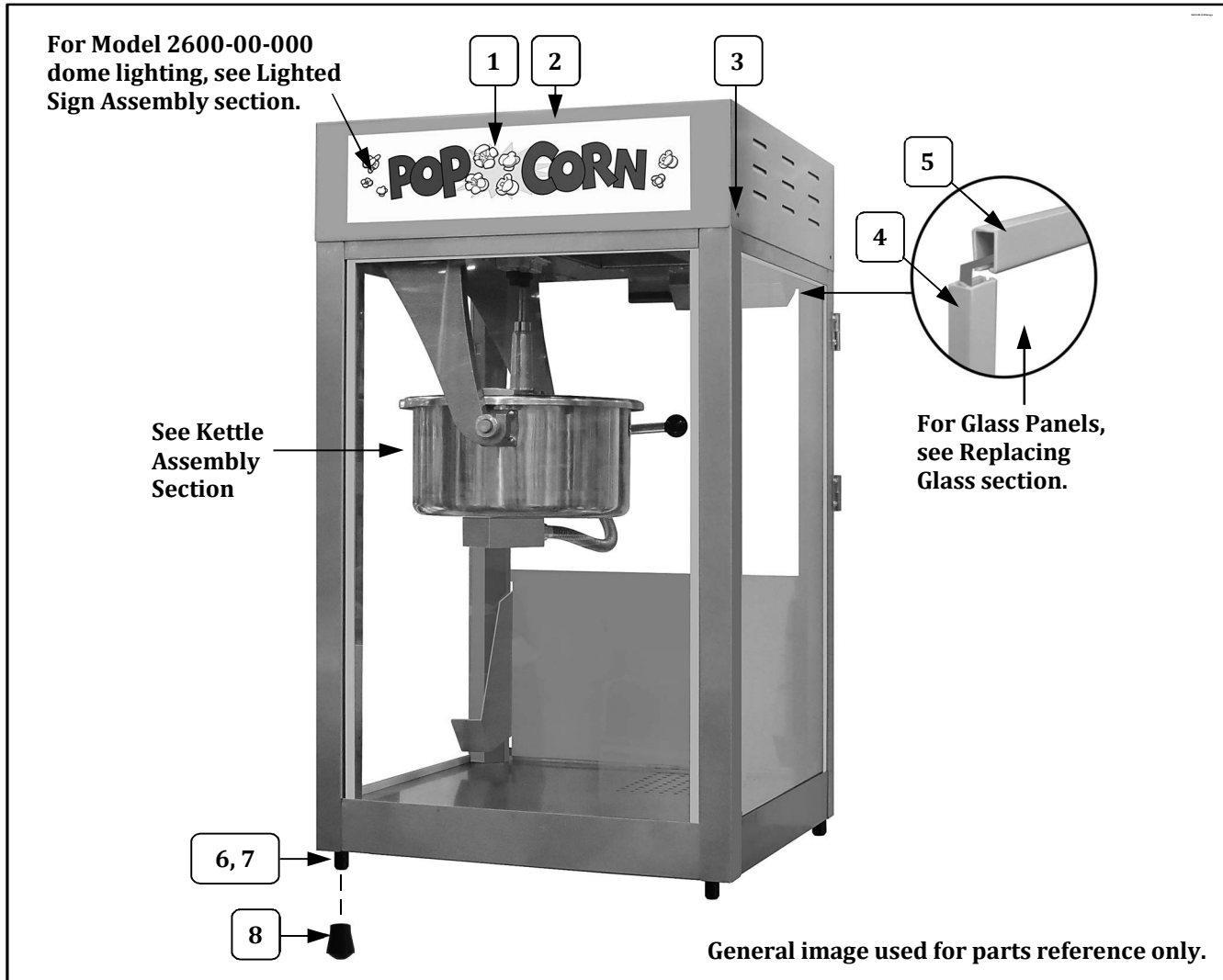

Item	Parts Description	Part Number			
		2600	2600A	2600-00-003	2600-00-000
1	POPCORN DECAL	49777	49777		
	PAPPY'S DECAL			49158KC	
2	DOMES	77769	77769	77769	77780
3	8-32 X 3/8 SLT. HWH M/S	42044	42044	42044	42044
4	26 1/8" GLASS CHANNEL (used on side edges of front and side glass panels)	61036	61036	61036	61036
5	16 1/4" GLASS CHANNEL (used on top and bottom edges of front and side glass panels)	74172	74172	74172	74172
6	GLIDE	47328	47328	47328	47328
7	10-24 X 3/4 HEX HD	41314	41314	41314	41314
8	BLACK CRUTCH TIP	49123	49123	49123	49123

Cabinet Exterior – Front View

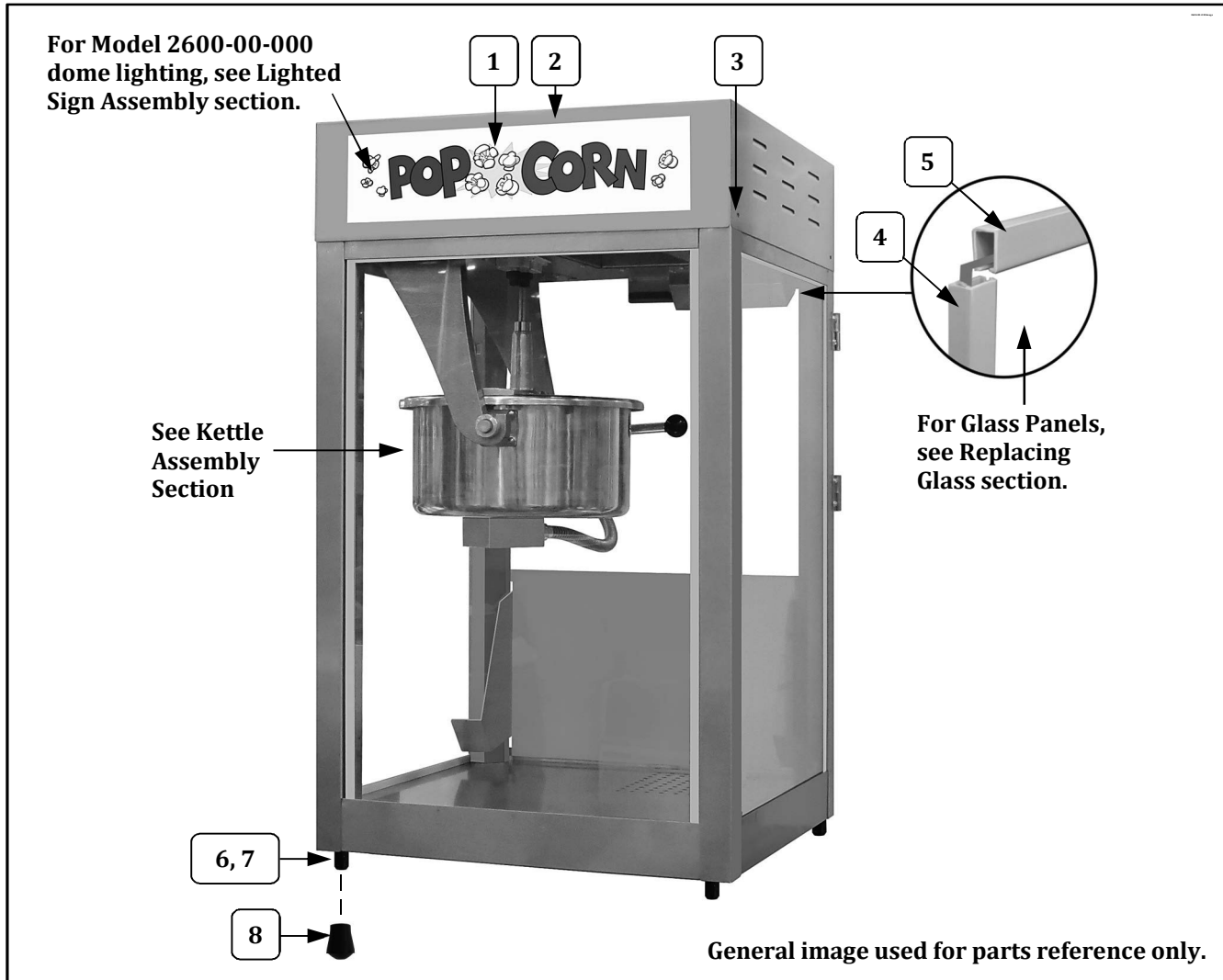

Item	Parts Description	Part Number			
		2600	2600A	2600-00-003	2600-00-000
1	POPCORN DECAL	49777	49777		
	PAPPY'S DECAL			49158KC	
2	DOMES	77769	77769	77769	77780
3	8-32 X 3/8 SLT. HWH M/S	42044	42044	42044	42044
4	26 1/8" GLASS CHANNEL (used on side edges of front and side glass panels)	61036	61036	61036	61036
5	16 1/4" GLASS CHANNEL (used on top and bottom edges of front and side glass panels)	74172	74172	74172	74172
6	GLIDE	47328	47328	47328	47328
7	10-24 X 3/4 HEX HD	41314	41314	41314	41314
8	BLACK CRUTCH TIP	49123	49123	49123	49123

Cabinet Exterior – Front View

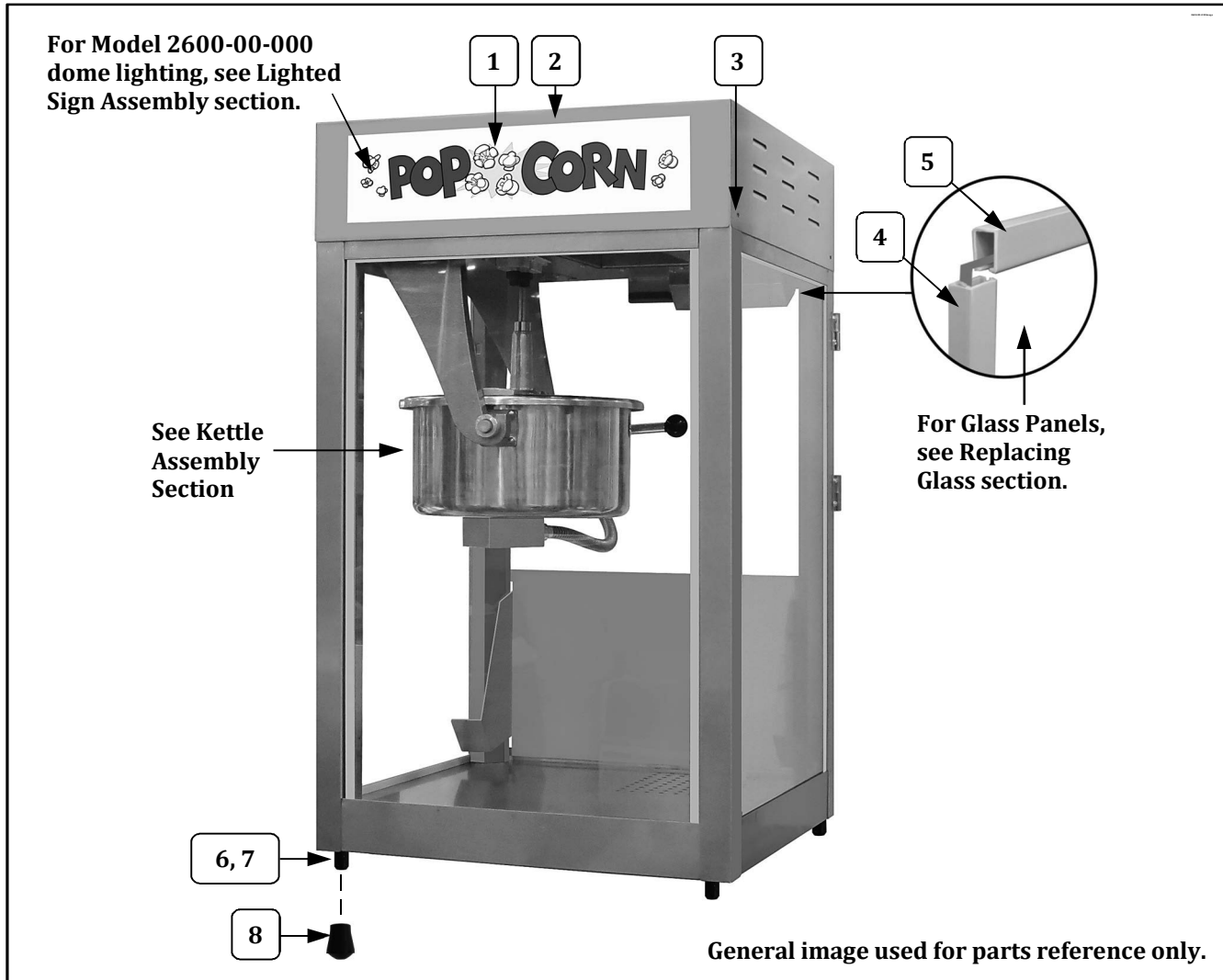

Item	Parts Description	Part Number			
		2600	2600A	2600-00-003	2600-00-000
1	POPCORN DECAL	49777	49777		
	PAPPY'S DECAL			49158KC	
2	DOMES	77769	77769	77769	77780
3	8-32 X 3/8 SLT. HWH M/S	42044	42044	42044	42044
4	26 1/8" GLASS CHANNEL (used on side edges of front and side glass panels)	61036	61036	61036	61036
5	16 1/4" GLASS CHANNEL (used on top and bottom edges of front and side glass panels)	74172	74172	74172	74172
6	GLIDE	47328	47328	47328	47328
7	10-24 X 3/4 HEX HD	41314	41314	41314	41314
8	BLACK CRUTCH TIP	49123	49123	49123	49123

Cabinet Exterior – Front View

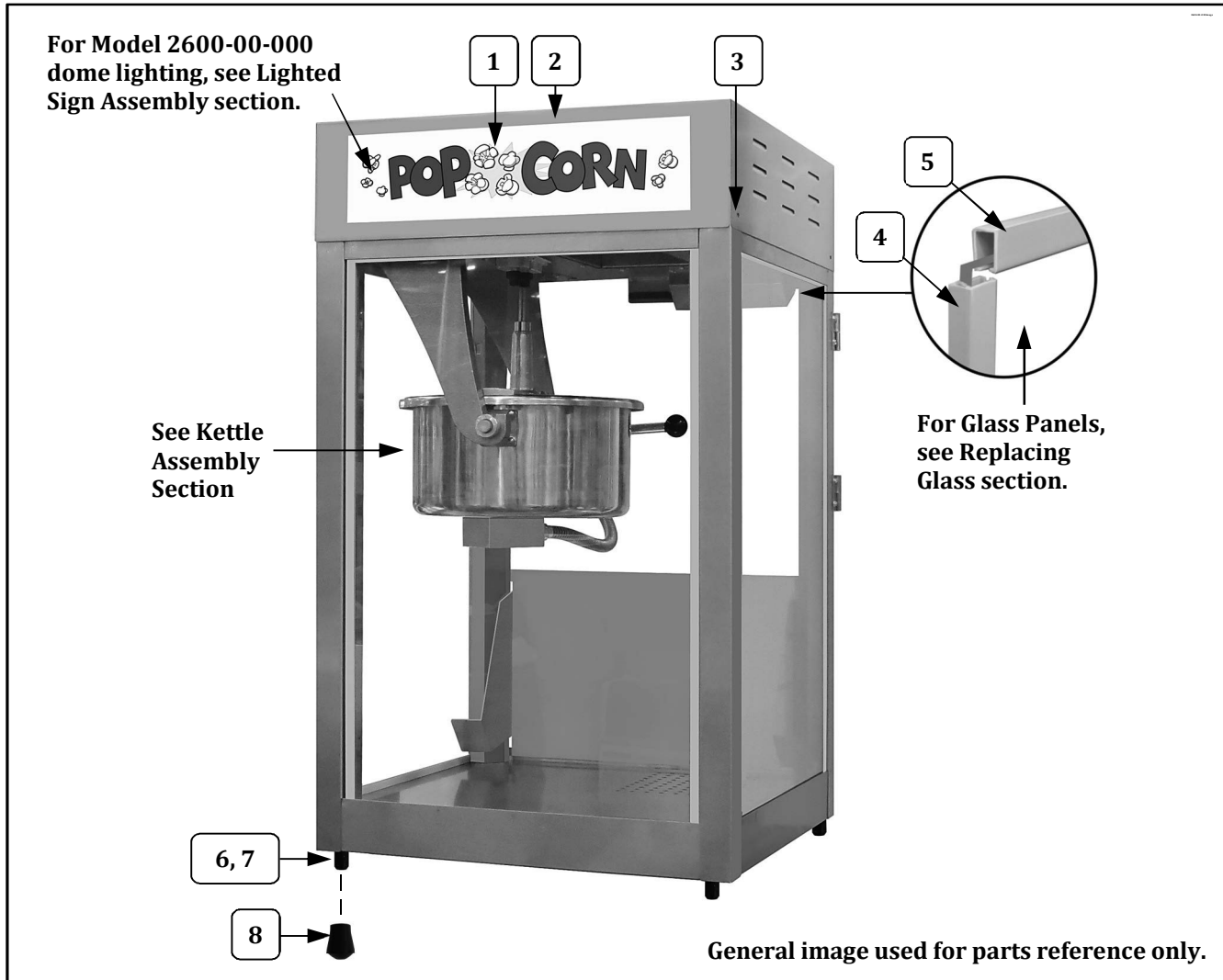

Item	Parts Description	Part Number			
		2600	2600A	2600-00-003	2600-00-000
1	POPCORN DECAL	49777	49777		
	PAPPY'S DECAL			49158KC	
2	DOMES	77769	77769	77769	77780
3	8-32 X 3/8 SLT. HWH M/S	42044	42044	42044	42044
4	26 1/8" GLASS CHANNEL (used on side edges of front and side glass panels)	61036	61036	61036	61036
5	16 1/4" GLASS CHANNEL (used on top and bottom edges of front and side glass panels)	74172	74172	74172	74172
6	GLIDE	47328	47328	47328	47328
7	10-24 X 3/4 HEX HD	41314	41314	41314	41314
8	BLACK CRUTCH TIP	49123	49123	49123	49123

Cabinet Exterior – Front View

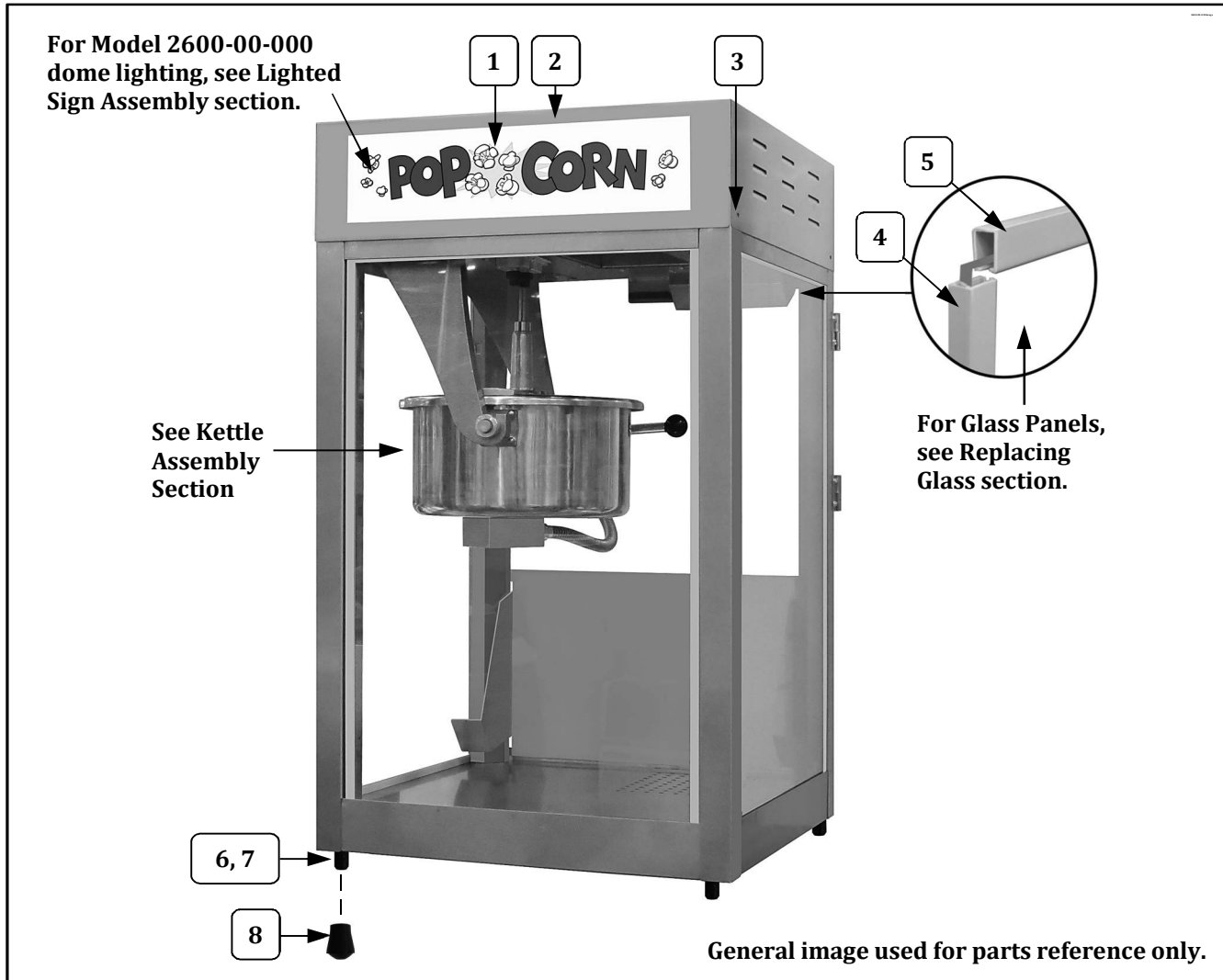

Item	Parts Description	Part Number			
		2600	2600A	2600-00-003	2600-00-000
1	POPCORN DECAL	49777	49777		
	PAPPY'S DECAL			49158KC	
2	DOMES	77769	77769	77769	77780
3	8-32 X 3/8 SLT. HWH M/S	42044	42044	42044	42044
4	26 1/8" GLASS CHANNEL (used on side edges of front and side glass panels)	61036	61036	61036	61036
5	16 1/4" GLASS CHANNEL (used on top and bottom edges of front and side glass panels)	74172	74172	74172	74172
6	GLIDE	47328	47328	47328	47328
7	10-24 X 3/4 HEX HD	41314	41314	41314	41314
8	BLACK CRUTCH TIP	49123	49123	49123	49123

Cabinet Exterior – Front View

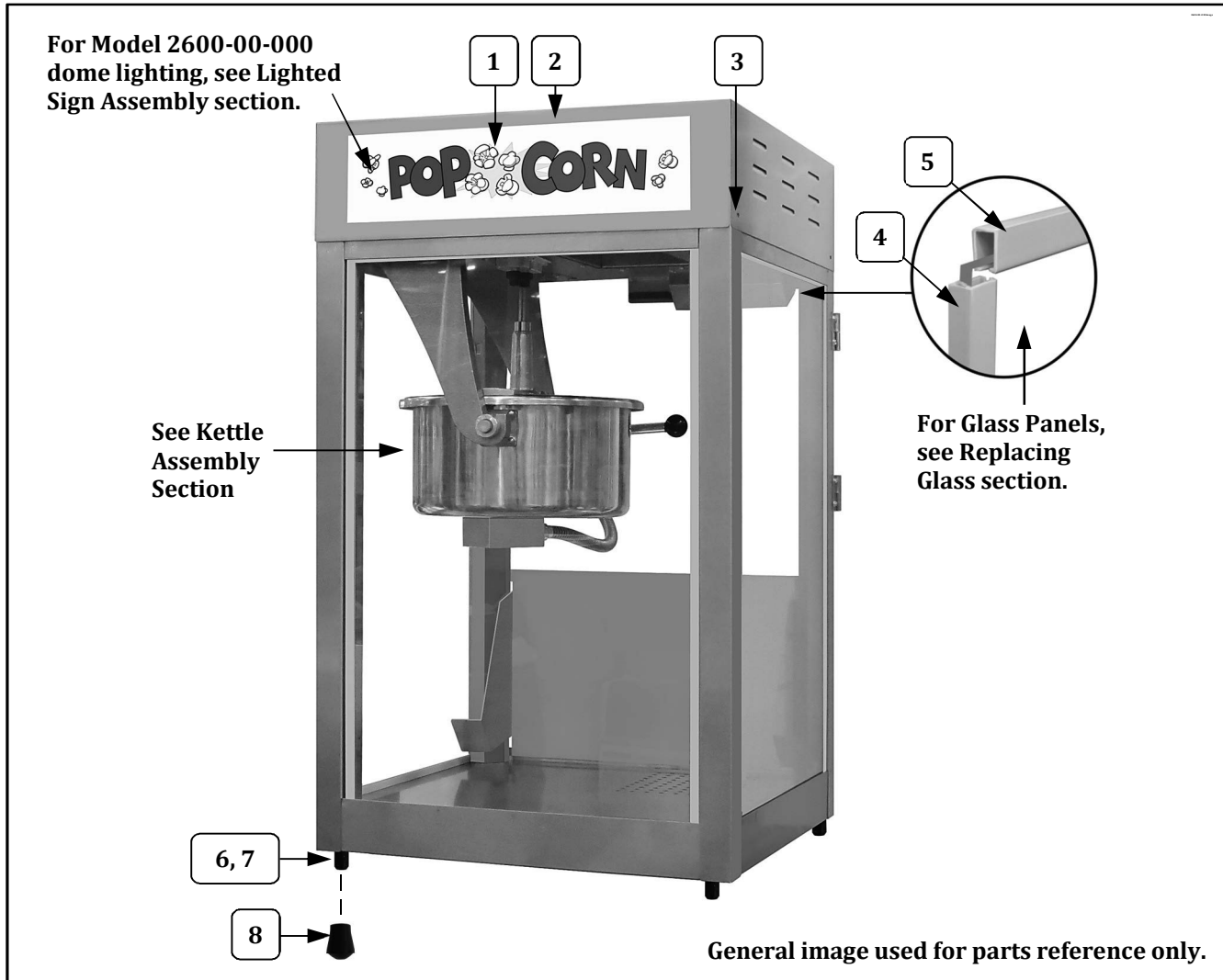

Item	Parts Description	Part Number			
		2600	2600A	2600-00-003	2600-00-000
1	POPCORN DECAL	49777	49777		
	PAPPY'S DECAL			49158KC	
2	DOMES	77769	77769	77769	77780
3	8-32 X 3/8 SLT. HWH M/S	42044	42044	42044	42044
4	26 1/8" GLASS CHANNEL (used on side edges of front and side glass panels)	61036	61036	61036	61036
5	16 1/4" GLASS CHANNEL (used on top and bottom edges of front and side glass panels)	74172	74172	74172	74172
6	GLIDE	47328	47328	47328	47328
7	10-24 X 3/4 HEX HD	41314	41314	41314	41314
8	BLACK CRUTCH TIP	49123	49123	49123	49123



Cabinet Exterior – Front View

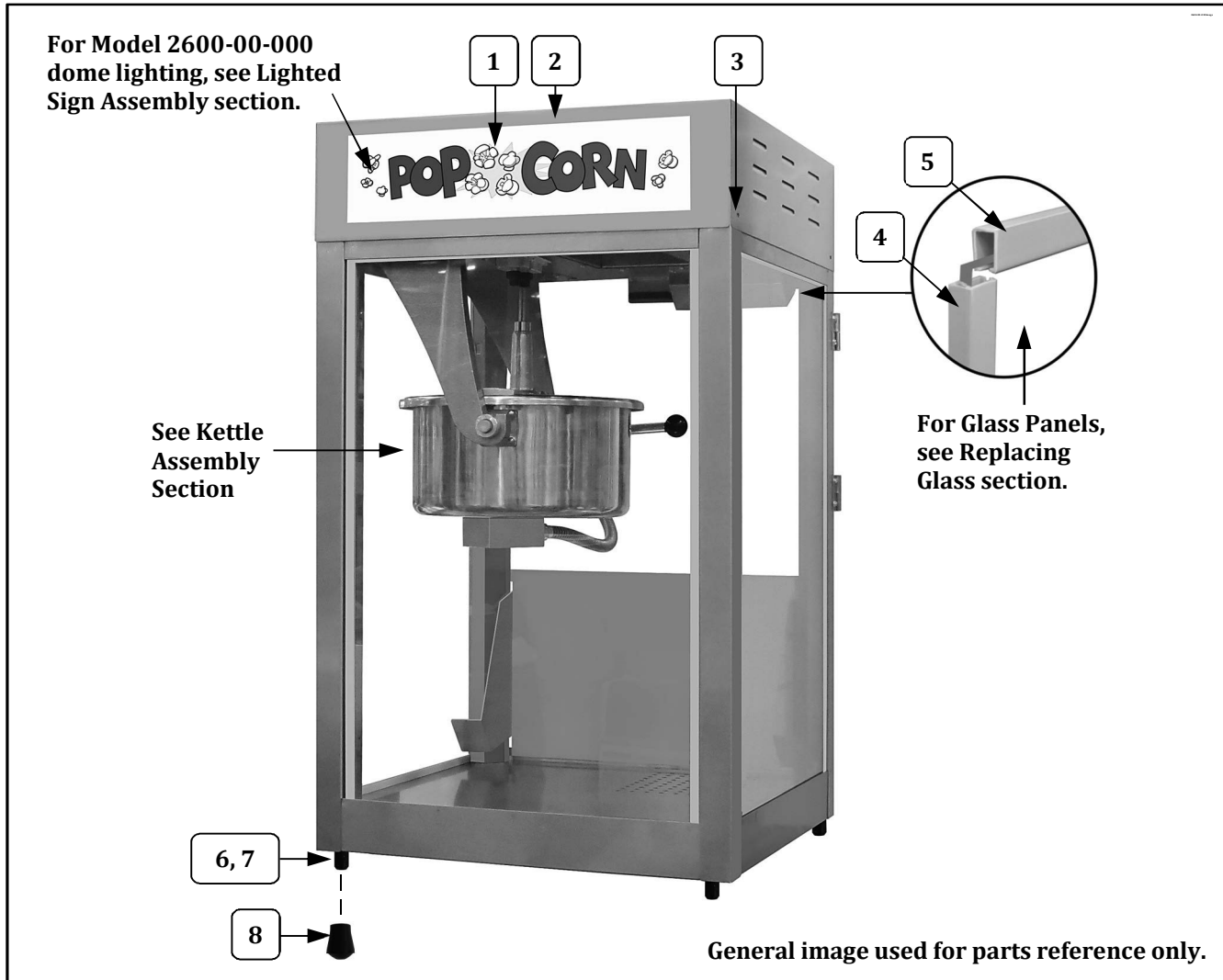

Item	Parts Description	Part Number			
		2600	2600A	2600-00-003	2600-00-000
1	POPCORN DECAL	49777	49777		
	PAPPY'S DECAL			49158KC	
2	DOMES	77769	77769	77769	77780
3	8-32 X 3/8 SLT. HWH M/S	42044	42044	42044	42044
4	26 1/8" GLASS CHANNEL (used on side edges of front and side glass panels)	61036	61036	61036	61036
5	16 1/4" GLASS CHANNEL (used on top and bottom edges of front and side glass panels)	74172	74172	74172	74172
6	GLIDE	47328	47328	47328	47328
7	10-24 X 3/4 HEX HD	41314	41314	41314	41314
8	BLACK CRUTCH TIP	49123	49123	49123	49123

Cabinet Exterior – Front View

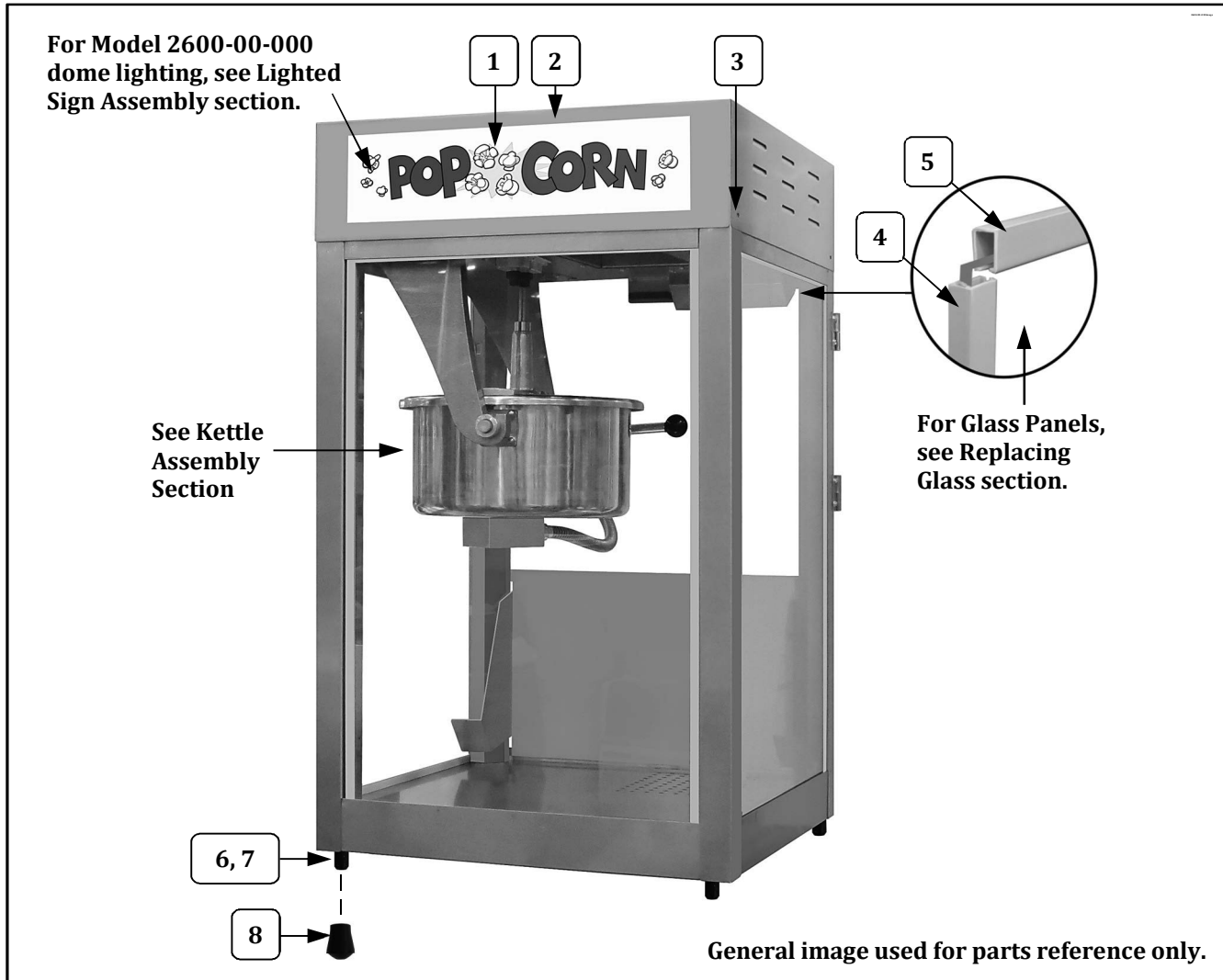

Item	Parts Description	Part Number			
		2600	2600A	2600-00-003	2600-00-000
1	POPCORN DECAL	49777	49777		
	PAPPY'S DECAL			49158KC	
2	DOMES	77769	77769	77769	77780
3	8-32 X 3/8 SLT. HWH M/S	42044	42044	42044	42044
4	26 1/8" GLASS CHANNEL (used on side edges of front and side glass panels)	61036	61036	61036	61036
5	16 1/4" GLASS CHANNEL (used on top and bottom edges of front and side glass panels)	74172	74172	74172	74172
6	GLIDE	47328	47328	47328	47328
7	10-24 X 3/4 HEX HD	41314	41314	41314	41314
8	BLACK CRUTCH TIP	49123	49123	49123	49123

Cabinet Exterior – Front View

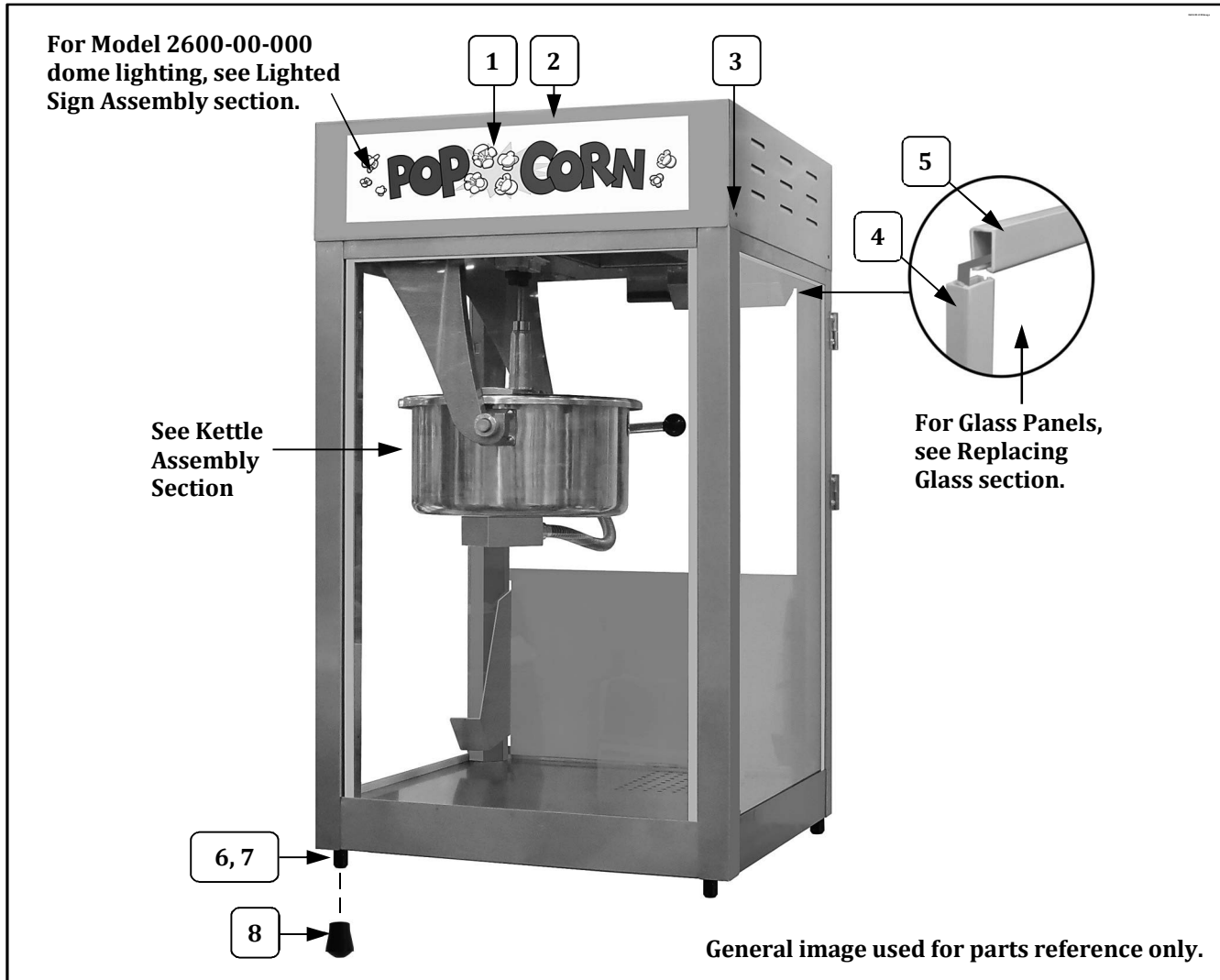

Item	Parts Description	Part Number			
		2600	2600A	2600-00-003	2600-00-000
1	POPCORN DECAL	49777	49777		
	PAPPY'S DECAL			49158KC	
2	DOMES	77769	77769	77769	77780
3	8-32 X 3/8 SLT. HWH M/S	42044	42044	42044	42044
4	26 1/8" GLASS CHANNEL (used on side edges of front and side glass panels)	61036	61036	61036	61036
5	16 1/4" GLASS CHANNEL (used on top and bottom edges of front and side glass panels)	74172	74172	74172	74172
6	GLIDE	47328	47328	47328	47328
7	10-24 X 3/4 HEX HD	41314	41314	41314	41314
8	BLACK CRUTCH TIP	49123	49123	49123	49123

Cabinet Exterior – Front View

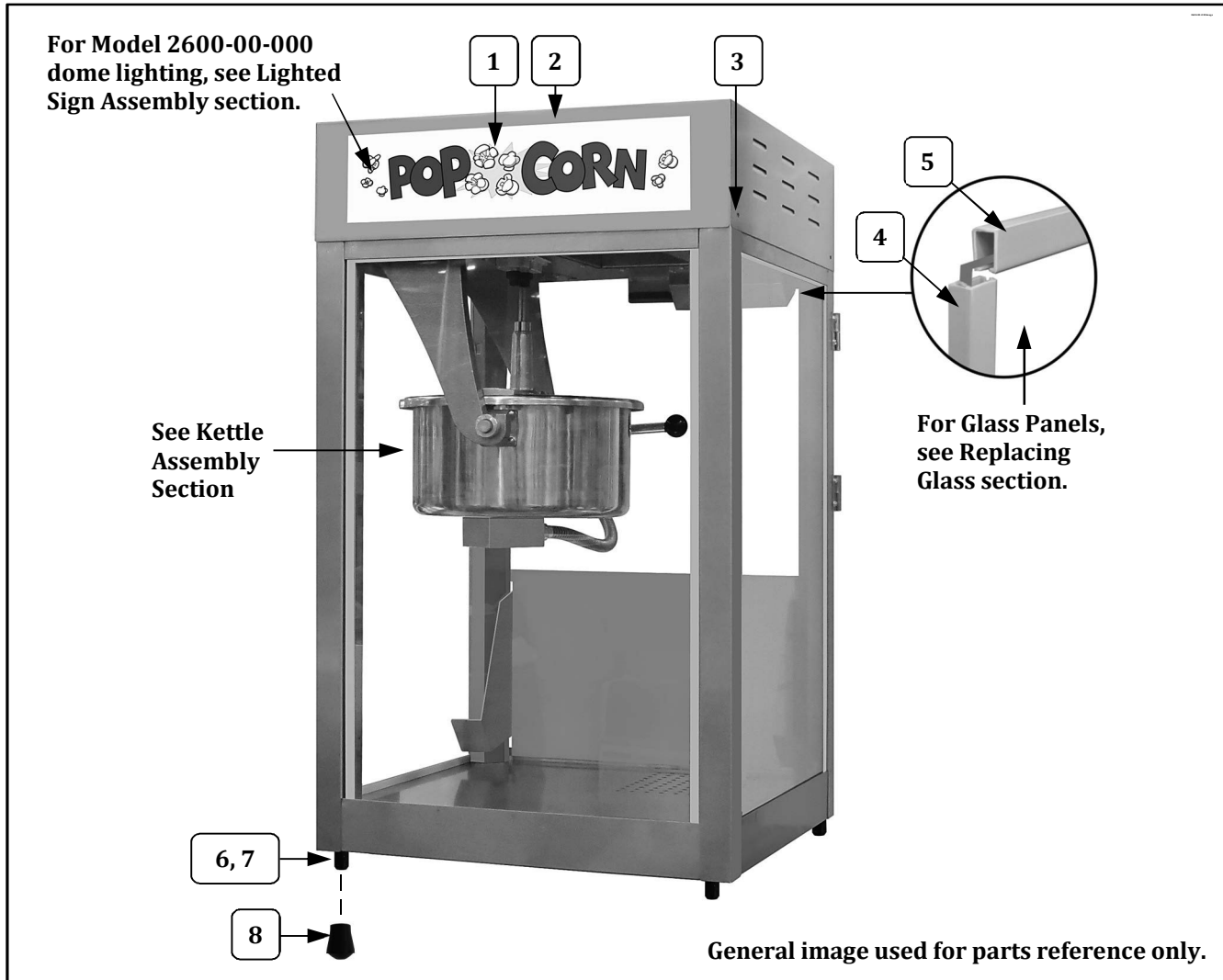

Item	Parts Description	Part Number			
		2600	2600A	2600-00-003	2600-00-000
1	POPCORN DECAL	49777	49777		
	PAPPY'S DECAL			49158KC	
2	DOME	77769	77769	77769	77780
3	8-32 X 3/8 SLT. HWH M/S	42044	42044	42044	42044
4	26 1/8" GLASS CHANNEL (used on side edges of front and side glass panels)	61036	61036	61036	61036
5	16 1/4" GLASS CHANNEL (used on top and bottom edges of front and side glass panels)	74172	74172	74172	74172
6	GLIDE	47328	47328	47328	47328
7	10-24 X 3/4 HEX HD	41314	41314	41314	41314
8	BLACK CRUTCH TIP	49123	49123	49123	49123

Cabinet Exterior – Front View

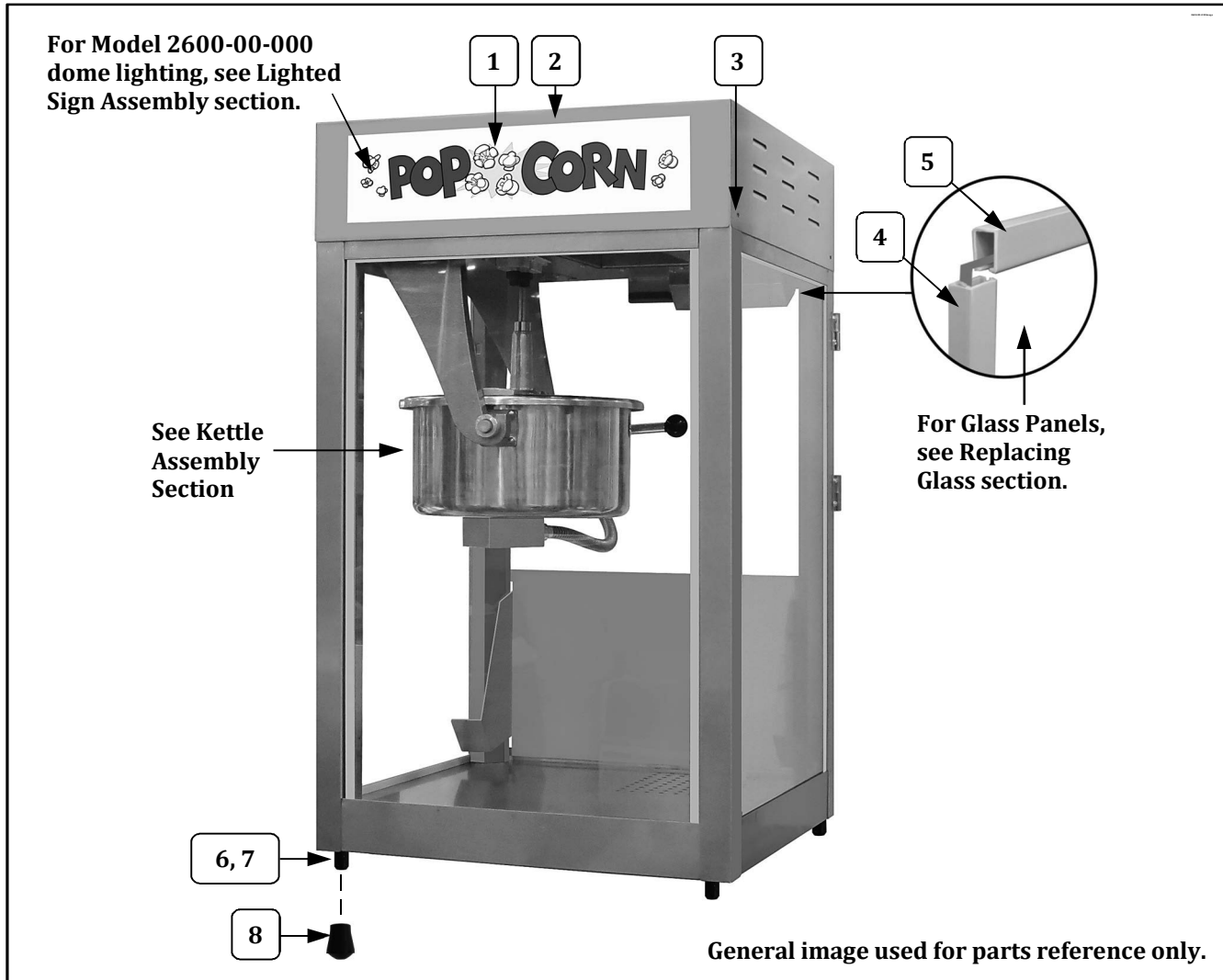

Item	Parts Description	Part Number			
		2600	2600A	2600-00-003	2600-00-000
1	POPCORN DECAL	49777	49777		
	PAPPY'S DECAL			49158KC	
2	DOMES	77769	77769	77769	77780
3	8-32 X 3/8 SLT. HWH M/S	42044	42044	42044	42044
4	26 1/8" GLASS CHANNEL (used on side edges of front and side glass panels)	61036	61036	61036	61036
5	16 1/4" GLASS CHANNEL (used on top and bottom edges of front and side glass panels)	74172	74172	74172	74172
6	GLIDE	47328	47328	47328	47328
7	10-24 X 3/4 HEX HD	41314	41314	41314	41314
8	BLACK CRUTCH TIP	49123	49123	49123	49123



Cabinet Exterior – Front View

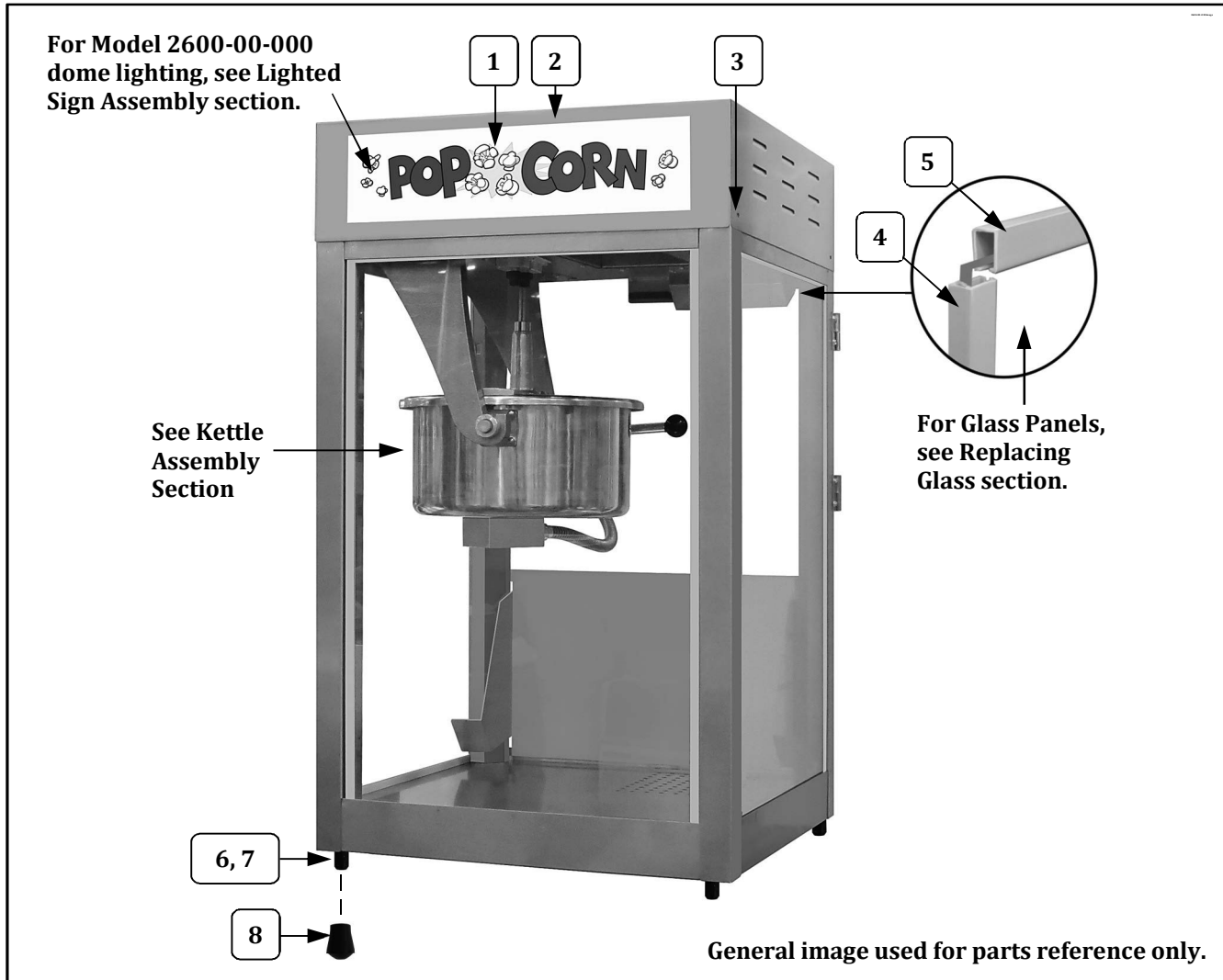

Item	Parts Description	Part Number			
		2600	2600A	2600-00-003	2600-00-000
1	POPCORN DECAL	49777	49777		
	PAPPY'S DECAL			49158KC	
2	DOMES	77769	77769	77769	77780
3	8-32 X 3/8 SLT. HWH M/S	42044	42044	42044	42044
4	26 1/8" GLASS CHANNEL (used on side edges of front and side glass panels)	61036	61036	61036	61036
5	16 1/4" GLASS CHANNEL (used on top and bottom edges of front and side glass panels)	74172	74172	74172	74172
6	GLIDE	47328	47328	47328	47328
7	10-24 X 3/4 HEX HD	41314	41314	41314	41314
8	BLACK CRUTCH TIP	49123	49123	49123	49123

Cabinet Exterior – Front View

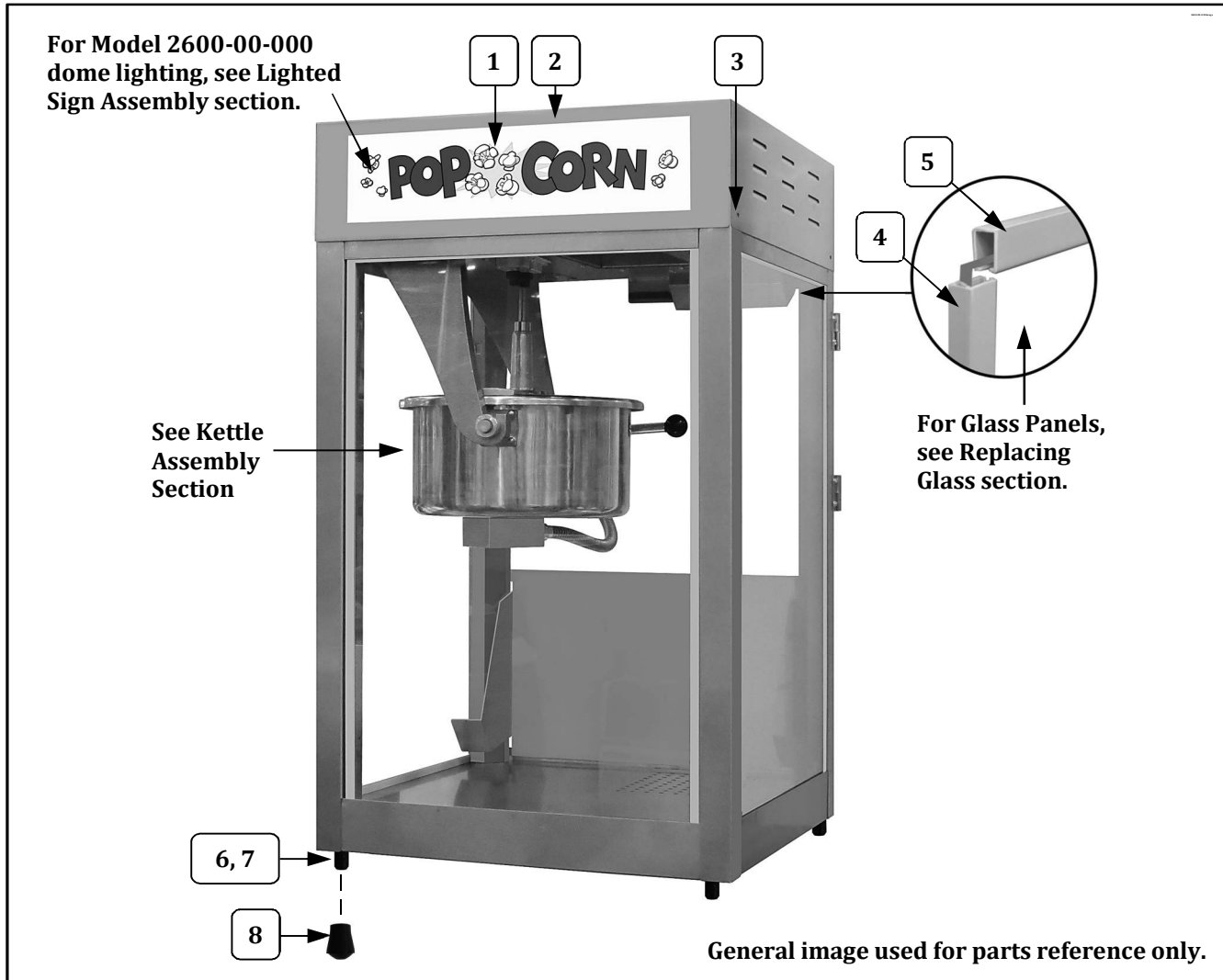

Item	Parts Description	Part Number			
		2600	2600A	2600-00-003	2600-00-000
1	POPCORN DECAL	49777	49777		
	PAPPY'S DECAL			49158KC	
2	DOMES	77769	77769	77769	77780
3	8-32 X 3/8 SLT. HWH M/S	42044	42044	42044	42044
4	26 1/8" GLASS CHANNEL (used on side edges of front and side glass panels)	61036	61036	61036	61036
5	16 1/4" GLASS CHANNEL (used on top and bottom edges of front and side glass panels)	74172	74172	74172	74172
6	GLIDE	47328	47328	47328	47328
7	10-24 X 3/4 HEX HD	41314	41314	41314	41314
8	BLACK CRUTCH TIP	49123	49123	49123	49123

Cabinet Exterior – Front View

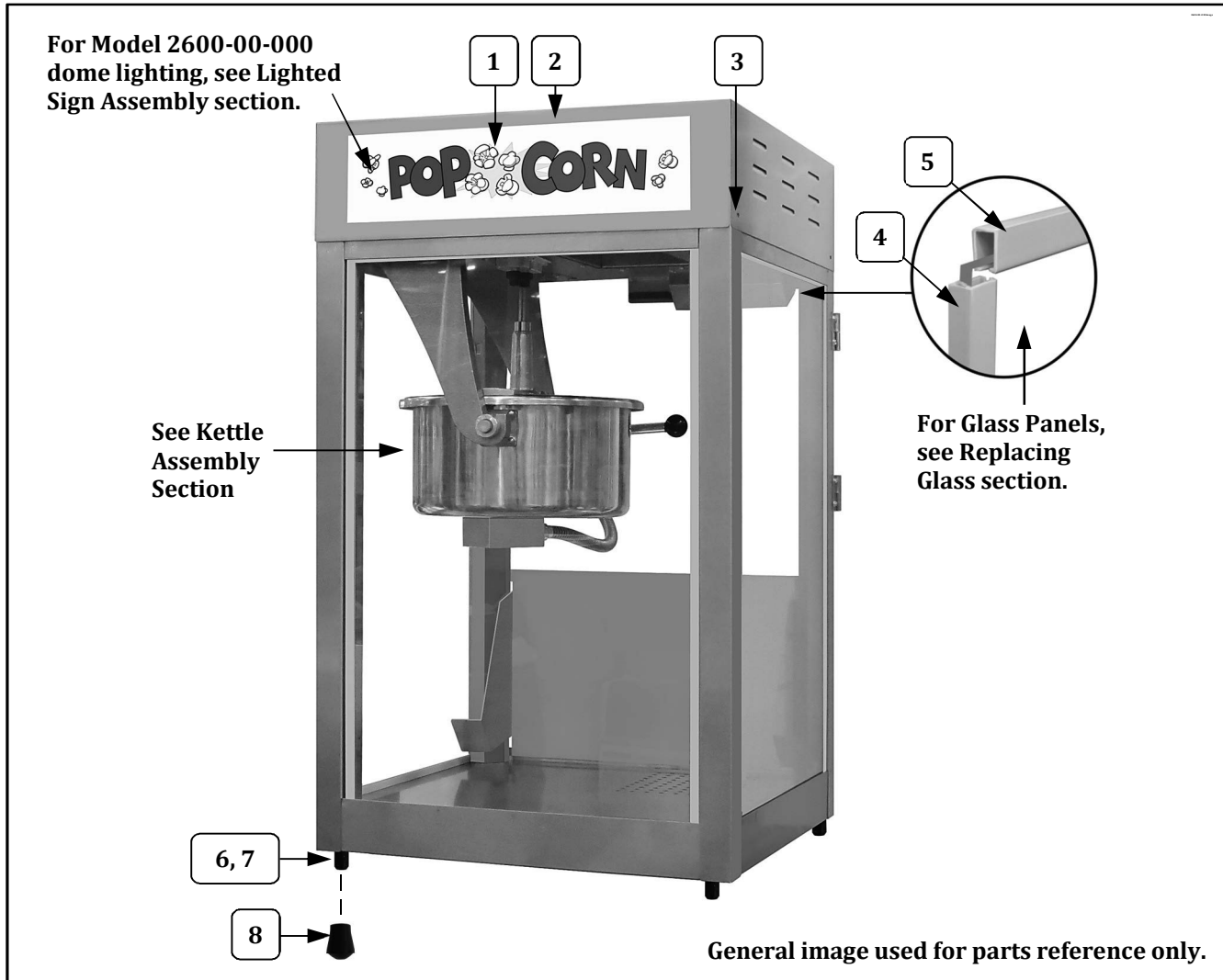

Item	Parts Description	Part Number			
		2600	2600A	2600-00-003	2600-00-000
1	POPCORN DECAL	49777	49777		
	PAPPY'S DECAL			49158KC	
2	DOMES	77769	77769	77769	77780
3	8-32 X 3/8 SLT. HWH M/S	42044	42044	42044	42044
4	26 1/8" GLASS CHANNEL (used on side edges of front and side glass panels)	61036	61036	61036	61036
5	16 1/4" GLASS CHANNEL (used on top and bottom edges of front and side glass panels)	74172	74172	74172	74172
6	GLIDE	47328	47328	47328	47328
7	10-24 X 3/4 HEX HD	41314	41314	41314	41314
8	BLACK CRUTCH TIP	49123	49123	49123	49123

Cabinet Exterior – Front View

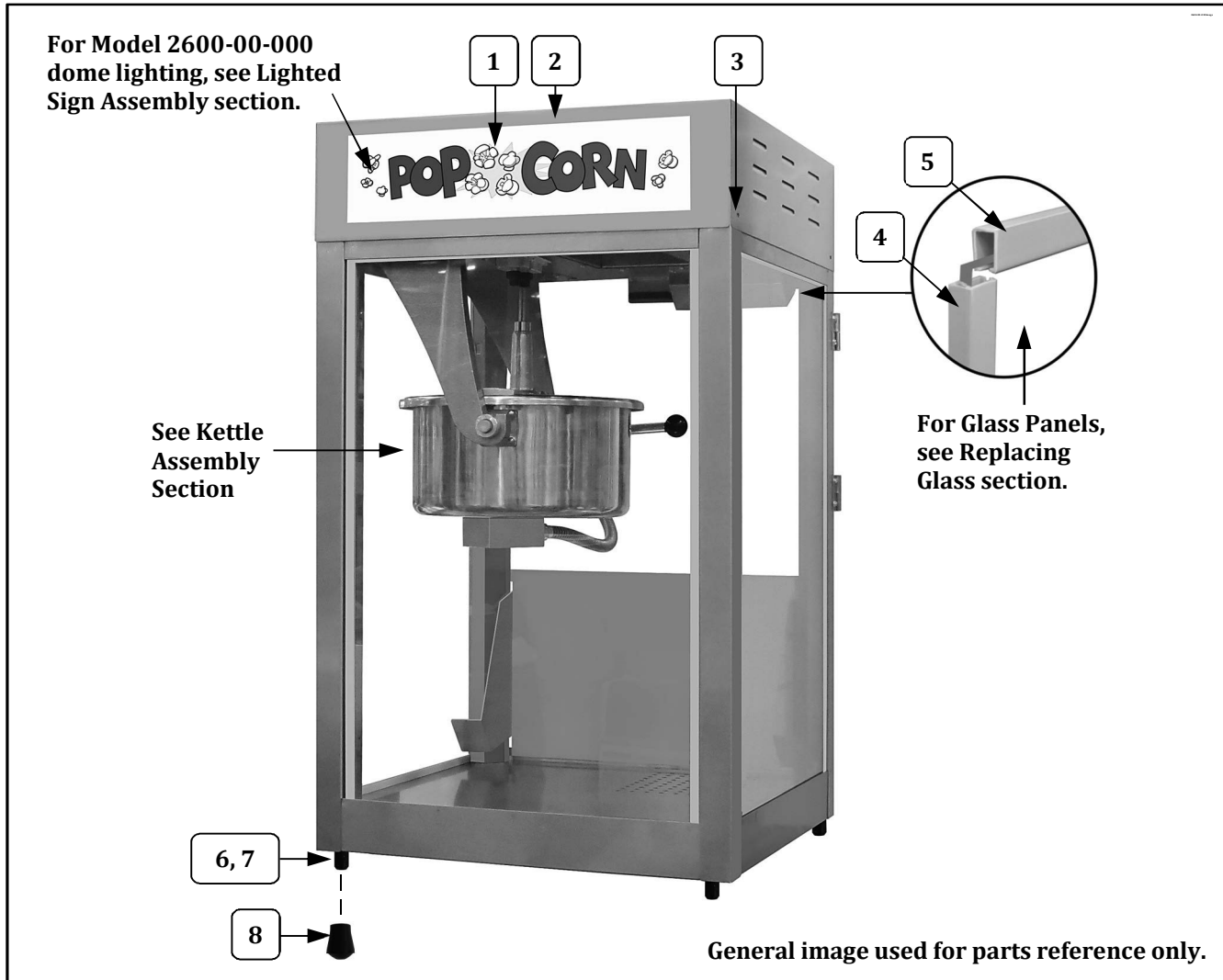

Item	Parts Description	Part Number			
		2600	2600A	2600-00-003	2600-00-000
1	POPCORN DECAL	49777	49777		
	PAPPY'S DECAL			49158KC	
2	DOMES	77769	77769	77769	77780
3	8-32 X 3/8 SLT. HWH M/S	42044	42044	42044	42044
4	26 1/8" GLASS CHANNEL (used on side edges of front and side glass panels)	61036	61036	61036	61036
5	16 1/4" GLASS CHANNEL (used on top and bottom edges of front and side glass panels)	74172	74172	74172	74172
6	GLIDE	47328	47328	47328	47328
7	10-24 X 3/4 HEX HD	41314	41314	41314	41314
8	BLACK CRUTCH TIP	49123	49123	49123	49123

Cabinet Exterior – Front View

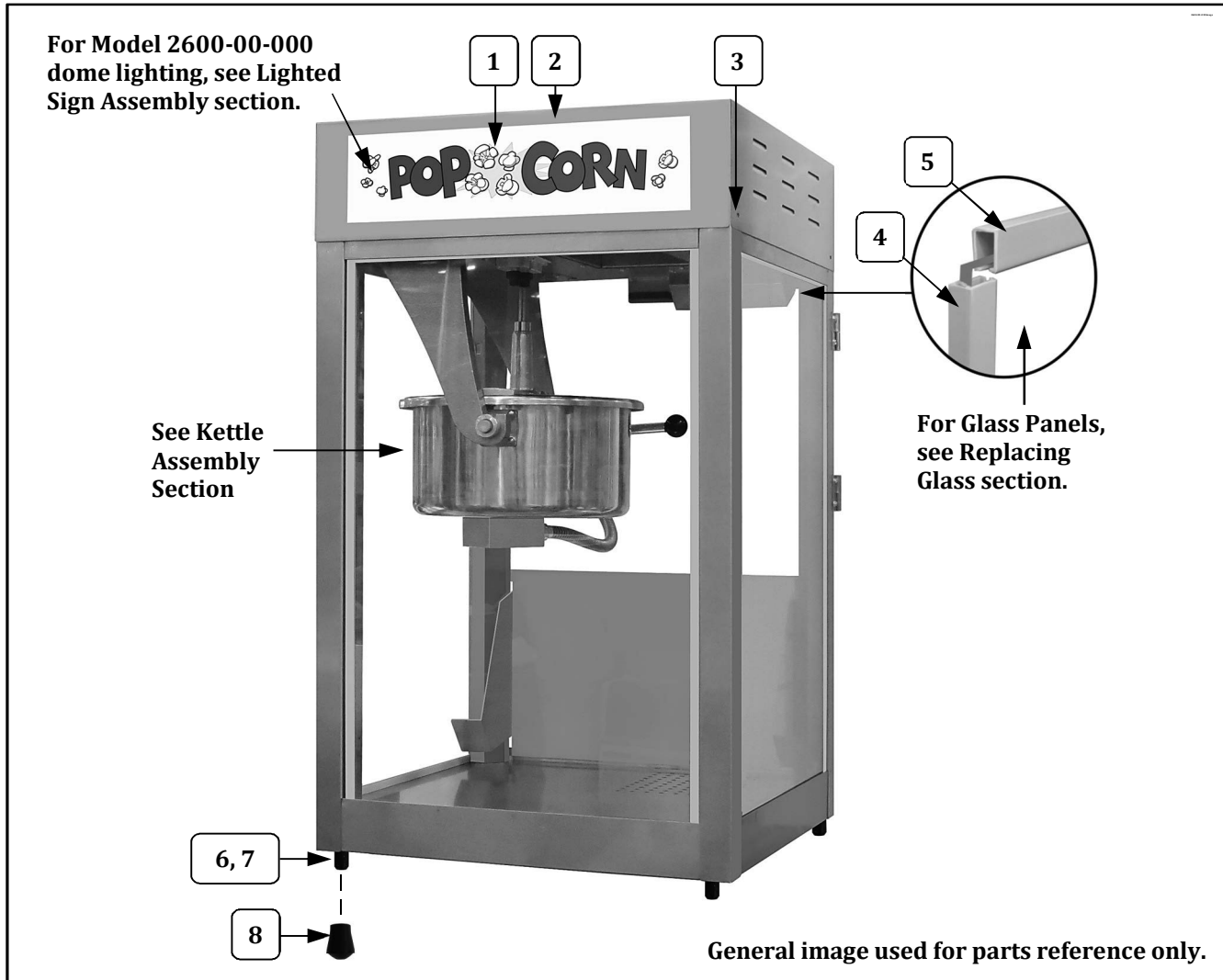

Item	Parts Description	Part Number			
		2600	2600A	2600-00-003	2600-00-000
1	POPCORN DECAL	49777	49777		
	PAPPY'S DECAL			49158KC	
2	DOMES	77769	77769	77769	77780
3	8-32 X 3/8 SLT. HWH M/S	42044	42044	42044	42044
4	26 1/8" GLASS CHANNEL (used on side edges of front and side glass panels)	61036	61036	61036	61036
5	16 1/4" GLASS CHANNEL (used on top and bottom edges of front and side glass panels)	74172	74172	74172	74172
6	GLIDE	47328	47328	47328	47328
7	10-24 X 3/4 HEX HD	41314	41314	41314	41314
8	BLACK CRUTCH TIP	49123	49123	49123	49123

Cabinet Exterior – Front View

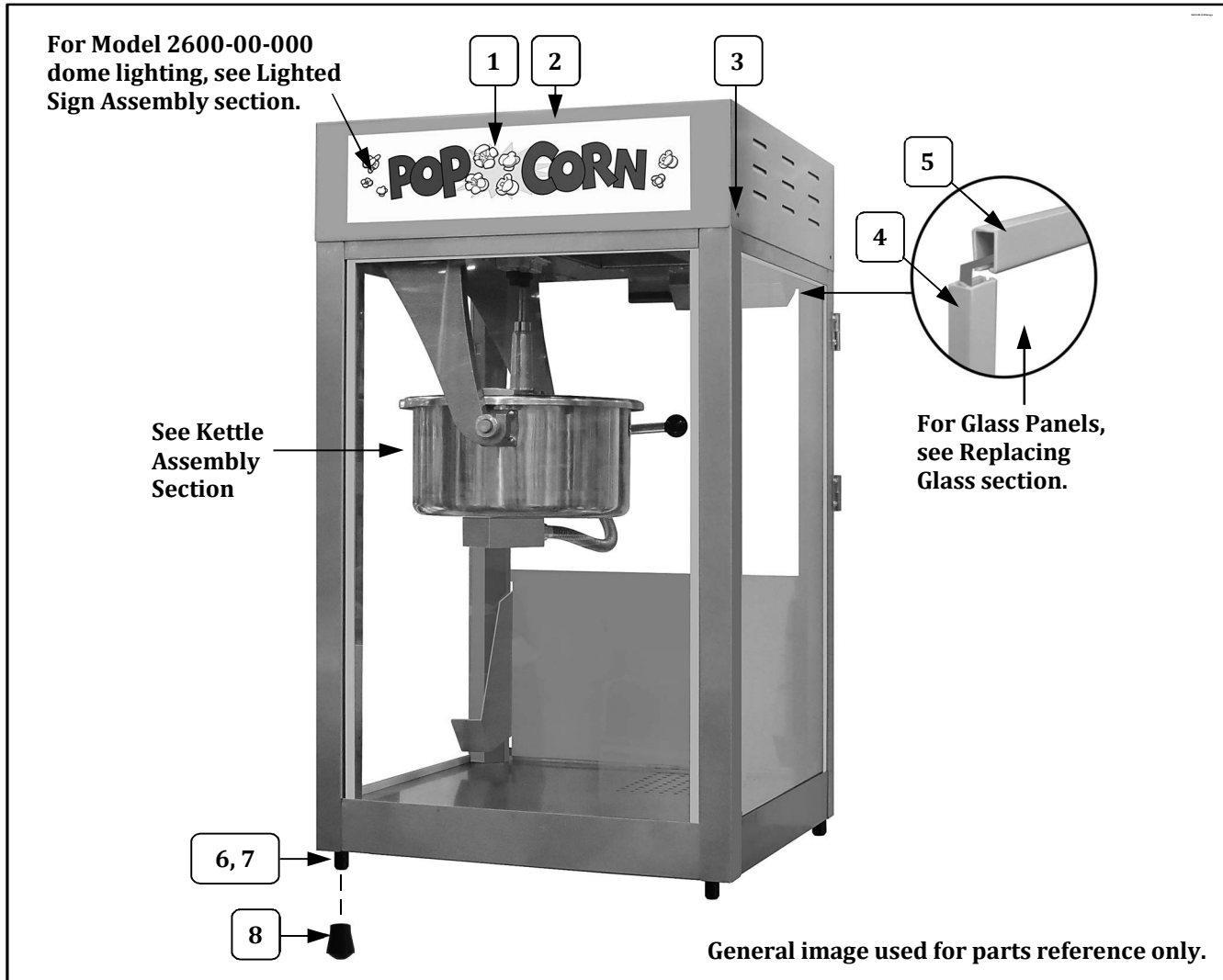

Item	Parts Description	Part Number			
		2600	2600A	2600-00-003	2600-00-000
1	POPCORN DECAL	49777	49777		
	PAPPY'S DECAL			49158KC	
2	DOME	77769	77769	77769	77780
3	8-32 X 3/8 SLT. HWH M/S	42044	42044	42044	42044
4	26 1/8" GLASS CHANNEL (used on side edges of front and side glass panels)	61036	61036	61036	61036
5	16 1/4" GLASS CHANNEL (used on top and bottom edges of front and side glass panels)	74172	74172	74172	74172
6	GLIDE	47328	47328	47328	47328
7	10-24 X 3/4 HEX HD	41314	41314	41314	41314
8	BLACK CRUTCH TIP	49123	49123	49123	49123

Cabinet Exterior – Front View

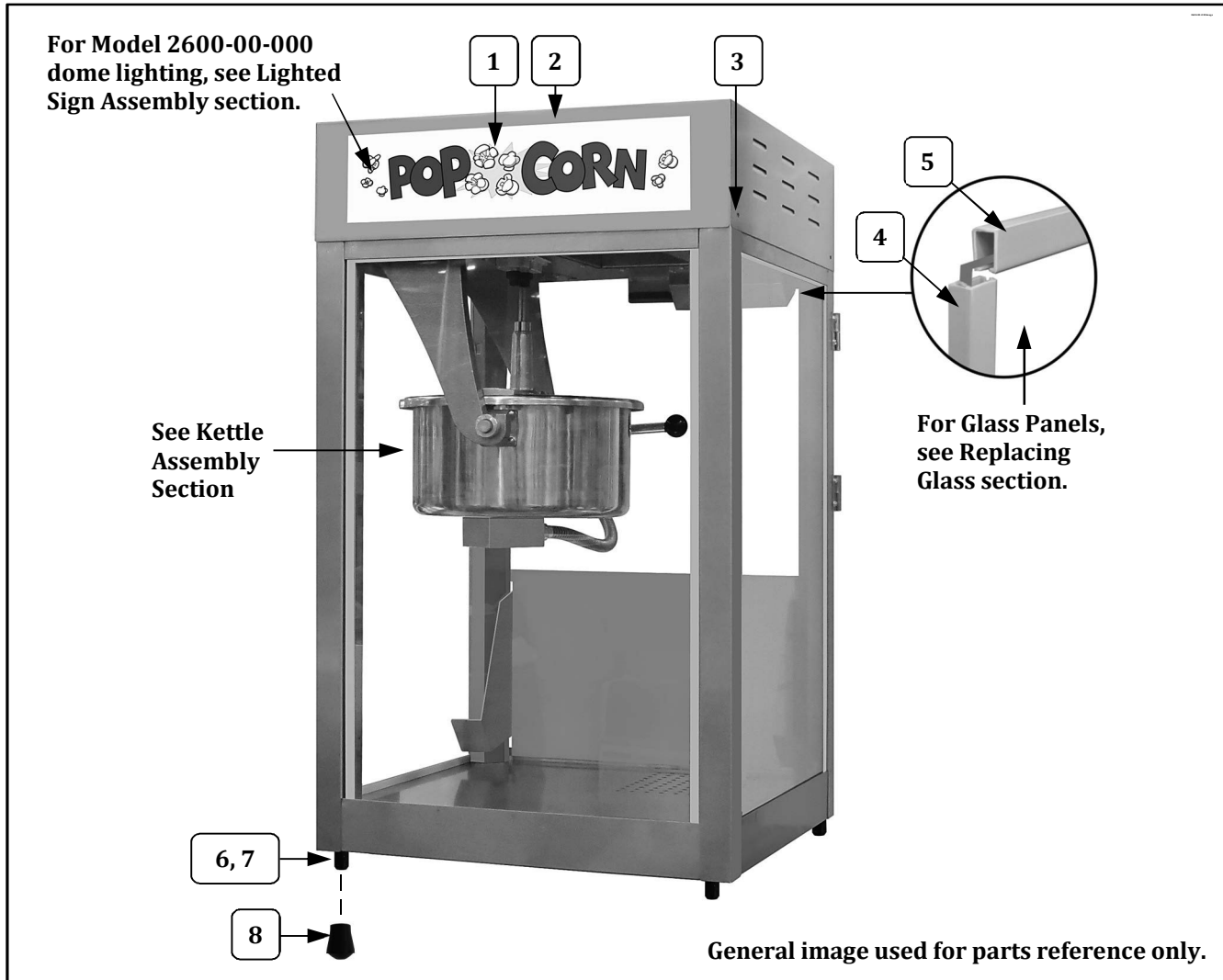

Item	Parts Description	Part Number			
		2600	2600A	2600-00-003	2600-00-000
1	POPCORN DECAL	49777	49777		
	PAPPY'S DECAL			49158KC	
2	DOMES	77769	77769	77769	77780
3	8-32 X 3/8 SLT. HWH M/S	42044	42044	42044	42044
4	26 1/8" GLASS CHANNEL (used on side edges of front and side glass panels)	61036	61036	61036	61036
5	16 1/4" GLASS CHANNEL (used on top and bottom edges of front and side glass panels)	74172	74172	74172	74172
6	GLIDE	47328	47328	47328	47328
7	10-24 X 3/4 HEX HD	41314	41314	41314	41314
8	BLACK CRUTCH TIP	49123	49123	49123	49123

Cabinet Exterior – Front View

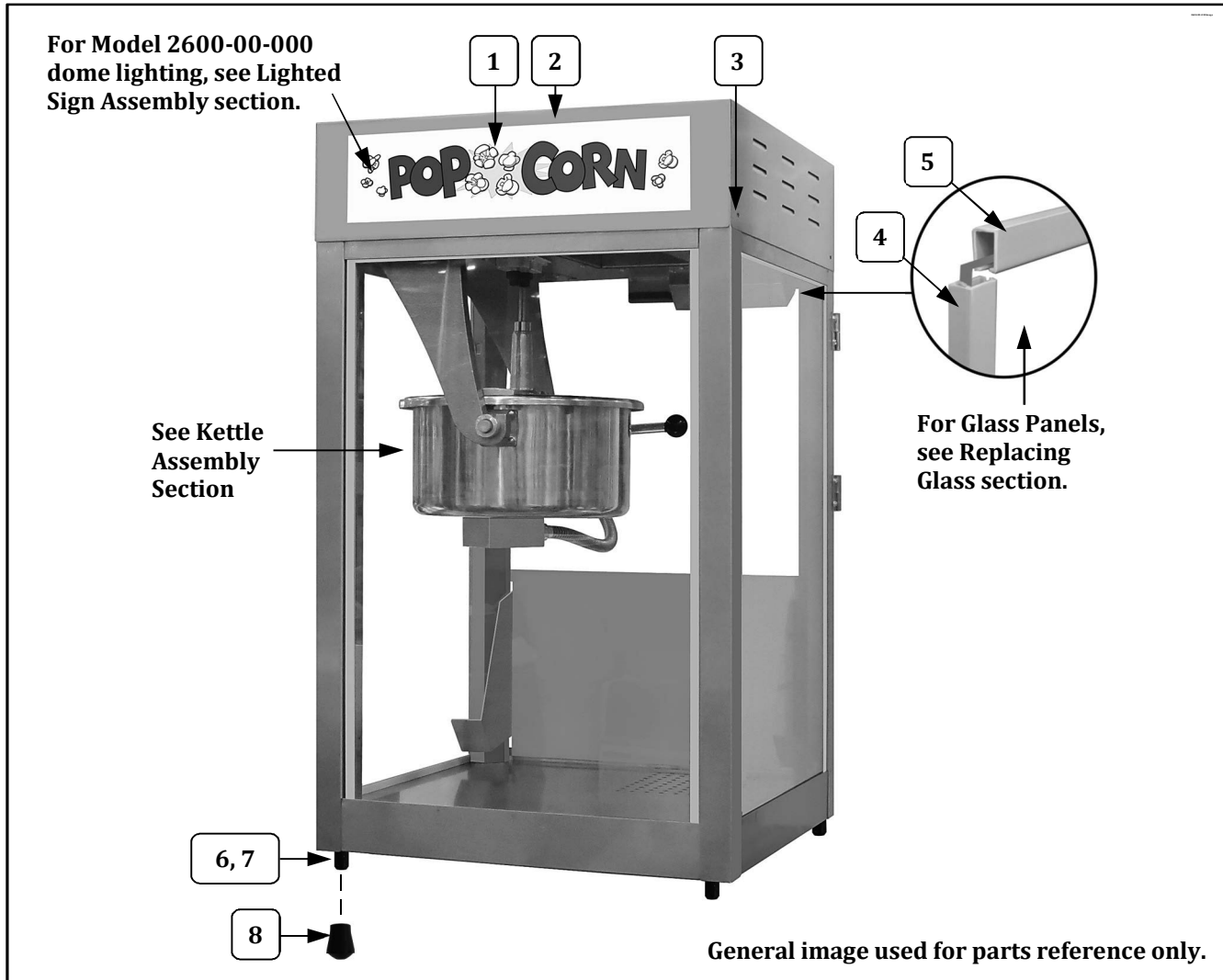

Item	Parts Description	Part Number			
		2600	2600A	2600-00-003	2600-00-000
1	POPCORN DECAL	49777	49777		
	PAPPY'S DECAL			49158KC	
2	DOMES	77769	77769	77769	77780
3	8-32 X 3/8 SLT. HWH M/S	42044	42044	42044	42044
4	26 1/8" GLASS CHANNEL (used on side edges of front and side glass panels)	61036	61036	61036	61036
5	16 1/4" GLASS CHANNEL (used on top and bottom edges of front and side glass panels)	74172	74172	74172	74172
6	GLIDE	47328	47328	47328	47328
7	10-24 X 3/4 HEX HD	41314	41314	41314	41314
8	BLACK CRUTCH TIP	49123	49123	49123	49123

Cabinet Exterior – Front View

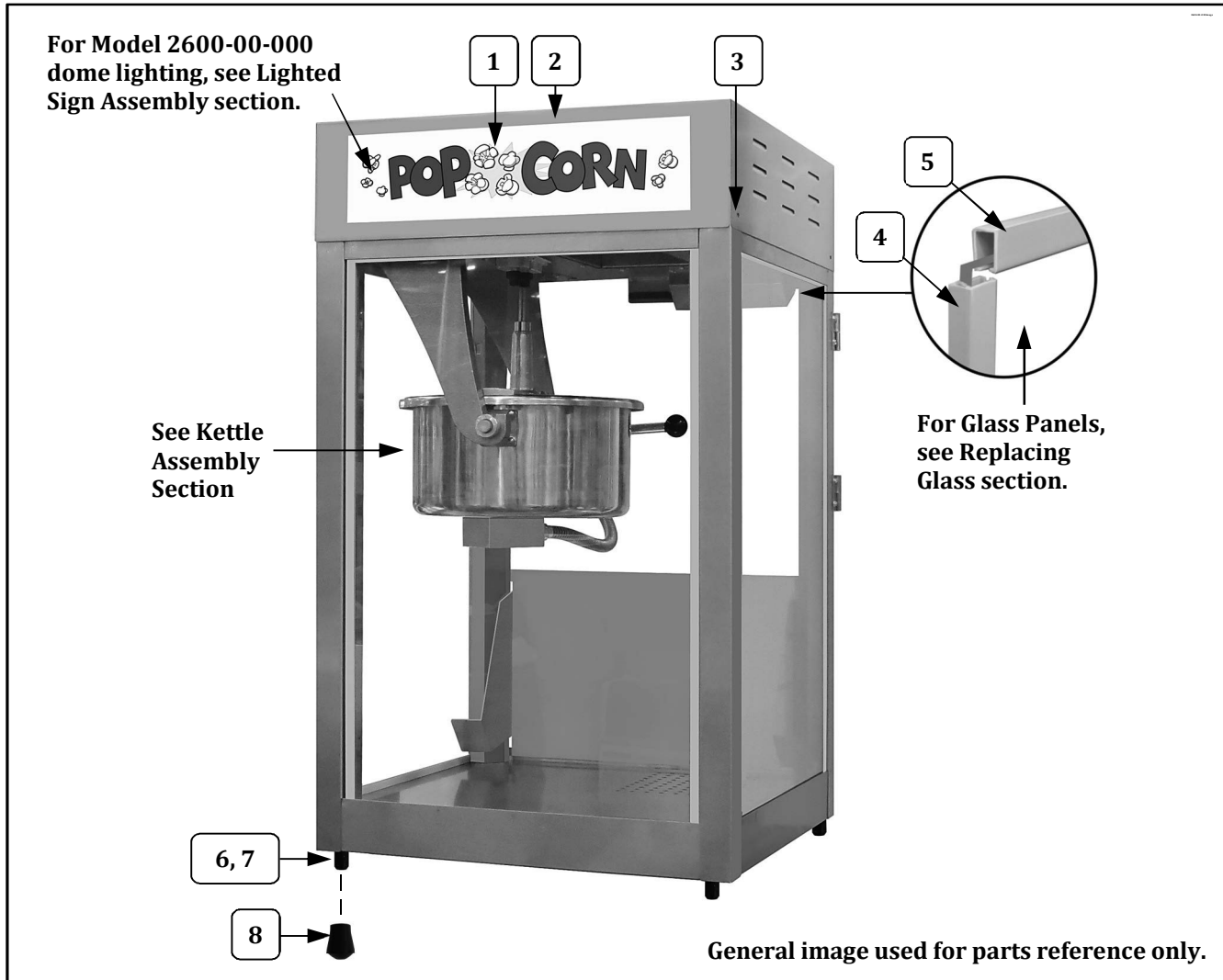

Item	Parts Description	Part Number			
		2600	2600A	2600-00-003	2600-00-000
1	POPCORN DECAL	49777	49777		
	PAPPY'S DECAL			49158KC	
2	DOMES	77769	77769	77769	77780
3	8-32 X 3/8 SLT. HWH M/S	42044	42044	42044	42044
4	26 1/8" GLASS CHANNEL (used on side edges of front and side glass panels)	61036	61036	61036	61036
5	16 1/4" GLASS CHANNEL (used on top and bottom edges of front and side glass panels)	74172	74172	74172	74172
6	GLIDE	47328	47328	47328	47328
7	10-24 X 3/4 HEX HD	41314	41314	41314	41314
8	BLACK CRUTCH TIP	49123	49123	49123	49123

Cabinet Exterior – Front View

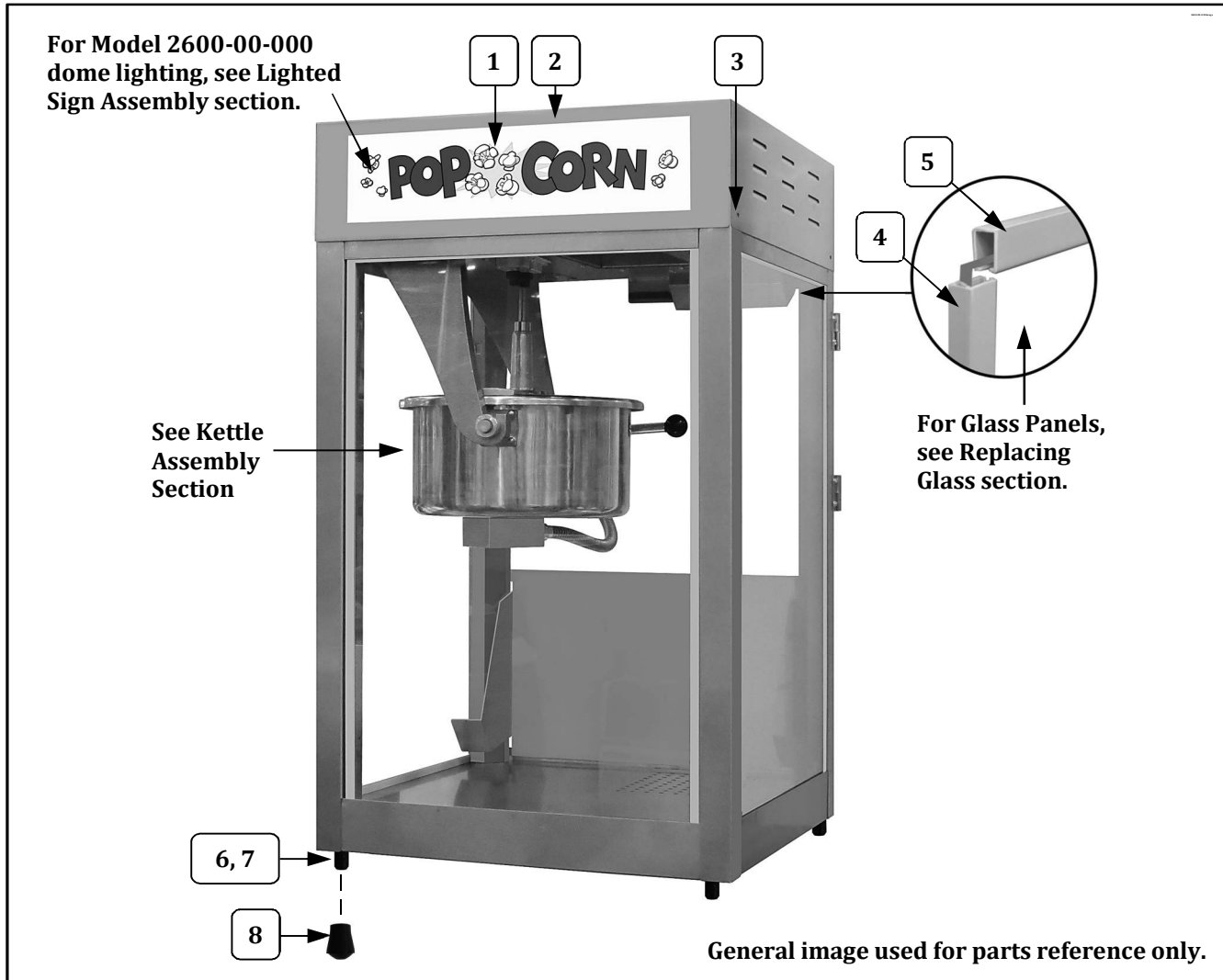

Item	Parts Description	Part Number			
		2600	2600A	2600-00-003	2600-00-000
1	POPCORN DECAL	49777	49777		
	PAPPY'S DECAL			49158KC	
2	DOMES	77769	77769	77769	77780
3	8-32 X 3/8 SLT. HWH M/S	42044	42044	42044	42044
4	26 1/8" GLASS CHANNEL (used on side edges of front and side glass panels)	61036	61036	61036	61036
5	16 1/4" GLASS CHANNEL (used on top and bottom edges of front and side glass panels)	74172	74172	74172	74172
6	GLIDE	47328	47328	47328	47328
7	10-24 X 3/4 HEX HD	41314	41314	41314	41314
8	BLACK CRUTCH TIP	49123	49123	49123	49123

Cabinet Exterior – Front View

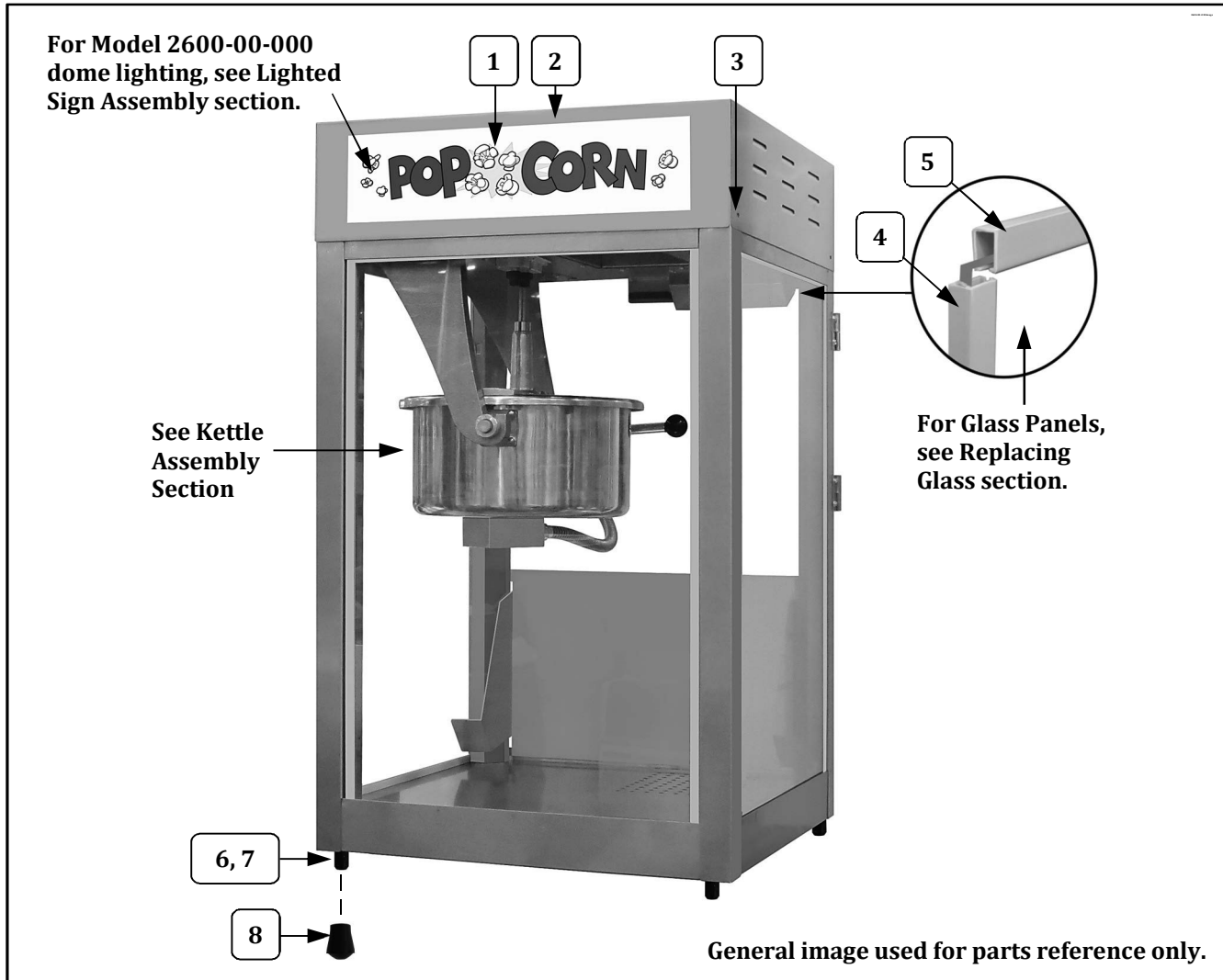

Item	Parts Description	Part Number			
		2600	2600A	2600-00-003	2600-00-000
1	POPCORN DECAL	49777	49777		
	PAPPY'S DECAL			49158KC	
2	DOMES	77769	77769	77769	77780
3	8-32 X 3/8 SLT. HWH M/S	42044	42044	42044	42044
4	26 1/8" GLASS CHANNEL (used on side edges of front and side glass panels)	61036	61036	61036	61036
5	16 1/4" GLASS CHANNEL (used on top and bottom edges of front and side glass panels)	74172	74172	74172	74172
6	GLIDE	47328	47328	47328	47328
7	10-24 X 3/4 HEX HD	41314	41314	41314	41314
8	BLACK CRUTCH TIP	49123	49123	49123	49123

Cabinet Exterior – Front View

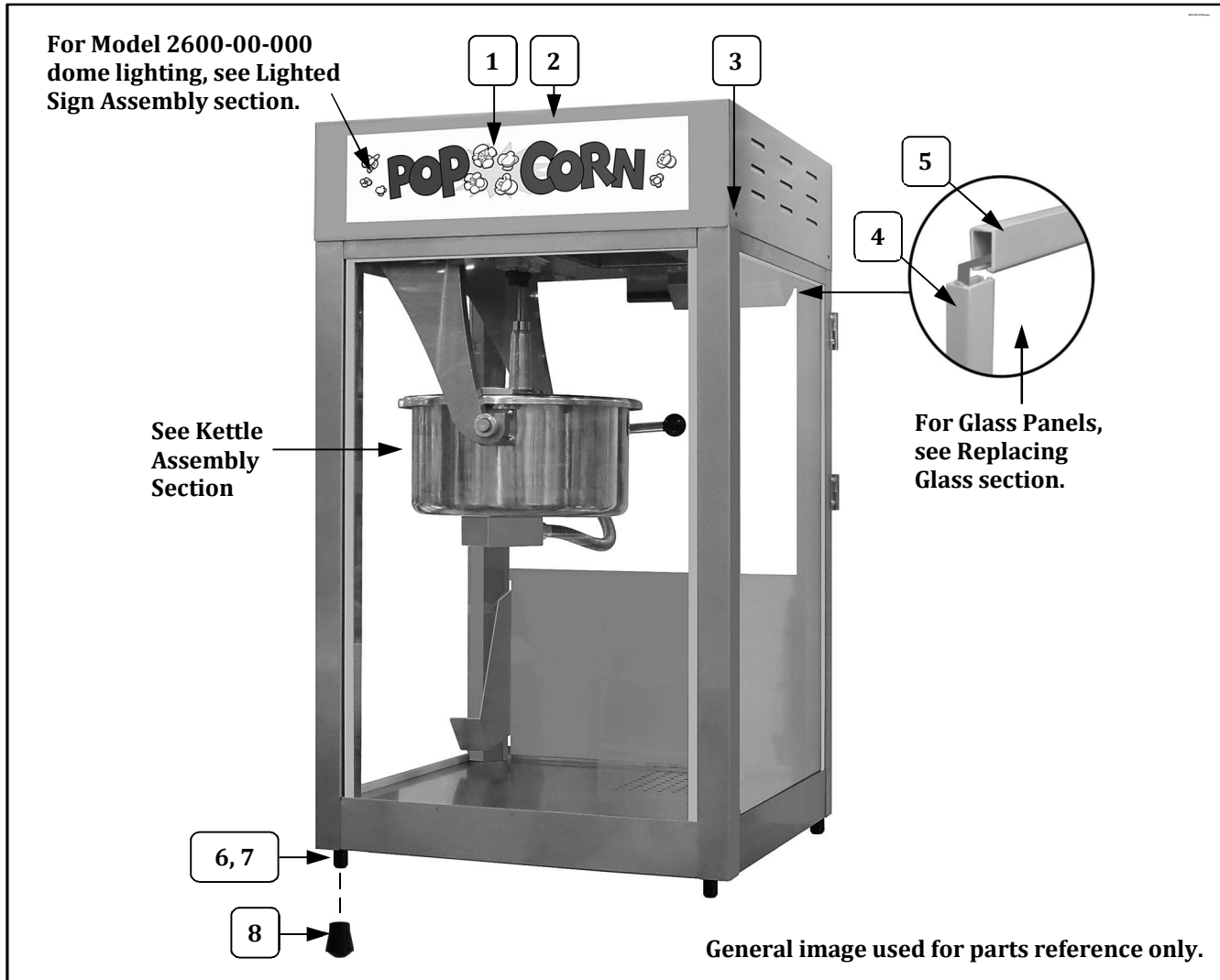

Item	Parts Description	Part Number			
		2600	2600A	2600-00-003	2600-00-000
1	POPCORN DECAL	49777	49777		
	PAPPY'S DECAL			49158KC	
2	DOMES	77769	77769	77769	77780
3	8-32 X 3/8 SLT. HWH M/S	42044	42044	42044	42044
4	26 1/8" GLASS CHANNEL (used on side edges of front and side glass panels)	61036	61036	61036	61036
5	16 1/4" GLASS CHANNEL (used on top and bottom edges of front and side glass panels)	74172	74172	74172	74172
6	GLIDE	47328	47328	47328	47328
7	10-24 X 3/4 HEX HD	41314	41314	41314	41314
8	BLACK CRUTCH TIP	49123	49123	49123	49123

Cabinet Exterior – Front View

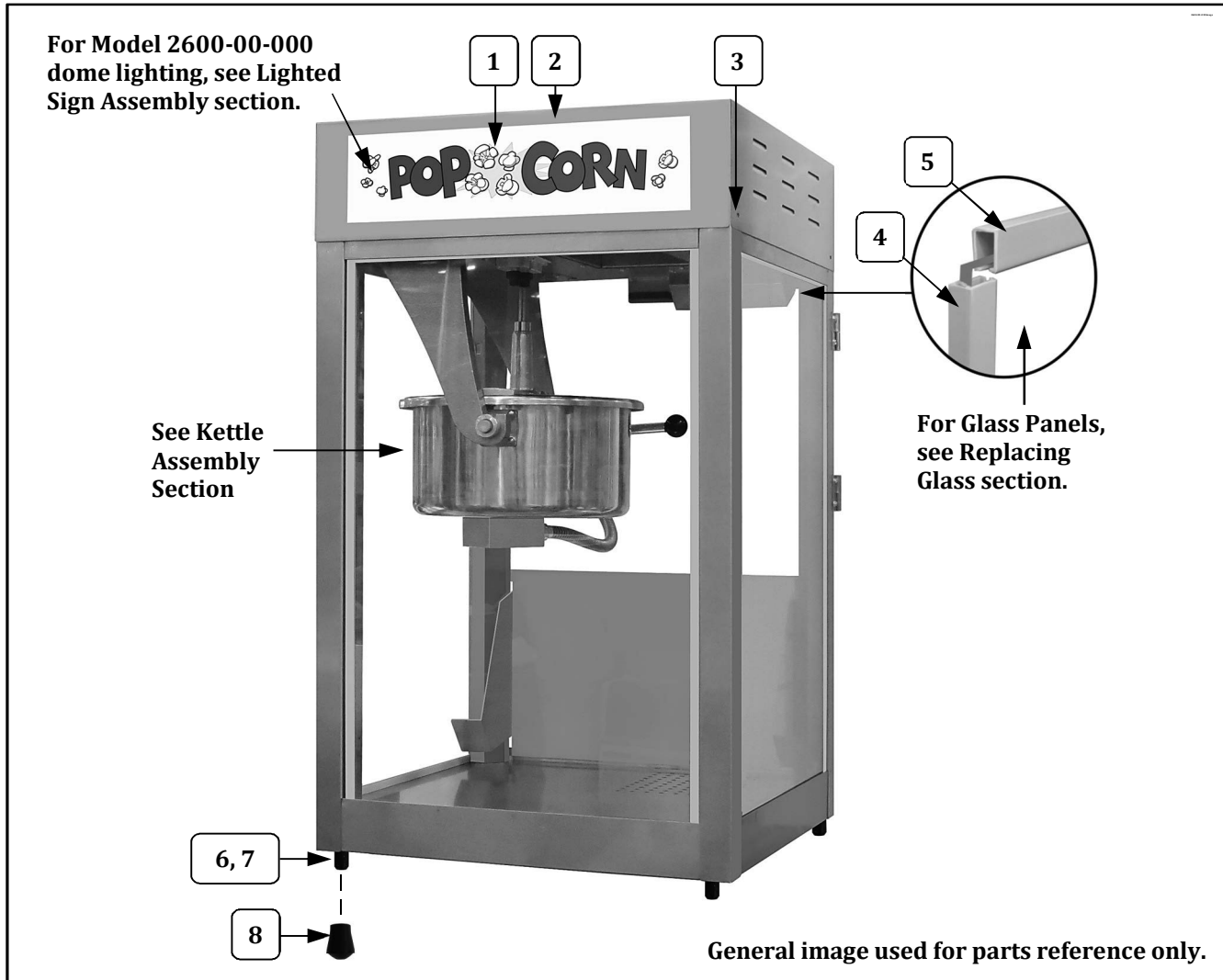

Item	Parts Description	Part Number			
		2600	2600A	2600-00-003	2600-00-000
1	POPCORN DECAL	49777	49777		
	PAPPY'S DECAL			49158KC	
2	DOMES	77769	77769	77769	77780
3	8-32 X 3/8 SLT. HWH M/S	42044	42044	42044	42044
4	26 1/8" GLASS CHANNEL (used on side edges of front and side glass panels)	61036	61036	61036	61036
5	16 1/4" GLASS CHANNEL (used on top and bottom edges of front and side glass panels)	74172	74172	74172	74172
6	GLIDE	47328	47328	47328	47328
7	10-24 X 3/4 HEX HD	41314	41314	41314	41314
8	BLACK CRUTCH TIP	49123	49123	49123	49123

Cabinet Exterior – Front View

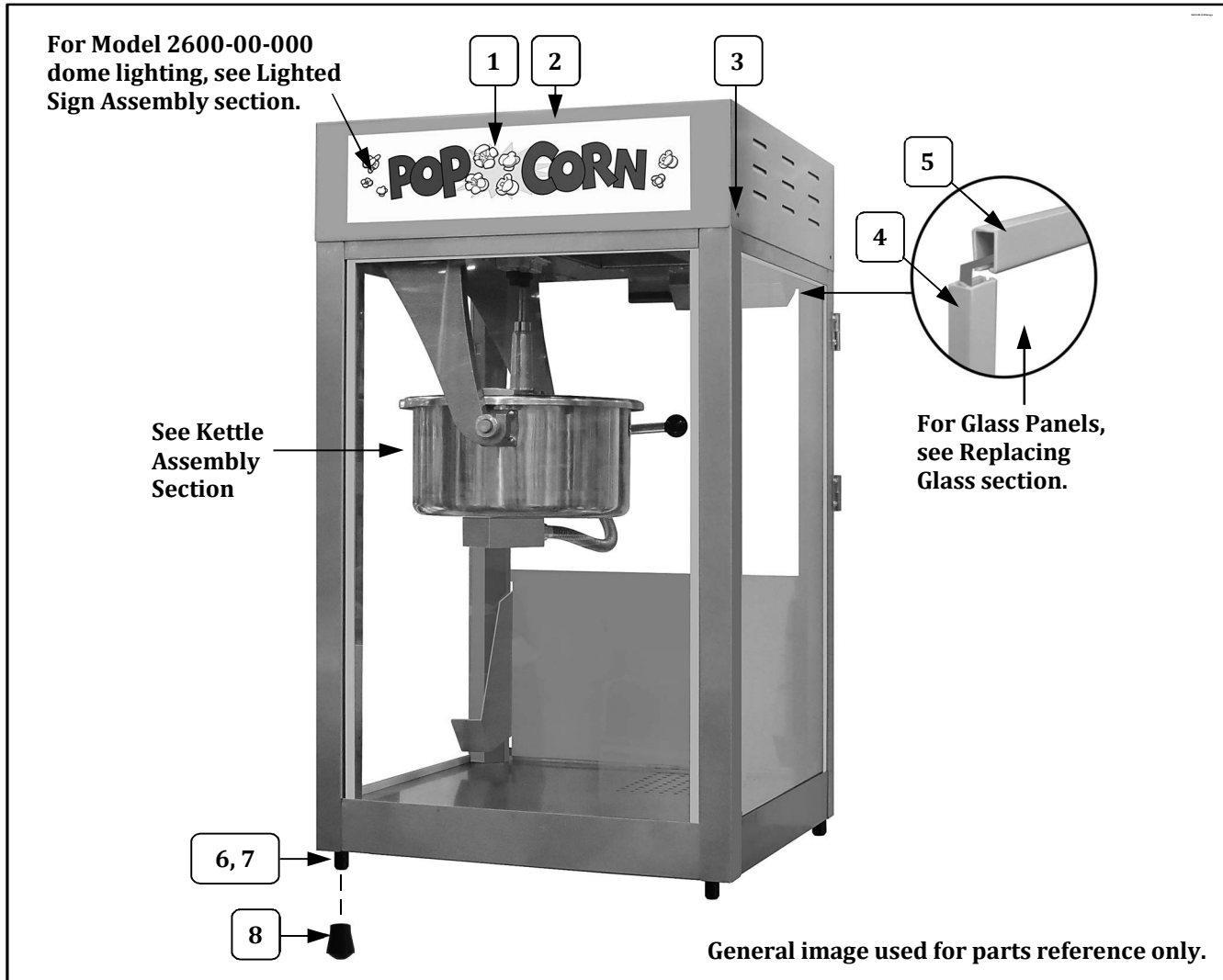

Item	Parts Description	Part Number			
		2600	2600A	2600-00-003	2600-00-000
1	POPCORN DECAL	49777	49777		
	PAPPY'S DECAL			49158KC	
2	DOMES	77769	77769	77769	77780
3	8-32 X 3/8 SLT. HWH M/S	42044	42044	42044	42044
4	26 1/8" GLASS CHANNEL (used on side edges of front and side glass panels)	61036	61036	61036	61036
5	16 1/4" GLASS CHANNEL (used on top and bottom edges of front and side glass panels)	74172	74172	74172	74172
6	GLIDE	47328	47328	47328	47328
7	10-24 X 3/4 HEX HD	41314	41314	41314	41314
8	BLACK CRUTCH TIP	49123	49123	49123	49123

Cabinet Exterior – Front View

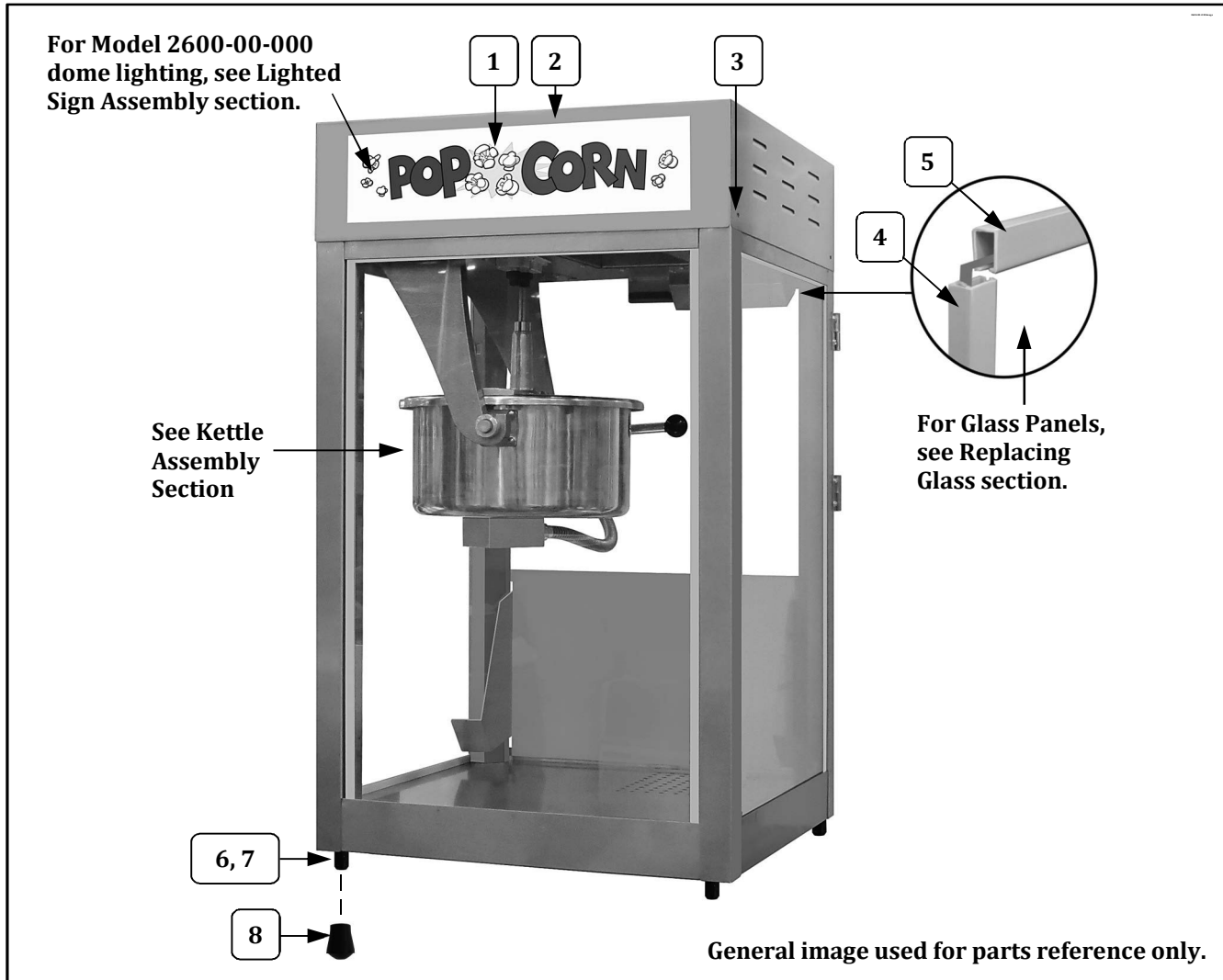

Item	Parts Description	Part Number			
		2600	2600A	2600-00-003	2600-00-000
1	POPCORN DECAL	49777	49777		
	PAPPY'S DECAL			49158KC	
2	DOMES	77769	77769	77769	77780
3	8-32 X 3/8 SLT. HWH M/S	42044	42044	42044	42044
4	26 1/8" GLASS CHANNEL (used on side edges of front and side glass panels)	61036	61036	61036	61036
5	16 1/4" GLASS CHANNEL (used on top and bottom edges of front and side glass panels)	74172	74172	74172	74172
6	GLIDE	47328	47328	47328	47328
7	10-24 X 3/4 HEX HD	41314	41314	41314	41314
8	BLACK CRUTCH TIP	49123	49123	49123	49123



Cabinet Exterior – Front View

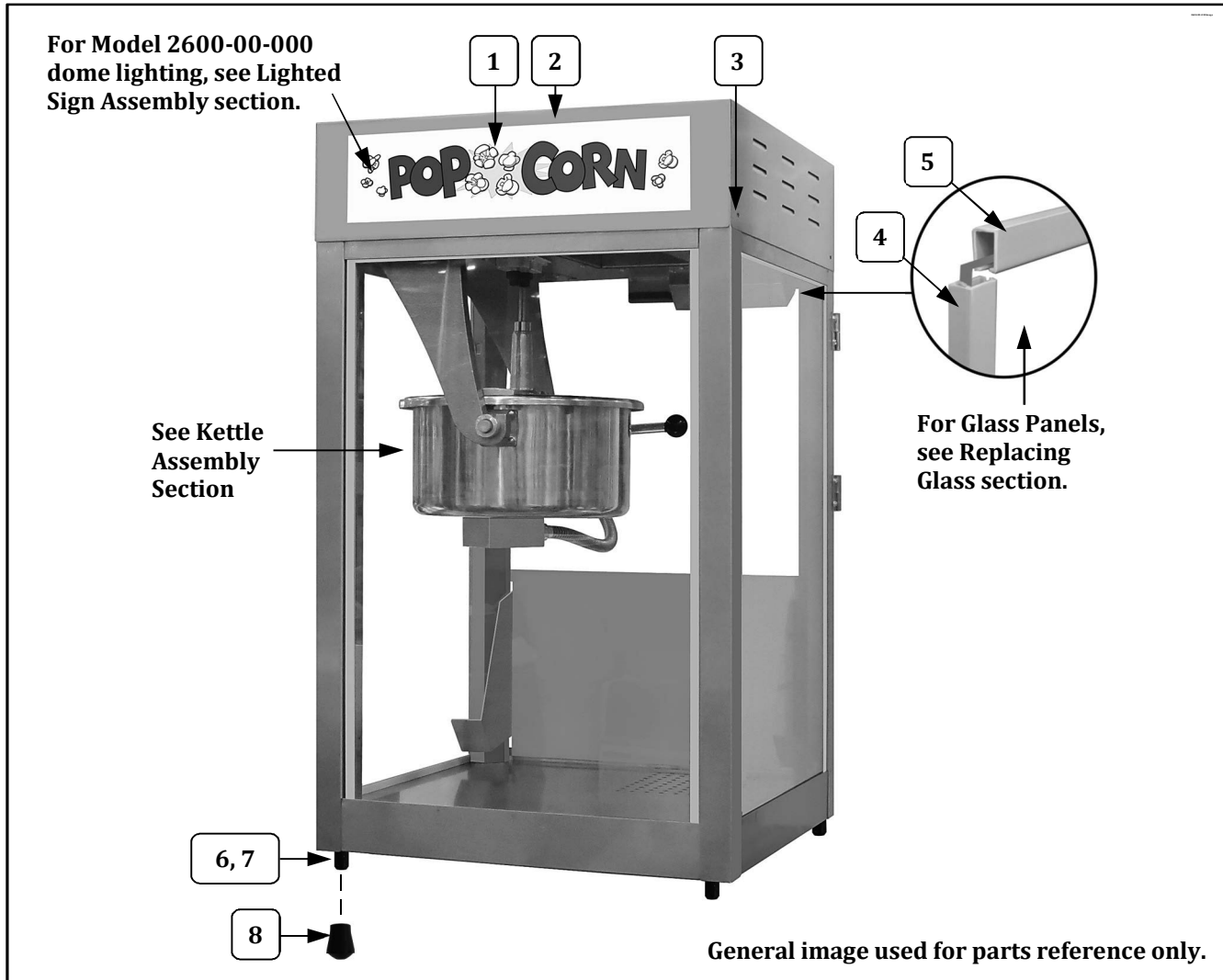

Item	Parts Description	Part Number			
		2600	2600A	2600-00-003	2600-00-000
1	POPCORN DECAL	49777	49777		
	PAPPY'S DECAL			49158KC	
2	DOMES	77769	77769	77769	77780
3	8-32 X 3/8 SLT. HWH M/S	42044	42044	42044	42044
4	26 1/8" GLASS CHANNEL (used on side edges of front and side glass panels)	61036	61036	61036	61036
5	16 1/4" GLASS CHANNEL (used on top and bottom edges of front and side glass panels)	74172	74172	74172	74172
6	GLIDE	47328	47328	47328	47328
7	10-24 X 3/4 HEX HD	41314	41314	41314	41314
8	BLACK CRUTCH TIP	49123	49123	49123	49123

Cabinet Exterior – Front View

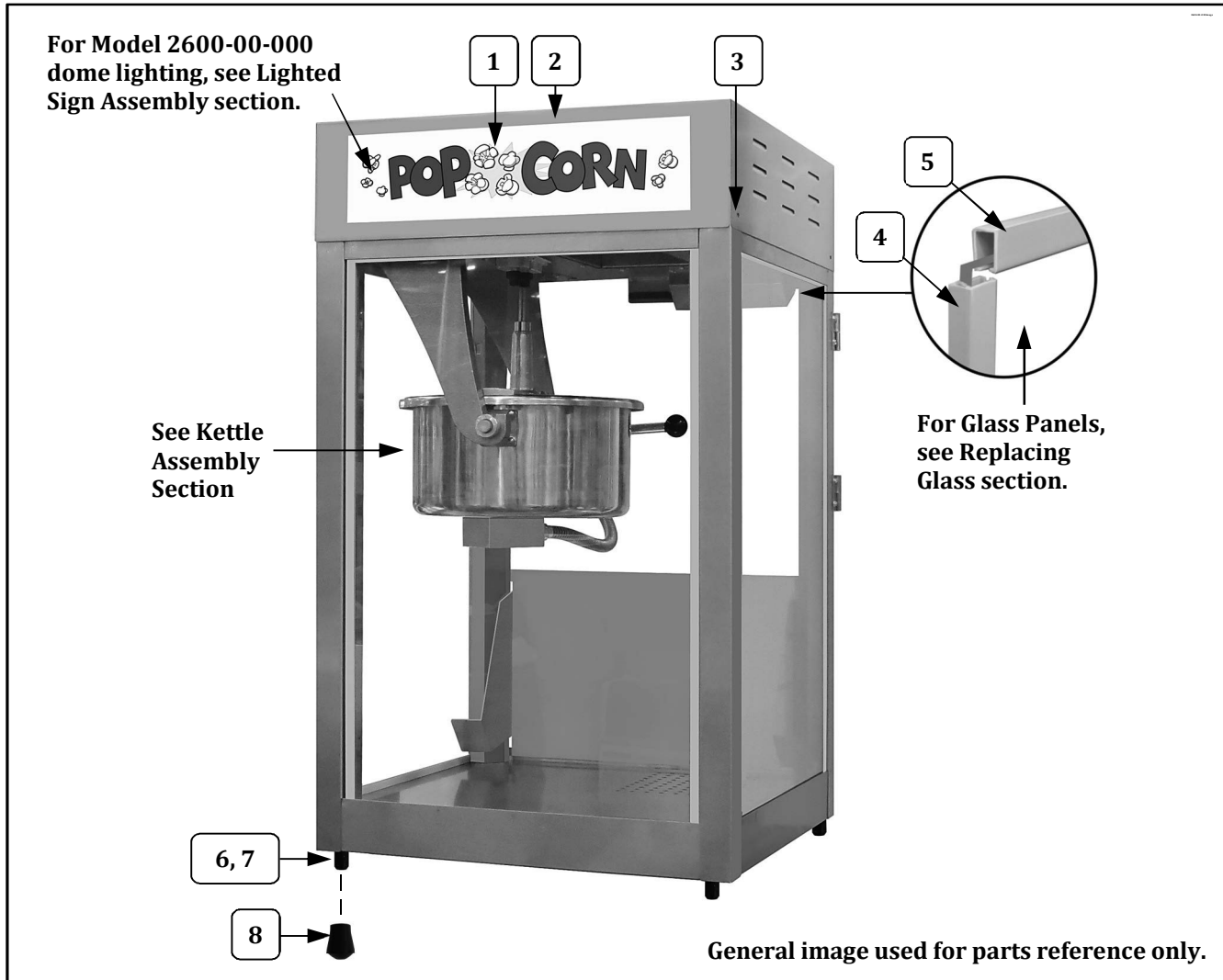

Item	Parts Description	Part Number			
		2600	2600A	2600-00-003	2600-00-000
1	POPCORN DECAL	49777	49777		
	PAPPY'S DECAL			49158KC	
2	DOMES	77769	77769	77769	77780
3	8-32 X 3/8 SLT. HWH M/S	42044	42044	42044	42044
4	26 1/8" GLASS CHANNEL (used on side edges of front and side glass panels)	61036	61036	61036	61036
5	16 1/4" GLASS CHANNEL (used on top and bottom edges of front and side glass panels)	74172	74172	74172	74172
6	GLIDE	47328	47328	47328	47328
7	10-24 X 3/4 HEX HD	41314	41314	41314	41314
8	BLACK CRUTCH TIP	49123	49123	49123	49123

Cabinet Exterior – Front View

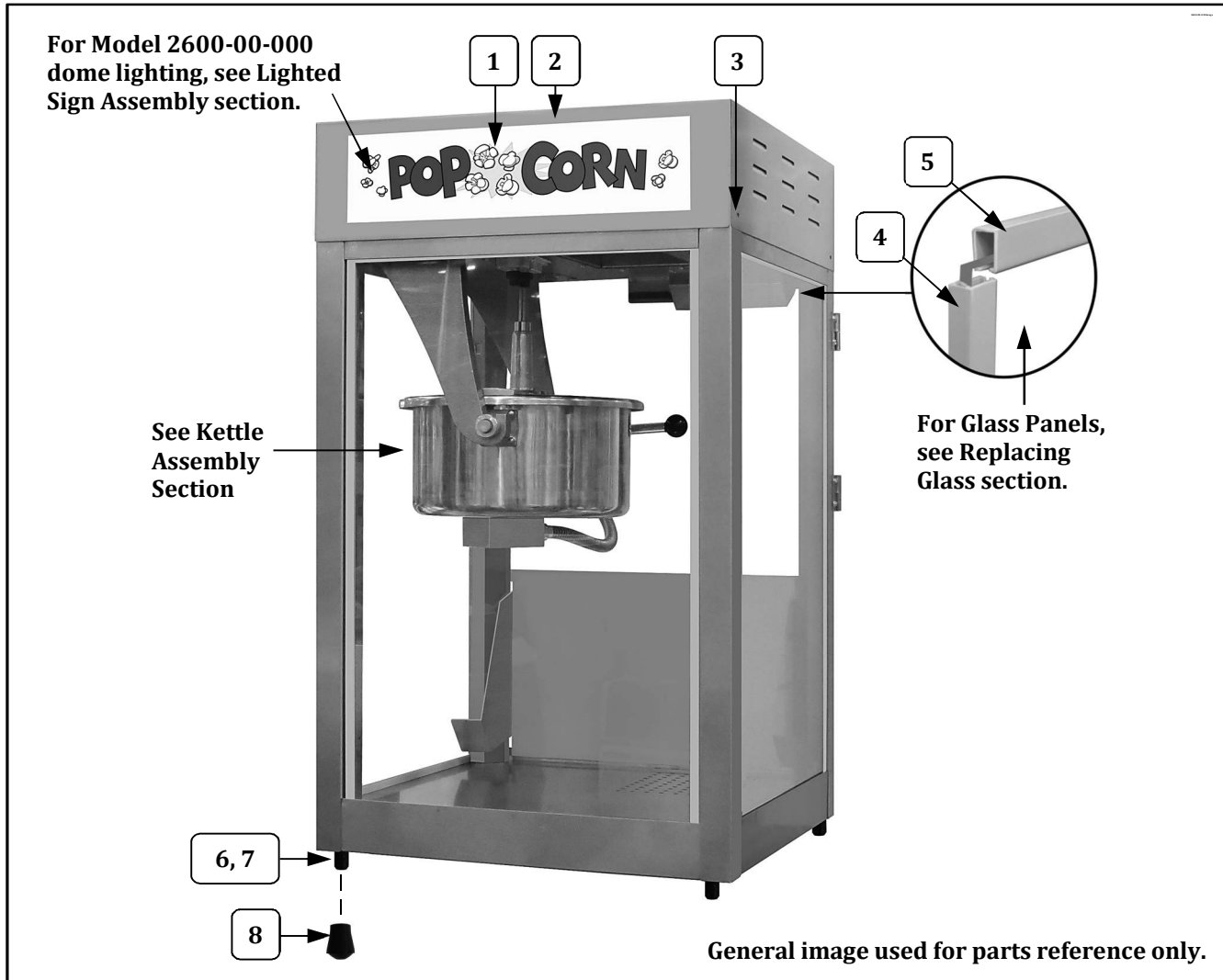

Item	Parts Description	Part Number			
		2600	2600A	2600-00-003	2600-00-000
1	POPCORN DECAL	49777	49777		
	PAPPY'S DECAL			49158KC	
2	DOMES	77769	77769	77769	77780
3	8-32 X 3/8 SLT. HWH M/S	42044	42044	42044	42044
4	26 1/8" GLASS CHANNEL (used on side edges of front and side glass panels)	61036	61036	61036	61036
5	16 1/4" GLASS CHANNEL (used on top and bottom edges of front and side glass panels)	74172	74172	74172	74172
6	GLIDE	47328	47328	47328	47328
7	10-24 X 3/4 HEX HD	41314	41314	41314	41314
8	BLACK CRUTCH TIP	49123	49123	49123	49123

Cabinet Exterior – Front View

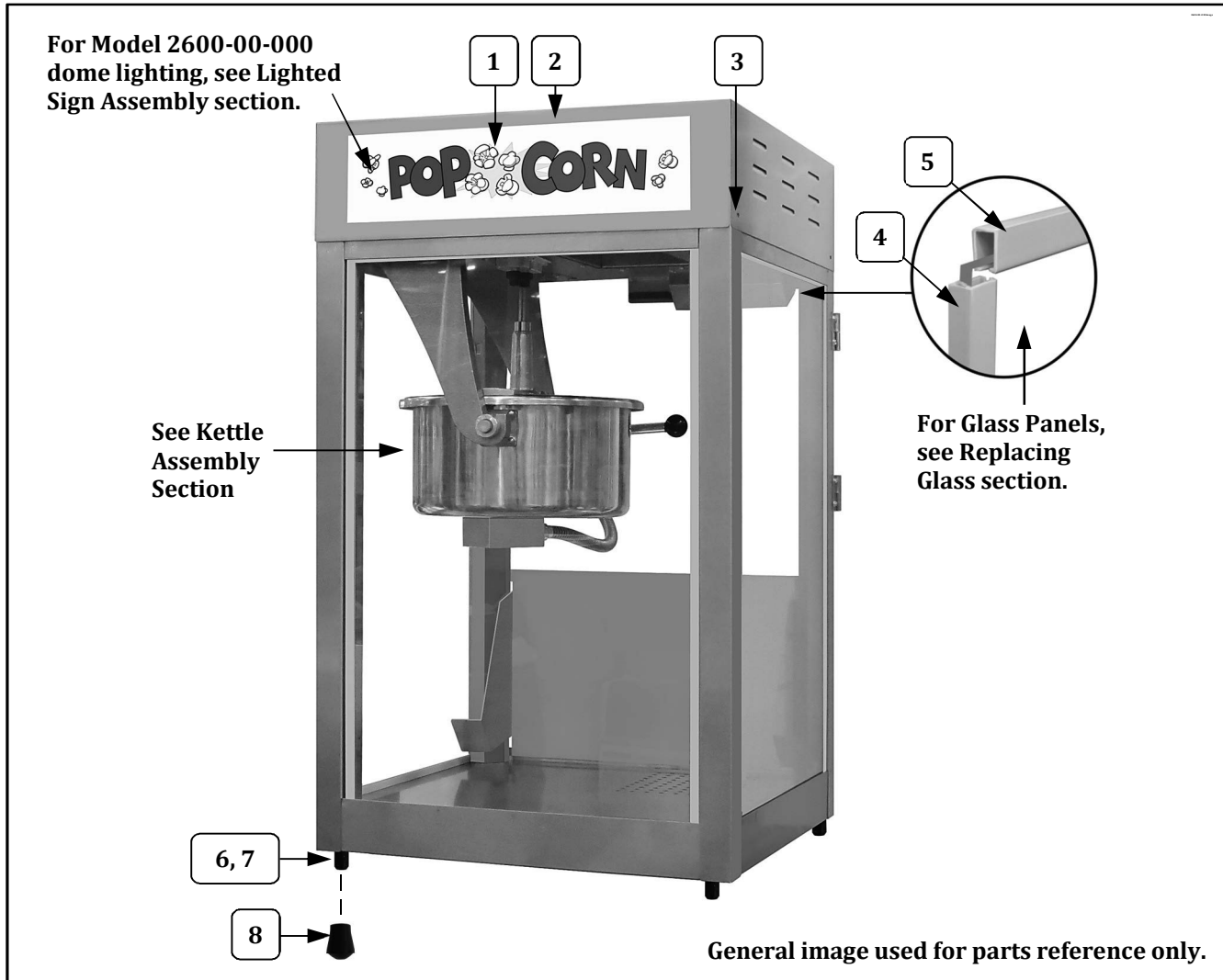

Item	Parts Description	Part Number			
		2600	2600A	2600-00-003	2600-00-000
1	POPCORN DECAL	49777	49777		
	PAPPY'S DECAL			49158KC	
2	DOMES	77769	77769	77769	77780
3	8-32 X 3/8 SLT. HWH M/S	42044	42044	42044	42044
4	26 1/8" GLASS CHANNEL (used on side edges of front and side glass panels)	61036	61036	61036	61036
5	16 1/4" GLASS CHANNEL (used on top and bottom edges of front and side glass panels)	74172	74172	74172	74172
6	GLIDE	47328	47328	47328	47328
7	10-24 X 3/4 HEX HD	41314	41314	41314	41314
8	BLACK CRUTCH TIP	49123	49123	49123	49123

Cabinet Exterior – Rear View

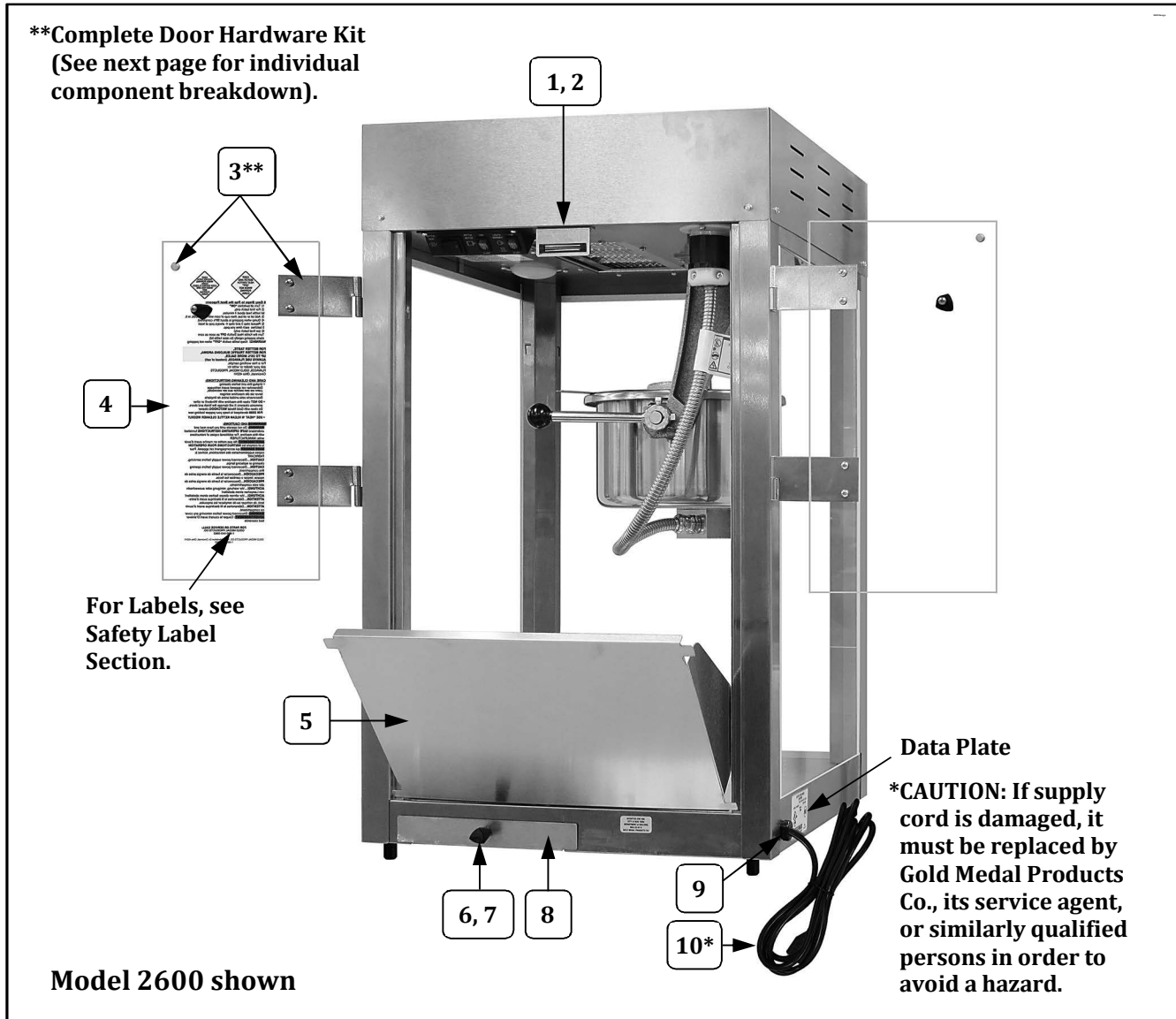

Item	Part Description	Part Number
		All Models
1	MAGNETIC CATCH	47561
2	MAGNETIC CATCH BRACKET	41340
3**	COMPLETE DOOR HARDWARE KIT	61380
4	DOOR	77774
5	DROP PANEL	17319
6	KNOB LID LIFT	47120
7	8-32" X 3/8" PH PAN W/SEMS	42227
8	OLD MAID PAN	49100
9	SR-7W-2 STRAIN RELIEF	67060
10*	15 AMP PLUG LEAD-IN CORD	87085

Cabinet Exterior – Rear View

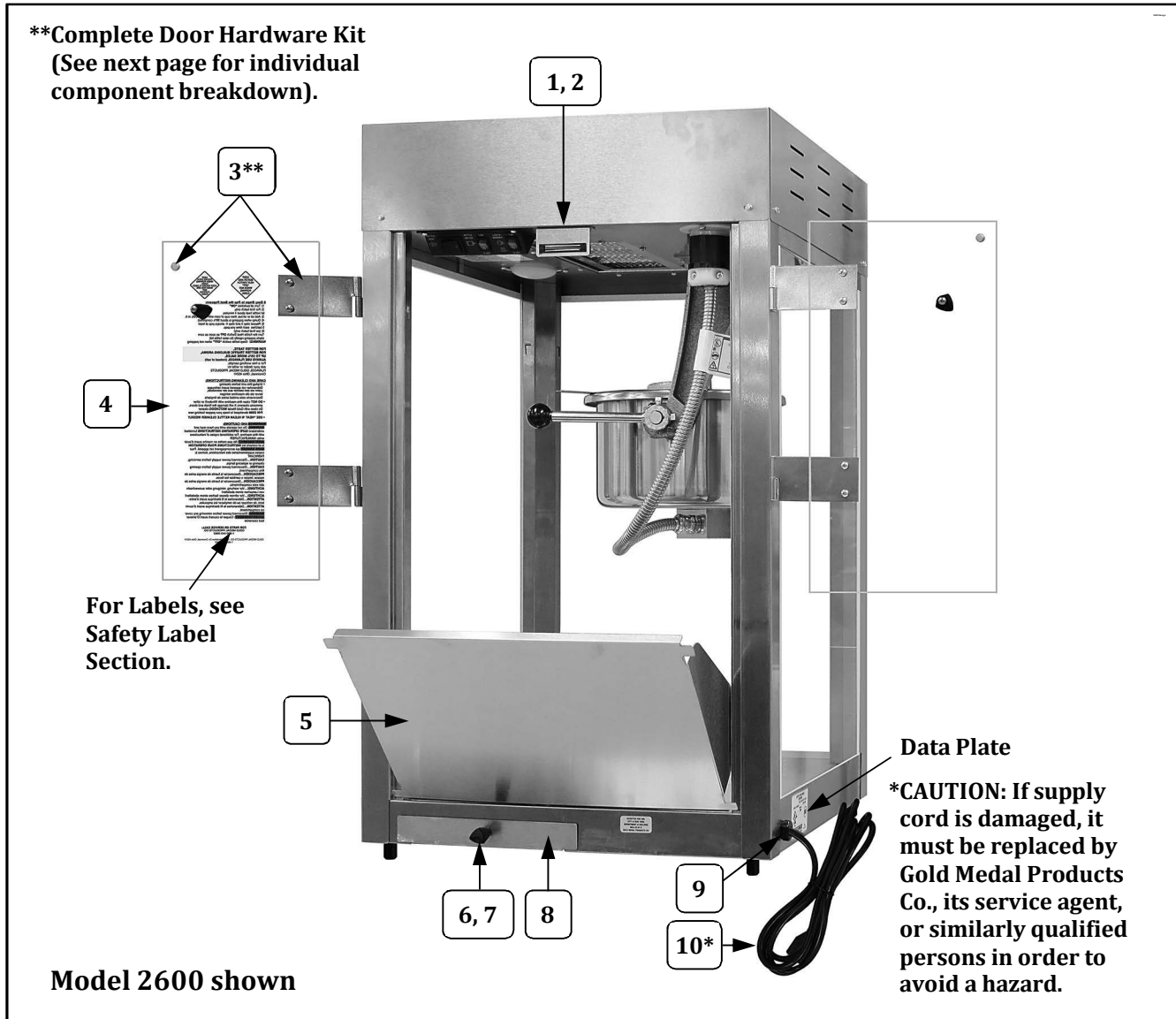

Item	Part Description	Part Number
		All Models
1	MAGNETIC CATCH	47561
2	MAGNETIC CATCH BRACKET	41340
3**	COMPLETE DOOR HARDWARE KIT	61380
4	DOOR	77774
5	DROP PANEL	17319
6	KNOB LID LIFT	47120
7	8-32" X 3/8" PH PAN W/SEMS	42227
8	OLD MAID PAN	49100
9	SR-7W-2 STRAIN RELIEF	67060
10*	15 AMP PLUG LEAD-IN CORD	87085

Cabinet Exterior – Rear View

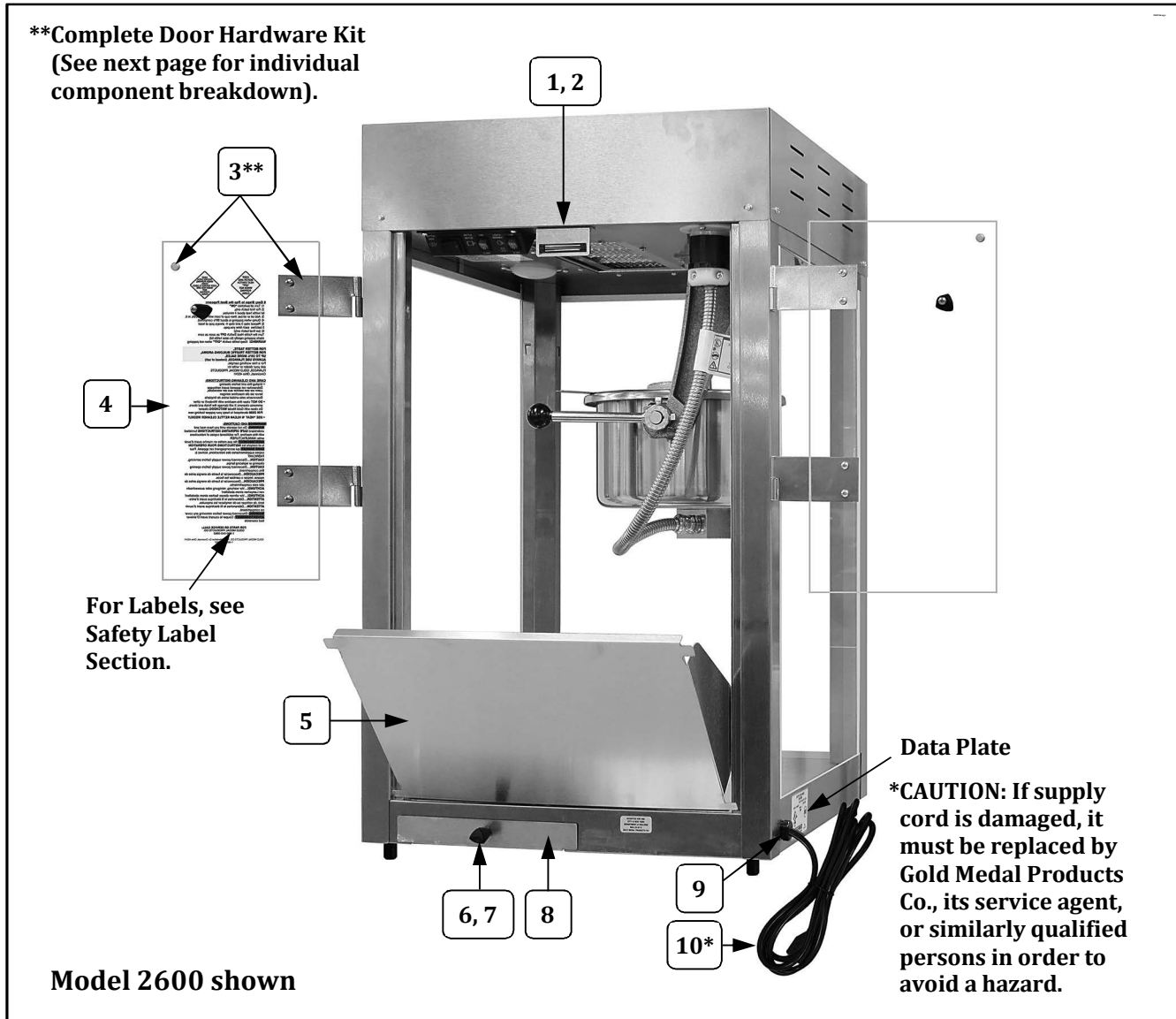

Item	Part Description	Part Number
		All Models
1	MAGNETIC CATCH	47561
2	MAGNETIC CATCH BRACKET	41340
3**	COMPLETE DOOR HARDWARE KIT	61380
4	DOOR	77774
5	DROP PANEL	17319
6	KNOB LID LIFT	47120
7	8-32" X 3/8" PH PAN W/SEMS	42227
8	OLD MAID PAN	49100
9	SR-7W-2 STRAIN RELIEF	67060
10*	15 AMP PLUG LEAD-IN CORD	87085

Cabinet Exterior – Rear View

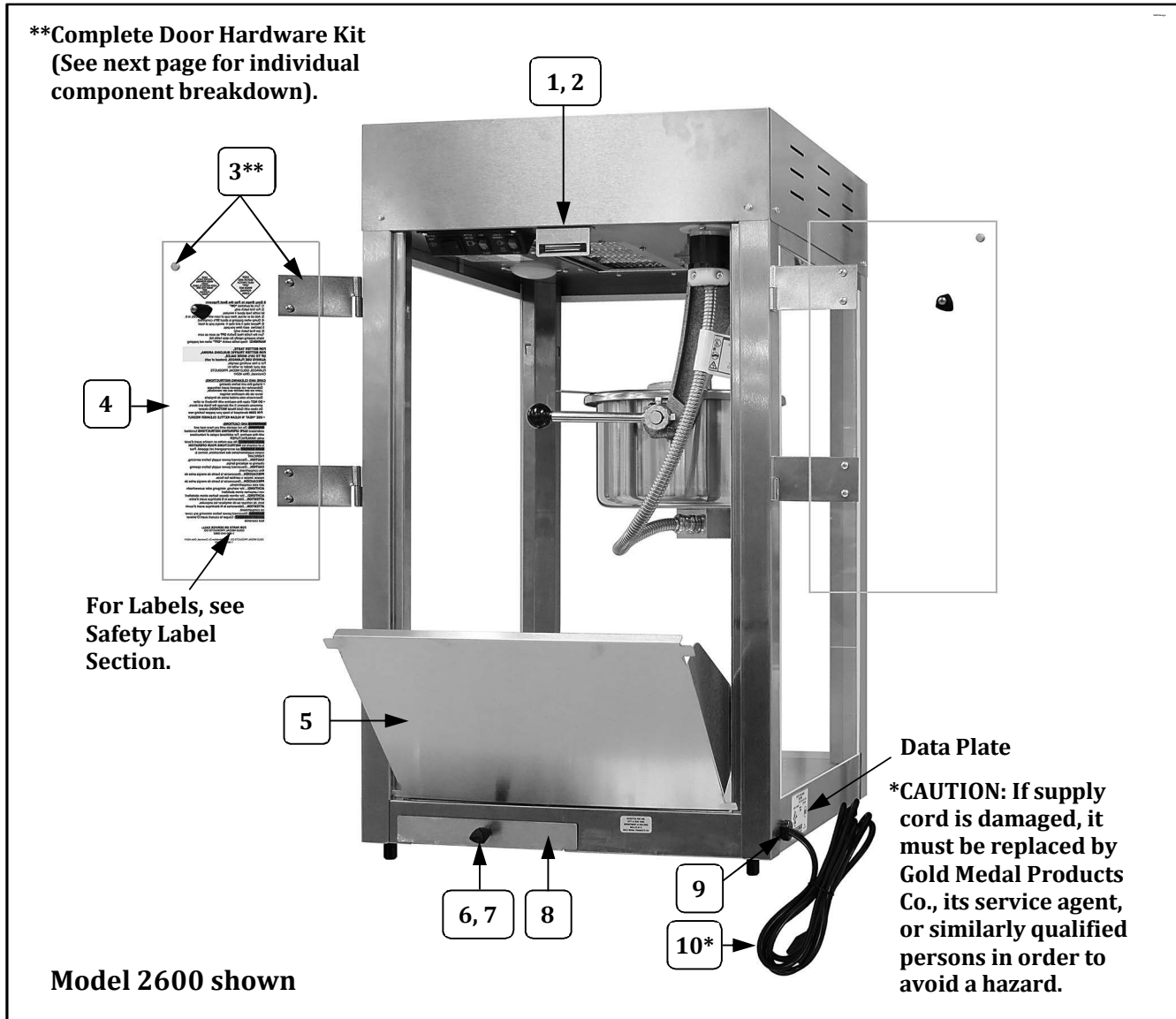

Item	Part Description	Part Number
		All Models
1	MAGNETIC CATCH	47561
2	MAGNETIC CATCH BRACKET	41340
3**	COMPLETE DOOR HARDWARE KIT	61380
4	DOOR	77774
5	DROP PANEL	17319
6	KNOB LID LIFT	47120
7	8-32" X 3/8" PH PAN W/SEMS	42227
8	OLD MAID PAN	49100
9	SR-7W-2 STRAIN RELIEF	67060
10*	15 AMP PLUG LEAD-IN CORD	87085

Cabinet Exterior – Rear View

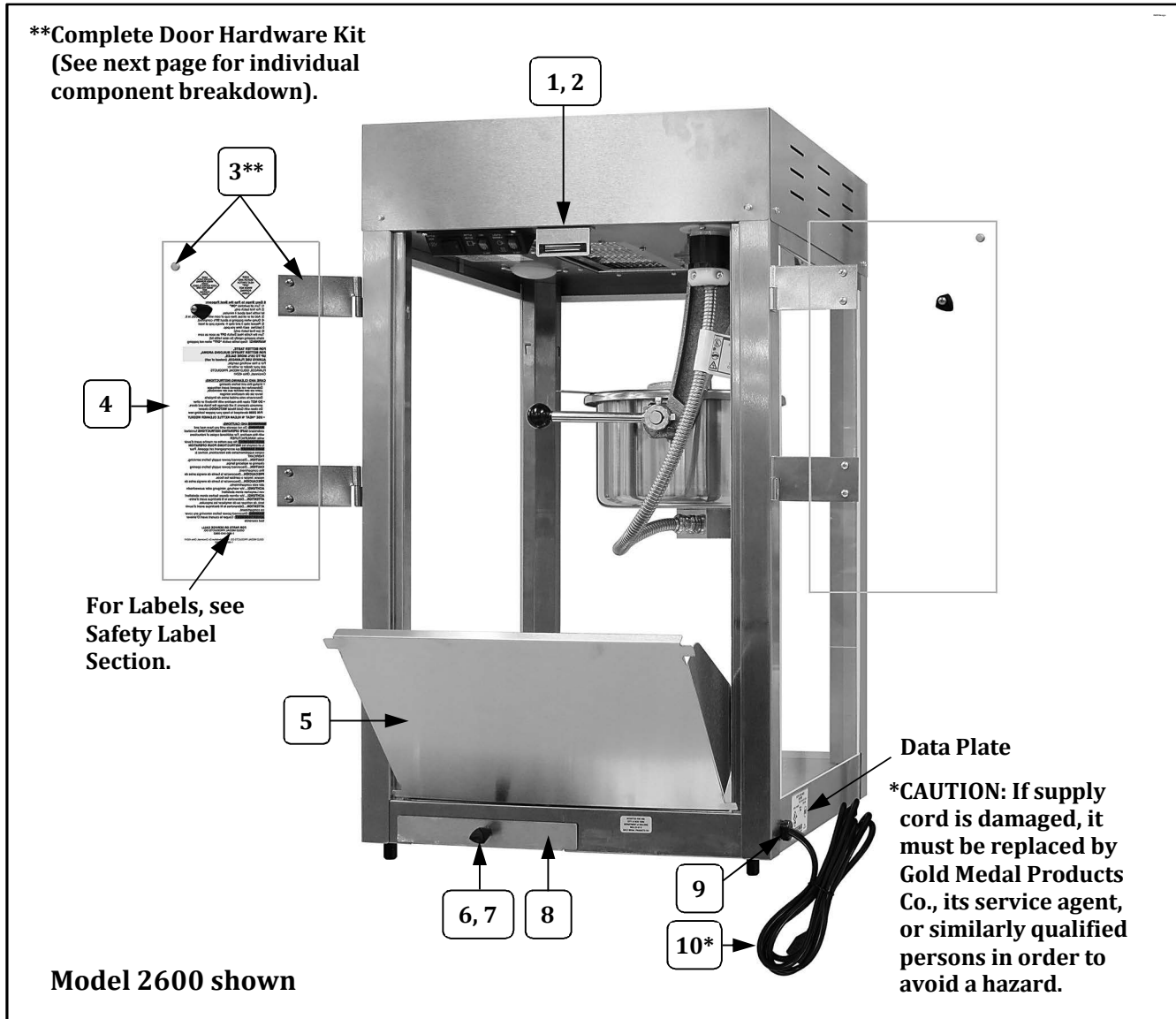

Item	Part Description	Part Number
		All Models
1	MAGNETIC CATCH	47561
2	MAGNETIC CATCH BRACKET	41340
3**	COMPLETE DOOR HARDWARE KIT	61380
4	DOOR	77774
5	DROP PANEL	17319
6	KNOB LID LIFT	47120
7	8-32" X 3/8" PH PAN W/SEMS	42227
8	OLD MAID PAN	49100
9	SR-7W-2 STRAIN RELIEF	67060
10*	15 AMP PLUG LEAD-IN CORD	87085

Cabinet Exterior – Rear View

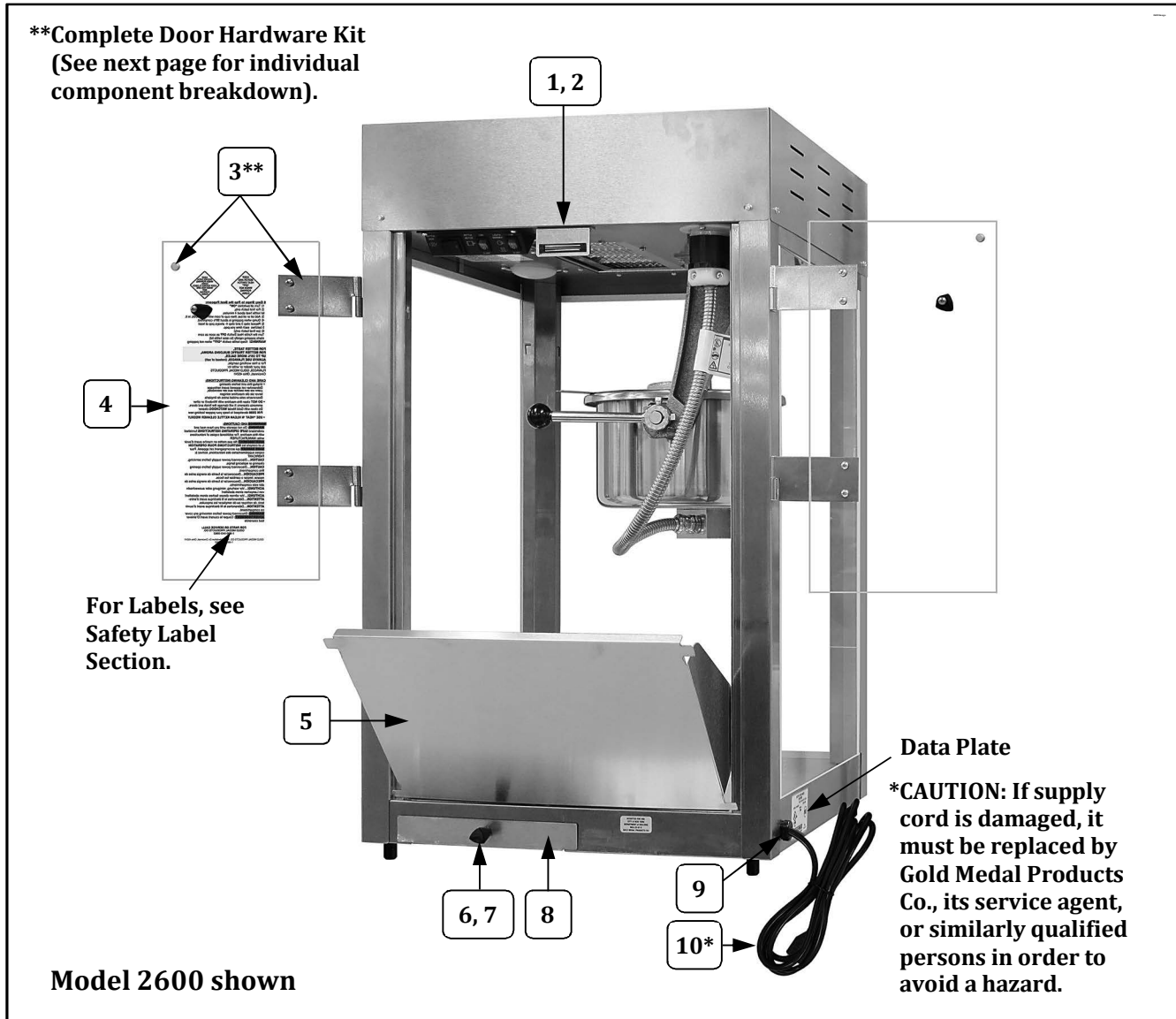

Item	Part Description	Part Number
		All Models
1	MAGNETIC CATCH	47561
2	MAGNETIC CATCH BRACKET	41340
3**	COMPLETE DOOR HARDWARE KIT	61380
4	DOOR	77774
5	DROP PANEL	17319
6	KNOB LID LIFT	47120
7	8-32" X 3/8" PH PAN W/SEMS	42227
8	OLD MAID PAN	49100
9	SR-7W-2 STRAIN RELIEF	67060
10*	15 AMP PLUG LEAD-IN CORD	87085

Cabinet Exterior – Rear View

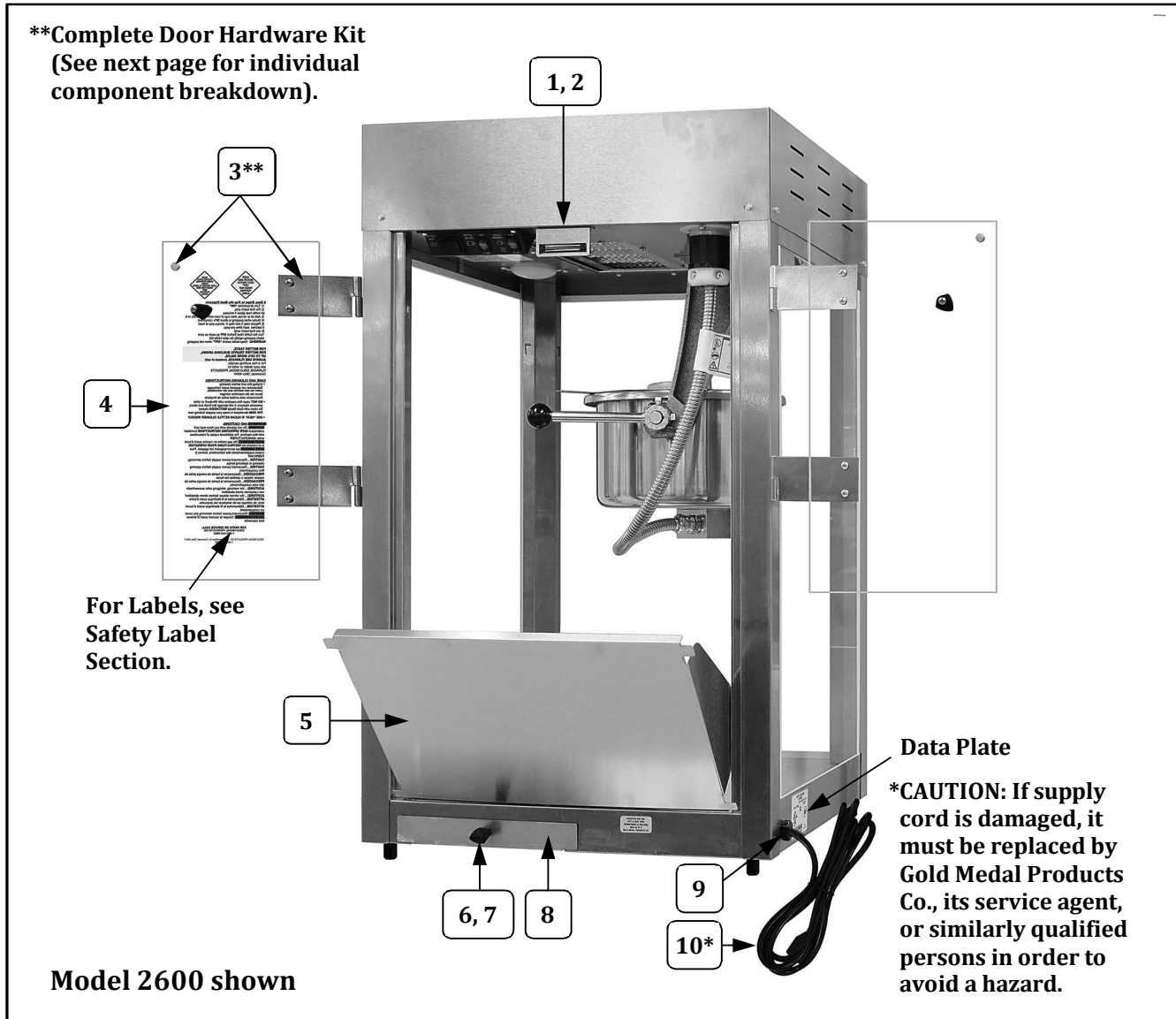

Item	Part Description	Part Number
		All Models
1	MAGNETIC CATCH	47561
2	MAGNETIC CATCH BRACKET	41340
3**	COMPLETE DOOR HARDWARE KIT	61380
4	DOOR	77774
5	DROP PANEL	17319
6	KNOB LID LIFT	47120
7	8-32" X 3/8" PH PAN W/SEMS	42227
8	OLD MAID PAN	49100
9	SR-7W-2 STRAIN RELIEF	67060
10*	15 AMP PLUG LEAD-IN CORD	87085

Cabinet Exterior – Rear View

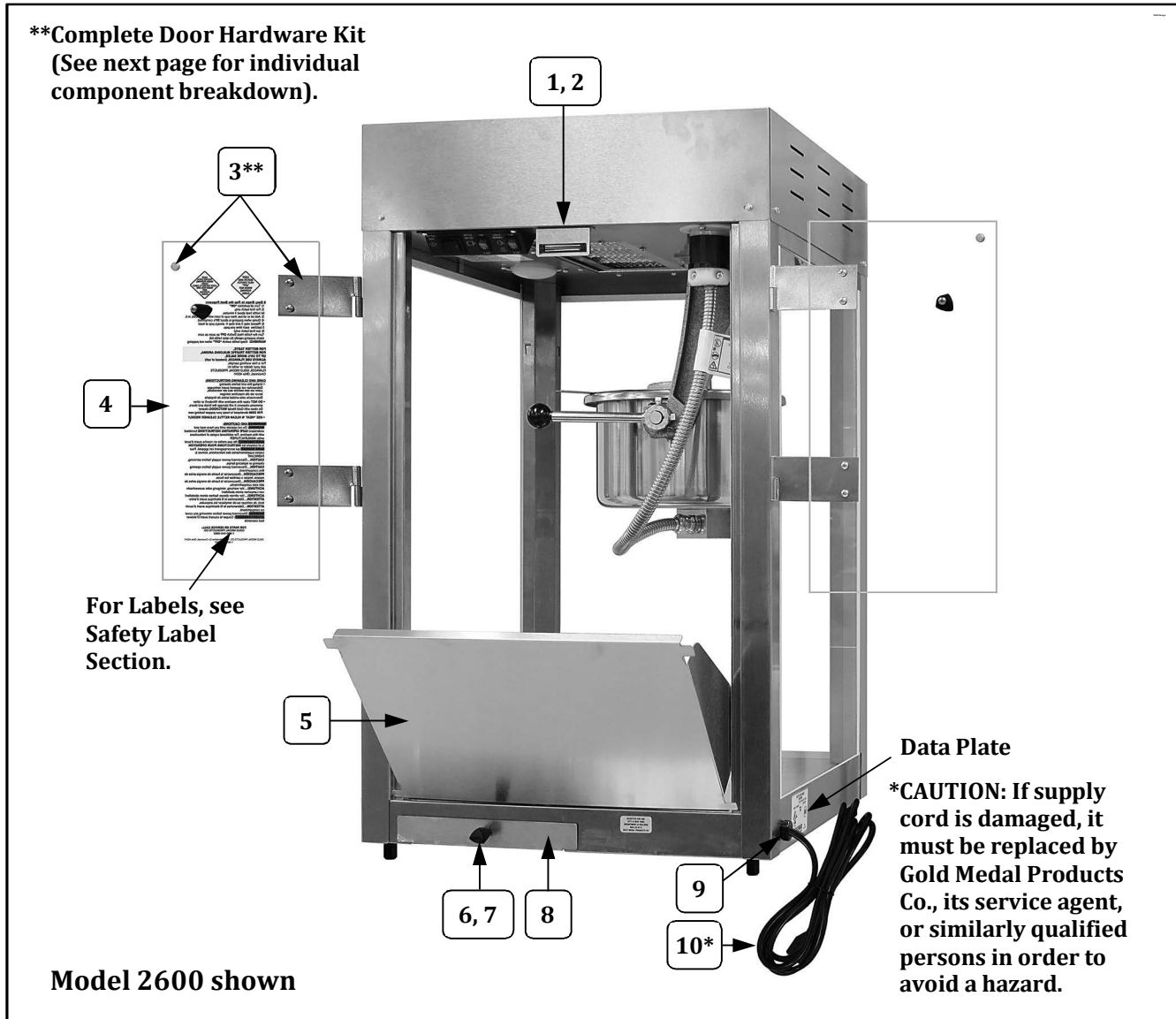

Item	Part Description	Part Number
		All Models
1	MAGNETIC CATCH	47561
2	MAGNETIC CATCH BRACKET	41340
3**	COMPLETE DOOR HARDWARE KIT	61380
4	DOOR	77774
5	DROP PANEL	17319
6	KNOB LID LIFT	47120
7	8-32" X 3/8" PH PAN W/SEMS	42227
8	OLD MAID PAN	49100
9	SR-7W-2 STRAIN RELIEF	67060
10*	15 AMP PLUG LEAD-IN CORD	87085

Cabinet Exterior – Rear View

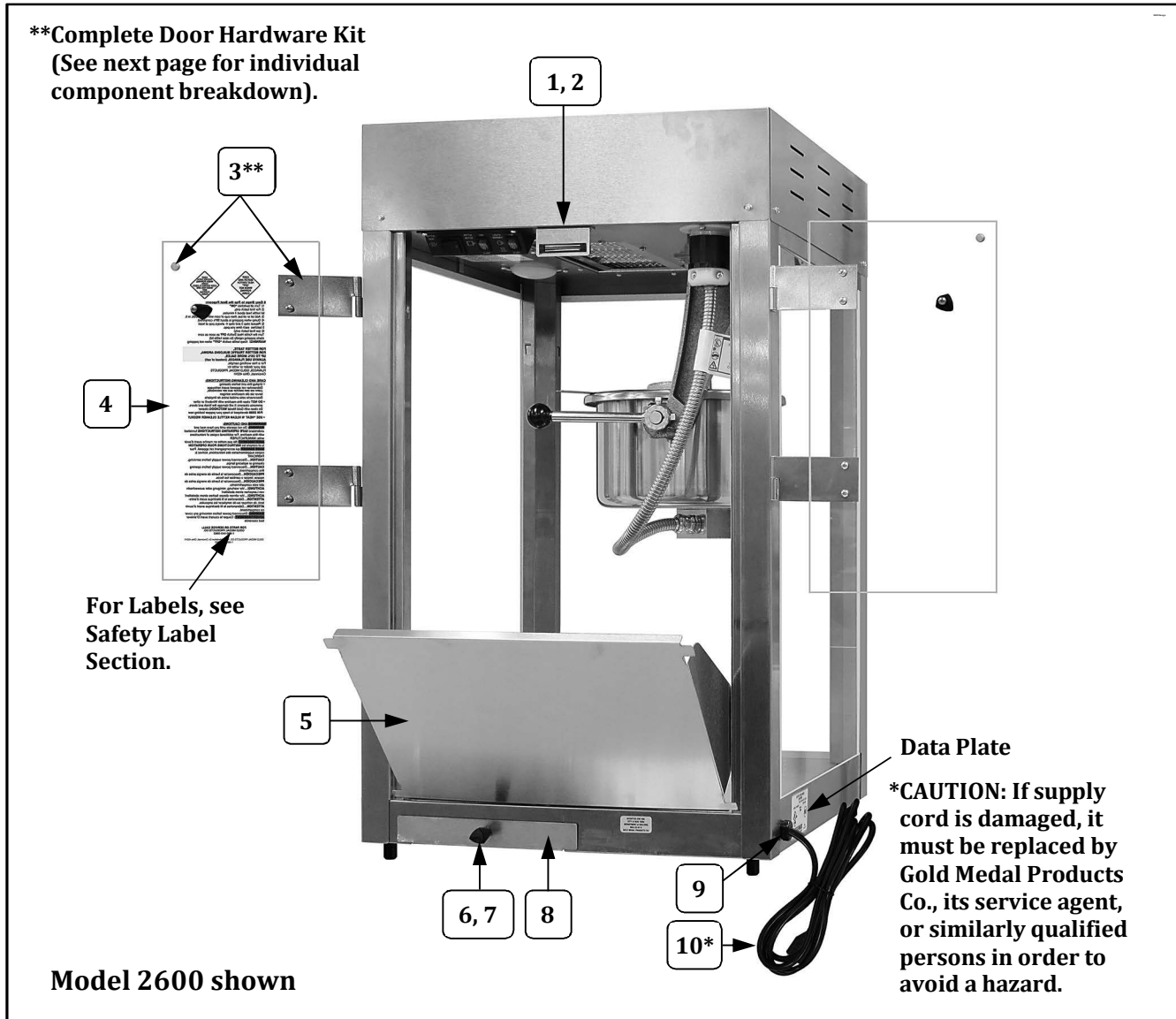

Item	Part Description	Part Number
		All Models
1	MAGNETIC CATCH	47561
2	MAGNETIC CATCH BRACKET	41340
3**	COMPLETE DOOR HARDWARE KIT	61380
4	DOOR	77774
5	DROP PANEL	17319
6	KNOB LID LIFT	47120
7	8-32" X 3/8" PH PAN W/SEMS	42227
8	OLD MAID PAN	49100
9	SR-7W-2 STRAIN RELIEF	67060
10*	15 AMP PLUG LEAD-IN CORD	87085

Cabinet Exterior – Rear View

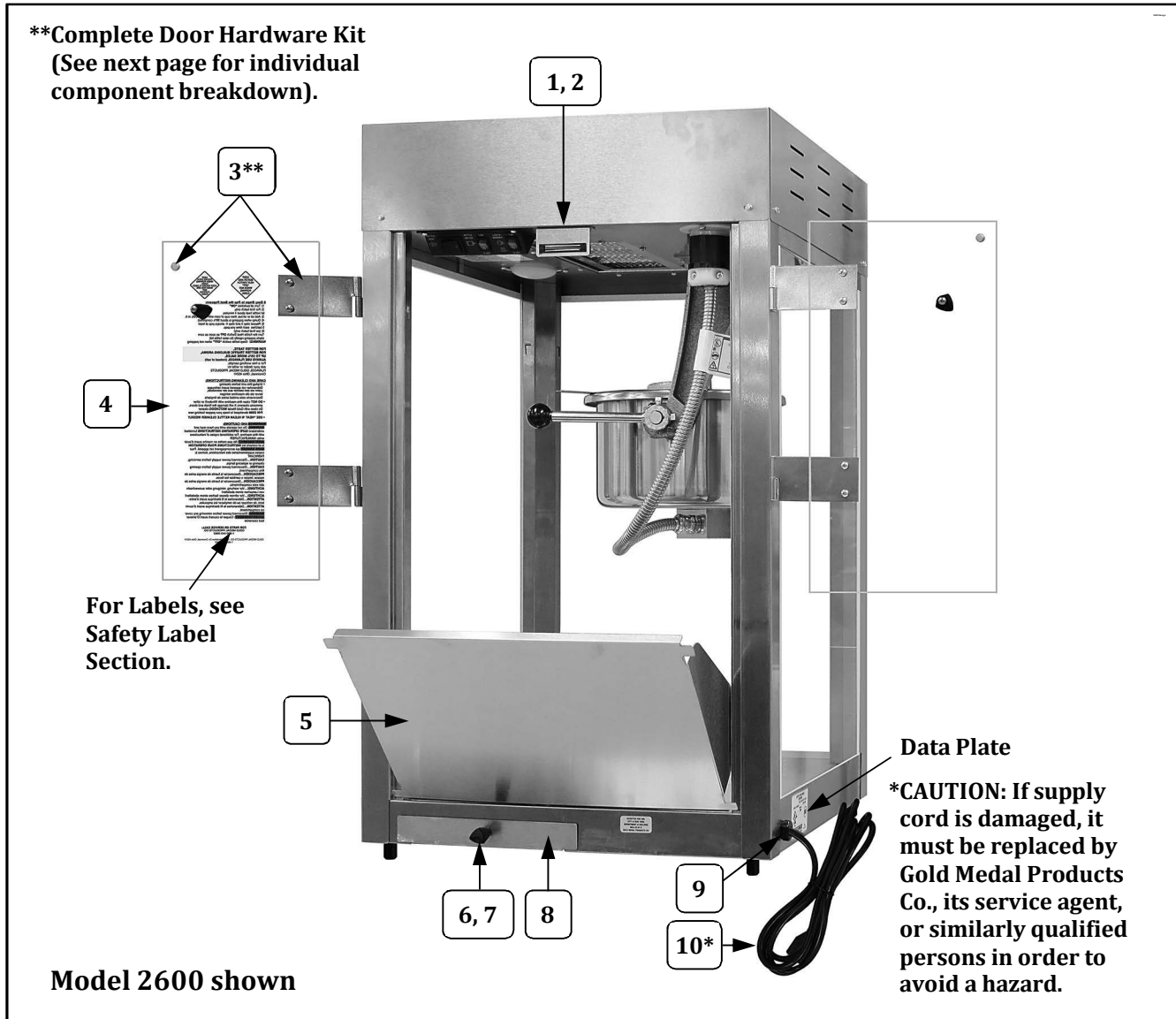

Item	Part Description	Part Number
		All Models
1	MAGNETIC CATCH	47561
2	MAGNETIC CATCH BRACKET	41340
3**	COMPLETE DOOR HARDWARE KIT	61380
4	DOOR	77774
5	DROP PANEL	17319
6	KNOB LID LIFT	47120
7	8-32" X 3/8" PH PAN W/SEMS	42227
8	OLD MAID PAN	49100
9	SR-7W-2 STRAIN RELIEF	67060
10*	15 AMP PLUG LEAD-IN CORD	87085

Door Hardware Kit 61380 – Individual Component Breakdown

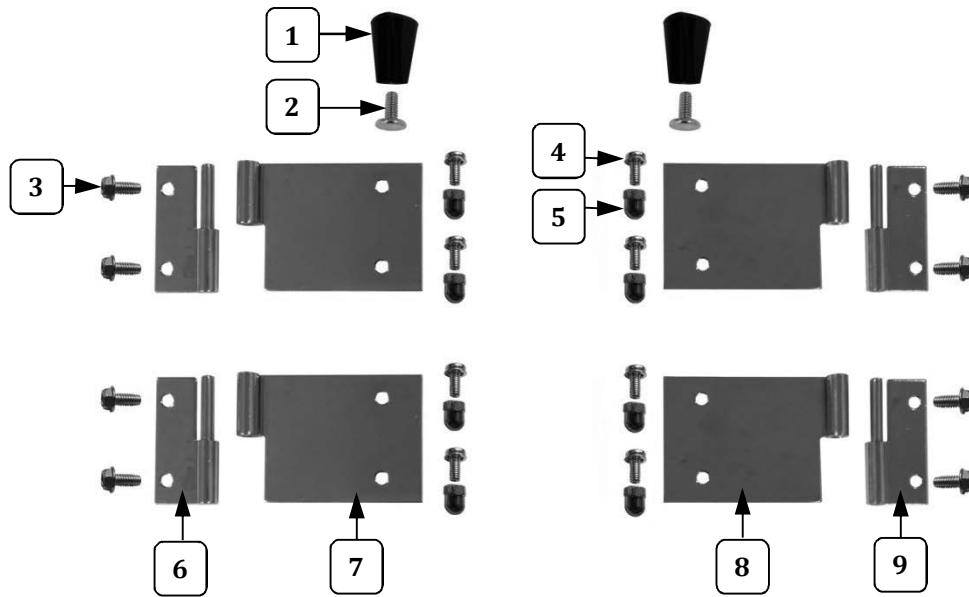

Complete Door Hardware Kit (P/N 61380)
(contains all parts shown above)

Item	Part Description	Part Number
		61380
1	KNOB LID LIFT	47120
2	TEE BOLT	75267
3	8-32 X 5/16 SLOTTED HEX	49594
4	8-32 X 3/8 PH PAN W/SEMS	42227
5	ACORN NUT #8-32	47702
6	MALE HINGE SHORT LEFT	41349
7	FEMALE HINGE LEFT HAND	61359
8	FEMALE HINGE RIGHT HAND	61373
9	MALE HINGE SHORT RIGHT	41350

Door Hardware Kit 61380 – Individual Component Breakdown

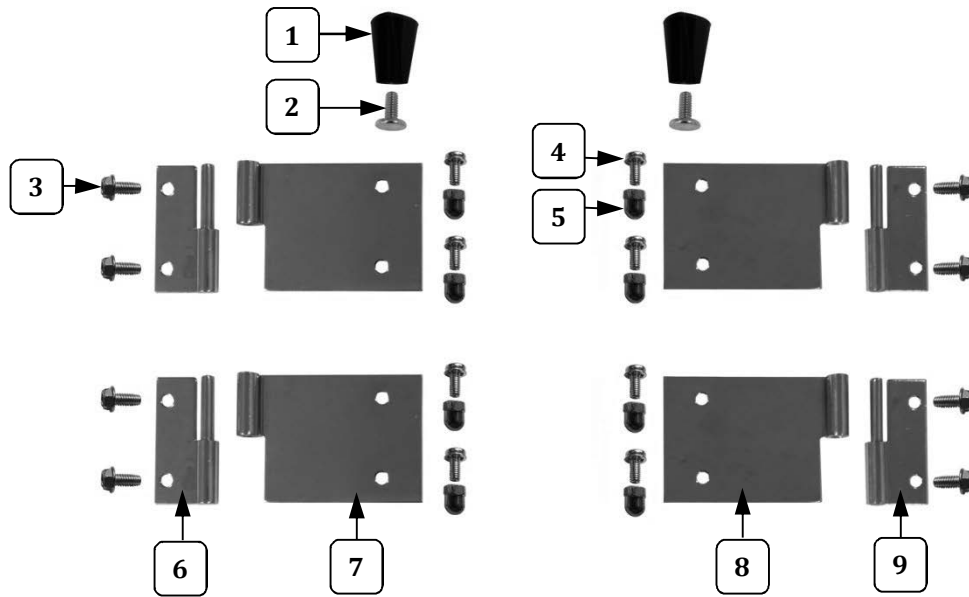

Complete Door Hardware Kit (P/N 61380)
(contains all parts shown above)

Item	Part Description	Part Number
		61380
1	KNOB LID LIFT	47120
2	TEE BOLT	75267
3	8-32 X 5/16 SLOTTED HEX	49594
4	8-32 X 3/8 PH PAN W/SEMS	42227
5	ACORN NUT #8-32	47702
6	MALE HINGE SHORT LEFT	41349
7	FEMALE HINGE LEFT HAND	61359
8	FEMALE HINGE RIGHT HAND	61373
9	MALE HINGE SHORT RIGHT	41350

Door Hardware Kit 61380 – Individual Component Breakdown

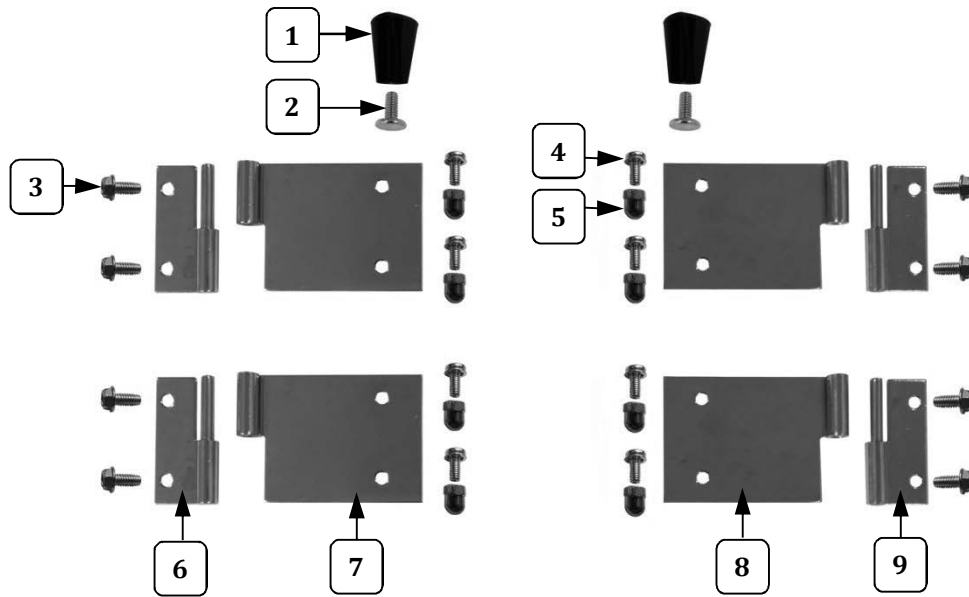

Complete Door Hardware Kit (P/N 61380)
(contains all parts shown above)

Item	Part Description	Part Number
		61380
1	KNOB LID LIFT	47120
2	TEE BOLT	75267
3	8-32 X 5/16 SLOTTED HEX	49594
4	8-32 X 3/8 PH PAN W/SEMS	42227
5	ACORN NUT #8-32	47702
6	MALE HINGE SHORT LEFT	41349
7	FEMALE HINGE LEFT HAND	61359
8	FEMALE HINGE RIGHT HAND	61373
9	MALE HINGE SHORT RIGHT	41350

Door Hardware Kit 61380 – Individual Component Breakdown

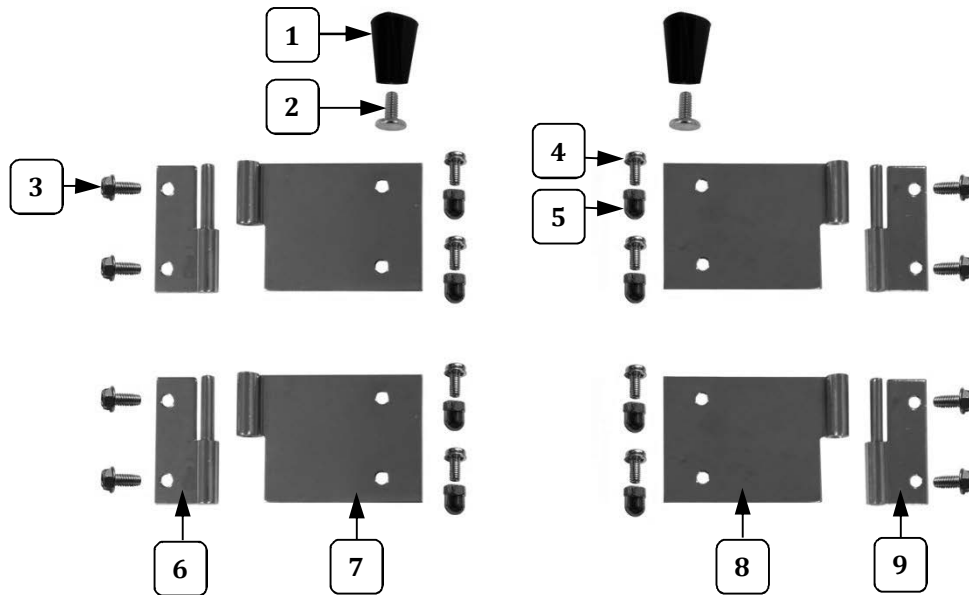

Complete Door Hardware Kit (P/N 61380)
(contains all parts shown above)

Item	Part Description	Part Number
		61380
1	KNOB LID LIFT	47120
2	TEE BOLT	75267
3	8-32 X 5/16 SLOTTED HEX	49594
4	8-32 X 3/8 PH PAN W/SEMS	42227
5	ACORN NUT #8-32	47702
6	MALE HINGE SHORT LEFT	41349
7	FEMALE HINGE LEFT HAND	61359
8	FEMALE HINGE RIGHT HAND	61373
9	MALE HINGE SHORT RIGHT	41350

Door Hardware Kit 61380 – Individual Component Breakdown

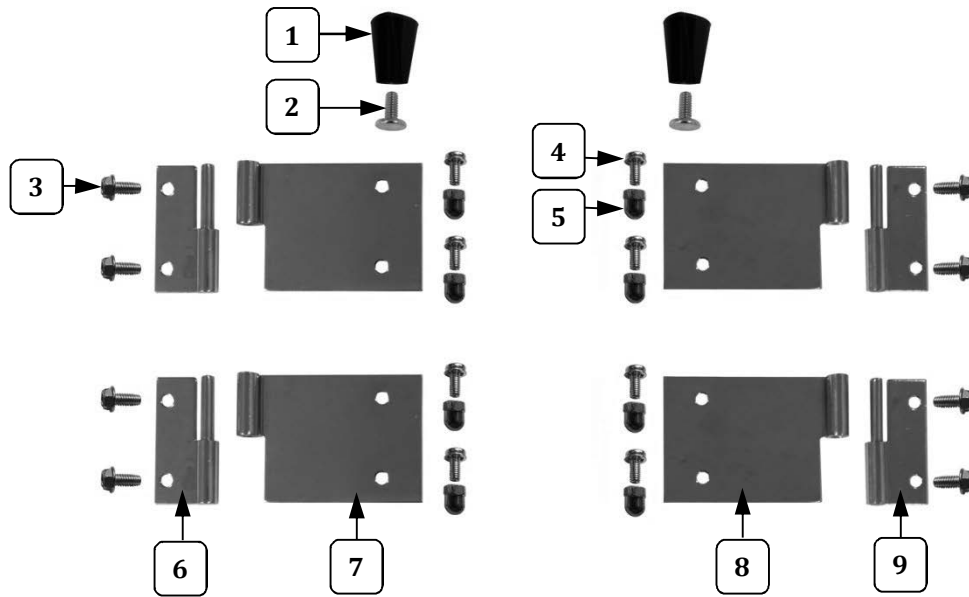

Complete Door Hardware Kit (P/N 61380)
(contains all parts shown above)

Item	Part Description	Part Number
		61380
1	KNOB LID LIFT	47120
2	TEE BOLT	75267
3	8-32 X 5/16 SLOTTED HEX	49594
4	8-32 X 3/8 PH PAN W/SEMS	42227
5	ACORN NUT #8-32	47702
6	MALE HINGE SHORT LEFT	41349
7	FEMALE HINGE LEFT HAND	61359
8	FEMALE HINGE RIGHT HAND	61373
9	MALE HINGE SHORT RIGHT	41350

Door Hardware Kit 61380 – Individual Component Breakdown

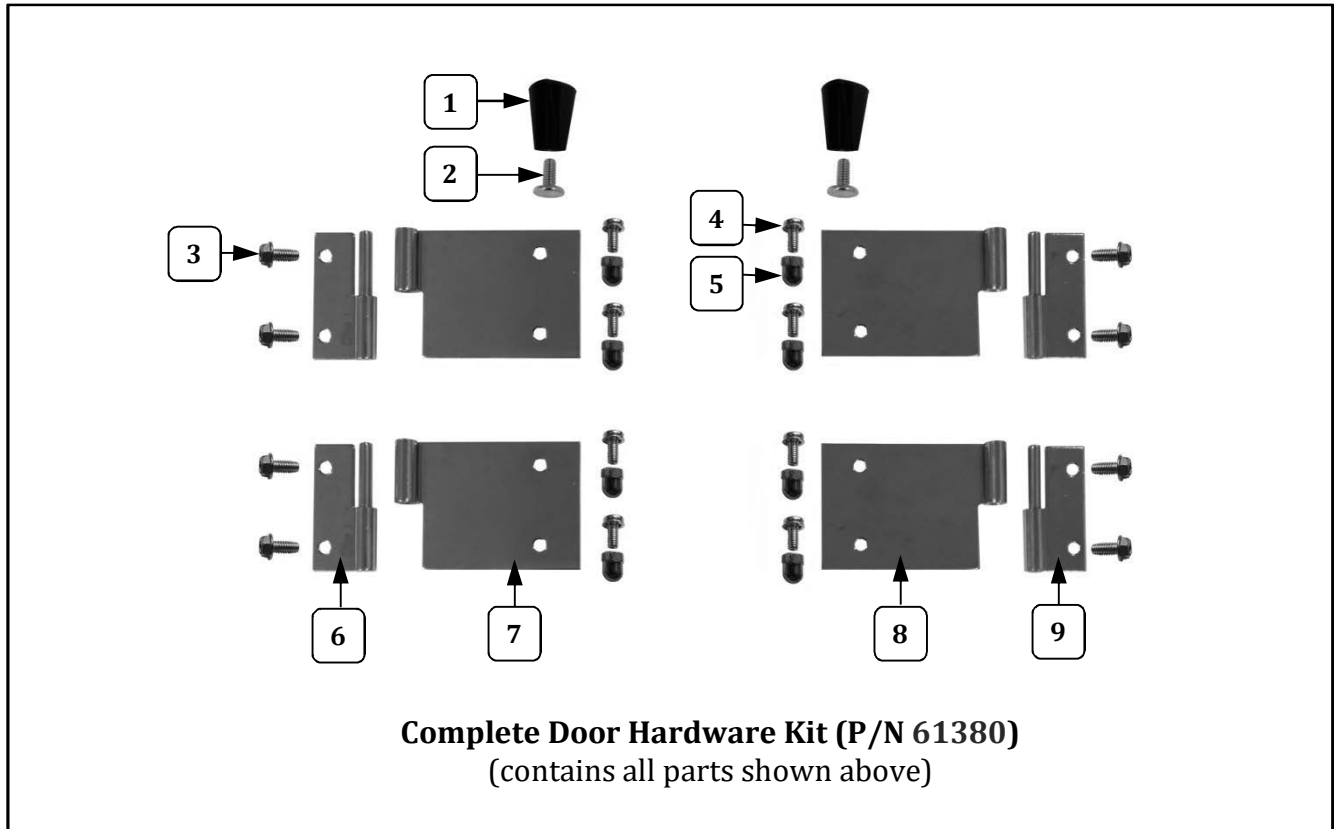

Item	Part Description	Part Number
		61380
1	KNOB LID LIFT	47120
2	TEE BOLT	75267
3	8-32 X 5/16 SLOTTED HEX	49594
4	8-32 X 3/8 PH PAN W/SEMS	42227
5	ACORN NUT #8-32	47702
6	MALE HINGE SHORT LEFT	41349
7	FEMALE HINGE LEFT HAND	61359
8	FEMALE HINGE RIGHT HAND	61373
9	MALE HINGE SHORT RIGHT	41350

Door Hardware Kit 61380 – Individual Component Breakdown

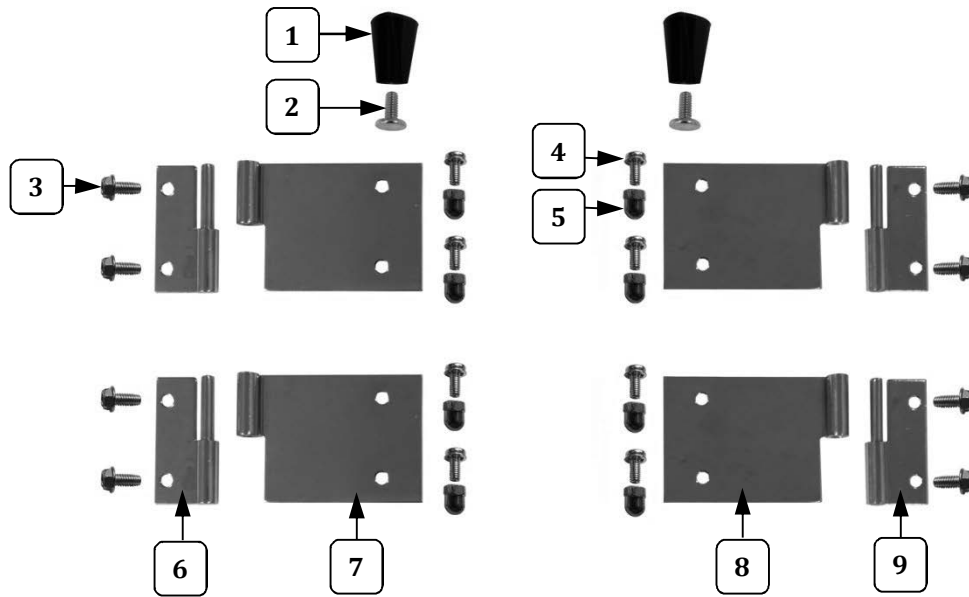

Complete Door Hardware Kit (P/N 61380)
(contains all parts shown above)

Item	Part Description	Part Number
		61380
1	KNOB LID LIFT	47120
2	TEE BOLT	75267
3	8-32 X 5/16 SLOTTED HEX	49594
4	8-32 X 3/8 PH PAN W/SEMS	42227
5	ACORN NUT #8-32	47702
6	MALE HINGE SHORT LEFT	41349
7	FEMALE HINGE LEFT HAND	61359
8	FEMALE HINGE RIGHT HAND	61373
9	MALE HINGE SHORT RIGHT	41350

Door Hardware Kit 61380 – Individual Component Breakdown

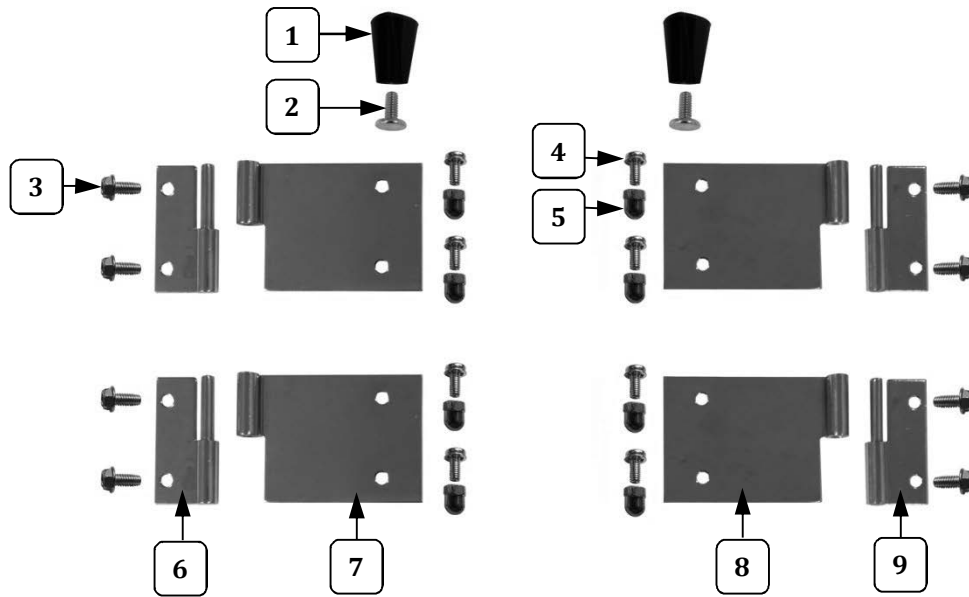

Complete Door Hardware Kit (P/N 61380)
(contains all parts shown above)

Item	Part Description	Part Number
		61380
1	KNOB LID LIFT	47120
2	TEE BOLT	75267
3	8-32 X 5/16 SLOTTED HEX	49594
4	8-32 X 3/8 PH PAN W/SEMS	42227
5	ACORN NUT #8-32	47702
6	MALE HINGE SHORT LEFT	41349
7	FEMALE HINGE LEFT HAND	61359
8	FEMALE HINGE RIGHT HAND	61373
9	MALE HINGE SHORT RIGHT	41350

Door Hardware Kit 61380 – Individual Component Breakdown

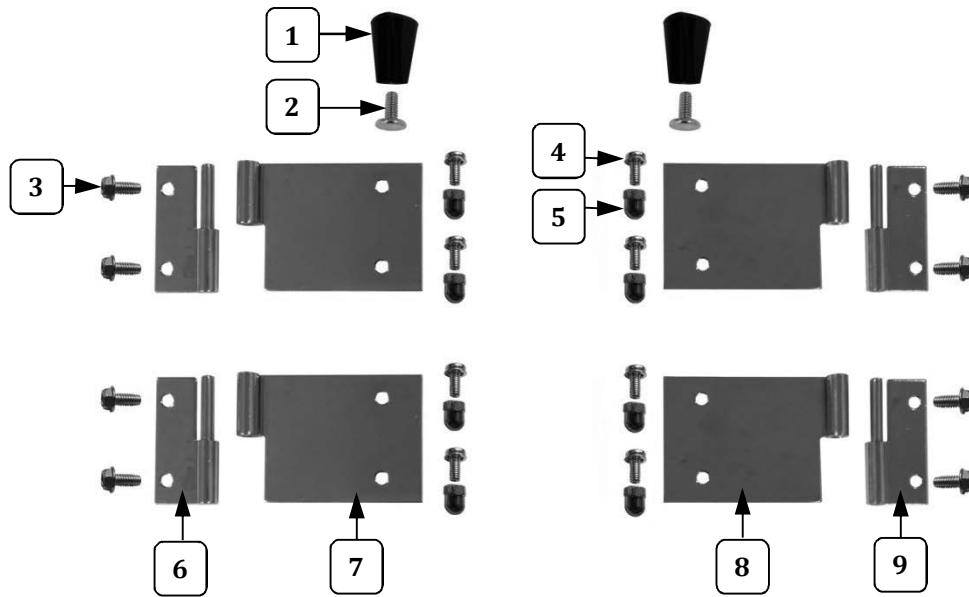

Complete Door Hardware Kit (P/N 61380)
(contains all parts shown above)

Item	Part Description	Part Number
		61380
1	KNOB LID LIFT	47120
2	TEE BOLT	75267
3	8-32 X 5/16 SLOTTED HEX	49594
4	8-32 X 3/8 PH PAN W/SEMS	42227
5	ACORN NUT #8-32	47702
6	MALE HINGE SHORT LEFT	41349
7	FEMALE HINGE LEFT HAND	61359
8	FEMALE HINGE RIGHT HAND	61373
9	MALE HINGE SHORT RIGHT	41350

Door Hardware Kit 61380 – Individual Component Breakdown

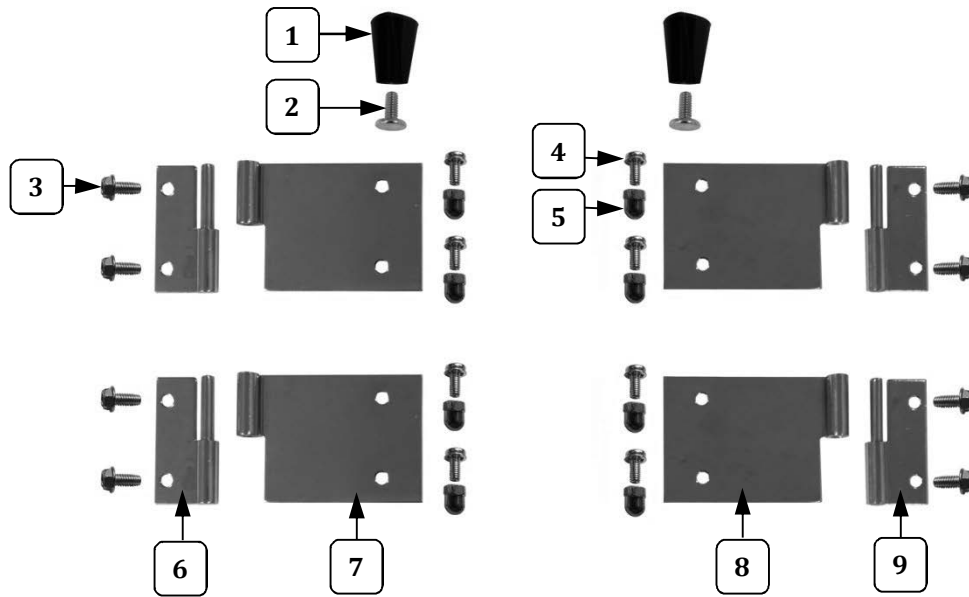

Complete Door Hardware Kit (P/N 61380)
(contains all parts shown above)

Item	Part Description	Part Number
		61380
1	KNOB LID LIFT	47120
2	TEE BOLT	75267
3	8-32 X 5/16 SLOTTED HEX	49594
4	8-32 X 3/8 PH PAN W/SEMS	42227
5	ACORN NUT #8-32	47702
6	MALE HINGE SHORT LEFT	41349
7	FEMALE HINGE LEFT HAND	61359
8	FEMALE HINGE RIGHT HAND	61373
9	MALE HINGE SHORT RIGHT	41350

Door Hardware Kit 61380 – Individual Component Breakdown

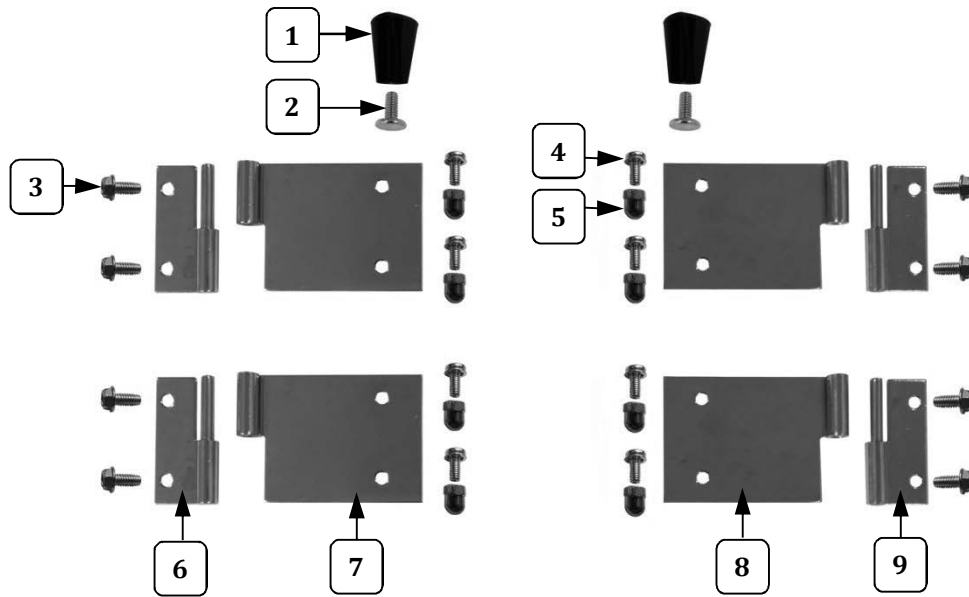

Complete Door Hardware Kit (P/N 61380)
(contains all parts shown above)

Item	Part Description	Part Number
		61380
1	KNOB LID LIFT	47120
2	TEE BOLT	75267
3	8-32 X 5/16 SLOTTED HEX	49594
4	8-32 X 3/8 PH PAN W/SEMS	42227
5	ACORN NUT #8-32	47702
6	MALE HINGE SHORT LEFT	41349
7	FEMALE HINGE LEFT HAND	61359
8	FEMALE HINGE RIGHT HAND	61373
9	MALE HINGE SHORT RIGHT	41350

Door Hardware Kit 61380 – Individual Component Breakdown

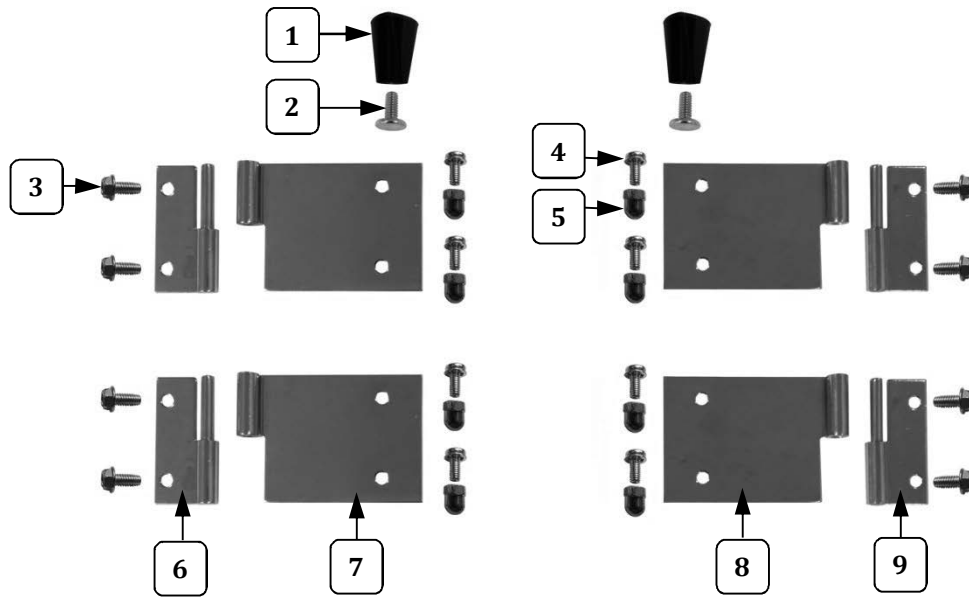

Complete Door Hardware Kit (P/N 61380)
(contains all parts shown above)

Item	Part Description	Part Number
		61380
1	KNOB LID LIFT	47120
2	TEE BOLT	75267
3	8-32 X 5/16 SLOTTED HEX	49594
4	8-32 X 3/8 PH PAN W/SEMS	42227
5	ACORN NUT #8-32	47702
6	MALE HINGE SHORT LEFT	41349
7	FEMALE HINGE LEFT HAND	61359
8	FEMALE HINGE RIGHT HAND	61373
9	MALE HINGE SHORT RIGHT	41350

Cabinet Interior – Hanger Assembly/Controls View

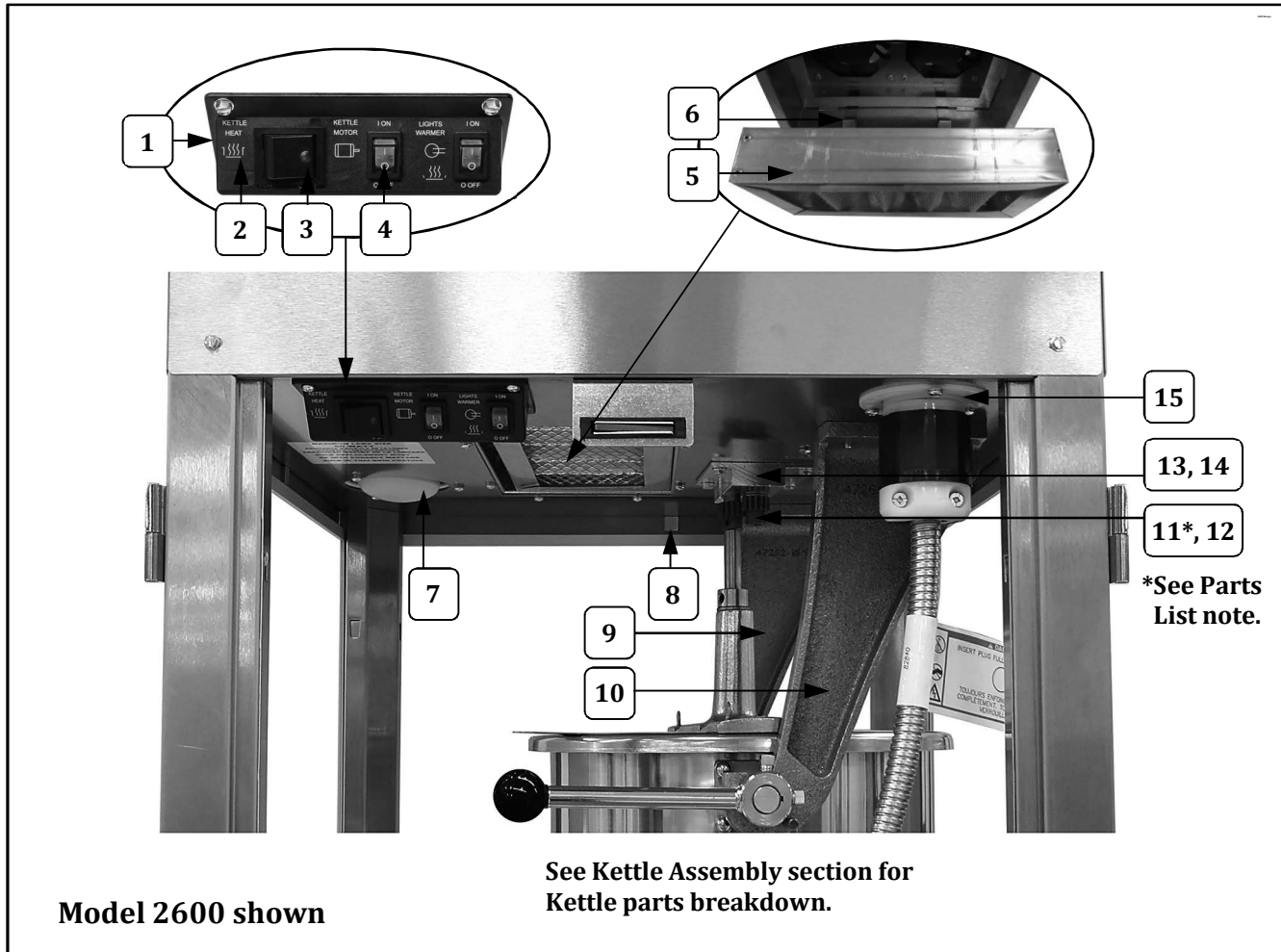

Item	Part Description	Part Number
		All Models
1	SWITCH BOX	48501
2	SWITCH LABEL	48502
3	GREEN LIGHTED ROCKER SWITCH	42798
4	DPST ROCKER SWITCH	42532
5	5 X 10 X 2 FILTER	69850
6	FILTER SPRING CLIP	62666
7	50 W FLOOD LIGHT COATED	42947
8	MAGNET .5X.5X.1 GLASS LOCK	51113
9	FRONT HANGER ARM	47262
10	REAR HANGER ARM	47263
11*	SPUR GEAR KIT (Includes 2 gears with set screws. Always replace Agitator Spur Gear and Kettle Drive Motor Gear as a set.)	47059K
12	10-32" X 3/16" SET SCREW	41742
13	GEAR BLOCK ASSEMBLY	67194
14	10-24 X 1 HEX MACH SCREW (fastens gear block assembly to kettle drive motor)	49322
15	KETTLE LEAD IN RECPT	47327

Cabinet Interior – Hanger Assembly/Controls View

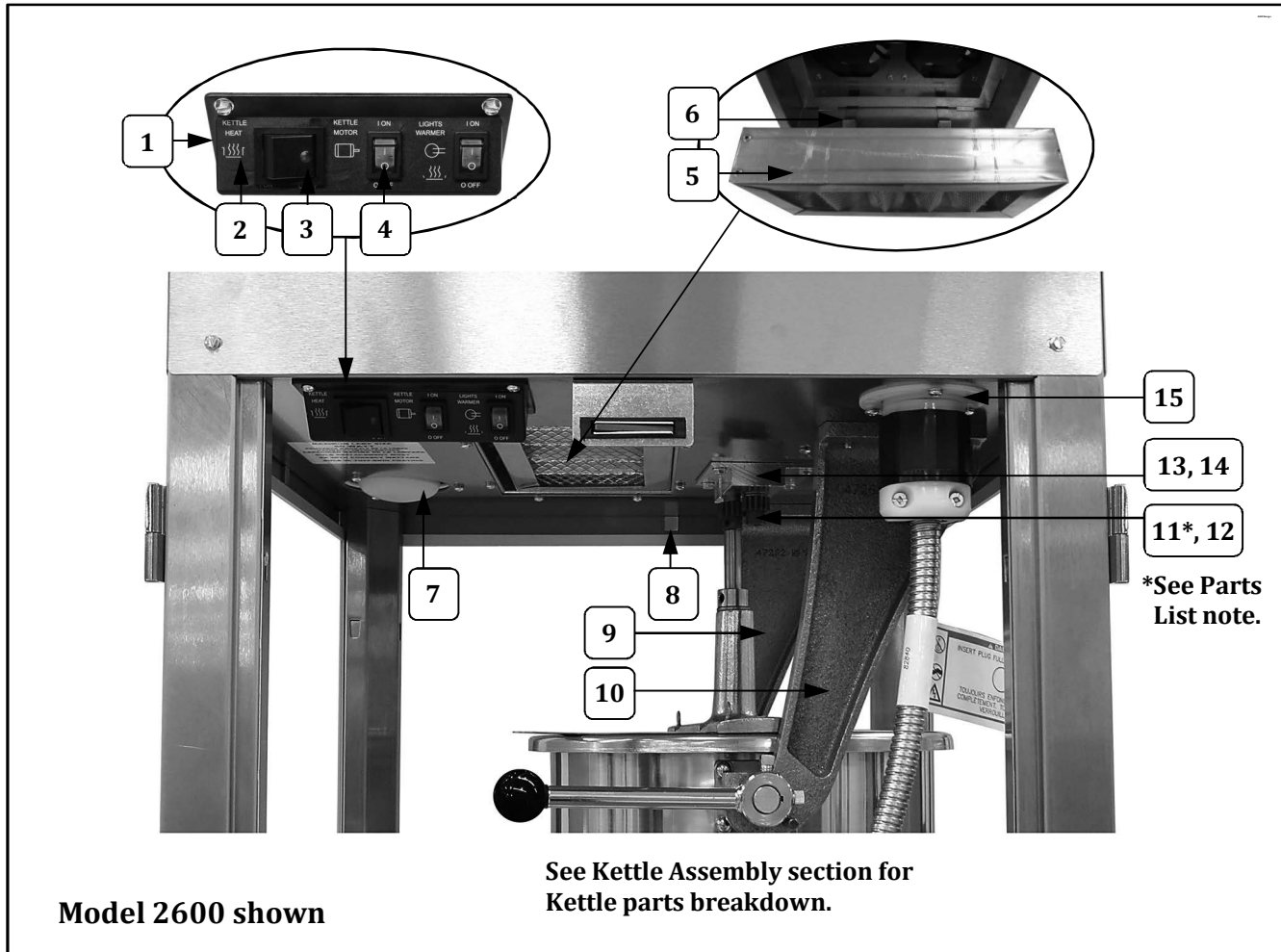

Item	Part Description	Part Number
		All Models
1	SWITCH BOX	48501
2	SWITCH LABEL	48502
3	GREEN LIGHTED ROCKER SWITCH	42798
4	DPST ROCKER SWITCH	42532
5	5 X 10 X 2 FILTER	69850
6	FILTER SPRING CLIP	62666
7	50 W FLOOD LIGHT COATED	42947
8	MAGNET .5X.5X.1 GLASS LOCK	51113
9	FRONT HANGER ARM	47262
10	REAR HANGER ARM	47263
11*	SPUR GEAR KIT (Includes 2 gears with set screws. Always replace Agitator Spur Gear and Kettle Drive Motor Gear as a set.)	47059K
12	10-32" X 3/16" SET SCREW	41742
13	GEAR BLOCK ASSEMBLY	67194
14	10-24 X 1 HEX MACH SCREW (fastens gear block assembly to kettle drive motor)	49322
15	KETTLE LEAD IN RECPT	47327

Cabinet Interior – Hanger Assembly/Controls View

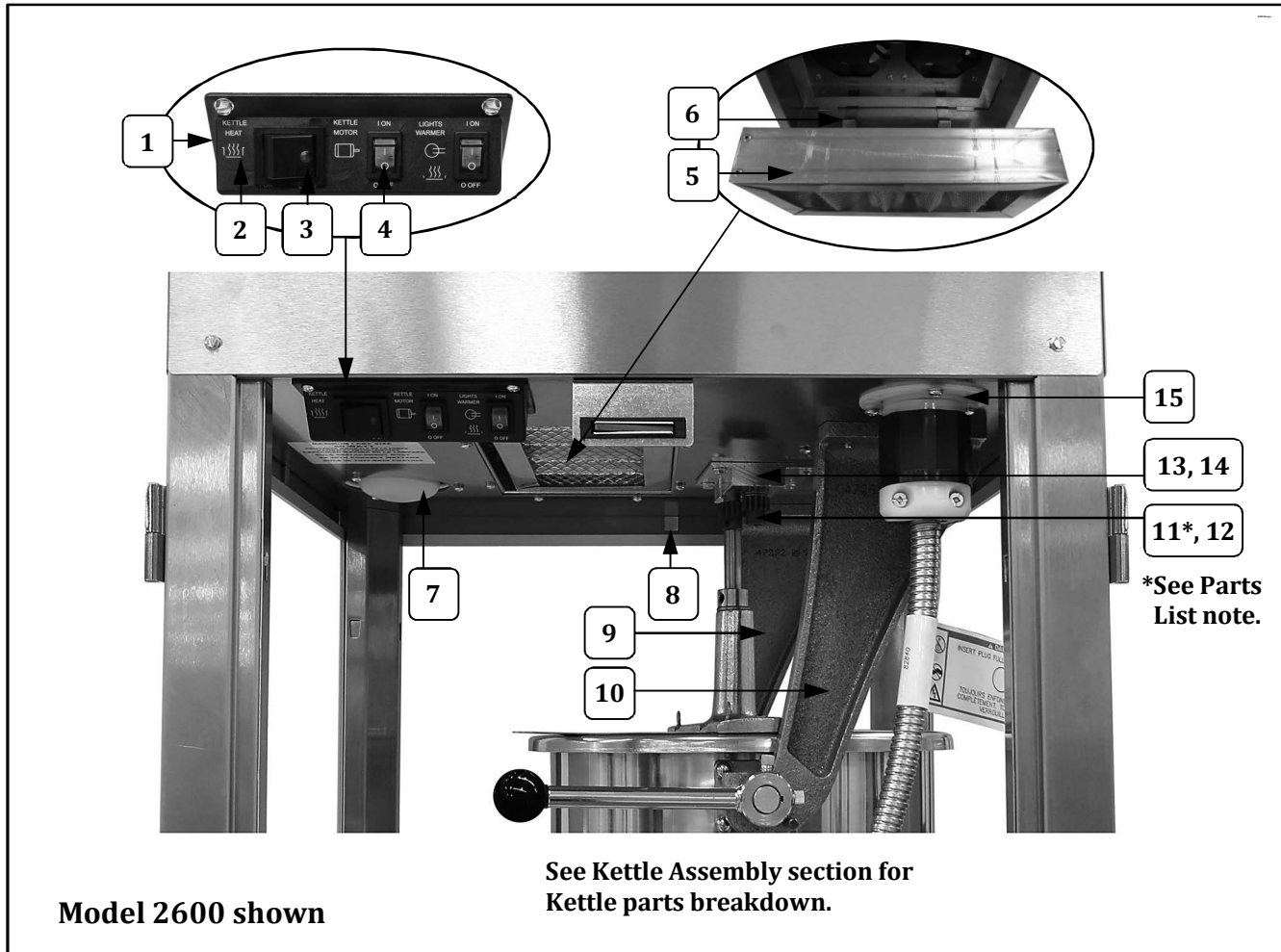

Item	Part Description	Part Number
		All Models
1	SWITCH BOX	48501
2	SWITCH LABEL	48502
3	GREEN LIGHTED ROCKER SWITCH	42798
4	DPST ROCKER SWITCH	42532
5	5 X 10 X 2 FILTER	69850
6	FILTER SPRING CLIP	62666
7	50 W FLOOD LIGHT COATED	42947
8	MAGNET .5X.5X.1 GLASS LOCK	51113
9	FRONT HANGER ARM	47262
10	REAR HANGER ARM	47263
11*	SPUR GEAR KIT (Includes 2 gears with set screws. Always replace Agitator Spur Gear and Kettle Drive Motor Gear as a set.)	47059K
12	10-32" X 3/16" SET SCREW	41742
13	GEAR BLOCK ASSEMBLY	67194
14	10-24 X 1 HEX MACH SCREW (fastens gear block assembly to kettle drive motor)	49322
15	KETTLE LEAD IN RECPT	47327

Cabinet Interior – Hanger Assembly/Controls View

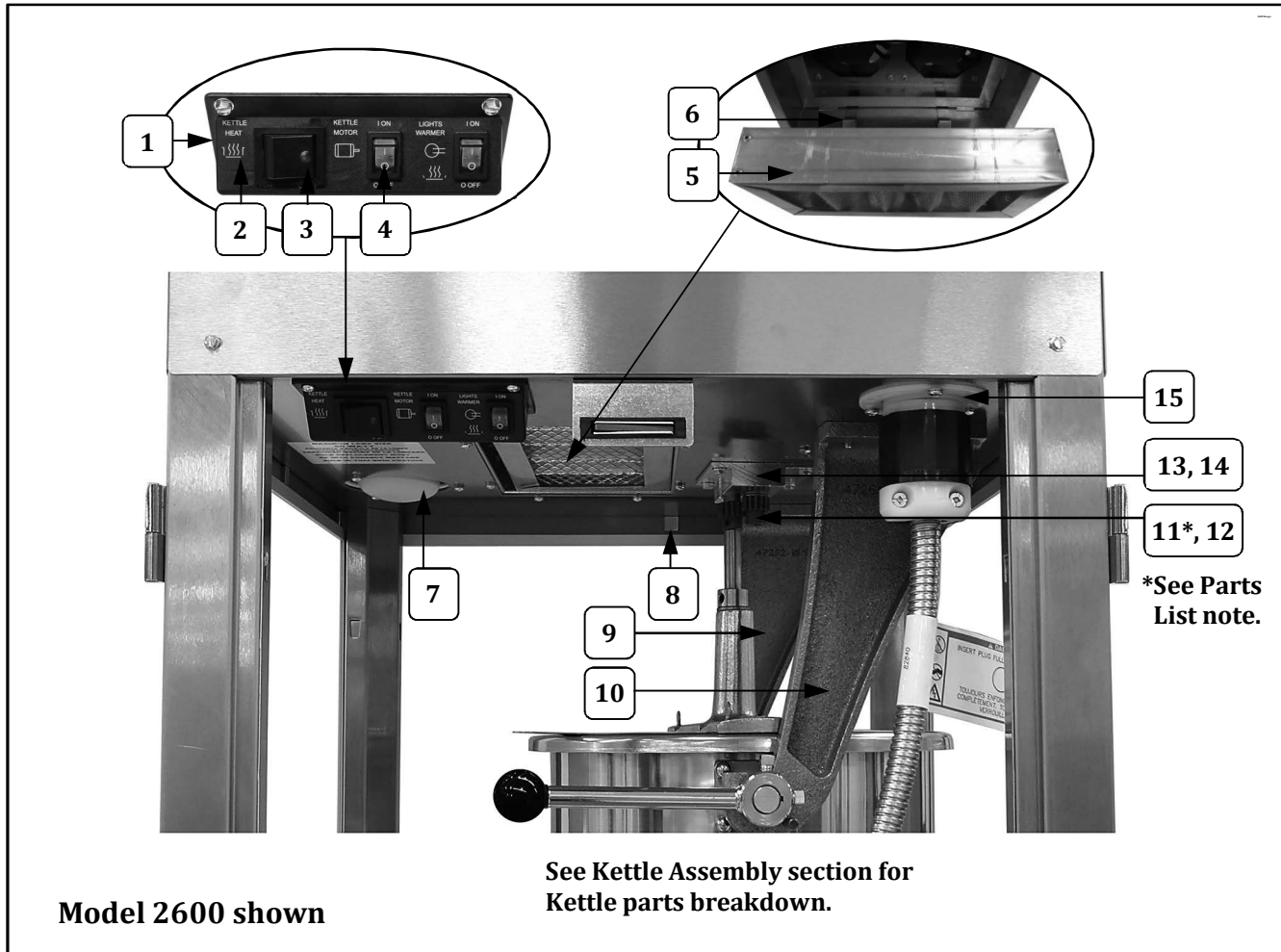

Item	Part Description	Part Number
		All Models
1	SWITCH BOX	48501
2	SWITCH LABEL	48502
3	GREEN LIGHTED ROCKER SWITCH	42798
4	DPST ROCKER SWITCH	42532
5	5 X 10 X 2 FILTER	69850
6	FILTER SPRING CLIP	62666
7	50 W FLOOD LIGHT COATED	42947
8	MAGNET .5X.5X.1 GLASS LOCK	51113
9	FRONT HANGER ARM	47262
10	REAR HANGER ARM	47263
11*	SPUR GEAR KIT (Includes 2 gears with set screws. Always replace Agitator Spur Gear and Kettle Drive Motor Gear as a set.)	47059K
12	10-32" X 3/16" SET SCREW	41742
13	GEAR BLOCK ASSEMBLY	67194
14	10-24 X 1 HEX MACH SCREW (fastens gear block assembly to kettle drive motor)	49322
15	KETTLE LEAD IN RECPT	47327

Cabinet Interior – Hanger Assembly/Controls View

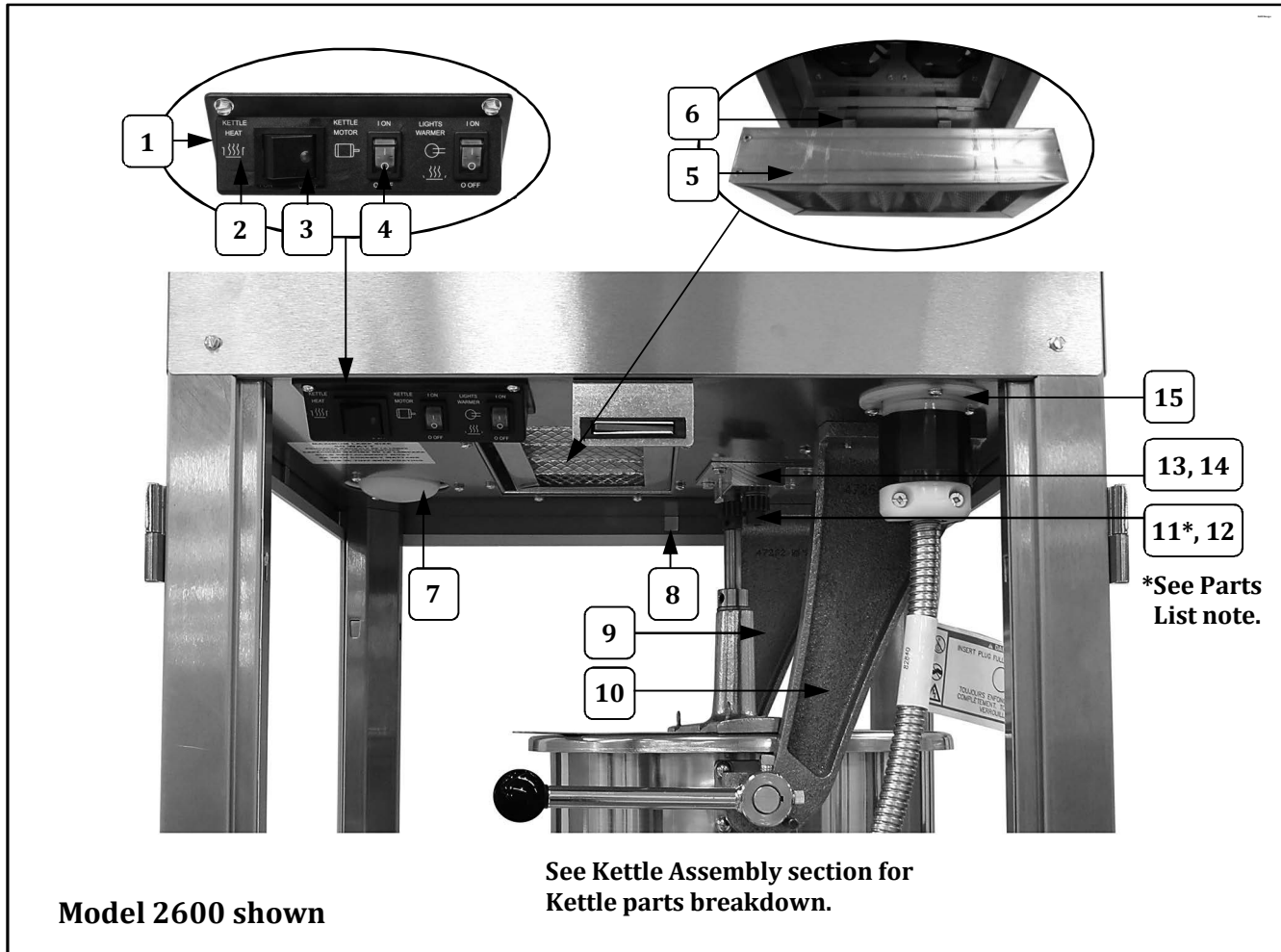

Item	Part Description	Part Number
		All Models
1	SWITCH BOX	48501
2	SWITCH LABEL	48502
3	GREEN LIGHTED ROCKER SWITCH	42798
4	DPST ROCKER SWITCH	42532
5	5 X 10 X 2 FILTER	69850
6	FILTER SPRING CLIP	62666
7	50 W FLOOD LIGHT COATED	42947
8	MAGNET .5X.5X.1 GLASS LOCK	51113
9	FRONT HANGER ARM	47262
10	REAR HANGER ARM	47263
11*	SPUR GEAR KIT (Includes 2 gears with set screws. Always replace Agitator Spur Gear and Kettle Drive Motor Gear as a set.)	47059K
12	10-32" X 3/16" SET SCREW	41742
13	GEAR BLOCK ASSEMBLY	67194
14	10-24 X 1 HEX MACH SCREW (fastens gear block assembly to kettle drive motor)	49322
15	KETTLE LEAD IN RECPT	47327

Cabinet Interior – Hanger Assembly/Controls View

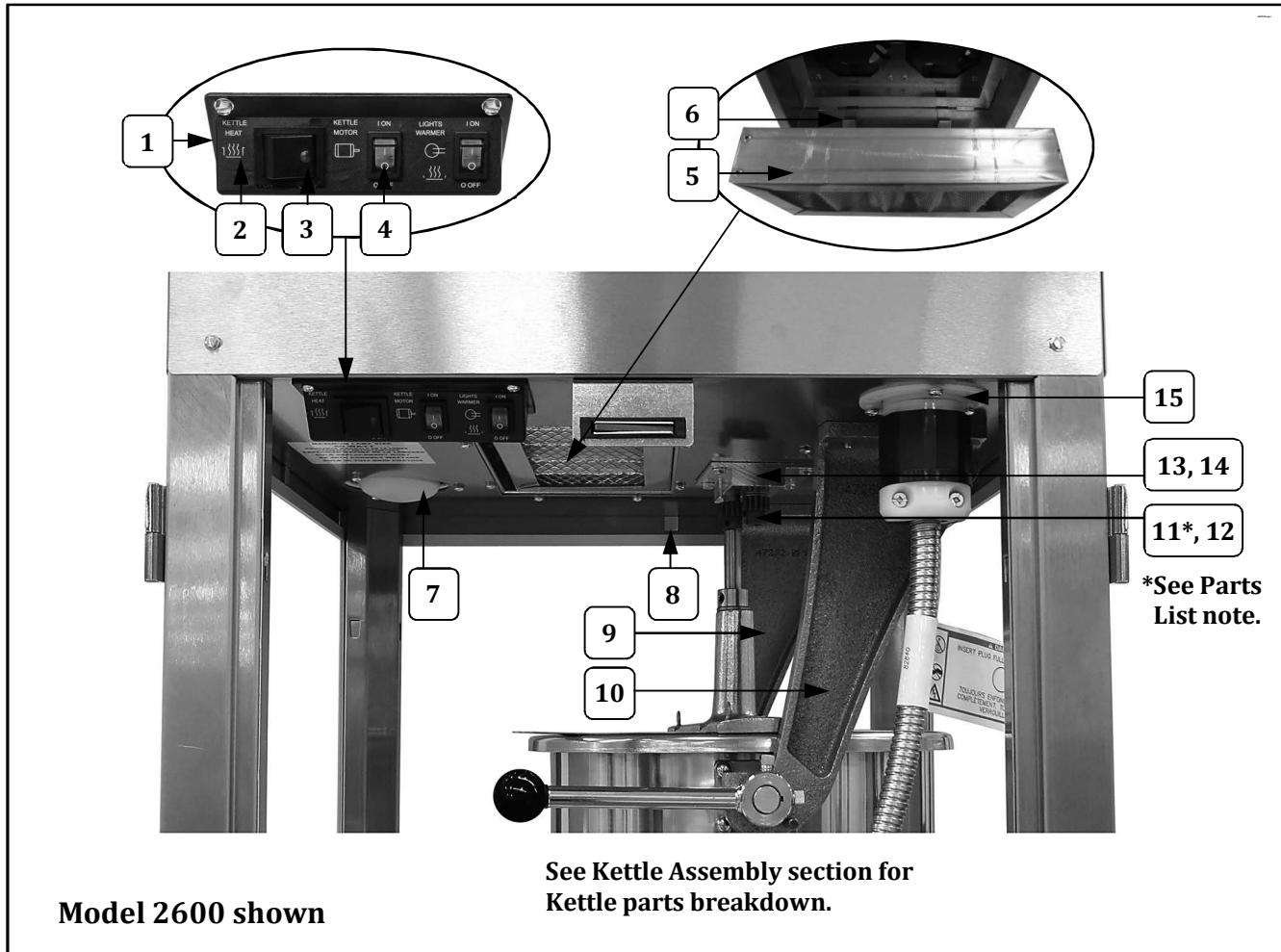

Item	Part Description	Part Number
		All Models
1	SWITCH BOX	48501
2	SWITCH LABEL	48502
3	GREEN LIGHTED ROCKER SWITCH	42798
4	DPST ROCKER SWITCH	42532
5	5 X 10 X 2 FILTER	69850
6	FILTER SPRING CLIP	62666
7	50 W FLOOD LIGHT COATED	42947
8	MAGNET .5X.5X.1 GLASS LOCK	51113
9	FRONT HANGER ARM	47262
10	REAR HANGER ARM	47263
11*	SPUR GEAR KIT (Includes 2 gears with set screws. Always replace Agitator Spur Gear and Kettle Drive Motor Gear as a set.)	47059K
12	10-32" X 3/16" SET SCREW	41742
13	GEAR BLOCK ASSEMBLY	67194
14	10-24 X 1 HEX MACH SCREW (fastens gear block assembly to kettle drive motor)	49322
15	KETTLE LEAD IN RECPT	47327

Cabinet Interior – Hanger Assembly/Controls View

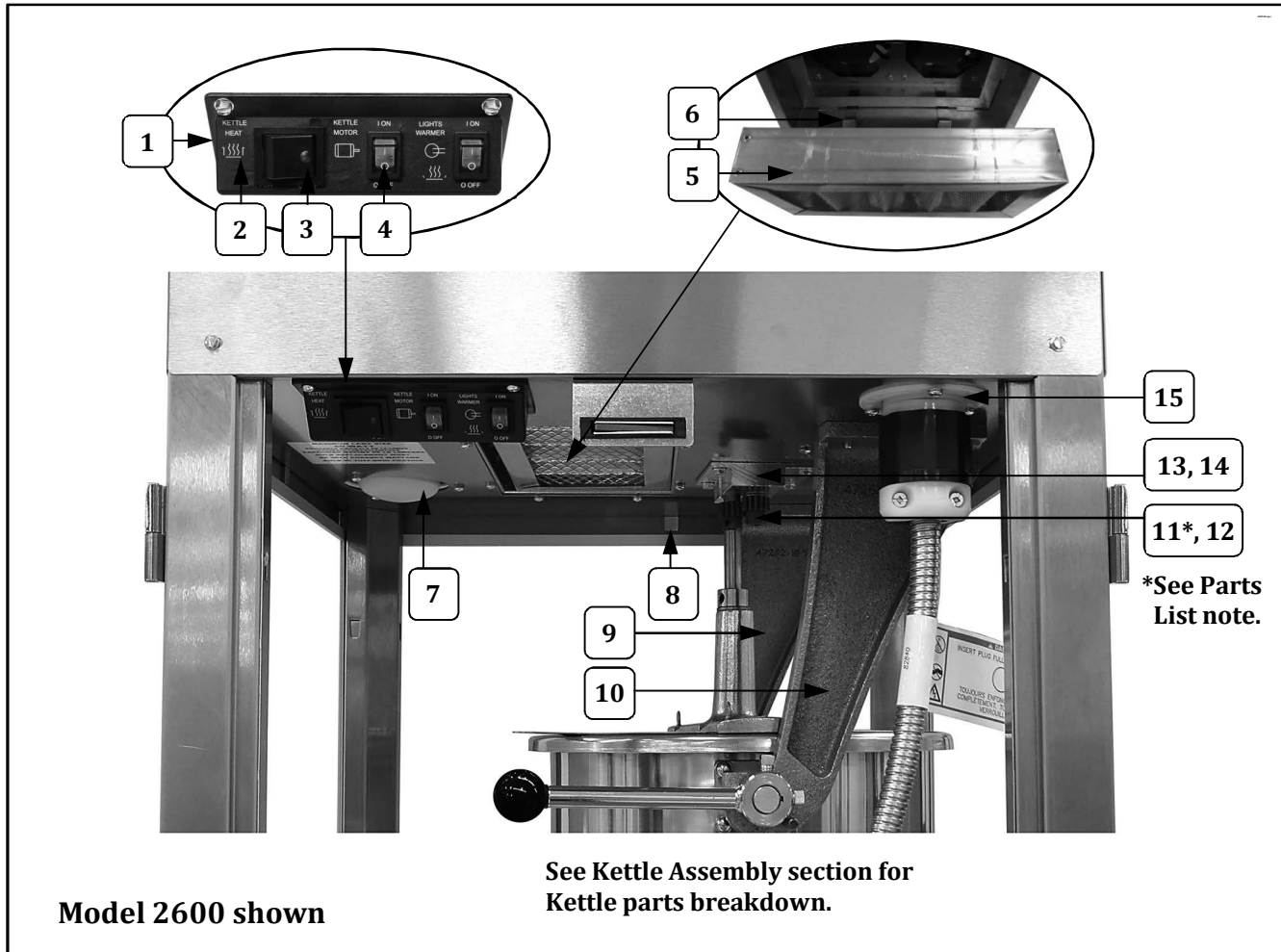

Item	Part Description	Part Number
		All Models
1	SWITCH BOX	48501
2	SWITCH LABEL	48502
3	GREEN LIGHTED ROCKER SWITCH	42798
4	DPST ROCKER SWITCH	42532
5	5 X 10 X 2 FILTER	69850
6	FILTER SPRING CLIP	62666
7	50 W FLOOD LIGHT COATED	42947
8	MAGNET .5X.5X.1 GLASS LOCK	51113
9	FRONT HANGER ARM	47262
10	REAR HANGER ARM	47263
11*	SPUR GEAR KIT (Includes 2 gears with set screws. Always replace Agitator Spur Gear and Kettle Drive Motor Gear as a set.)	47059K
12	10-32" X 3/16" SET SCREW	41742
13	GEAR BLOCK ASSEMBLY	67194
14	10-24 X 1 HEX MACH SCREW (fastens gear block assembly to kettle drive motor)	49322
15	KETTLE LEAD IN RECPT	47327

Cabinet Interior – Hanger Assembly/Controls View

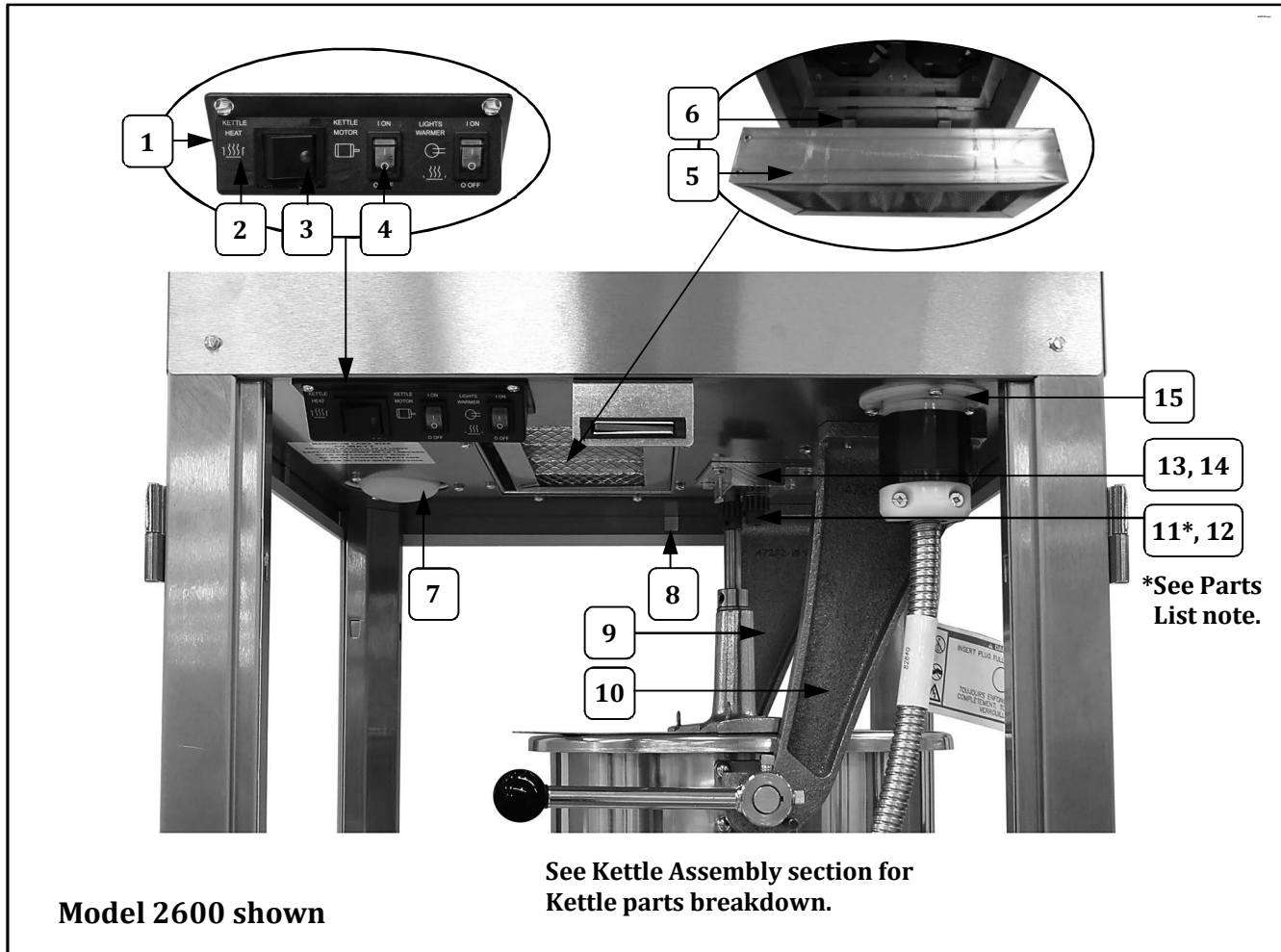

Item	Part Description	Part Number
		All Models
1	SWITCH BOX	48501
2	SWITCH LABEL	48502
3	GREEN LIGHTED ROCKER SWITCH	42798
4	DPST ROCKER SWITCH	42532
5	5 X 10 X 2 FILTER	69850
6	FILTER SPRING CLIP	62666
7	50 W FLOOD LIGHT COATED	42947
8	MAGNET .5X.5X.1 GLASS LOCK	51113
9	FRONT HANGER ARM	47262
10	REAR HANGER ARM	47263
11*	SPUR GEAR KIT (Includes 2 gears with set screws. Always replace Agitator Spur Gear and Kettle Drive Motor Gear as a set.)	47059K
12	10-32" X 3/16" SET SCREW	41742
13	GEAR BLOCK ASSEMBLY	67194
14	10-24 X 1 HEX MACH SCREW (fastens gear block assembly to kettle drive motor)	49322
15	KETTLE LEAD IN RECPT	47327

Cabinet Interior – Hanger Assembly/Controls View

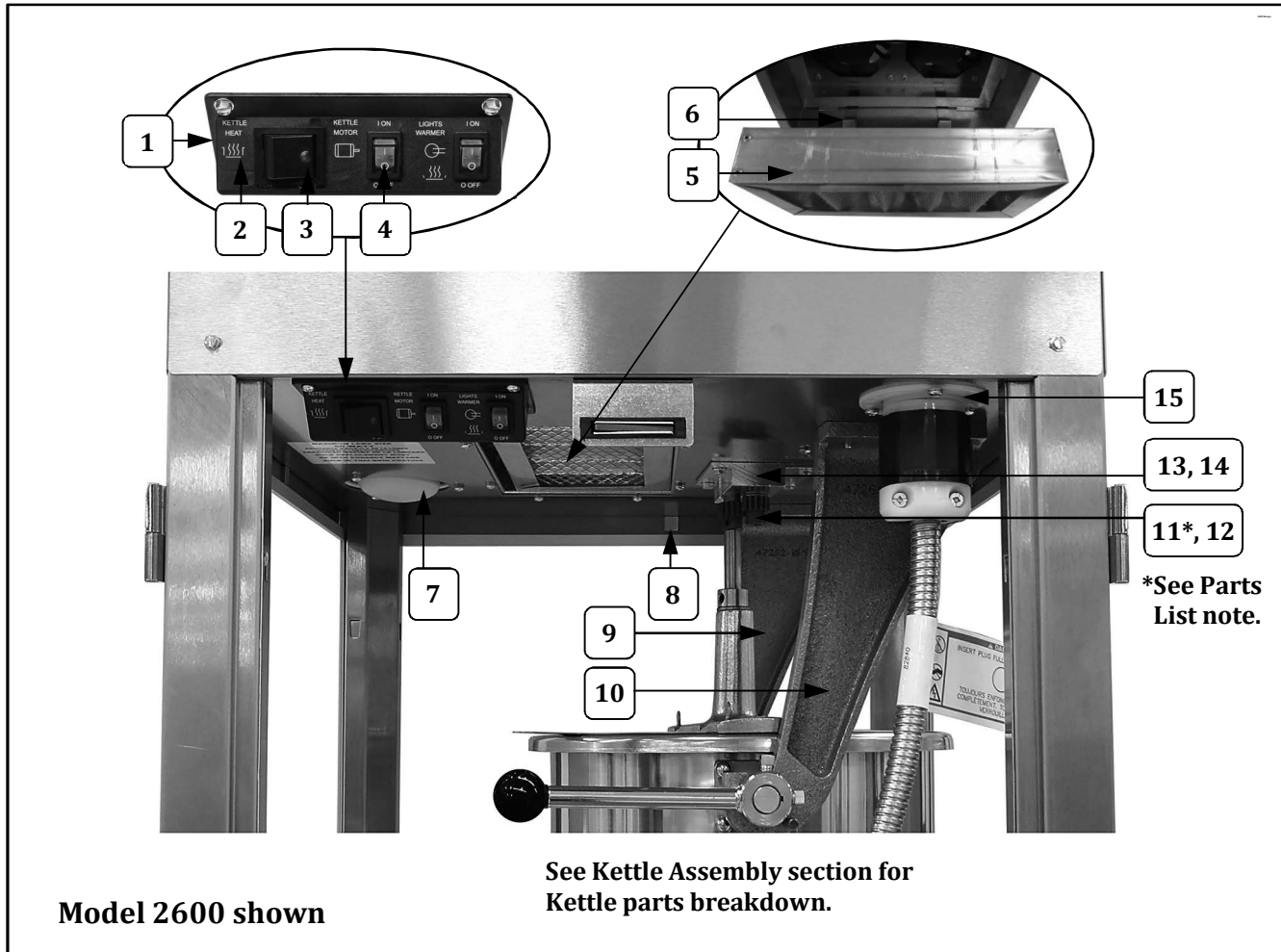

Item	Part Description	Part Number
		All Models
1	SWITCH BOX	48501
2	SWITCH LABEL	48502
3	GREEN LIGHTED ROCKER SWITCH	42798
4	DPST ROCKER SWITCH	42532
5	5 X 10 X 2 FILTER	69850
6	FILTER SPRING CLIP	62666
7	50 W FLOOD LIGHT COATED	42947
8	MAGNET .5X.5X.1 GLASS LOCK	51113
9	FRONT HANGER ARM	47262
10	REAR HANGER ARM	47263
11*	SPUR GEAR KIT (Includes 2 gears with set screws. Always replace Agitator Spur Gear and Kettle Drive Motor Gear as a set.)	47059K
12	10-32" X 3/16" SET SCREW	41742
13	GEAR BLOCK ASSEMBLY	67194
14	10-24 X 1 HEX MACH SCREW (fastens gear block assembly to kettle drive motor)	49322
15	KETTLE LEAD IN RECPT	47327

Cabinet Interior – Hanger Assembly/Controls View

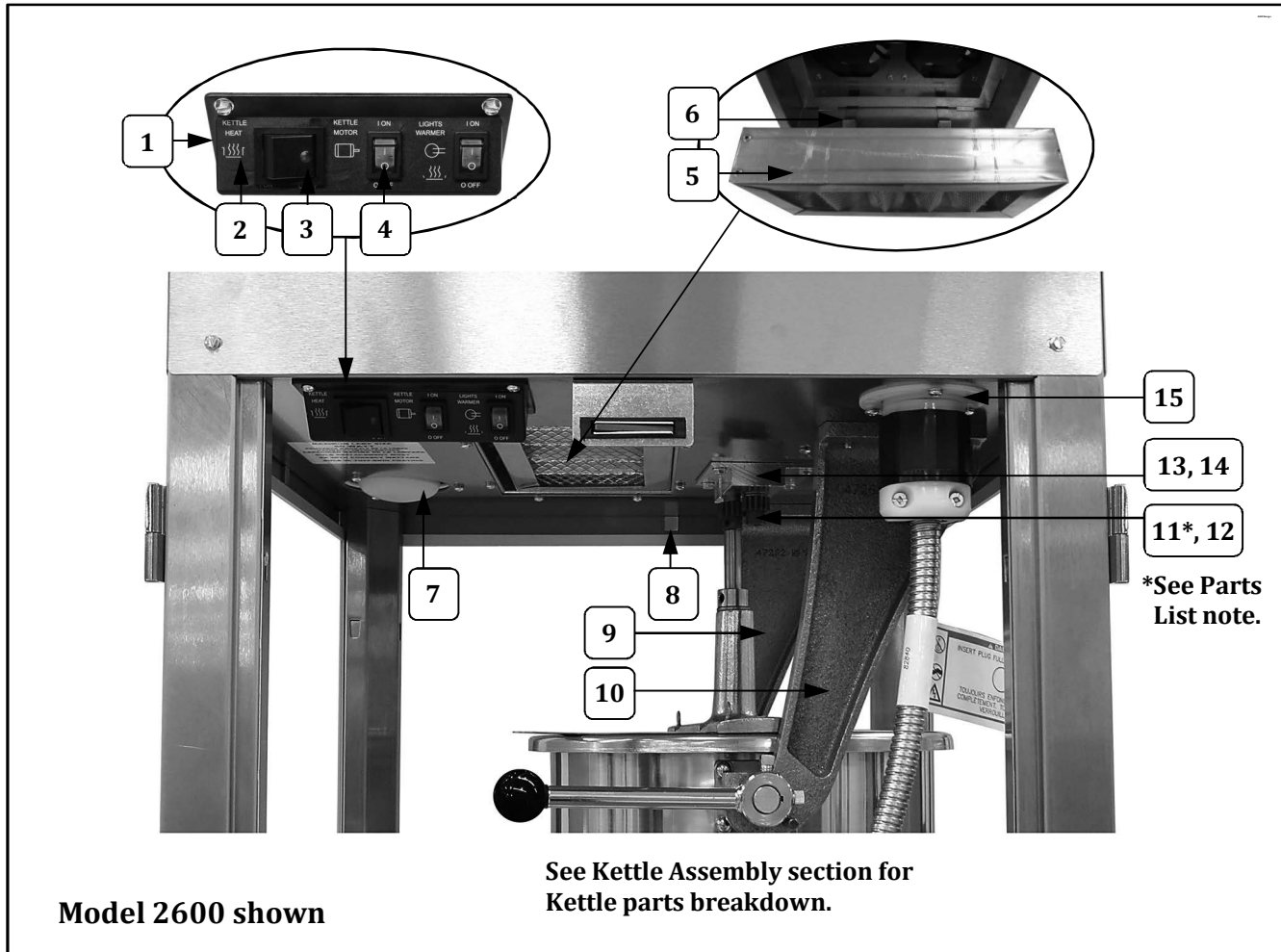

Item	Part Description	Part Number
		All Models
1	SWITCH BOX	48501
2	SWITCH LABEL	48502
3	GREEN LIGHTED ROCKER SWITCH	42798
4	DPST ROCKER SWITCH	42532
5	5 X 10 X 2 FILTER	69850
6	FILTER SPRING CLIP	62666
7	50 W FLOOD LIGHT COATED	42947
8	MAGNET .5X.5X.1 GLASS LOCK	51113
9	FRONT HANGER ARM	47262
10	REAR HANGER ARM	47263
11*	SPUR GEAR KIT (Includes 2 gears with set screws. Always replace Agitator Spur Gear and Kettle Drive Motor Gear as a set.)	47059K
12	10-32" X 3/16" SET SCREW	41742
13	GEAR BLOCK ASSEMBLY	67194
14	10-24 X 1 HEX MACH SCREW (fastens gear block assembly to kettle drive motor)	49322
15	KETTLE LEAD IN RECPT	47327

Cabinet Interior – Hanger Assembly/Controls View

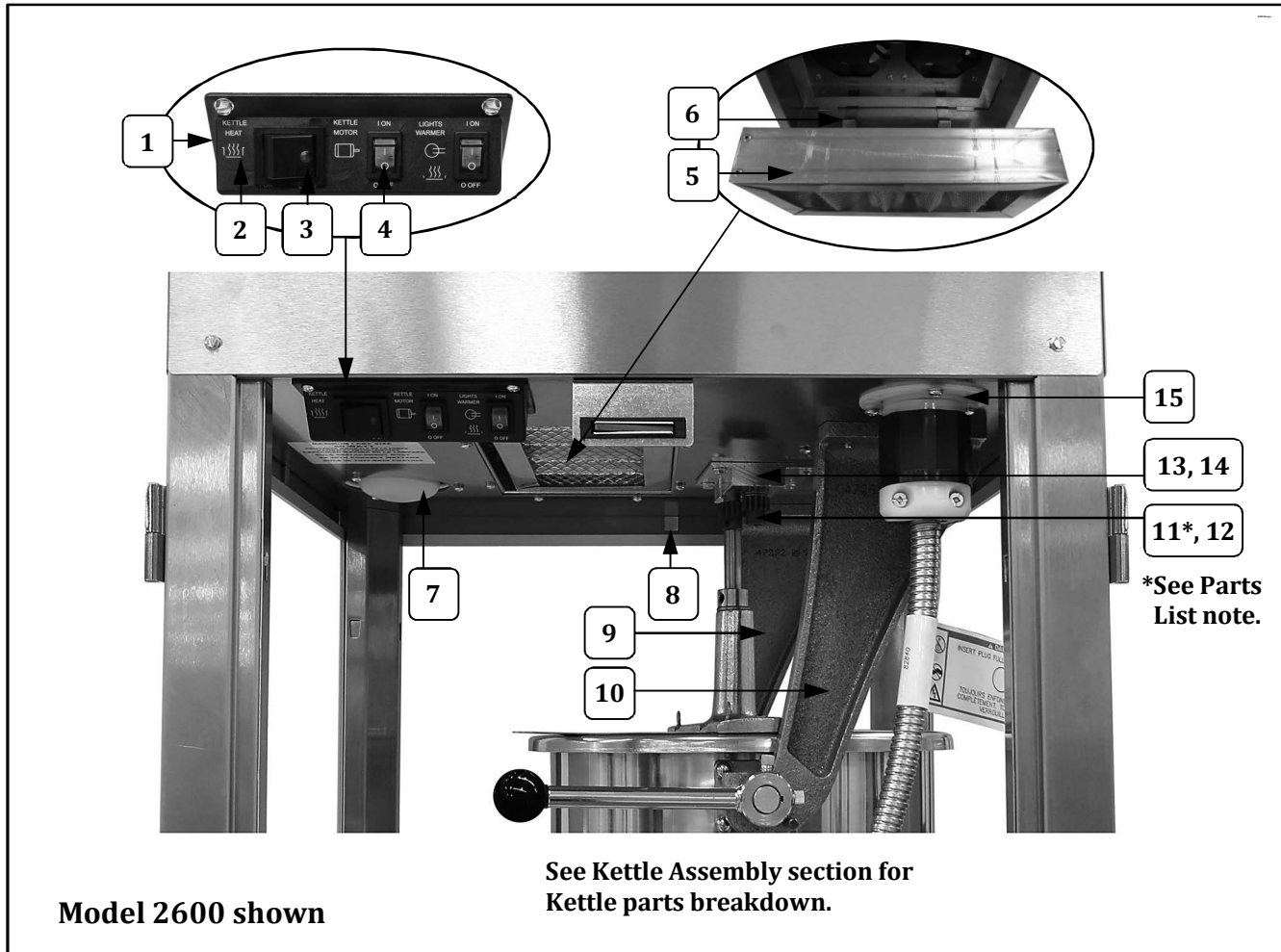

Item	Part Description	Part Number
		All Models
1	SWITCH BOX	48501
2	SWITCH LABEL	48502
3	GREEN LIGHTED ROCKER SWITCH	42798
4	DPST ROCKER SWITCH	42532
5	5 X 10 X 2 FILTER	69850
6	FILTER SPRING CLIP	62666
7	50 W FLOOD LIGHT COATED	42947
8	MAGNET .5X.5X.1 GLASS LOCK	51113
9	FRONT HANGER ARM	47262
10	REAR HANGER ARM	47263
11*	SPUR GEAR KIT (Includes 2 gears with set screws. Always replace Agitator Spur Gear and Kettle Drive Motor Gear as a set.)	47059K
12	10-32" X 3/16" SET SCREW	41742
13	GEAR BLOCK ASSEMBLY	67194
14	10-24 X 1 HEX MACH SCREW (fastens gear block assembly to kettle drive motor)	49322
15	KETTLE LEAD IN RECPT	47327

Cabinet Interior – Hanger Assembly/Controls View

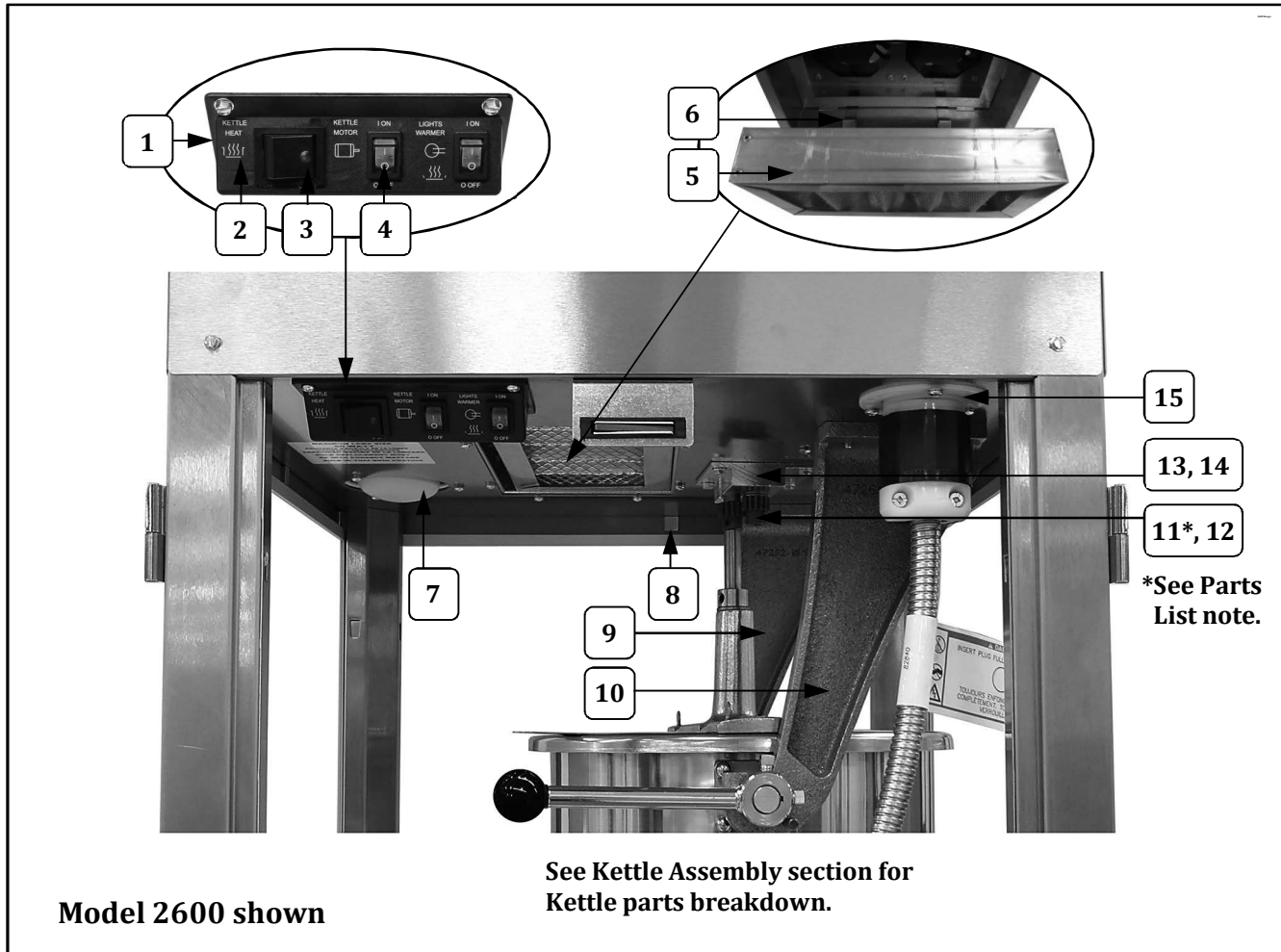

Item	Part Description	Part Number
		All Models
1	SWITCH BOX	48501
2	SWITCH LABEL	48502
3	GREEN LIGHTED ROCKER SWITCH	42798
4	DPST ROCKER SWITCH	42532
5	5 X 10 X 2 FILTER	69850
6	FILTER SPRING CLIP	62666
7	50 W FLOOD LIGHT COATED	42947
8	MAGNET .5X.5X.1 GLASS LOCK	51113
9	FRONT HANGER ARM	47262
10	REAR HANGER ARM	47263
11*	SPUR GEAR KIT (Includes 2 gears with set screws. Always replace Agitator Spur Gear and Kettle Drive Motor Gear as a set.)	47059K
12	10-32" X 3/16" SET SCREW	41742
13	GEAR BLOCK ASSEMBLY	67194
14	10-24 X 1 HEX MACH SCREW (fastens gear block assembly to kettle drive motor)	49322
15	KETTLE LEAD IN RECPT	47327

Cabinet Interior – Hanger Assembly/Controls View

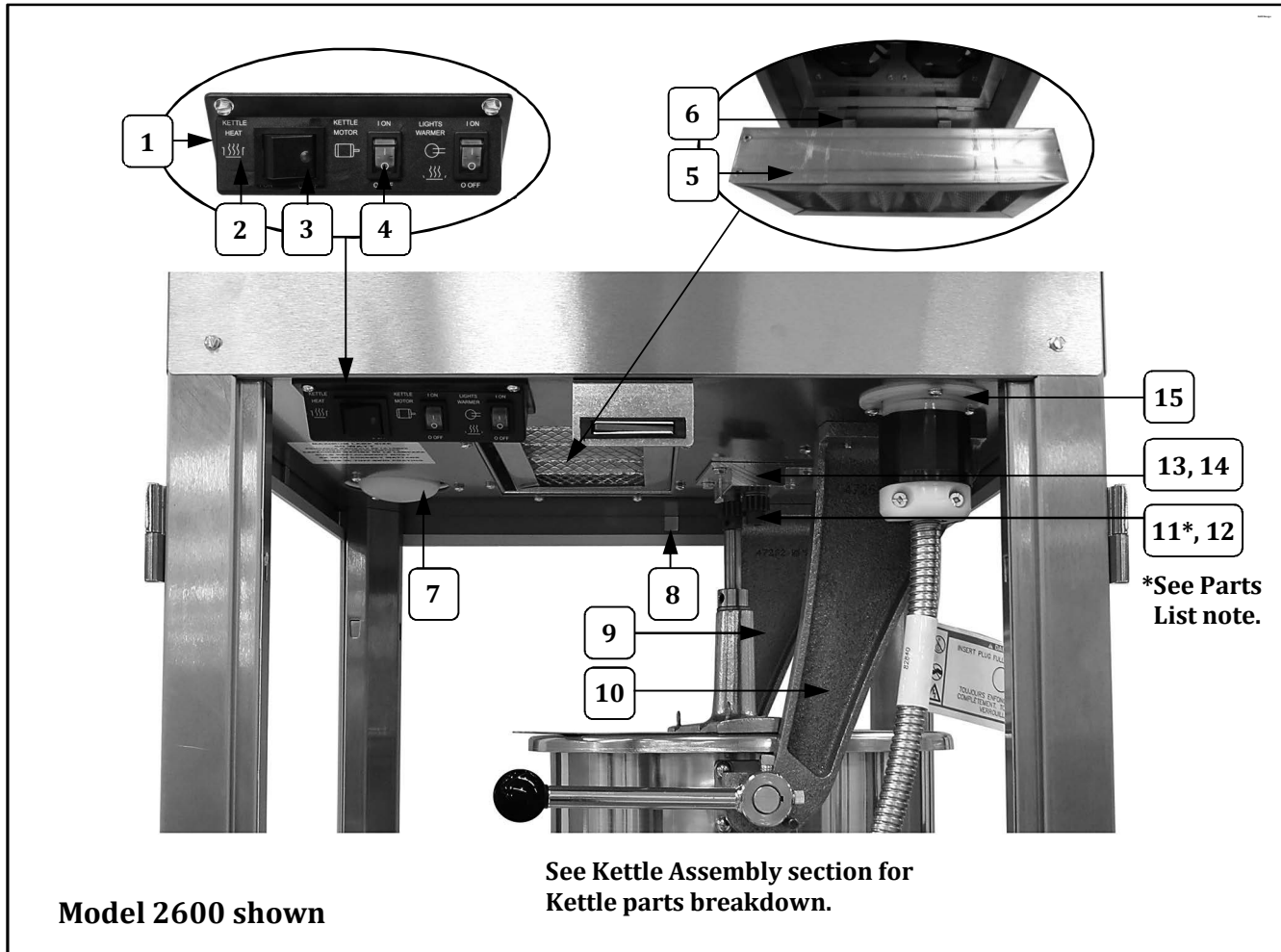

Item	Part Description	Part Number
		All Models
1	SWITCH BOX	48501
2	SWITCH LABEL	48502
3	GREEN LIGHTED ROCKER SWITCH	42798
4	DPST ROCKER SWITCH	42532
5	5 X 10 X 2 FILTER	69850
6	FILTER SPRING CLIP	62666
7	50 W FLOOD LIGHT COATED	42947
8	MAGNET .5X.5X.1 GLASS LOCK	51113
9	FRONT HANGER ARM	47262
10	REAR HANGER ARM	47263
11*	SPUR GEAR KIT (Includes 2 gears with set screws. Always replace Agitator Spur Gear and Kettle Drive Motor Gear as a set.)	47059K
12	10-32" X 3/16" SET SCREW	41742
13	GEAR BLOCK ASSEMBLY	67194
14	10-24 X 1 HEX MACH SCREW (fastens gear block assembly to kettle drive motor)	49322
15	KETTLE LEAD IN RECPT	47327

Cabinet Interior – Hanger Assembly/Controls View

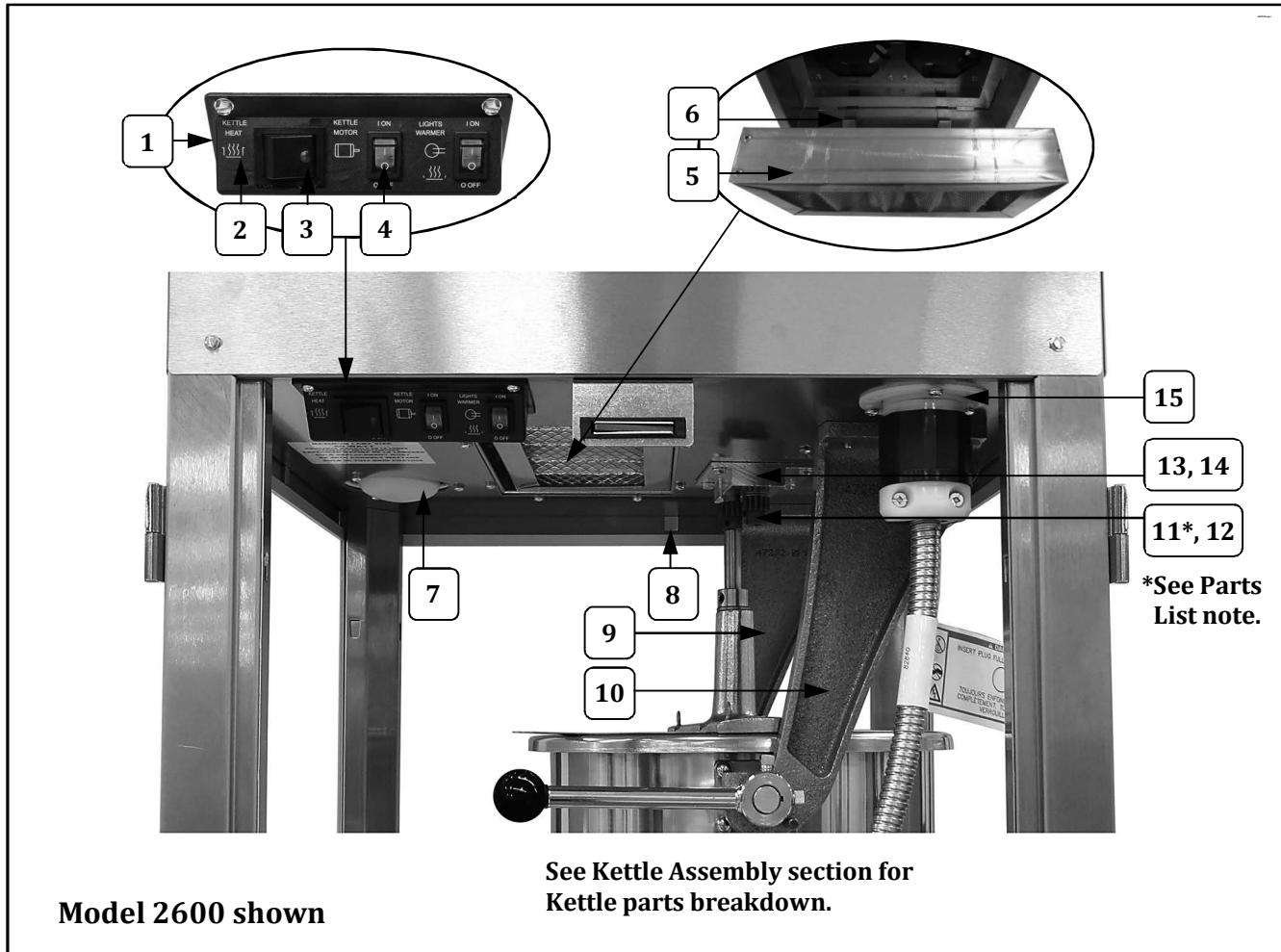

Item	Part Description	Part Number
		All Models
1	SWITCH BOX	48501
2	SWITCH LABEL	48502
3	GREEN LIGHTED ROCKER SWITCH	42798
4	DPST ROCKER SWITCH	42532
5	5 X 10 X 2 FILTER	69850
6	FILTER SPRING CLIP	62666
7	50 W FLOOD LIGHT COATED	42947
8	MAGNET .5X.5X.1 GLASS LOCK	51113
9	FRONT HANGER ARM	47262
10	REAR HANGER ARM	47263
11*	SPUR GEAR KIT (Includes 2 gears with set screws. Always replace Agitator Spur Gear and Kettle Drive Motor Gear as a set.)	47059K
12	10-32" X 3/16" SET SCREW	41742
13	GEAR BLOCK ASSEMBLY	67194
14	10-24 X 1 HEX MACH SCREW (fastens gear block assembly to kettle drive motor)	49322
15	KETTLE LEAD IN RECPT	47327

Cabinet Interior – Hanger Assembly/Controls View

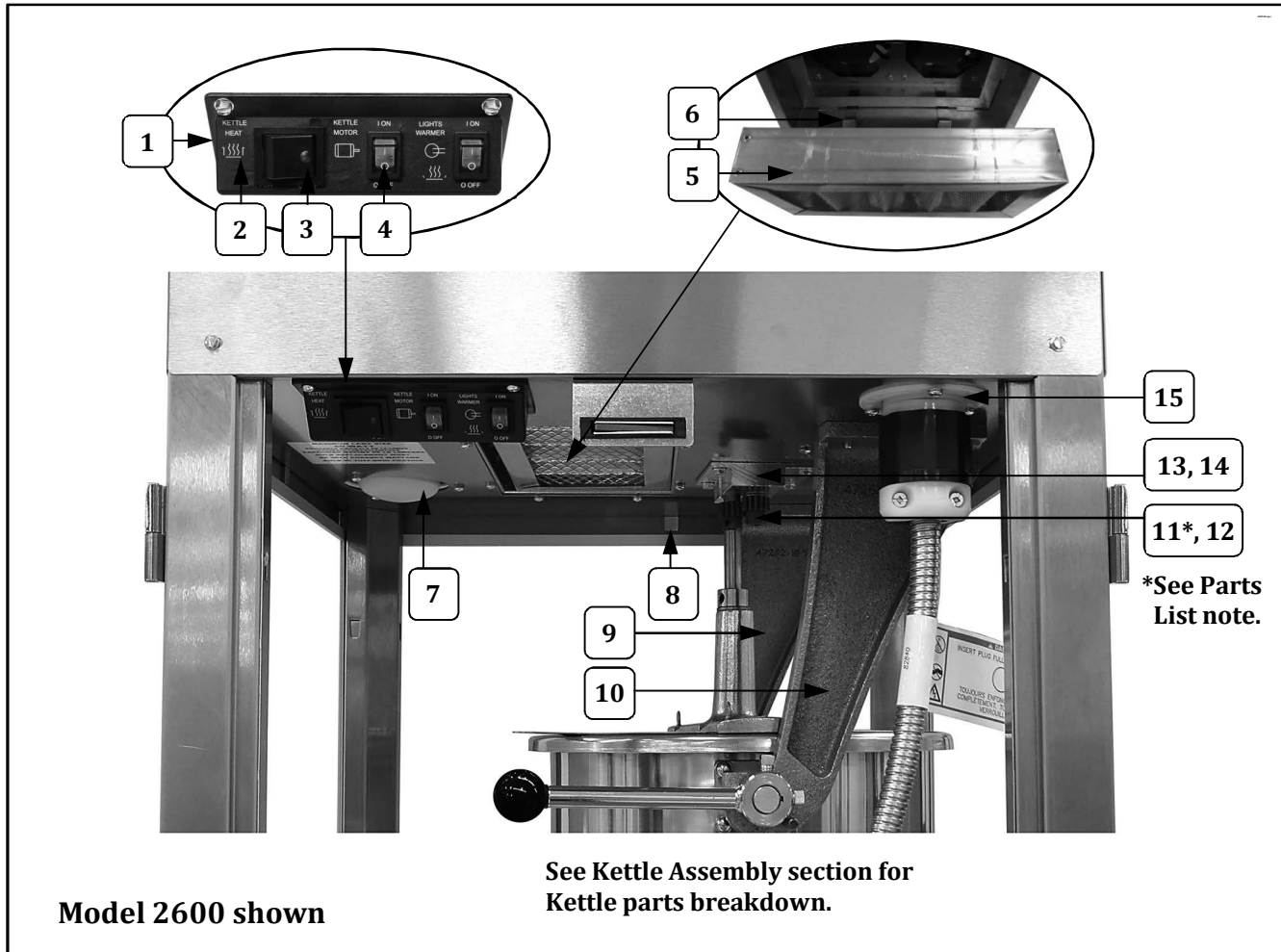

Item	Part Description	Part Number
		All Models
1	SWITCH BOX	48501
2	SWITCH LABEL	48502
3	GREEN LIGHTED ROCKER SWITCH	42798
4	DPST ROCKER SWITCH	42532
5	5 X 10 X 2 FILTER	69850
6	FILTER SPRING CLIP	62666
7	50 W FLOOD LIGHT COATED	42947
8	MAGNET .5X.5X.1 GLASS LOCK	51113
9	FRONT HANGER ARM	47262
10	REAR HANGER ARM	47263
11*	SPUR GEAR KIT (Includes 2 gears with set screws. Always replace Agitator Spur Gear and Kettle Drive Motor Gear as a set.)	47059K
12	10-32" X 3/16" SET SCREW	41742
13	GEAR BLOCK ASSEMBLY	67194
14	10-24 X 1 HEX MACH SCREW (fastens gear block assembly to kettle drive motor)	49322
15	KETTLE LEAD IN RECPT	47327

Cabinet Interior – Bottom View

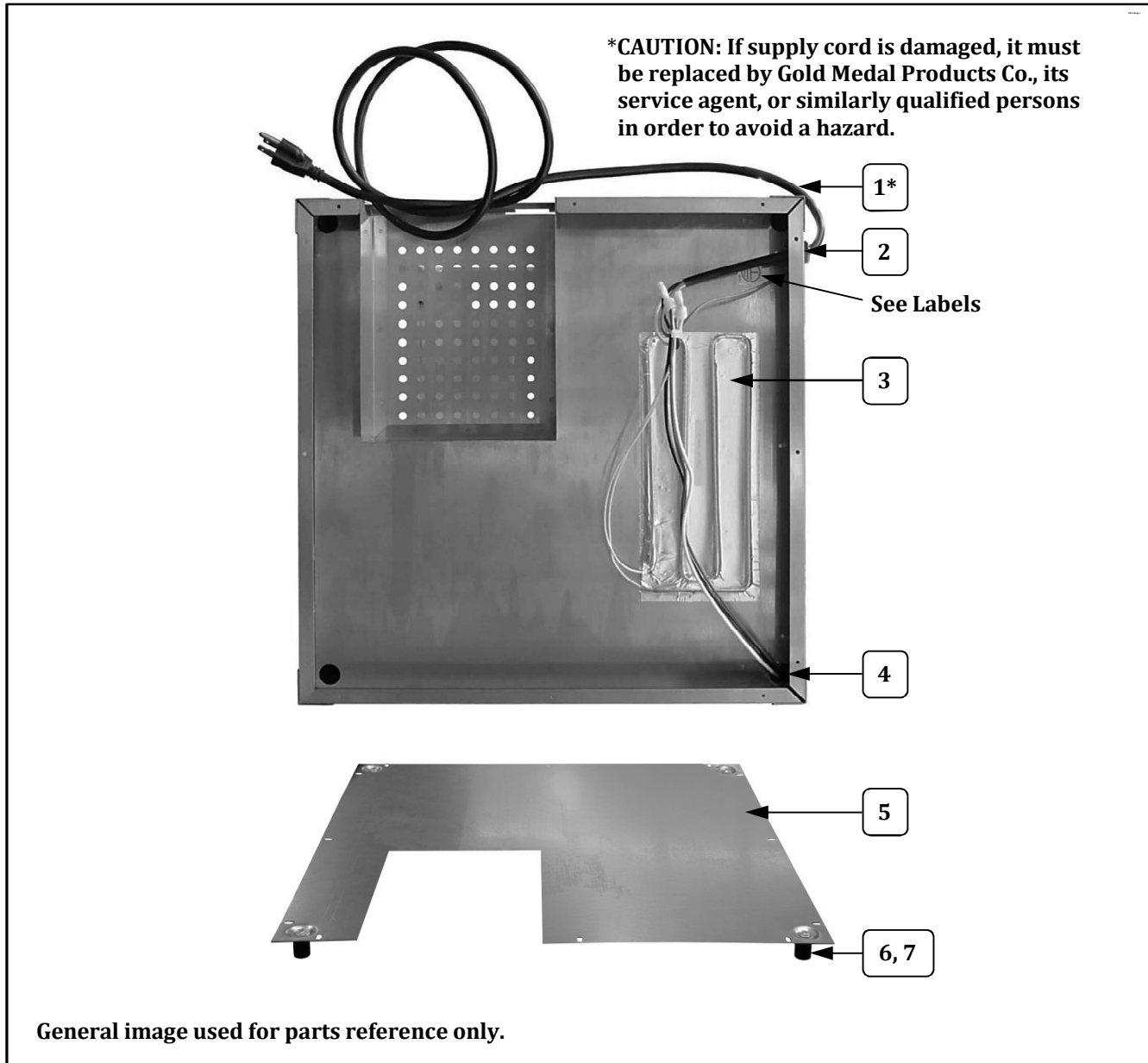

Item	Part Description	Part Number
		All Models
1	LEAD IN CORD 15 AMP PLUG	87085
2	STRAIN RELIEF	67060
3	120 VOLT FOIL HEATER	40557
4	.875 SNAP BUSHING	45396
5	BOTTOM COVER	49838
6	GLIDE	47328
7	10-24 X 3/4 HEX HD	41314

Cabinet Interior – Bottom View

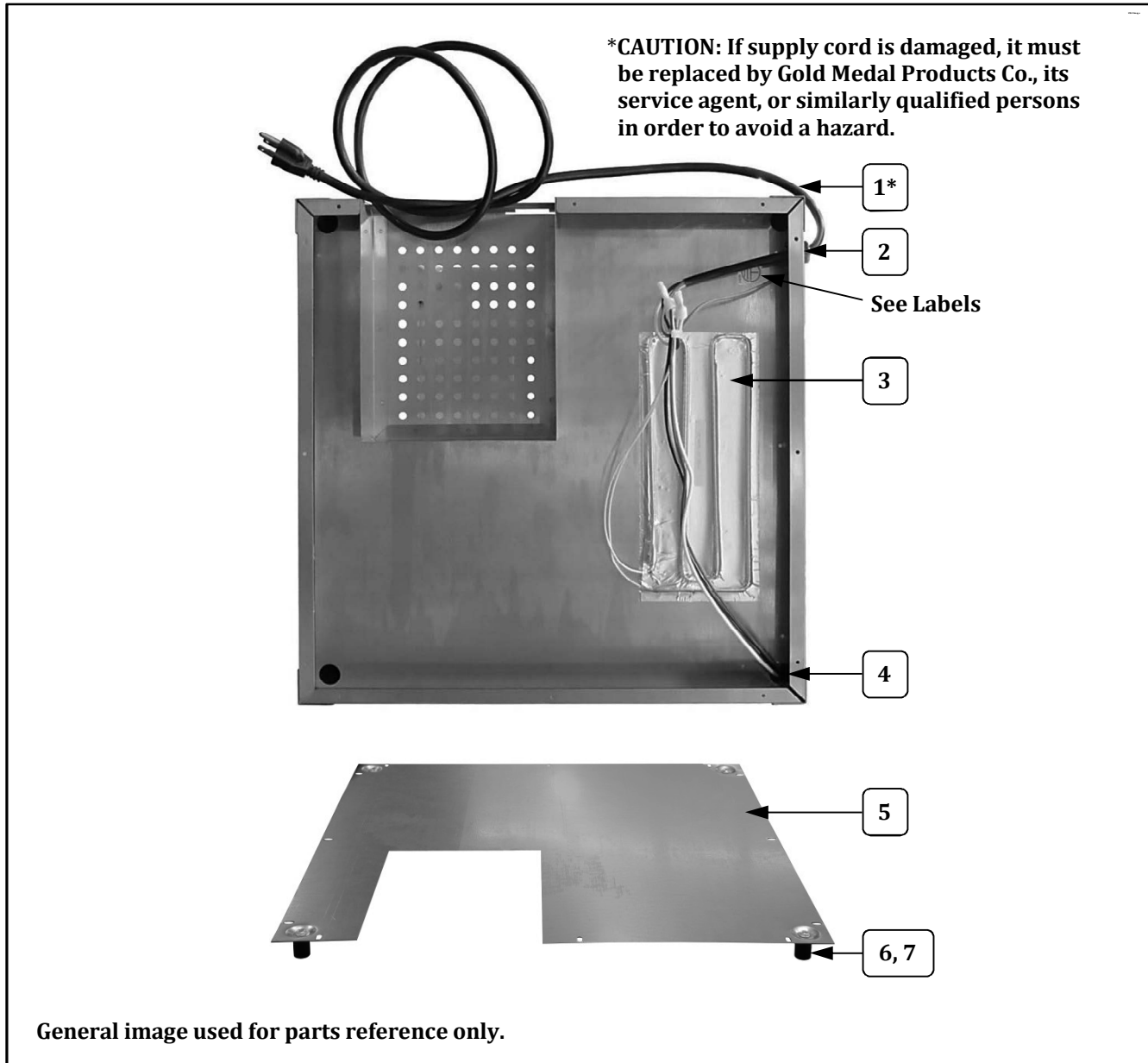

Item	Part Description	Part Number
		All Models
1	LEAD IN CORD 15 AMP PLUG	87085
2	STRAIN RELIEF	67060
3	120 VOLT FOIL HEATER	40557
4	.875 SNAP BUSHING	45396
5	BOTTOM COVER	49838
6	GLIDE	47328
7	10-24 X 3/4 HEX HD	41314

Cabinet Interior – Bottom View

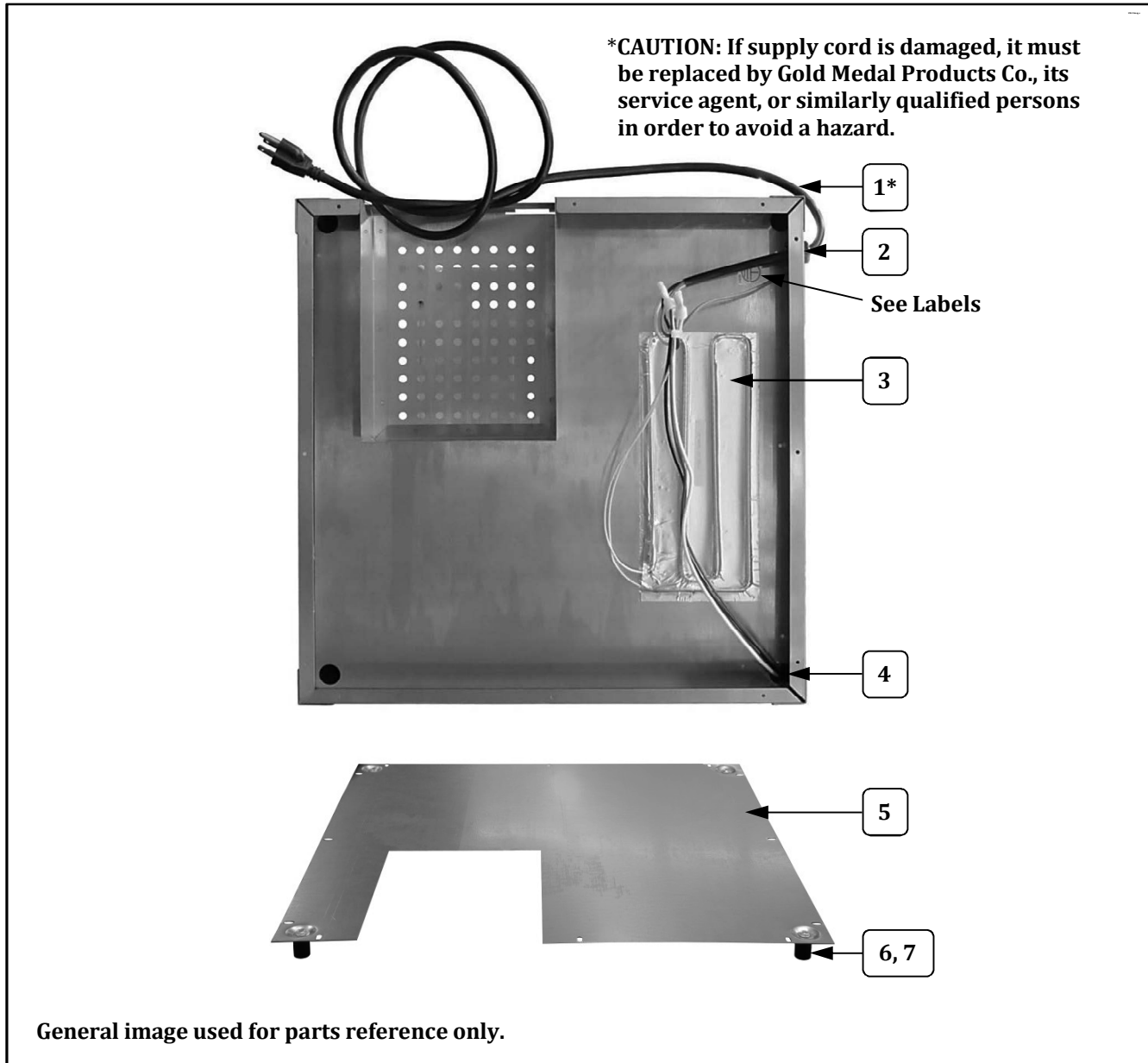

Item	Part Description	Part Number
		All Models
1	LEAD IN CORD 15 AMP PLUG	87085
2	STRAIN RELIEF	67060
3	120 VOLT FOIL HEATER	40557
4	.875 SNAP BUSHING	45396
5	BOTTOM COVER	49838
6	GLIDE	47328
7	10-24 X 3/4 HEX HD	41314

Cabinet Interior – Bottom View

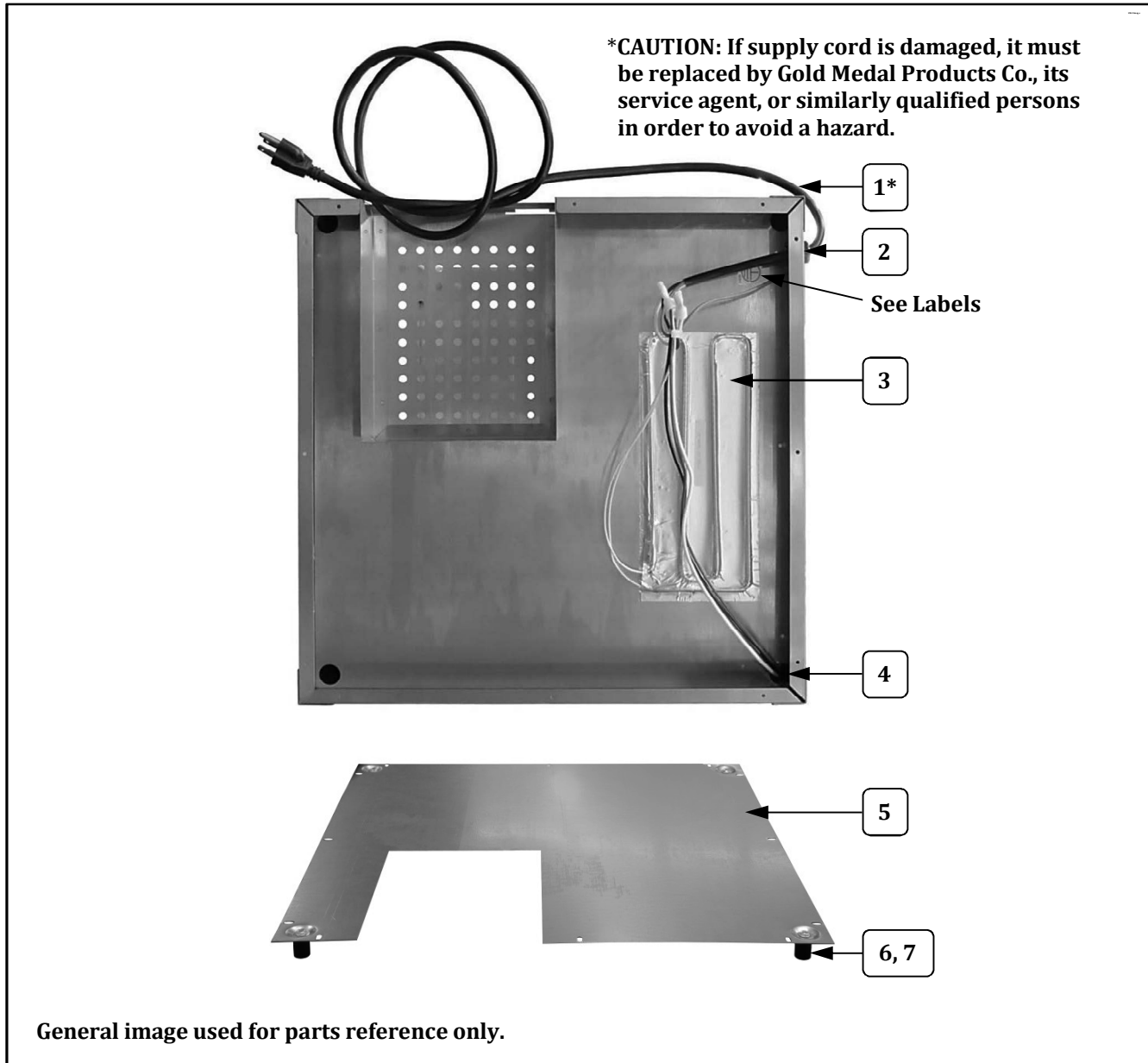

Item	Part Description	Part Number
		All Models
1	LEAD IN CORD 15 AMP PLUG	87085
2	STRAIN RELIEF	67060
3	120 VOLT FOIL HEATER	40557
4	.875 SNAP BUSHING	45396
5	BOTTOM COVER	49838
6	GLIDE	47328
7	10-24 X 3/4 HEX HD	41314

Cabinet Interior – Bottom View

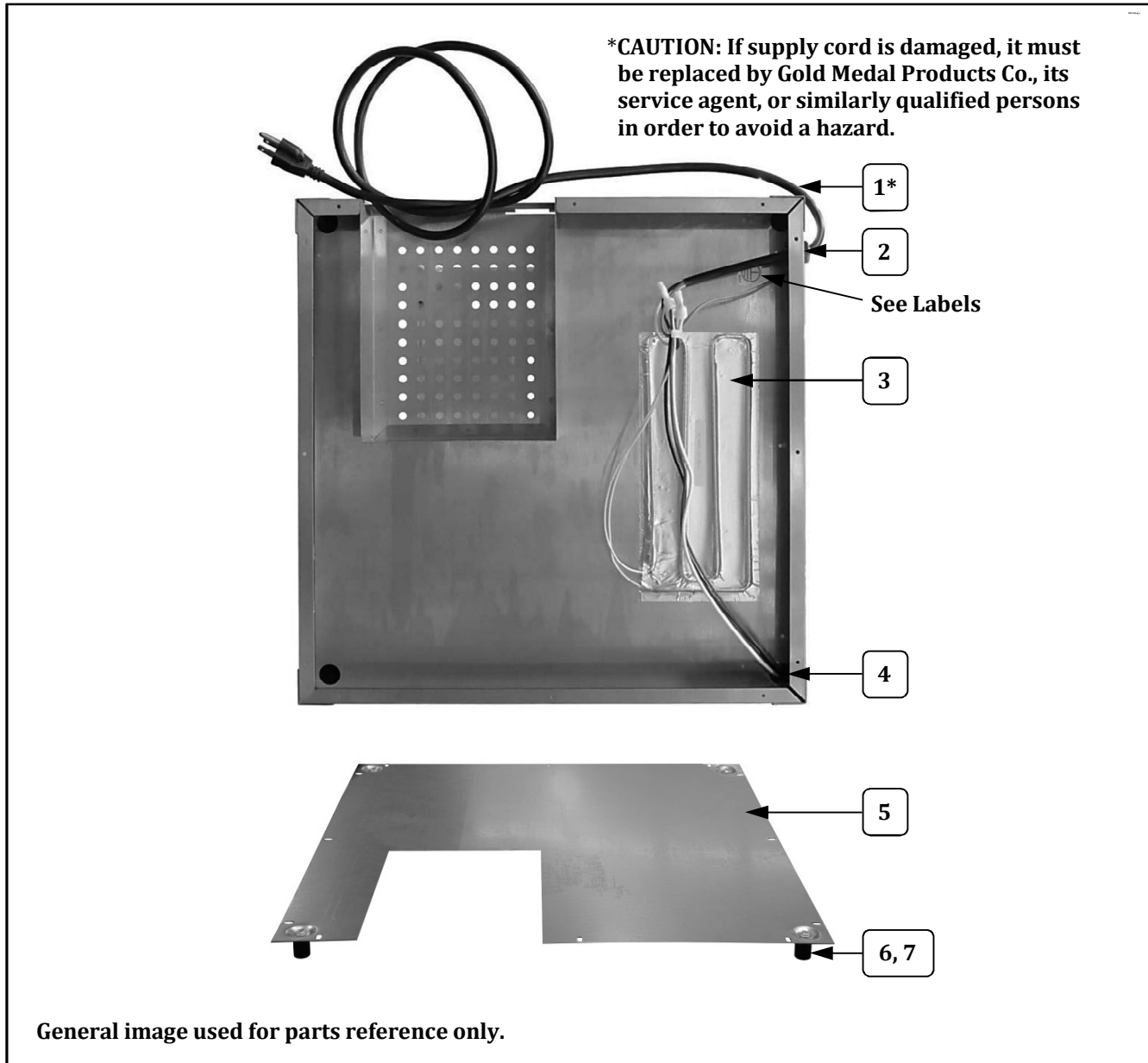

Item	Part Description	Part Number
		All Models
1	LEAD IN CORD 15 AMP PLUG	87085
2	STRAIN RELIEF	67060
3	120 VOLT FOIL HEATER	40557
4	.875 SNAP BUSHING	45396
5	BOTTOM COVER	49838
6	GLIDE	47328
7	10-24 X 3/4 HEX HD	41314

Cabinet Interior – Bottom View

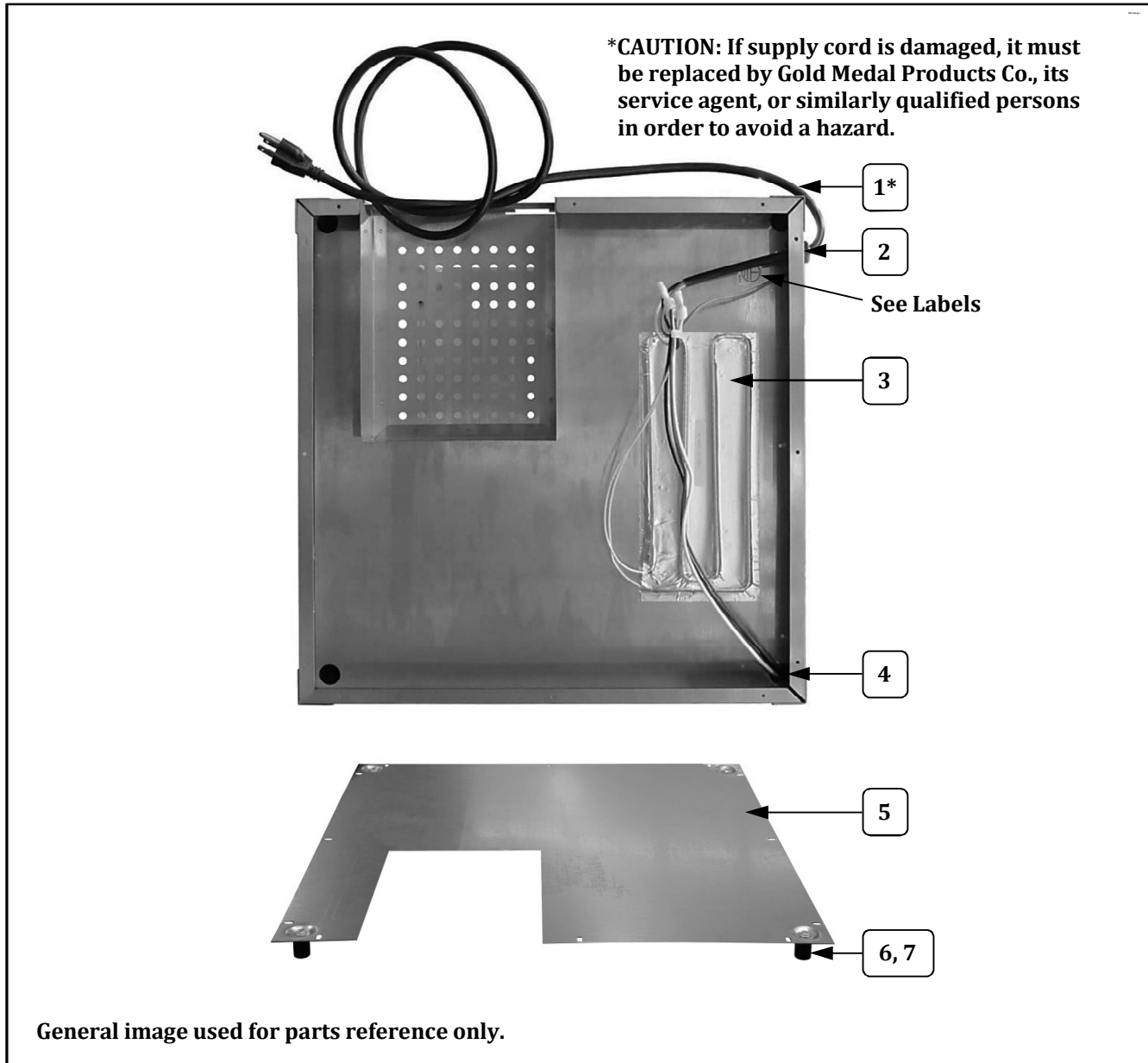

Item	Part Description	Part Number
		All Models
1	LEAD IN CORD 15 AMP PLUG	87085
2	STRAIN RELIEF	67060
3	120 VOLT FOIL HEATER	40557
4	.875 SNAP BUSHING	45396
5	BOTTOM COVER	49838
6	GLIDE	47328
7	10-24 X 3/4 HEX HD	41314

Cabinet Interior – Bottom View

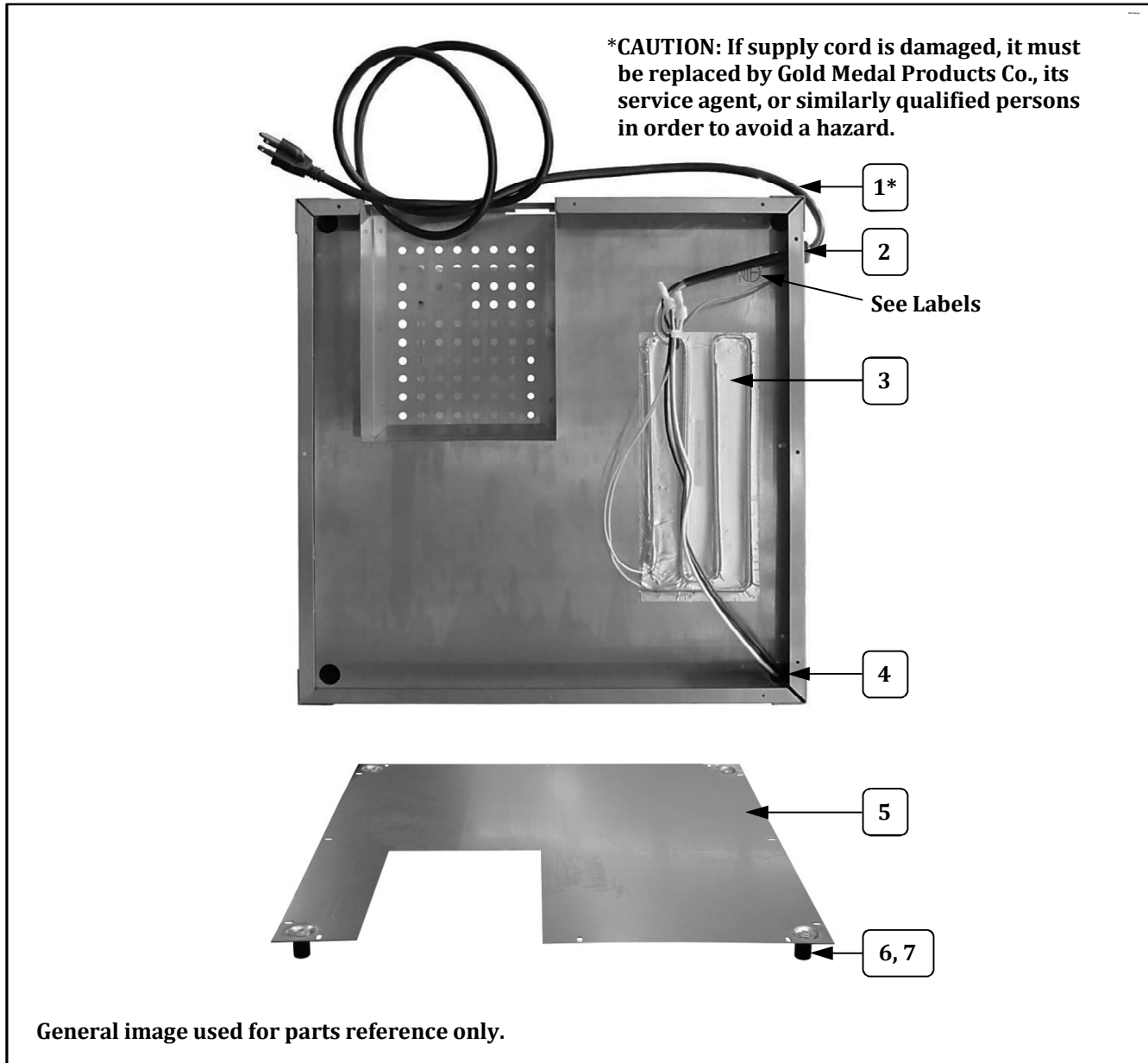

Item	Part Description	Part Number
		All Models
1	LEAD IN CORD 15 AMP PLUG	87085
2	STRAIN RELIEF	67060
3	120 VOLT FOIL HEATER	40557
4	.875 SNAP BUSHING	45396
5	BOTTOM COVER	49838
6	GLIDE	47328
7	10-24 X 3/4 HEX HD	41314

Dome Interior – Electrical Components

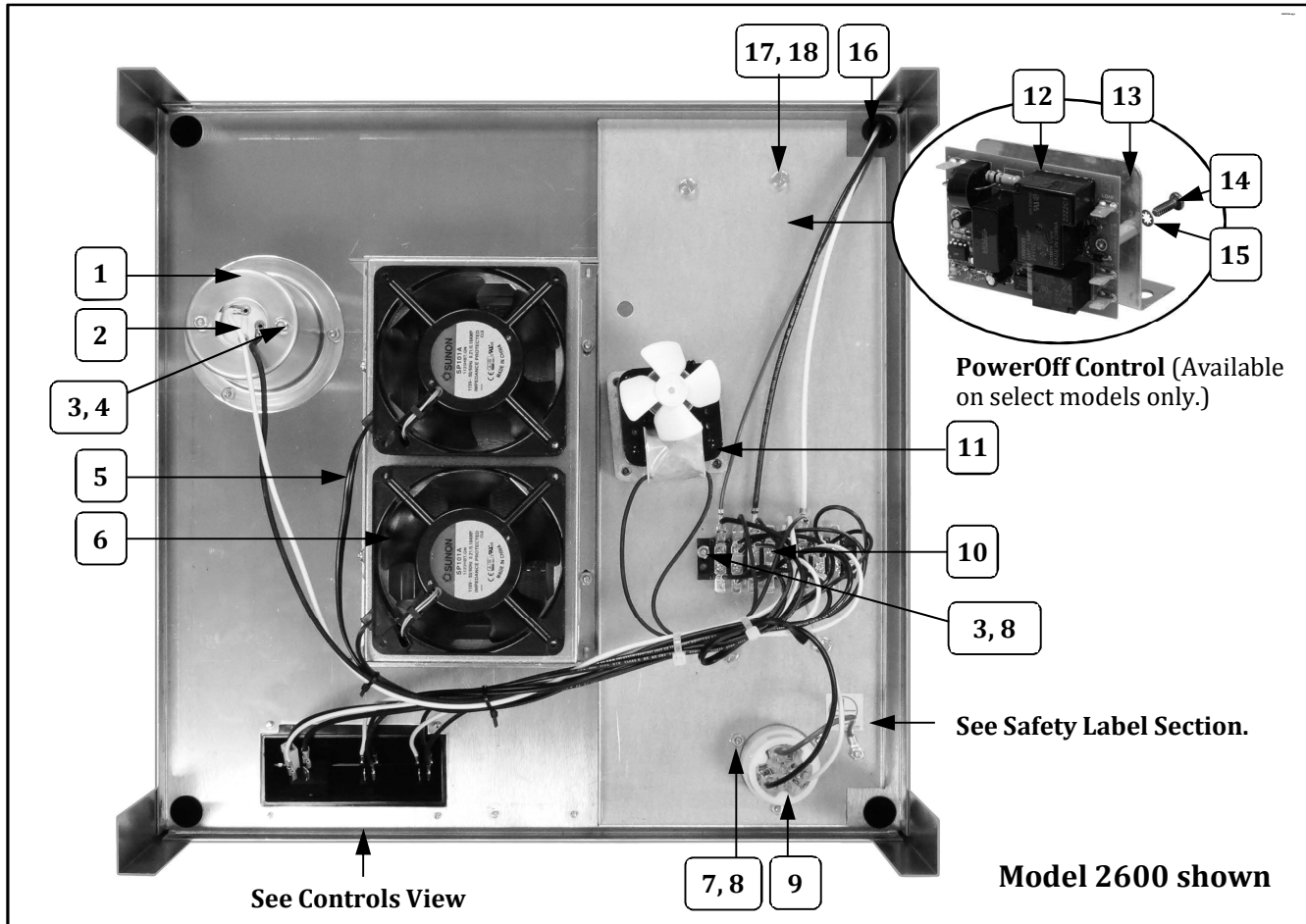

Item	Part Description	Part Number	
		2600, 2600-00-003, 2600-00-000	2600A
1	LIGHT SHIELD CONICAL	40589	40589
2	LAMP HOLDER	47047	47047
3	8-32 X 3/4 PHIL PAN MS SS	39007	39007
4	8-32 HEX NUT, ESLOK, S.S.	22070	22070
5	EXHST BLOWER PLUG & CORD	47199	47199
6	120V 60CY EXHAUST BLOWER	48018	48018
7	8-32 X 1/2 PH PAN W/SEMS	47124	47124
8	8-32 HEX M/S NUT	74149	74149
9	KETTLE LEAD IN RECPT	47327	47327
10	8 POS TERMINAL BLOCK	47208	47208
11	120V KETTLE DRIVE MOTOR	47038	47038
12	KETTLE POWEROFF CNTRL PCB		55402
13	BRACKET, POWEROFF CNTRL		55427
14	6-32 X 3/8 PHIL PAN M/S		39000
15	#6 INTERNAL TOOTH L/W 410SS		39001
16	.875 IN BUSHING, SNAP	45396	45396
17	1/4-20 X 3/4 GRADE 5 BOLT (fastens hanger arm)	74520	74520
18	MED SPLIT LOCK WASHER 1/4 (fastens hanger arm)	74526	74526

Dome Interior – Electrical Components

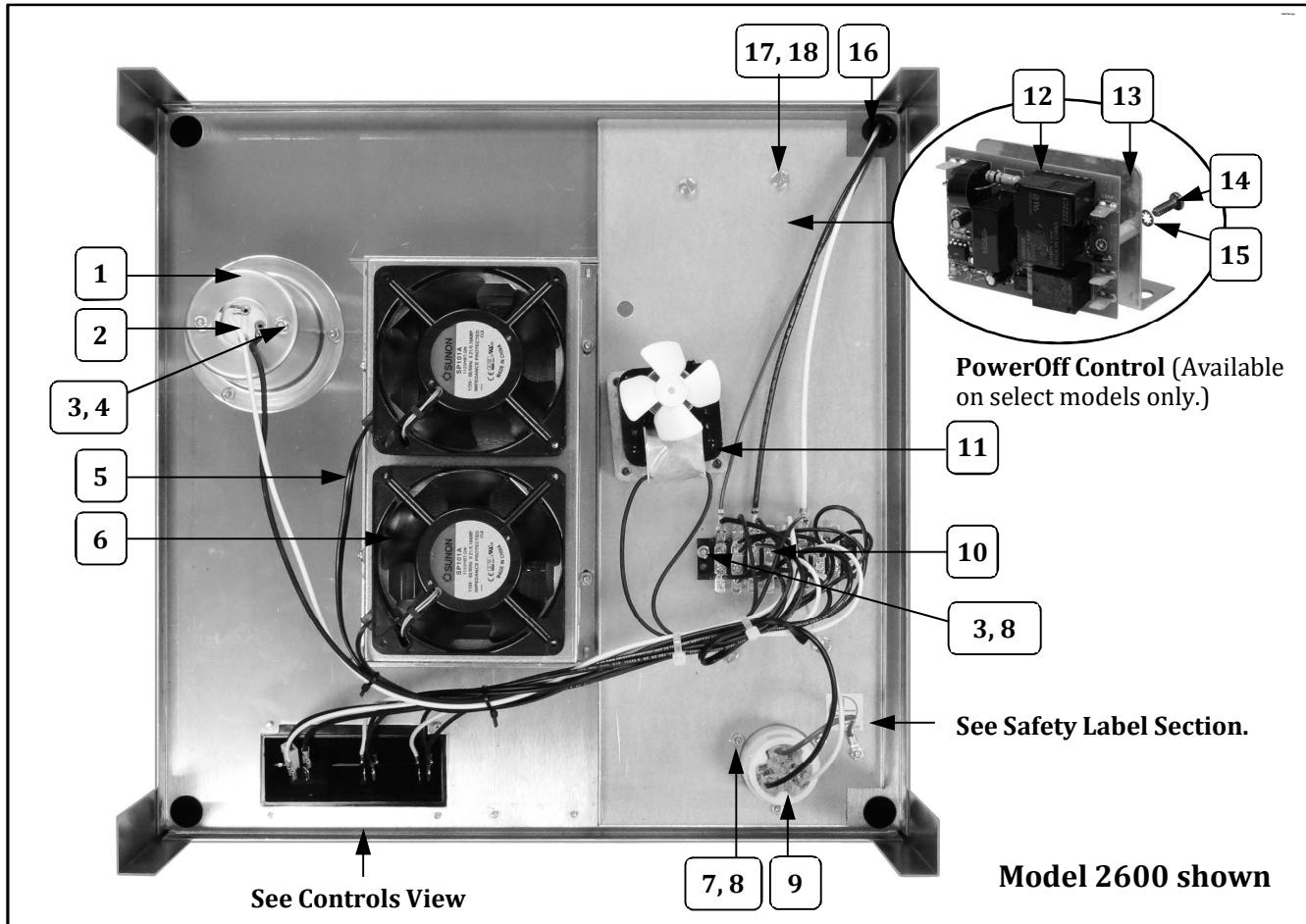

Item	Part Description	Part Number	
		2600, 2600-00-003, 2600-00-000	2600A
1	LIGHT SHIELD CONICAL	40589	40589
2	LAMP HOLDER	47047	47047
3	8-32 X 3/4 PHIL PAN MS SS	39007	39007
4	8-32 HEX NUT, ESLOK, S.S.	22070	22070
5	EXHST BLOWER PLUG & CORD	47199	47199
6	120V 60CY EXHAUST BLOWER	48018	48018
7	8-32 X 1/2 PH PAN W/SEMS	47124	47124
8	8-32 HEX M/S NUT	74149	74149
9	KETTLE LEAD IN RECPT	47327	47327
10	8 POS TERMINAL BLOCK	47208	47208
11	120V KETTLE DRIVE MOTOR	47038	47038
12	KETTLE POWEROFF CNTRL PCB		55402
13	BRACKET, POWEROFF CNTRL		55427
14	6-32 X 3/8 PHIL PAN M/S		39000
15	#6 INTERNAL TOOTH L/W 410SS		39001
16	.875 IN BUSHING, SNAP	45396	45396
17	1/4-20 X 3/4 GRADE 5 BOLT (fastens hanger arm)	74520	74520
18	MED SPLIT LOCK WASHER 1/4 (fastens hanger arm)	74526	74526

Dome Interior – Electrical Components

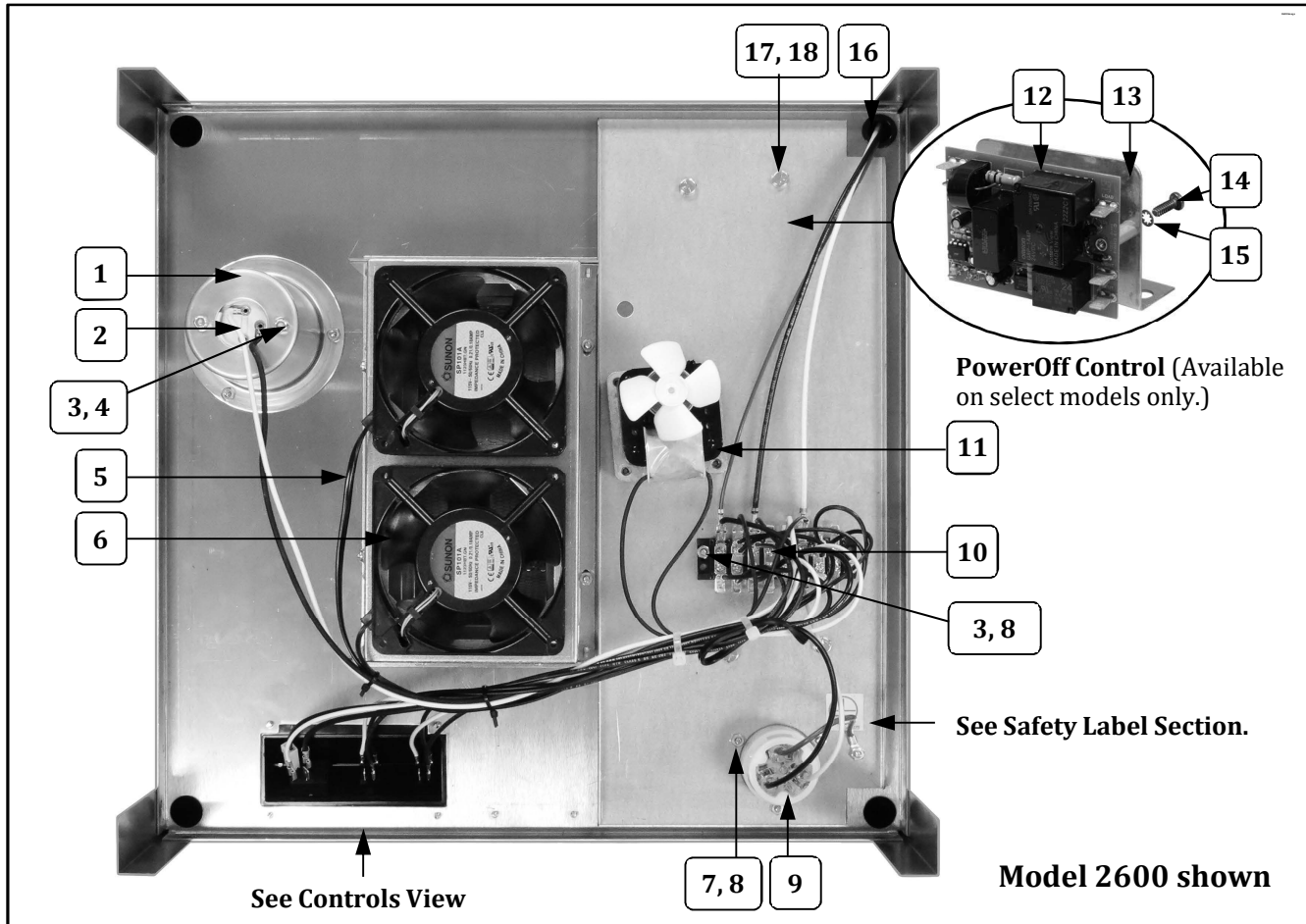

Item	Part Description	Part Number	
		2600, 2600-00-003, 2600-00-000	2600A
1	LIGHT SHIELD CONICAL	40589	40589
2	LAMP HOLDER	47047	47047
3	8-32 X 3/4 PHIL PAN MS SS	39007	39007
4	8-32 HEX NUT, ESLOK, S.S.	22070	22070
5	EXHST BLOWER PLUG & CORD	47199	47199
6	120V 60CY EXHAUST BLOWER	48018	48018
7	8-32 X 1/2 PH PAN W/SEMS	47124	47124
8	8-32 HEX M/S NUT	74149	74149
9	KETTLE LEAD IN RECPT	47327	47327
10	8 POS TERMINAL BLOCK	47208	47208
11	120V KETTLE DRIVE MOTOR	47038	47038
12	KETTLE POWEROFF CNTRL PCB		55402
13	BRACKET, POWEROFF CNTRL		55427
14	6-32 X 3/8 PHIL PAN M/S		39000
15	#6 INTERNAL TOOTH L/W 410SS		39001
16	.875 IN BUSHING, SNAP	45396	45396
17	1/4-20 X 3/4 GRADE 5 BOLT (fastens hanger arm)	74520	74520
18	MED SPLIT LOCK WASHER 1/4 (fastens hanger arm)	74526	74526

Dome Interior – Electrical Components

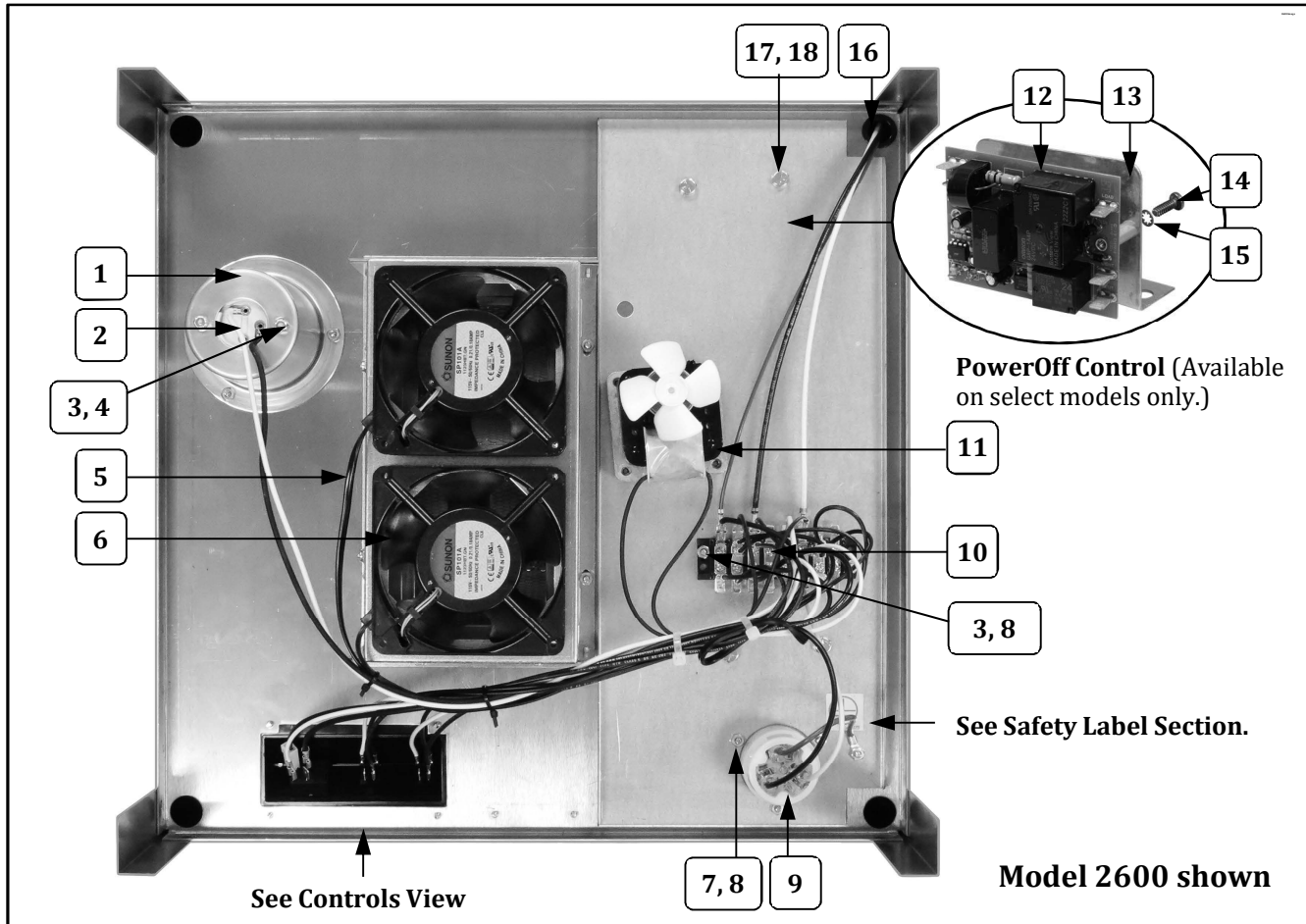

Item	Part Description	Part Number	
		2600, 2600-00-003, 2600-00-000	2600A
1	LIGHT SHIELD CONICAL	40589	40589
2	LAMP HOLDER	47047	47047
3	8-32 X 3/4 PHIL PAN MS SS	39007	39007
4	8-32 HEX NUT, ESLOK, S.S.	22070	22070
5	EXHST BLOWER PLUG & CORD	47199	47199
6	120V 60CY EXHAUST BLOWER	48018	48018
7	8-32 X 1/2 PH PAN W/SEMS	47124	47124
8	8-32 HEX M/S NUT	74149	74149
9	KETTLE LEAD IN RECPT	47327	47327
10	8 POS TERMINAL BLOCK	47208	47208
11	120V KETTLE DRIVE MOTOR	47038	47038
12	KETTLE POWEROFF CNTRL PCB		55402
13	BRACKET, POWEROFF CNTRL		55427
14	6-32 X 3/8 PHIL PAN M/S		39000
15	#6 INTERNAL TOOTH L/W 410SS		39001
16	.875 IN BUSHING, SNAP	45396	45396
17	1/4-20 X 3/4 GRADE 5 BOLT (fastens hanger arm)	74520	74520
18	MED SPLIT LOCK WASHER 1/4 (fastens hanger arm)	74526	74526

Dome Interior – Electrical Components

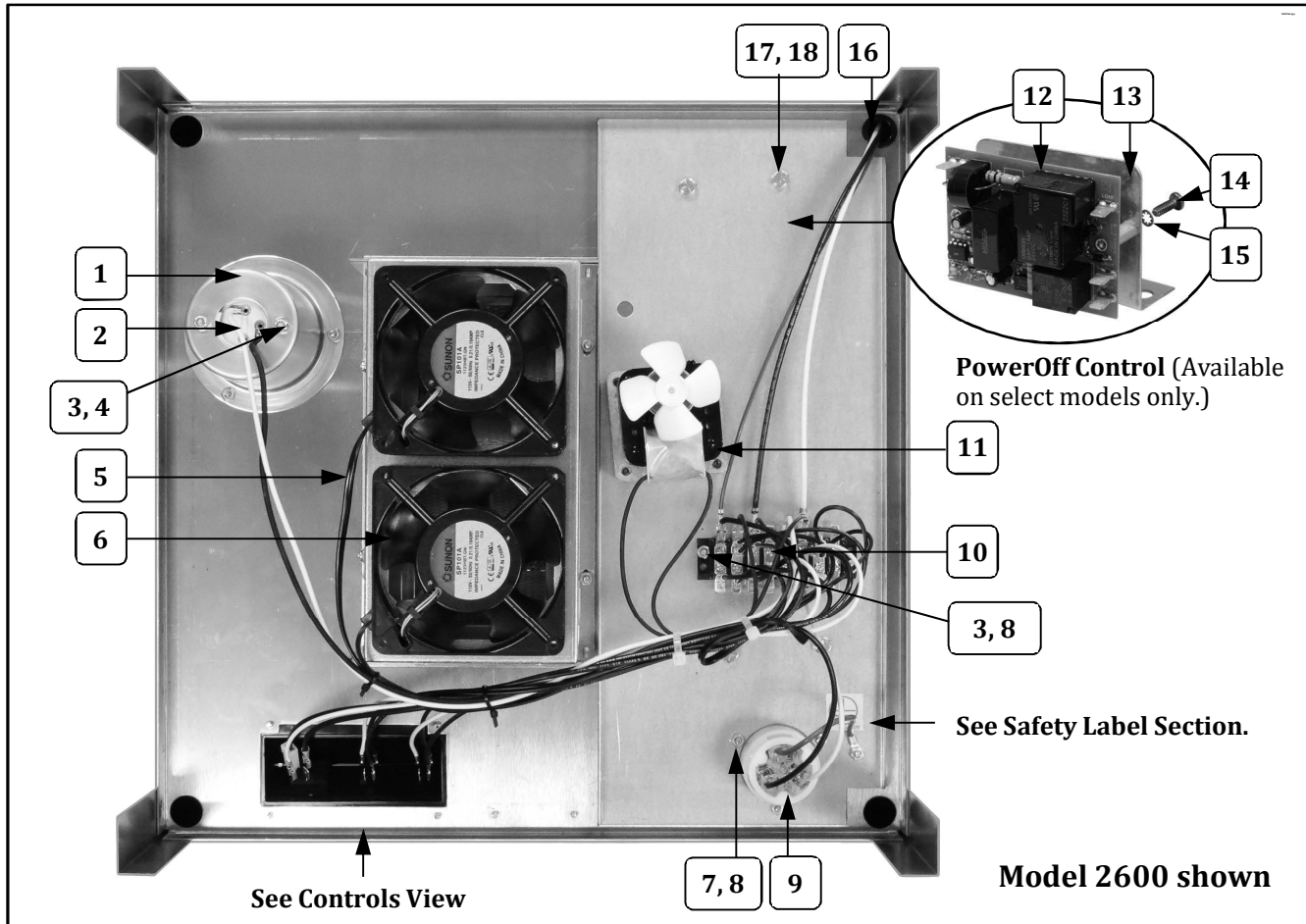

Item	Part Description	Part Number	
		2600, 2600-00-003, 2600-00-000	2600A
1	LIGHT SHIELD CONICAL	40589	40589
2	LAMP HOLDER	47047	47047
3	8-32 X 3/4 PHIL PAN MS SS	39007	39007
4	8-32 HEX NUT, ESLOK, S.S.	22070	22070
5	EXHST BLOWER PLUG & CORD	47199	47199
6	120V 60CY EXHAUST BLOWER	48018	48018
7	8-32 X 1/2 PH PAN W/SEMS	47124	47124
8	8-32 HEX M/S NUT	74149	74149
9	KETTLE LEAD IN RECPT	47327	47327
10	8 POS TERMINAL BLOCK	47208	47208
11	120V KETTLE DRIVE MOTOR	47038	47038
12	KETTLE POWEROFF CNTRL PCB		55402
13	BRACKET, POWEROFF CNTRL		55427
14	6-32 X 3/8 PHIL PAN M/S		39000
15	#6 INTERNAL TOOTH L/W 410SS		39001
16	.875 IN BUSHING, SNAP	45396	45396
17	1/4-20 X 3/4 GRADE 5 BOLT (fastens hanger arm)	74520	74520
18	MED SPLIT LOCK WASHER 1/4 (fastens hanger arm)	74526	74526

Dome Interior – Electrical Components

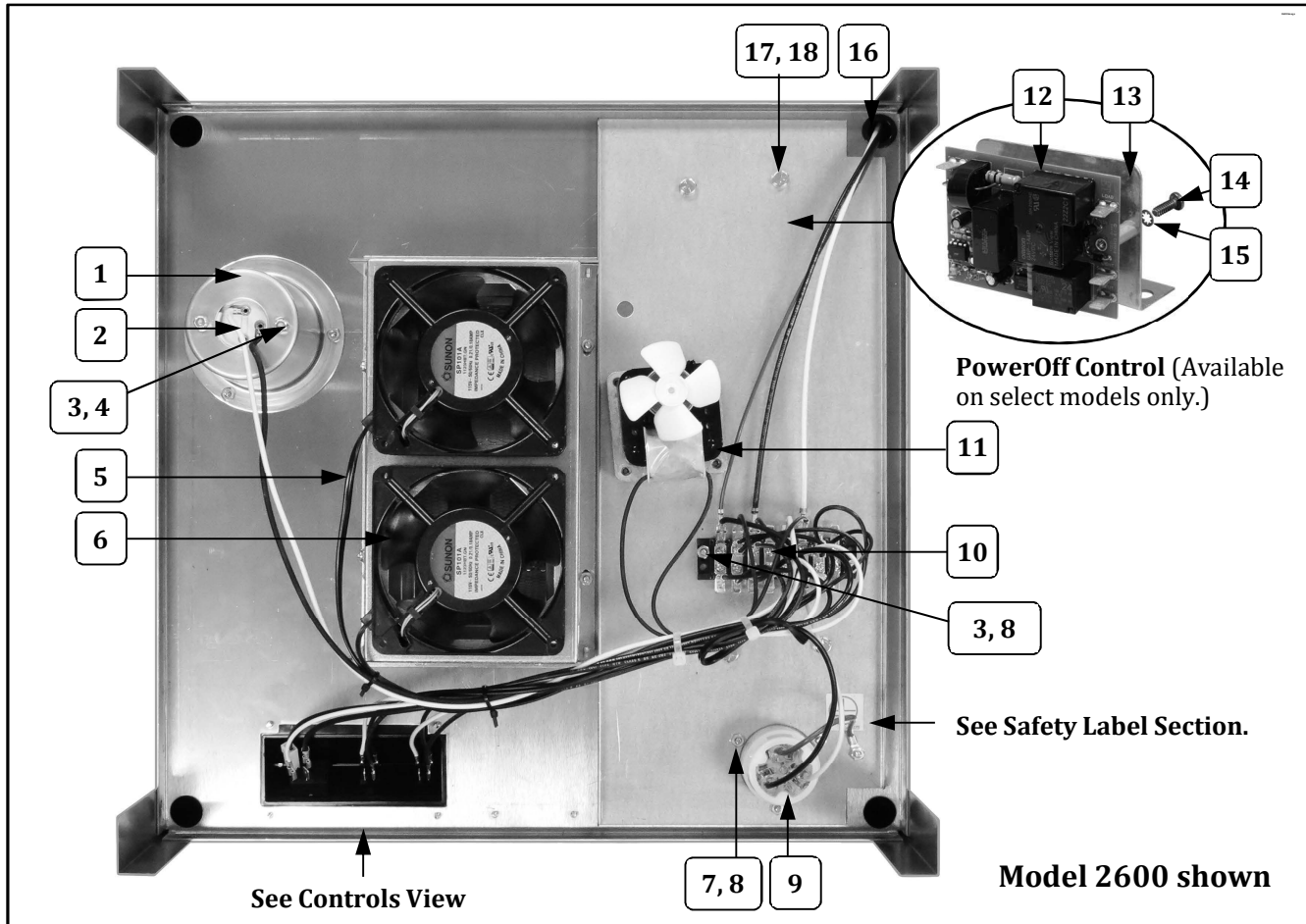

Item	Part Description	Part Number	
		2600, 2600-00-003, 2600-00-000	2600A
1	LIGHT SHIELD CONICAL	40589	40589
2	LAMP HOLDER	47047	47047
3	8-32 X 3/4 PHIL PAN MS SS	39007	39007
4	8-32 HEX NUT, ESLOK, S.S.	22070	22070
5	EXHST BLOWER PLUG & CORD	47199	47199
6	120V 60CY EXHAUST BLOWER	48018	48018
7	8-32 X 1/2 PH PAN W/SEMS	47124	47124
8	8-32 HEX M/S NUT	74149	74149
9	KETTLE LEAD IN RECPT	47327	47327
10	8 POS TERMINAL BLOCK	47208	47208
11	120V KETTLE DRIVE MOTOR	47038	47038
12	KETTLE POWEROFF CNTRL PCB		55402
13	BRACKET, POWEROFF CNTRL		55427
14	6-32 X 3/8 PHIL PAN M/S		39000
15	#6 INTERNAL TOOTH L/W 410SS		39001
16	.875 IN BUSHING, SNAP	45396	45396
17	1/4-20 X 3/4 GRADE 5 BOLT (fastens hanger arm)	74520	74520
18	MED SPLIT LOCK WASHER 1/4 (fastens hanger arm)	74526	74526

Dome Interior – Electrical Components

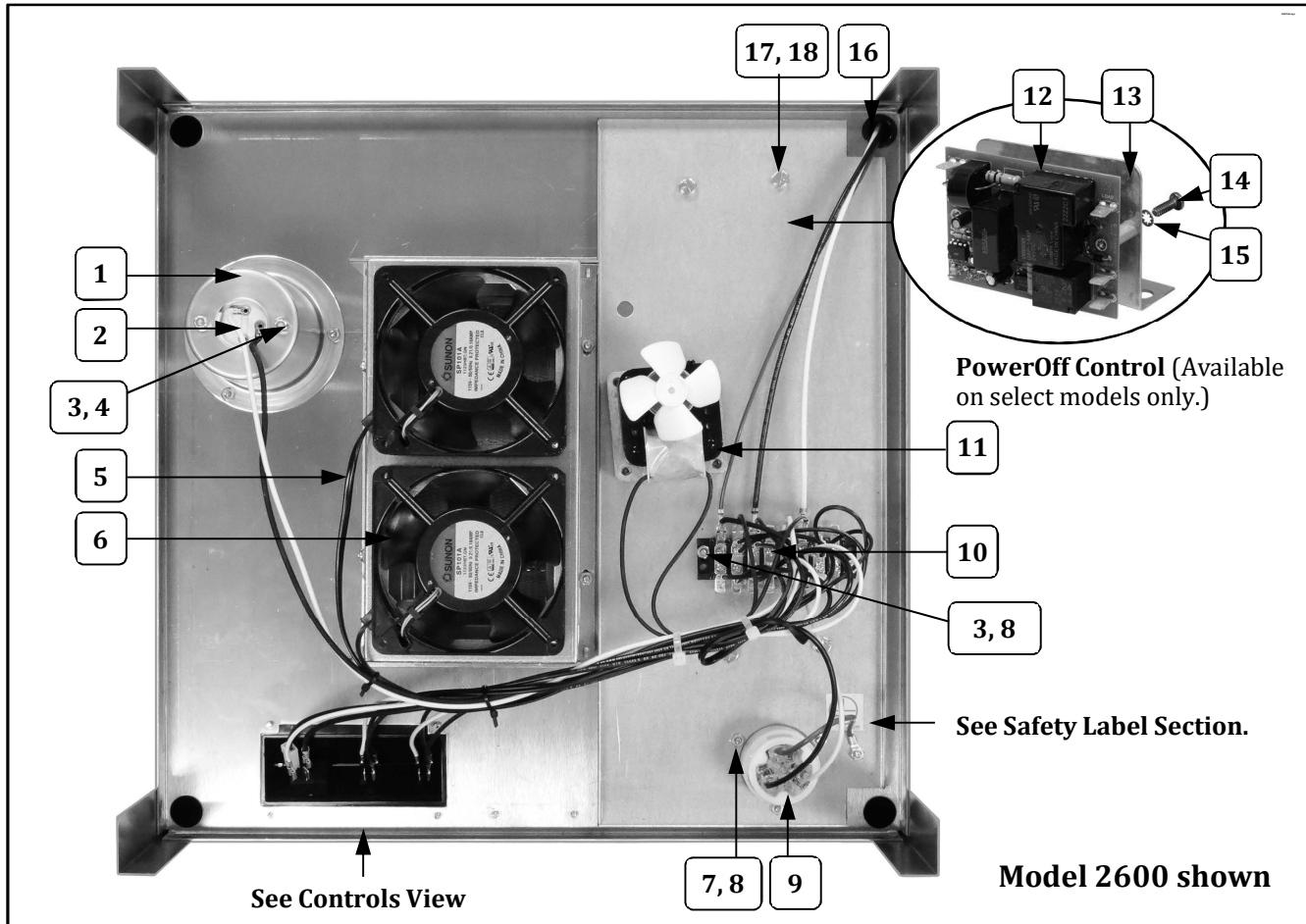

Item	Part Description	Part Number	
		2600, 2600-00-003, 2600-00-000	2600A
1	LIGHT SHIELD CONICAL	40589	40589
2	LAMP HOLDER	47047	47047
3	8-32 X 3/4 PHIL PAN MS SS	39007	39007
4	8-32 HEX NUT, ESLOK, S.S.	22070	22070
5	EXHST BLOWER PLUG & CORD	47199	47199
6	120V 60CY EXHAUST BLOWER	48018	48018
7	8-32 X 1/2 PH PAN W/SEMS	47124	47124
8	8-32 HEX M/S NUT	74149	74149
9	KETTLE LEAD IN RECPT	47327	47327
10	8 POS TERMINAL BLOCK	47208	47208
11	120V KETTLE DRIVE MOTOR	47038	47038
12	KETTLE POWEROFF CNTRL PCB		55402
13	BRACKET, POWEROFF CNTRL		55427
14	6-32 X 3/8 PHIL PAN M/S		39000
15	#6 INTERNAL TOOTH L/W 410SS		39001
16	.875 IN BUSHING, SNAP	45396	45396
17	1/4-20 X 3/4 GRADE 5 BOLT (fastens hanger arm)	74520	74520
18	MED SPLIT LOCK WASHER 1/4 (fastens hanger arm)	74526	74526

Dome Interior – Electrical Components

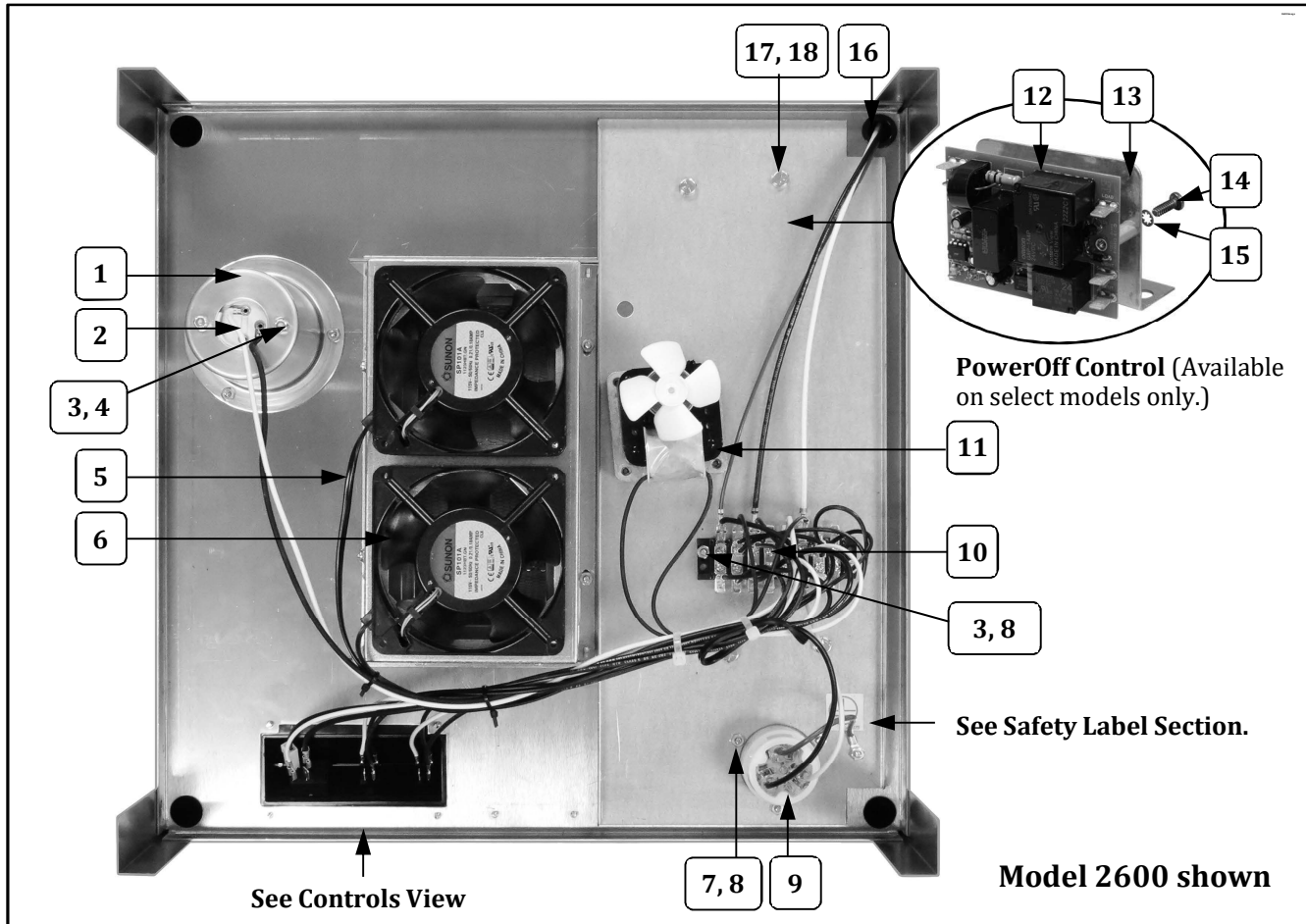

Item	Part Description	Part Number	
		2600, 2600-00-003, 2600-00-000	2600A
1	LIGHT SHIELD CONICAL	40589	40589
2	LAMP HOLDER	47047	47047
3	8-32 X 3/4 PHIL PAN MS SS	39007	39007
4	8-32 HEX NUT, ESLOK, S.S.	22070	22070
5	EXHST BLOWER PLUG & CORD	47199	47199
6	120V 60CY EXHAUST BLOWER	48018	48018
7	8-32 X 1/2 PH PAN W/SEMS	47124	47124
8	8-32 HEX M/S NUT	74149	74149
9	KETTLE LEAD IN RECPT	47327	47327
10	8 POS TERMINAL BLOCK	47208	47208
11	120V KETTLE DRIVE MOTOR	47038	47038
12	KETTLE POWEROFF CNTRL PCB		55402
13	BRACKET, POWEROFF CNTRL		55427
14	6-32 X 3/8 PHIL PAN M/S		39000
15	#6 INTERNAL TOOTH L/W 410SS		39001
16	.875 IN BUSHING, SNAP	45396	45396
17	1/4-20 X 3/4 GRADE 5 BOLT (fastens hanger arm)	74520	74520
18	MED SPLIT LOCK WASHER 1/4 (fastens hanger arm)	74526	74526

Dome Interior – Electrical Components

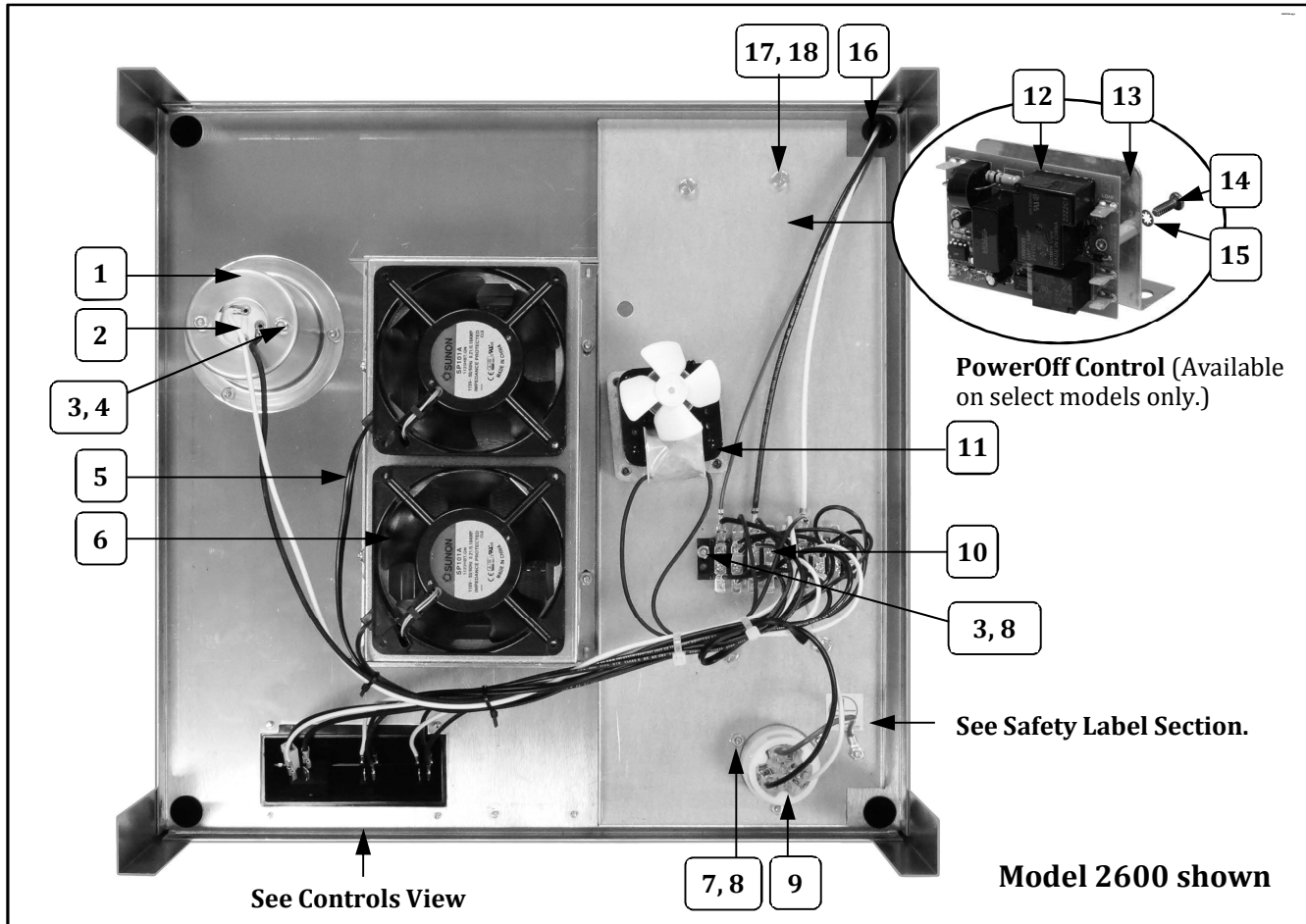

Item	Part Description	Part Number	
		2600, 2600-00-003, 2600-00-000	2600A
1	LIGHT SHIELD CONICAL	40589	40589
2	LAMP HOLDER	47047	47047
3	8-32 X 3/4 PHIL PAN MS SS	39007	39007
4	8-32 HEX NUT, ESLOK, S.S.	22070	22070
5	EXHST BLOWER PLUG & CORD	47199	47199
6	120V 60CY EXHAUST BLOWER	48018	48018
7	8-32 X 1/2 PH PAN W/SEMS	47124	47124
8	8-32 HEX M/S NUT	74149	74149
9	KETTLE LEAD IN RECPT	47327	47327
10	8 POS TERMINAL BLOCK	47208	47208
11	120V KETTLE DRIVE MOTOR	47038	47038
12	KETTLE POWEROFF CNTRL PCB		55402
13	BRACKET, POWEROFF CNTRL		55427
14	6-32 X 3/8 PHIL PAN M/S		39000
15	#6 INTERNAL TOOTH L/W 410SS		39001
16	.875 IN BUSHING, SNAP	45396	45396
17	1/4-20 X 3/4 GRADE 5 BOLT (fastens hanger arm)	74520	74520
18	MED SPLIT LOCK WASHER 1/4 (fastens hanger arm)	74526	74526

Dome Interior – Electrical Components

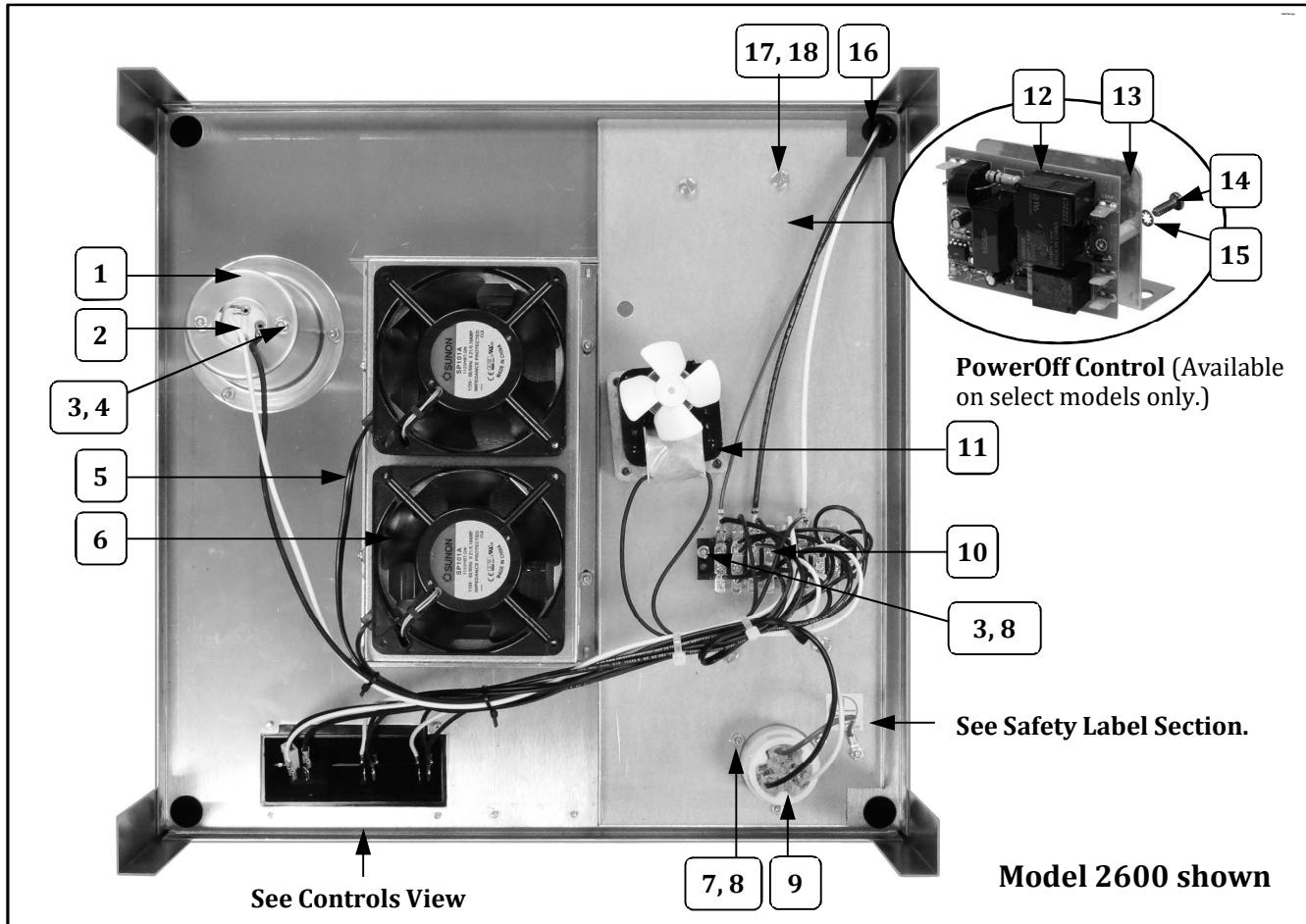

Item	Part Description	Part Number	
		2600, 2600-00-003, 2600-00-000	2600A
1	LIGHT SHIELD CONICAL	40589	40589
2	LAMP HOLDER	47047	47047
3	8-32 X 3/4 PHIL PAN MS SS	39007	39007
4	8-32 HEX NUT, ESLOK, S.S.	22070	22070
5	EXHST BLOWER PLUG & CORD	47199	47199
6	120V 60CY EXHAUST BLOWER	48018	48018
7	8-32 X 1/2 PH PAN W/SEMS	47124	47124
8	8-32 HEX M/S NUT	74149	74149
9	KETTLE LEAD IN RECPT	47327	47327
10	8 POS TERMINAL BLOCK	47208	47208
11	120V KETTLE DRIVE MOTOR	47038	47038
12	KETTLE POWEROFF CNTRL PCB		55402
13	BRACKET, POWEROFF CNTRL		55427
14	6-32 X 3/8 PHIL PAN M/S		39000
15	#6 INTERNAL TOOTH L/W 410SS		39001
16	.875 IN BUSHING, SNAP	45396	45396
17	1/4-20 X 3/4 GRADE 5 BOLT (fastens hanger arm)	74520	74520
18	MED SPLIT LOCK WASHER 1/4 (fastens hanger arm)	74526	74526

Dome Interior – Electrical Components

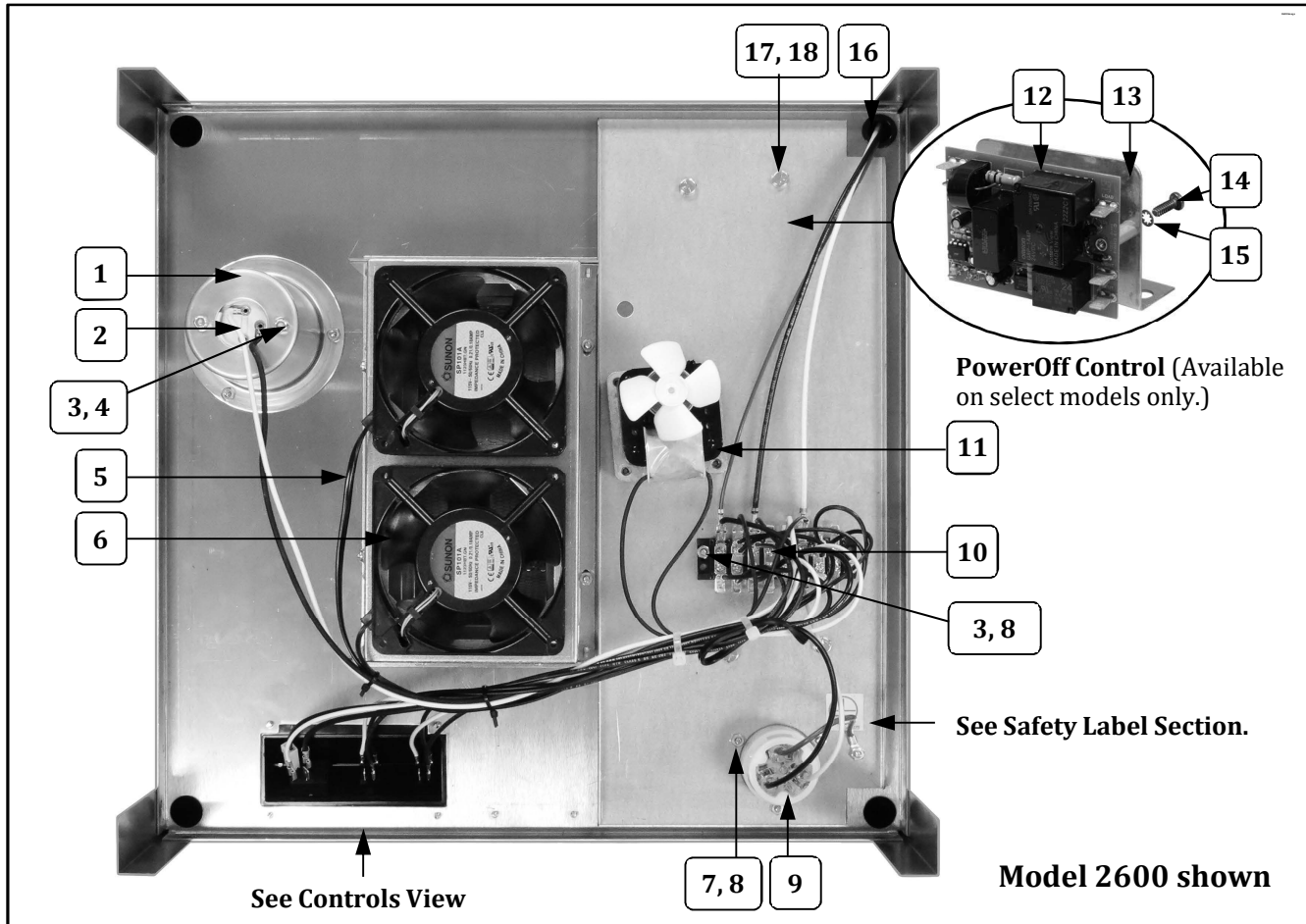

Item	Part Description	Part Number	
		2600, 2600-00-003, 2600-00-000	2600A
1	LIGHT SHIELD CONICAL	40589	40589
2	LAMP HOLDER	47047	47047
3	8-32 X 3/4 PHIL PAN MS SS	39007	39007
4	8-32 HEX NUT, ESLOK, S.S.	22070	22070
5	EXHST BLOWER PLUG & CORD	47199	47199
6	120V 60CY EXHAUST BLOWER	48018	48018
7	8-32 X 1/2 PH PAN W/SEMS	47124	47124
8	8-32 HEX M/S NUT	74149	74149
9	KETTLE LEAD IN RECPT	47327	47327
10	8 POS TERMINAL BLOCK	47208	47208
11	120V KETTLE DRIVE MOTOR	47038	47038
12	KETTLE POWEROFF CNTRL PCB		55402
13	BRACKET, POWEROFF CNTRL		55427
14	6-32 X 3/8 PHIL PAN M/S		39000
15	#6 INTERNAL TOOTH L/W 410SS		39001
16	.875 IN BUSHING, SNAP	45396	45396
17	1/4-20 X 3/4 GRADE 5 BOLT (fastens hanger arm)	74520	74520
18	MED SPLIT LOCK WASHER 1/4 (fastens hanger arm)	74526	74526

Dome Interior – Electrical Components

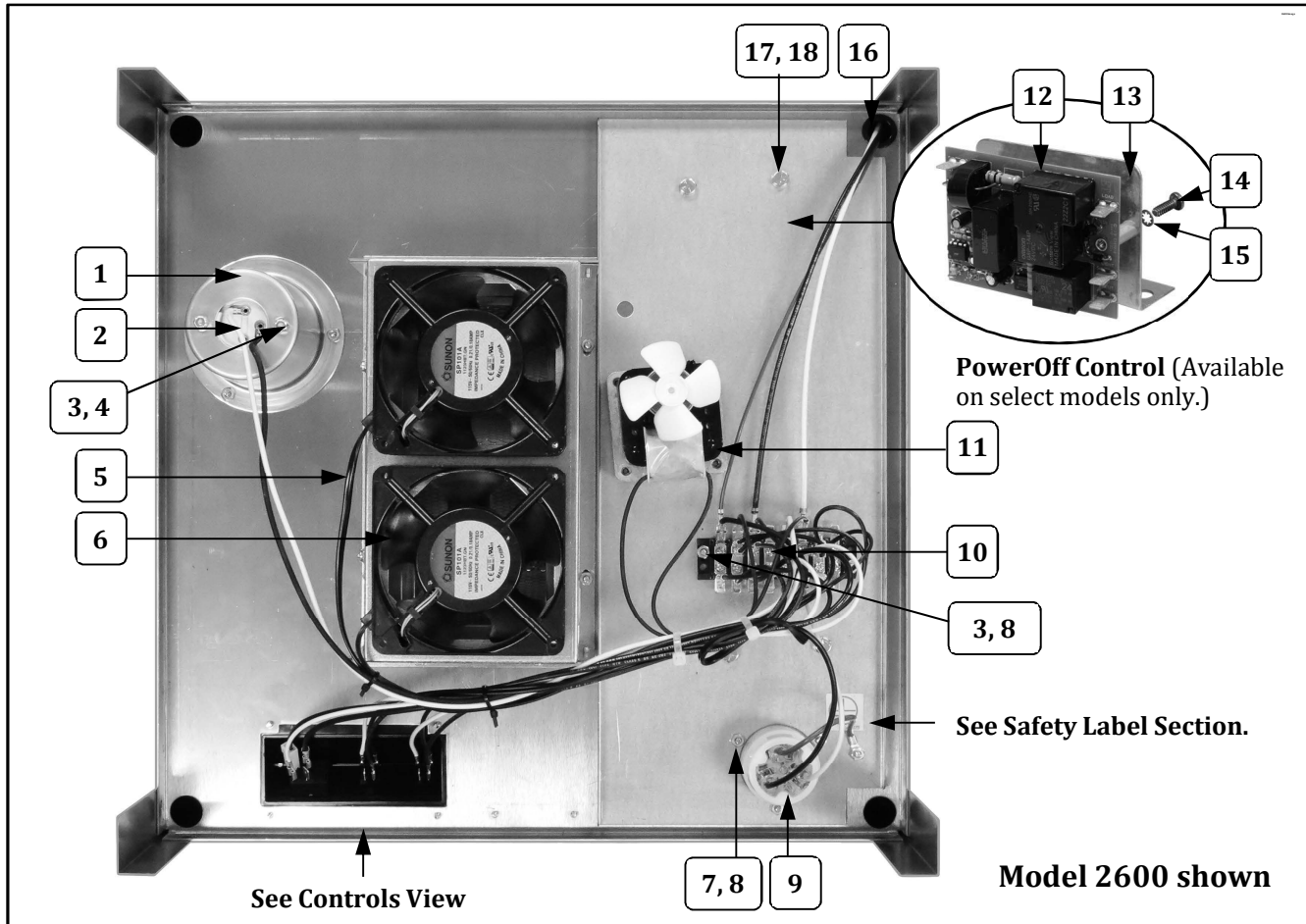

Item	Part Description	Part Number	
		2600, 2600-00-003, 2600-00-000	2600A
1	LIGHT SHIELD CONICAL	40589	40589
2	LAMP HOLDER	47047	47047
3	8-32 X 3/4 PHIL PAN MS SS	39007	39007
4	8-32 HEX NUT, ESLOK, S.S.	22070	22070
5	EXHST BLOWER PLUG & CORD	47199	47199
6	120V 60CY EXHAUST BLOWER	48018	48018
7	8-32 X 1/2 PH PAN W/SEMS	47124	47124
8	8-32 HEX M/S NUT	74149	74149
9	KETTLE LEAD IN RECPT	47327	47327
10	8 POS TERMINAL BLOCK	47208	47208
11	120V KETTLE DRIVE MOTOR	47038	47038
12	KETTLE POWEROFF CNTRL PCB		55402
13	BRACKET, POWEROFF CNTRL		55427
14	6-32 X 3/8 PHIL PAN M/S		39000
15	#6 INTERNAL TOOTH L/W 410SS		39001
16	.875 IN BUSHING, SNAP	45396	45396
17	1/4-20 X 3/4 GRADE 5 BOLT (fastens hanger arm)	74520	74520
18	MED SPLIT LOCK WASHER 1/4 (fastens hanger arm)	74526	74526

Dome Interior – Electrical Components

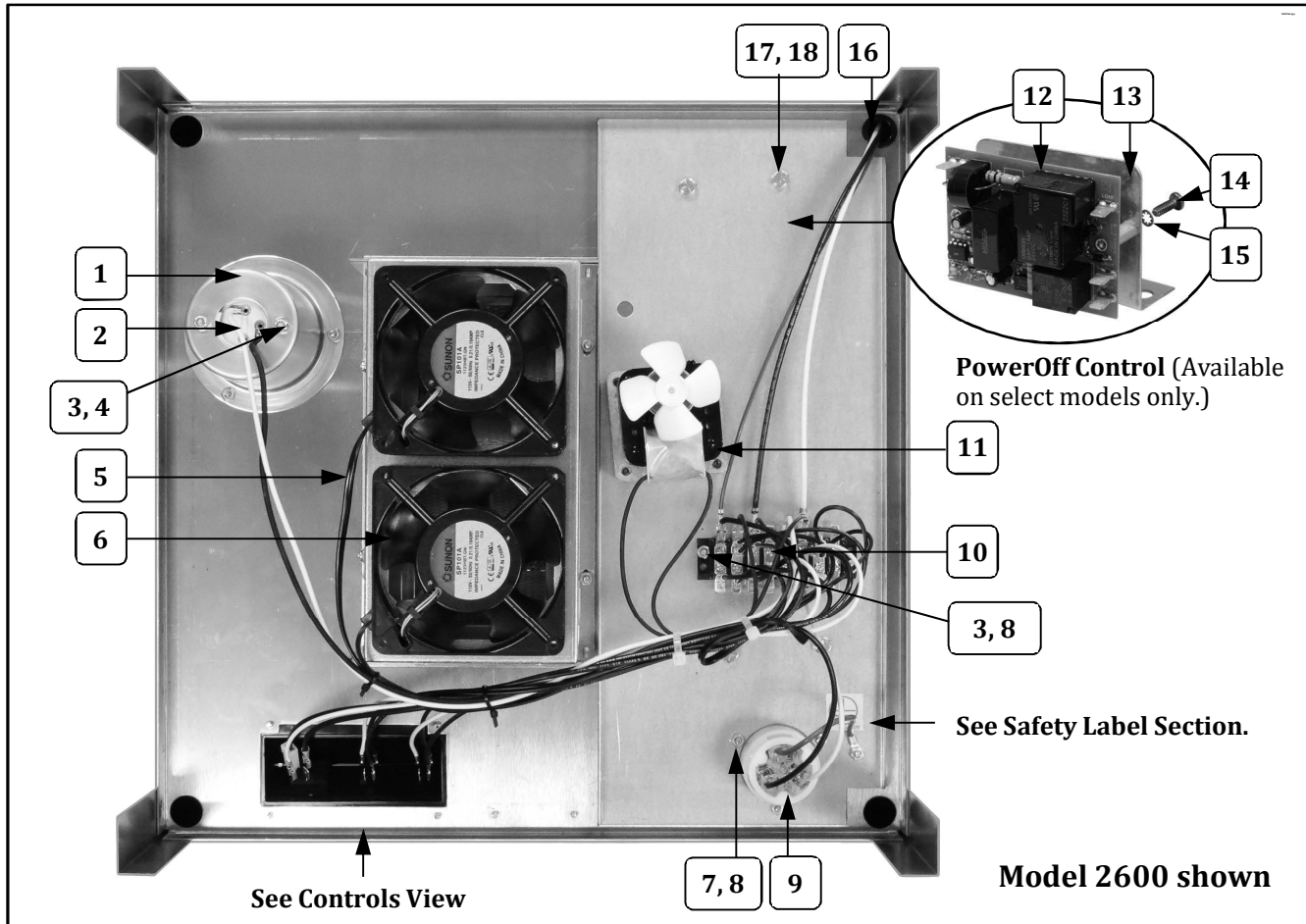

Item	Part Description	Part Number	
		2600, 2600-00-003, 2600-00-000	2600A
1	LIGHT SHIELD CONICAL	40589	40589
2	LAMP HOLDER	47047	47047
3	8-32 X 3/4 PHIL PAN MS SS	39007	39007
4	8-32 HEX NUT, ESLOK, S.S.	22070	22070
5	EXHST BLOWER PLUG & CORD	47199	47199
6	120V 60CY EXHAUST BLOWER	48018	48018
7	8-32 X 1/2 PH PAN W/SEMS	47124	47124
8	8-32 HEX M/S NUT	74149	74149
9	KETTLE LEAD IN RECPT	47327	47327
10	8 POS TERMINAL BLOCK	47208	47208
11	120V KETTLE DRIVE MOTOR	47038	47038
12	KETTLE POWEROFF CNTRL PCB		55402
13	BRACKET, POWEROFF CNTRL		55427
14	6-32 X 3/8 PHIL PAN M/S		39000
15	#6 INTERNAL TOOTH L/W 410SS		39001
16	.875 IN BUSHING, SNAP	45396	45396
17	1/4-20 X 3/4 GRADE 5 BOLT (fastens hanger arm)	74520	74520
18	MED SPLIT LOCK WASHER 1/4 (fastens hanger arm)	74526	74526

Dome Interior – Electrical Components

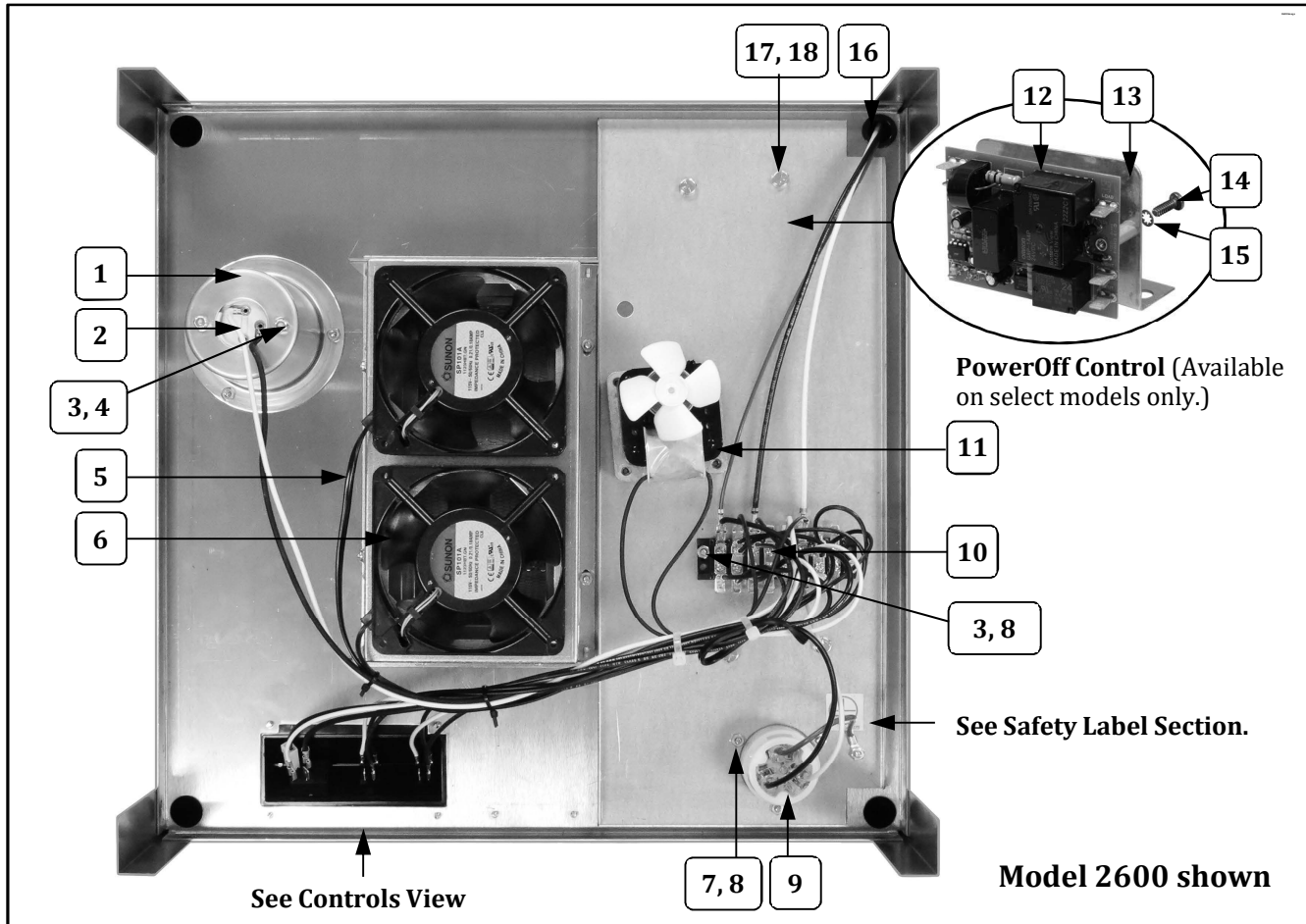

Item	Part Description	Part Number	
		2600, 2600-00-003, 2600-00-000	2600A
1	LIGHT SHIELD CONICAL	40589	40589
2	LAMP HOLDER	47047	47047
3	8-32 X 3/4 PHIL PAN MS SS	39007	39007
4	8-32 HEX NUT, ESLOK, S.S.	22070	22070
5	EXHST BLOWER PLUG & CORD	47199	47199
6	120V 60CY EXHAUST BLOWER	48018	48018
7	8-32 X 1/2 PH PAN W/SEMS	47124	47124
8	8-32 HEX M/S NUT	74149	74149
9	KETTLE LEAD IN RECPT	47327	47327
10	8 POS TERMINAL BLOCK	47208	47208
11	120V KETTLE DRIVE MOTOR	47038	47038
12	KETTLE POWEROFF CNTRL PCB		55402
13	BRACKET, POWEROFF CNTRL		55427
14	6-32 X 3/8 PHIL PAN M/S		39000
15	#6 INTERNAL TOOTH L/W 410SS		39001
16	.875 IN BUSHING, SNAP	45396	45396
17	1/4-20 X 3/4 GRADE 5 BOLT (fastens hanger arm)	74520	74520
18	MED SPLIT LOCK WASHER 1/4 (fastens hanger arm)	74526	74526

Dome Interior – Electrical Components

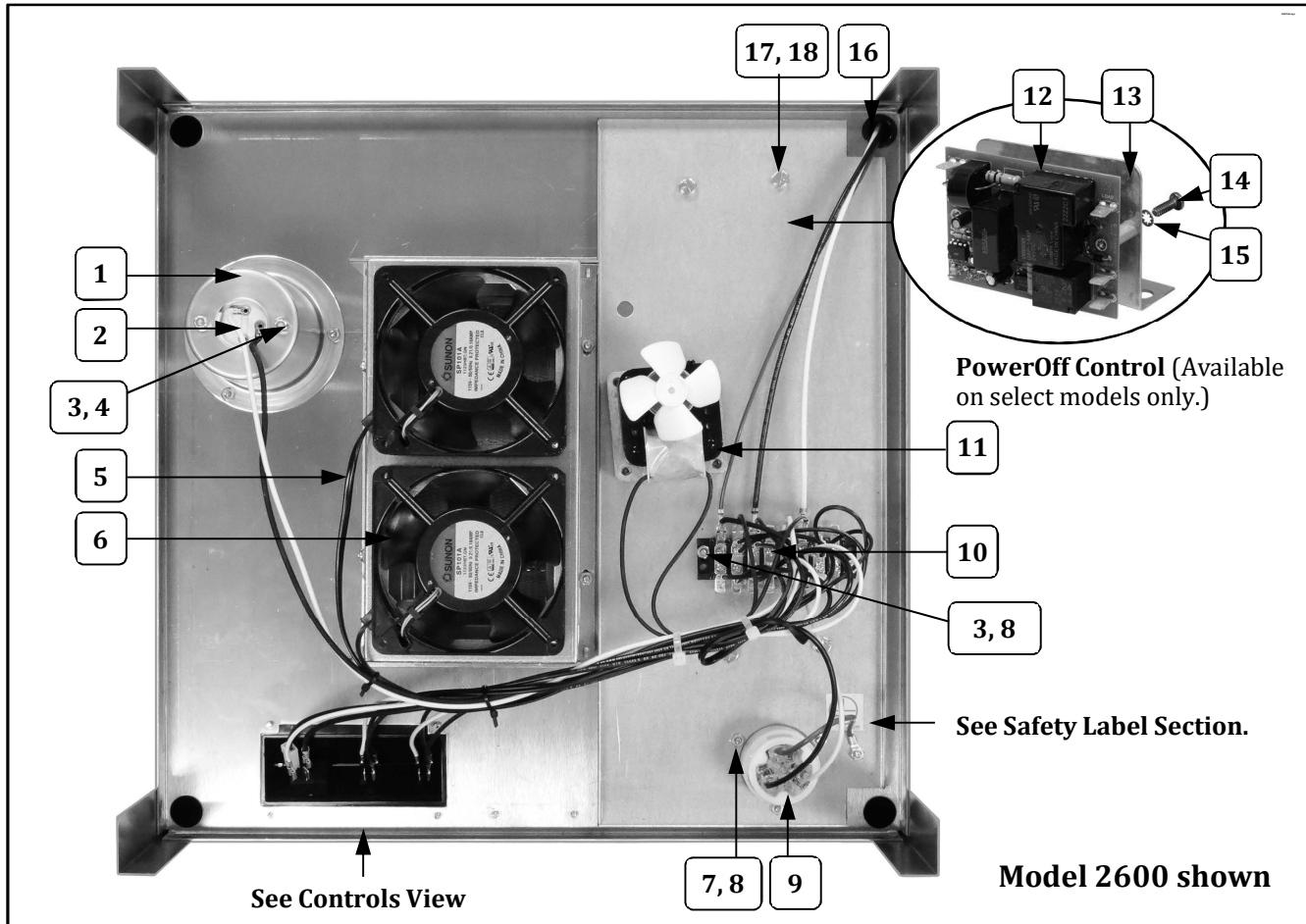

Item	Part Description	Part Number	
		2600, 2600-00-003, 2600-00-000	2600A
1	LIGHT SHIELD CONICAL	40589	40589
2	LAMP HOLDER	47047	47047
3	8-32 X 3/4 PHIL PAN MS SS	39007	39007
4	8-32 HEX NUT, ESLOK, S.S.	22070	22070
5	EXHST BLOWER PLUG & CORD	47199	47199
6	120V 60CY EXHAUST BLOWER	48018	48018
7	8-32 X 1/2 PH PAN W/SEMS	47124	47124
8	8-32 HEX M/S NUT	74149	74149
9	KETTLE LEAD IN RECPT	47327	47327
10	8 POS TERMINAL BLOCK	47208	47208
11	120V KETTLE DRIVE MOTOR	47038	47038
12	KETTLE POWEROFF CNTRL PCB		55402
13	BRACKET, POWEROFF CNTRL		55427
14	6-32 X 3/8 PHIL PAN M/S		39000
15	#6 INTERNAL TOOTH L/W 410SS		39001
16	.875 IN BUSHING, SNAP	45396	45396
17	1/4-20 X 3/4 GRADE 5 BOLT (fastens hanger arm)	74520	74520
18	MED SPLIT LOCK WASHER 1/4 (fastens hanger arm)	74526	74526

Dome Interior – Electrical Components

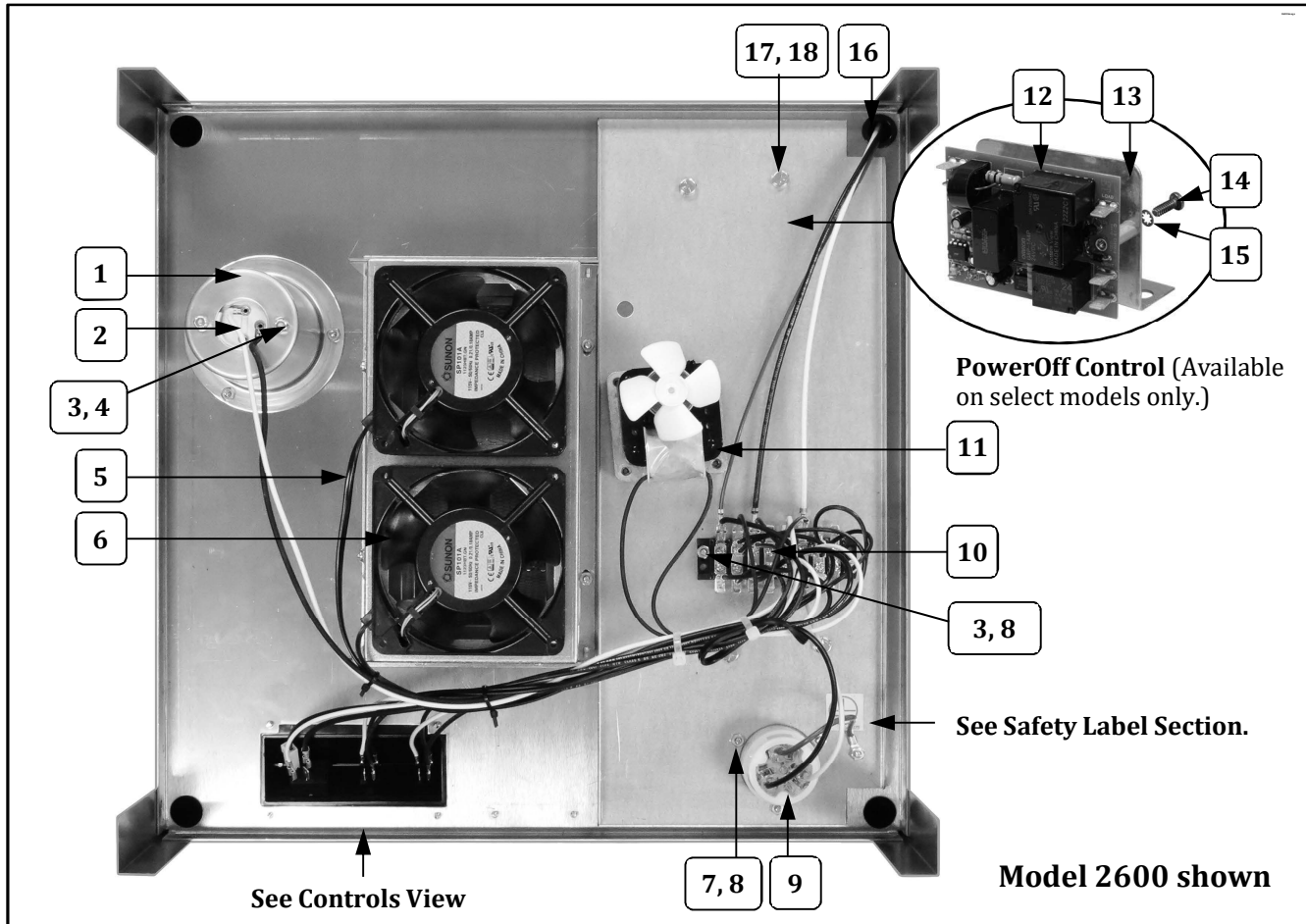

Item	Part Description	Part Number	
		2600, 2600-00-003, 2600-00-000	2600A
1	LIGHT SHIELD CONICAL	40589	40589
2	LAMP HOLDER	47047	47047
3	8-32 X 3/4 PHIL PAN MS SS	39007	39007
4	8-32 HEX NUT, ESLOK, S.S.	22070	22070
5	EXHST BLOWER PLUG & CORD	47199	47199
6	120V 60CY EXHAUST BLOWER	48018	48018
7	8-32 X 1/2 PH PAN W/SEMS	47124	47124
8	8-32 HEX M/S NUT	74149	74149
9	KETTLE LEAD IN RECPT	47327	47327
10	8 POS TERMINAL BLOCK	47208	47208
11	120V KETTLE DRIVE MOTOR	47038	47038
12	KETTLE POWEROFF CNTRL PCB		55402
13	BRACKET, POWEROFF CNTRL		55427
14	6-32 X 3/8 PHIL PAN M/S		39000
15	#6 INTERNAL TOOTH L/W 410SS		39001
16	.875 IN BUSHING, SNAP	45396	45396
17	1/4-20 X 3/4 GRADE 5 BOLT (fastens hanger arm)	74520	74520
18	MED SPLIT LOCK WASHER 1/4 (fastens hanger arm)	74526	74526

Dome Interior – Electrical Components

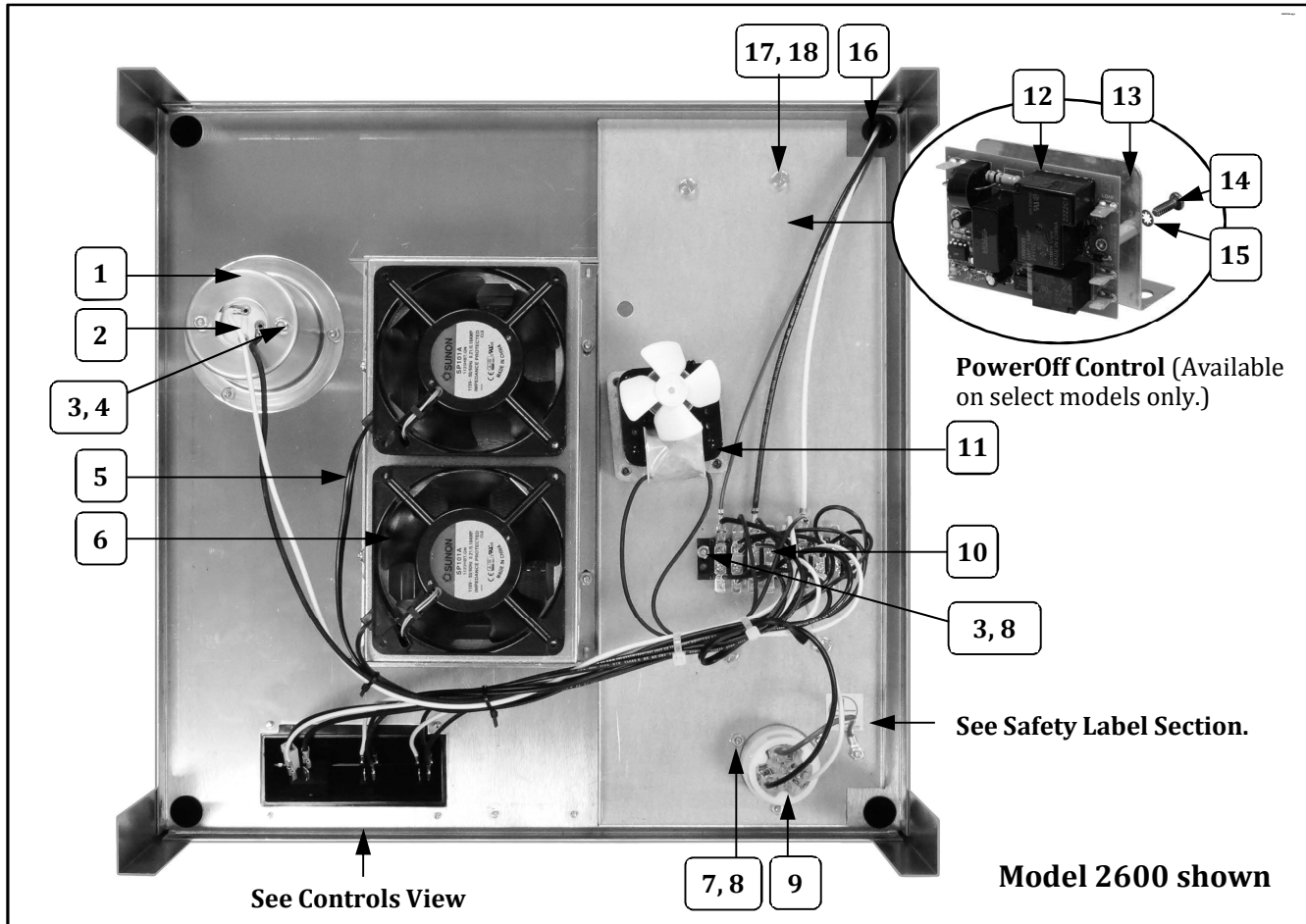

Item	Part Description	Part Number	
		2600, 2600-00-003, 2600-00-000	2600A
1	LIGHT SHIELD CONICAL	40589	40589
2	LAMP HOLDER	47047	47047
3	8-32 X 3/4 PHIL PAN MS SS	39007	39007
4	8-32 HEX NUT, ESLOK, S.S.	22070	22070
5	EXHST BLOWER PLUG & CORD	47199	47199
6	120V 60CY EXHAUST BLOWER	48018	48018
7	8-32 X 1/2 PH PAN W/SEMS	47124	47124
8	8-32 HEX M/S NUT	74149	74149
9	KETTLE LEAD IN RECPT	47327	47327
10	8 POS TERMINAL BLOCK	47208	47208
11	120V KETTLE DRIVE MOTOR	47038	47038
12	KETTLE POWEROFF CNTRL PCB		55402
13	BRACKET, POWEROFF CNTRL		55427
14	6-32 X 3/8 PHIL PAN M/S		39000
15	#6 INTERNAL TOOTH L/W 410SS		39001
16	.875 IN BUSHING, SNAP	45396	45396
17	1/4-20 X 3/4 GRADE 5 BOLT (fastens hanger arm)	74520	74520
18	MED SPLIT LOCK WASHER 1/4 (fastens hanger arm)	74526	74526

Dome Interior – Electrical Components

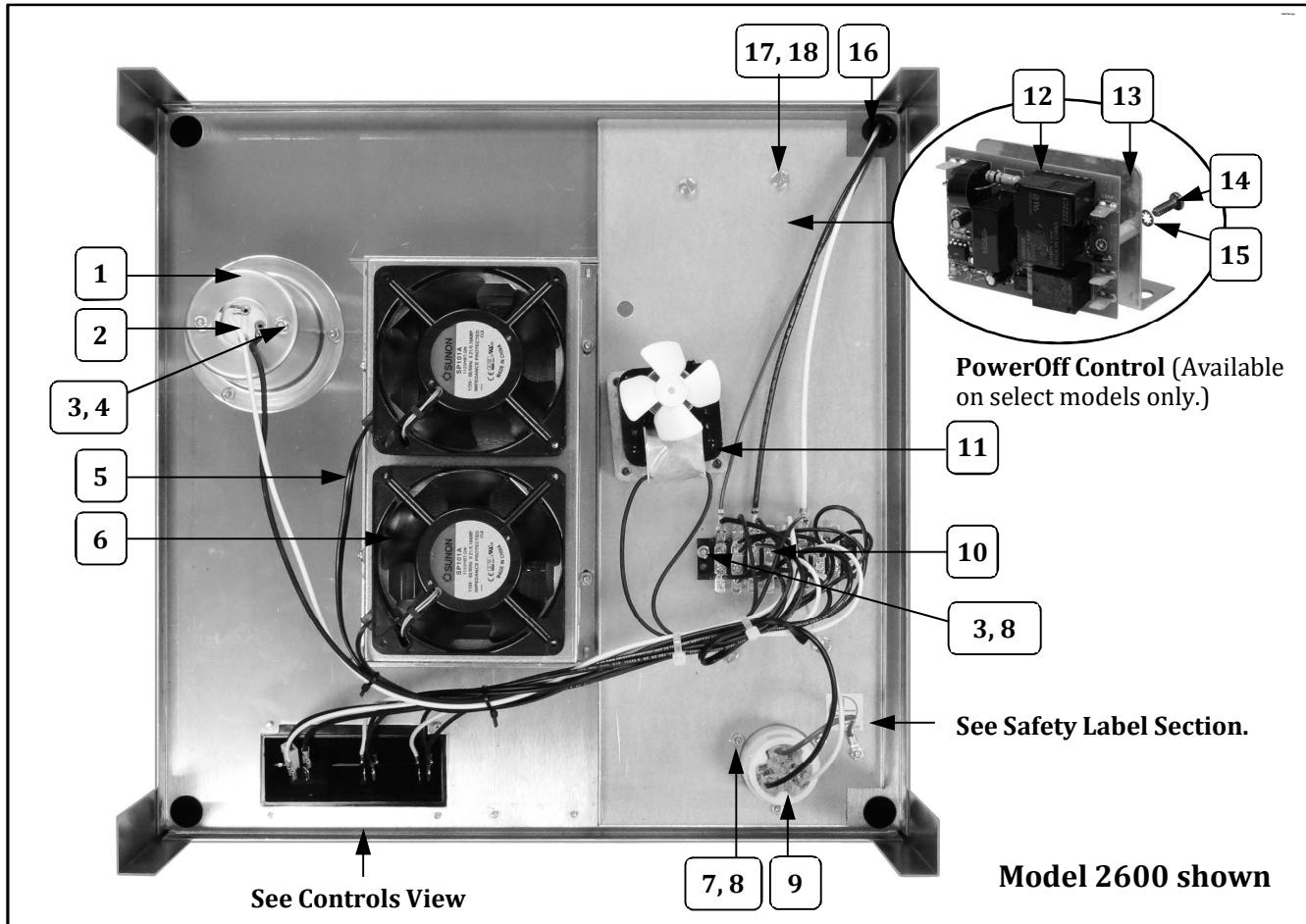

Item	Part Description	Part Number	
		2600, 2600-00-003, 2600-00-000	2600A
1	LIGHT SHIELD CONICAL	40589	40589
2	LAMP HOLDER	47047	47047
3	8-32 X 3/4 PHIL PAN MS SS	39007	39007
4	8-32 HEX NUT, ESLOK, S.S.	22070	22070
5	EXHST BLOWER PLUG & CORD	47199	47199
6	120V 60CY EXHAUST BLOWER	48018	48018
7	8-32 X 1/2 PH PAN W/SEMS	47124	47124
8	8-32 HEX M/S NUT	74149	74149
9	KETTLE LEAD IN RECPT	47327	47327
10	8 POS TERMINAL BLOCK	47208	47208
11	120V KETTLE DRIVE MOTOR	47038	47038
12	KETTLE POWEROFF CNTRL PCB		55402
13	BRACKET, POWEROFF CNTRL		55427
14	6-32 X 3/8 PHIL PAN M/S		39000
15	#6 INTERNAL TOOTH L/W 410SS		39001
16	.875 IN BUSHING, SNAP	45396	45396
17	1/4-20 X 3/4 GRADE 5 BOLT (fastens hanger arm)	74520	74520
18	MED SPLIT LOCK WASHER 1/4 (fastens hanger arm)	74526	74526

Dome Interior – Electrical Components

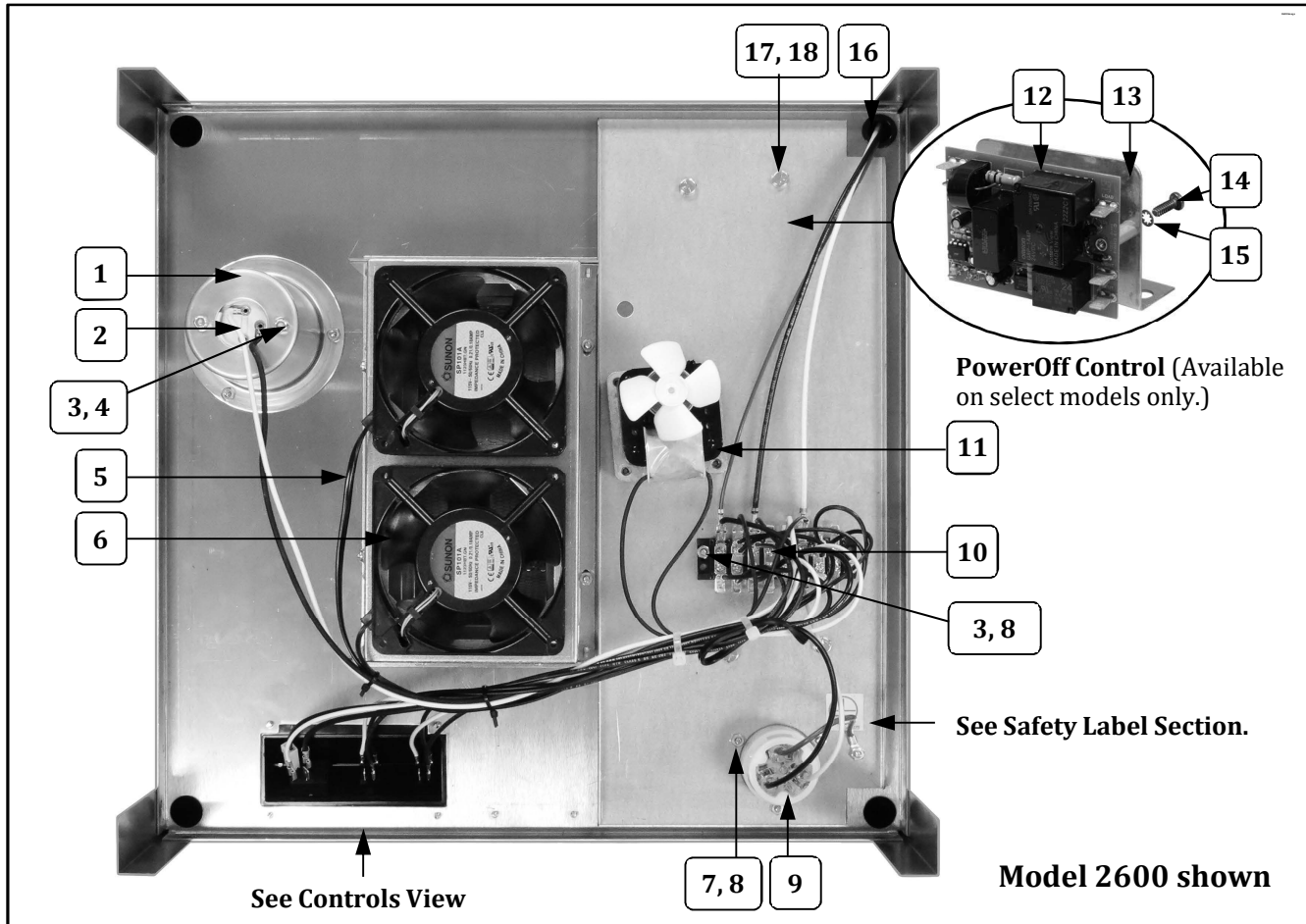

Item	Part Description	Part Number	
		2600, 2600-00-003, 2600-00-000	2600A
1	LIGHT SHIELD CONICAL	40589	40589
2	LAMP HOLDER	47047	47047
3	8-32 X 3/4 PHIL PAN MS SS	39007	39007
4	8-32 HEX NUT, ESLOK, S.S.	22070	22070
5	EXHST BLOWER PLUG & CORD	47199	47199
6	120V 60CY EXHAUST BLOWER	48018	48018
7	8-32 X 1/2 PH PAN W/SEMS	47124	47124
8	8-32 HEX M/S NUT	74149	74149
9	KETTLE LEAD IN RECPT	47327	47327
10	8 POS TERMINAL BLOCK	47208	47208
11	120V KETTLE DRIVE MOTOR	47038	47038
12	KETTLE POWEROFF CNTRL PCB		55402
13	BRACKET, POWEROFF CNTRL		55427
14	6-32 X 3/8 PHIL PAN M/S		39000
15	#6 INTERNAL TOOTH L/W 410SS		39001
16	.875 IN BUSHING, SNAP	45396	45396
17	1/4-20 X 3/4 GRADE 5 BOLT (fastens hanger arm)	74520	74520
18	MED SPLIT LOCK WASHER 1/4 (fastens hanger arm)	74526	74526

Dome Interior – Electrical Components

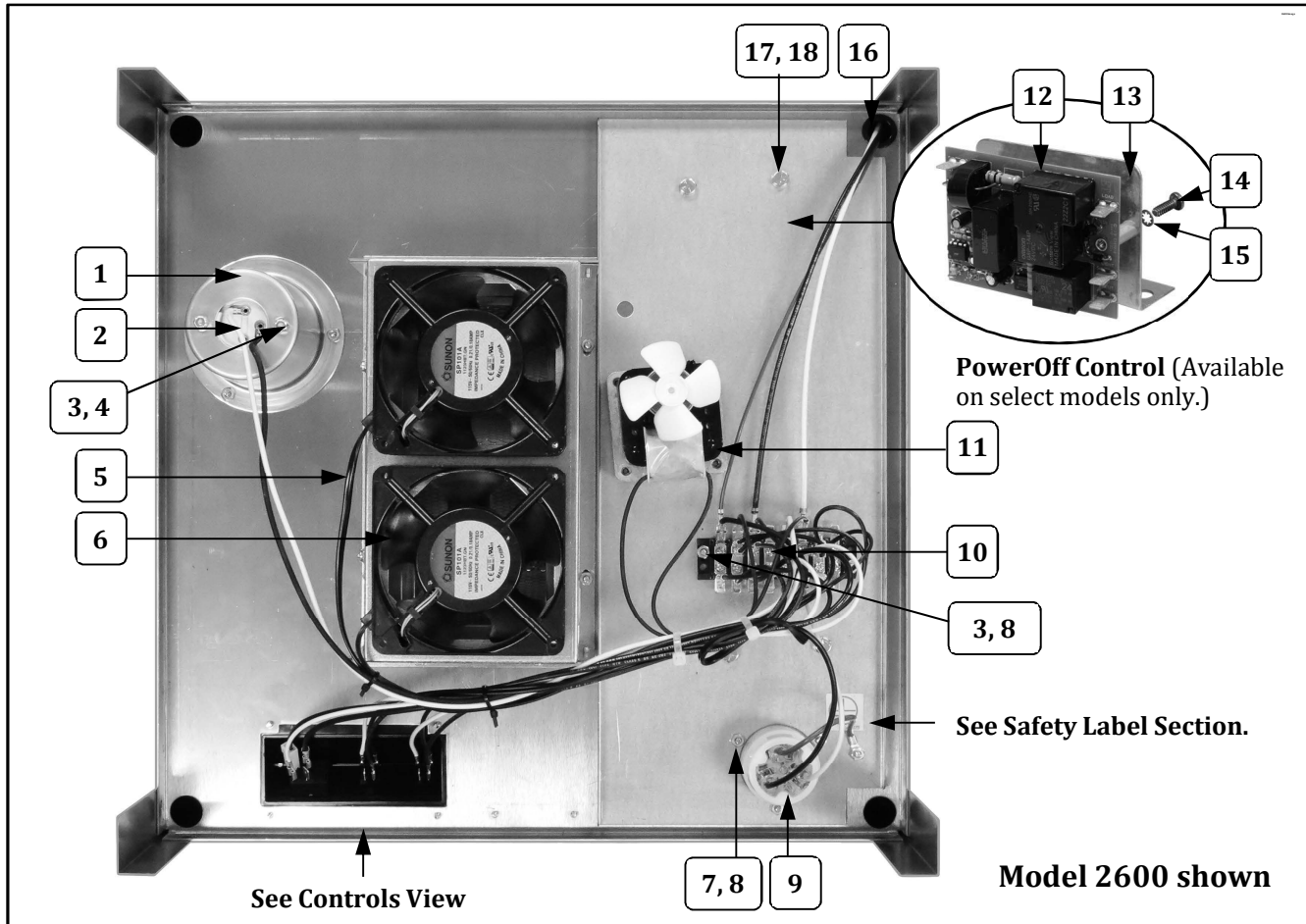

Item	Part Description	Part Number	
		2600, 2600-00-003, 2600-00-000	2600A
1	LIGHT SHIELD CONICAL	40589	40589
2	LAMP HOLDER	47047	47047
3	8-32 X 3/4 PHIL PAN MS SS	39007	39007
4	8-32 HEX NUT, ESLOK, S.S.	22070	22070
5	EXHST BLOWER PLUG & CORD	47199	47199
6	120V 60CY EXHAUST BLOWER	48018	48018
7	8-32 X 1/2 PH PAN W/SEMS	47124	47124
8	8-32 HEX M/S NUT	74149	74149
9	KETTLE LEAD IN RECPT	47327	47327
10	8 POS TERMINAL BLOCK	47208	47208
11	120V KETTLE DRIVE MOTOR	47038	47038
12	KETTLE POWEROFF CNTRL PCB		55402
13	BRACKET, POWEROFF CNTRL		55427
14	6-32 X 3/8 PHIL PAN M/S		39000
15	#6 INTERNAL TOOTH L/W 410SS		39001
16	.875 IN BUSHING, SNAP	45396	45396
17	1/4-20 X 3/4 GRADE 5 BOLT (fastens hanger arm)	74520	74520
18	MED SPLIT LOCK WASHER 1/4 (fastens hanger arm)	74526	74526

Dome Interior – Electrical Components

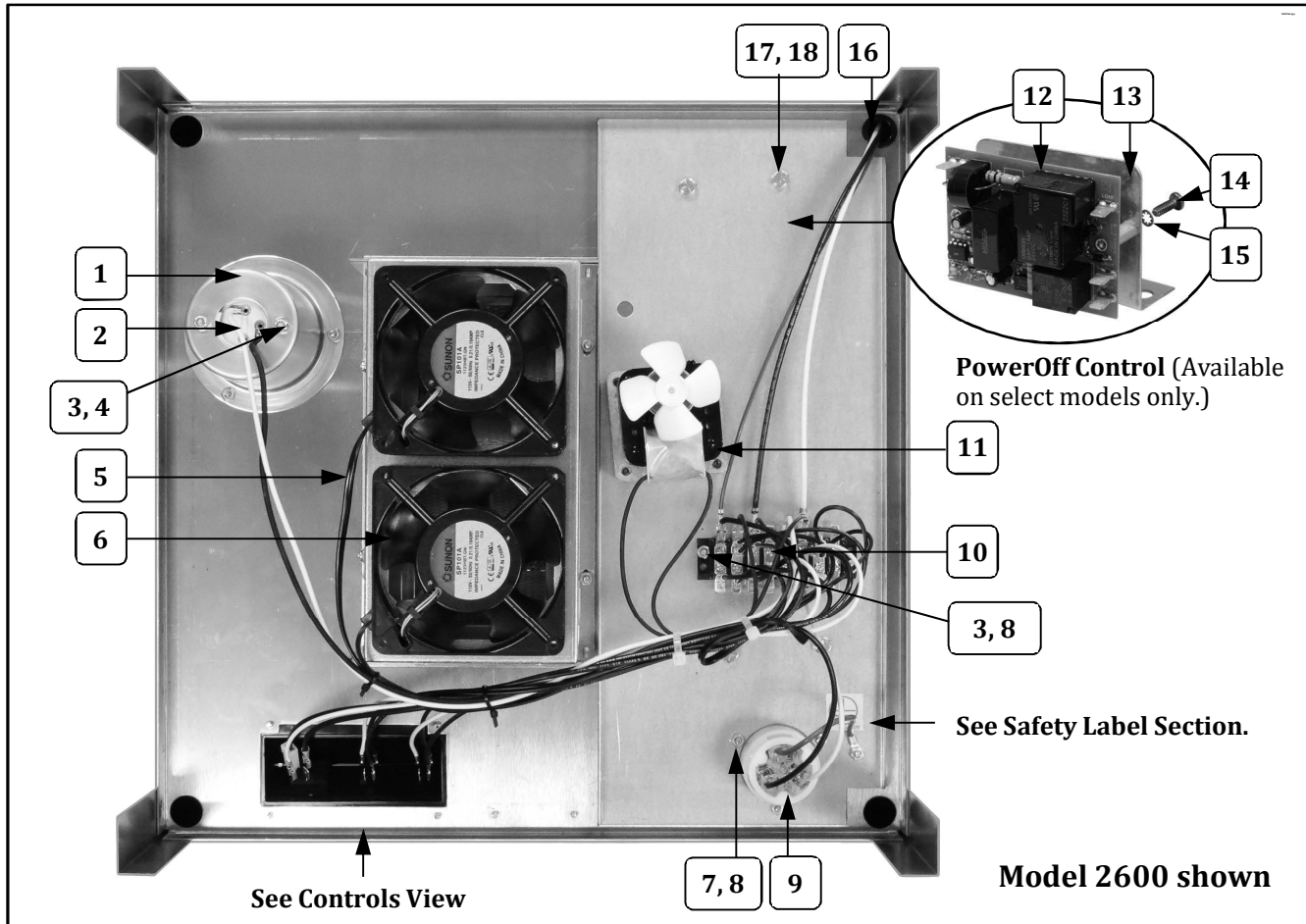

Item	Part Description	Part Number	
		2600, 2600-00-003, 2600-00-000	2600A
1	LIGHT SHIELD CONICAL	40589	40589
2	LAMP HOLDER	47047	47047
3	8-32 X 3/4 PHIL PAN MS SS	39007	39007
4	8-32 HEX NUT, ESLOK, S.S.	22070	22070
5	EXHST BLOWER PLUG & CORD	47199	47199
6	120V 60CY EXHAUST BLOWER	48018	48018
7	8-32 X 1/2 PH PAN W/SEMS	47124	47124
8	8-32 HEX M/S NUT	74149	74149
9	KETTLE LEAD IN RECPT	47327	47327
10	8 POS TERMINAL BLOCK	47208	47208
11	120V KETTLE DRIVE MOTOR	47038	47038
12	KETTLE POWEROFF CNTRL PCB		55402
13	BRACKET, POWEROFF CNTRL		55427
14	6-32 X 3/8 PHIL PAN M/S		39000
15	#6 INTERNAL TOOTH L/W 410SS		39001
16	.875 IN BUSHING, SNAP	45396	45396
17	1/4-20 X 3/4 GRADE 5 BOLT (fastens hanger arm)	74520	74520
18	MED SPLIT LOCK WASHER 1/4 (fastens hanger arm)	74526	74526

Dome Interior – Electrical Components

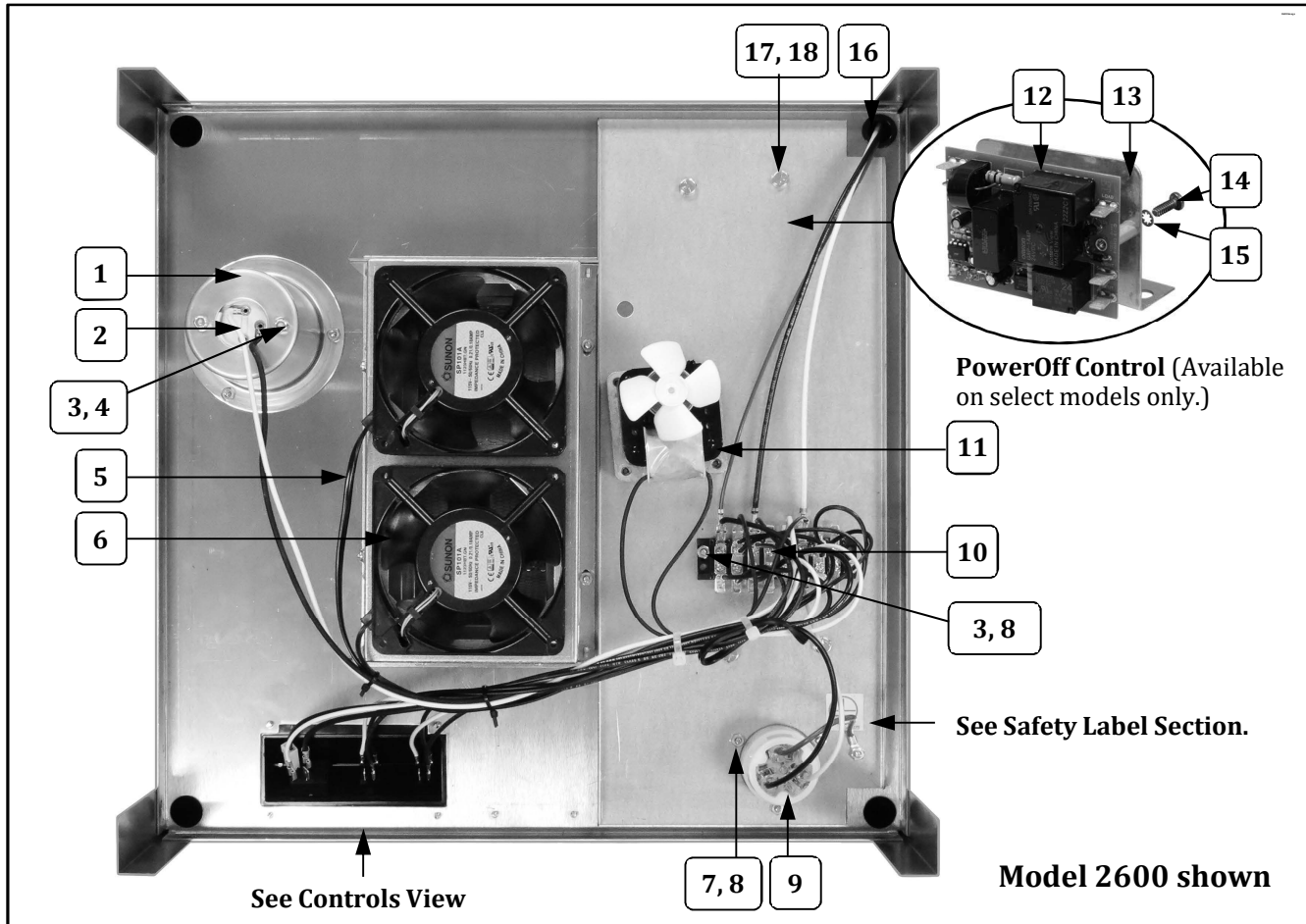

Item	Part Description	Part Number	
		2600, 2600-00-003, 2600-00-000	2600A
1	LIGHT SHIELD CONICAL	40589	40589
2	LAMP HOLDER	47047	47047
3	8-32 X 3/4 PHIL PAN MS SS	39007	39007
4	8-32 HEX NUT, ESLOK, S.S.	22070	22070
5	EXHST BLOWER PLUG & CORD	47199	47199
6	120V 60CY EXHAUST BLOWER	48018	48018
7	8-32 X 1/2 PH PAN W/SEMS	47124	47124
8	8-32 HEX M/S NUT	74149	74149
9	KETTLE LEAD IN RECPT	47327	47327
10	8 POS TERMINAL BLOCK	47208	47208
11	120V KETTLE DRIVE MOTOR	47038	47038
12	KETTLE POWEROFF CNTRL PCB		55402
13	BRACKET, POWEROFF CNTRL		55427
14	6-32 X 3/8 PHIL PAN M/S		39000
15	#6 INTERNAL TOOTH L/W 410SS		39001
16	.875 IN BUSHING, SNAP	45396	45396
17	1/4-20 X 3/4 GRADE 5 BOLT (fastens hanger arm)	74520	74520
18	MED SPLIT LOCK WASHER 1/4 (fastens hanger arm)	74526	74526

Dome Interior – Electrical Components

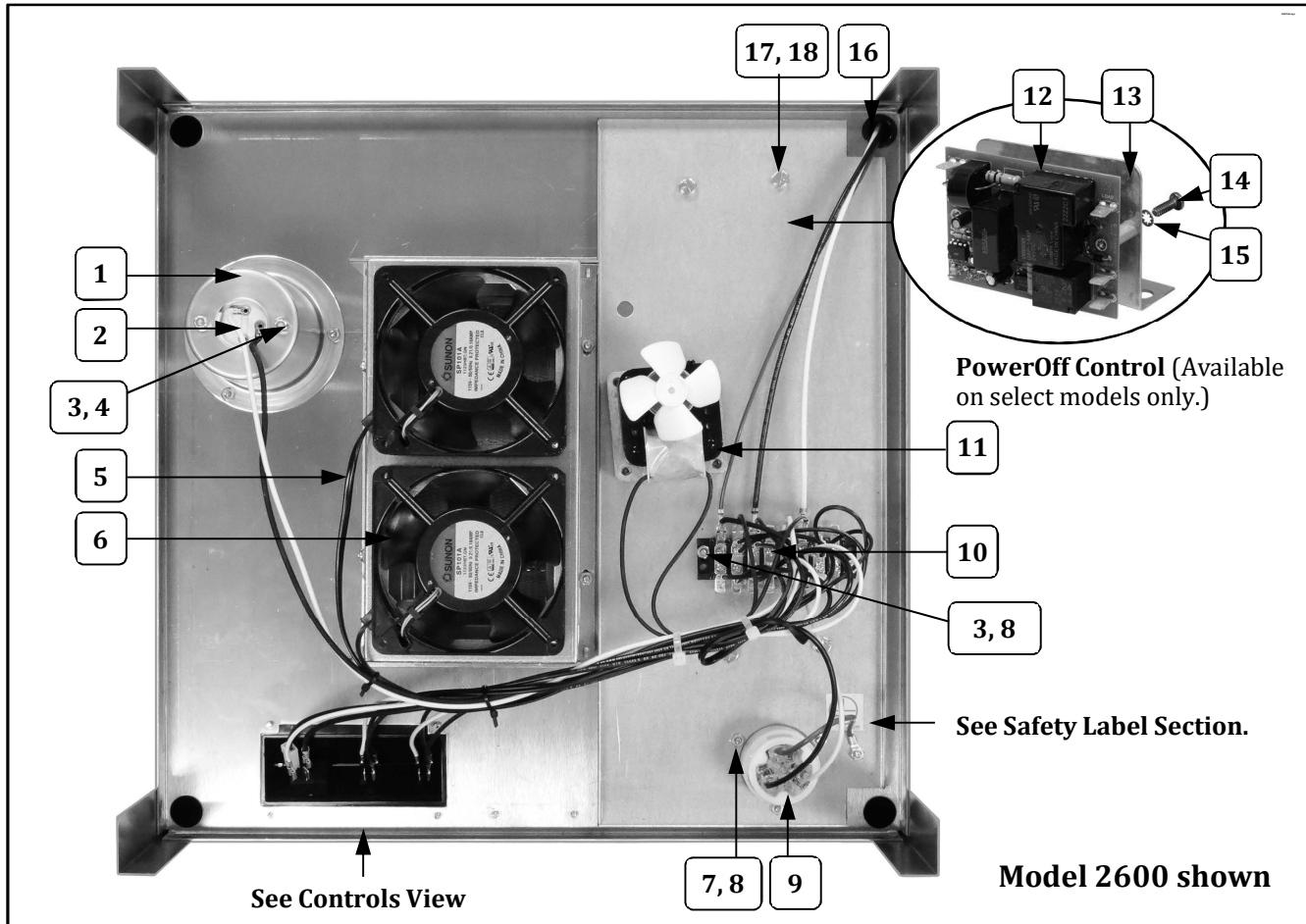

Item	Part Description	Part Number	
		2600, 2600-00-003, 2600-00-000	2600A
1	LIGHT SHIELD CONICAL	40589	40589
2	LAMP HOLDER	47047	47047
3	8-32 X 3/4 PHIL PAN MS SS	39007	39007
4	8-32 HEX NUT, ESLOK, S.S.	22070	22070
5	EXHST BLOWER PLUG & CORD	47199	47199
6	120V 60CY EXHAUST BLOWER	48018	48018
7	8-32 X 1/2 PH PAN W/SEMS	47124	47124
8	8-32 HEX M/S NUT	74149	74149
9	KETTLE LEAD IN RECPT	47327	47327
10	8 POS TERMINAL BLOCK	47208	47208
11	120V KETTLE DRIVE MOTOR	47038	47038
12	KETTLE POWEROFF CNTRL PCB		55402
13	BRACKET, POWEROFF CNTRL		55427
14	6-32 X 3/8 PHIL PAN M/S		39000
15	#6 INTERNAL TOOTH L/W 410SS		39001
16	.875 IN BUSHING, SNAP	45396	45396
17	1/4-20 X 3/4 GRADE 5 BOLT (fastens hanger arm)	74520	74520
18	MED SPLIT LOCK WASHER 1/4 (fastens hanger arm)	74526	74526

Dome Interior – Electrical Components

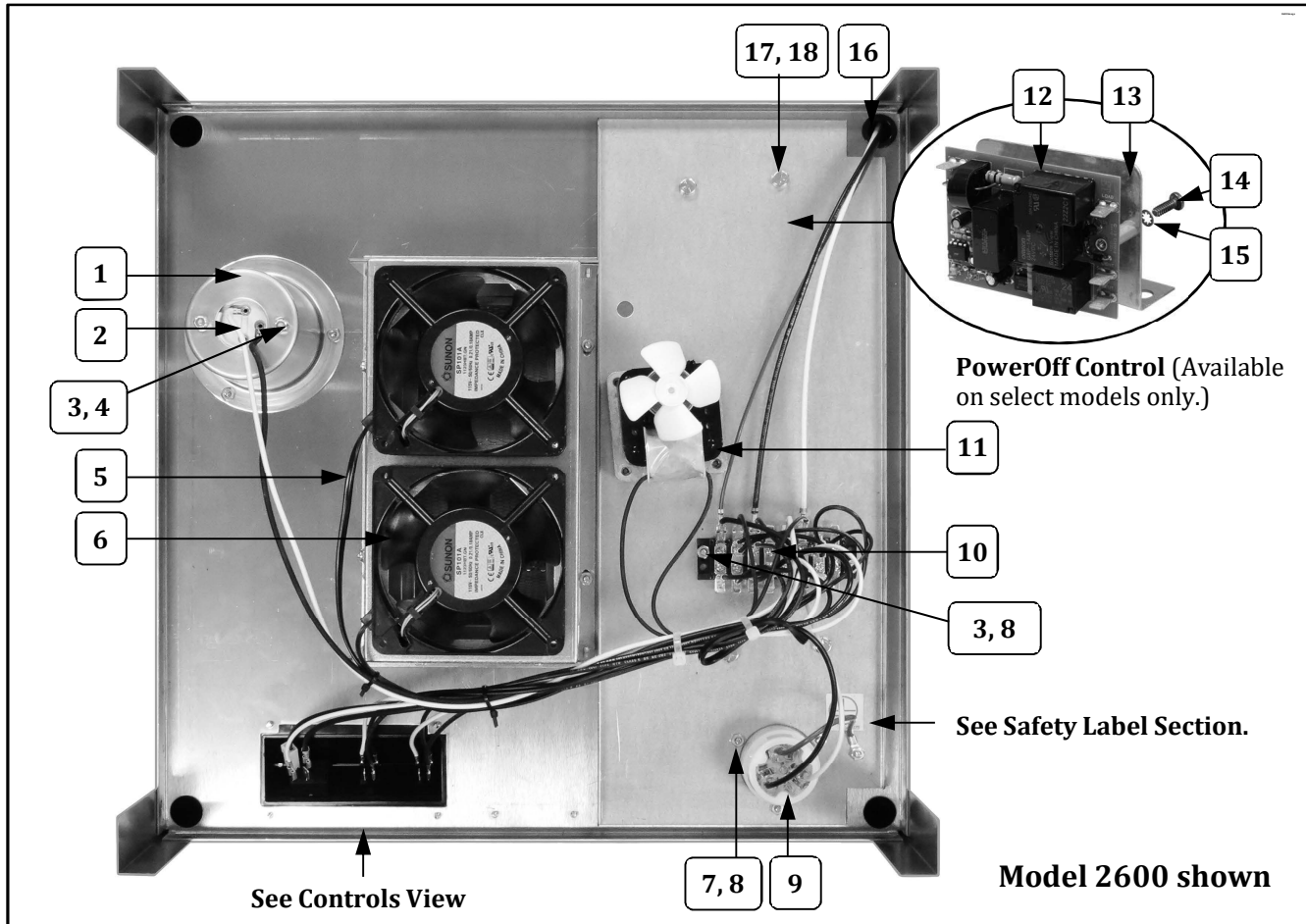

Item	Part Description	Part Number	
		2600, 2600-00-003, 2600-00-000	2600A
1	LIGHT SHIELD CONICAL	40589	40589
2	LAMP HOLDER	47047	47047
3	8-32 X 3/4 PHIL PAN MS SS	39007	39007
4	8-32 HEX NUT, ESLOK, S.S.	22070	22070
5	EXHST BLOWER PLUG & CORD	47199	47199
6	120V 60CY EXHAUST BLOWER	48018	48018
7	8-32 X 1/2 PH PAN W/SEMS	47124	47124
8	8-32 HEX M/S NUT	74149	74149
9	KETTLE LEAD IN RECPT	47327	47327
10	8 POS TERMINAL BLOCK	47208	47208
11	120V KETTLE DRIVE MOTOR	47038	47038
12	KETTLE POWEROFF CNTRL PCB		55402
13	BRACKET, POWEROFF CNTRL		55427
14	6-32 X 3/8 PHIL PAN M/S		39000
15	#6 INTERNAL TOOTH L/W 410SS		39001
16	.875 IN BUSHING, SNAP	45396	45396
17	1/4-20 X 3/4 GRADE 5 BOLT (fastens hanger arm)	74520	74520
18	MED SPLIT LOCK WASHER 1/4 (fastens hanger arm)	74526	74526

Dome Interior – Electrical Components

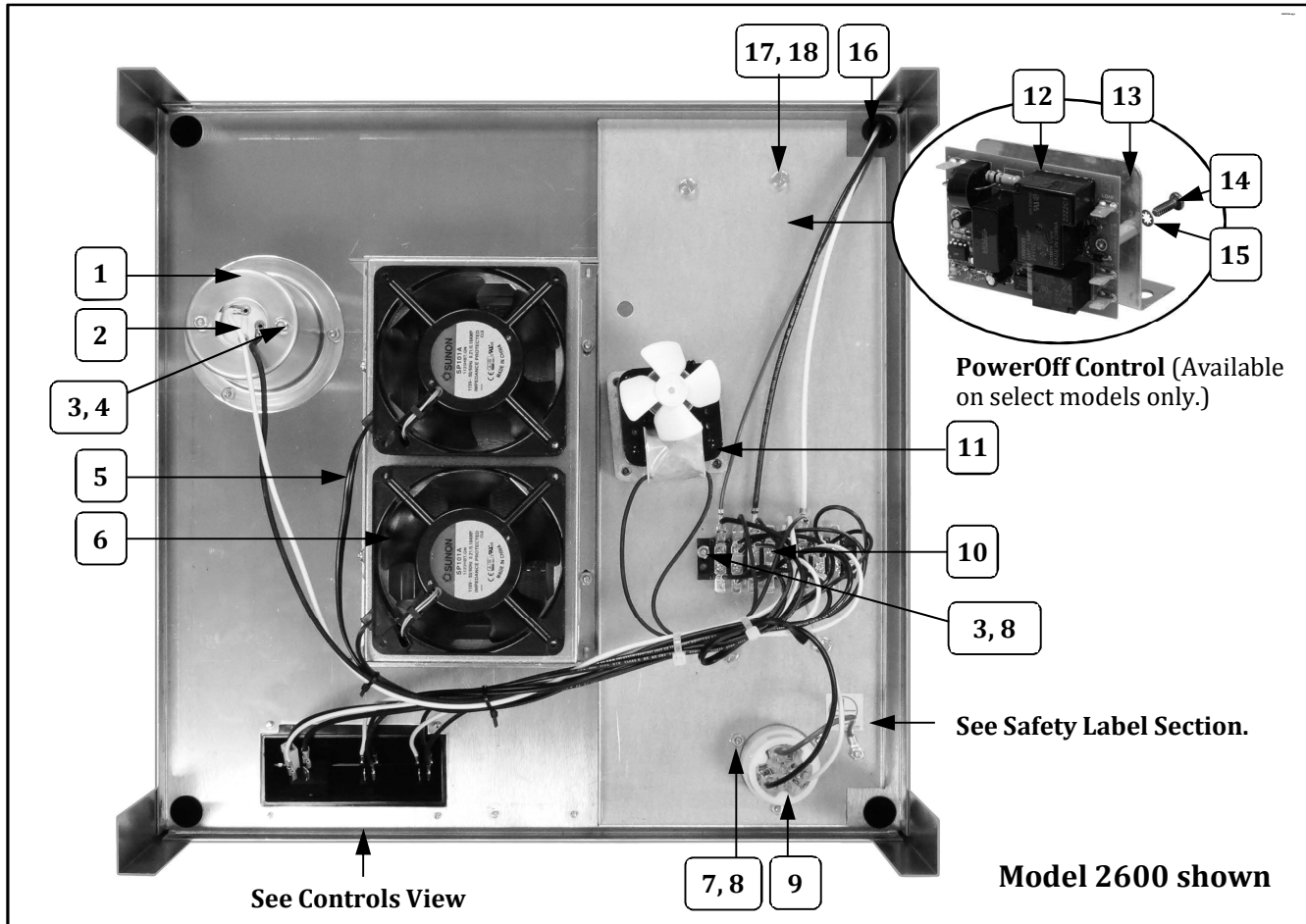

Item	Part Description	Part Number	
		2600, 2600-00-003, 2600-00-000	2600A
1	LIGHT SHIELD CONICAL	40589	40589
2	LAMP HOLDER	47047	47047
3	8-32 X 3/4 PHIL PAN MS SS	39007	39007
4	8-32 HEX NUT, ESLOK, S.S.	22070	22070
5	EXHST BLOWER PLUG & CORD	47199	47199
6	120V 60CY EXHAUST BLOWER	48018	48018
7	8-32 X 1/2 PH PAN W/SEMS	47124	47124
8	8-32 HEX M/S NUT	74149	74149
9	KETTLE LEAD IN RECPT	47327	47327
10	8 POS TERMINAL BLOCK	47208	47208
11	120V KETTLE DRIVE MOTOR	47038	47038
12	KETTLE POWEROFF CNTRL PCB		55402
13	BRACKET, POWEROFF CNTRL		55427
14	6-32 X 3/8 PHIL PAN M/S		39000
15	#6 INTERNAL TOOTH L/W 410SS		39001
16	.875 IN BUSHING, SNAP	45396	45396
17	1/4-20 X 3/4 GRADE 5 BOLT (fastens hanger arm)	74520	74520
18	MED SPLIT LOCK WASHER 1/4 (fastens hanger arm)	74526	74526

Dome Interior – Electrical Components

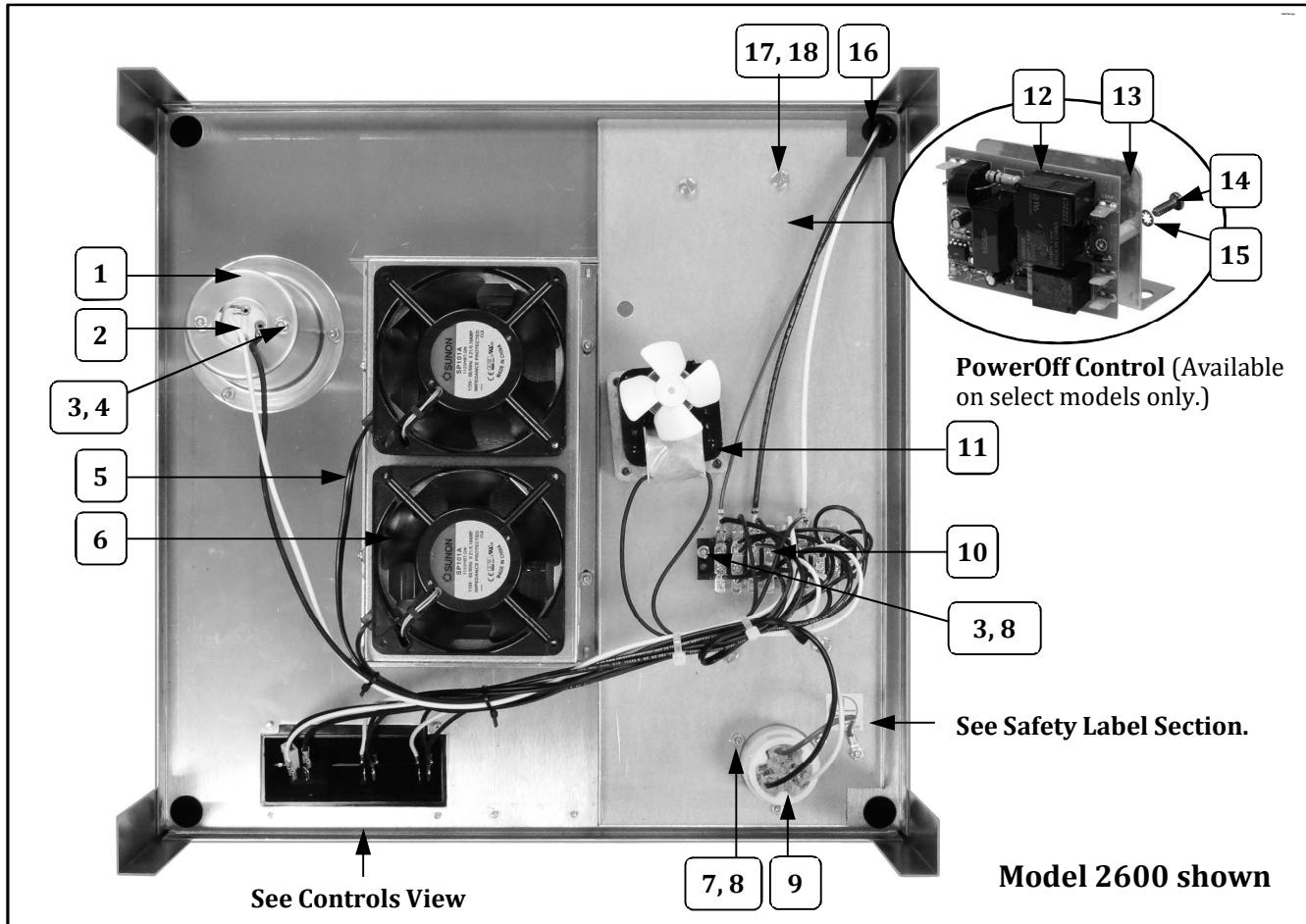

Item	Part Description	Part Number	
		2600, 2600-00-003, 2600-00-000	2600A
1	LIGHT SHIELD CONICAL	40589	40589
2	LAMP HOLDER	47047	47047
3	8-32 X 3/4 PHIL PAN MS SS	39007	39007
4	8-32 HEX NUT, ESLOK, S.S.	22070	22070
5	EXHST BLOWER PLUG & CORD	47199	47199
6	120V 60CY EXHAUST BLOWER	48018	48018
7	8-32 X 1/2 PH PAN W/SEMS	47124	47124
8	8-32 HEX M/S NUT	74149	74149
9	KETTLE LEAD IN RECPT	47327	47327
10	8 POS TERMINAL BLOCK	47208	47208
11	120V KETTLE DRIVE MOTOR	47038	47038
12	KETTLE POWEROFF CNTRL PCB		55402
13	BRACKET, POWEROFF CNTRL		55427
14	6-32 X 3/8 PHIL PAN M/S		39000
15	#6 INTERNAL TOOTH L/W 410SS		39001
16	.875 IN BUSHING, SNAP	45396	45396
17	1/4-20 X 3/4 GRADE 5 BOLT (fastens hanger arm)	74520	74520
18	MED SPLIT LOCK WASHER 1/4 (fastens hanger arm)	74526	74526

Dome Interior – Electrical Components

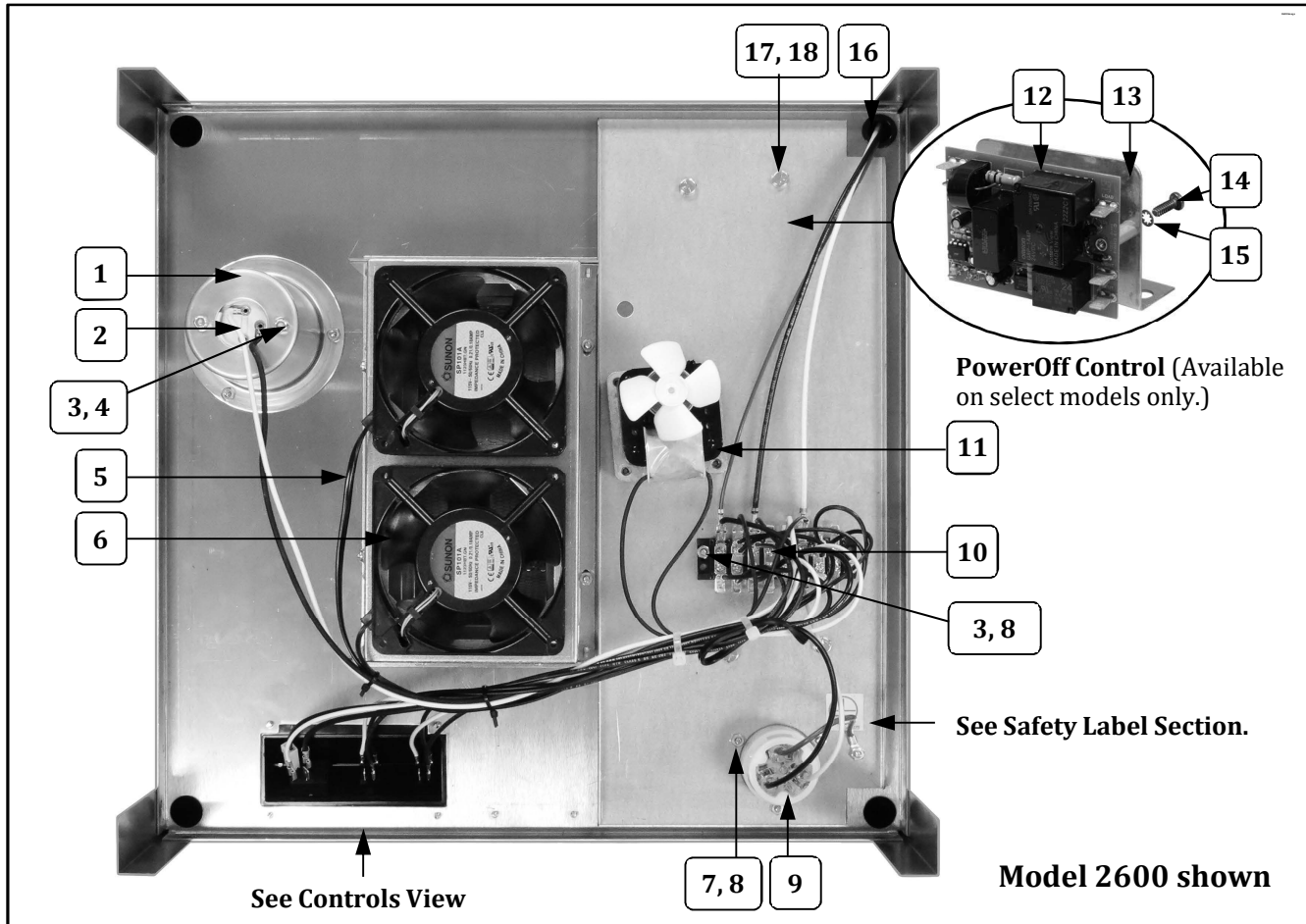

Item	Part Description	Part Number	
		2600, 2600-00-003, 2600-00-000	2600A
1	LIGHT SHIELD CONICAL	40589	40589
2	LAMP HOLDER	47047	47047
3	8-32 X 3/4 PHIL PAN MS SS	39007	39007
4	8-32 HEX NUT, ESLOK, S.S.	22070	22070
5	EXHST BLOWER PLUG & CORD	47199	47199
6	120V 60CY EXHAUST BLOWER	48018	48018
7	8-32 X 1/2 PH PAN W/SEMS	47124	47124
8	8-32 HEX M/S NUT	74149	74149
9	KETTLE LEAD IN RECPT	47327	47327
10	8 POS TERMINAL BLOCK	47208	47208
11	120V KETTLE DRIVE MOTOR	47038	47038
12	KETTLE POWEROFF CNTRL PCB		55402
13	BRACKET, POWEROFF CNTRL		55427
14	6-32 X 3/8 PHIL PAN M/S		39000
15	#6 INTERNAL TOOTH L/W 410SS		39001
16	.875 IN BUSHING, SNAP	45396	45396
17	1/4-20 X 3/4 GRADE 5 BOLT (fastens hanger arm)	74520	74520
18	MED SPLIT LOCK WASHER 1/4 (fastens hanger arm)	74526	74526

Dome Interior – Electrical Components

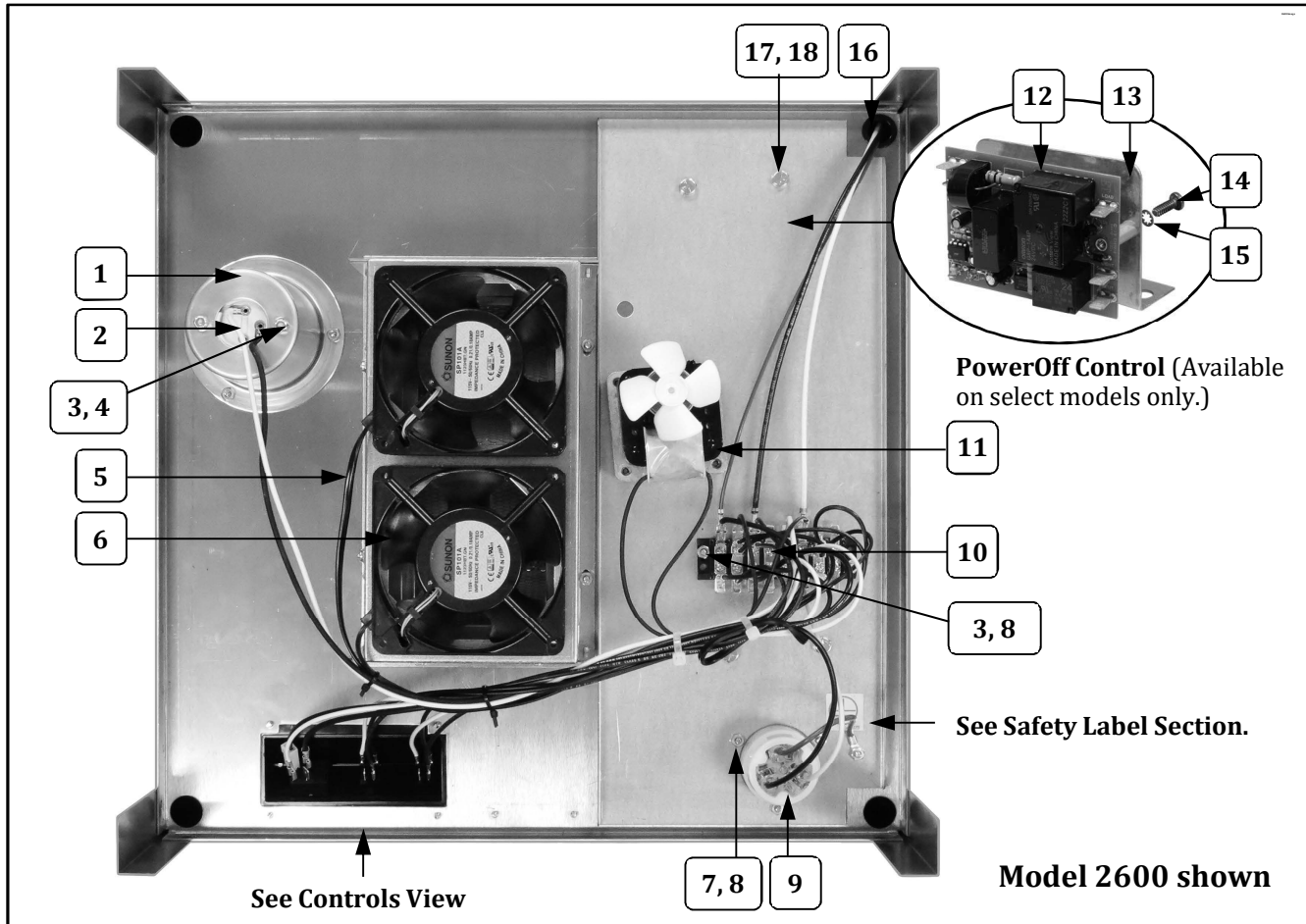

Item	Part Description	Part Number	
		2600, 2600-00-003, 2600-00-000	2600A
1	LIGHT SHIELD CONICAL	40589	40589
2	LAMP HOLDER	47047	47047
3	8-32 X 3/4 PHIL PAN MS SS	39007	39007
4	8-32 HEX NUT, ESLOK, S.S.	22070	22070
5	EXHST BLOWER PLUG & CORD	47199	47199
6	120V 60CY EXHAUST BLOWER	48018	48018
7	8-32 X 1/2 PH PAN W/SEMS	47124	47124
8	8-32 HEX M/S NUT	74149	74149
9	KETTLE LEAD IN RECPT	47327	47327
10	8 POS TERMINAL BLOCK	47208	47208
11	120V KETTLE DRIVE MOTOR	47038	47038
12	KETTLE POWEROFF CNTRL PCB		55402
13	BRACKET, POWEROFF CNTRL		55427
14	6-32 X 3/8 PHIL PAN M/S		39000
15	#6 INTERNAL TOOTH L/W 410SS		39001
16	.875 IN BUSHING, SNAP	45396	45396
17	1/4-20 X 3/4 GRADE 5 BOLT (fastens hanger arm)	74520	74520
18	MED SPLIT LOCK WASHER 1/4 (fastens hanger arm)	74526	74526

Dome Interior – Electrical Components

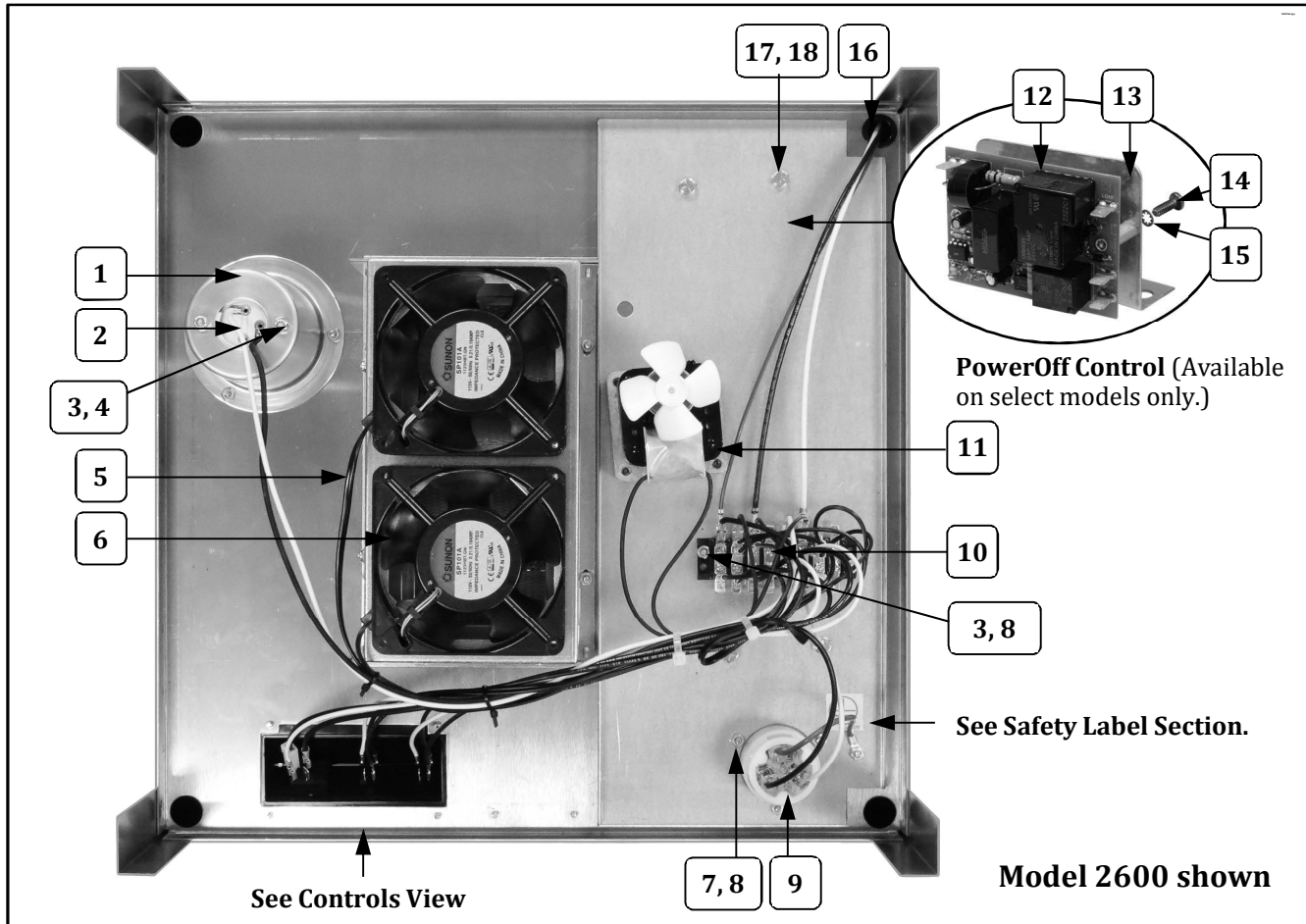

Item	Part Description	Part Number	
		2600, 2600-00-003, 2600-00-000	2600A
1	LIGHT SHIELD CONICAL	40589	40589
2	LAMP HOLDER	47047	47047
3	8-32 X 3/4 PHIL PAN MS SS	39007	39007
4	8-32 HEX NUT, ESLOK, S.S.	22070	22070
5	EXHST BLOWER PLUG & CORD	47199	47199
6	120V 60CY EXHAUST BLOWER	48018	48018
7	8-32 X 1/2 PH PAN W/SEMS	47124	47124
8	8-32 HEX M/S NUT	74149	74149
9	KETTLE LEAD IN RECPT	47327	47327
10	8 POS TERMINAL BLOCK	47208	47208
11	120V KETTLE DRIVE MOTOR	47038	47038
12	KETTLE POWEROFF CNTRL PCB		55402
13	BRACKET, POWEROFF CNTRL		55427
14	6-32 X 3/8 PHIL PAN M/S		39000
15	#6 INTERNAL TOOTH L/W 410SS		39001
16	.875 IN BUSHING, SNAP	45396	45396
17	1/4-20 X 3/4 GRADE 5 BOLT (fastens hanger arm)	74520	74520
18	MED SPLIT LOCK WASHER 1/4 (fastens hanger arm)	74526	74526

Dome Interior – Electrical Components

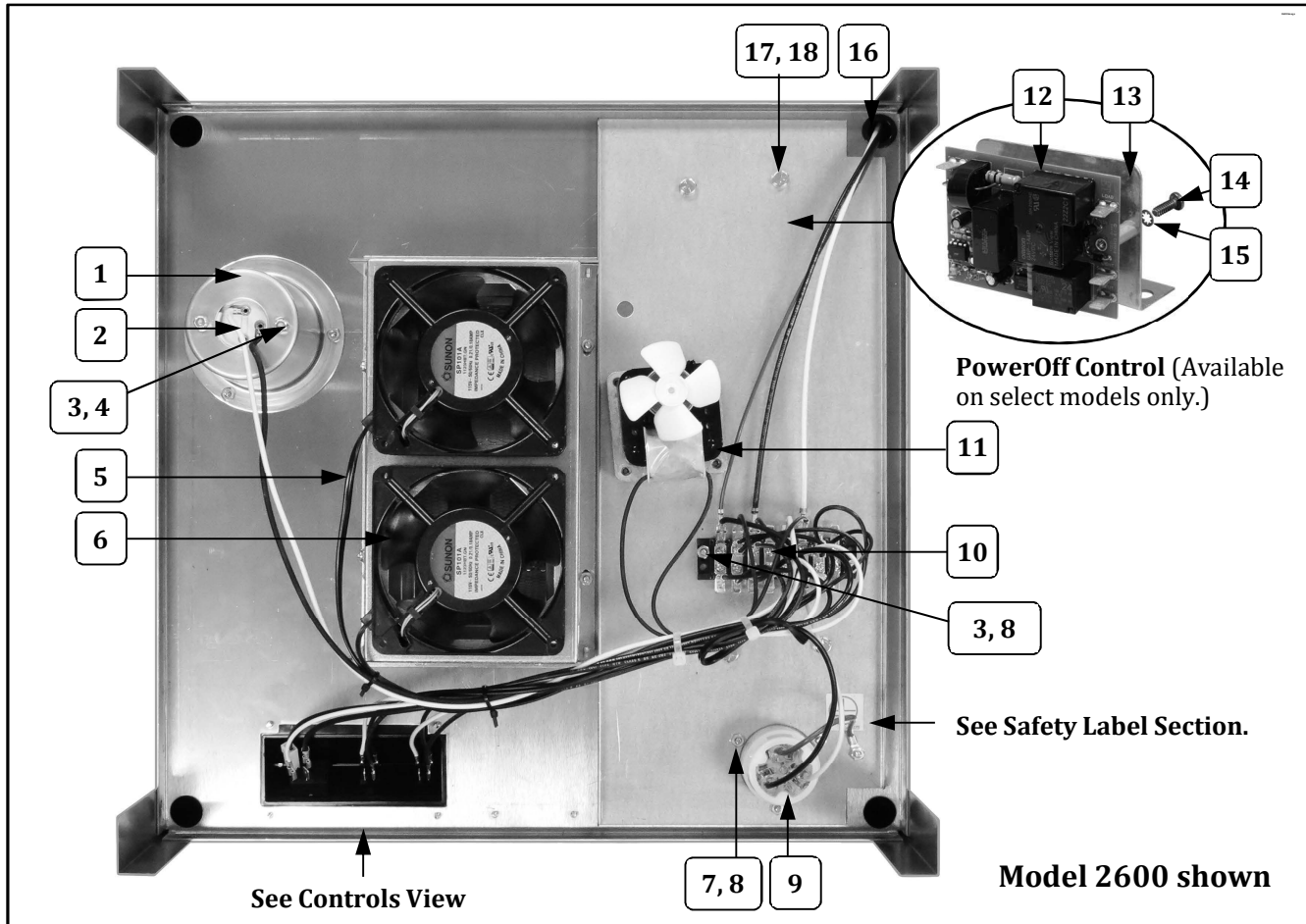

Item	Part Description	Part Number	
		2600, 2600-00-003, 2600-00-000	2600A
1	LIGHT SHIELD CONICAL	40589	40589
2	LAMP HOLDER	47047	47047
3	8-32 X 3/4 PHIL PAN MS SS	39007	39007
4	8-32 HEX NUT, ESLOK, S.S.	22070	22070
5	EXHST BLOWER PLUG & CORD	47199	47199
6	120V 60CY EXHAUST BLOWER	48018	48018
7	8-32 X 1/2 PH PAN W/SEMS	47124	47124
8	8-32 HEX M/S NUT	74149	74149
9	KETTLE LEAD IN RECPT	47327	47327
10	8 POS TERMINAL BLOCK	47208	47208
11	120V KETTLE DRIVE MOTOR	47038	47038
12	KETTLE POWEROFF CNTRL PCB		55402
13	BRACKET, POWEROFF CNTRL		55427
14	6-32 X 3/8 PHIL PAN M/S		39000
15	#6 INTERNAL TOOTH L/W 410SS		39001
16	.875 IN BUSHING, SNAP	45396	45396
17	1/4-20 X 3/4 GRADE 5 BOLT (fastens hanger arm)	74520	74520
18	MED SPLIT LOCK WASHER 1/4 (fastens hanger arm)	74526	74526

Dome Interior – Electrical Components

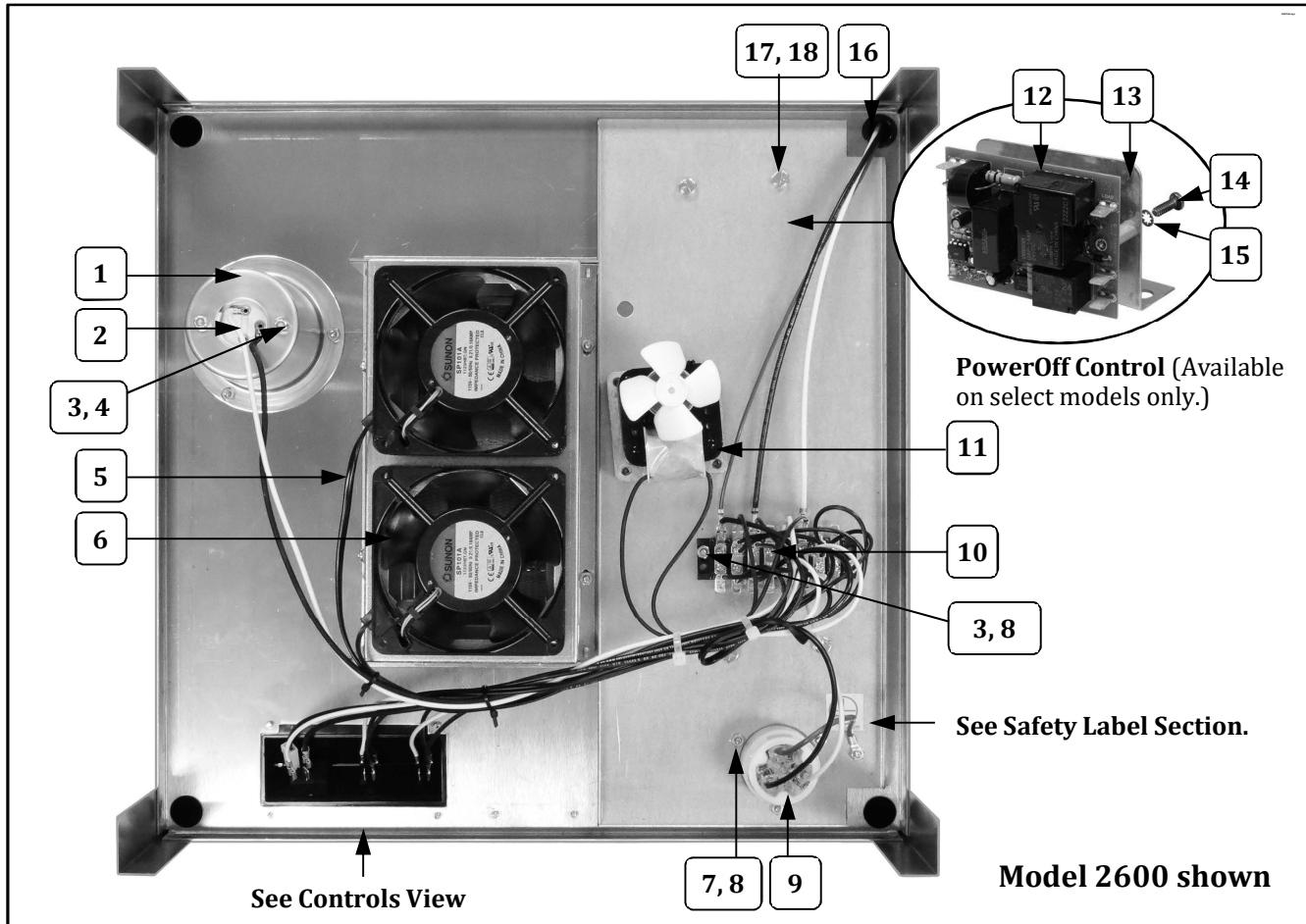

Item	Part Description	Part Number	
		2600, 2600-00-003, 2600-00-000	2600A
1	LIGHT SHIELD CONICAL	40589	40589
2	LAMP HOLDER	47047	47047
3	8-32 X 3/4 PHIL PAN MS SS	39007	39007
4	8-32 HEX NUT, ESLOK, S.S.	22070	22070
5	EXHST BLOWER PLUG & CORD	47199	47199
6	120V 60CY EXHAUST BLOWER	48018	48018
7	8-32 X 1/2 PH PAN W/SEMS	47124	47124
8	8-32 HEX M/S NUT	74149	74149
9	KETTLE LEAD IN RECPT	47327	47327
10	8 POS TERMINAL BLOCK	47208	47208
11	120V KETTLE DRIVE MOTOR	47038	47038
12	KETTLE POWEROFF CNTRL PCB		55402
13	BRACKET, POWEROFF CNTRL		55427
14	6-32 X 3/8 PHIL PAN M/S		39000
15	#6 INTERNAL TOOTH L/W 410SS		39001
16	.875 IN BUSHING, SNAP	45396	45396
17	1/4-20 X 3/4 GRADE 5 BOLT (fastens hanger arm)	74520	74520
18	MED SPLIT LOCK WASHER 1/4 (fastens hanger arm)	74526	74526

Dome Interior – Electrical Components

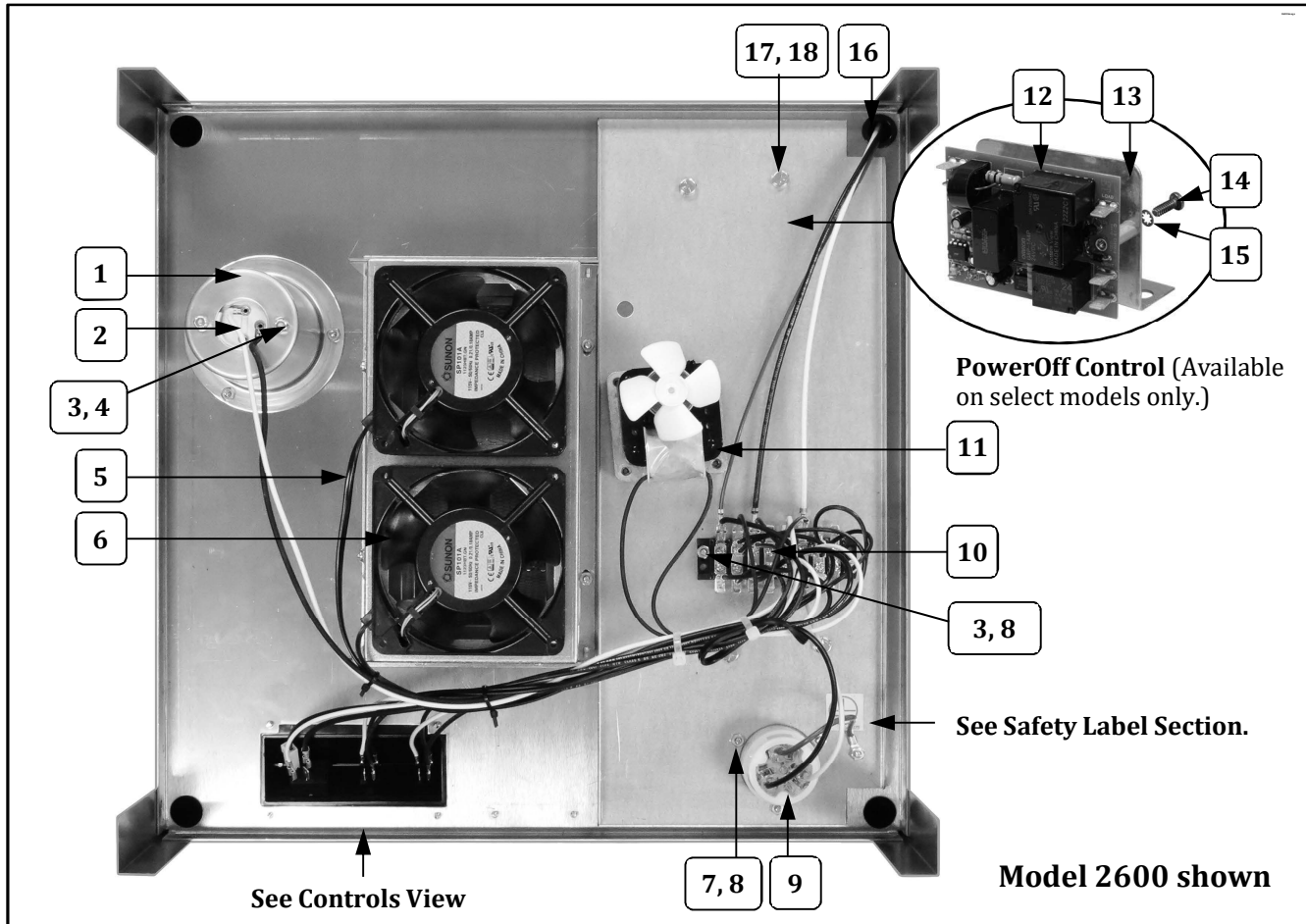

Item	Part Description	Part Number	
		2600, 2600-00-003, 2600-00-000	2600A
1	LIGHT SHIELD CONICAL	40589	40589
2	LAMP HOLDER	47047	47047
3	8-32 X 3/4 PHIL PAN MS SS	39007	39007
4	8-32 HEX NUT, ESLOK, S.S.	22070	22070
5	EXHST BLOWER PLUG & CORD	47199	47199
6	120V 60CY EXHAUST BLOWER	48018	48018
7	8-32 X 1/2 PH PAN W/SEMS	47124	47124
8	8-32 HEX M/S NUT	74149	74149
9	KETTLE LEAD IN RECPT	47327	47327
10	8 POS TERMINAL BLOCK	47208	47208
11	120V KETTLE DRIVE MOTOR	47038	47038
12	KETTLE POWEROFF CNTRL PCB		55402
13	BRACKET, POWEROFF CNTRL		55427
14	6-32 X 3/8 PHIL PAN M/S		39000
15	#6 INTERNAL TOOTH L/W 410SS		39001
16	.875 IN BUSHING, SNAP	45396	45396
17	1/4-20 X 3/4 GRADE 5 BOLT (fastens hanger arm)	74520	74520
18	MED SPLIT LOCK WASHER 1/4 (fastens hanger arm)	74526	74526

Lighted Sign Assembly – Model 2600-00-000

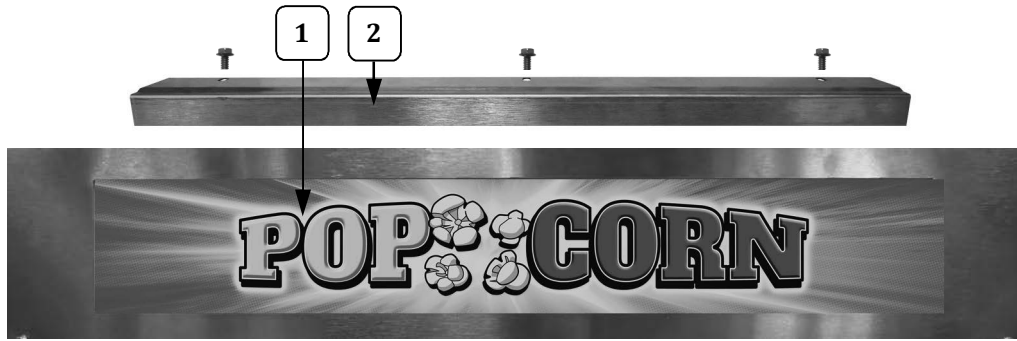

Front Sign View

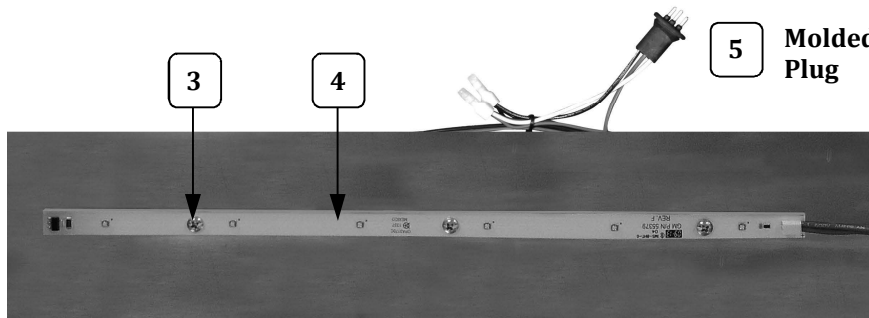

Interior View - LED Strip

General lighting image shown for reference.

5 Molded Plug

6 Molded Receptacle (not shown)



7 Power Supply located on back of LED mount.

8,9 Power Supply fasteners

Item	Part Description	Part Number
		2600-00-000
1	POPCORN SIGN	111876
2	DOME SUPPORT ANGLE	77789
3	SCREW #8-32X3/8 PAN HD PH	74141
4	LED STRIP COOL WHITE	55379
5	MOLDED PLUG	47726
6	MOLDED RECEPTACLE	41712
7	POWER SUPPLY	55394
8	6-32 X 1/2 PHIL PAN (Mounts Power Supply)	42237
9	6-32 NUT (Mounts Power Supply)	47517

Lighted Sign Assembly – Model 2600-00-000

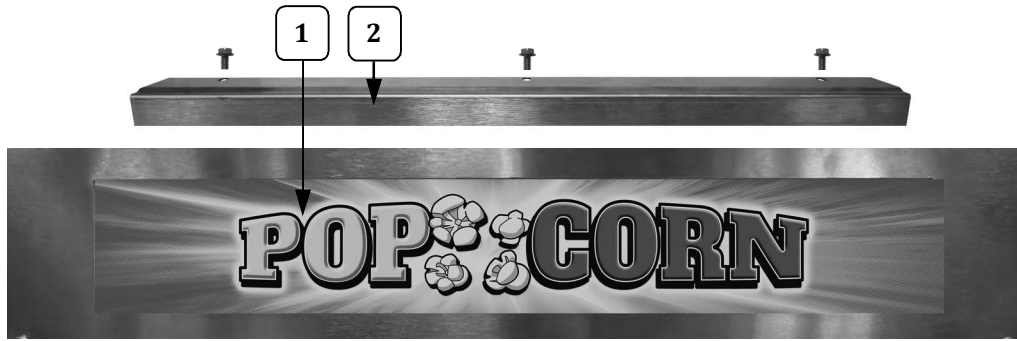

Front Sign View

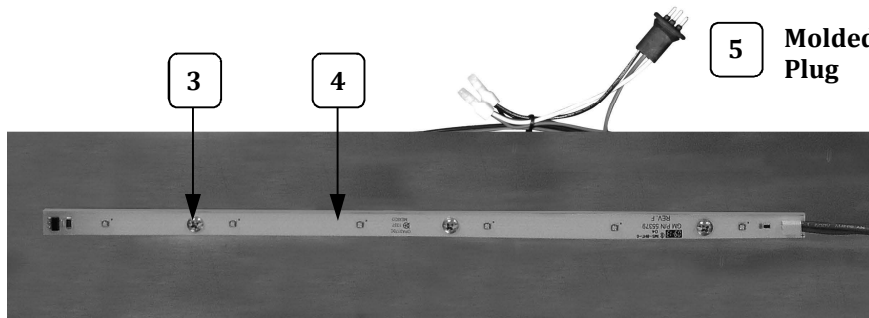

Interior View - LED Strip

General lighting image shown for reference.

5 Molded Plug

6 Molded Receptacle (not shown)



7 Power Supply located on back of LED mount.

8,9 Power Supply fasteners

Item	Part Description	Part Number
		2600-00-000
1	POPCORN SIGN	111876
2	DOMESUPPORT ANGLE	77789
3	SCREW #8-32X3/8 PAN HD PH	74141
4	LED STRIP COOL WHITE	55379
5	MOLDED PLUG	47726
6	MOLDED RECEPTACLE	41712
7	POWER SUPPLY	55394
8	6-32 X 1/2 PHIL PAN (Mounts Power Supply)	42237
9	6-32 NUT (Mounts Power Supply)	47517

Lighted Sign Assembly – Model 2600-00-000

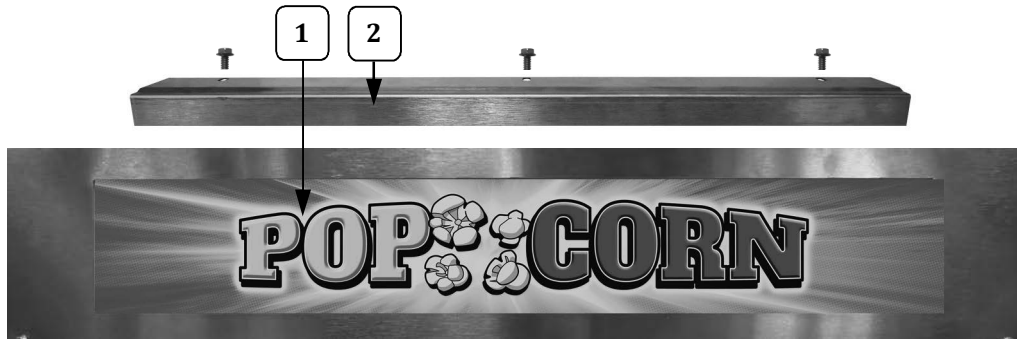

Front Sign View

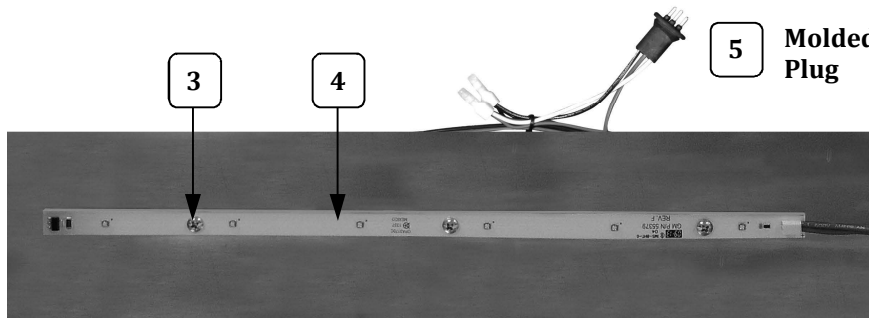

Interior View - LED Strip

General lighting image shown for reference.

5 Molded Plug

6 Molded Receptacle (not shown)



7 Power Supply located on back of LED mount.

8,9 Power Supply fasteners

Item	Part Description	Part Number
		2600-00-000
1	POPCORN SIGN	111876
2	DOME SUPPORT ANGLE	77789
3	SCREW #8-32X3/8 PAN HD PH	74141
4	LED STRIP COOL WHITE	55379
5	MOLDED PLUG	47726
6	MOLDED RECEPTACLE	41712
7	POWER SUPPLY	55394
8	6-32 X 1/2 PHIL PAN (Mounts Power Supply)	42237
9	6-32 NUT (Mounts Power Supply)	47517

Lighted Sign Assembly – Model 2600-00-000

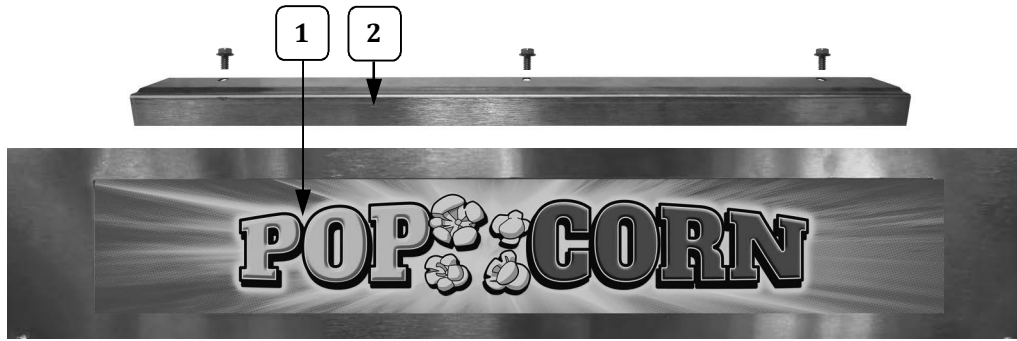

Front Sign View

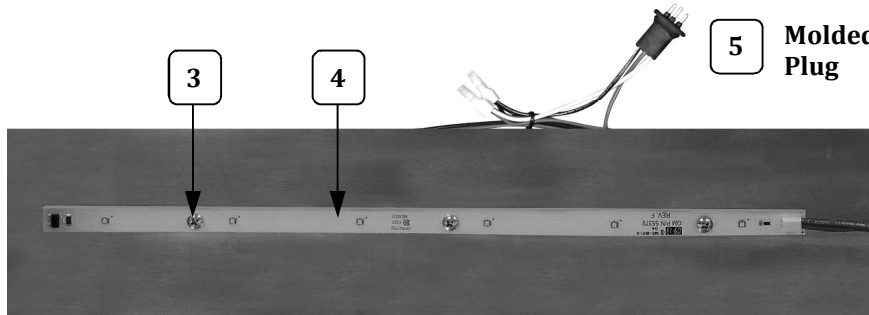

Interior View - LED Strip

General lighting image shown for reference.

5 Molded Plug

6 Molded Receptacle (not shown)



7 Power Supply located on back of LED mount.

8,9 Power Supply fasteners

Item	Part Description	Part Number
		2600-00-000
1	POPCORN SIGN	111876
2	DOME SUPPORT ANGLE	77789
3	SCREW #8-32X3/8 PAN HD PH	74141
4	LED STRIP COOL WHITE	55379
5	MOLDED PLUG	47726
6	MOLDED RECEPTACLE	41712
7	POWER SUPPLY	55394
8	6-32 X 1/2 PHIL PAN (Mounts Power Supply)	42237
9	6-32 NUT (Mounts Power Supply)	47517

Lighted Sign Assembly – Model 2600-00-000

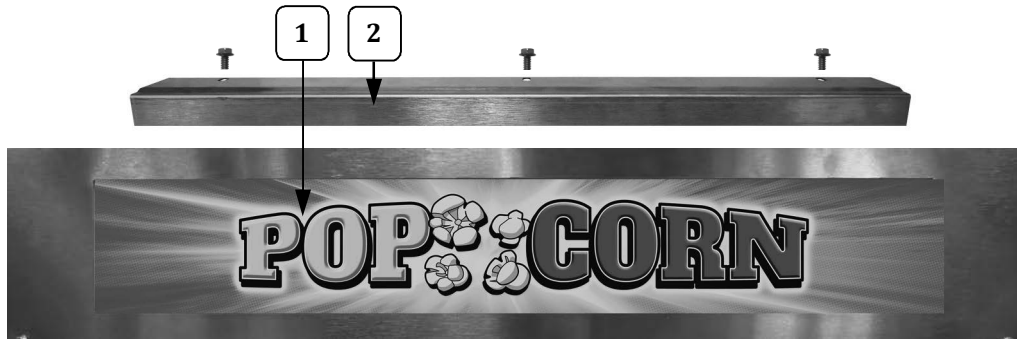

Front Sign View

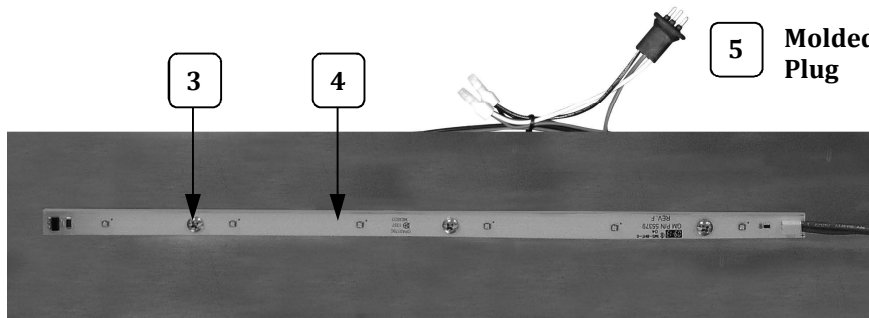

Interior View - LED Strip

General lighting image shown for reference.

5 Molded Plug

6 Molded Receptacle (not shown)



7 Power Supply located on back of LED mount.

8,9 Power Supply fasteners

Item	Part Description	Part Number
		2600-00-000
1	POPCORN SIGN	111876
2	DOME SUPPORT ANGLE	77789
3	SCREW #8-32X3/8 PAN HD PH	74141
4	LED STRIP COOL WHITE	55379
5	MOLDED PLUG	47726
6	MOLDED RECEPTACLE	41712
7	POWER SUPPLY	55394
8	6-32 X 1/2 PHIL PAN (Mounts Power Supply)	42237
9	6-32 NUT (Mounts Power Supply)	47517

Lighted Sign Assembly – Model 2600-00-000

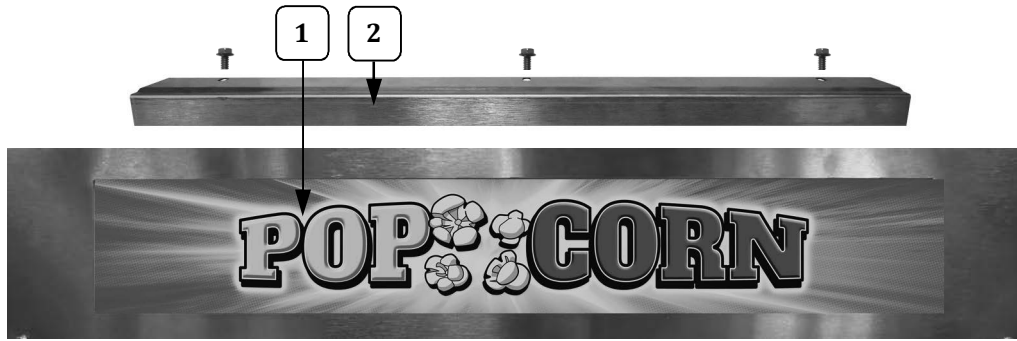

Front Sign View

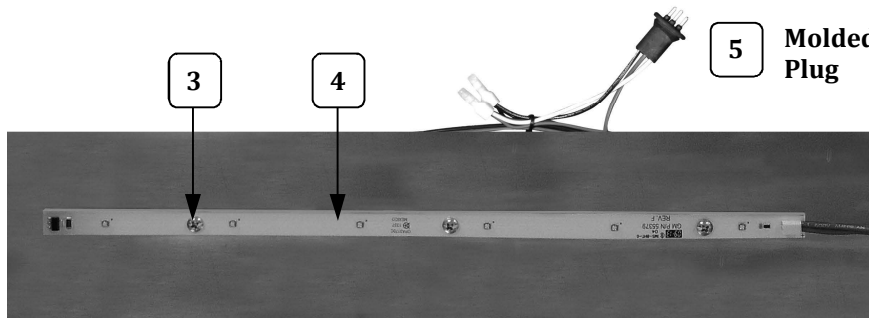

Interior View - LED Strip

General lighting image shown for reference.

5 Molded Plug

6 Molded Receptacle (not shown)



7 Power Supply located on back of LED mount.

8,9 Power Supply fasteners

Item	Part Description	Part Number
		2600-00-000
1	POPCORN SIGN	111876
2	DOMESUPPORT ANGLE	77789
3	SCREW #8-32X3/8 PAN HD PH	74141
4	LED STRIP COOL WHITE	55379
5	MOLDED PLUG	47726
6	MOLDED RECEPTACLE	41712
7	POWER SUPPLY	55394
8	6-32 X 1/2 PHIL PAN (Mounts Power Supply)	42237
9	6-32 NUT (Mounts Power Supply)	47517

Lighted Sign Assembly – Model 2600-00-000

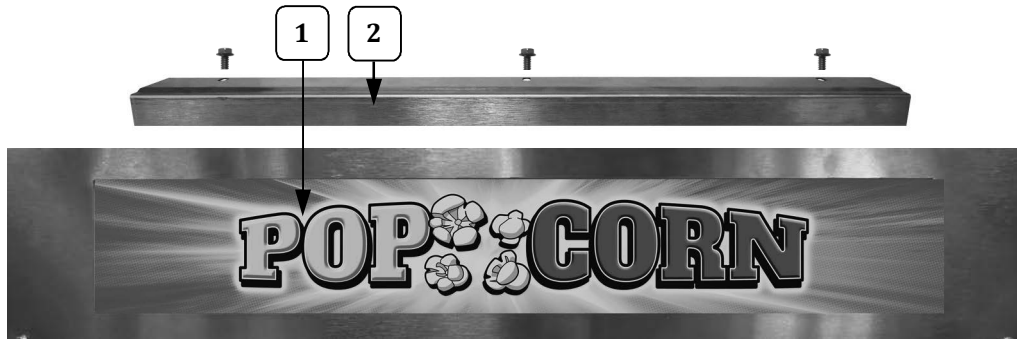

Front Sign View

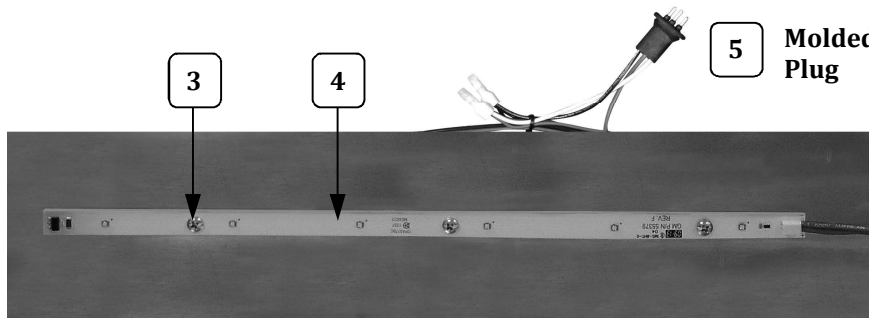

Interior View - LED Strip

General lighting image shown for reference.

5 Molded Plug

6 Molded Receptacle (not shown)



7 Power Supply located on back of LED mount.

8,9 Power Supply fasteners

Item	Part Description	Part Number
		2600-00-000
1	POPCORN SIGN	111876
2	DOME SUPPORT ANGLE	77789
3	SCREW #8-32X3/8 PAN HD PH	74141
4	LED STRIP COOL WHITE	55379
5	MOLDED PLUG	47726
6	MOLDED RECEPTACLE	41712
7	POWER SUPPLY	55394
8	6-32 X 1/2 PHIL PAN (Mounts Power Supply)	42237
9	6-32 NUT (Mounts Power Supply)	47517

Lighted Sign Assembly – Model 2600-00-000

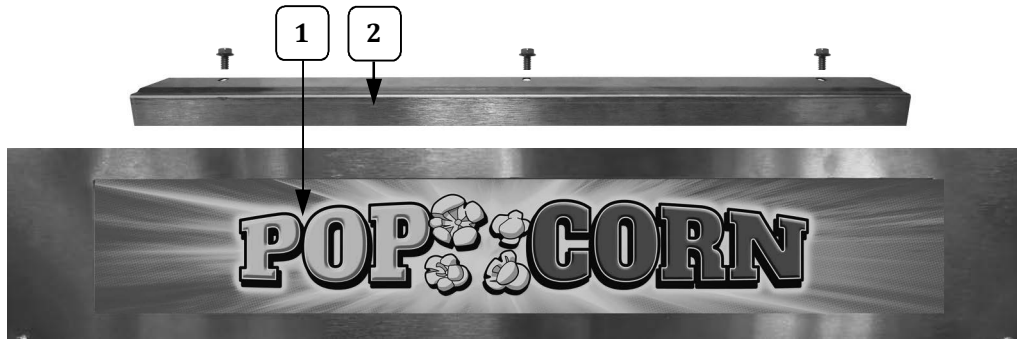

Front Sign View

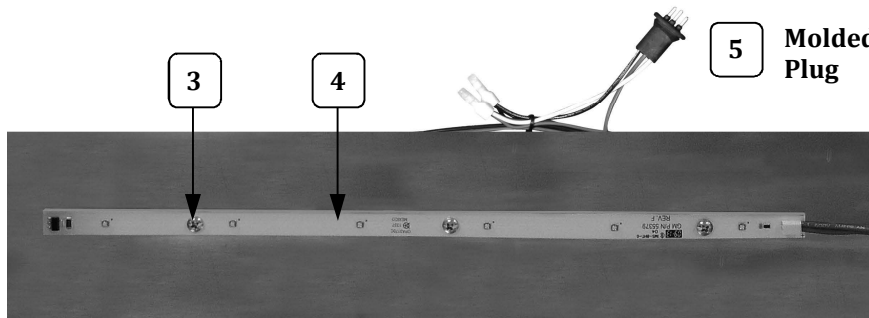

Interior View - LED Strip

General lighting image shown for reference.

5 Molded Plug

6 Molded Receptacle (not shown)



7 Power Supply located on back of LED mount.

8,9 Power Supply fasteners

Item	Part Description	Part Number
		2600-00-000
1	POPCORN SIGN	111876
2	DOME SUPPORT ANGLE	77789
3	SCREW #8-32X3/8 PAN HD PH	74141
4	LED STRIP COOL WHITE	55379
5	MOLDED PLUG	47726
6	MOLDED RECEPTACLE	41712
7	POWER SUPPLY	55394
8	6-32 X 1/2 PHIL PAN (Mounts Power Supply)	42237
9	6-32 NUT (Mounts Power Supply)	47517

Safety Labels

1

2

3

4

Label used on units with the PowerOff Control feature.

5

Kettle Lead-In Label

6

Power Cord Label

Unit Labels

Power Cord Label

Item	Part Description	Part Number	
		2600, 2600-00-003, 2600-00-000	2600A
1	UNIVERSAL POPPER DECAL	41019	41019
2	WARNING, MAX LAMP 50W	74795	74795
3	MAIN GROUND LABEL	42375	42375
4	LABEL POWEROFF CNTRL		55436
5	CONDUIT WARNING LABEL	82840	82840
6	WARNING LABEL CORD	68720	68720

Accessories

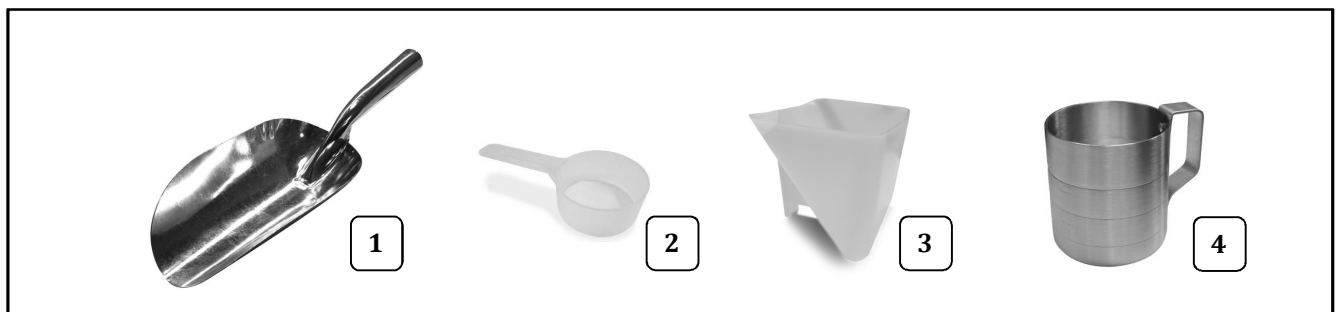

Item	Part Description	Part Number
		All Models
1	STAMPED ALUM SCOOP	2071
2	MEASURE 20 CC	47680
3	MEASURE 6 OZ	49049
4	16OZ CORN MEASURE W/HANDL	68050

Safety Labels

1 

2 

3 

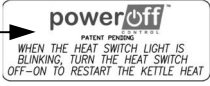
4 

Label used on units with the PowerOff Control feature.

5 

6 

Power Cord Label

Unit Labels

Power Cord Label

Item	Part Description	Part Number	
		2600, 2600-00-003, 2600-00-000	2600A
1	UNIVERSAL POPPER DECAL	41019	41019
2	WARNING, MAX LAMP 50W	74795	74795
3	MAIN GROUND LABEL	42375	42375
4	LABEL POWEROFF CNTRL		55436
5	CONDUIT WARNING LABEL	82840	82840
6	WARNING LABEL CORD	68720	68720

Accessories

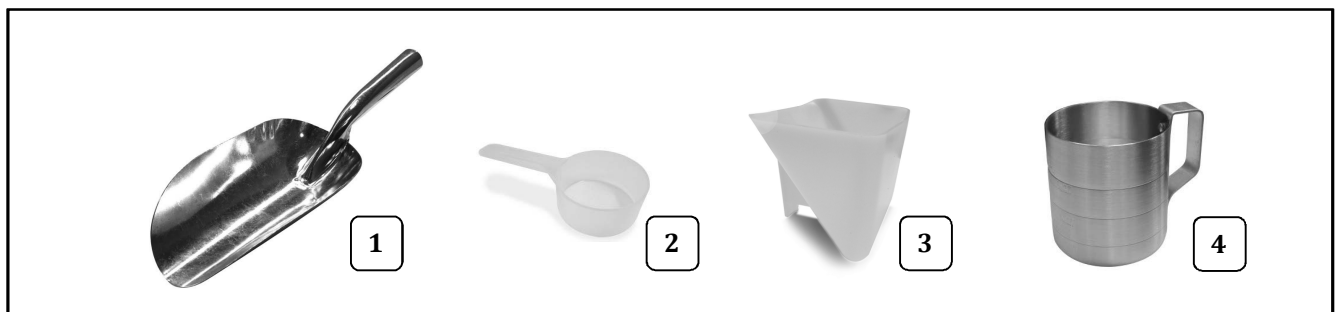

Item	Part Description	Part Number
		All Models
1	STAMPED ALUM SCOOP	2071
2	MEASURE 20 CC	47680
3	MEASURE 6 OZ	49049
4	16OZ CORN MEASURE W/HANDL	68050

Safety Labels

1

2

3

4

Label used on units with the PowerOff Control feature.

5

6

Kettle Lead-In Label

Power Cord Label

Unit Labels

Power Cord Label

Item	Part Description	Part Number	
		2600, 2600-00-003, 2600-00-000	2600A
1	UNIVERSAL POPPER DECAL	41019	41019
2	WARNING, MAX LAMP 50W	74795	74795
3	MAIN GROUND LABEL	42375	42375
4	LABEL POWEROFF CNTRL		55436
5	CONDUIT WARNING LABEL	82840	82840
6	WARNING LABEL CORD	68720	68720

Accessories

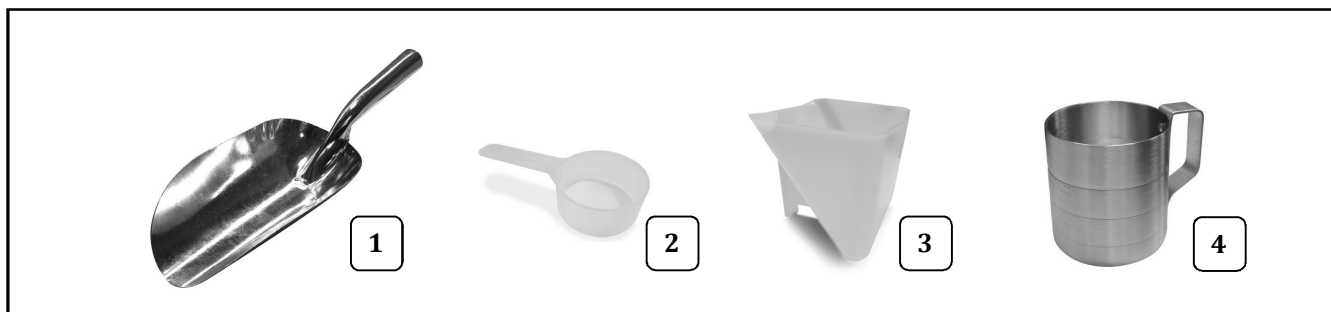

Item	Part Description	Part Number
		All Models
1	STAMPED ALUM SCOOP	2071
2	MEASURE 20 CC	47680
3	MEASURE 6 OZ	49049
4	16OZ CORN MEASURE W/HANDL	68050

Safety Labels

1

2

3

4

Label used on units with the PowerOff Control feature.

5

6

Kettle Lead-In Label

Power Cord Label

Unit Labels

Power Cord Label

Item	Part Description	Part Number	
		2600, 2600-00-003, 2600-00-000	2600A
1	UNIVERSAL POPPER DECAL	41019	41019
2	WARNING, MAX LAMP 50W	74795	74795
3	MAIN GROUND LABEL	42375	42375
4	LABEL POWEROFF CNTRL		55436
5	CONDUIT WARNING LABEL	82840	82840
6	WARNING LABEL CORD	68720	68720

Accessories

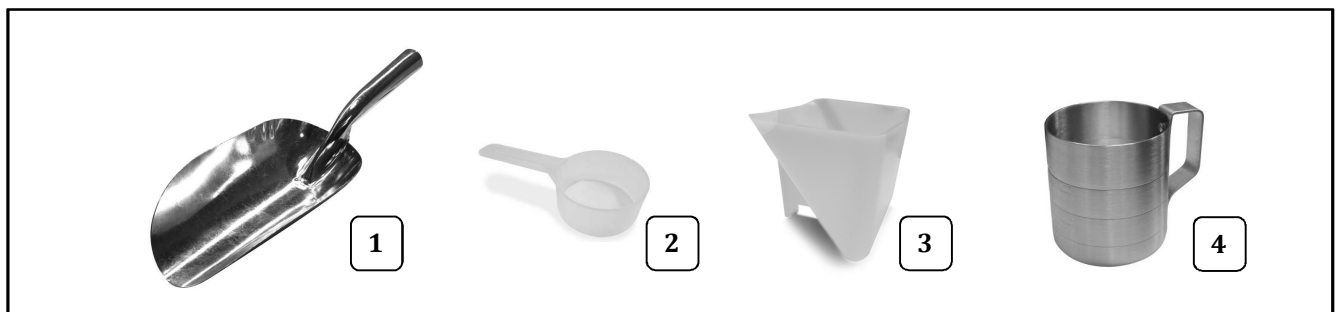

Item	Part Description	Part Number
		All Models
1	STAMPED ALUM SCOOP	2071
2	MEASURE 20 CC	47680
3	MEASURE 6 OZ	49049
4	16OZ CORN MEASURE W/HANDL	68050

Safety Labels

1

2

3

4

Label used on units with the PowerOff Control feature.

5

6

Kettle Lead-In Label

Power Cord Label

Unit Labels

Power Cord Label

Item	Part Description	Part Number	
		2600, 2600-00-003, 2600-00-000	2600A
1	UNIVERSAL POPPER DECAL	41019	41019
2	WARNING, MAX LAMP 50W	74795	74795
3	MAIN GROUND LABEL	42375	42375
4	LABEL POWEROFF CNTRL		55436
5	CONDUIT WARNING LABEL	82840	82840
6	WARNING LABEL CORD	68720	68720

Accessories

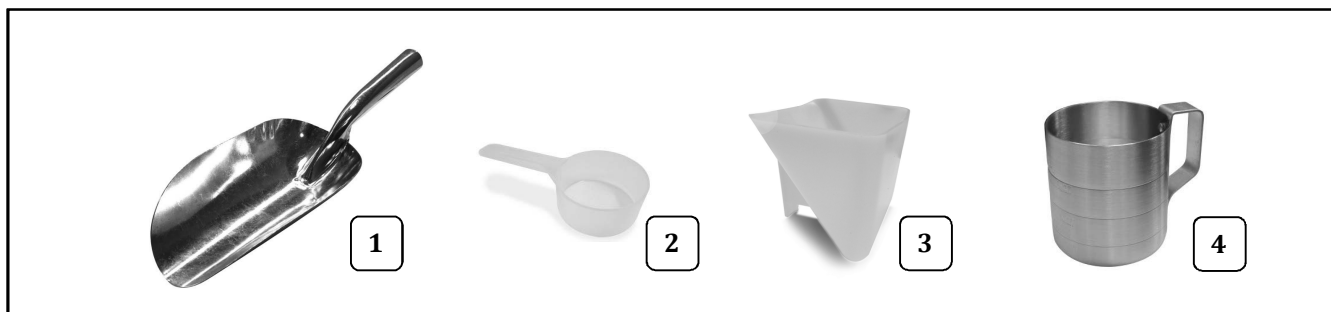

Item	Part Description	Part Number
		All Models
1	STAMPED ALUM SCOOP	2071
2	MEASURE 20 CC	47680
3	MEASURE 6 OZ	49049
4	16OZ CORN MEASURE W/HANDL	68050

Safety Labels

1

2

3

4

Label used on units with the PowerOff Control feature.

5

6

Kettle Lead-In Label

Power Cord Label

Unit Labels

Power Cord Label

Item	Part Description	Part Number	
		2600, 2600-00-003, 2600-00-000	2600A
1	UNIVERSAL POPPER DECAL	41019	41019
2	WARNING, MAX LAMP 50W	74795	74795
3	MAIN GROUND LABEL	42375	42375
4	LABEL POWEROFF CNTRL		55436
5	CONDUIT WARNING LABEL	82840	82840
6	WARNING LABEL CORD	68720	68720

Accessories

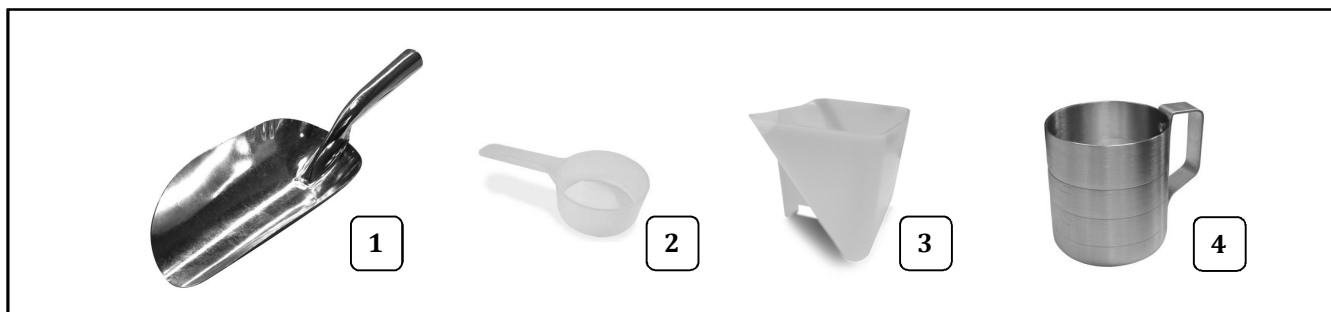

Item	Part Description	Part Number
		All Models
1	STAMPED ALUM SCOOP	2071
2	MEASURE 20 CC	47680
3	MEASURE 6 OZ	49049
4	16OZ CORN MEASURE W/HANDL	68050

Safety Labels

1

2

3

4

Unit Labels

5

Kettle Lead-In Label

6

Power Cord Label

Item	Part Description	Part Number	
		2600, 2600-00-003, 2600-00-000	2600A
1	UNIVERSAL POPPER DECAL	41019	41019
2	WARNING, MAX LAMP 50W	74795	74795
3	MAIN GROUND LABEL	42375	42375
4	LABEL POWEROFF CNTRL		55436
5	CONDUIT WARNING LABEL	82840	82840
6	WARNING LABEL CORD	68720	68720

Accessories

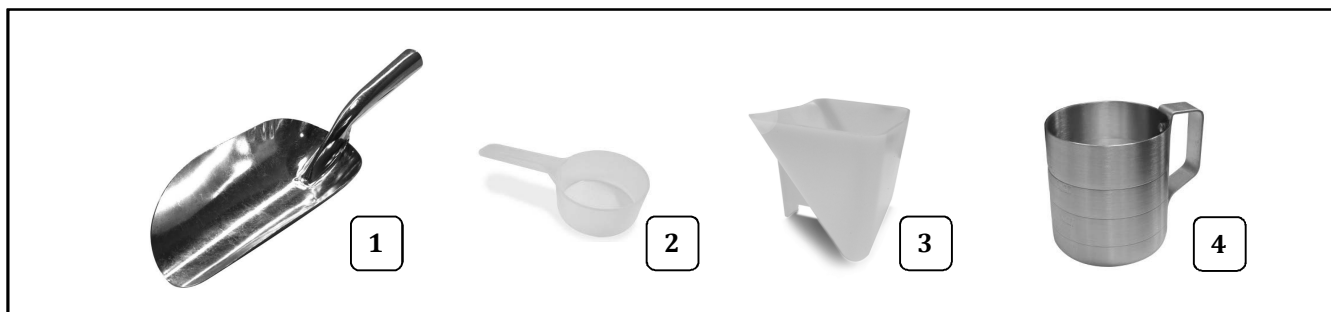

Item	Part Description	Part Number
		All Models
1	STAMPED ALUM SCOOP	2071
2	MEASURE 20 CC	47680
3	MEASURE 6 OZ	49049
4	16OZ CORN MEASURE W/HANDL	68050

Safety Labels

1

2

3

4

Label used on units with the PowerOff Control feature.

5

6

Kettle Lead-In Label

Power Cord Label

Unit Labels

Power Cord Label

Item	Part Description	Part Number	
		2600, 2600-00-003, 2600-00-000	2600A
1	UNIVERSAL POPPER DECAL	41019	41019
2	WARNING, MAX LAMP 50W	74795	74795
3	MAIN GROUND LABEL	42375	42375
4	LABEL POWEROFF CNTRL		55436
5	CONDUIT WARNING LABEL	82840	82840
6	WARNING LABEL CORD	68720	68720

Accessories

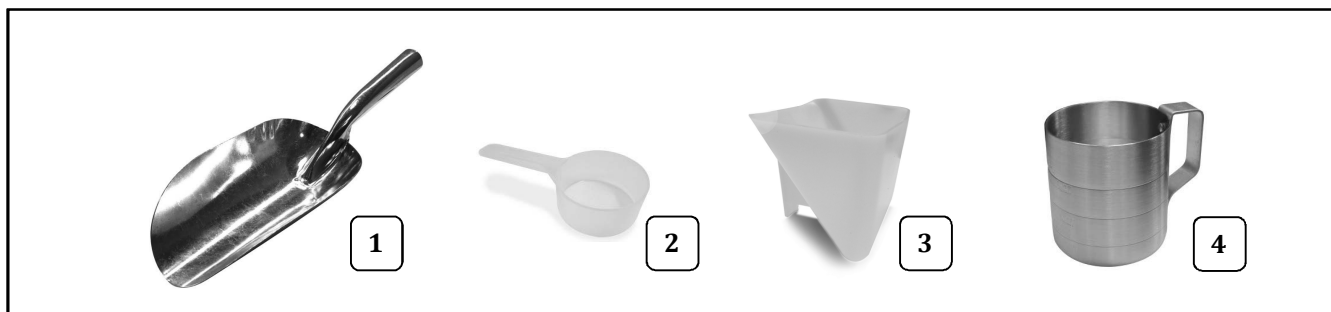

Item	Part Description	Part Number
		All Models
1	STAMPED ALUM SCOOP	2071
2	MEASURE 20 CC	47680
3	MEASURE 6 OZ	49049
4	16OZ CORN MEASURE W/HANDL	68050

Safety Labels

1

2

3

4

Label used on units with the PowerOff Control feature.

5

6

Kettle Lead-In Label

Power Cord Label

Unit Labels

Power Cord Label

Item	Part Description	Part Number	
		2600, 2600-00-003, 2600-00-000	2600A
1	UNIVERSAL POPPER DECAL	41019	41019
2	WARNING, MAX LAMP 50W	74795	74795
3	MAIN GROUND LABEL	42375	42375
4	LABEL POWEROFF CNTRL		55436
5	CONDUIT WARNING LABEL	82840	82840
6	WARNING LABEL CORD	68720	68720

Accessories

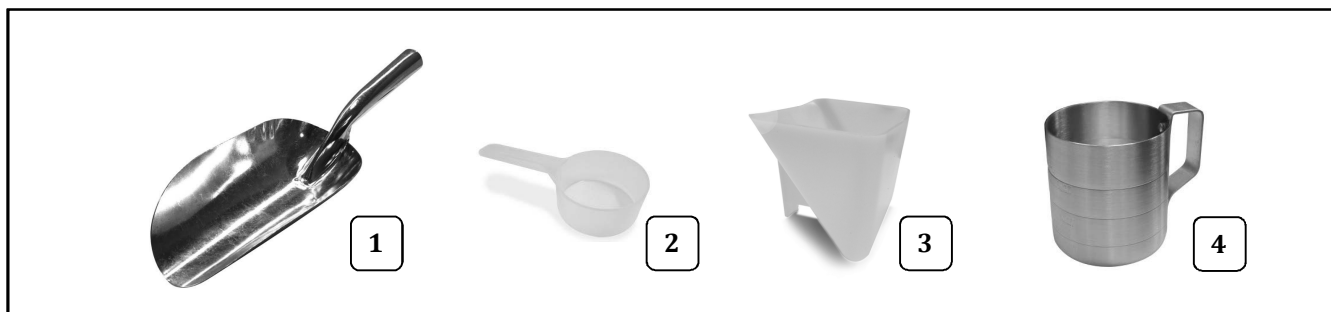

Item	Part Description	Part Number
		All Models
1	STAMPED ALUM SCOOP	2071
2	MEASURE 20 CC	47680
3	MEASURE 6 OZ	49049
4	16OZ CORN MEASURE W/HANDL	68050

Safety Labels

1

2

3

4

Label used on units with the PowerOff Control feature.

5

6

Kettle Lead-In Label

Power Cord Label

Unit Labels

Power Cord Label

Item	Part Description	Part Number	
		2600, 2600-00-003, 2600-00-000	2600A
1	UNIVERSAL POPPER DECAL	41019	41019
2	WARNING, MAX LAMP 50W	74795	74795
3	MAIN GROUND LABEL	42375	42375
4	LABEL POWEROFF CNTRL		55436
5	CONDUIT WARNING LABEL	82840	82840
6	WARNING LABEL CORD	68720	68720

Accessories

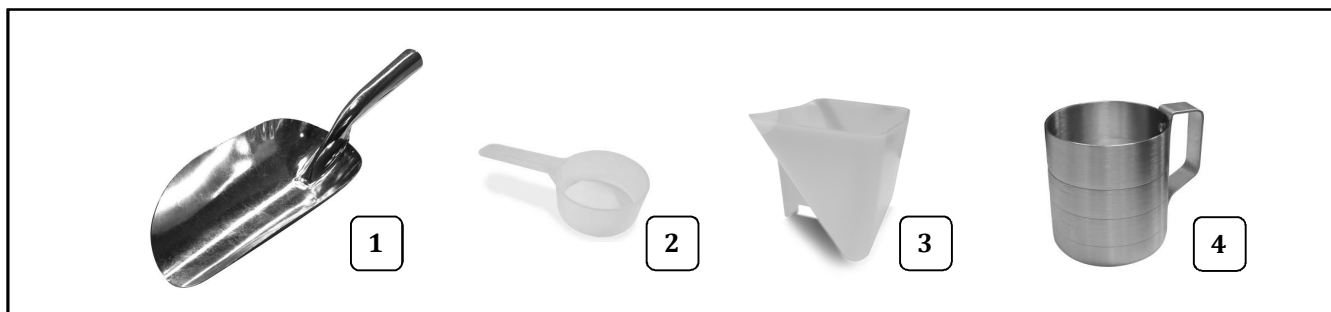

Item	Part Description	Part Number
		All Models
1	STAMPED ALUM SCOOP	2071
2	MEASURE 20 CC	47680
3	MEASURE 6 OZ	49049
4	16OZ CORN MEASURE W/HANDL	68050

Safety Labels

1

2

3

4

Label used on units with the PowerOff Control feature.

5

6

Kettle Lead-In Label

Power Cord Label

Unit Labels

Power Cord Label

Item	Part Description	Part Number	
		2600, 2600-00-003, 2600-00-000	2600A
1	UNIVERSAL POPPER DECAL	41019	41019
2	WARNING, MAX LAMP 50W	74795	74795
3	MAIN GROUND LABEL	42375	42375
4	LABEL POWEROFF CNTRL		55436
5	CONDUIT WARNING LABEL	82840	82840
6	WARNING LABEL CORD	68720	68720

Accessories

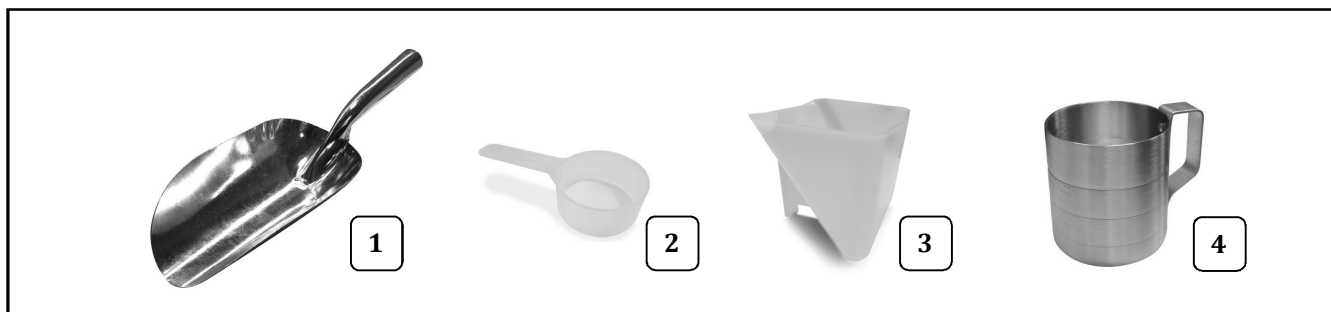

Item	Part Description	Part Number
		All Models
1	STAMPED ALUM SCOOP	2071
2	MEASURE 20 CC	47680
3	MEASURE 6 OZ	49049
4	16OZ CORN MEASURE W/HANDL	68050

Safety Labels

1

2

3

4

Label used on units with the PowerOff Control feature.

5

6

Kettle Lead-In Label

Power Cord Label

Unit Labels

Power Cord Label

Item	Part Description	Part Number	
		2600, 2600-00-003, 2600-00-000	2600A
1	UNIVERSAL POPPER DECAL	41019	41019
2	WARNING, MAX LAMP 50W	74795	74795
3	MAIN GROUND LABEL	42375	42375
4	LABEL POWEROFF CNTRL		55436
5	CONDUIT WARNING LABEL	82840	82840
6	WARNING LABEL CORD	68720	68720

Accessories

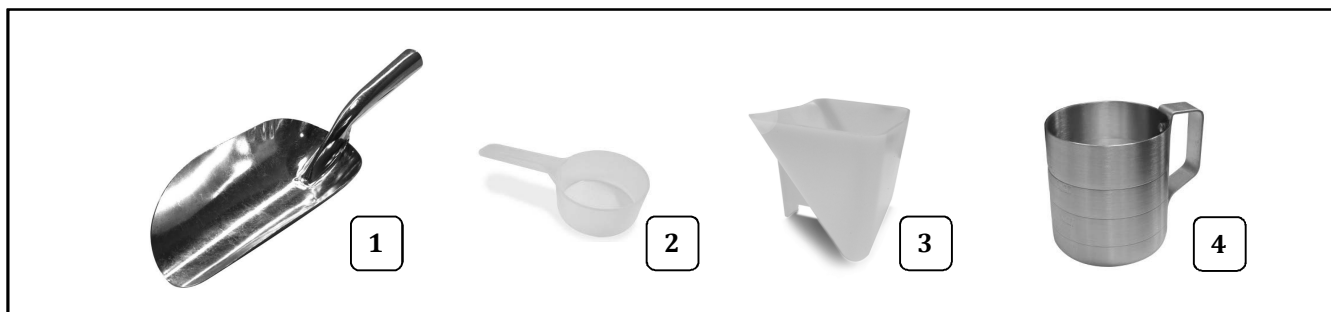

Item	Part Description	Part Number
		All Models
1	STAMPED ALUM SCOOP	2071
2	MEASURE 20 CC	47680
3	MEASURE 6 OZ	49049
4	16OZ CORN MEASURE W/HANDL	68050

Safety Labels

1

2

3

4

Label used on units with the PowerOff Control feature.

5

6

Kettle Lead-In Label

Power Cord Label

Unit Labels

Power Cord Label

Item	Part Description	Part Number	
		2600, 2600-00-003, 2600-00-000	2600A
1	UNIVERSAL POPPER DECAL	41019	41019
2	WARNING, MAX LAMP 50W	74795	74795
3	MAIN GROUND LABEL	42375	42375
4	LABEL POWEROFF CNTRL		55436
5	CONDUIT WARNING LABEL	82840	82840
6	WARNING LABEL CORD	68720	68720

Accessories

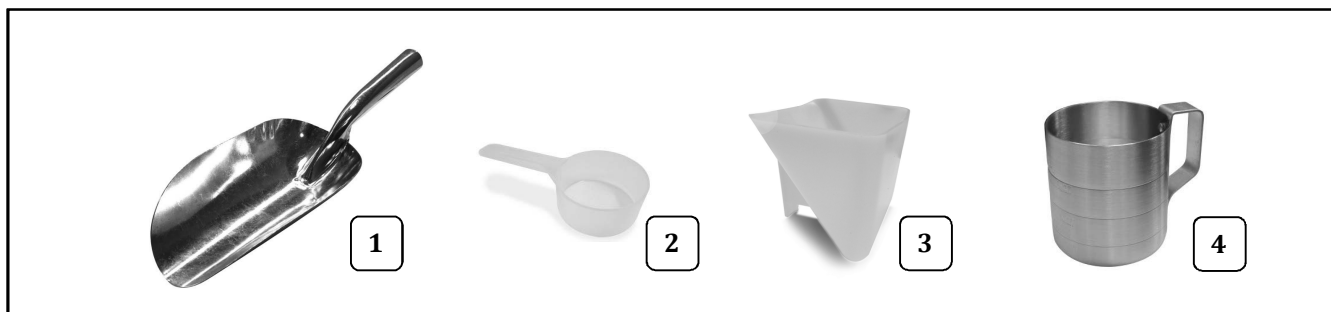

Item	Part Description	Part Number
		All Models
1	STAMPED ALUM SCOOP	2071
2	MEASURE 20 CC	47680
3	MEASURE 6 OZ	49049
4	16OZ CORN MEASURE W/HANDL	68050

Safety Labels

1 

2 

3 

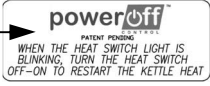
4 

Label used on units with the PowerOff Control feature.

5 

6 

Kettle Lead-In Label

Power Cord Label

Unit Labels

Power Cord Label

Item	Part Description	Part Number	
		2600, 2600-00-003, 2600-00-000	2600A
1	UNIVERSAL POPPER DECAL	41019	41019
2	WARNING, MAX LAMP 50W	74795	74795
3	MAIN GROUND LABEL	42375	42375
4	LABEL POWEROFF CNTRL		55436
5	CONDUIT WARNING LABEL	82840	82840
6	WARNING LABEL CORD	68720	68720

Accessories

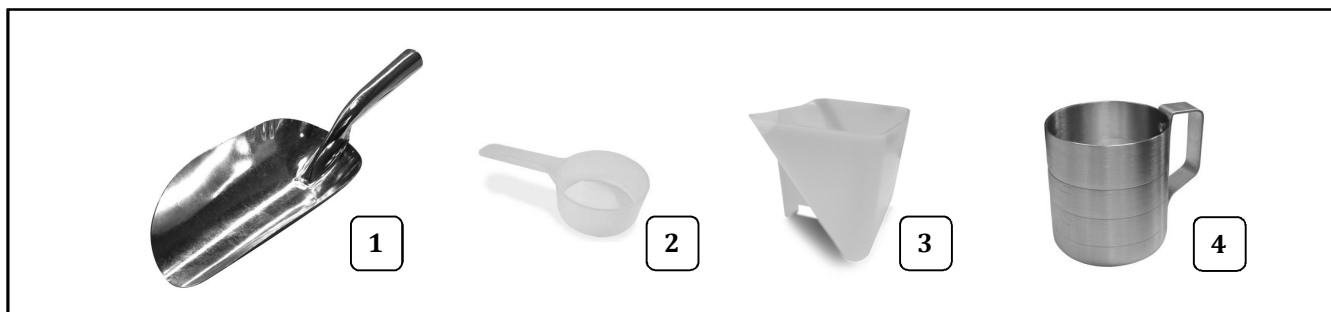

Item	Part Description	Part Number
		All Models
1	STAMPED ALUM SCOOP	2071
2	MEASURE 20 CC	47680
3	MEASURE 6 OZ	49049
4	16OZ CORN MEASURE W/HANDL	68050