



# THERMO-FINISHER™

## Food Finisher

### TF-1900 & TF-4600 Series

---

## Installation & Operating Manual

I & W #07.05.117.00

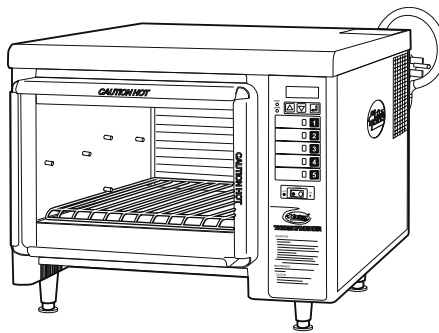

This manual contains important safety information concerning the maintenance, use and operation of this product. Failure to follow the instructions contained in this manual may result in serious injury. If you are unable to understand the contents of this manual, please bring it to the attention of your supervisor. Do not operate this equipment unless you have read and understood the contents of this manual.

Este manual contiene importante información sobre seguridad concerniente al mantenimiento, uso y operación de este producto. Cualquier falla en el seguimiento de las instrucciones contenidas en este manual puede resultar en un serio daño. Si usted no puede entender el contenido de este manual por favor pregunte a su supervisor. No opere este equipo al menos que haya leído y comprendido el contenido de este manual.

# CONTENTS

<b>Important Owner Information</b> .....	i	<b>Programming The Unit</b> .....	7
<b>Introduction</b> .....	i	General .....	7
<b>Important Safety Instructions</b> .....	1	<b>Programming Controller</b> .....	8
<b>Model Descriptions</b> .....	2	Programming a Selection .....	8
All Models .....	2	Idle Mode .....	10
TF-1919 .....	2	Auto-Off Mode .....	10
TF-4619 .....	2	Programming Hints .....	10
TF-461R .....	2	<b>Operation</b> .....	12
TFW-461R .....	2	Basic Food Finishing .....	12
<b>Specifications</b> .....	3	Food Finishing Hints.....	12
Electrical Rating Chart.....	3	<b>Maintenance</b> .....	13
Plug Configurations .....	3	General .....	13
Dimensions .....	4	Cleaning-Exterior .....	13
<b>Installation</b> .....	5	Blower Motors.....	13
Unpacking.....	5	Cleaning-Interior .....	13
Location .....	5	<b>Recommended Food Finishing Guide</b> .....	14
Electrical Connections (TFW-461R) .....	6	<b>Hatco Limited Warranty</b> .....	17
Appliance Legs (TFW-461R) .....	6	<b>Authorized Parts Distributors</b> .....	Back Cover

## IMPORTANT OWNER INFORMATION

Record the model number, serial number (identification decal located on the back or side of the unit), voltage and purchase date of your Thermo-Finisher™ Food Finisher in the spaces below. Please have this information available when calling Hatco for service assistance.

Model No. \_\_\_\_\_

Serial No. \_\_\_\_\_

Voltage \_\_\_\_\_

Date of Purchase \_\_\_\_\_

Business Hours: 8:00 a.m. to 5:00 p.m.  
Central Standard Time

(Summer Hours: June to September –  
8:00 a.m. to 5:00 p.m. C.D.T.  
Monday through Thursday  
8:00 a.m. to 2:30 p.m. C.D.T. Friday)

Telephone: (800) 558-0607; (414) 671-6350

Fax: (800) 690-2966 (Parts & Service)  
(414) 671-3976 (International)



 24-Hour 7-Day Parts & Service Assistance available in the United States and Canada by calling (800) 558-0607.

Additional information can be found by visiting our web site at [www.hatcocorp.com](http://www.hatcocorp.com).

## INTRODUCTION

The Hatco Thermo-Finisher is designed to rapidly heat or thermalize a wide range of food products which allows operators to serve customers faster, thereby improving customer satisfaction. The Thermo-Finisher is perfect for melting toppings or finishing soup and foods like Mexican entrees, nachos and potato skins. It also thermalizes frozen foods such as appetizers, french fries and pizza. Thermo-Finisher can also be used to heat plates prior to serving.

This manual provides the installation, safety and operating instructions for the Thermo-Finisher Food Finisher. We recommend all installation, operating and safety instructions appearing in this manual be read prior to installation or operation of your Hatco

Food Finisher. Safety instructions that appear in this manual after a warning symbol  and the words **WARNING** or **CAUTION** printed in bold face are very important.  **WARNING** means there is the possibility of serious personal injury or death to yourself or others.  **CAUTION** means there is the possibility of minor or moderate injury. **CAUTION without the symbol** signifies the possibility of equipment or property damage only.

Your Hatco Thermo-Finisher Food Finisher is a product of extensive research and field testing. The materials used were selected for maximum durability, attractive appearance and optimum performance. Every unit is thoroughly inspected and tested prior to shipment.

# IMPORTANT SAFETY INSTRUCTIONS

**IMPORTANT! Read the following important safety instructions to avoid personal injury or death, and to avoid damage to the equipment or property.**

## ⚠ WARNINGS

- ⚠ Plug unit into a properly grounded electrical outlet of the correct voltage, size and plug configuration. If the plug and receptacle do not match, contact a qualified electrician to determine the proper voltage and size and install the proper electrical outlet.
- ⚠ To avoid any injury or damage to the unit do not pull unit by power cord.
- ⚠ To prevent any injury, discontinue use if power cord is frayed or worn.
- ⚠ To prevent injury or damage to the unit, TFW-461R model must be installed by a qualified electrician.
- ⚠ For safe and proper operation, the unit must be located a reasonable distance from combustible walls and materials. If safe distances are not maintained, discoloration or combustion could occur. Do not locate unit under shelving or closer than 12" (305 mm) from the ceiling.
- ⚠ On TF-1919, TF-4619 and TF-461R models allow a minimum of 1" (25 mm) clearance along the sides and back. Allow a clearance of 26" (660 mm) along the front discharge to ensure proper operation and safety.
- ⚠ On TFW-461R models allow a minimum of 1" (25 mm) clearance along the right wall and back wall when facing controls. Allow 3" (76 mm) along the left wall. Allow a clearance of 26" (660 mm) along the front discharge to ensure proper operation and safety.
- ⚠ To reduce the risk of fire, the TFW-461R appliance is to be mounted on floors of noncombustible flooring and surface finish with no combustible material against the underside, or on noncombustible slabs or arches, have no combustible material against the underside. Such construction shall in all cases extend not less than 12" (305 mm) beyond the equipment on all sides.
- ⚠ To avoid any injury, turn the power switch OFF, unplug the unit from the power source and allow to cool before performing any maintenance.
- ⚠ Unit is not waterproof. DO NOT submerge in water. Do not operate if it has been submerged in water. Do not steam clean the interior or flood with water or liquid solution.
- ⚠ To avoid electrical shock or personal injury, do not steam clean or use excessive water on the unit.
- ⚠ If service is required on this unit, contact your Authorized Hatco Service Agent, or contact the Hatco Service Department at 800-558-0607 or 414-671-6350; fax 800-690-2966 or International fax 414-671-3976.
- ⚠ This product has no "user" serviceable parts. To avoid damage to the unit or injury to personnel, use only Authorized Hatco Service Agents and Genuine Hatco Replacement Parts when service is required.
- ⚠ Genuine Hatco Replacement Parts are specified to operate safely in the environments in which they are used. Some aftermarket or generic replacement parts do not have the characteristics that will allow them to operate safely in Hatco equipment. It is essential to use Hatco Replacement Parts when repairing Hatco equipment. Failure to use Hatco Replacement Parts may subject operators of the equipment to hazardous electrical voltage, resulting in electrical shock or burn.

## ⚠ CAUTIONS

- ⚠ Some exterior surfaces on the unit will get hot. Use caution when touching these areas to avoid injury.
- ⚠ Unit is not weatherproof. For safe and proper operation locate the unit indoors where the ambient air temperature is a minimum of 70°F (21°C).
- ⚠ To avoid any injury or damage to the unit do not operate appliance without installation of supplied legs.
- ⚠ DO NOT use "Pyrex" glass plates or serving pieces in the finisher. "Pyrex" glass may break causing personal injury and/or food contamination.
- ⚠ DO NOT use paper or plastic serving pieces in the finisher. These materials may melt or burn causing a fire hazard and/or food contamination and may damage the unit.
- ⚠ Plate/ tray will be very hot upon removal; use oven mitt, protective clothing, or pan gripper to remove.

# IMPORTANT SAFETY INSTRUCTIONS

## ⚠ CAUTIONS

- ⚠ Do not remove the glass from the unit for cleaning purposes. Doing so may cause injury or damage to the unit.
- ⚠ To avoid any injury or damage locate the unit at the proper counter height, in an area that is convenient for use. The location should be level to prevent the unit or its contents from accidentally falling, and strong enough to support the weight of the unit.
- ⚠ Do not place anything on top of the unit; doing so could damage the unit or subject personnel to possible injury.
- ⚠ To avoid any injury or damage to the unit make sure the plate rack is not in direct contact with the glass base.

- ⚠ The National Sanitation Foundation (NSF) requires TFW-461R units to be either sealed or raised on the installation surface. If this unit cannot be sealed at the point of use, 4" (102 mm) legs are included to allow for proper cleaning access below unit.

## CAUTIONS

Do not place any objects on the metal rack during preheat. Doing so will most likely over-cook the product.

Use only non-abrasive cleaners. Abrasive cleaners could scratch the finish of your Thermo-Finisher, marring its appearance and making it susceptible to dirt accumulation.

# MODEL DESCRIPTIONS

## ALL MODELS

The Thermo-Finisher Food Finisher models have an easy-to-clean interior, constructed of stainless steel and heavy duty glass. The units feature quick-heating infrared ribbon elements with a microprocessor to control the radiant heat and heating time. All models come with a user friendly control panel which accepts up to five preprogrammed recipe times. All models accommodate a half-size sheet pan. A plate rack is included.

## MODEL TF-1919

The TF-1919 model features one upper element to heat the food product on the plate and one lower element to heat the center of the plate. Loading and unloading of food is done on the control side of the unit. An attached cord and plug set is included.

## MODEL TF-4619

The TF-4619 model features four upper elements that heat food product on the plate and one lower element that heats the center of the plate. Loading and unloading of food is done on the control side of the unit. An attached cord and plug set is included.

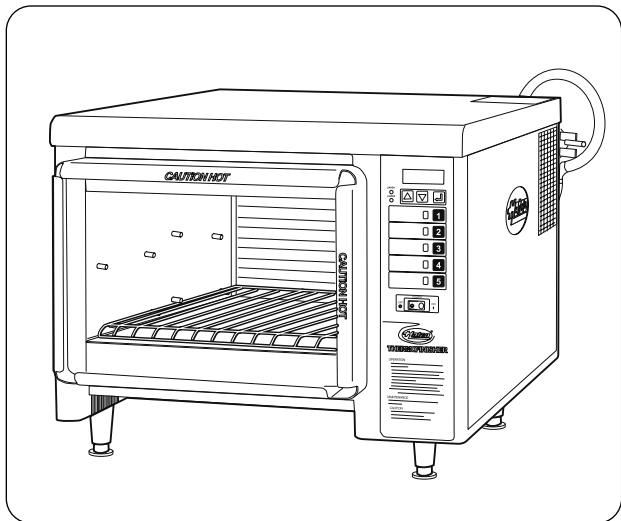

Figure 1. Thermo-Finisher – Model TF-4619

## MODEL TF-461R

The TF-461R features four upper circular elements and one lower rectangular element for even heat distribution from corner to corner. Loading and unloading of food is done on the control side of the unit. An attached cord and plug set is included.

## MODEL TFW-461R

The TFW-461R features four upper circular elements and one lower rectangular element for even heat distribution from corner to corner. Loading and unloading of food is done on the control side of the unit. This model must be electrically hard wire connected by a qualified electrician.

# SPECIFICATIONS

## ELECTRICAL RATING CHART

Model	Voltage	Watts	Amps	Phase	Plug Configuration	Shipping Weight
TF-1919	208	4800	23.1	1	NEMA 6-30P	88 lbs. (40 kg)
	240	5000	20.8	1	NEMA 6-30P	88 lbs. (40 kg)
	220	4201	19.1	1	NONE†	88 lbs. (40 kg)
	240	5000	20.8	1	NONE†	88 lbs. (40 kg)
	380 (CE)	4513	11.9	1	NONE†	88 lbs. (40 kg)
TF-4619	208	7200	20.1	3	NEMA L15-30P	90 lbs. (41 kg)
	240	7300	17.6	3	NEMA L15-30P	90 lbs. (41 kg)
	220	6134	16.1	3	NONE†	90 lbs. (41 kg)
	240	7300	17.6	3	NONE†	90 lbs. (41 kg)
	380 (CE)	6588	10.1	3	NONE†	90 lbs. (41 kg)
TF-461R	208	6250	30.0	1	NEMA 6-50P	93 lbs. (42 kg)
	208	6250	19.0	3	NEMA L15-30P	93 lbs. (42 kg)
	240	8320	34.7	1	NEMA 6-50P	93 lbs. (42 kg)
	240	8320	21.9	3	NEMA L15-30P	93 lbs. (42 kg)
	220	6992	20.1	3	NONE†	93 lbs. (42 kg)
Model	Voltage	Watts	Amps	Phase	Circuit Breaker Size*	Shipping Weight
TFW-461R	208	6250	30.0	1	40	93 lbs. (42 kg)
	208	6250	19.0	3	30	93 lbs. (42 kg)
	240	8320	34.7	1	50	93 lbs. (42 kg)
	240	8320	21.9	3	30	93 lbs. (42 kg)
	220	6992	20.1	3	30	93 lbs. (42 kg)

The electrical information in the shaded areas pertains to **Export models only**.

† Power cord is attached without a plug.

*\*NOTE: Model TFW-461R must be properly hard wire connected by a qualified electrician. This model cannot be used with a cord and plug.*

### PLUG CONFIGURATIONS

Units are supplied from the factory with an electrical cord and plug on the back of the unit. (See Figure 2.)

#### ⚠ WARNING

Plug unit into a properly grounded electrical outlet of the correct voltage, size and plug configuration. If the plug and receptacle do not match, contact a qualified electrician to determine the proper voltage and size and install the proper electrical outlet.

#### ⚠ WARNING

To prevent injury or damage to the unit, TFW-461R model must be installed by a qualified electrician.

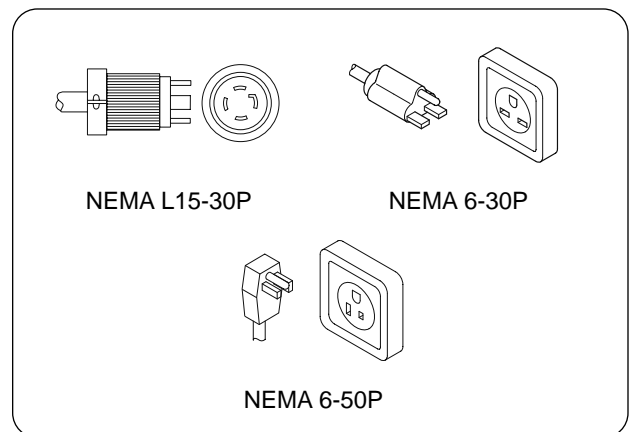

Figure 2. Plug Configurations

# SPECIFICATIONS

## DIMENSIONS

### EXTERIOR DIMENSIONS

Model	(A) Width	(B) Depth*	(C) Height
TF-1919	20-1/4" (514 mm)	27-1/2"* (699 mm)	17" (432 mm)
TF-4619	20-1/4" (514 mm)	27-1/2"* (699 mm)	17" (432 mm)
TF-461R 1 Phase Units	23-1/8" (587 mm)	30-7/8" (784 mm)	17" (432 mm)
TF-461R 3 Phase Units	22-1/8" (562 mm)	30-7/8" (784 mm)	17" (432 mm)
TFW-461R	25-1/2" (648 mm)	20-7/8" (530 mm)	18-1/2" ♦ (470 mm)

### EFFECTIVE FINISHING AREA

Model	(D) Width	(E) Depth	(F) Height
TF-1919	13" (330 mm)	18" (457 mm)	6-3/8" (162 mm)
TF-4619	13" (330 mm)	18" (457 mm)	6-3/8" (162 mm)
TF-461R	13" (330 mm)	18" (457 mm)	6-3/8" (162 mm)
TFW-461R	18" (457 mm)	13" (330 mm)	6-3/8" (162 mm)

\*Allow an additional 2" (51 mm) minimum for power cord.

♦ Height of unit is 14-5/8" (159 mm) without legs attached.

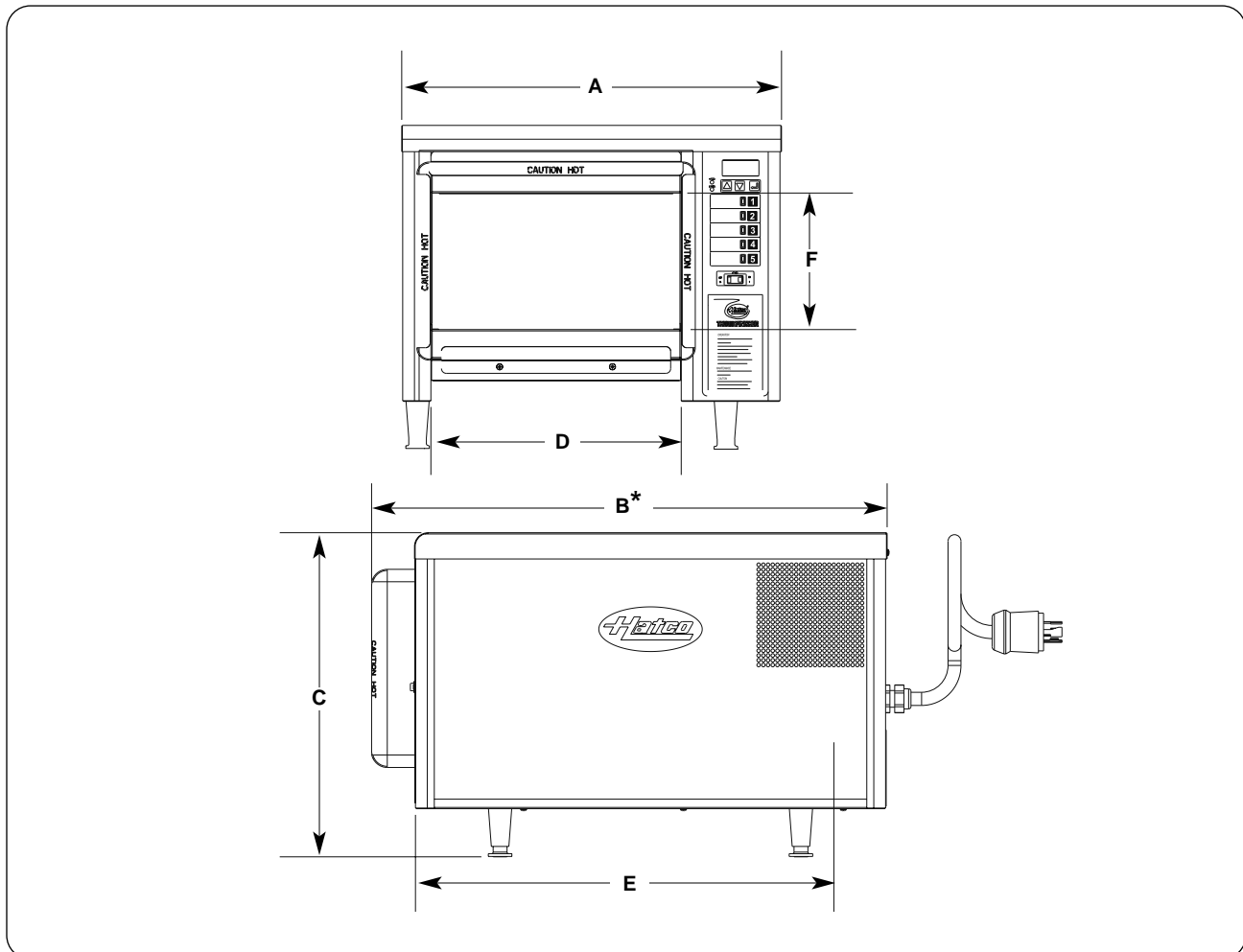

Figure 3. Dimensions

## UNPACKING

1. Remove unit from box.
2. Remove information packet. **To prevent delay in obtaining warranty coverage, fill out and mail in warranty card to Hatco.**
3. Remove tape, glass protection corners and packaging material from all surfaces of unit.
4. The unit is equipped with both a top set and bottom set of pins for supporting the wire plate rack. Properly position the wire plate rack using either set, making sure the wire rack is placed between the three lower pins and the upper pin on each side. (See Figure 4).

*NOTE: Top wire plate position is recommended for quick flash heating only. All items listed in the Food Finishing Guide are utilizing the bottom set of pins for supporting the wire plate rack.*

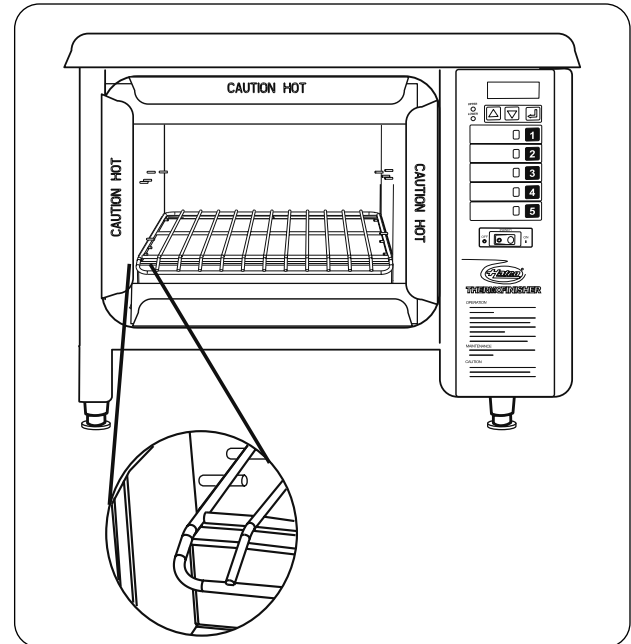

Figure 4. Rack Support Placement

## LOCATION

### ⚠ WARNING

To reduce the risk of fire, the TFW-461R appliance is to be mounted on floors of noncombustible flooring and surface finish with no combustible material against the underside, or on noncombustible slabs or arches, have no combustible material against the underside. Such construction shall in all cases extend not less than 12" (305 mm) beyond the equipment on all sides.

### ⚠ WARNING

For safe and proper operation, the unit must be located a reasonable distance from combustible walls and materials. If safe distances are not maintained, discoloration or combustion could occur. Do not locate unit under shelving or closer than 12" (305 mm) from the ceiling.

### ⚠ WARNING

On TF-1919, TF-4619 and TF-461R models allow a minimum of 1" (25 mm) clearance along the sides and back. Allow a clearance of 26" (660 mm) along the front discharge to ensure proper operation and safety.

### ⚠ WARNING

To avoid any injury or damage to the unit do not pull unit by power cord.

### ⚠ WARNING

To prevent any injury, discontinue use if power cord is frayed or worn.

### ⚠ WARNING

On TFW-461R models allow a minimum of 1" (25 mm) clearance along the right wall and back wall when facing controls. Allow 3" (76 mm) along the left wall. Allow a clearance of 26" (660 mm) along the front discharge to ensure proper operation and safety.

### ⚠ CAUTION

To avoid any injury or damage to the unit make sure the plate rack is not in direct contact with the glass base.

### ⚠ CAUTION

To avoid any injury or damage locate the unit at the proper counter height, in an area that is convenient for use. The location should be level to prevent the unit or its contents from accidentally falling, and strong enough to support the weight of the unit.

### ⚠ CAUTION

Do not place anything on top of the unit; doing so could damage the unit or subject personnel to possible injury.

# INSTALLATION

## ⚠ CAUTION

Unit is not weatherproof. For safe and proper operation locate the unit indoors where the ambient air temperature is a minimum of 70°F (21°C).

## ELECTRICAL CONNECTIONS (TFW-461R)

### ⚠ WARNING

To prevent injury or damage to the unit, TFW-461R model must be installed by a qualified electrician.

1. Remove wire inspection cover located on the right side of the unit when facing the controls.
2. Locate the terminal block inside the unit.
3. Bring power leads from a properly sized circuit breaker or disconnect switch through the knockout provided on the unit.

*NOTE: TFW-461R have two knockout locations, one on the bottom of the unit and one on the back.*

4. Use copper wire only. Tighten connections properly to a minimum of 40 inch pounds.
5. A grounding screw is provided near the electrical terminals. An equipment grounding conductor must be properly connected to it.
6. Replace and secure wire inspection cover.

## APPLIANCE LEGS (TFW-461R)

The TFW-461R Series unit can be installed with or without the 4" (1016 mm) appliance legs supplied.

If the appliance is used without the legs the unit must be sealed and secured to the countertop.

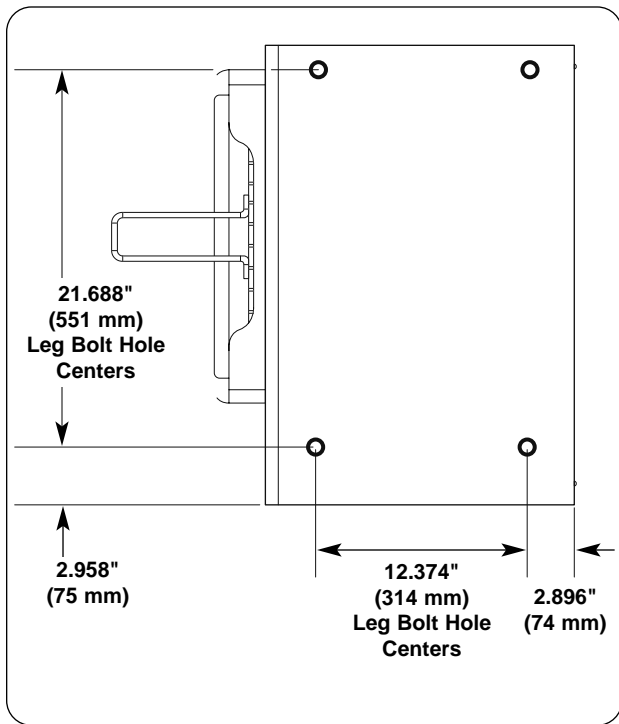

Figure 5. Leg Bolt Hole Centers – TFW-461R

To secure unit to countertop material use four 3/8"-16 bolts placed through the countertop and threaded into the leg bolt holes. See Figure 5 for leg bolt hole centers.

## ⚠ CAUTION

The National Sanitation Foundation (NSF) requires TFW-461R units to be either sealed or raised on the installation surface. If this unit cannot be sealed at the point of use, 4" (102 mm) legs are included to allow for proper cleaning access below unit.



# PROGRAMMING THE UNIT

## GENERAL

Thermo-Finisher™ units have both an upper and lower heating zone. The upper elements heat the product on the plate and the lower elements heat the center of the plate.

Five adjustable program button selections allow the operator to fine tune the radiant heat input and heating time for a variety of menu items. This adjustable feature assures optimum serving temperatures without effecting quality.

Thermo-Finisher units also feature an adjustable “Idle” mode and adjustable “Auto-Off” mode, which allow for additional flexibility.

*NOTE: After reading and understanding how to program the unit, see PROGRAMMING HINTS and RECOMMENDED FOOD FINISHING GUIDE in this manual for further helpful information.*

*NOTE: If at anytime during the programming or operation of the unit the display is not reading correctly or the unit is unable to be programmed, turn the unit off. Next, turn the unit back on and restart.*

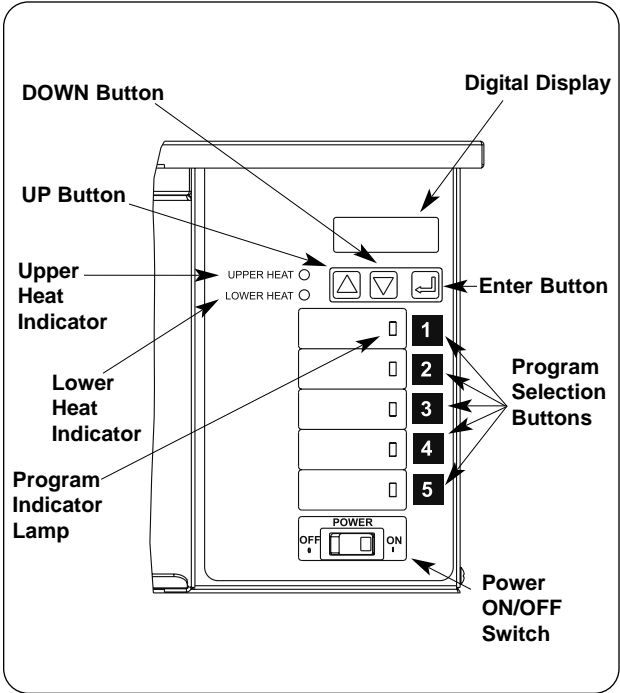

Figure 6. Control Panel

# PROGRAMMING CONTROLLER

## PROGRAMMING A SELECTION

The following terms are used when programming the unit:

**UP = Upper Power Value:** Controls the power setting on the upper heating element(s)

**UT = Upper Time Value:** Controls the time setting on the upper heating element(s)

**LP = Lower Power Value:** Controls the power setting on the lower heating element(s)

**LT = Lower Time Value:** Controls the time setting on the lower heating element(s)

When the unit display shows a Power Value (UP for upper heating zone or LP for lower heating zone) the number indicates the value set at a percentage: example P20 = 20%. These values are adjustable from 5-100% in 5% increments.

When the unit display shows a Time Value (UT for upper heating zone or LT for lower heating zone) the number indicates the time in seconds the heating element will be on: example T35 = 35 seconds. These values are adjustable from zero to nine minutes fifty nine seconds.



*NOTE: The arrow keys are used to enter values when programming the unit. Pressing a key changes the value incrementally. Holding down the key rapidly changes the value.*



1. Plug unit into an electrical outlet of the correct voltage, size and plug configuration. (See SPECIFICATIONS for details.)



2. Turn power switch to the "ON" position. The unit will make an audible beep, automatically go into preheat and display will indicate **Stby** (Figure 7A).



After one minute and ten seconds, the preheat cycle is complete the unit will display **rdy** (Figure 7B). The unit is now ready to be programmed.

3. With display showing **rdy**, push and hold the desired Numbered Program Selection button, while at the same time push and hold the Enter  button for **5 seconds** (Figure 7C).

4. Upper Power Value (UP): After 3 seconds, the upper heat indicator will glow and the unit will display **PXX** (Figure 7D). Press the UP  or DOWN  arrow key until you reach the desired setting. Values change by 5% every time an arrow key is pressed. Press the ENTER  button when you have reached the desired setting.

5. Upper Time Value (UT): The unit will display **t0:00** (Figure 7E). Press the UP  or DOWN  arrow key until you reach the desired setting. Values change by 1 second every time an arrow key is pressed. Holding down an arrow key will cause the numbers to change rapidly. Time can be adjusted from zero to nine minutes fifty nine seconds. Press the ENTER  button when you have reached the desired setting.

6. Lower Power Value (LP): The lower heat indicator will glow and the unit will display **PXX** (Figure 7F). Press the UP  or DOWN  arrow key until you reach the desired setting. Values change by 5% every time an arrow key is pressed. Press the ENTER  button when you have reached the desired setting.

7. Lower Time Value (LT): The unit will display **t0:00** (Figure 7G). Press the UP  or DOWN  arrow key until you reach the desired setting. Values change by 1 second every time an arrow key is pressed. Press the ENTER  button when you have reached the desired setting.

8. Press the Numbered Program Selection button selected in step 3 to enter all the settings into memory. The display will show **rdy**.

**IMPORTANT NOTE:** *If no adjustments are made within 15 seconds, the controller will revert back to the "READY" mode and will not accept any changes. Also, pressing any of the other Numbered Program Selection buttons will take the unit out of the programming mode without accepting any changes.*

9. If ready to finish food, place product in unit on center of metal rack and press desired Numbered Program Selection button.

10. Using a grease pencil or "China" pencil, record the specific menu item on the control panel next to the selected Numbered Program button.

11. Repeat steps 3-10 for the other Program buttons.

*NOTE: All units keep the power and timing settings in memory, even when the unit is turned off or is unplugged from the power source.*

# PROGRAMMING CONTROLLER

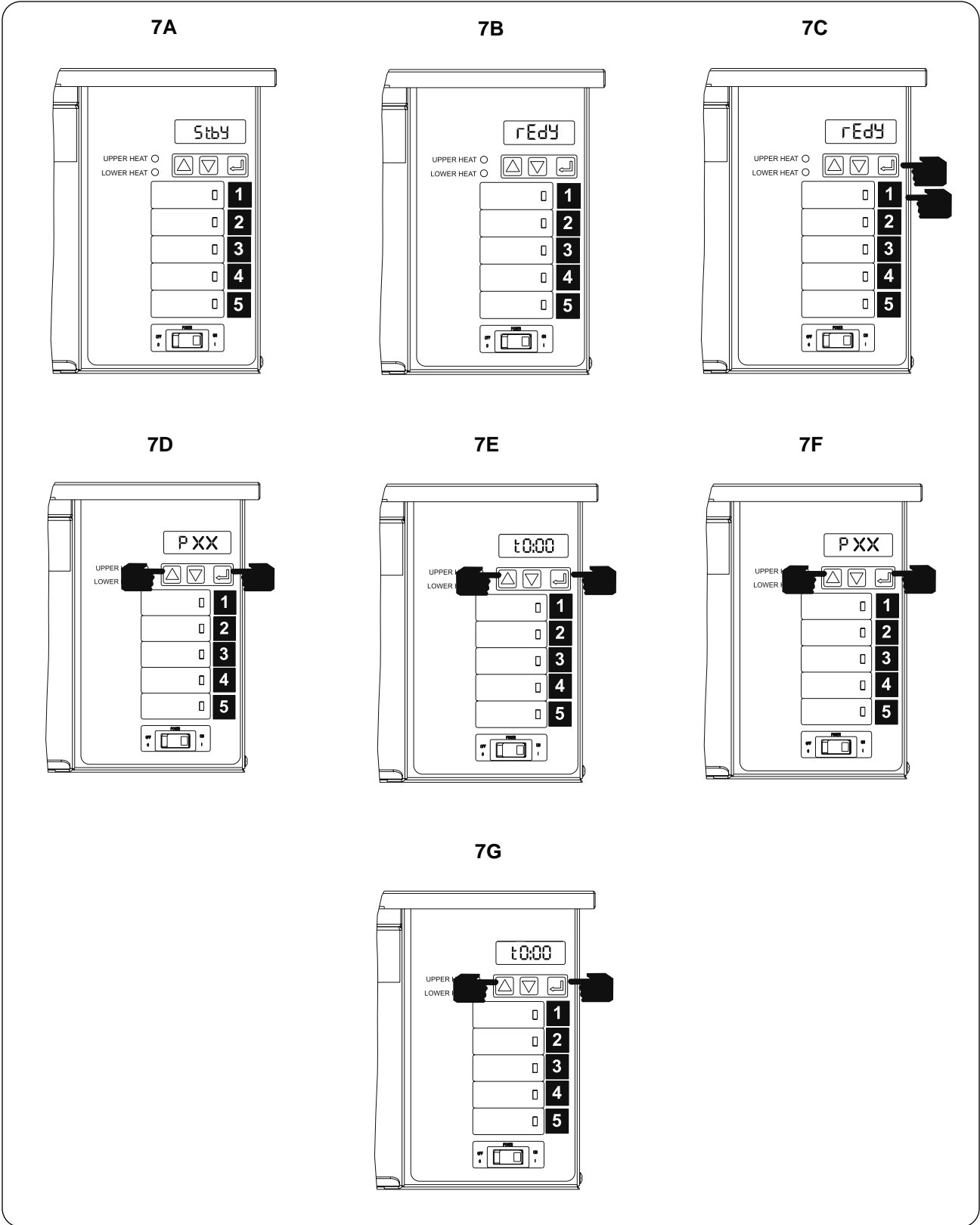

Figure 7. Programming a Selection

# PROGRAMMING CONTROLLER

---

## IDLE MODE

The Thermo-Finisher™ features an “Idle” mode. Once the unit reaches the READY mode, the upper heating element(s) automatically go into a programmed idle power setting. (The display will still show READY during the idle mode). The unit will stay in this mode until one of the five Program buttons is pressed, or the unit goes into auto-shut off.

*NOTE: Begin by setting the idle mode power setting at 30% and adjust the program accordingly to achieve optimum performance.*

To change the idle mode power setting, follow these steps:

1. Press and hold the UP  $\Delta$  arrow while, at the same time, press and hold the ENTER  $\leftarrow$  button for **three seconds**. The display will show the current programmed power value (Figure 8A).
2. To adjust the idle mode, press either the UP  $\Delta$  or DOWN  $\nabla$  arrow until you reach the desired setting (Figure 8B). Each time you press an arrow, the setting will change by 10.
3. To accept the new value, push the ENTER  $\leftarrow$  button a second time (Figure 8C).

*Note: If no adjustments are made within 15 seconds, the controller goes back to its original settings without accepting the change. Pushing any of the numbered program buttons will also take the controller out of programming mode without accepting the change.*

## AUTO-OFF MODE

The Thermo-Finisher features an Auto-Off mode that turns all the elements off if the unit has not been used for a programmed length of time. This feature can be adjusted from 1 - 60 minutes in one minute increments, or it can be set to never shut off by itself.

To change the Auto-Off mode to a new setting, make sure unit is in “READY” mode and follow these steps:

1. Press and hold the DOWN  $\nabla$  arrow while at the same time press and hold the ENTER  $\leftarrow$  button for **three seconds**. The display will show the current programmed Auto-Off value (Figure 9A).

2. To adjust the Auto-Off time push either the UP  $\Delta$  or DOWN  $\nabla$  arrow until you reach the desired setting (Figure 9B). The Auto-Off mode can be adjusted from “0” (indicating unit will not turn off) to 60 minutes, in single minute increments.
3. To accept the new Auto-Off time value, push the ENTER  $\leftarrow$  button a second time (Figure 9C).

*Note: If no adjustments are made within 15 seconds the controller goes back to its original settings without accepting the change. Pressing any of the numbered buttons will also take the controller out of programming mode without accepting the change. To get the unit out of the Auto-Off Mode, push any one of the five numbered program buttons and the unit will begin operating.*

## PROGRAMMING HINTS:

- On menu items in which internal temperatures are critical (such as chicken or pork), the primary heat source comes from the bottom. On menu items in which the surface temperatures are critical (such as cheese melting), the primary heat source comes from the top. See *RECOMMENDED FOOD FINISHING GUIDE* for specific menu examples.
- When performing product testing, use three plates with the same product and run through the unit in succession. Adjust program accordingly to achieve optimum product temperature.
- When testing a menu item not listed in the *Recommended Food Finishing Guide* start by dividing the conventional cooking time by three and use that number as your cooking time. Set top and bottom heat at 50% and adjust from there. Program setting will vary based on model and food product.

# PROGRAMMING CONTROLLER

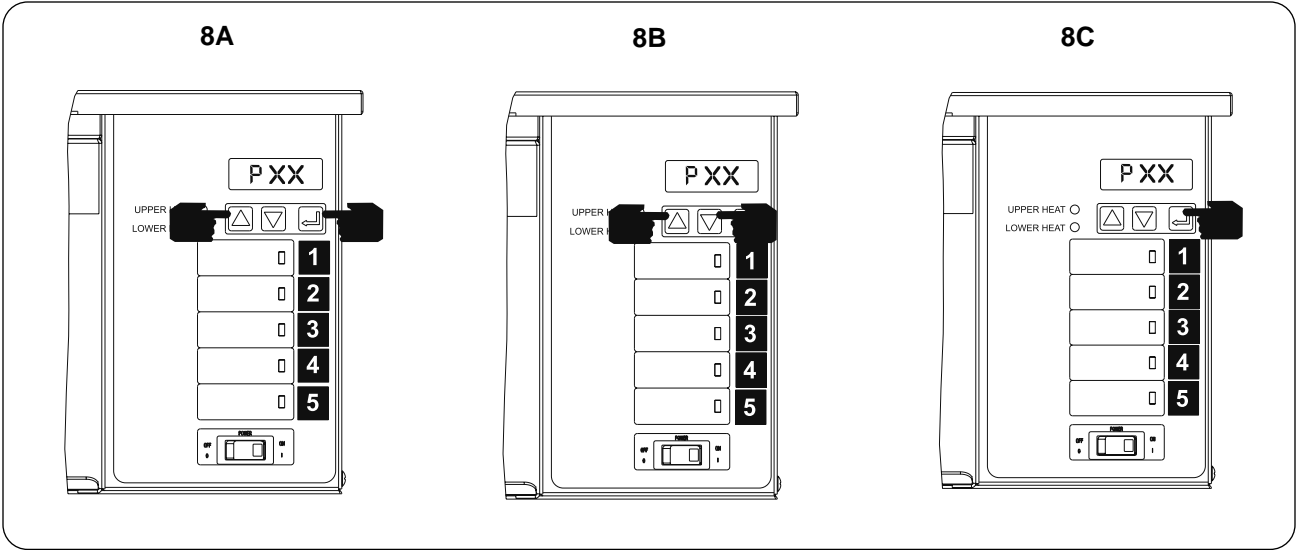

Figure 8. Programming Idle Mode

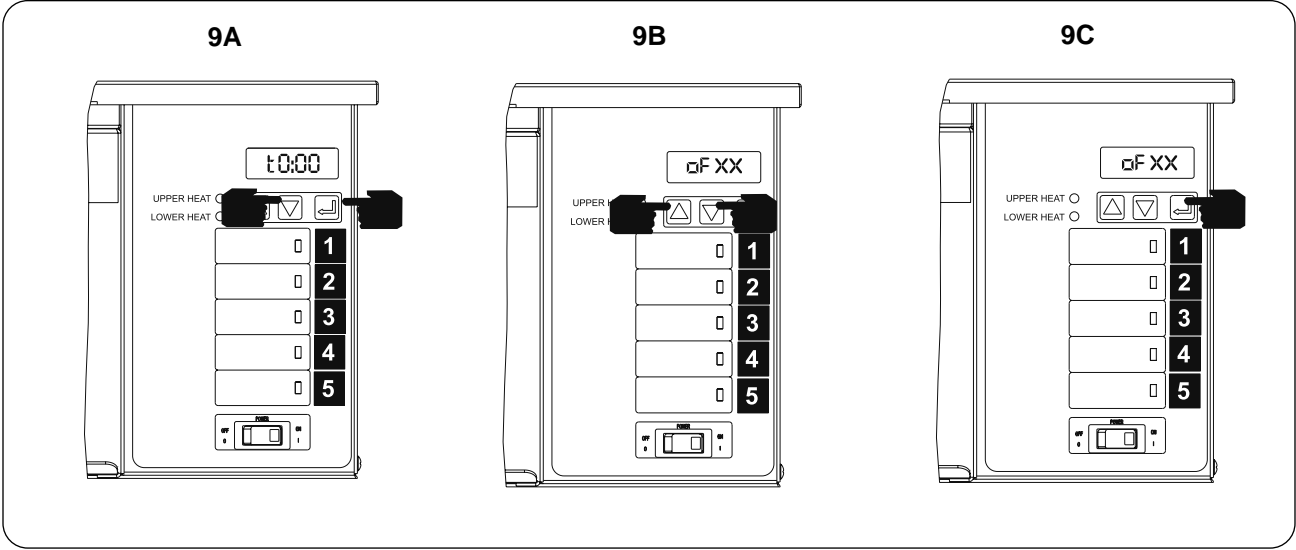

Figure 9. Programming Auto-Off Mode

# OPERATION

## BASIC FOOD FINISHING

### ⚠ CAUTION

Some exterior surfaces on the unit will get hot. Use caution when touching these areas to avoid injury.

### ⚠ CAUTION

DO NOT use “Pyrex” glass plates or serving pieces in the finisher. “Pyrex” glass may break causing personal injury and/or food contamination.

### ⚠ CAUTION

DO NOT use paper or plastic serving pieces in the finisher. These materials may melt or burn causing a fire hazard and/or food contamination and may damage the unit.

### ⚠ CAUTION

To avoid any injury or damage to the unit do not operate appliance without installation of supplied legs.

*NOTE: See RECOMMENDED FOOD FINISHING GUIDE for specific information.*

1. Plug unit into an electrical outlet of the correct voltage, size and plug configuration. See *SPECIFICATIONS* for details.
2. Turn the Power Switch to the “ON” position. (See Figure 10). The unit will make an audible beep, automatically go into “Preheat” and the display will indicate  $\text{PRE}$ . If the unit displays “OFF”, press one of the five product selection keys to put the unit into “Preheat” mode.

### CAUTION

Do not place any objects on the metal rack during preheat. Doing so will most likely overcook the product.

3. When the Finisher has reached temperature and is ready for product, the unit will display  $\text{READY}$ . Place plate/tray with food product on the center of the metal rack when unit is in  $\text{READY}$  mode.
4. Select one of five preprogrammed finishing cycles. Unit will beep and the display will begin counting down the programmed finishing time.

*Note: If you make an incorrect selection it can be cancelled by selecting any of the buttons on the Control Panel.*

5. Finishing is complete when the display flashes  $\text{done}$ , the control panel lights flash and the unit beeps for five seconds. Remove product at this time.

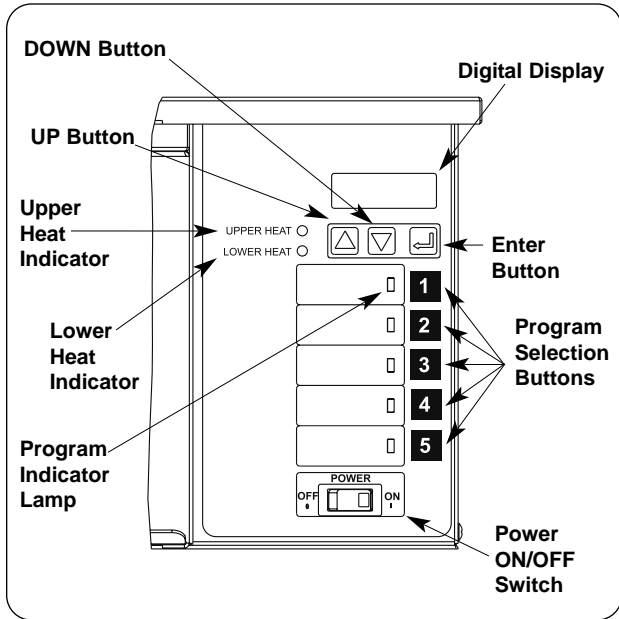

Figure 10. Control Panel

### ⚠ CAUTION

Plate/tray will be very hot upon removal; use oven mitt, protective clothing, or pan gripper to remove.

*Note: The beeping sound can be stopped before the five seconds have elapsed by selecting any of the buttons on the control panel.*

6. Another plate/tray with food product can be placed on the rack when Finisher is in the  $\text{READY}$  mode. To heat, repeat steps 3, 4, and 5.

## FOOD FINISHING HINTS:

- Most menu items will require the Lower Power Value to be set higher than the Upper Power Value.
- Frozen or refrigerated food product can be heated in the unit. Frozen items do not have to be thawed first.
- Menu items that have completed a food finishing cycle but are not hot enough can be put back in the unit for additional heating.
- When testing a menu item not listed in the *RECOMMENDED FOOD FINISHING GUIDE* start by dividing the conventional cooking time by three and use that number as your cooking time. Set top and bottom heat at 50% and adjust from there. Program setting will vary based on model and food product.

*NOTE: See RECOMMENDED FOOD FINISHING GUIDE for specific information.*

## GENERAL

The Hatco Thermo-Finisher™ warmers are designed for maximum durability and performance with minimum maintenance.

### WARNING

**To avoid any injury, turn the power switch OFF, unplug the unit from the power source and allow to cool before performing any maintenance.**

*NOTE: When the unit is HOT the blower fans will remain on even when the power switch is turned off.*

## CLEANING - EXTERIOR

To preserve the bright finish of the unit, it is recommended that the exterior surfaces be wiped daily with a damp cloth. Stubborn stains may be removed with a good stainless steel cleaner or a non-abrasive cleaner.

### CAUTION

**Use only non-abrasive cleaners. Abrasive cleaners could scratch the finish of your Thermo-Finisher, marring its appearance and making it susceptible to dirt accumulation.**

## BLOWER MOTORS

Inspect rear blower motors for food and/or grease build up and clean off if necessary.

## CLEANING - INTERIOR

### WIRE PLATE RACK

Remove rack from unit and wash with a mild soap and water solution and rinse.

### GLASS SURFACES

#### WARNING

**To avoid any injury, turn the power switch OFF, unplug the unit from the power source and allow to cool before performing any maintenance.**

Upper and lower glass surfaces can be cleaned after the unit has *cooled for at least one hour.*

With the wire plate rack removed carefully use a “grill scraper” or other small hand held scraper and scrape loose any food debris that has accumulated on the glass.

### CAUTION

**Do not remove the glass from the unit for cleaning purposes. Doing so may cause injury or damage to the unit.**

Remove any stains from the heating surfaces by wiping off the glass using a moist cloth and ceramic cooking top cleaner.

### WARNING

**Unit is not waterproof. DO NOT submerge in water. Do not operate if it has been submerged in water. Do not steam clean the interior or flood with water or liquid solution.**

### WARNING

**To avoid electrical shock or personal injury, do not steam clean or use excessive water on the unit.**

### WARNING

If service is required on this unit, contact your Authorized Hatco Service Agent, or contact the Hatco service Department at 800-558-0607 or 414-671-6350; fax 800-690-2966 or International fax 414-671-3976.

### WARNING

**This product has no “user” serviceable parts. To avoid damage to the unit or injury to personnel, use only Authorized Hatco Service Agents and Genuine Hatco Replacement Parts when service is required.**

### WARNING

**Genuine Hatco Replacement Parts are specified to operate safely in the environments in which they are used. Some aftermarket or generic replacement parts do not have the characteristics that will allow them to operate safely in Hatco equipment. It is essential to use Hatco Replacement Parts when repairing Hatco equipment. Failure to use Hatco Replacement Parts may subject operators of the equipment to hazardous electrical voltage, resulting in electrical shock or burn.**

# RECOMMENDED FOOD FINISHING GUIDE

Food Item	Upper Power Value (UP)	Upper Time Value (UT)	Lower Power Value (LP)	Lower Time Value (LT)
<b>Biscuits</b> Refrigerated, premade. PAN USED: Half sheet pan, greased lightly.	10	2 minutes 30 seconds	55	4 minutes
<b>Bacon</b> Pork, thick sliced. PAN USED: Half sheet pan, greased lightly.	75	5 minutes	70	5 minutes
<b>Cheese Bread</b> Slacked, topped with 5 cheeses. PAN USED: Hardcoated half sheet pan.	45	4 minutes	30	3 minutes
<b>Cheese Sandwich</b> 1-3 sandwiches at once; assembled, 2 slices of white bread & 2 slices of American cheese each. PAN USED: Hardcoated half sheet pan, 2" (5 cm) deep.	45	1 minute 15 seconds	100	55 seconds
<b>Cheese Sandwich</b> 4 sandwiches at once; assembled, 2 slices of white bread & 2 slices of American cheese each. PAN USED: Hardcoated half sheet pan, 2" (5 cm) deep.	50	1 minute 15 seconds	100	1 minute 23 seconds
<b>Chicken Patty</b> 4 oz., breaded, refrigerated, precooked. PAN USED: hardcoated half sheet pan.	60	4 minutes 30 seconds	40	4 minutes 30 seconds
<b>Chicken Skewers</b> Filleted and marinated. PAN USED: Hatco skewer holder.	85	5 minutes	80	4 minutes 45 seconds
<b>Chicken Wings</b> Buffalo style, slacked, fully cooked, sauce coated. PAN USED: Half sheet pan.	70	5 minutes	60	4 minutes 30 seconds

NOTE: All food items listed are utilizing the bottom set of pins for supporting the wire plate rack.



## RECOMMENDED FOOD FINISHING GUIDE

Food Item	Upper Power Value (UP)	Upper Time Value (UT)	Lower Power Value (LP)	Lower Time Value (LT)
<b>Egg Rolls</b> Refrigerated, chicken & pork. PAN USED: Half sheet pan.	35	4 minutes 45 seconds	35	4 minutes
<b>French Fries</b> Frozen, fast-food oven bake style. PAN USED: Half sheet pan.	90	3 minutes	80	3 minutes
<b>French Onion Soup</b> Soup already hot, for melting cheese. PAN USED: Standard soup crock placed on a half sheet pan.	95	35 seconds	5	0 minutes
<b>Hamburgers</b> Pre-cooked, quarter pound patty. PAN USED: Half sheet pan.	70	2 minutes 15 seconds	75	2 minutes
<b>Mozzarella Sticks</b> Breaded, refrigerated. PAN USED: Half sheet pan.	40	5 minutes	50	5 minutes
<b>Nachos</b> Corn chips topped with shredded cheddar cheese. PAN USED: Ceramic plate.	75	1 minute	70	1 minute
<b>Pizza, 12" (31 cm) Thin Crust</b> Frozen, to thaw or rethermalize. PAN USED: 12" (31 cm) pizza screen.	20	4 minutes	20	3 minutes
<b>Pizza, 12" (31 cm) Thin Crust</b> Frozen thawed, to cook after Rethermalizing. PAN USED: 12" (31 cm) pizza screen.	50	3 minutes	45	2 minutes 30 seconds
<b>Pizza, 12" (31 cm) Self-Rising Crust</b> Frozen, slacked. PAN USED: 12" (31 cm) round, 2" (5 cm) deep, hardcoated pan, greased lightly.	50	5 minutes	40	5 minutes 20 seconds

*NOTE: All food items listed are utilizing the bottom set of pins for supporting the wire plate rack.*

## RECOMMENDED FOOD FINISHING GUIDE

Food Item	Upper Power Value (UP)	Upper Time Value (UT)	Lower Power Value (LP)	Lower Time Value (LT)
<b>Pork Sausage Links</b> Skinless, raw. PAN USED: Half sheet pan, greased lightly.	70	4 minutes 30 seconds	65	5 minutes
<b>Potato Skins</b> Frozen, pre-prepared. PAN USED: Hardcoated half sheet pan.	40	4 minutes 15 seconds	35	4 minutes 10 seconds
<b>Quesadillas</b> 10 " (25 cm) flour tortillas, stuffed with sauteed peppers, onions & cheddar cheese. PAN USED: 10" (25 cm) aluminum pizza screen.	30	1 minute 45 seconds	40	1 minute
<b>Tomato Halves, Broiled</b> Lightly seasoned. PAN USED: Half sheet pan.	75	3 minutes 30 seconds	60	3 minutes

*NOTE: All food items listed are utilizing the bottom set of pins for supporting the wire plate rack.*

*NOTE: When testing a menu item not listed above start by dividing the conventional cooking time by three and use that number as your cooking time. Set top and bottom heat at 50% and adjust from there. This Food Guide is based on a Thermo-Finisher model TF-4619. Program setting will vary based on model and food product.*

# HATCO LIMITED WARRANTY

## 1. PRODUCT WARRANTY

Hatco warrants the products that it manufactures (the "Products") to be free from defects in materials and workmanship, under normal use and service, for a period of one (1) year from the date of purchase when installed and maintained in accordance with Hatco's written instructions or 18 months from the date of shipment from Hatco. Buyer must establish the product's purchase date by returning Hatco's Warranty Registration Card or by other means satisfactory to Hatco in its sole discretion.

Hatco warrants the following Product components to be free from defects in materials and workmanship from the date of purchase (subject to the foregoing conditions) for the period(s) of time and on the conditions listed below:

**a) One (1) Year Parts and Labor PLUS One (1) Additional Year Parts-Only Warranty:**

Toaster Elements (metal sheathed)  
Drawer Warmer Elements (metal sheathed)  
Drawer Warmer Drawer Rollers and Slides  
Food Warmer Elements (metal sheathed)  
Display Warmer Elements (metal sheathed air heating)  
Holding Cabinet Elements (metal sheathed air heating)

**b) One (1) Year Parts and Labor PLUS Four (4) Years Parts-Only Warranty on pro-rated terms that Hatco will explain at Buyer's request:**

3CS and FR Tanks

**c) One (1) Year Parts and Labor PLUS Nine (9) Years Parts-Only Warranty on:**

Electric Booster Heater Tanks  
Gas Booster Heater Tanks

THE FOREGOING WARRANTIES ARE EXCLUSIVE AND IN LIEU OF ANY OTHER WARRANTY, EXPRESSED OR IMPLIED, INCLUDING BUT NOT LIMITED TO ANY IMPLIED WARRANTY OF MERCHANTABILITY OR FITNESS FOR A PARTICULAR PURPOSE OR PATENT OR OTHER INTELLECTUAL PROPERTY RIGHT INFRINGEMENT. Without limiting the generality of the foregoing, SUCH WARRANTIES DO NOT COVER: Coated incandescent light bulbs, fluorescent lights, lamp warmer heat bulbs, glass components, Product failure in booster tank, fin tube heat exchanger, or other water heating equipment, caused by liming, sediment buildup, chemical attack or freezing, Product misuse, tampering or misapplication, improper installation or application of improper voltage.

## 2. LIMITATION OF REMEDIES AND DAMAGES

Hatco's liability and Buyer's exclusive remedy hereunder will be limited solely, at Hatco's option, to repair or replacement by a Hatco-authorized service agency (other than where Buyer is located outside of the United States, Canada, United Kingdom or Australia in which case Hatco's liability and Buyer's exclusive remedy hereunder will be limited solely to replacement of part under warranty) with respect to any claim made within the applicable warranty period referred to above. Hatco reserves the right to accept or reject any such claim in whole or in part. Hatco will not accept the return of any Product without prior written approval from Hatco, and all such approved returns shall be made at Buyer's sole expense. HATCO WILL NOT BE LIABLE, UNDER ANY CIRCUMSTANCES, FOR CONSEQUENTIAL OR INCIDENTAL DAMAGES, INCLUDING BUT NOT LIMITED TO LABOR COSTS OR LOST PROFITS RESULTING FROM THE USE OF OR INABILITY TO USE THE PRODUCTS OR FROM THE PRODUCTS BEING INCORPORATED IN OR BECOMING A COMPONENT OF ANY OTHER PRODUCT OR GOODS.

## HATCO AUTHORIZED PARTS DISTRIBUTORS

### ALABAMA

Jones McLeod Appl. Svc.  
Birmingham 205-251-0159

### ARIZONA

Auth. Comm. Food Equip.  
Phoenix 602-234-2443  
Byassee Equipment Co.  
Phoenix 602-252-0402

### CALIFORNIA

Industrial Electric  
Huntington Beach 714-379-7100  
Chapman Appl. Service  
San Diego 619-298-7106  
P & D Appliance  
S. San Francisco 650-635-1900

### COLORADO

Hawkins Commercial Appliance  
Englewood 303-781-5548

### DELAWARE

Food Equipment Service  
Wilmington 302-996-9363

### FLORIDA

Whaley Foodservice Repair  
Jacksonville 904-725-7800  
Universal Restaurant Services  
Miami 305-593-5488  
Nass Service Co., Inc.  
Orlando 407-425-2681  
B.G.S.I.  
Pompano Beach 954-971-0456  
Comm. Appliance Service  
Tampa 813-663-0313

### GEORGIA

TWC Services  
Lake City 404-361-8010  
Heritage Service Group  
Norcross 866-388-9837  
Southeastern Rest. Svc.  
Norcross 770-446-6177

### HAWAII

Burney's Comm. Service, Inc.  
Honolulu 808-848-1466  
Food Equip Parts & Service  
Honolulu 808-847-4871

### ILLINOIS

Parts Town  
Lombard 708-865-7278  
Eichenauer Elec. Service  
Decatur 217-429-4229  
Midwest Elec. Appl. Service  
Elmhurst 630-279-8000  
Cone's Repair Service  
Moline 309-797-5323

### INDIANA

GCS Service  
Indianapolis 317-545-9655

### IOWA

Electric Motor Service Co.  
Davenport 319-323-1823  
Goodwin Tucker Group  
Des Moines 515-262-8308

### KENTUCKY

GCS Service  
Louisville 502-367-1788

### LOUISIANA

Chandlers Parts & Service  
Baton Rouge 225-272-6620  
Bana Comm. Parts, Inc.  
Harahan 504-734-0076

### MARYLAND

Electric Motor Service  
Baltimore 410-467-8080  
GCS Service  
Silver Spring 301-585-7550

### MASSACHUSETTS

Ace Service Co., Inc.  
Needham 781-449-4220

### MICHIGAN

Commercial Kitchen Service  
Bay City 517-893-4561  
Bildons Appliance Service  
Detroit 248-478-3320  
Midwest Food Equip. Service  
Grandville 616-261-2000

### MINNESOTA

GCS Service  
Minneapolis 612-546-4221

### MISSOURI

General Parts  
Kansas City 816-421-5400  
Commercial Kitchen Services  
St. Louis 314-890-0700  
Kaemmerlen Parts & Service  
St. Louis 314-535-2222

### NEBRASKA

Anderson Electric  
Omaha 402-341-1414

### NEVADA

Burney's Commercial  
Las Vegas 702-736-0006  
Hi. Tech Commercial Service  
N. Las Vegas 702-649-4616

### NEW JERSEY

Jay Hill Repair  
Fairfield 973-575-9145  
Service Plus  
Flanders 973-691-6300

### NEW YORK

Acme American Repairs, Inc.  
Brooklyn 718-456-6544  
Alpro Service Co.  
Brooklyn 718-386-2515  
Appliance Installation  
Buffalo 716-884-7425  
Northern Parts Dist.  
Plattsburgh 518-563-3200  
J.B. Brady, Inc.  
Syracuse 315-422-9271

### NORTH CAROLINA

Authorized Appliance  
Charlotte 704-377-4501

### OHIO

Akron/Canton Comm. Svc. Inc.  
Akron 330-753-6635  
Certified Service Center  
Cincinnati 513-772-6600  
Commercial Parts and Service  
Columbus 614-221-0057  
Electrical Appl. Repair Service  
Independence 216-459-8700  
E. A. Wichman Co.  
Toledo 419-385-9121

### OKLAHOMA

Hagar Rest. Service, Inc.  
Oklahoma City 405-235-2184  
Krueger, Inc.  
Oklahoma City 405-528-8883

### OREGON

Bressie Electric Co.  
Portland 503-231-7171  
Ron's Service, Inc.  
Portland 503-624-0890

### PENNSYLVANIA

Elmer Schultz Services  
Philadelphia 215-627-5401  
FAST Comm. Appl. Service  
Philadelphia 215-288-4800  
GCS Service  
Pittsburgh 412-787-1970  
K & D Service Co.  
Harrisburg 717-236-9039  
Electric Repair Co.  
Reading 610-376-5444

### RHODE ISLAND

Marshall Electric Co.  
Providence 401-331-1163

### SOUTH CAROLINA

Whaley Foodservice Repair  
W. Columbia 803-791-4420

### TENNESSEE

Camp Electric  
Memphis 901-527-7543

### TEXAS

Stove Parts Supply  
Fort Worth 817-831-0381  
Armstrong Repair Service  
Houston 713-666-7100  
Commercial Kitchen Repair Co.  
San Antonio 210-735-2811  
San Antonio Rest. Equip.  
San Antonio 210-532-1660

### UTAH

La Monica's Rest. Equip. Service  
Murray 801-263-3221

### VIRGINIA

Daubers  
Norfolk 757-855-4097  
Daubers  
Springfield 703-866-3600

### WASHINGTON

Restaurant Appl. Service  
Seattle 206-524-8200

### WISCONSIN

A.S.C., Inc.  
Madison 608-246-3160  
A.S.C., Inc.  
Milwaukee 414-543-6460

## CANADA

### BRITISH COLUMBIA

Key Food Equipment Service  
Vancouver 604-433-4484

### MANITOBA

Denko Mechanical Ltd.  
Winnipeg 204-233-8003

### ONTARIO

R.G. Henderson Ltd.  
Toronto 416-422-5580

### CHOQUETTE CKS

Ottawa 613-739-8458

### QUÉBEC

Choquette CKS  
Montreal 514-722-2000

### CHOQUETTE CKS

Québec City 418-681-3944

## HATCO CORPORATION

P.O. Box 340500, Milwaukee, WI 53234-0500 U.S.A.

(800) 558-0607 (414) 671-6350

Parts & Service Fax (800) 690-2966 Int'l. Fax (414) 671-3976

www.hatcocorp.com