



Henny Penny Portable Venting System Model 500 PVS

2nd PROOF
Paust Printers

11-4-92



SERVICE MANUAL

Henny Penny Portable Venting System

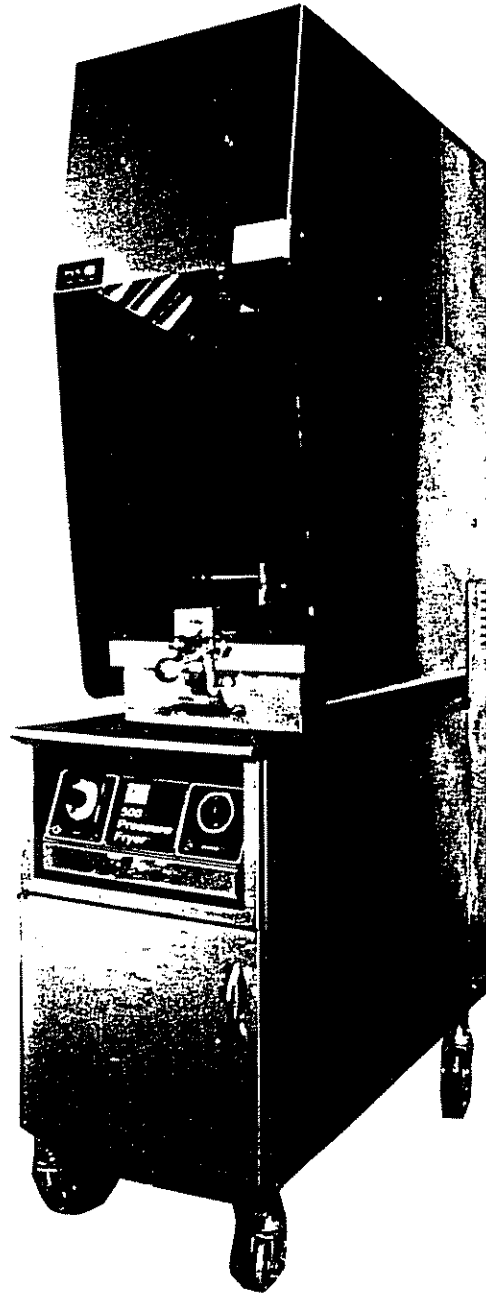

Model 500 PVS
Product Number 02310

**LIMITED WARRANTY
FOR HENNY PENNY APPLIANCES**

Subject to the following conditions, Henny Penny Corporation makes the following limited warranties to the original purchaser only for Henny Penny appliances and replacement parts:

New Equipment Any part of a new appliance, except lamps and fuses, which proves to be defective in material or workmanship within one year from date of original installation, will be repaired or replaced without charge F.O.B. factory, Eaton, Ohio, or F.O.B. authorized distributor. To validate this warranty, the registration card for the appliance must be mailed to Henny Penny within 10 days after installation.

Replacement Parts Any appliance replacement part, except lamps and fuses, which proves to be defective in material or workmanship within 90 days from date of original installation will be repaired or replaced without charge F.O.B. factory, Eaton, Ohio, or F.O.B. authorized distributor.

This warranty covers only the repair or replacement of the defective part and does not include any labor charges for the removal and installation of any parts, travel or other expenses incidental to the repair or replacement of a part.

Any claim must be presented to either Henny Penny or the distributor from whom the appliance was purchased. No allowance will be granted for repairs made by anyone else without Henny Penny's written consent. If damage occurs during shipping, notify the carrier at once so that a claim may be filed.

THE ABOVE LIMITED WARRANTY SETS FORTH THE SOLE REMEDY AGAINST HENNY PENNY FOR ANY BREACH OF WARRANTY OR OTHER TERM. BUYER AGREES THAT NO OTHER REMEDY (INCLUDING CLAIMS FOR ANY INCIDENTAL OR CONSEQUENTIAL DAMAGES) SHALL BE AVAILABLE.

The above limited warranty does not apply (a) to damage resulting from accident, alteration, misuse, or abuse; (b) if the equipment's serial number is removed or defaced; or (c) for lamps and fuses. THE ABOVE LIMITED WARRANTY IS EXPRESSLY IN LIEU OF ALL OTHER WARRANTIES, EXPRESS OR IMPLIED, INCLUDING MERCHANTABILITY AND FITNESS, AND ALL OTHER WARRANTIES ARE EXCLUDED. HENNY PENNY NEITHER ASSUMES NOR AUTHORIZES ANY PERSON TO ASSUME FOR IT ANY OTHER OBLIGATION OR LIABILITY.

TABLE OF CONTENTS

Section	Page
Section 1. INTRODUCTION	
1-1. Pressure Fryer	1-1
1-2. Features	1-1
1-3. Proper Care	1-1
1-4. Safety	1-2
1-5. Assistance	1-2
Section 2. INSTALLATION	
2-1. Introduction	2-1
2-2. Unpacking	2-1
2-3. Select a Fryer Location	2-2
2-4. Leveling the Fryer	2-2
2-5. Electrical Requirements	2-2
2-6. Testing the Fryer	2-5
Section 3. OPERATION	
3-1. Introduction	3-1
3-2. Filters	3-1
3-3. Fire Extinguisher	3-2
3-4. Scrubber Tank	3-2
3-5. Blower	3-3
Section 4. CLEANING INSTRUCTIONS	
4-1. Introduction	4-1
4-2. Cleaning Schedule	4-1
4-3. Cleaning Procedures - Filters	4-1
4-4. Cleaning Procedures - Water Scrubber Tank	4-2
4-5. Cleaning Procedures - PVS Hood Area	4-2
4-6. Side Panel Cleaning	4-3
4-7. Cleaning and Maintenance Schedule	4-3
Section 5. TROUBLESHOOTING	
5-1. Introduction	5-1
5-2. Troubleshooting	5-1

TABLE OF CONTENTS (Continued)

Section	Page
Section 6. MAINTENANCE	
6-1. Introduction	6-1
6-2. Maintenance Hints	6-1
6-3. Microswitches	6-1
6-4. Pump	6-3
6-5. Air Pressure Switch	6-4
6-6. Water Level Sensor	6-4
6-7. Blower	6-5
6-8. Fire Extinguisher	6-6
6-9. Relay	6-7
Section PARTS INFORMATION	
7-1. Introduction	7-1
7-2. Genuine Parts	7-1
7-3. How to Find Parts	7-1
7-4. How to Order	7-1
7-5. Prices	7-2
7-6. Delivery	7-2
7-7. Warranty	7-2
7-8. Parts List/Exploded View	7-4

Henny Penny Distributor List

SECTION 1. INTRODUCTION

1-1. INTRODUCTION

The Henny Penny Portable Venting System is an exhaust hood mounted directly on new Henny Penny electric fryers. It has the capability to absorb the steam exhaust in a unique water system. Also, any exhaust or odor off the open frypot is directed into three filters. This system eliminates most of the steam and odors created from pressure frying.

1-2. FEATURES

- Mounted directly onto fryer.
- Filters are easily removed for cleaning.
- Built in fire extinguisher.
- Low noise level.
- Side panels easily remove for cleaning and maintaining fryer.

1-3. PROPER CARE

As with any unit of food service equipment, the PVS does require care and maintenance. Suggestions for this maintenance are contained in this manual.

The careful use of the recommended procedures, coupled with the regular preventative maintenance, will result in few repairs to the equipment. When such repairs are required, they may be accomplished by following the repair steps contained in this manual.

1-4. SAFETY

The Henny Penny Portable Venting System has many safety features incorporated. However, the only way to ensure safe operation is to fully understand the proper installation, operation, and maintenance procedures. The instructions in this manual have been prepared to aid you in learning the proper procedures. Where information is of particular importance or is safety related, the words DANGER, WARNING, CAUTION, or NOTE are used. Their usage is described below:



The word DANGER indicates an imminent hazard which will result in highly serious injury such as second or third degree burns.

WARNING

The word WARNING is used to alert you to a procedure, that if not performed properly, might cause personal injury.

CAUTION

The word CAUTION is used to alert you to a procedure that, if not performed properly, may damage the fryer.

NOTE

The word NOTE is used to highlight especially important information.

1-5. ASSISTANCE

Should you require outside assistance, just call your local independent distributor maintained by Henny Penny Corporation.

In addition, feel free to contact our corporate headquarters in Eaton, Ohio. Dial 1-800-543-6243 toll free, except in Ohio dial 1-800-762-2964.

SECTION 2. INSTALLATION

2-1. INTRODUCTION

This section provides the installation instructions for the PVS.

NOTE

Installation of this unit should be performed by qualified service personnel.

WARNING

Do not puncture the skin of the unit with any tools or fastening devices. Electrical shock could result.

2-2. UNPACKING

1. Cut banding.
2. Remove all packaging around fryer.
3. Install casters. Locking casters in front, large casters on the back.
4. Place fryer in the upright position.

WARNING

The fryer weighs approximately 500 pounds. Care should be taken when lifting to prevent personal injury.

5. Unthread the cap on the dead weight valve.

NOTE

A metal shipping support is placed within the dead weight valve housing to protect the orifice and weight during shipment. This support must be removed prior to installation and startup.

6. Remove the weight.
7. Remove and discard the metal shipping support. (See Fryer Service Manual page 2-2.)
8. Clean the orifice with a dry cloth.
9. Replace the weight and cap.

2-2. UNPACKING (Continued)

10. Open the lid of the fryer and remove all accessories.
11. Remove the protective plastic from the fryer cabinet sheet metal and clean with a cloth and detergent water.
12. Slide the drain pan in under the fryer.
13. Connect the filter union.
14. Slide in the condensate pan in front of the drain pan.

2-3. SELECT A FRYER LOCATION

1. Proper clearances must be maintained for proper and safe operation. The clearances from cumbustible materials are:

 4 inches on both sides
 2 inches from the rear
 16 inches from the top
 (See Figure 1)
2. Choose a location where the fryer can be cleaned and serviced regularly. The fryer is on casters so it can be pulled out for cleaning.



Do not move the fryer with hot shortening in the pot unless the fryer lid is closed, or serious burns could result.

2-4. LEVELING THE FRYER

For proper operation, the fryer should be level from side to side and front to back.

Using a level placed on the flat areas around the frypot collar, adjust the leveling bolts or casters until the unit is level.

2-5. ELECTRICAL REQUIREMENTS

The electric fryer is available from the factory wired for 208, 220/240, or 440/480 volts, single or three phase, 60 Hertz service. The proper power service cable must be ordered as an accessory or provided at installation. Check the data plate

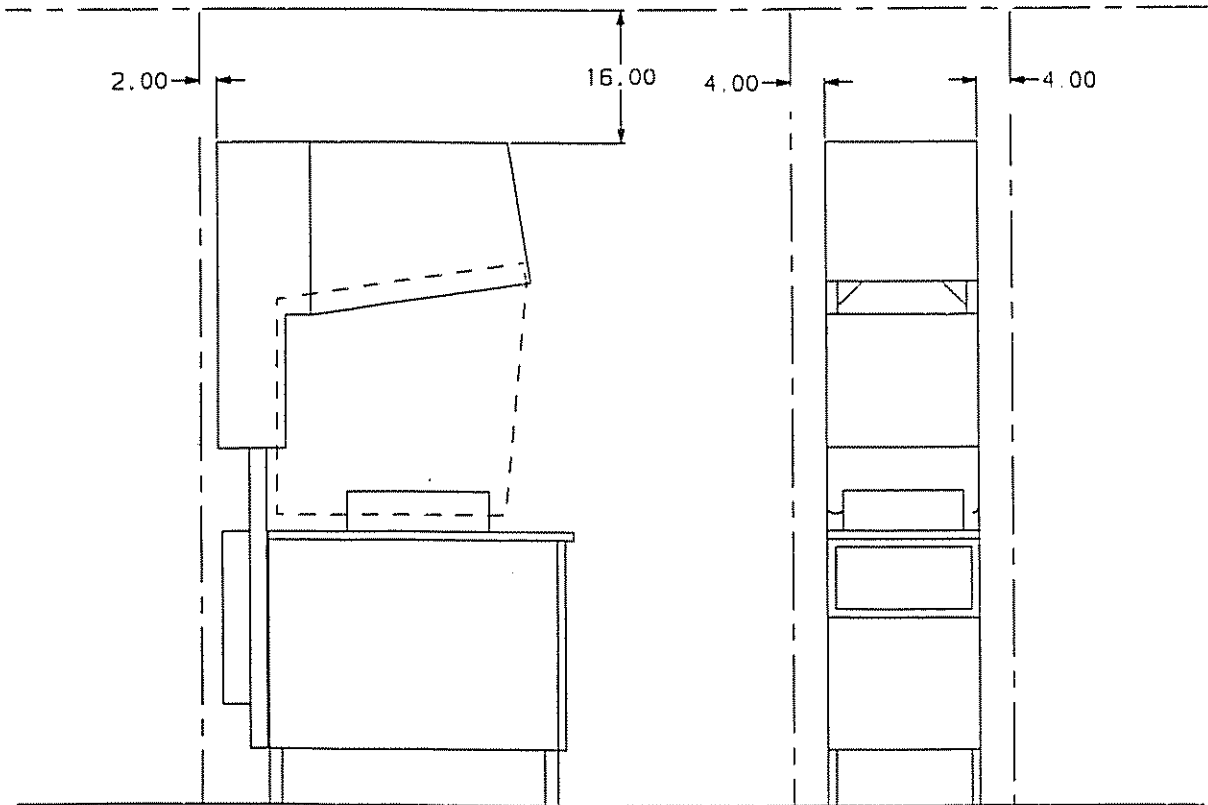

CLEARANCES REQUIRED FROM COMBUSTIBLE SURFACES

Figure 1.

**2-5. ELECTRICAL
REQUIREMENTS (Continued)**

on the inside of the fryer door to determine the correct power supply.



This fryer must be adequately and safely grounded. Refer to local electrical codes for correct grounding procedures. If fryer is not adequately grounded, electrical shock could result.

A separate disconnect switch with proper capacity fuses or breakers must be installed at a convenient location between the fryer and the power source. (The field supply wiring to the fryer should be of the size indicated in the data table.) It should be an insulated copper conductor rated for 600 volts and 90°C. For runs longer than 50 feet, use the next larger size wire.

DATA TABLE
SUPPLY WIRING AND FUSING FOR ELECTRIC FRYER

Volts	Phase	KW	Amps	Supply Wire Size	Min. Fuse Size
208	Single	12.00	58	3	80
208	Single	14.25	69	2	90
208	Three	12.00	34	6	50
208	Three	14.25	41	4	60
220/240	Single	12.00	55/60	3/3	70/80
220/240	Single	14.25	65/71	2/2	90/90
220/240	Three	12.00	33/36	6/6	50/50
220/240	Three	14.25	38/41	6/4	50/60
440/480	Three	12.00	16/18	12/8	20/30
440/480	Three	14.25	19/21	8/8	30/30

2-6. TESTING THE FRYER

1. Fill the water scrubber tank at the rear of the fryer with water. When water begins draining into the condensate pan in the front of the fryer, the scrubber tank is full. (See Section 3-4.)

NOTE

The scrubber tank has a water level sensor which will shut the power off if not enough water is in the tank. The power light will be off and the elements will not heat.

2. Raise the lid.
3. Remove all items from the frypot.
4. Be sure the side shields are in their proper position.



The Fire Suppressant is not effective with the sides removed. For your personal safety, DO NOT remove the sides of hood when operating this equipment.

5. Move all switches and controls to the OFF position.
6. Turn on the main power supply to the fryer using the main circuit breaker or safety switch.
7. Move the main power switch on the fryer control panel to the POWER position.
 - Within in two seconds the RED indicator light labeled POWER will illuminate.
8. Once the RED indicator light is on, the fryer is ready for operation.

For further testing of fryer and PVS, see Final Installation Check-Test Frying, Section 2-7 in the fryer service manual.

SECTION 3. OPERATION

3-1. INTRODUCTION

This section provides explanations on the operation of the components of the PVS. All instructions should be read before operating the cabinet.

3-2. FILTERS

The Henny Penny PVS has three filters to accommodate the exhaust coming off the frypot.

Baffle Grease Filter

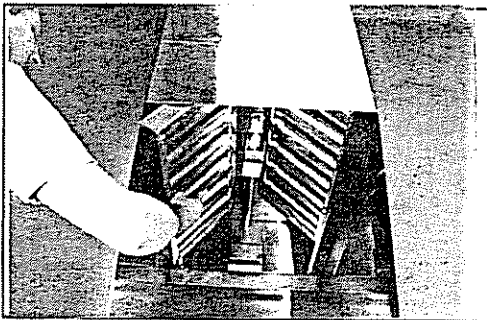

1. The Baffle Grease Filter is the first filter the exhaust comes into contact with. It catches most of any condensation and/or grease that may arise out of the frypot. It must be removed and cleaned periodically. The filter is made of two parts, each can be easily removed by sliding them up and pulling out to be cleaned.

Mesh Grease Filter

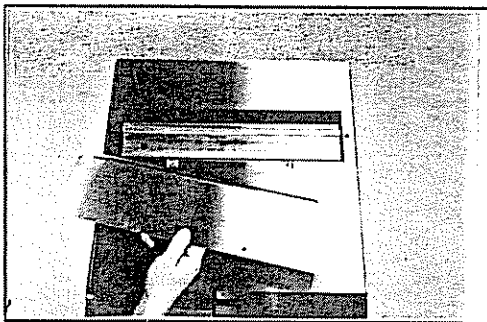

2. The Mesh Grease Filter is the second filter. It catches any particulates or grease that gets by the Baffle Grease Filter. The front access panel must be removed to obtain access to the filter. Once the front cover is removed, the filter can then be pulled straight out to be cleaned.

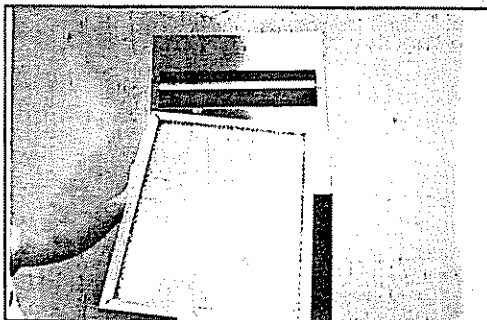

3.2 FILTERS (Continued)

Charcoal Filter

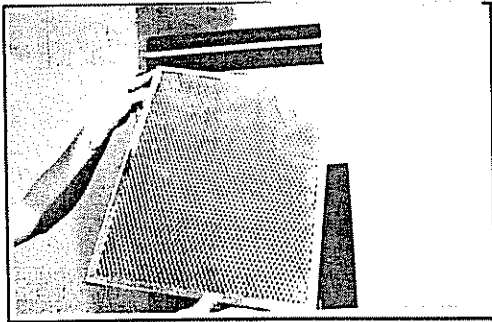

3. Charcoal Filter is the third filter. It is to absorb any odors which come off the frypot. It can NOT be cleaned. It has to be replaced when needed. It also is accessed from the front access panel. It can easily be pulled up and straight out for replacement.

NOTE

The front access panel must be in place to heat up the fryer. A microswitch shuts down the heat when the panel is removed.

3-3. FIRE EXTINGUISHER

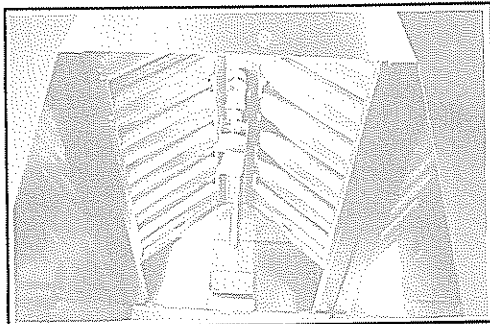

In case of a fire in the pot, a sensor under the PVS hood will set off the fire extinguisher. A pressure switch on the extinguisher will also shut the heat off on the fryer once the extinguisher has lost some pressure.

3-4. SCRUBBER TANK

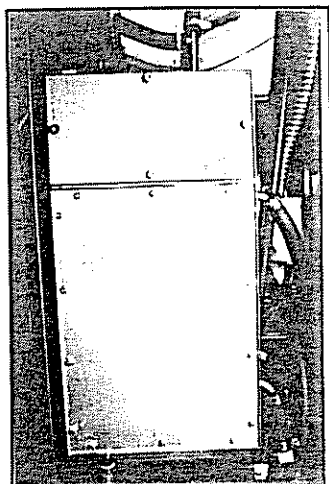

This tank must be manually filled before operating the fryer. It is on the back of the fryer, behind the lower back panel. The top portion of the tank is easily removed with four (4) thumb nuts. The tank then is filled until water overflows to the condensate pan in the front of the fryer. Once the tank is filled and the fryer is operating, a pump circulates the water through a radiator at the top of the PVS, which cools the water. The fryer steam exhaust is blown directly into the scrubber tank.

3.4 SCRUBBER TANK (Continued)

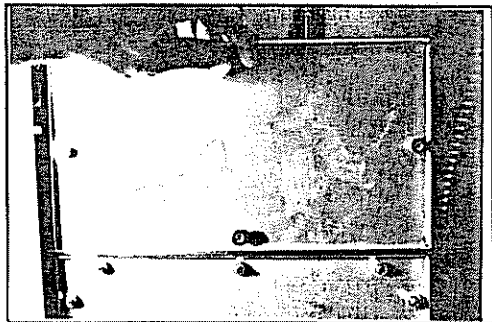

The cool water from the radiator also is plumbed into the tank and changes the steam to water. Any excess water is then drained out to the condensate pan.

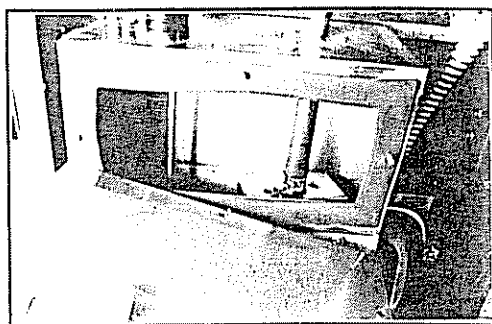

3-5. BLOWER

The Blower in the top of the PVS creates an upward draft of air under the hood so that the exhaust and odors off the frypot are absorbed into the filters. It also blows across the radiator, keeping the water cool in the system.

SECTION 4. CLEANING INSTRUCTIONS (PVS ADDENDUM)

4-1. INTRODUCTION

The PVS, along with the fryer, must be cleaned and maintained to operate efficiently and properly. This section provides procedures on cleaning the various parts of the PVS.

4-2. CLEANING SCHEDULE

1. Baffle Grease Filters: Clean at least once every seven days. If any open frying is done, then the cleaning schedule should be altered to once every three days.
2. Mesh Grease Filters: Clean on the same schedule as the baffle grease filters.
3. The water scrubber tank at the rear of the fryer should be drained and cleaned at least once every seven days.

4-3. CLEANING PROCEDURES - FILTERS

1. Baffle grease filters and mesh grease filters should be removed and placed in hot detergent water to soak for 15 minutes.
2. The baffle grease filters can be scrubbed if necessary to remove any accumulation of grease.
3. Rinse both types of filters with hot water.
4. Allow to air dry.
5. Install the filters in the PVS hood area.

CAUTION

There are arrows on the side of the filters indicating the direction of airflow through the filters. Be sure the filters are installed so the air flows through the filters in the proper direction, or filters may clog prematurely.

**4-4. CLEANING PROCEDURES
- WATER SCRUBBER
TANK**

1. Remove bottom, back panel.
2. Drain all the water by opening the drain valve in the bottom of the tank.



The water in this tank can be hot; burns could result.

3. Remove the top panel on the rear of the scrubber tank. (See Section 3-4.)
4. Rinse the tank out with clean hot water.
5. Inspect the interior of the tank. It may be necessary to reach inside and scrub the tank with hot detergent water.
6. If necessary, the bottom panel can be removed for a more thorough cleaning.
7. With the bottom panel reinstalled, fill the tank with clean water.
8. Install the top panel.

**4-5. CLEANING PROCEDURES
- PVS HOOD AREA**

1. When the filters are removed for cleaning, wipe out the internal hood area with hot detergent water and a wash cloth.



Close the fryer lid when using any water over the frypot. Water splashing in the frypot shortening can cause a violent reaction; burns could result.

4-6. SIDE PANEL CLEANING

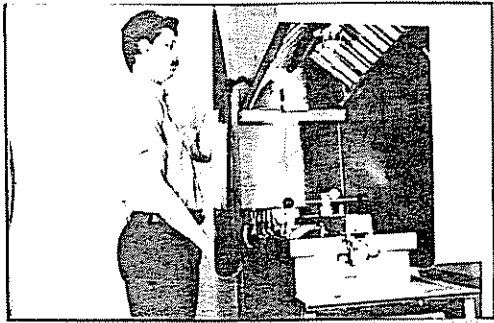

1. Remove the side panels by lifting them up and out. Be careful in handling.
2. Wipe the side panels clean with hot detergent water and a wash cloth.
3. Reinstall panels to operate fryer.

NOTE

Removing the side panels gives easier access to clean the area of the fryer behind the frypot.



The Fire Suppressant system is not effective with the sides removed. For your personal safety, **DO NOT** remove the sides of hood when operating this equipment. Also, the fryer will not heat up without the sides in place.

4-7. CLEANING AND MAINTENANCE SCHEDULE

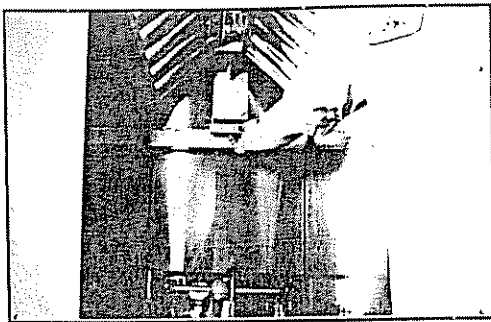

Baffle Grease Filter, Mesh Grease Filter and Scrubber Tank - Cleaned once a week.

Charcoal Filter - Replaced every six months.

Condensation Pan - Checked after every two loads.

Filter Drip Trough - Checked once a day. (See Photo)

SECTION 5. TROUBLESHOOTING (PVS ADDENDUM)

5-1. INTRODUCTION

Because the PVS Model 500 Electric Fryer has the capability to clean the exhaust of the frying process, certain malfunctions in the hood area can cause the fryer to shut down. These potential malfunctions will be discussed in this section.

5-2. TROUBLESHOOTING

The PVS portion of the Model 500 fryer has safeties built-in to ensure proper operation. These safeties will turn off the RED indicator light labeled POWER. Units with Computron controls will show the error code "E10" when any of the following safeties are tripped.

1. LIMIT SWITCH, FRONT FILTER ACCESS PANEL. This panel must in place to activate the fryer heating elements.
2. LIMIT SWITCH, SIDE PANELS. The side panels must be mounted in position to energize the fryer heating elements.



The Fire Suppressant System is not effective with the sides removed. For your personal safety, DO NOT remove the sides of hood when operating this equipment.

3. AIR FLOW PRESSURE SWITCH. If there is no air flow, this switch will not activate. If there is limited air flow because of dirty filters, there could be interruptions in the primary power to the fryer heating elements. Proper filter cleaning should prevent this from happening. Also, the copper tube in the top of the unit needs to be up against the metal shroud to ensure proper air flow to the switch.
4. FIRE EXTINGUISHER PRESSURE SWITCH. If the fire extinguisher were to leak or fully discharge, this switch will interrupt primary power to the fryer heating elements and shut down the blower. The fire extinguisher has a pressure gauge for inspection of pressure (approximately 100 psi).

5-2. TROUBLESHOOTING
(Continued)**WARNING**

If the extinguisher has lost pressure, it must be replaced. Do not operate the unit with a faulty extinguisher. Do not attempt to recharge an extinguisher or the extinguisher may not work properly when needed.

5. **LEVEL SENSOR, WATER SCRUBBER.** If the water scrubber tank does not maintain a certain water level, this sensor will shut down the primary power to the fryer heating elements.

NOTE

The opening of the high limit of the fryer will result in the same heating element shut down. If these safeties described seem to be functioning properly, check the manual on resetting the high limit.

SECTION 6. MAINTENANCE

6-1. INTRODUCTION

This section provides procedures for the check out and replacement of the various parts used within the PVS. Before replacing any parts, refer to Section 4A, Troubleshooting. It will aid you in determining the cause of the malfunction.

6-2. MAINTENANCE HINTS

1. You may use two test instruments to check the electric components.
 - A continuity light
 - An ohmmeter
2. When the manual refers to the circuit being closed the continuity light will be illuminated or the ohmmeter will read 1 (one).

NOTE

A continuity tester cannot be used to check coils or motors.

6-3. MICROSWITCHES

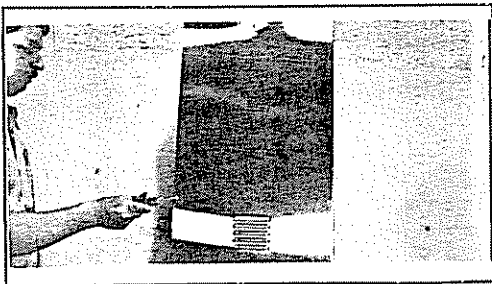

1. SIDE PANEL MICROSWITCHES

- A. Remove all electrical power to unit.

WARNING

Remove electrical power supplied to the unit by unplugging the unit or turning off the wall circuit breaker. Electrical shock could result.

- B. Remove the twelve (12) screws securing the top, back panel of the PVS.
- C. Remove the wires from the terminals of the microswitch and take a continuity check on the switch. With the plunger on the switch pushed down, the circuit should be closed. With the plunger out, the circuit should be open. If the microswitch proves to be faulty, continue to next step.

**6-3. MICROSWITCHES
(Continued)**

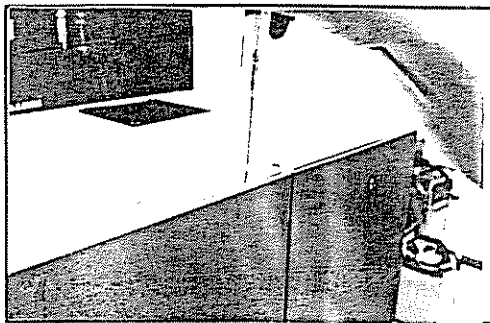
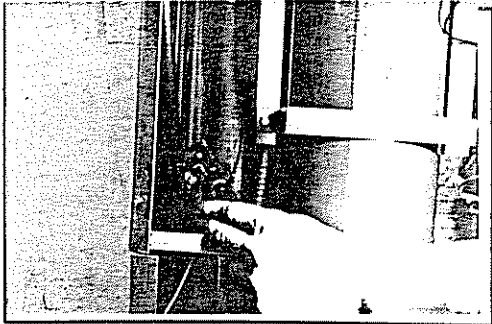

- D. With the 3/8" socket, remove the nuts securing the bracket to the unit and remove bracket.
 - E. Remove microswitch from bracket.
 - F. Install new microswitch in reverse order.
2. Filter Access Panel Microswitch
- A. Remove electrical power to unit.

WARNING

Remove electrical power supplied to the unit by unplugging the unit, or turning off the wall circuit breaker. Electrical shock could result.

- B. Remove the six (6) screws securing the top access panel and remove panel.
- C. Remove wires from terminals and check for continuity on the switch. With the plunger on the switch pushed down, the circuit should be closed. With the plunger out, the circuit should be open. If the microswitch proves to be faulty, continue on to the next step.
- D. Using a 3/8" socket, remove the nuts securing the bracket to the unit and remove bracket.
- E. Remove microswitch from bracket.
- F. Install new microswitch in reverse order.

NOTE

The bracket is slotted to allow the switch to be lined up with the hole in the hood. The fryer will not heat up until the microswitch is activated with the peg on the filter access panel.

6-4. PUMP

Checkout:

Replacement:

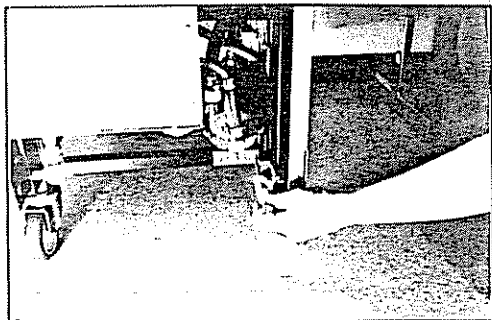
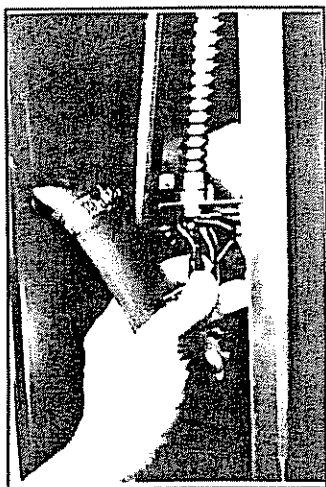
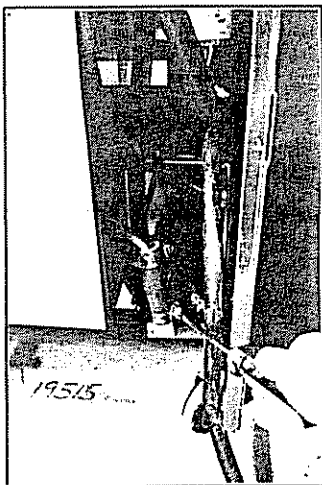

The pump circulates the water up through the radiator.

A check across motor wire leads should show about 40 ohms.

1. Remove electrical power to unit.

WARNING

Remove electrical power supplied to the unit by unplugging the unit, or turning off the wall circuit breaker. Electrical shock could result.

2. Remove the bottom, back panel of unit, which slides up and out.

3. Remove hoses from pump.

4. Remove wires from the wire nuts inside junction box.

5. Remove screws securing bracket to frame of fryer and remove bracket.

6. Remove pump from bracket.

7. Install new pump in reverse order.

6-5. AIR PRESSURE SWITCH

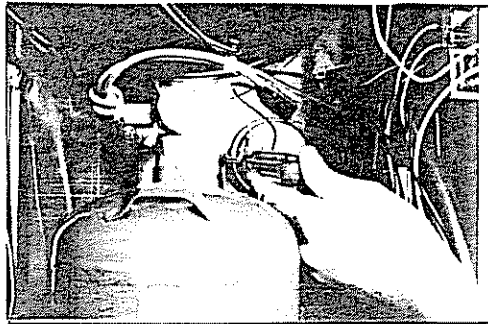
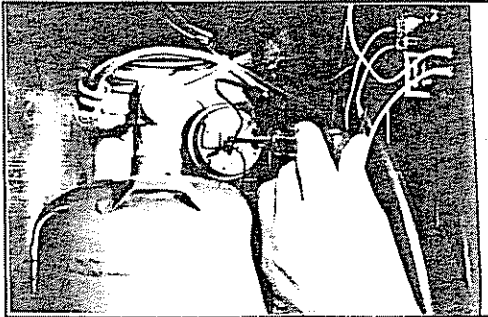

1. Remove electrical power to unit.

WARNING

Remove electrical power supplied to the unit by unplugging the unit, or turning off the wall circuit breaker. Electrical shock could result.

2. Remove the twelve (12) screws securing the top, back panel to the unit, and remove back panel.
3. Remove wires from terminals and check switch for continuity. The circuit should be closed while blower is functioning; open when it is not. If switch proves to be faulty, continue to next step.
4. Using a 5/16" socket, remove the nuts securing the bracket to the unit and remove bracket.
5. Remove switch from bracket.
6. Install new switch in reverse order.

6-6. WATER LEVEL SENSOR

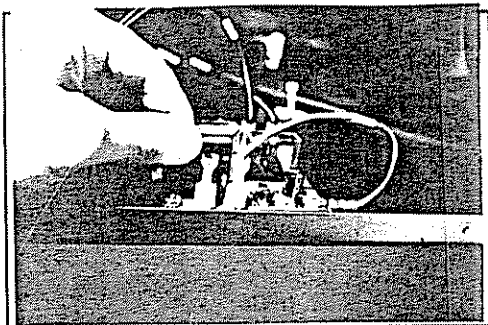

1. Remove electrical power to unit.

WARNING

Remove electrical power supplied to the unit by unplugging the unit, or turning off the wall circuit breaker. Electrical shock could result.

2. Remove the twelve (12) screws securing the top, back panel and remove panel.
3. Remove and label wires from sensor.

NOTE

Wires should be labeled or marked to ensure correct wiring when reconnecting wires.

**6-6. WATER LEVEL SENSOR
(Continued)**

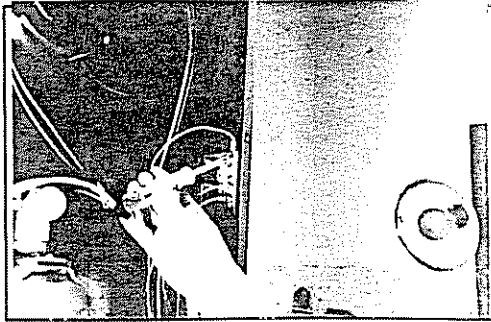

4. Using a 5/16" socket, remove the nuts securing the sensor to the unit and remove sensor.
5. Install new sensor in reverse order.

6-7. BLOWER

Checkout:

Replacement:

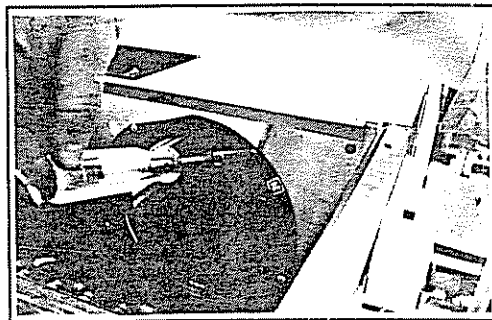
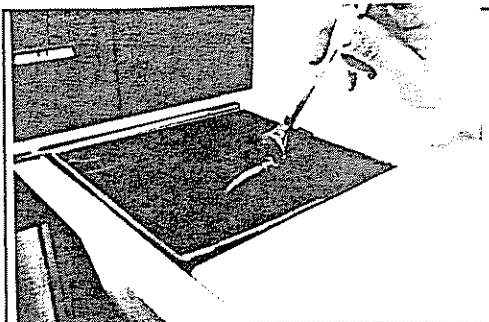

A check across wire leads should show about 6 ohms

1. Remove electrical power to unit.

WARNING

Remove electrical power supplied to the unit by unplugging the unit, or turning off the wall circuit breaker. Electrical shock could result.

2. Remove the twelve (12) screws securing the top, back panel to the unit and remove panel.
3. Remove the top access panel of the PVS.
4. Using a 9/16" wrench, remove the brass nut securing the pressure switch tube to the blower housing.
5. Straighten the tube and pull the tube from the blower from behind the unit.
6. Disconnect the wires of the blower from the relay.
7. From the top of the unit, remove the five (5) screws securing the blower to the unit.
8. Pull blower out from the back of the unit.
9. Install new blower in reverse order.

NOTE

When installing the tube into the blower, be sure the tube is bent downward and up against the metal shroud. The pressure switch may not register enough air pressure unless it is installed properly.

6-8. FIRE EXTINGUISHER

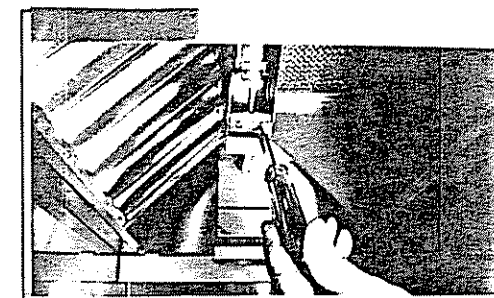
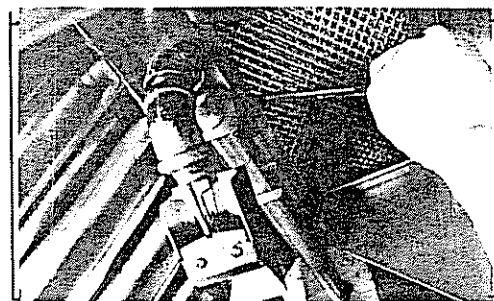
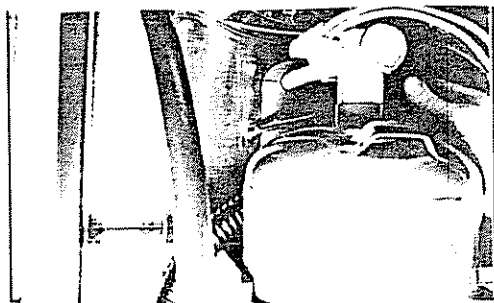
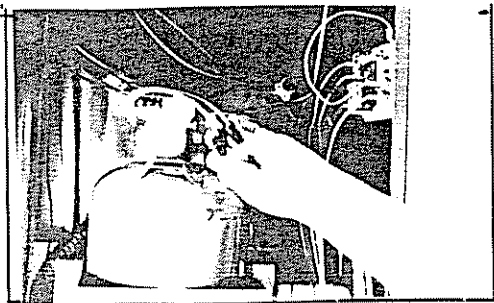

The fire extinguisher cannot be recharged out in the field. It must be sent back to the factory.

1. Remove the electrical power to unit.

WARNING

Remove electrical power supplied to the unit by unplugging the unit, or turning off the wall circuit breaker. Electrical shock could result.

2. Remove the twelve (12) screws securing the top, back panel of the unit and remove panel.
3. Disconnect wires of the pressure switch at the wire nuts.
4. Using a 3/8" socket, remove the two (2) nuts securing the deflector onto the unit, and remove the deflector.
5. Remove the baffle grease filter from unit.
6. Using a 3/8" wrench, remove nuts securing the extension bracket from underneath the hood.
7. Using a 3/8" socket, remove the four (4) bolts securing the extinguisher brackets and remove brackets.
8. Remove deflector shield from end of nozzle.
9. Carefully pull extinguisher out from the back of the unit.
10. Install new extinguisher in reverse order.

6-9. RELAY

Checkout:

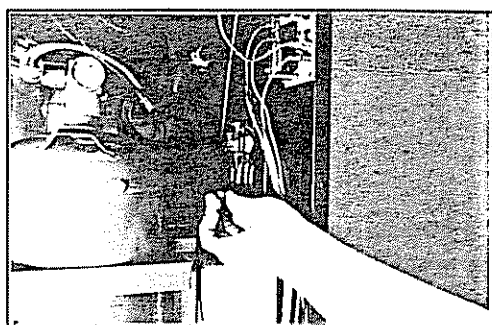
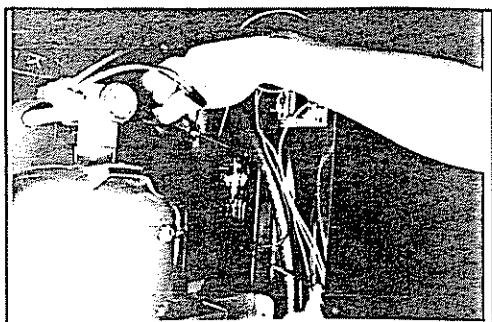

The relay in the unit protects the extinguisher pressure switch from high current.

1. Remove electrical power to unit.

WARNING

Remove electrical power supplied to the unit by unplugging the unit, or turning off the wall circuit breaker. Electrical shock could result.

2. Remove the twelve (12) screws securing the top, back panel to the unit and remove panel.
3. Remove and label wires from relay.

NOTE

Wires should be labeled, or marked, to ensure correct wiring when re-connecting wires.

4. Check across terminals A and B. The resistance should show about 9 ohms.

5. Across terminal:	Result:
1-7	Closed
3-9	Closed
4-7	Open
6-9	Open

NOTE

The terminals of the relay are labeled on the relay for your convenience. If the relay proves to be faulty, continue on to the next step.

6. Remove the two (2) nuts securing the relay to the unit and remove relay.
7. Install new relay in reverse order.

**LIMITED WARRANTY
FOR HENNY PENNY APPLIANCES**

Subject to the following conditions, Henny Penny Corporation makes the following limited warranties to the original purchaser only for Henny Penny appliances and replacement parts:

New Equipment Any part of a new appliance, except lamps and fuses, which proves to be defective in material or workmanship within one year from date of original installation, will be repaired or replaced without charge F.O.B. factory, Eaton, Ohio, or F.O.B. authorized distributor. To validate this warranty, the registration card for the appliance must be mailed to Henny Penny within 10 days after installation.

Replacement Parts Any appliance replacement part, except lamps and fuses, which proves to be defective in material or workmanship within 90 days from date of original installation will be repaired or replaced without charge F.O.B. factory, Eaton, Ohio, or F.O.B. authorized distributor.

This warranty covers only the repair or replacement of the defective part and does not include any labor charges for the removal and installation of any parts, travel or other expenses incidental to the repair or replacement of a part.

Any claim must be presented to either Henny Penny or the distributor from whom the appliance was purchased. No allowance will be granted for repairs made by anyone else without Henny Penny's written consent. If damage occurs during shipping, notify the carrier at once so that a claim may be filed.

THE ABOVE LIMITED WARRANTY SETS FORTH THE SOLE REMEDY AGAINST HENNY PENNY FOR ANY BREACH OF WARRANTY OR OTHER TERM. BUYER AGREES THAT NO OTHER REMEDY (INCLUDING CLAIMS FOR ANY INCIDENTAL OR CONSEQUENTIAL DAMAGES) SHALL BE AVAILABLE.

The above limited warranty does not apply (a) to damage resulting from accident, alteration, misuse, or abuse; (b) if the equipment's serial number is removed or defaced; or (c) for lamps and fuses. THE ABOVE LIMITED WARRANTY IS EXPRESSLY IN LIEU OF ALL OTHER WARRANTIES, EXPRESS OR IMPLIED, INCLUDING MERCHANTABILITY AND FITNESS, AND ALL OTHER WARRANTIES ARE EXCLUDED. HENNY PENNY NEITHER ASSUMES NOR AUTHORIZES ANY PERSON TO ASSUME FOR IT ANY OTHER OBLIGATION OR LIABILITY.

SECTION 7. PARTS INFORMATION

7-1. INTRODUCTION

This section identifies and lists the replaceable parts of the Henny Penny Portable Venting System.

7-2. GENUINE PARTS

Use only genuine Henny Penny parts in your cabinet. Using a part of lesser quality or substitute design may result in cabinet damage or personal injury.

7-3. HOW TO FIND PARTS

To find items you want to order from the Parts List, proceed as follows:

1. Refer to the photographs in the front of the Operation Section and to the exploded drawings in this section to identify the part needed.
2. Use the item number from the exploded drawing to locate the corresponding part in the Parts List in this section. In this list will be the Henny Penny part number and a description of the part.

7-4. HOW TO ORDER

Once the parts you want to order have been found in the Parts List, write down the following information:

1. From the photograph and Parts List. Example:

Item number	<u>4</u>
Part Number	<u>18227</u>
Description	<u>Microswitch</u>

2. From the data plate. Example:

Product number	<u>02310</u>
Serial number	<u>LB038HI</u>
Voltage	<u>208/120</u>

3. The following table has been provided as a sample format for you to use in preparing your spare parts orders. By providing all the entries, your distributor will be able to insure the correct parts will be sent to you. Also, by prepayment your order will be expedited.

FROM PARTS LIST			YOUR ORDER		
Item Number	Part Number	Description	Quantity Ordered	Price Each	Total
4	18227	Microswitch			
Product No. <u>02310</u>		Serial No. <u>LB038HI</u>	Voltage <u>208/120</u>		

7-5. PRICES

Your distributor has a priced parts list and will be glad to inform you of the cost of your parts order.

7-6. DELIVERY

Commonly replaced items are stocked by your distributor and will be sent out when your order is received. Other parts will be ordered by your distributor from Henny Penny Corporation. Normally, these will be sent to your distributor within three working days.

7-7. WARRANTY

Refer to the warranty statement found at the beginning of this section.

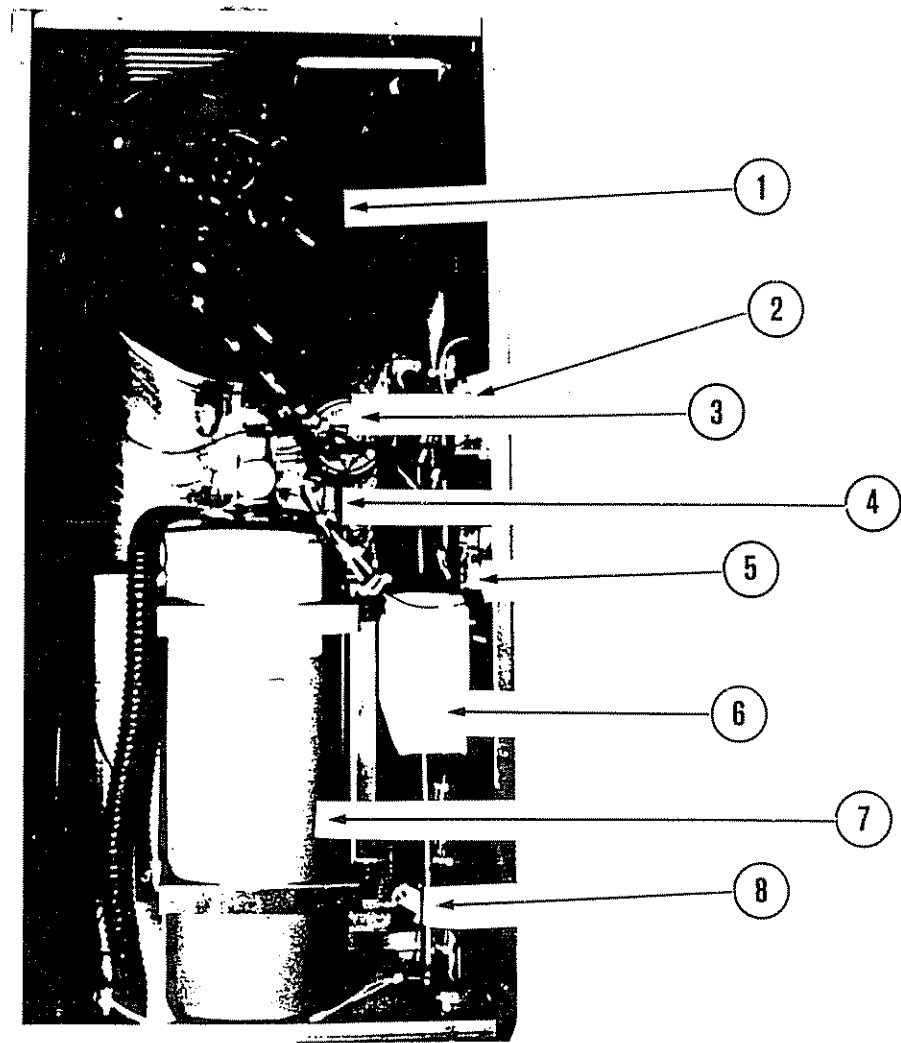

ITEM	PART NO.	DESCRIPTION	QTY.
1	30924	BLOWER	1
2	30818	WATER LEVEL SENSOR	1
3	30628	AIR PRESSURE SWITCH	1
4	30759	HOSE - Pressure Switch	1
5	30723	RELAY	1
6	30770	TRANSFORMER (208 volt only)	1
7	30729	FIRE EXTINGUISHER ASSEMBLY	1
8	18227	MICROSWITCH	3

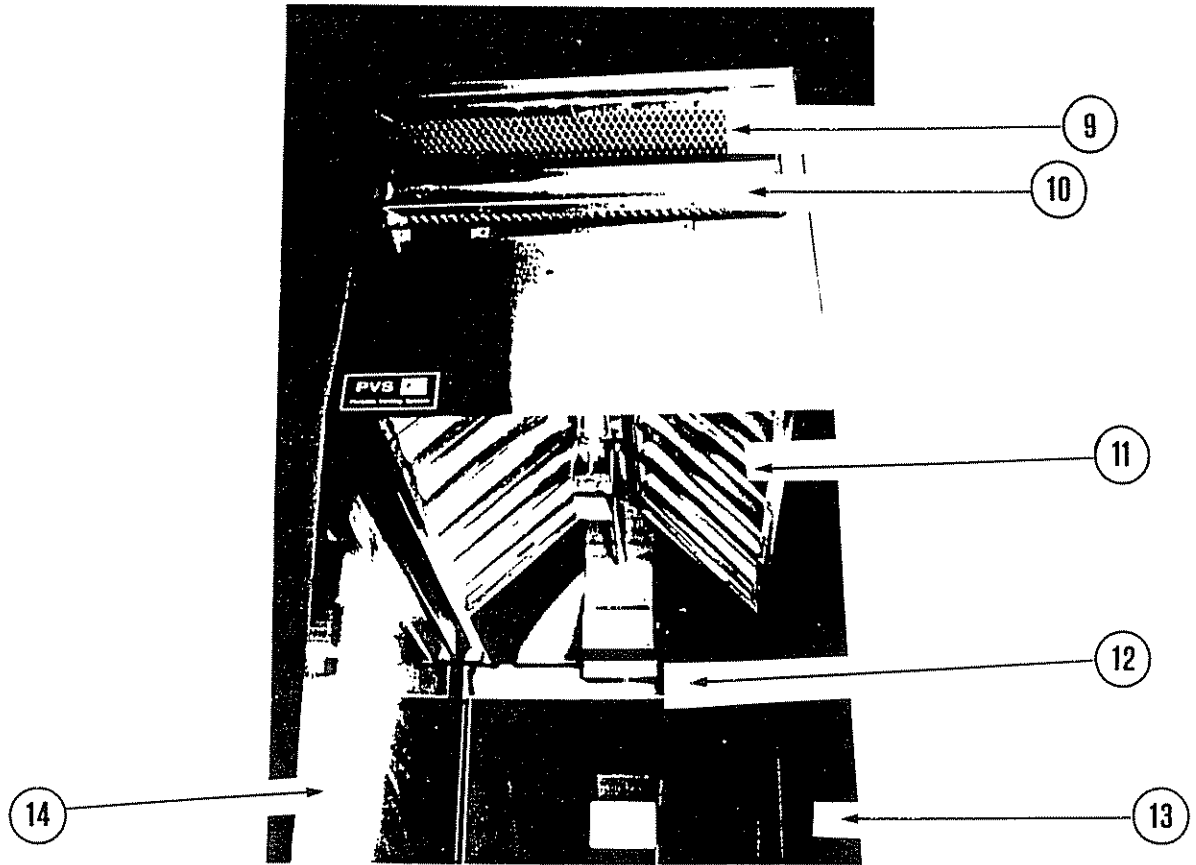

ITEM	PART NO.	DESCRIPTION	QTY.
9	30632	CARBON FILTER	1
10	30631	MESH FILTER	1
11	30630	BAFFLE GREASE FILTER	2
12	30671	DRIP PAN	1
13	30649	RIGHT SIDE SHIELD	1
14	30651	LEFT SIDE SHIELD	1

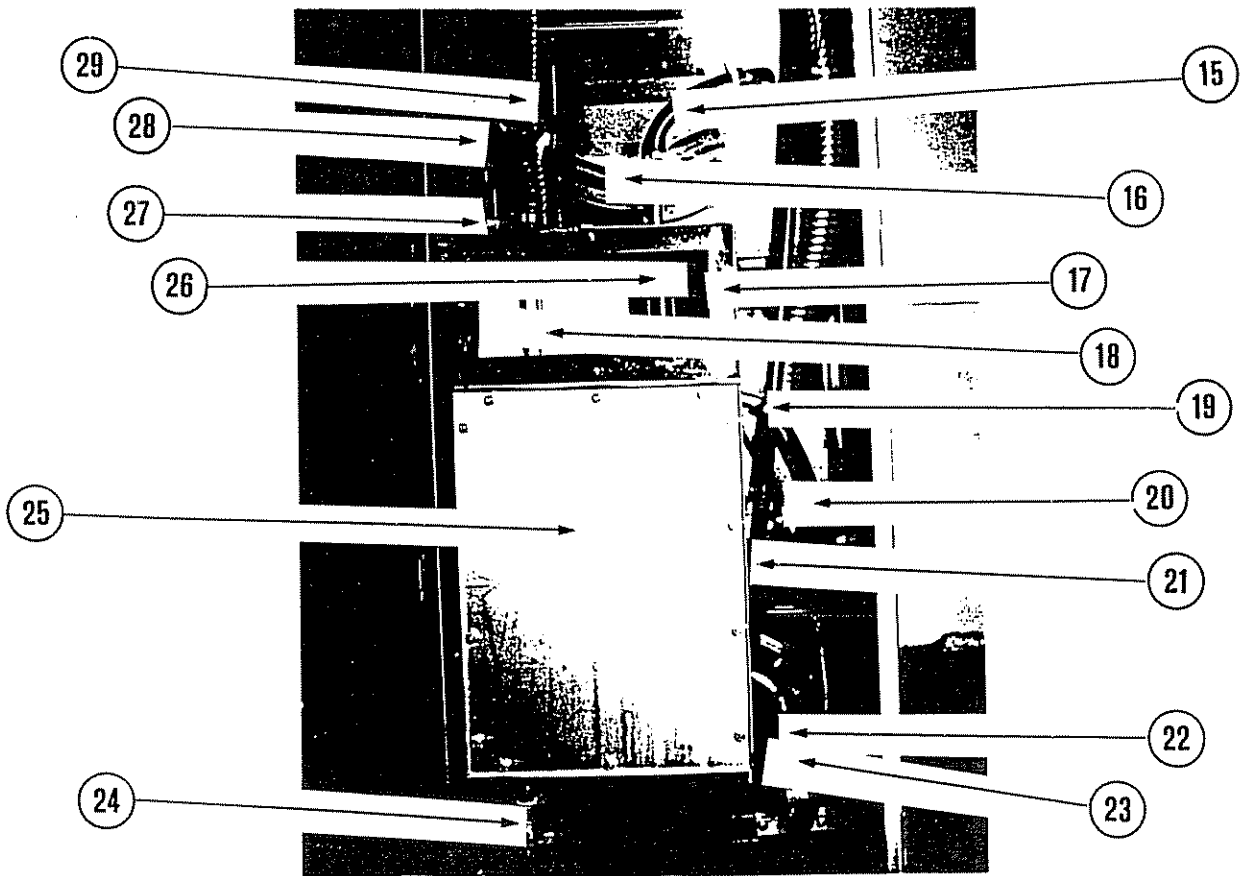

ITEM	PART NO.	DESCRIPTION	QTY.
15	30755	HOSE - Exhaust	1
16	30755	HOSE - Exhaust	1
17	30763	GASKET - Upper Tank	1
18	30803	WATER LEVEL PROBE	1
19	MS01-297	HOSE CLAMP - SS	5
20	37844	DRAIN HOSE	1
21	30757	HOSE - Water Supply	1
22	30754	HOSE - Pump Motor	1
23	30629	WATER PUMP	1
24	17308	DRAIN VALVE	1
25	37839 30714	WATER TANK & BRACE ASS'Y.....	1
26	30755	HOSE - Exhaust	1
27	MS01-294	CLAMP - Nylon Hose (.75-.875 dia.)	3
	MS01-295	CLAMP - Nylon Hose (.875-1.00 dia.)	5
	MS01-296	CLAMP - Nylon Hose (1.03-1.19 dia.)	2
28	30756	HOSE - Water Return	1
29	30760	HOSE - Exhaust-Wire	1
	30725	<i>W.C. 10/10/10</i>	

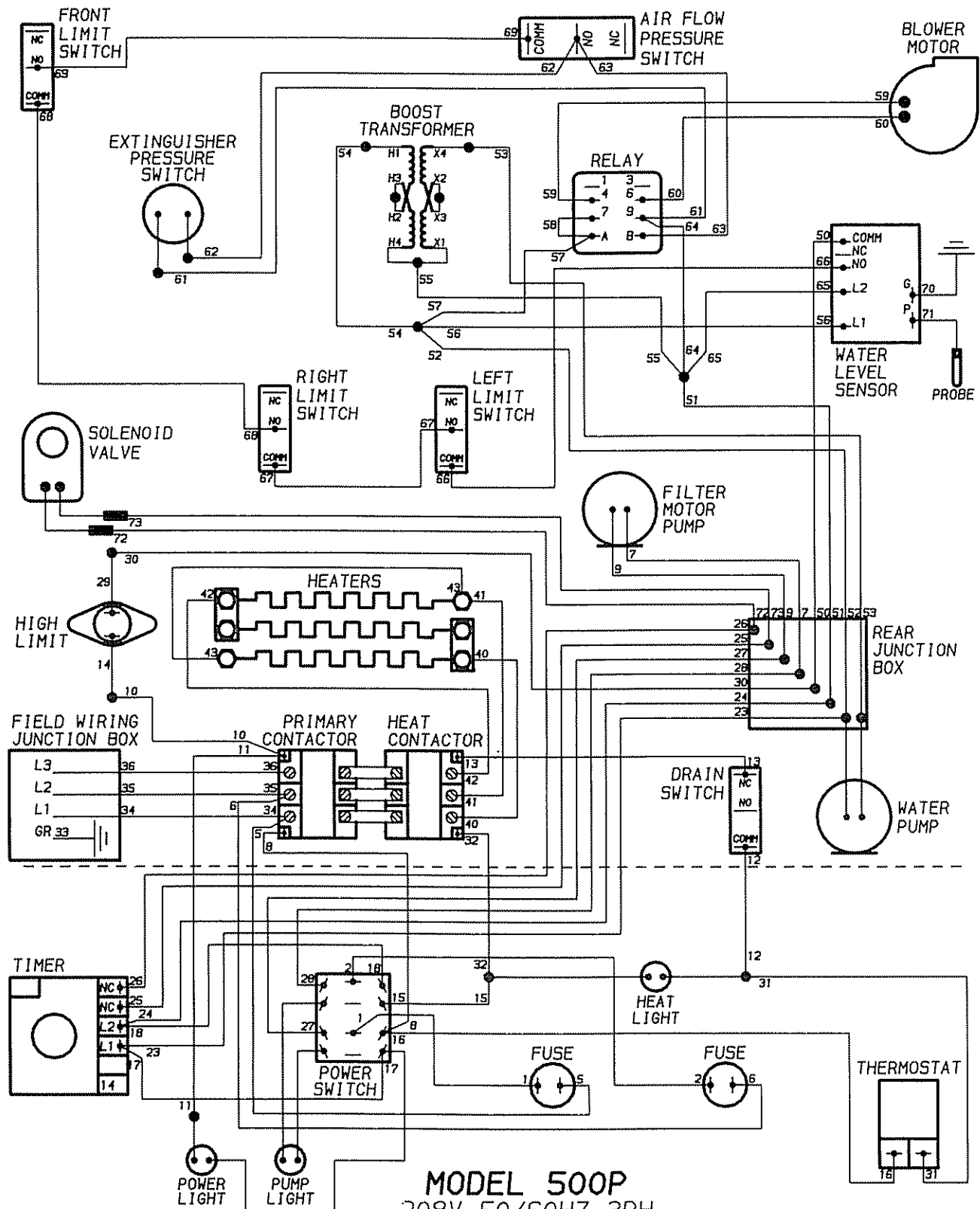

MODEL 500P
208V 50/60HZ 3PH
HENNY PENNY CORP.
EATON, OHIO 45320

30762

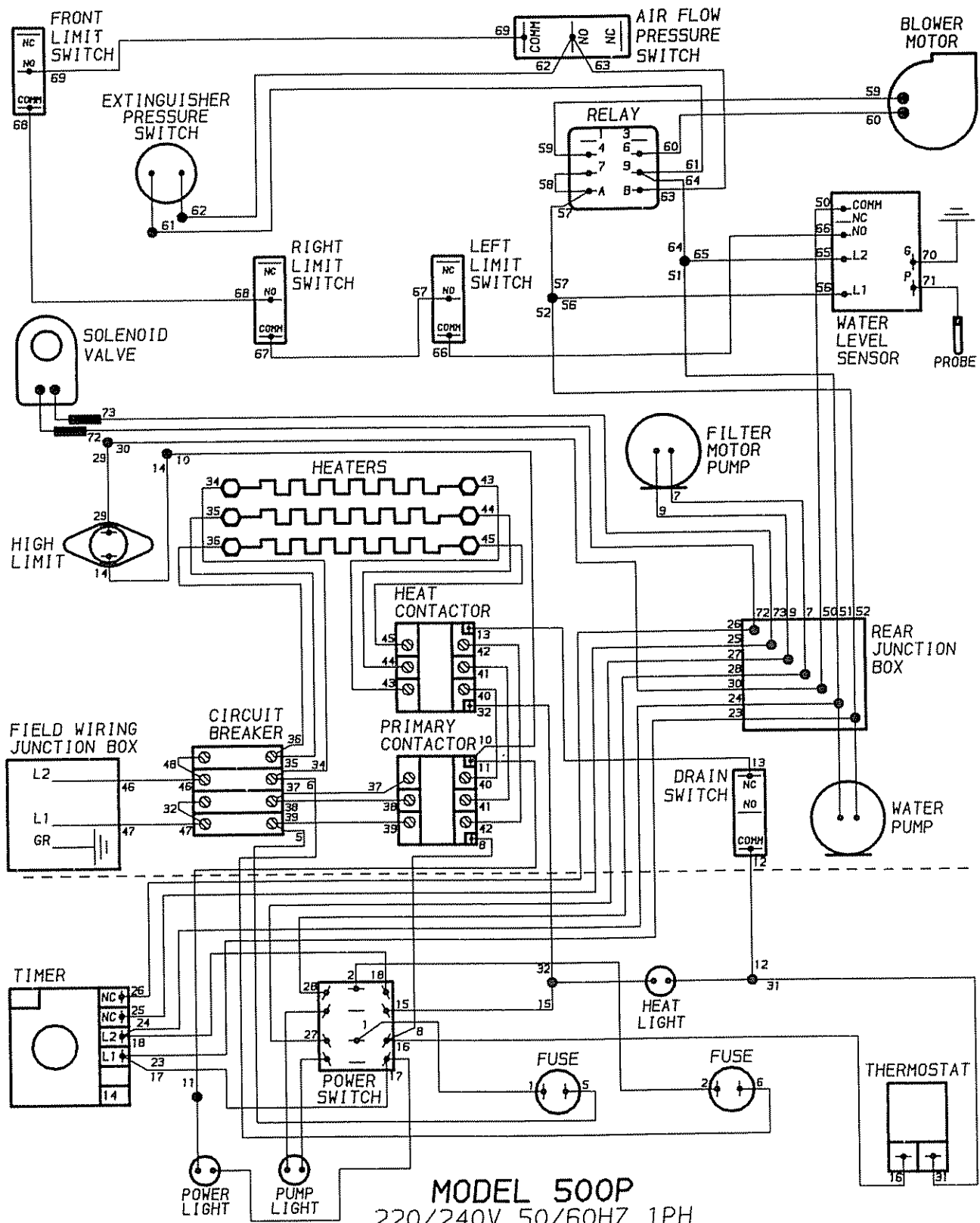

MODEL 500P
220/240V 50/60HZ 1PH
HENNY PENNY CORP.
EATON, OHIO 45320

30799

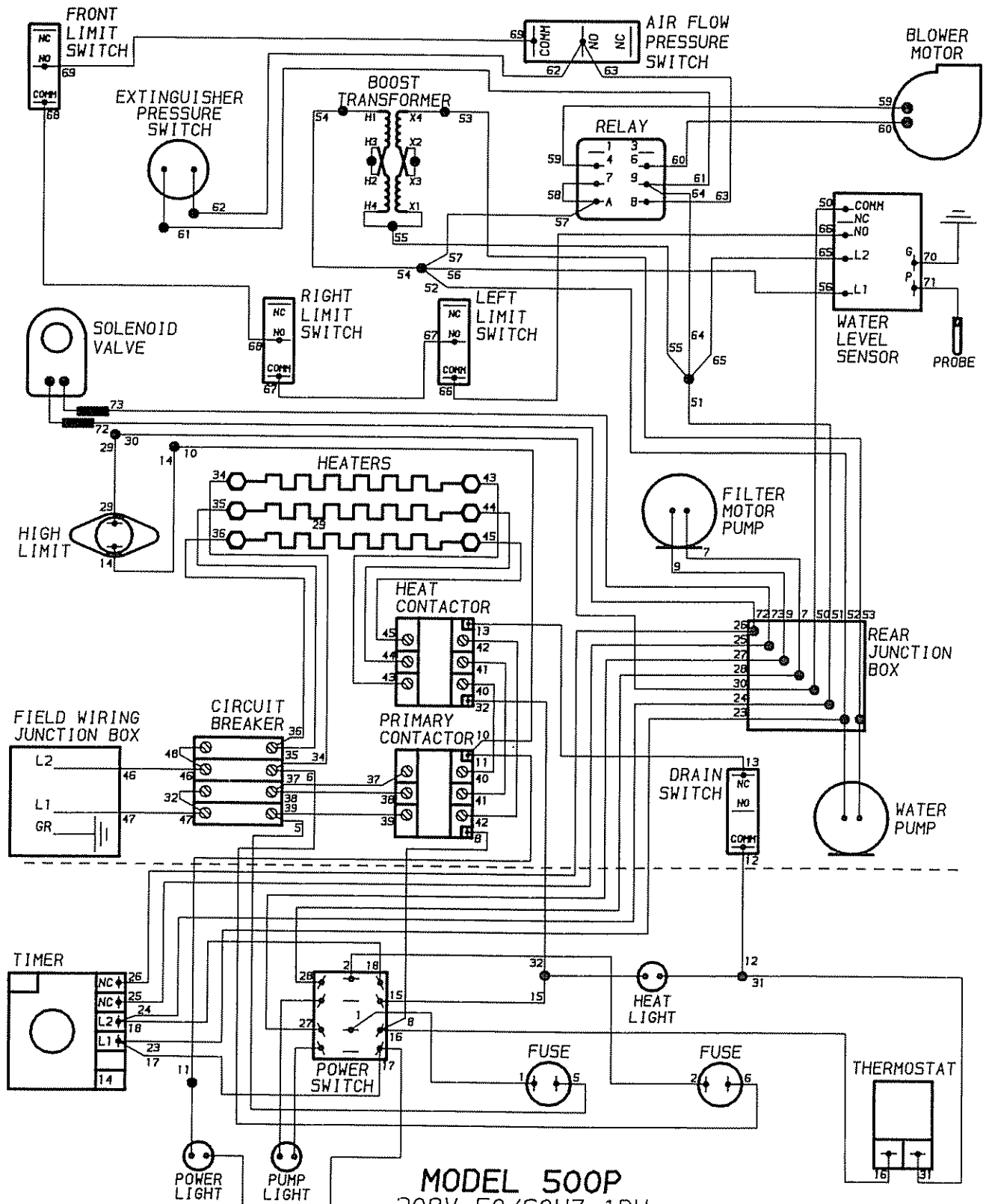

MODEL 500P
208V 50/60HZ 1PH
HENNY PENNY CORP.
EATON, OHIO 45320

30836

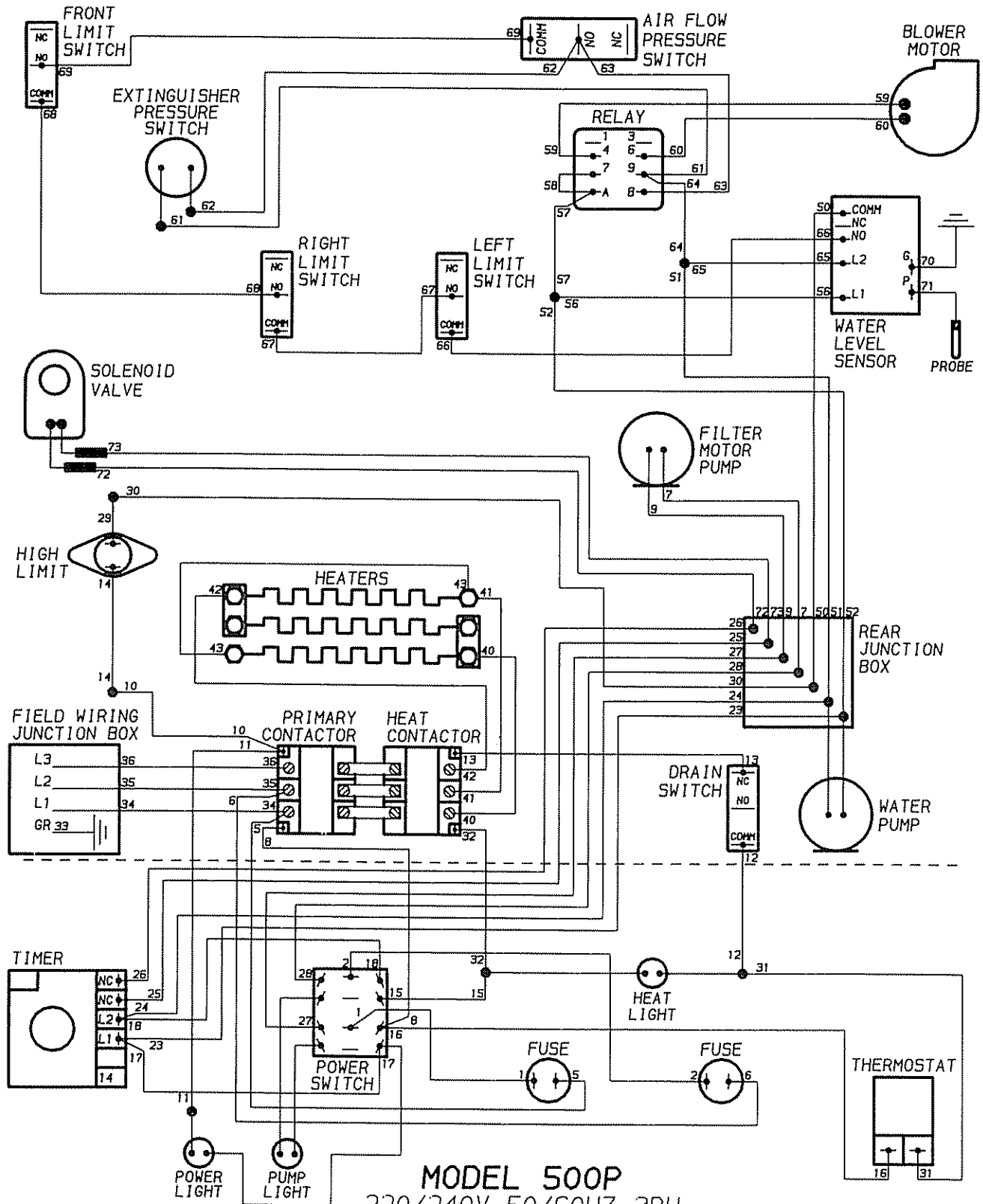

MODEL 500P
220/240V 50/60HZ 3PH
HENNY PENNY CORP.
EATON, OHIO 45320

30837

