



# **Henny Penny CFA Pressure Fryer**

**Electric Model 500  
Gas Model 600**

**TECHNICAL MANUAL**



## NOTICE

This manual should be retained in a convenient location for future reference.

A wiring diagram for this appliance is located on the rear shroud cover of the control panel.

Post in a prominent location, instructions to be followed if user smells gas. This information should be obtained by consulting the local gas supplier.

The Model 600 Fryer is equipped with a continuous pilot. Fryer cannot be operated without electric power. Fryer will automatically return to normal operation when power is restored.

Do not obstruct the flow of combustion and ventilation air. Adequate clearance must be left all around appliance for sufficient air to the combustion chamber.

## CAUTION FIRE HAZARD

To avoid a fire, keep appliance area free and clear from combustibles.

## WARNING

**Improper installation, adjustment, alteration, service or maintenance can cause property damage, injury or death. Read the installation, operating and maintenance instructions thoroughly before installing or servicing this equipment.**

## DANGER

**DO NOT STORE OR USE GASOLINE OR OTHER FLAMMABLE VAPORS AND LIQUIDS IN THE VICINITY OF THIS OR ANY OTHER APPLIANCE. FIRE OR EXPLOSION COULD RESULT.**

**TABLE OF CONTENTS**

<b>Section</b>	<b>Page</b>
Section 1. TROUBLESHOOTING .....	1-1
1-1. Introduction .....	1-1
1-2. Safety .....	1-1
1-3. Troubleshooting .....	1-2
1-4. Warnings and Error Messages .....	1-13
1-5. Diagnostic Mode Details .....	1-16
1-6. Information Mode Details .....	1-32
 Section 2. MAINTENANCE .....	 2-1
2-1. Introduction .....	2-1
2-2. Maintenance Hints .....	2-1
2-3. Preventive Maintenance Schedule .....	2-2
2-4. Removing the Control Panel .....	2-2
2-5. Transformer Replacement .....	2-3
2-6. Temperature Probe Replacement .....	2-4
2-7. High Temperature Limit Control (Electric and Gas Models) .....	2-6
2-8. Heating Elements (Electric Models) .....	2-9
2-9. Heating Contactors (Electric Models) .....	2-12
2-10. Gas Burner Assembly (Gas Models) .....	2-15
2-11. Thermocouple (Gas Models) .....	2-18
2-12. Gas Control Valve .....	2-20
2-13. Electrical Components .....	2-23
2-14. Pressure Regulation/Exhaust .....	2-27
2-15. Filtering System .....	2-47
2-16. Gas Conversion .....	2-52
Wiring Diagrams .....	2-53
 Section 3. PARTS INFORMATION .....	 3-1
3-1. Introduction .....	3-1
3-2. Genuine Parts .....	3-1
3-3. Model Variations .....	3-1
3-4. How to Find Parts .....	3-1
3-5. Subassemblies .....	3-2
3-6. How to Order Parts .....	3-2
3-7. Prices .....	3-3
3-8. Delivery .....	3-3
3-9. Warranty .....	3-3
3-10. Recommended Spare Parts for Distributors .....	3-3
3-11. Index of Parts List Illustrations .....	3-4

**SECTION 1. TROUBLESHOOTING**

1-1. INTRODUCTION

This section provides troubleshooting information in the form of an easy to read table.

If a problem occurs during the first operation of a new fryer, recheck the installation per Section 2 of the Operator’s Manual.

Before troubleshooting, always recheck the operating procedure per Section 3 of the Operator’s Manual.

**1-2. SAFETY**

The Henny Penny Pressure Fryer has many safety features incorporated. However, the only way to ensure a safe operation is to fully understand e proper installation, operation, and maintenance procedures. The instructions in this manual have been prepared to aid you in learning the proper procedures. Where information is of particuloar importance or safety related, the words DANGER, WARNING, CAUTION, and NOTICE are used. Their usage is described below.



**SAFETY ALERT SYMBOL** is used with DANGER, WARNING, or CAUTION which indicates a personal injury type hazard.



**NOTICE** is used to highlight especially important information.



*CAUTION used without the safety alert symbol indicates a potentially hazardous situation which, if not avoided, may result in property damage.*



*CAUTION indicates a potentially hazardous situation which, if not avoided, may result in minor or moderate injury.*



**WARNING** indicates a potentially hazardous situation which, if not avoided, could result in death or serious injury.



**DANGER INDICATES AN IMMINENTLY HAZARDOUS SITUATION WHICH, IF NOT AVOIDED, WILL RESULT IN DEATH OR SERIOUS INJURY.**

### 1-3. TROUBLESHOOTING

To isolate a malfunction, proceed as follows:

1. Clearly define the problem (or symptom) and when it occurs.
2. Locate the problem in the troubleshooting table.
3. Review all possible causes. Then, one-at-a-time work through the list of corrections until the problem is solved.



**Refer to the maintenance procedures in Section 2 of this manual to safely and properly make the checkout and repair needed. If maintenance procedures are not followed correctly, injuries and/or property damage could result.**



Problem	Cause	Correction
<b>COOKING SECTION (Continued)</b>		
C. Too Light (all batches)	<ul style="list-style-type: none"> <li>• Temperature probe out of calibration</li>   <li>• Slow fryer heat-up/recovery</li>   <li>• Oil usage wasn't set for new peanut oil</li> </ul>	<ul style="list-style-type: none"> <li>• See Diagnostic Mode <b>D 1</b> to adjust color of product</li>   <li>• Check temperature probe calibration; see Checking Temperature Probe Calibration Section; if less than 15 degrees off, have probe calibrated; if more than 15 degrees off, replace probe</li>   <li>• See Diagnostic Mode <b>D 4</b> for present day's performance; or see Information Modes 5, 6, 7, 8, and 9 for more information on this problem</li>   <li>• Low voltage; see Diagnostic Mode <b>D 3</b> for present day's voltage performance; see Information Modes 4, 5, 6, 7, 8, 9, and 15 for more information on this problem</li>   <li>• Low gas pressure; have gas pressure checked going to burners, on gas fryers</li>   <li>• See Diagnostic Mode <b>D 2</b> for the age of the oil; see section 3-7 for setting the age of the oil</li> </ul>
D. Too Light (some batches)	<ul style="list-style-type: none"> <li>• Temperature programmed too low</li>   <li>• Product placed in peanut oil before proper temperature</li>   <li>• Wrong product button pushed</li> </ul>	<ul style="list-style-type: none"> <li>• See Diagnostic Mode <b>D 10</b>; if temperature settings have been changed, without authorization, have the controls reinitialized</li>   <li>• If fryer hasn't been used since the problem batch, see Information Mode <b>4 C</b>; for more information on this see Information Modes <b>5 S, 6 S, 7 P, or 8 P</b></li>   <li>• If fryer hasn't been used since problem batch, see Information Mode <b>4 B</b> to see what product was selected</li> </ul>



Problem	Cause	Correction
<b>COOKING SECTION (Continued)</b>		
D. Too Light (some batches) (Continued)	<ul style="list-style-type: none"> <li>• Cook Cycle aborted before alarm and “DONE” flashes</li> </ul>	<ul style="list-style-type: none"> <li>• See Diagnostic Mode <b>D 7</b> to see how many times the Cook Cycle was stopped before the end of the cycle</li> </ul>
	<ul style="list-style-type: none"> <li>• Frozen product placed in peanut oil</li> </ul>	<ul style="list-style-type: none"> <li>• Use fresh or thawed product; see Diagnostic Mode <b>D 5</b> to see if the controls sensed any frozen or overloaded batches</li> </ul>
Dryness of Product	<ul style="list-style-type: none"> <li>• Moisture loss prior to cooking</li> </ul>	<ul style="list-style-type: none"> <li>• Use fresh product</li> <li>• Cover product with plastic wrap, reducing evaporation</li> </ul>
	<ul style="list-style-type: none"> <li>• Over-cooking the product</li> </ul>	<ul style="list-style-type: none"> <li>• Done alarm ignored for more than 20 seconds; if the fryer hasn’t been used since the problem batch, see Information Mode <b>4 H</b>; for more information on this problem, see Information Modes <b>5 U, 6 U, 7R, or 8 R</b></li> </ul>
	<ul style="list-style-type: none"> <li>• Time of Cook Cycle set too long</li> </ul>	<ul style="list-style-type: none"> <li>• See Diagnostic Mode <b>D 10</b>; if time settings have been changed, have the controls reinitialized</li> </ul>
	<ul style="list-style-type: none"> <li>• Wrong product button pushed</li> </ul>	<ul style="list-style-type: none"> <li>• If fryer hasn’t been used since problem batch, see Information Mode <b>4 B</b> to see what product was selected</li> </ul>
	<ul style="list-style-type: none"> <li>• Low operating pressure</li> </ul>	<ul style="list-style-type: none"> <li>• Check pressure gauge reading Check for pressure leaks</li> </ul>
Burned Taste	<ul style="list-style-type: none"> <li>• Burned peanut oil flavor</li> </ul>	<ul style="list-style-type: none"> <li>• Replace peanut oil</li> </ul>
	<ul style="list-style-type: none"> <li>• Peanut oil needs filtering</li> </ul>	<ul style="list-style-type: none"> <li>• Filter peanut oil more often</li> </ul>
	<ul style="list-style-type: none"> <li>• Frypot not properly cleaned</li> </ul>	<ul style="list-style-type: none"> <li>• Drain and clean frypot</li> </ul>

Problem	Cause	Correction
<b>COOKING SECTION (Continued)</b>		
<p>Product not done</p>	<ul style="list-style-type: none"> <li>• Cook Cycle aborted before alarm, and “DONE” flashes</li>   <li>• Frozen product placed in peanut oil</li>   <li>• Wrong product button pushed</li>   <li>• Temperature programmed too low or not programmed properly</li>   <li>• Temperature probe out of calibration</li>   <li>• Slow fryer heat-up/recovery</li>               <li>• Product too thick</li> </ul>	<ul style="list-style-type: none"> <li>• See Diagnostic Mode <b>D 7</b> to see how many times the Cook Cycle was stopped before the end of the cycle</li>   <li>• Use fresh or thawed product; see Diagnostic Mode <b>D 5</b> to see if the controls sensed frozen or overloaded batches.</li>   <li>• If fryer hasn’t been used since problem batch, see Information Mode <b>4 B</b> to see what product was selected</li>   <li>• See Diagnostic Mode <b>D 10</b>; if temperature settings have been changed, have the controls reinitialized</li>   <li>• Check temperature probe calibration; see Checking Temperature Probe Calibration Section; <ul style="list-style-type: none"> <li>a. If less than 5° off, see Diagnostic Mode <b>D 1</b></li> <li>b. If between 5 and 15 degrees off, calibrate probe; if more than 15° off, replace probe</li> </ul> </li>   <li>• See Diagnostic Mode <b>D 4</b> for present day’s performance; or see Information Modes 5, 6, 7, 8, and 9 for more information on this problem</li>   <li>• Low voltage; see Diagnostic Mode <b>D 3</b> for present day’s voltage performance; see Information Modes 4, 5, 6, 7, 8, 9, and 15 for more information on this problem</li>   <li>• Low gas pressure; have gas pressure checked going to burners, on gas fryers</li>   <li>• Make sure chicken filets have been fileted</li> </ul>

Problem	Cause	Correction
<b>POWER SECTION</b>		
<p>With COOK/PUMP Switch in COOK position, fryer is completely without power</p>	<ul style="list-style-type: none"> <li>• Open circuit</li> </ul>	<ul style="list-style-type: none"> <li>• Check to see if fryer is plugged in</li> <li>• Check wall circuit breaker or fuse</li> <li>• Have a qualified service technician check power supply and COOK/PUMP switch</li> </ul>
<b>PRESSURE SECTION</b>		
<p>Pressure will not exhaust at end of cooking cycle.</p> <p>Operating pressure too high</p>	<ul style="list-style-type: none"> <li>• Exhaust line from solenoid valve to exhaust tank clogged</li> <li>• Solenoid valve clogged</li> <li>• Deadweight clogged</li> <li>• Exhaust line to stack clogged</li> </ul>	<ul style="list-style-type: none"> <li>• Turn unit off and allow fryer to cool to release pressure from frypot; have all pressure lines, exhaust stacks, and exhaust tank cleaned</li> <li>• Have solenoid checked and cleaned</li> <li>• Turn unit off and allow fryer to cool to release pressure from frypot; remove deadweight and clean, per Cleaning the Deadweight Valve Section.</li> <li>• Clean exhaust line to stack</li> </ul>



**DO NOT OPERATE UNIT IF PRESSURE GAUGE SHOWS HIGH PRESSURE CONDITIONS. SEVERE INJURIES AND BURNS WILL RESULT. IMMEDIATELY PLACE THE POWER/PUMP SWITCH IN THE OFF POSITION, WHICH RELEASES THE PRESSURE BY ALLOWING THE UNIT TO COOL. DO NOT RESUME USE OF UNIT UNTIL CAUSE OF HIGH PRESSURE HAS BEEN FOUND AND CORRECTED.**

Problem	Cause	Correction
<b>PRESSURE SECTION (Continued)</b>		
Pressure does not build	<ul style="list-style-type: none"> <li>• Not enough product in fryer or product not fresh</li> <li>• Metal shipping spacer not removed from deadweight</li> <li>• Lid open or not latched</li> <li>• Solenoid valve leaking or not closing</li> <li>• Deadweight assembly leaking</li> <li>• Pressure not programmed</li> <li>• Lid gasket leaking</li> <li>• Safety relief valve leaking.</li> </ul>	<ul style="list-style-type: none"> <li>• Place proper quantity of fresh product within frypot to generate steam</li> <li>• Remove shipping spacer; see Unpacking Section</li> <li>• Close and latch lid</li> <li>• Have solenoid valve checked or cleaned</li> <li>• Have deadweight assembly repaired</li> <li>• See Diagnostic Mode <b>D 10</b>; if pressure settings have been changed, have the controls reinitialized</li> <li>• Reverse gasket or lid needs adjusted</li> <li>• Check and replace if necessary</li> </ul>
<b>FILTER SYSTEM SECTION</b>		
Filter motor runs but pumps peanut oil slowly	<ul style="list-style-type: none"> <li>• Pump clogged</li> <li>• Filter line connection loose</li> <li>• Solidified peanut oil</li> </ul>	<ul style="list-style-type: none"> <li>• Have pump cleaned</li> <li>• Tighten all filter line connections</li> <li>• Clear all filter lines of solidified peanut oil</li> </ul>
Filter switch on, motor does not run	<ul style="list-style-type: none"> <li>• Defective COOK/PUMP switch</li> <li>• Defective motor</li> <li>• Motor thermal protector tripped</li> </ul>	<ul style="list-style-type: none"> <li>• Have switch checked</li> <li>• Have motor checked</li> <li>• Reset thermal protector per Filter Pump Motor Thermal Protector Section</li> </ul>

Problem	Cause	Correction
<b>FILTER SYSTEM SECTION (Continued)</b>		
Motor hums but will not pump	<ul style="list-style-type: none"> <li>• Clogged lines or pump</li> </ul>	<ul style="list-style-type: none"> <li>• Have pump and lines removed and cleaned</li> <li>• Have pump seal, rotor and rollers replaced</li> </ul>
<b>HEATING OF PEANUT OIL SECTION</b>		
Peanut oil will not heat	<ul style="list-style-type: none"> <li>• Blown fuse or tripped circuit breaker</li> <li>• Faulty cord and plug</li> <li>• Faulty PC board</li> <li>• Faulty or tripped high limit “E10”</li> <li>• Drain valve open “E15”</li> <li>• Possible faulty probe “E6”</li> <li>• Possible faulty contactor (electric models)</li> <li>• Gas valve knob turned to the OFF position (gas models)</li> <li>• Faulty thermocouple on gas control valve (gas models)</li> <li>• Faulty COOK/PUMP switch</li> <li>• Faulty drain switch “E15”</li> <li>• Possible faulty gas control</li> <li>• Pilot not lit (gas models)</li> </ul>	<ul style="list-style-type: none"> <li>• Reset breaker or replace fuse</li> <li>• Check cord and plug</li> <li>• Have control panel checked</li> <li>• Reset high limit per Operating Components Section; if high limit doesn’t reset, have it checked</li> <li>• Close drain valve</li> <li>• Have temperature probe checked</li> <li>• See Diagnostic Modes <b>D 4</b>; see if “<b>CHECK COILS, CONTACTORS AND WIRING</b>” shows on display</li> <li>• Make sure the gas valve knob is turned to ON</li> <li>• Have thermocouple checked</li> <li>• See Information Mode10 and check to see if the input code is present; if not, have fryer checked by a certified service technician</li> <li>• Light pilot per Gas Pilot Lighting Procedure section in Operator’s Manual</li> </ul>

Problem	Cause	Correction
<b>HEATING OF PEANUT OIL SECTION (Continued)</b>		
Peanut oil heating slowly	<ul style="list-style-type: none"> <li>• Low or improper amps</li>   <li>• Low or improper voltage</li> </ul>	<ul style="list-style-type: none"> <li>• See Information Mode <b>16</b> for present amperage; or see Information Modes 4, 5, 6, 7, 8, 9, for more information on this problem; Diagnostic Mode <b>D 4</b> gives present day's heating performance</li>   <li>• See Diagnostic Modes <b>D 3 &amp; D 4</b> for present day's voltage and heating performance; or see Information Modes 4, 5, 6, 7, 8, 9, and 15 for more information on this problem</li> </ul>
	<ul style="list-style-type: none"> <li>• Weak or burnt out elements (elec. model)</li> <li>• Burnt or charred connectors</li> <li>• Faulty contactor (electric models)</li> </ul>	<ul style="list-style-type: none"> <li>• See Diagnostic Modes <b>D 4</b>; see if "<b>CHECK COILS, CONTACTORS AND WIRING</b>" shows on display; if so, have fryer checked by a certified service technician</li> </ul>
	<ul style="list-style-type: none"> <li>• Wire(s) loose</li> <li>• Supply line too small - low gas volume (gas models)</li>   <li>• Improper ventilation system (gas models)</li> </ul>	<ul style="list-style-type: none"> <li>• Have wires tightened</li>   <li>• Increase supply line size; refer to installation instructions</li>   <li>• Refer to installation instructions</li> </ul>


1-3. TROUBLESHOOTING (Continued)

<b>PROBLEM</b>	<b>CAUSE</b>	<b>CORRECTION</b>
<b>PEANUT OIL DRAINING</b>		
Peanut oil will not drain from frypot (all models)	<ul style="list-style-type: none"> <li>• Drain valve clogged with crumbs</li> <li>• Drain valve will not open by turning handle</li> </ul>	<ul style="list-style-type: none"> <li>• Open valve - force cleaning brush through drain opening</li> <li>• Replace cotter pins in valve coupling</li> </ul>

**LID SECTION**

Gasket coming out of lid liner	<ul style="list-style-type: none"> <li>• Crumbs under gasket</li> </ul>	<ul style="list-style-type: none"> <li>• Remove gasket and clean per Pressure Regulation/Exhaust section</li> <li>• Clean top rim of frypot</li> <li>• Replace worn or damaged gasket per Pressure Regulation/Exhaust section</li> </ul>
Lid spindle will not turn or turns hard with lid open	<ul style="list-style-type: none"> <li>• Spindle dry</li> <li>• Worn acme nut</li> </ul>	<ul style="list-style-type: none"> <li>• Lubricate spindle per Pressure Regulation/Exhaust section</li> <li>• Replace acme nut per Pressure Regulation/Exhaust section</li> </ul>


1-3. TROUBLESHOOTING (Continued)

PROBLEM	CAUSE	CORRECTION
<b>LID SECTION (Continued)</b>		
<p>Lid will not unlatch from closed position</p>	<ul style="list-style-type: none"> <li>• Lid gasket not seated properly or idle nut not adjusted</li> </ul>	<ul style="list-style-type: none"> <li>• To check the problem, perform the following procedures:               <ol style="list-style-type: none"> <li>1. Remove pressure from frypot.</li> <li>2. Turn main switch to off position.</li> <li>3. Drain shortening from frypot.</li> </ol> <div data-bbox="1008 569 1430 709" style="border: 2px solid black; padding: 5px; margin: 10px 0;">  <span style="font-size: 24pt; font-weight: bold; margin-left: 10px;">WARNING</span> </div> <p><i>The next procedure must be performed while holding the lid closed until the lid latch is free from the crossarm. Failure to hold down the lid will result in the lid springing back to a full open position. Personal injury, or damage to the hinge may result.</i></p> <ol style="list-style-type: none"> <li>4. Remove Tru-Arc ring. Drive latch pin out. Lid will open.</li> <li>5. Raise lid slowly.</li> <li>6. Reinstall latch.</li> <li>7. Adjust limit stop, per Pressure Regulation/Exhaust section.</li> <li>8. Lid gasket should be properly seated in lid liner.</li> </ol> </li> </ul>





**1-4. WARNINGS AND ERROR MESSAGES**

The controls monitor procedure problems and system failures with warnings and error codes. The display shows the warning or error code, and an alarm sounds.

Pressing  cancels most warnings and pressing any control button stops most Error Code alarms. But there are some exceptions (see below). The display shows the error until the situation is corrected.

**WARNINGS**

<b>DISPLAY</b>	<b>CAUSE</b>	<b>CORRECTION</b>
“W-1” “LOW VOLTAGE”	Incoming supply voltage too low	Have voltage at plug and receptacle checked
“W-2” “SLOW HEAT-UP”	Faulty components or connections	Have elements, connections, and contactors checked
“W-3” “WAS NOT READY”	Product loaded into frypot before <b>READY</b> lights 	Wait until peanut oil is at proper temperature before loading product
“W-4” “SLOW COOKING”	Frozen or too much product in frypot	Do not overfill or place frozen product into the frypot
“W-5” “SLOW COOKING”	Product loaded into frypot before <b>READY</b> lights 	Wait until peanut oil is at proper temperature before loading product.
“W-6” “SLOW COOKING”	Faulty components or connections	Have elements, connections, and contactors checked
“W-7” “LOW AMPS”	Faulty components or connections	Have elements, connections, and contactors checked
“W-9” “DISCARD PRODUCT”	Product overcooked (may appear after a “W-6”, “SLOW COOKING” warning)	Discard product immediately
“OIL TOO HOT”	Didn’t allow peanut oil to drop down to current product’s setpoint temperature	CANCEL button will not stop this warning; once the peanut oil temperature drops to setpoint temperature, the alarm automatically stops
“E-4” “CPU TOO HOT”	PC board too hot	Check ventilation louvers on side of fryer for obstructions; if louvers are clear, have PC board checked; check cooling fan if present.





**1-4. WARNINGS AND  
ERROR MESSAGES (Continued)**

**ERROR CODES**

<b>DISPLAY</b>	<b>CAUSE</b>	<b>CORRECTION</b>
“E-5” “FRYER TOO HOT”	Controls sensing 405°F or above	Have heat components and temperature probe checked
“E-6” (A or B) “FRYER TEMP SENSOR FAILED”	Faulty temperature probe or connection	Have temperature probe and connection checked
“E-10” “HIGH LIMIT TRIPPED”	Peanut oil temperature too hot, drain valve opened while heat was on, or faulty high limit	Reset high limit per Operating Components; Section; check peanut oil temperature for overheating; have heat components checked if high limit continues to trip
“E-15” “DRAIN IS OPEN”	Drain is open or faulty microswitch	Close drain; have drain microswitch checked if error code persists
“E-25” “HEAT AMPS WERE TOO HIGH” (500 fryer only)	Wrong or faulty elements or wiring problem.	Have electrical supply, wiring, and elements checked <b>NOTICE</b> Because of the seriousness of this error code, turn the COOK/PUMP switch OFF and back to COOK to cancel.
“E-26” “HEAT AMPS ARE LOCKED ON” (500 fryer only)	Faulty contactors or PC board	Have the contactors and PC board checked <b>NOTICE</b> This error code could be displayed even with the COOK/PUMP switch turned OFF. Unplug fryer or shut off the wall circuit breaker to disconnect electrical power to fryer.
“E-41” “SYSTEM DATA LOST”	Memory scrambled; an individual product program may be scrambled; ex: “E-41 -2- DATA LOST”; this means product #2 program is scrambled	Turn the COOK/PUMP switch OFF and back to COOK; if error code persists, have the PC board checked or re-initialized
“E-41” “SYSTEM DATA LOST”	Memory scrambled; an individual product program may be scrambled; ex: “E-41 -2- DATA LOST”; this means product #2 program is scrambled	Turn the COOK/PUMP switch OFF and back to COOK; if error code persists, have the PC board checked or re-initialized

**1-4. WARNINGS AND  
ERROR MESSAGES (Continued)**

**ERROR CODES**

<b>DISPLAY</b>	<b>CAUSE</b>	<b>CORRECTION</b>
“E-41” “SYSTEM DATA LOST”	Memory scrambled; an individual product program may be scrambled; ex: “E-41 -2- DATA LOST”; this means product #2 program is scrambled	Turn the COOK/PUMP switch OFF and back to COOK; if error code persists, have the PC board checked or re-initialized
“E-46” “DATA SAVE FAILED”	Faulty eprom or PC board	Turn the COOK/PUMP switch OFF and back to COOK; if error code persists, have the PC board checked or re-initialized
“E-47” “ANALOG SYSTEM OR 12 VOLT FAILED”	Failure of 12 volt DC supply on the I/O board  Amp sensors plugged in backwards  Faulty PC board	Turn the COOK/PUMP switch OFF and back to COOK; if the  and  DO NOT light up when the 8888’s are displayed, have the I/O board replaced  Have positions of amp sensors checked  Have control panel replaced
“E-48” INPUT SYSTEM ERROR”	Failure of 12 volt DC supply on the I/O board  Faulty PC board	Turn the COOK/PUMP switch OFF and back to COOK; if the  and  DO NOT light up when the 8888’s are displayed, have the I/O board replaced  Have control panel replaced
“E-70 A” “FAN VAC JUMPER MISSING”	Missing or broken wire in pins 1 and 2 of P11 connector, or faulty connector  Faulty I/O board	Have jumper wire between pins 1 and 2 checked  Have I/O board checked and replaced if necessary
“E-70 B” “PWR SW OR WIRES FAILED”	Faulty COOK/PUMP switch or switch wiring; faulty I/O board	Have COOKPUMP switch checked, along with its wiring; have I/O board checked
“E-92” “24 VOLT FUSE”	Blown 24 volt controller fuse, or bad 14-pin cable connection  Stuck or clogged solenoid valve	Have the 14-pin cable connector checked or have the fryer checked for a short to ground in components such as the drain switch, solenoid, or high limit and wiring  Have solenoid checked and cleaned



**1-5. DIAGNOSTIC MODE**  
**DETAILS**

The Chick-fil-A fryer controllers provide diagnostic functions that let an Operator review operating and performance data for the fryer.

The information provided by Diagnostic Mode can be used to monitor procedural errors, such as, not waiting for the READY light before starting a Cook Cycle, canceling cycles early, etc.





In addition, Diagnostic Mode allows slight adjustment to product color, reports the age and accumulated wear of the oil, and reports information about the performance of the line voltage supply.

**Accessing Diagnostic Mode**

To activate Diagnostic Mode, press  button, then press  button. The controller displays the following message:

“ \*DIAGNOSTIC\* “  
“ \*REPORT\* “

When this introduction message is finished, the controller displays Diagnostic step D 1 (see below).

  are used to step through the report items. Press  to step forward to the next item. Press  to step backward through the report items.

The report information is grouped into sections, D 1 through D 10. Most sections have several related items.




To toggle between English and Spanish Display Mode, press  button then press .

To exit Diagnostic Report Mode at any point, press .

**1-5. DIAGNOSTIC MODE**  
**DETAILS (Continued)**



**D 1: Color Adjustment**

This step lets the user make slight adjustments to the product color. The first step of this item asks “IS PRODUCT COLOR OK?”


If product color is okay and no change is desired press  or  to move on to the next item, or press  to exit Diagnostic Mode.

If a change *is* desired, press  (i.e. color is *not* okay). The controller shows “ADJUST DARKNESS”, then displays the darkness control slider:


“ LT - - - - + - - - - DK”

A blinking asterisk (\*) indicates the current position.  and  are used to adjust the darkness setting.

To make the product darker, press  to move the blinking “\* “ toward the DK (darker) side.

To make the product lighter, press  to move the blinking “\* “ toward the LT (lighter) side.

When done adjusting, press  to exit and return to normal operating mode.

Any temperature adjustment activated by the color adjustment feature will be reflected in the normal setpoint display as part of the offset from the basic product cook temperature. To view the present regulating temperature, press  twice.

In the example, “SETPT = 315°F + 6” the product cook temperature is 315°F and has an additional offset of 6°F to compensate for the age of the oil, how long the fryer sits idle, and any color adjustments.

**1-5. DIAGNOSTIC MODE**  
**DETAILS (Continued)**

**D 2: Oil Wear Report**



This section displays information about the age of the present batch of peanut oil.

The first step shows how many days of use this oil has:

“D2: THIS OIL IS “  
“D2: 4 DAYS OLD “


**NOTICE**

The controller only counts days in which the fryer is in use.

Press  to move on to the second step. This step shows the age of the  peanut oil by percentage of its expected lifetime. The peanut oil's present, accumulated wear is compared to the wear setting at which the controller will prompt for the oil to be changed.

“D2: THIS OIL IS “  
“D2: 16% USED “

This information can be used as the oil nears the end of its life (i.e. 95%), to plan ahead for when a clean-out will be required.

Press  to move on to the next section.

**1-5. DIAGNOSTIC MODE**  
**DETAILS (Continued)**

**D 3: Line Voltage Performance Report**

This section displays information about how good the line voltage supply has been for the present day and for the present batch of oil.

The controller continually monitors the line voltage supplied to the fryer (when the fryer is on). If the line voltage drops below [90%] of its nominal value, the controller signals a “LOW VOLTAGE” alarm. This alarm sounds at the end of each Cook Cycle for which low voltage has been detected. While not cooking, the low voltage alarm can sound as frequently as every 30 minutes.

**NOTICE**

“[ ]” around a value, such as [90%], means this value is programmable and might change with later software versions.

**Voltage Report for Today**

If no low voltage warnings have been detected for the present day, the controller shows, “D3: VOLTAGE OK, D3: TODAY “

If one or more low voltage warnings have been detected for the present day, the following sequence example could be displayed:

“D3: YOU HAD 3”  
“D3: LOW VOLTAGE”  
“D3: WARNINGS”  
“D3: TODAY”

(Press  )

“D3: MIN VOLTAGE”  
“D3: TODAY = 83%”

(Press  )

“D3: MAX VOLTAGE”  
“D3: TODAY = 101%”

(Press  )


**1-5. DIAGNOSTIC MODE**  
**DETAILS (Continued)**

“D3: ARE OTHER”  
“D3: FRYERS”  
“D3: HAVING THIS”  
“D3: PROBLEM”  
“D3: TODAY?”


Press  or  .

If  is pressed (other fryers are having this problem):

“D3: FACILITY”  
“D3: OR UTILITY”  
“D3: PROBLEM”

If  is pressed (other fryers are not having this problem):

“D3: CHECK CORD,”  
“D3: WIRING,”  
“D3: AND BREAKER”

In either case, press  to move on to the next step.

**Voltage Report for Present Batch of Peanut Oil**

This report for the present batch of oil does not include data from the today. It includes data for all days on the present batch of oil before today.

For example, if low voltage warnings started appearing today but had not been displayed before, the previous item might report “3 LOW VOLTAGE WARNINGS TODAY” while this step reports “VOLTAGE OK SINCE LAST OIL CHANGE”.

If no low voltage warnings have been detected before today for the present batch of oil, the controller shows:

“D3: VOLTAGE OK”  
“D3: SINCE LAST”  
“D3: OIL CHANGE”



**1-5. DIAGNOSTIC MODE**  
**DETAILS (Continued)**

If one or more low voltage warnings have been detected before today, the following sequence is displayed:

“D3: BEFORE TODAY”

“D3: 27 LOW VOLT”

“D3: WARNINGS”

“D3: ON THIS OIL”

(Press )

“D3: MIN VOLTAGE”

“D3: BEFORE TODAY”


“D3: = 85%”

(Press )

“D3: MAX VOLTAGE”

“D3: BEFORE TODAY”

“D3: = 105%”

Press  to advance to the next section.

**D 4: Heating Capacity Report**

This section reports the present status of the heating system.

The controller examines a history of heat-up data and determines whether or not the heating system is operating normally. The heat capacity is said to be bad only if the most recent heat-up failed to meet the expected heat-up rate and three of the last four heat-ups also failed to achieve the expected rate. That is, a single slow heat-up will not trigger a slow heat warning. The slow heat warning is activated only after repeated low-rate heat-ups is observed.

The controller can't assess the integrity of the heating system if the fryer has been experiencing voltage problems. Low heat rates observed in this situation might be due to voltage problems rather than heater problems.

**1-5. DIAGNOSTIC MODE**  
**DETAILS (Continued)**

If the fryer has witnessed two or more low voltage warnings today, the following report is displayed:

“D4: CAN’T TEST”  
“D4: HEAT CAPACITY”  
“D4: DUE TO”  
“D4: VOLTAGE”  
“D4: PROBLEMS”

Otherwise, if the assessed heat capacity rating is presently “good” and there has been at most one heat-up today that failed to achieve the expected rate, the following report is displayed:

“D4: HEATING”  
“D4: CAPACITY”  
“D4: IS FINE”

Otherwise, if the heat capacity is presently assessed as “bad”, or presently assessed as “good” but two or more heat-ups today have not reached the expected heat-up rate, the following report sequence is generated:

“D4: YOU HAD 75%”  
“D4: SLOW HEATS”  
“D4: TODAY”

(Press  )

“D4: HAVE 20%”  
“D4: SLOW HEATS”  
“D4: THIS OIL”

(Press  )

“D4: HAD 0%”  
“D4: SLOW HEATS”  
“D4: LAST OIL”

(Press  )


If the heat capacity is assessed as bad (low heat-up rate on last heat-up, and on three of the last four heat-ups), then the heating coils are suspect and the following message is displayed:

“D4: CHECK COILS,”  
“D4: CONTACTORS,”  
“D4: AND WIRING”

**1-5. DIAGNOSTIC MODE**  
**DETAILS (Continued)**

Otherwise, the heating coils are presumed to be good and the following messages appear:

“D4: HEATER COILS “  
“D4: APPEAR OK “

(Press  )

“D4: CHECK “  
“D4: CONTACTORS, “  
“D4: CONNECTIONS, “  
“D4: AND WIRING “

**D 5: Cook Times (Slow Cooks) Report**

This section summarizes the slow cooking status for each product.

Actual cook times for Cook Cycles can vary from the programmed cook time setting, due to the load compensation feature. Load Compensation slows the cook timer down when the actual peanut oil temperature is below a reference value, and speeds up the cook timer countdown when peanut oil temperature is above the reference.

When the peanut oil temperature is lower than expected during a Cook Cycle, the overall cook time will be longer than normal. If the actual cook time stretches beyond a programmed limit, the controller counts a “SLOW COOK” event and sounds an alarm at the end of the Cook Cycle.

If low voltage or low amps are detected during the Cook Cycle, the warning message indicates “LOW VOLTAGE” or “LOW AMPS”, but the cycle will still count as a “slow cook”. If the voltage and amps have been fine during the Cook Cycle but the cycle was started before the Ready light came on, then the warning message indicates “SLOW COOK — WAIT FOR READY LIGHT”. Otherwise, the slow cooking problem will be attributed to a “bad batch” of product: cooking too much in one load, or cooking product that is too cold (i.e. frozen product on a pressure fryer when the product should be fresh).

If none of the products has more than 5% slow Cook Cycles today, the following report is made:

“D5: COOK TIMES”  
“D5: LOOK OK”  
“D5: TODAY”

**1-5. DIAGNOSTIC MODE**  
**DETAILS (Continued)**

Otherwise, if one or more cook products have generated a slow cook warning more than 5% of the time, but four or more low voltage or slow heat-up warnings (any combination) have been generated today, then the report is as follows:


“D5: SOME SLOW”  
 “D5: COOKS TODAY”  
 “D5: MAYBE DUE TO”  
 “D5: VOLTAGE OR”  
 “D5: COIL PROBLEMS”

Such a report is saying the slow cooking may be the result of low voltage (which significantly reduces heat capacity) or the result of other problems with the heating system. In this case, the slow cook problems might not have anything to do with user error.

Otherwise, the slow cooking is generally attributed to user error: cooking too much product in one load, cooking frozen product (in the pressure fryer) when it should be fresh, or cooking before the Ready light illuminates, etc.

An individual “XXXXX IS COOKING SLOWLY TODAY” report item is generated for each product that has had more than 5% slow cook warnings today. This report item is triggered based solely on the number of slow cooks for that product, whether those slow cooks are due to voltage or heating problems, or due to cooking before ready, cooking too much, or cooking frozen product.

“D5: “FILET” ( ← Product Name )  
 “D5: COOKING SLOW”  
 “D5: TODAY”

(Press  )

If any of the slow cooks for this product are suspected as being due user error, a second, “bad batch” report is generated for the product.

←  
 “D5: “NUG-STRP” ( ← Product Name )  
 “D5: COOKING SLOW”  
 “D5: TODAY”

(Press  )

**1-5. DIAGNOSTIC MODE**  
**DETAILS (Continued)**

“D5: POSSIBLE”  
“D5: OVERSIZED”  
“D5: OR FROZEN”  
“D5: BATCH OF”  
“D5: “NUG-STRP” “ ← ( Product Name )  
“D5: DETECTED”  
“D5: 3 TIMES”  
“D5: TODAY”

(Press  )

“D5: POSSIBLE”  
“D5: OVERSIZED”  
“D5: BATCH OF”  
“D5: “FRIES”  
“D5: DETECTED”  
“D5: 5 TIMES”  
“D5: TODAY”

**D 6: “Cooked Before Ready” Report**

This section shows how many Cook Cycles were started before the READY light was on. This is strictly a user error.

If the fryer was in the ready range when the user begins to load product, but is out of the ready range by the time the Cook Cycle is started, the control will not give you an alarm.

If the fryer wasn't ready before loading, an alarm sounds and “WAS NOT READY” warning is generated. The number of times this has happened today is indicated by the following report item:

“D6: COOKED”  
“D6: BEFORE READY”  
“D6: 11 TIMES”  
“D6: TODAY”

(Press  )

**1-5. DIAGNOSTIC MODE**  
**DETAILS (Continued)**

The number of “WAS NOT READY” warnings for this batch of peanut oil is also reported. Note that this value does not yet include the not ready warnings generated today.

“D6: BEFORE TODAY,”

“D6: COOKED”

“D6: BEFORE READY”

“D6: 8 TIMES”

“D6: ON THIS OIL”

(Press  )

Finally, the controller identifies how many times the not ready warning was generated for the previous batch of peanut oil:

“D6: LAST OIL,”

“D6: COOKED”

“D6: BEFORE READY”

“D6: 24 TIMES”

**D 7: “Stopped Too Soon” Report**

This section shows how many Cook Cycles were stopped early by the user, before the cook timer had counted down to 0:00 and the “\*DONE\*” indication was given. This is strictly a user error.

Cycles that are canceled after cooking for less than 30 seconds are not counted here. For example, if a cycle is accidentally started, and the Cook Cycle is canceled after just a few seconds, this cycle will not be counted as a Stopped Too Soon Cycle.

Also, some allowance is given for stopping a cycle a *little* early. The user can cancel the cycle up to 10 seconds early without penalty.

Otherwise, however, any cycle that was stopped with more than 10 seconds remaining (0:10) on the cook clock will be counted as a Stopped Too Soon Cycle.

The first item displays what percent of cycles today were stopped with more than 0:10 remaining. All products are grouped into one count.

“D7: 8% OF LOADS”

“D7: WERE STOPPED”

“D7: TOO SOON”

“D7: TODAY”

(Press  )

**1-5. DIAGNOSTIC MODE**  
**DETAILS (Continued)**

The number of Stopped Too Soon cycles for this batch of peanut oil is reported next. Note that this value does not yet include the Cook Cycles from today.

“D7: BEFORE TODAY “  
“D7: 3% OF LOADS”  
“D7: WERE STOPPED”  
“D7: TOO SOON”  
“D7: ON THIS OIL”


(Press  )


Finally, the controller identifies percentage of Stopped Too Soon Cycles for the previous batch of peanut oil:

“D7: LAST OIL”  
“D7: 5% OF LOADS”  
“D7: WERE STOPPED”  
“D7: TOO SOON”

**D 8: “Beeped \*DONE\* Too Long” Report**

Diagnostic Report section 8 reveals how many Cook Cycles beeped “\*DONE\*” for more than 20 seconds before the user pressed the timer button to stop the cycle. This is strictly a user error.

The controller cannot detect when the product is actually removed from the fryer. It only identifies how long the controller beeped “\*DONE\*” before the user pressed  to stop the alarm.

The first item displays the percent of today’s Cook Cycles that beeped “\*DONE\*” for more than 20 seconds before the user pressed  to stop it. All products are grouped into one count.

“D8: 10% OF LOADS”  
“D8: BEEPED ‘DONE’”  
“D8: TOO LONG”  
“D8: TODAY”

(Press  )

**1-5. DIAGNOSTIC MODE**  
**DETAILS (Continued)**

The number of Beeped Done Too Long Cycles for this batch of peanut oil is reported next. Note that this value does not yet include the Cook Cycles from today.

“D8: BEFORE TODAY “

“D8: 7% OF LOADS”

“D8: BEEPED ‘DONE’”

“D8: TOO LONG”

“D8: ON THIS OIL”

(Press the DOWN button...)

Finally, the controller identifies percentage of Beeped Done Too Long Cycles for the previous batch of peanut oil:

“D8: LAST OIL”

“D8: 6% OF LOADS”

“D8: BEEPED ‘DONE’”

“D8: TOO LONG”

**D 9: Irregular Loading Report**

For most Cook Cycles, the controller determines when the product was placed into the peanut oil. This report identifies the percentage of cycles for which this determination was not successful.

This drop detection detects most loads, but can fail for several reasons. Anytime the detection routine fails to find the true drop point, the controller logs an irregular loading count.

Examples of failed drop detection might be: the Operator takes too long to load the product to the time he presses the start button, or the Operator cooks a very light product load, one or two filets, for example.

In these instances, no drop point will be found and that Cook Cycle counts as an Irregular Loading Cycle. Only products that have more than 5% of loads with missed detection's are reported.



**1-5. DIAGNOSTIC MODE**  
**DETAILS (Continued)**

Loading Report for Today

If no products have a failed to detect rate of more than 5%, the controller shows:

“D9: LOADING”  
“D9: LOOKS OK”  
“D9: TODAY”

Otherwise, for each product that has more than 5% of loads in which the controller failed to detect the drop point, the following message is displayed:

“D9: IRREGULAR”  
“D9: LOADING”  
“D9: FOR 8% OF”  
“D9: “FILET” (← Product Name )  
“D9: TODAY”

Loading Report for Present Batch of Peanut oil

The data for this batch of peanut oil does not yet include Cook Cycles from today.

If no products have a failed to detect rate of more than 5%, the controller shows:

“D9: LOADING “  
“D9: LOOKS OK “  
“D9: THIS OIL “

Otherwise, for each product that has more than 5% of loads in which the controller failed to detect the drop point, the following message is displayed:

“D9: FOR THIS OIL,”  
“D9: IRREGULAR “  
“D9: LOADING “  
“D9: FOR 12% OF “  
“D9: “NUG-STRP” “ (← Product Name )

**1-5. DIAGNOSTIC MODE**  
**DETAILS (Continued)**

Loading Report for Previous Batch of Peanut oil

If no products have a failed to detect rate of more than 5%, the controller shows:

“D9: LOADING”  
“D9: LOOKED OK”  
“D9: PREVIOUS OIL”

Otherwise, for each product that has more than 5% of loads in which the controller failed to detect the drop point, the following message is displayed:

“D9: PREVIOUS OIL,”  
“D9: IRREGULAR”  
“D9: LOADING”  
“D9: FOR 6% OF”  
“D9: “BRK-FIL” ( ← Product Name )

**D 10: Non-Standard Program Items Report**

The last section in the diagnostic report identifies how many programmable settings have been altered from their original, factory default settings.

For each of the various program modes, the controller either reports that all settings match original values or reports N items do not match original values. This report makes it easy to see if any cook parameters or other settings have been changed from CFA settings.

Some programming items may have been changed from original values under the direction of CFA corporate headquarters. In some cases, a controller should have values that don't match original values. A report that “all items match original values” could actually be an indication that something isn't set right.

Keep in mind also that the number of such approved alterations might be different for different versions of software.

If all product cook settings match the original, factory default values, the controller displays the following message:

“10: ALL PROD'S”  
“10: MATCH”  
“10: ORIG. VALUES”

**1-5. DIAGNOSTIC MODE**  
**DETAILS (Continued)**

If any of the product settings do not match original values, the following message is displayed (with one or more of the product numbers blinking):

“10: PROD’S 123456”  
“10: DO NOT MATCH”  
“10: ORIG. VALUES”

In this case, the blinking numbers indicate which products do not match original settings. If the numbers 3 and 5 are the only numbers blinking, then product #3 and product #5 each have at least one setting changed from their factory preset values. Products 1, 2, 4, and 6 are confirmed to exactly match their original settings.

The second item in D 10 identifies how many items in CFA Programming Mode have been changed from their original values. These Chick-fil-A settings mainly deal with special Chick-fil-A controller features like oil wear, heat-up monitoring, new oil compensation, oil idle compensation, drop detection, amps and voltage alarms, and Clean-out Mode.

If all items in CFA Prog Mode match their original, factory preset values, the following report is made:

“10: ALL CFA ITEMS”  
“10: MATCH”  
“10: ORIG. VALUES”

If any of the items in CFA Prog Mode do not match their original values, the following message is displayed (with the actual number of changed items):

“10: 2 CFA ITEMS”  
“10: DO NOT MATCH”  
“10: ORIG. VALUES”

A similar report is made for Special Program Mode. Special Program (SP) Mode settings deal with °F/°C display, speaker tone and volume, Melt and Idle Modes, and how the product buttons function (start cook or merely select product).

“10: ALL SP ITEMS”	“10: 1 SP ITEMS “
“10: MATCH “	“10: DO NOT MATCH “
“10: ORIG. VALUES “	“10: ORIG. VALUES “

**1-5. DIAGNOSTIC MODE**  
**DETAILS (Continued)**



The final item in D 10 identifies if any changes have been made to the heat control settings. These settings affect the fryer’s heating algorithms, and include the PC factors, rate-of-rise compensations, and heat pulse cycle time, etc.

“10: ALL HC ITEMS”  
“10: MATCH”  
“10: ORIG. VALUES”

“10: 3 HC ITEMS”  
“10: DO NOT MATCH”  
“10: ORIG. VALUES”


**1-6. INFORMATION MODE**  
**DETAILS**

This historic information in this mode can be recorded and used for operational and technical help.


Press  and  at the same time and “\*INFO MODE\*”


shows in the display, followed by “1. E-LOG”.


**NOTICE**


Press and hold  to exit Information Mode at any time, or after 2 minutes, controls automatically exit back to normal operation.

1. E-LOG (error code log)


Press  and “1A. (date & time) \*NOW\* shows in display. This is the present date and time.


Press  and if a error was recorded, “1B. (date, time, and error code information)” shows in display. This is the latest error code that the controls recorded.

Press  and the next latest error code information can be seen. Up to 10 error codes (1B to 1K) can be stored in the E-LOG section.


Press  to continue to P-LOG.

2. P-LOG (power-up log)

Press  and “2A. (date & time) \*NOW\* shows in display. This is the present date and time.


Press  and latest power-up is shown, “2B. (date, time,) PWR-UP”.


**1-6. INFORMATION MODE**  
**DETAILS**


Press  and the next latest power-up date is shown. Up to 10 power-ups (2B to 2K) can be stored in the P-LOG section.


Press  to continue onto the heat-up log.

**3. HEAT-UP'S**


Press  and "3A. (date & time) \*NOW\* shows in display. This is the present date and time.

Press  and the latest heat-up is shown, along with heat-up rate, ex: "3B. MAY-22, 8:37A 1.25". The heat rate is the maximum rate (degrees/second) the controller recorded during the shown time frame.


Press  and the next latest heat-up is shown. Up to 10 heat-ups (3B to 3K) can be stored in the HEAT-UP log.

Press  to continue onto the COOK DATA.

**4. COOK DATA**

Press  to step through the following data:

<b>FUNCTION</b>	<b>DISPLAY EXAMPLE</b>
Time of day last Cook Cycle was started	4A. STARTED 10.25A
Product (last product cooked)	4B. PRODUCT -1-
Ready? (was fryer ready before start?)	4C. READY? YES
Drop detect status	4D. DETECT / T-14
Drop adjust (real time seconds)	4E. DROP ADJ T-14
Cook time adj (clock adjust)	4F. CK TM ADJ -13
Actual elapsed cook time (real seconds)	4G. ACT TIME 4:50
Stopped: time remaining, or secs past done	4H. STOP DONE+2
Slow cook for this cycle?	4I. SLOW? NO
Frozen or overload? (bad batch)	4J. FRZ/OVL? NO
Avg temp during Cook Cycle	4K. AVG TMP 317°F
Max voltage during Cook Cycle	4L. MAX VOLT 99%
Min voltage during Cook Cycle	4M. MIN VOLT 97%
Max amps during Cook Cycle	4N. MAX AMPS 35
Min amps during Cook Cycle	4O. MIN AMPS 34

Press  to continue onto today's data log.

**1-6. INFORMATION MODE**  
**DETAILS**


5. TODAY'S DATA (automatically resets each day)

Press  to step through the following data:

<b>FUNCTION</b>	<b>DISPLAY EX:</b>
Today's Date	5A. DATE APR-12
Time of day last heat-up was completed	5B. LAST HEAT 9:45A
Peak heat-up rate (°F/Sec) for last heat-up	5C. LAST RATE 0.82
Was last heat-up acceptable?	5D. LAST OK? YES
Heat cap. status (based on last 4 ht-ups)	5E. HEAT CAP GOOD
Number of monitored heat-ups today	5F. HEAT-UPS 2
Number of slow heat-ups	5G. SLOW HT'S 0
Max time to heat 270°F to 310°F today	5H. MAX HT TM 1:17
Lowest peak rate for today's heat-ups	5I. MIN RATE 0.82
Maximum voltage today (when fryer on)	5J. MAX VOLT 99%
Minimum voltage today (when fryer on)	5K. MIN VOLT 95%
No. of "LOW VOLTAGE" warnings	5L. LO VOLT'S 0
Maximum amp draw today	5M. MAX AMPS 35
Minimum amp draw today	5N. MIN AMPS 33
Number of "Low Amps" warnings today	5O. LO AMP'S 0
Non-cooking time (hh:mm) while fryer was on	5P. IDLE HRS 1:23
Oil wear accumulated so far today	5Q. OIL WEAR 3
Total number of Cook Cycles today	5R. TOT CK'S 11
No. of cycles started before ready	5S. NOT RDY'S 2
No. cycles quit early (0:11 or more remaining)	5T. QUIT 11+ 0
No. cycles beeped *DONE* 21 sec or more	5U. DONE 21+ 1
Individual product cook counts	5V. Px CK CT 2
Individual product not detected counts	5W. Px NO DET 0
Individual product slow cook counts	5X. Px SLO CT 0
Individual product frozen or overloaded	5Y. Px FRZ/OV 0


**NOTICE**

During steps 5V through 5Y, press the product buttons (or Manual Prog) to see data on individual product items.

Press  to continue onto prev-day-sun log.

**1-6. INFORMATION MODE**  
**DETAILS**

**6. PREV DAY - SUN**

Press  to step through following data. During each step, press




to choose the day of the week, of the past 7 days.

<b>FUNCTION</b>	<b>DISPLAY EX:</b>
Day this data was recorded for	6A. DATE APR-8
Time of day last heat-up was completed	6B. LAST HEAT 8:15P
Peak heat-up rate (°F/Sec) for last heat-up	6C. LAST RATE 0.88
Was that day's last heat-up acceptable?	6D. LAST OK? YES
Heat cap. status (based on last 4 ht-ups)	6E. HEAT CAP GOOD
Number of monitored heat-ups that day	6F. HEAT-UPS 7
Number of slow heat-ups	6G. SLOW HT'S 0
Max time to heat 270°F to 310°F that day	6H. MAX HT TM 1:11
Lowest peak rate for that day's heat-ups	6I. MIN RATE 0.67
Maximum voltage that day (when fryer on)	6J. MAX VOLT 102%
Minimum voltage that day (when fryer on)	6K. MIN VOLT 98%
No. of "LOW VOLTAGE" warnings	6L. LO VOLT'S 0
Maximum Amp Draw that day	6M. MAX AMPS 35
Minimum Amp Draw that day	6N. MIN AMPS 34
No. of "LOW AMPS" warnings that day	6O. LO AMP'S 0
Non-cooking time (hh:mm) while fryer was on	6P. IDLE HRS 7:09
Oil wear accumulated that day	6Q. OIL WEAR 39
Total number of Cook Cycles that day	6R. TOT CK'S 18
Number of cycles started before ready	6S. NOT RDY'S 2
No. cycles quit early (0:11 or more remaining)	6T. QUIT 11+ 1
No. cycles beeped *DONE* 21 sec or more	6U. DONE 21+ 3
Individual product cook counts	6V. Px CK CT 12
Individual product not detected counts	6W. Px NO DET 1
Individual product slow cook counts	6X. Px SLO CT 0
Individual product frozen or overloaded	6Y. Px FRZ/OV 1


**NOTICE**

During steps 6V through 6Y, press the product buttons (or Manual Prog) to see data on individual product items.

Press  to continue onto 7-day totals log.

**1-6. INFORMATION MODE  
DETAILS**


**7. 7-DAY TOTALS**

Press  to step through the following data:

<b>FUNCTION</b>	<b>DISPLAY EX:</b>
Oldest day in the previous days history	7A. SINCE APR-5
Number of days with data included in totals	7B. DAYS CNT 6
Number of monitored heat-ups	7C. HEAT-UPS 30
Number of slow heat-ups	7D. SLOW HT'S 1
Max time to heat 270°F to 310°F	7E. MAX HT TM 3:25
Lowest peak rate of all heat-ups	7F. MIN RATE 0.47
Maximum voltage	7G. MAX VOLT 102%
Minimum voltage	7H. MIN VOLT 91%
No. of "LOW VOLTAGE" warnings	7I. LO VOLT'S 0
Maximum amp draw	7J. MAX AMPS 35
Minimum amp draw	7K. MIN AMPS 32
Number of "LOW AMPS" warnings	7L. LO AMP'S 0
Non-cooking time (hrs) while fryer was on	7M. IDLE HRS 43
Total oil wear accumulated	7N. TOT WEAR 278
Total number of Cook Cycles	7O. TOT CK'S 125
Number of cycles started before ready	7P. NOT RDY'S 7
No. cycles quit early (0:11 or more remaining)	7Q. QUIT 11+ 1
No. cycles beeped *DONE* 21 sec or more	7R. DONE 21+ 3
Individual product cook counts	7S. Px CK CT 77
Individual product not detected counts	7T. Px NO DET 3
Individual product slow cook counts	7U. Px SLO CT 0
Individual product frozen or overloaded	7V. Px FRZ/OV 1

**NOTICE**


During steps 7S through 7V, press the product buttons (or Manual Prog) to see data on individual product items.

Press  to continue onto oil data log.



**1-6. INFORMATION MODE**  
**DETAILS**


8. OIL DATA (current batch; resets by Clean-Out Mode)

Press  to step through the following data:

<b>FUNCTION</b>	<b>DISPLAY EX:</b>
The day current batch of oil was started	8A. SINCE APR-1
Number of days with data included in totals	8B. DAYS CNT 10
Number of monitored heat-ups	8C. HEAT-UPS 75
Number of slow heat-ups	8D. SLOW HT'S 2
Max time to heat 270°F to 310°F	8E. MAX HT TM 3:25
Lowest peak rate of all heat-ups	8F. MIN RATE 0.43
Maximum voltage	8G. MAX VOLT 102%
Minimum voltage	8H. MIN VOLT 91%
No. of "LOW VOLTAGE" warnings	8I. LO VOLT'S 0
Maximum amp draw	8J. MAX AMPS 35
Minimum amp draw	8K. MIN AMPS 32
No. of "LOW AMPS" warnings	8L. LO AMP'S 0
Non-cooking time (hrs) while fryer was on	8M. IDLE HRS 43
Total oil wear accumulated	8N. TOT WEAR 278
Total number of Cook Cycles	8O. TOT CK'S 125
Number of cycles started before ready	8P. NOT RDY'S 7
No. cycles quit early (0:11 or more remaining)	8Q. QUIT 11+ 1
No. cycles beeped *DONE* 21 sec or more	8R. DONE 21+ 3
Individual product cook counts	8S. Px CK CT 77
Individual product not detected counts	8T. Px NO DET 3
Individual product slow cook counts	8U. Px SLO CT 0
Individual product frozen or overloaded	8V. Px FRZ/OV 1


**NOTICE**

During steps 8S through 8V, press the product buttons (or Manual Prog) to see data on individual product items.

Press  to continue onto prev oil data log.

**1-6. INFORMATION MODE**  
**DETAILS**

9. PREV OIL DATA (moved here from Oil Data log; assumes new peanut oil)

Press  to step through the following data:

<b>FUNCTION</b>	<b>DISPLAY EX:</b>
The day previous batch of oil was started	9A. BEGAN MAR-9
Number of days with data included in totals	9B. DAYS CNT 18
Number of monitored heat-ups	9C. HEAT-UPS 98
Number of slow heat-ups	9D. SLOW HT'S 0
Max time to heat 270°F to 310°F	9E. MAX HT TM 1:31
Lowest peak rate of all heat-ups	9F. MIN RATE 0.57
Maximum voltage	9G. MAX VOLT 101%
Minimum voltage	9H. MIN VOLT 96%
Number of "LOW VOLTAGE" warnings	9I. LO VOLT'S 0
Maximum amp draw	9J. MAX AMPS 35
Minimum amp draw	9K. MIN AMPS 33
Number of "LOW AMPS" warnings	9L. LO AMP'S 0
Non-cooking time (hours) while fryer was on	9M. IDLE HRS 62
Total oil wear accumulated	9N. TOT WEAR 1523
Total number of Cook Cycles	9O. TOT CK'S 653
Number of cycles started before ready	9P. NOT RDY'S 25
Num. cycles quit early with 0:11 or more rem	9Q. QUIT 11+ 3
Num. cycles beeped *DONE* 21 sec or more	9R. DONE 21+ 13
Individual product cook counts	9S. Px CK CT 466
Individual product not detected counts	9T. Px NO DET 31
Individual product slow cook counts	9U. Px SLO CT 0
Individual product frozen or overloaded	9V. Px FRZ/OV 5

**NOTICE**

During steps 9S through 9V, press the product buttons (or Manual Prog) to see data on individual product items.

Press  to continue onto INP A\_VHDSF\_M checks.

**1-6. INFORMATION MODE**  
**DETAILS**

10. INP A\_VHDSF\_M

This mode displays the status of components and inputs. If the input signal is detected, an identifying letter is displayed (see below). If the signal is not detected, “\_” is displayed.

With the COOK/PUMP switch turned to COOK, and all inputs detected, “H\_P\_A\_VHDSF\_M” shows in the display, for electric fryers; “H\_P\_A\_VHDSFP\_” for gas fryers. See below for definition of codes.

A = COOK/PUMP switch turned to COOK

B = COOK/PUMP switch in PUMP position

V = Volts - 24 VAC detected

H = High Limit - If “H” is present, the high limit is good; if “H” is missing, the high limit is tripped (overheated) or faulty


D = Drain switch - If “D” is present, the drain handle is closed; if “D” is missing, the drain is open or faulty

S = COOK/PUMP switch “on” interlock circuit: If “S” is present, COOK/PUMP switch is in the COOK position; if “S” is missing, power switch is either off, failed, or wired incorrectly

F = Fan

P = PV - Detects 24 V jumper to PV terminal - gas fryers only


M = MV - Detects 24 V jumper to MV terminal - electric fryers only

Press  to view specific status of each input. **An underscore**

(“\_”) indicates the input is not presently detected. A checkmark (“√”) indicates the signal is detecting a normal input. A blinking (“X”) indicates the signal is presently detected, but is detected as a half-wave (partially failed) input.

**NOTICE**

The V, H, D, S, F, P, and M signals below are wired in series. The first signal missing out of this sequence will generally cause all signals to the right of it to be missing as well.

Press  to continue onto OUTP H\* P\_ checks.

**1-6. INFORMATION MODE**  
**DETAILS**

**11. OUTP H\* P\_**

This mode displays the status of components and outputs. If the output signal is detected, an identifying letter is displayed (see below), followed by an “\*”. If the output is off, “\_” is displayed.

H = Heat output


P = Pressure output

If heat is on, “H\*” shows in display. If heat is off, “H\_” shows in display. If controls senses a problem with the heat output, “H\*” shows in display, with the “\*” flashing.


If pressure is on, “P\*” shows in display. If pressure is off, “P\_” shows in display. If controls senses a problem with the pressure output, “P\*” shows in display, with the “\*” flashing.


Press  to view the “amps” status of each output.

“H/” and “P/” in the display means the amps are good. A flashing “X” behind the H or P means a problem exists.

Press  to view the no connect/ground (“NC/GD”) status of each output. This monitors a possible problem with the relays on the output PC board.


“H/” and “P/” in the display means everything on output PC board is good. A flashing “X” behind H or P means a problem exists.

Press  to view the outputs and inputs (see step 10) together.

Press  to continue onto the POT TMP reading.


**12. POT TMP**

This step shows the present peanut oil temperature. The display shows “12. POT TMP (temp.)”.

Press  to continue onto the CPU TMP reading.

**13. CPU TMP**

This step shows the present PC board temperature.

Press  to continue onto the ANALOG reading.

**1-6. INFORMATION MODE**  
**DETAILS**


14. ANALOG <1> 2344

This step displays the present status of any channel of the controller's a to d converter. This feature may be useful to a technician troubleshooting a problem with the fryer or controller.

Displayed value can be toggled between volts and bits by pressing





(0 to 5 VDC). If no decimal point is shown, the value is a-to-d bits (0 - 4095).

Press  to continue onto AC volts reading.

15. AC VOLTS 98%

This item displays the present status of the line voltage supply to the fryer. The displayed value is averaged over a 10-second period, so brief dips or fluctuations in the voltage might not show up in this display.

The voltage is normally displayed as a “percent of nominal” value, where 100% would indicate that voltage is right on the nominal value (i.e. 208 volts for a 208v fryer). The display can be toggled to an actual Voltage value by pressing .

Press  to continue onto AMPS reading.


16. AMPS 33 33 33

For electric fryers, this display shows the present readings from the fryer's amps sensors, which monitor the electrical current supplied to the heaters. (These sensors are not present on gas fryers.)

On pressure fryers, these values indicate the current through each supply leg to the heaters. These values do not correspond directly to the current through an individual heater coil.

The amps values should normally cycle on and off with the heat light, and all three values should be about the same.

**NOTICE**

Press and hold  to exit Information Mode at any time, or after 2 minutes, controls automatically exit back to normal operation.



## **SECTION 2. MAINTENANCE**

### 2-1. INTRODUCTION

This section provides procedures for the checkout and replacement of the various parts used within the fryer. Before replacing any parts, refer to Section 1, Troubleshooting. It will aid you in determining the cause of the malfunction.

### 2-2. MAINTENANCE HINTS

1. You may use two test instruments to check the electric components.
  - A continuity light
  - An ohmmeter
2. When the manual refers to the circuit being closed, the continuity light will be illuminated or the ohmmeter should read zero unless otherwise noted.
3. When the manual refers to the circuit being open, the continuity light will not illuminate or the ohmmeter will read 1 (one).

### **NOTICE**

A continuity tester cannot be used to check coils or motors.

2-3. PREVENTIVE  
MAINTENANCE  
SCHEDULE

To ensure a long life of the fryers and their components, regular maintenance should be performed. Refer to the chart below.

<b>Frequency</b>	<b>Action</b>
Daily (3-4 loads)	Filter shortening
Daily	Clean deadweight valve cap, weight, and orifice
30 Days	Lubricate spindle threads and ball seat
90 Days	Reverse lid gasket
90 Days	Check limit stop adjustment
90 Days	Check and tighten element spreaders
Once a year	Remove and clean safety relief valve

2-4. REMOVING THE  
CONTROL PANEL

To replace parts inside the fryer you will often need to remove the control panel. The following steps provide the correct procedure:

**Removal**

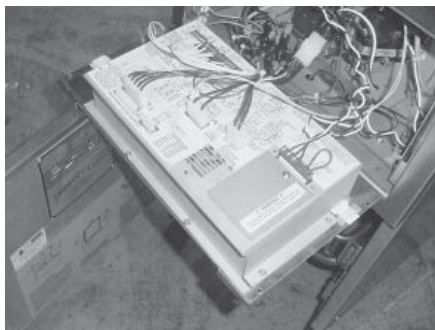
1. Place the main power switch to the OFF position. (This switch is labeled COOK/OFF/PUMP.)



**To avoid electrical shock or property damage, move the power switch to OFF and disconnect main circuit breaker, or unplug cord at wall receptacle.**



**Step 2**



**Step 3**

2. Remove the screws from the of the control panel.
3. With the fryer door partially closed, place the lower edge of control panel in the slot between the door and the frame of the fryer.



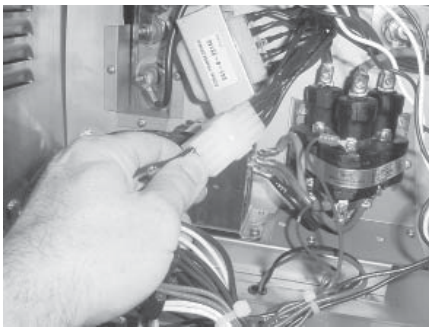
## 2-5. TRANSFORMER REPLACEMENT

The transformer reduces the voltage down to accommodate those components with low voltage.

1. Remove electrical power supplied to the unit.



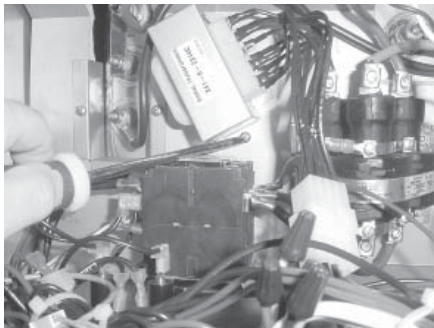
**To avoid electrical shock or property damage, move the power switch to OFF and disconnect main circuit breaker, or unplug cord at wall receptacle.**



**Step 3**

2. Remove the control panel. Refer to Section 2-4.

3. Disconnect the white box connector.



**Step 4**

4. Remove the two screws securing transformer to the unit and remove transformer.

5. Replace with new transformer in reverse order.

**2-6. TEMPERATURE PROBE  
REPLACEMENT**

The Temperature Probe relays the actual shortening temperature to the control. If it becomes disabled, “E-6” shows in the display. Also, if the temperature is out of calibration more than 10°F, or 10°C, the temperature probe should be replaced. An Ohm check can be performed also. See chart at end of this section.



**Step 4**

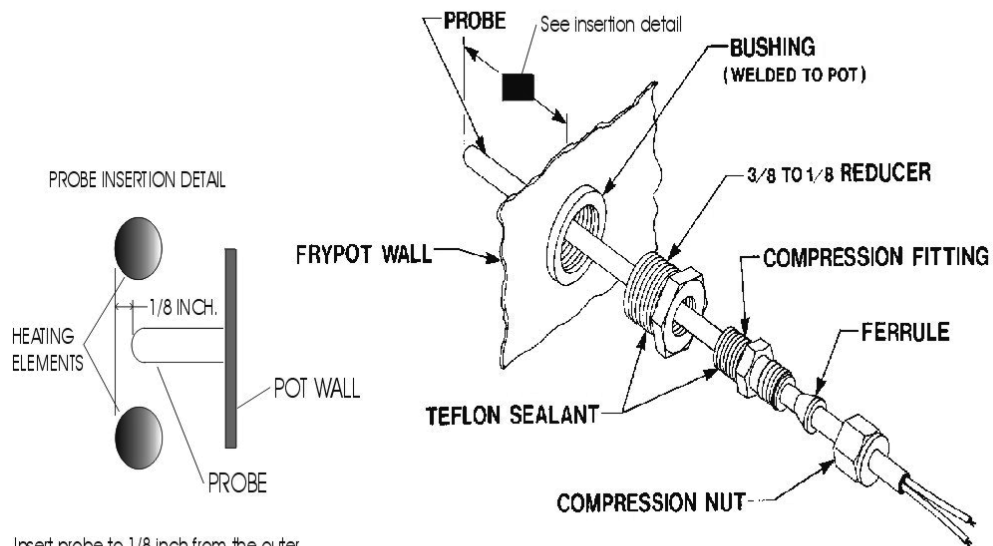
1. Remove electrical power supplied to the fryer.



**To avoid electrical shock or property damage, move the power switch to OFF and disconnect main circuit breaker, or unplug cord at wall receptacle.**

2. Drain the shortening from the frypot.
3. Remove the control panel. Refer to Section 2-4.
4. Using a 1/2” wrench, remove the nut on the compression fitting.
5. Remove the temperature probe from the frypot.
6. Follow the appropriate instructions below depending upon the type of fryer, gas or electric.

**ELECTRIC  
PROBE INSTALLATION INSTRUCTIONS**

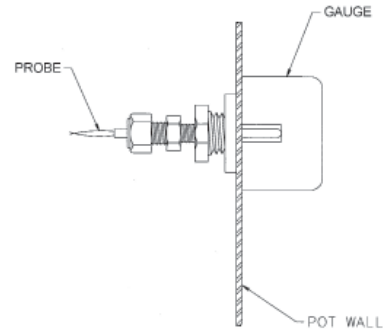
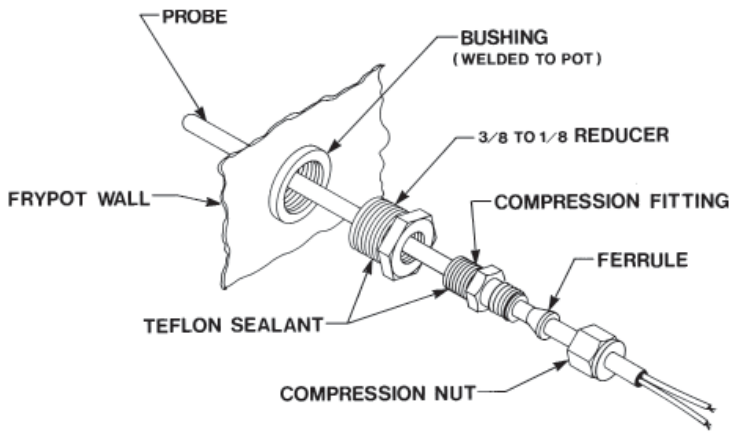


Insert probe to 1/8 inch from the outer surface of the elements. It must not extend beyond this or the basket will catch and bend it. If not extended far enough into the pot, the temperature readings will be lower than the actual oil temperature

Do not overtighten the compression nut- overtightening can cause the ferrule to distort the probe sheath.

2-6. TEMPERATURE PROBE  
REPLACEMENT (Continued)

**GAS**



- .) LOCATE TEMPERATURE PROBE THRU POT WALL.
- .) PLACE GAUGE AGAINST POT WALL AS SHOWN.
- .) PUSH TEMPERATURE PROBE THRU UNTIL IT MAKES CONTACT WITH GAUGE.
- .) TIGHTEN TEMPERATURE PROBE IN PLACE.

7. Tighten the compression nut hand tight and then a half turn with \_\_\_\_\_ wrench.

**CAUTION**

*Excess force will damage temperature probe.*

8. Connect new temperature probe to PC board and replace control panel.
9. Replace shortening and turn power on and check out fryer.

Temp. F	Temp. C	Resistance Ohms	Temp. F	Temp. C	Resistance Ohms
50	10.00	1039.02	250	121.11	1464.79
60	15.56	1060.65	260	126.67	1485.71
70	21.11	1082.24	270	132.22	1506.58
80	26.67	1103.80	280	137.78	1527.43
90	32.22	1125.32	290	143.33	1548.23
100	37.78	1146.81	300	148.89	1569.00
110	43.33	1168.26	310	154.44	1589.73
120	48.89	1189.67	320	160.00	1610.43
130	54.44	1211.05	325	162.78	1620.77
140	60.00	1232.39	330	165.56	1631.09
150	65.56	1253.70	340	171.11	1651.72
160	71.11	1274.97	350	176.67	1672.31
170	76.67	1296.20	360	182.22	1692.86
180	82.22	1317.40	365	185.00	1703.13
185	85.00	1327.99	370	187.78	1713.38
190	87.78	1338.57	380	193.33	1733.87
200	93.33	1359.69	390	198.89	1754.31
210	98.89	1380.79	400	204.44	1774.72
212	100.00	1385.00	410	210.00	1795.10
220	104.44	1401.84	420	215.56	1815.44
230	110.00	1422.86	430	221.11	1835.74
240	115.56	1443.85	440	226.67	1856.01

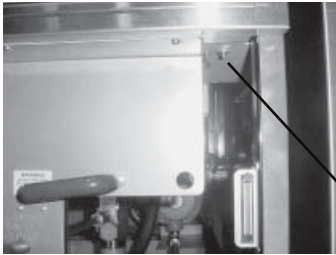
2-7. HIGH TEMPERATURE  
LIMIT CONTROL  
(ELECTRIC AND  
GAS MODELS)

**Description**

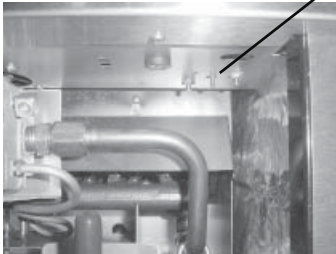
This high temperature control is a manual reset control which senses the temperature of the shortening. If the shortening temperature exceeds the safe operating limit, this control switch will open and shut off the heat to the frypot. When the temperature of the shortening drops to the safe operating limit, the control must manually be reset.

To locate the high limit reset button, open the door to the drain pan. Look up under the controls and to the right of the filter handle for a red reset button. (On the left for single phase units.)

**Electric**



**Gas**



Red Reset Button

**Checkout**

Before replacing a high temperature limit control, check to see that its circuit is closed.

**NOTICE**

The shortening temperature must be below 380° F to accurately perform this check.

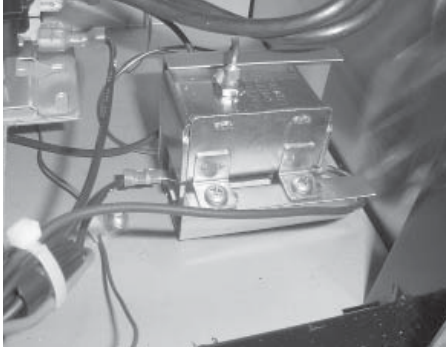
1. Remove electrical power supplied to the fryer.



**To avoid electrical shock or property damage, move the power switch to OFF and disconnect main circuit breaker, or unplug cord at wall receptacle.**

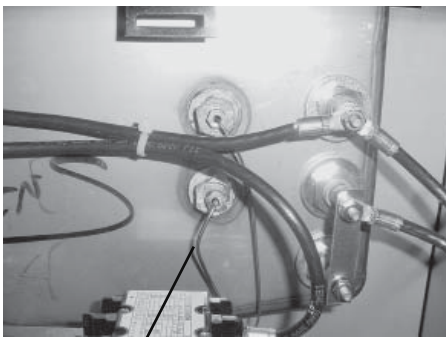
2. Remove the control panel. Refer to Section 2-4.

2-7. HIGH TEMPERATURE  
LIMIT CONTROL  
(ELECTRIC AND  
GAS MODELS)  
(Continued)



Step 3

**Electric**



High Limit Capillary Tube

**Gas**



Step 1

3. Remove the two electrical wires from the high temperature limit control.
4. Check for continuity between the two terminals after resetting the control. If the circuit is open, replace the control, then continue with this procedure. (If the circuit is closed, high limit is not defective. Reconnect the two electrical wires.)

**Replacement**



**To avoid electrical shock or property damage, move the power switch to OFF and disconnect main circuit breaker, or unplug cord at wall receptacle.**

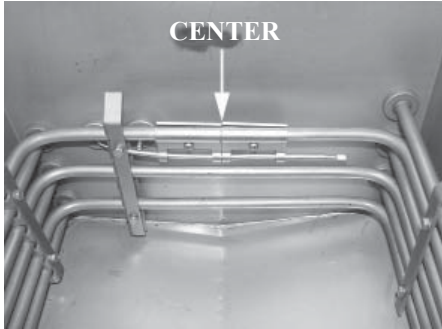
1. If the capillary tube is broken or cracked, control will open, shutting off electrical power. The control cannot be reset.
2. Drain shortening from the frypot.
3. Remove control panel.
4. Loosen small inside screw nut on capillary tube.
5. Remove capillary bulb from bulb holders inside the frypot.
6. Straighten the capillary tube.
7. Remove larger outside nut that threads into pot wall.
8. Remove the two screws that secure the high limit to the high limit bracket.
9. Remove defective control from control panel area.
10. Insert new 450 degree high limit (part no. 16738) and replace screws.
11. Uncoil capillary line, starting at capillary tube, and insert through frypot wall.



**To avoid electrical shock or other injury, the capillary line must run under and away from all electrical power wires. The tube must never be in contact with the electrical power wires or terminals.**

2-7. HIGH TEMPERATURE  
LIMIT CONTROL  
(ELECTRIC AND  
GAS MODELS)  
(Continued)

**Electric**

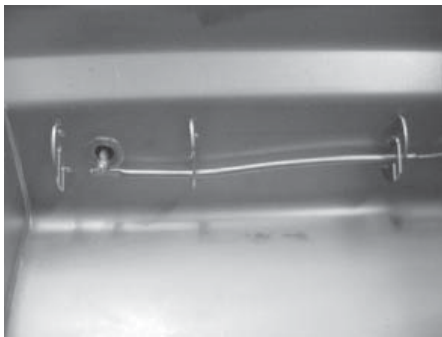


12. Carefully bend capillary bulb and tube toward bulb holders on heating elements on electric units, and toward the welded clips on gas units.

**NOTICE**

Hang 2 high limit bulb holders, for capillary bulb of the 450 degree high limit (part no. 16738) from the center of the top element. See photo at left.

**Gas**



**Step 13**

13. Slip capillary bulb into 2 bulb holders located on heating elements, on electric units, and snap bulb in place in welded clips, on gas units. Pull excess capillary line from pot and tighten nut into frypot wall.

**CAUTION**

*Be sure capillary bulb of high limit on electric units is not located past the front of the elements. The capillary bulb and bulb holders should be positioned as not to interfere with basket or when cleaning the frypot wall, or damage to capillary tube could result.*

14. With excess capillary line pulled out, tighten smaller nut.
15. Replace front panel.
16. Refill with shortening.

2-8. HEATING ELEMENTS  
(ELECTRIC MODELS)

**Description**

Each electric fryer uses three heating element assemblies.

**NOTICE**

Heating elements are available for 208, 220/240, or 440/480 voltage. Check the data plate inside the door to determine the correct voltage.

**Maintenance Hint**

If the shortening's temperature recovery is very slow, or at a slower rate than required, this may indicate defective heating element(s). An ohmmeter will quickly indicate if the elements are shorted or open.

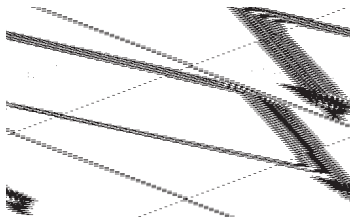
**Checkout**

1. Remove electrical power supplied to the fryer.



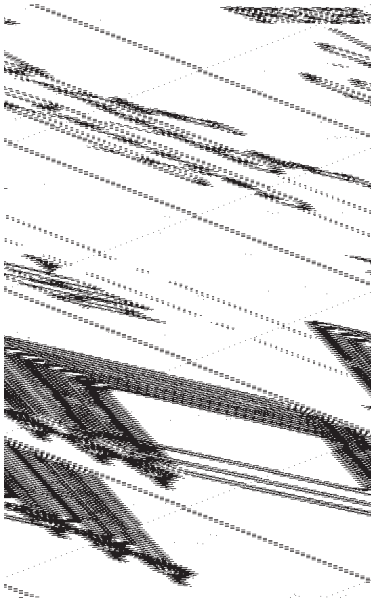
**To avoid electrical shock or property damage, move power switch to OFF and disconnect main circuit breaker, or unplug cord at wall receptacle.**

2. Remove the control panel and insert it in the slot above the door. Refer to paragraph 2-4.
3. Perform an ohm check on one heating element at a time, with wires disconnected from element. If the resistance is not within tolerance, replace the element.

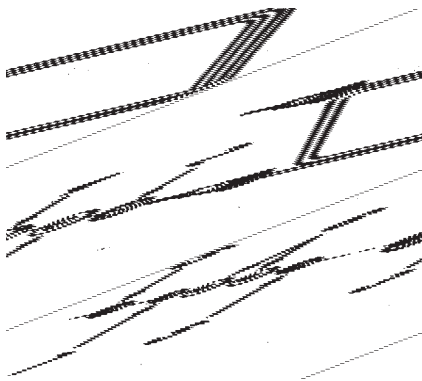


HEATER P/N	POWER	VOLTAGE	RESISTANCE IN OHMS (COLD)
18233-1	4500W	208VAC	9±1
18233-2	4500W	230VAC	11±1.5
18233-4	3750W	208VAC	11±1.5
18233-5	3750W	220VAC	12±2
18233-6	3750W	480VAC	60±5
18233-7	4500W	480VAC	50±4
18233-8	4500W	380VAC	32±3.5

2-8. HEATING ELEMENTS  
(ELECTRIC MODELS)  
(Continued)



(Reference Figure 3-16)



**Replacement**

1. Drain the shortening.
2. Remove the high limit bulb holder from the heating element inside the frypot.
3. Remove the heating element wires from the terminals by removing nuts (5) and washers (6 and 7). Label each so it can be replaced in the same position on the new element.
4. Loosen the bolts on the four element spreaders.
5. Slide the element spreaders to the center of the heating element.
6. Remove the brass nuts (4) and washers (3), which secure the ends of the elements through the frypot wall.
7. Remove the heating elements from the frypot as a group by lifting the far end and sliding them up and out toward the rear of the frypot.

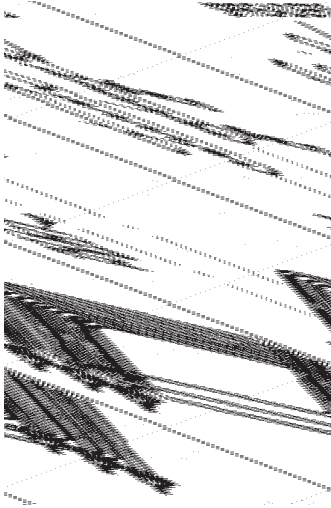
**NOTICE**

Always install new rubber O-rings (2) when installing heating elements.

8. Install new heating elements with new rubber O-rings (2) mounted on terminal ends, and spreaders loosely mounted in the center of the stacked elements.
9. Replace the heating elements, terminal end first at approximately 45° angle, slipping the terminal ends through the front wall of the frypot.



2-8. HEATING ELEMENTS  
(ELECTRIC MODELS)  
(Continued)



10. Replace the brass nuts (4) and washers (3) on the heating element terminals. Tighten the brass nuts to 30 foot lbs of torque.
11. Move the element spreaders from the center of the element, into a position which will spread each element apart evenly on all four sides, and tighten.
12. Replace the high limit bulb holder on the top element, and position the bulb between the top and second element midway from side to side, and tighten screw which holds the bulb in place.
13. Reconnect the wires to the appropriate terminal as labeled when they were removed.
14. Replace the front control panel.
15. Connect the power cord to the wall receptacle or close wall circuit breaker.

**CAUTION**

*Heating elements should never be energized without shortening in the frypot, or damage to elements could result.*

16. Check the heating elements as described in paragraph 2-17 of Operator's Manual.
17. Replace the shortening in the frypot.

2-9. HEATING  
CONTACTORS  
(ELECTRIC MODELS)

**Description**

Each electric fryer requires two switching contactors. One is the primary contactor and the second in line is the heat contactor. When open, the primary contactor allows no power to flow to the heat contactor. When closed, the primary contactor completes the timer circuit and the high limit (heat) circuit. It also supplies power to the heat contactor which is controlled by the thermostat.

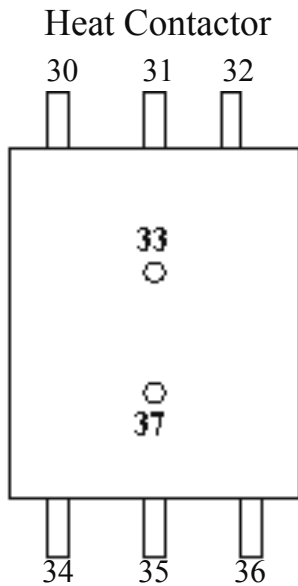
**Checkout (power removed)**

1. Remove electrical power supplied to the fryer.



**To avoid electrical shock or property damage, move the power switch to OFF and disconnect main circuit breaker, or unplug cord at wall receptacle.**

2. Remove the control panel.
3. Perform a check on the contactor as follows:



**Test Points**

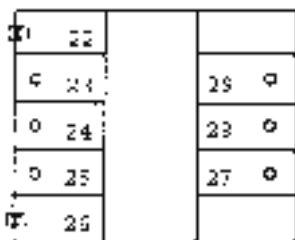
**Results**

From 23 to 29	open circuit
From 24 to 28	open circuit
From 25 to 27	open circuit
From 30 to 34	open circuit
From 31 to 35	open circuit
From 32 to 36	open circuit
From 33 to 37	ohm reading 1700
From 22 to 26	ohm reading 415

**NOTICE**

Wires should be removed and labeled to obtain an accurate check of contactors.

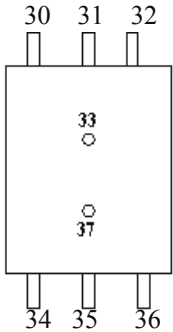
Primary Contactor



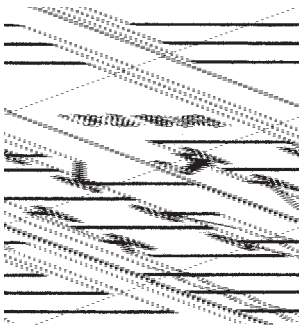
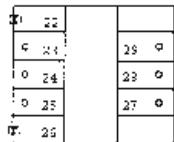
**2-9. HEATING**

**CONTACTORS  
(ELECTRIC MODELS)  
(Continued)**

Heat Contactor



Primary Contactor



**Checkout (power supplied)**



To avoid electrical shock, make connections before applying power, take reading, and remove power before removing meter leads. The following checks are performed with the wall circuit breaker closed and the main power switch in the ON position.

1. With power re-applied, press one of product buttons to start the unit heating.
2. On fryers using single phase power, check voltage as follows:

<u>Test Points</u>	<u>Results</u>
from pin D on circuit breaker to: terminal 34 terminal 35 terminal 36 (If voltage is not present, check output of primary contactor at terminals 27, 28, and 29.)	The voltage should read the same at each terminal. It should correspond to the voltage rating stated on the data plate.

3. On fryers using three-phase power, check voltage as follows:

<u>Test Points</u>	<u>Results</u>
Heat contactor from terminal 34 to 35 from terminal 35 to 36 from terminal 34 to 36	The voltage should read the same at each terminal. It should correspond to the voltage rating stated on the data plate.
Primary contactor from terminal 27 to 28 from terminal 28 to 29 from terminal 27 to 29	

2-9. HEATING

CONTACTORS

(ELECTRIC MODELS)

(Continued)

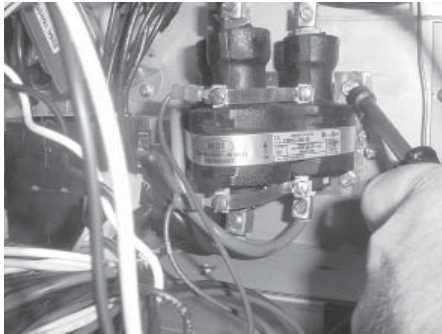
**Replacement**

If either contactor is defective it must be replaced as follows:



**To avoid electrical shock or property damage, move the power switch to OFF and disconnect main circuit breaker, or unplug cord at wall receptacle.**

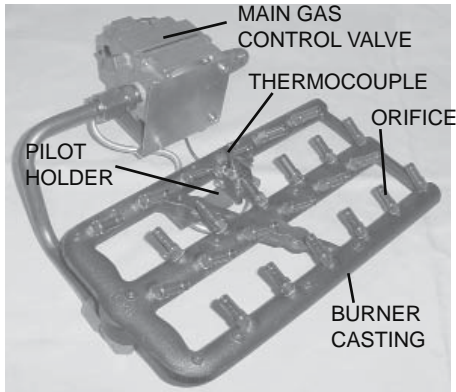
1. Remove only those wires directly connected to the contactor being replaced. Label the wires.



**Step 2**

2. On the mercury heat contactor, use a 5/16" socket or nut-driver and loosen four nuts securing contactor to shroud. Slide contactor up and then pull out through the slotted holes in the base of the contactor.
3. On the primary contactor, remove two mounting screws on the base plate and remove contactor.
4. Install the new contactor and tighten the two mounting screws.
5. Connect the labeled wires to their respective positions.
6. Install the control panel.
7. Reconnect power to the fryer and test the fryer for proper operation.

**2-10. GAS BURNER  
ASSEMBLY  
(GAS MODELS)**



**Description**

The gas model fryer has a gas burner assembly consisting of a burner casting, orifices, thermocouple, pilot holder, and main gas control valve.

**Safety Precautions**

**NOTICE**

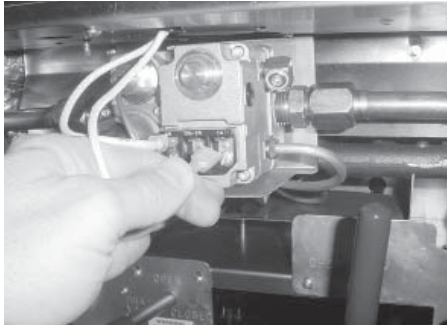
If converting from natural gas to propane gas or from propane gas to natural gas, conversion must be done by a qualified service technician.

**! DANGER**  
**EXPLOSION RISK**

**TO AVOID PERSONAL INJURY OR PROPERTY DAMAGE, BEFORE STARTING THIS PROCEDURE, MOVE THE MAIN POWER SWITCH TO THE OFF POSITION. DISCONNECT THE MAIN CIRCUIT BREAKERS AT THE CIRCUIT BREAKER BOX OR UNPLUG SERVICE CORD FROM WALL RECEPTACLE. TURN OFF THE MAIN GAS SUPPLY TO THE FRYER AND DISCONNECT AND CAP THE MAIN SUPPLY LINE TO FRYER, OR POSSIBLE EXPLOSION COULD RESULT.**

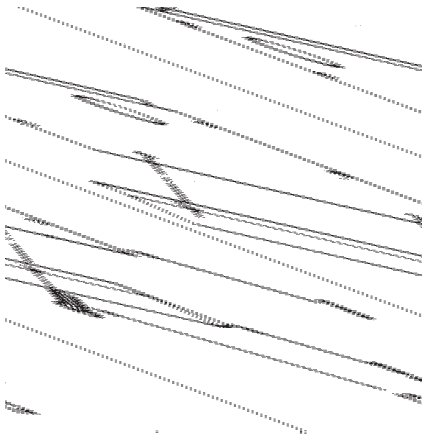
1. Remove the control panel per paragraph 2-4.
2. Label and remove the gas control valve wires.
3. Place the control panel back in upright position, in the metal flanges.

**2-10. GAS BURNER  
ASSEMBLY  
(GAS MODELS)  
(Continued)**



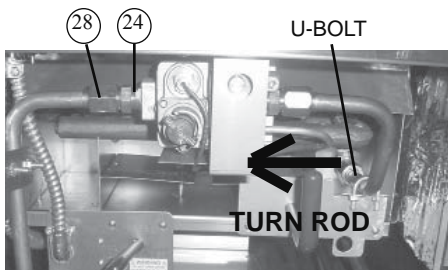
**Step 4**

4. Remove wires from the gas control valve.
5. Disconnect gas supply line (28) from the connector (24) at control valve. (Refer to photo below.)



**Step 6 and 7**

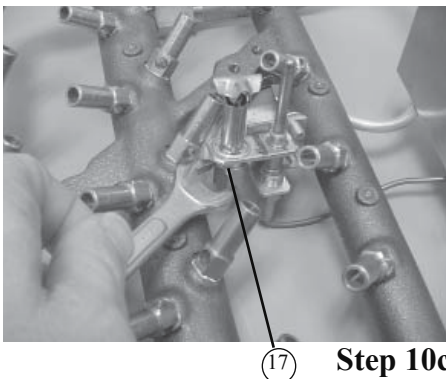
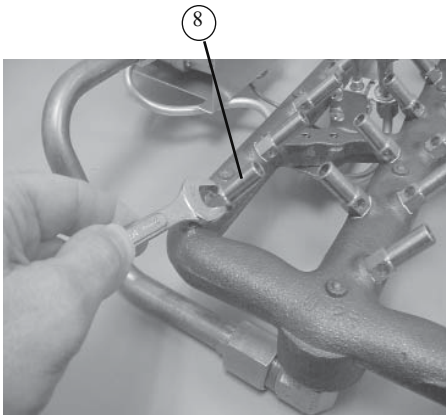
6. Loosen the two screws (13) on the heat shield deflector (9), on the firebox and flue assembly and raise the deflector to its highest position.
7. Retighten screws (13) to hold the heat shield deflector in the high position.



**Step 5, 8 and 9**

8. Turn the filter valve rod to the OPEN position.
9. Remove u-bolt from rinse hose bracket.

2-10. GAS BURNER  
ASSEMBLY  
(GAS MODELS)  
(Continued)



**Step 10c**

10. Remove entire gas burner assembly, by lifting and pulling toward front of fryer.
  - a. Replace thermocouple (19) as required, per paragraph 2-13.
  - b. Repair or replace gas control valve (20) as required, per paragraph 2-14.
  - c. Replace orifices (8 and 17) as required.

**NOTICE**

There are 23 brass orifices and 1 stainless steel orifice. The stainless steel orifice is to be mounted adjacent to the pilot light.

11. Make other repairs or replacements as required.
12. Install entire gas burner assembly.
13. Install u-bolt to rinse hose bracket and gas line.
14. Turn the filter valve handle to the CLOSED position.
15. Loosen the two screws (13) which are holding the heat shield deflector (9) in the high position, and lower it to the normal operating position.
16. Tighten the two screws (13) on the heat shield.
17. Connect gas supply line (28) to the gas control valve connector (24).
18. Install the wires onto gas control valve.

2-10. GAS BURNER  
ASSEMBLY  
(GAS MODELS)  
(Continued)

19. Remove control panel and install it in slot above the door.
20. Connect gas control valve wires to the thermostat and high temperature limit control as labeled.
21. Install control panel per paragraph 2-4.
22. Uncap and reconnect the main gas supply line to the fryer.  
Turn on the main gas supply



**LEAKING GAS MAY CAUSE AN EXPLOSION.  
CHECK FOR LEAKS PER OPERATOR'S MANUAL  
PARAGRAPH 2-8.**

23. Connect the service cord to the wall receptacle, or close circuit breakers.
24. Relight gas pilot per the instructions in paragraph 2-10 of the Operator's Manual.

2-11. THERMOCOUPLE  
(GAS MODELS)

The thermocouple controls the gas control valve. It generates voltage in the millivolt. This voltage signals the gas control valve to remain open to the pilot and burner. When the voltage is not generated the gas control valve will shut off, not allowing gas to the pilot and main burner.

**NOTICE**

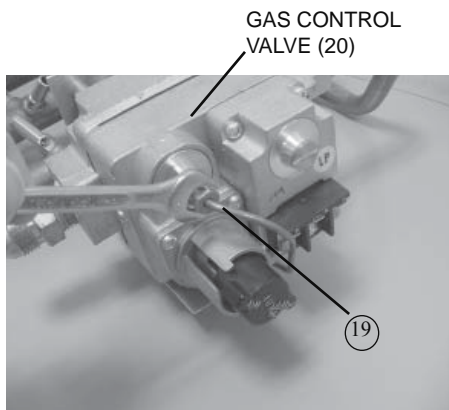
If converting from natural gas to propane gas or from propane gas to natural gas, conversion must be done by a qualified technician.



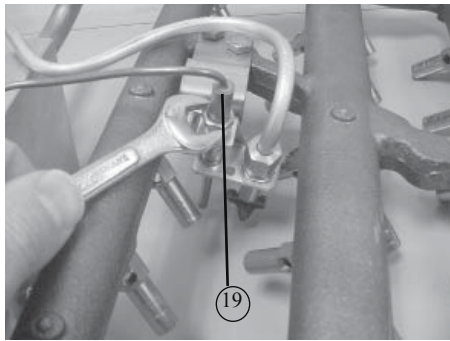
**TO AVOID INJURY OR PROPERTY DAMAGE, BEFORE STARTING THIS PROCEDURE, MOVE THE MAIN POWER SWITCH TO THE OFF POSITION. DISCONNECT THE MAIN CIRCUIT BREAKER AT THE CIRCUIT BREAKER BOX OR UNPLUG THE SERVICE CORD AT THE WALL RECEPTACLE. TURN OFF THE MAIN GAS SUPPLY TO THE FRYER. DISCONNECT AND CAP THE SUPPLY LINE TO FRYER, OR EXPLOSION COULD RESULT.**



**2-11. THERMOCOUPLE**  
**(GAS MODELS)**  
**(Continued)**

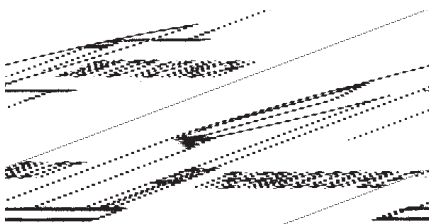


**Step 1**



**Step 2**

**(Refer to exploded view,  
figure 3-14)**



**Step 3**

**Replacement of Thermocouple**

Removal of the thermocouple is accomplished with the main gas supply shut off. The main burner may remain inside the fryer, but the work is more easily performed with the burner removed.

1. Using a 3/8" wrench, remove nut securing the thermocouple (19) in the gas control valve (20).

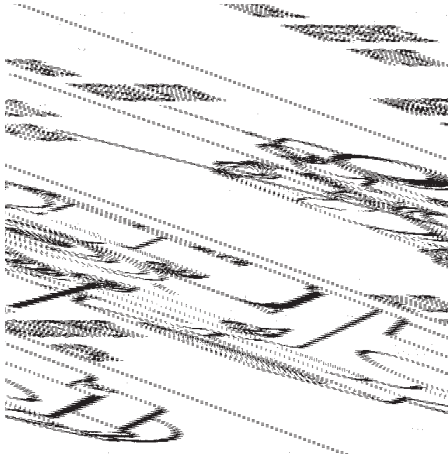
2. Remove nut securing the thermocouple in the pilot holder.

3. Install new thermocouple, being careful not to create sharp bends in the tubing. When the pilot is lit, the flame must surround the top of the thermocouple.

4. Turn on the main gas supply and reconnect the electrical power.

5. Light the pilot per paragraph 2-10 of the Operator's Manual and test the fryer for proper operation.

## 2-12. GAS CONTROL VALVE



### **Description**

The gas control valve regulates the flow of gas to the pilot and the main burner. The valve consists of: gas regulator, magnetic plug, pilot gas tube, gas valve knob, pilot adjustment cap and screw, gas outlet and inlet ports, thermocouple connector, and electrical connection. The gas control valve also has a dial reference point - OFF/PILOT/ON.

The components of the gas control valve can be serviced without removing the complete valve from the fryer.

### **Safety Precautions**

#### **NOTICE**

If converting from natural gas to propane gas or from propane gas to natural gas, conversion must be done by a qualified technician.

#### **! DANGER** **EXPLOSION RISK**

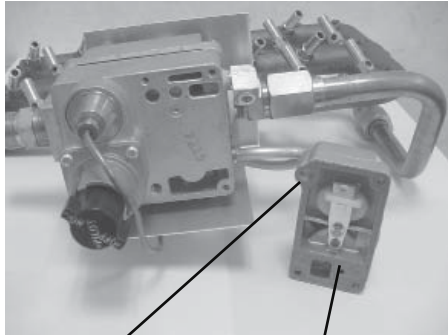
**TO AVOID INJURY OR PROPERTY DAMAGE, BEFORE STARTING THIS PROCEDURE, MOVE THE MAIN POWER SWITCH TO THE OFF POSITION. DISCONNECT THE MAIN CIRCUIT BREAKER AT CIRCUIT BREAKER BOX OR UNPLUG THE SERVICE CORD AT THE WALL RECEPTACLE. TURN OFF THE MAIN GAS SUPPLY LINE TO FRYER. DISCONNECT AND CAP THE SUPPLY LINE TO FRYER, OR EXPLOSION COULD RESULT.**

If the gas control valve must be replaced, remove per paragraph 2-10.

### **Operator Replacement**

1. Depress the gas valve knob and turn to the OFF position.
2. Remove control panel per paragraph 2-4.
3. Label and remove the gas control valve wires.

2-12. GAS CONTROL VALVE (Continued)



**Step 5**

Gasket

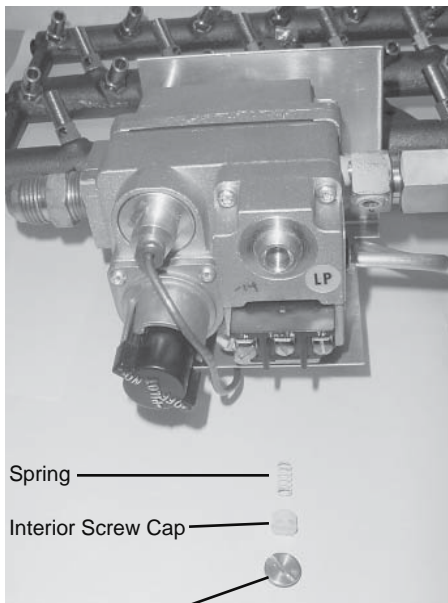
Operator

**Operator Replacement (continued)**

4. Using a T20 “star” screwdriver, remove 4 screws securing the operator and gasket.
5. Secure the new operator and gasket with the four screws provided.
6. Reconnect the gas control valve wires.
7. Install the control panel per paragraph 2-4.

**Check Procedures:**

120 volt - 50/60 Hz	.....	2350 ohms
208-240 volt - 50/60 Hz		880 ohms
24 volt - 50/60 Hz	.....	7 ohms



Spring

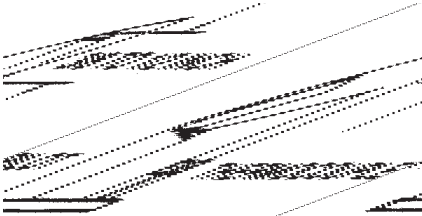
Interior Screw Cap

Exterior Screw Cap

**Regulator Spring Replacement**

1. Remove the screw cap to the regulator.
2. Remove the plastic interior screw cap and spring.
3. Use gas control valve manufacturer’s instructions from the envelope containing the regulator spring, and follow the directions.

**2-12. GAS CONTROL  
VALVE (Continued)**



**Adjusting Pilot Burner**

**NOTICE**

The following two procedures must be performed with the gas supply reconnected and turned on. The service cord must be plugged into the receptacle and the circuit breaker on.

1. The pilot burner is preset at the factory. It may require resetting at the time of installation.
  - a. Remove the pilot adjustment cap.
  - b. Use a small flat screwdriver and rotate the adjustment screw counterclockwise to increase the size of the flame. Rotate clockwise the adjustment screw to decrease the size of the flame.

**NOTICE**

The flame should be set high enough to surround the top of the thermocouple.

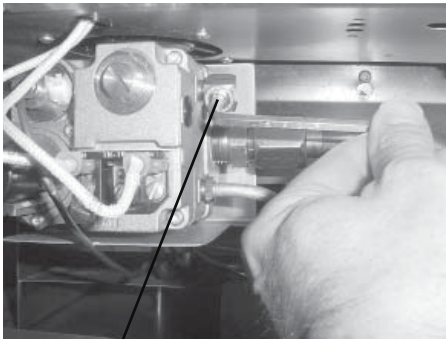
**Adjusting Regulator**

1. The pressure regulator is preset at the factory. It may require resetting at the time of installation.
  - a. Turn gas valve knob to OFF position.
  - b. Attach a manometer to the gas control valve at the pressure tap.
  - c. Turn gas valve knob to PILOT, light, and turn to ON.
  - d. Remove the regulator adjustment screw cap.
  - e. Rotate the adjustment screw counterclockwise to increase the column indicated on the manometer or rotate clockwise to lower the column indicated.
  - f. Turn gas valve knob to OFF and remove manometer.
  - g. Replace the regulator adjustment screw cap.
  - h. Turn gas valve knob to PILOT and relight. Leak test with soap and water solution.

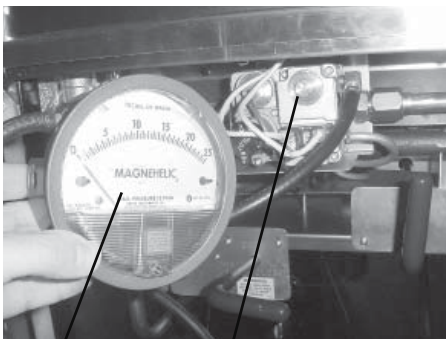
**NOTICE**

Natural gas regulator is factory preset at 3 1/2 inches water column.

Propane gas regulator is factory preset at 10.0 inches water column.



PRESSURE TAP



MANOMETER

REGULATOR  
ADJUSTING  
SCREW

**Step 1a**

2-13. ELECTRICAL COMPONENTS

**Safety Precautions**



**Do not disconnect the ground (Earth) plug. This fryer MUST be adequately and safely grounded (Earthed) or electrical shock could result. Refer to local electrical codes for correct grounding (Earthing) procedures or in absence of local codes, with The National Electrical Code, ANSI/NFPA No. 70-(the current edition). In Canada, all electrical connections are to be made in accordance with CSA C22.1, Canadian Electrical Code Part 1, and/or local codes.**

**NOTICE**

Electric motor bearings are permanently lubricated and do not require attention during the normal service life of this fryer.

**Fan (Gas Models)**

The gas model fryers have a fan in the circuit. This fan operates only with the Main Power switch in the ON position. The fan helps keep the control panel cool by pulling out heat, from between the control panel and frypot.

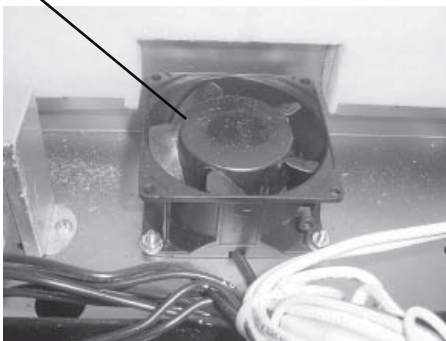
The replacement of a faulty fan is accomplished using following procedure:



**To avoid electrical shock or property damage, move the power switch to OFF and disconnect main circuit breaker, or unplug cord at wall receptacle.**

1. Remove control panel per Removing Control Panel section.
2. Label and disconnect fan motor wires.
3. Remove the four cap screws, washers and nuts securing the fan to the heat shield.
4. Remove the fan from the heat shield.
5. Install the new fan on the heat shield and secure with the four screws, washers, and nuts.
6. Reconnect the fan motor wires.
7. Install control panel per Removing Control Panel section.

FAN



2-13. ELECTRICAL COMPONENTS  
(Continued)

**Drain Switch**

All fryer models have a drain microswitch in line with the gas control valve or heat contactor and the thermostat. When drain valve is opened to drain the shortening, this causes drain switch to open, shutting off electrical power to the heating elements.



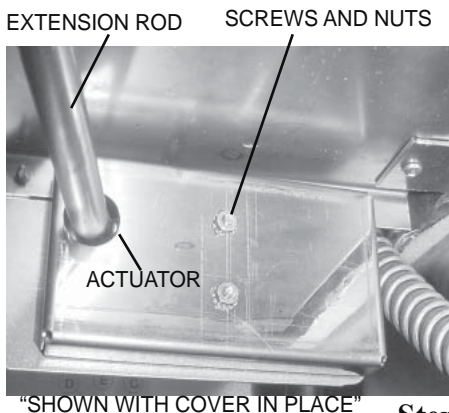
**To avoid electrical shock or property damage, move the power switch to OFF and disconnect main circuit breaker, or unplug cord at wall receptacle.**

1. The following check should be made to determine if the drain switch is defective. All checks should be made with drain valve in closed position, with the actuator pushed in.

- a. Remove drain switch cover on gas fryers.

- b. Remove wires from the switch.

- c. Check for continuity across the middle and normally open terminals on the drain switch. Press on the actuator and if circuit is open, drain switch is bad. The circuit should only be opened by releasing the actuator of the drain switch.



**Step a**

2. To replace the drain switch, remove the two screws and nuts securing switch.

3. Label and disconnect wires.

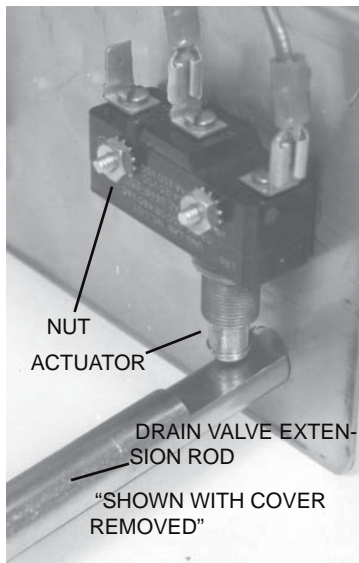
4. Connect wires to new drain switch.

5. Position actuator and attach drain switch and switch cover with two screws and nuts. Tighten nuts to 3 - 4 inch-pounds of torque.

6. Test to see if drain valve extension rod actuates the switch.



Listen for “click” of switch while rotating drain valve extension rod.



**Step 2**

2-13. ELECTRICAL COMPONENTS  
(Continued)

**Cook/Pump Switch**  
**(all models)**

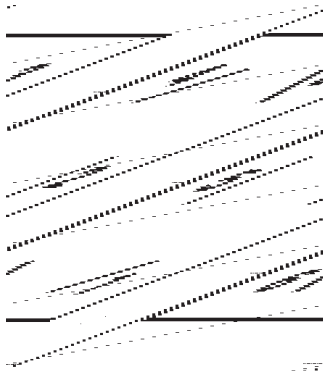
The Cook/Pump switch is a three way switch with a center OFF position. With the switch in the COOK position the fryer will operate. With the switch in the PUMP position the filter pump will operate but the heating unit will not.



**To avoid electrical shock or property damage, move the power switch to OFF and disconnect main circuit breaker, or unplug cord at wall receptacle.**

**Continuity Check Procedure**

1. Remove control panel.
2. Label and remove wires from the switch.
3. OFF position-should be open circuit anywhere on switch.
4. COOK position. Check from: #5 to #6 closed circuit  
#1 to #2 closed circuit
5. Pump position. Check from: #4 to #5 closed circuit  
#3 to #2 closed circuit



**Step 3**

**Replacement**

1. Remove control panel per Replacing Control Panel Section.
2. Label wires at Cook/Pump switch and disconnect wires at switch.
3. Remove faulty switch by pressing in on tabs on the switch, behind the control panel and pull the switch through the front of the panel.
4. Install new switch.
5. Reconnect wires to switch in same position as noted on labels.
6. Replace control.

2-13. ELECTRICAL  
COMPONENTS  
(Continued)

**Fuse Holder(s)**  
**(electric models)**

There are two fuse holders on each model of the electric fryers. There are no fuse holder assemblies for the gas models other than that at the main power source.

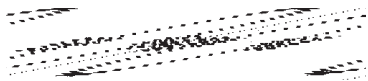


**To avoid electrical shock or property damage, move the power switch to OFF and disconnect main circuit breaker, or unplug cord at wall receptacle.**

**Checking Procedure for Fuses**

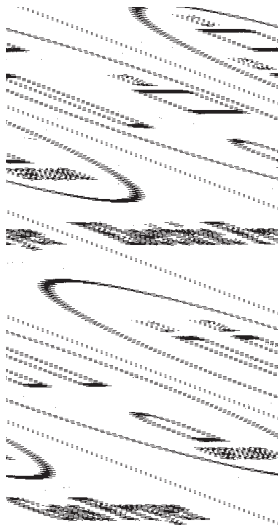
CONTROL PANEL FUSES 3 Phase

Check from #54 to #55 and #68 to #69 on fuse assembly. The circuit should be closed. If not, replace the fuse (HP# EF02-007).



**Cord and Plug Check**

Perform a check on the cord and plug as follows. Test from each plug prong to the corresponding wire lead on the other end of the cord at junction box. The result should be a closed circuit on each line tested.



**Wall Receptacle**  
**(voltage check)**

Check the voltage across the following lines:

L1-L2; L2-L3, L1-L3.

The voltage should read the same for each line test. It should correspond to the voltage shown on the data plate.

Check the voltage across line L1 and L2.

The voltage should correspond to the voltage shown on the data plate.



2-14. PRESSURE  
REGULATION/  
EXHAUST

**Solenoid Valve**

This is an electromechanical device that causes pressure to be held in the frypot. The solenoid valve closes at the beginning of the cook cycle and is opened automatically by the timer at the end of the cook cycle. If this valve should become dirty or the teflon seat nicked, pressure will not build up. The solenoid valve used on all models is the same with the exception of the coil. The gas model fryer uses a 120 volt, 60 Hz, coil. The electric model fryer uses a 208/240 volt 60 Hz coil. The 440/480 volt electric model uses a transformer to drop voltage to 220/240 volts.



**To avoid electrical shock or property damage, move the power switch to OFF and disconnect main circuit breaker, or unplug cord at wall receptacle.**

**Coil Check Procedure**

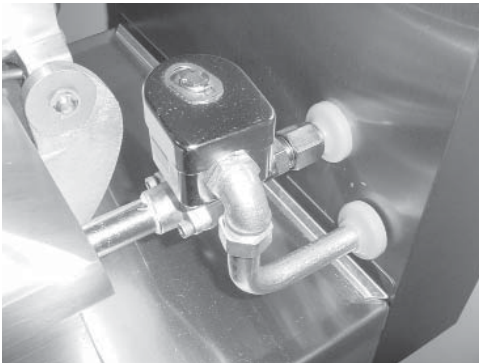
1. Remove the cover of the junction box in the rear of the fryer. Locate the solenoid wires and remove them from the wire-nuts. Check the ohms of the solenoid coil by checking across the solenoid wires. Use chart below:

<u>Test Volts/Phase</u>	<u>Results</u>
120 volt 60 Hz	50 ohms
208-240 volt 60 Hz	150 ohms
208-240 volt 50 Hz	245 ohms

2-14. PRESSURE REGULATION/  
EXHAUST (Continued)

**Replacement**

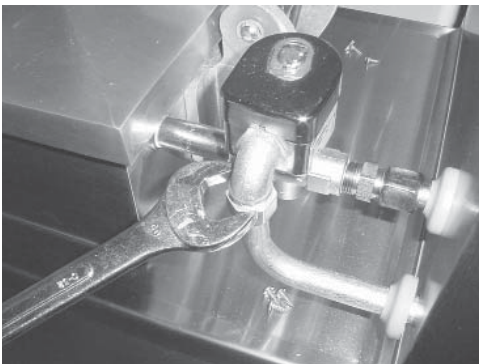
**Solenoid Valve Assembly**



1. Remove Tru-Arc retaining clip on top of the coil housing.
2. Remove the nameplate and cover.
3. If only the coil is replaced, disconnect two coil wires at the wire nuts in the coil housing, and remove the coil from the housing. Then replace nameplate, cover, and Tru-Arc clip.

If complete solenoid, or seals are being replaced, continue on to step 4.

**Conduit Connector**



**Step 4**

**NOTICE**

The wires may be connected in any order.

4. Loosen nut on 1/2 inch connector and pull piping conduit from the valve case. Leave enough slack to remove the coil housing and yoke.

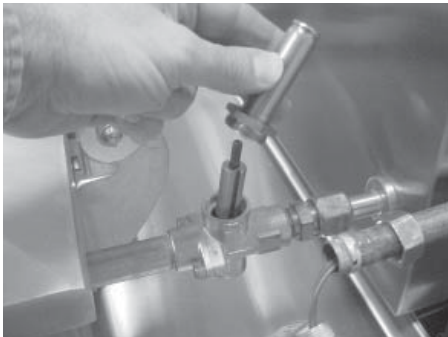
2-14. PRESSURE  
REGULATION/  
EXHAUST (Continued)

5. If the core-disc assembly is sticking due to buildup of shortening, breadings and food particles proceed with the following steps.



**Step 5a**

- a. Unscrew the solenoid bonnet assembly from the solenoid valve body.



**Step 5b**

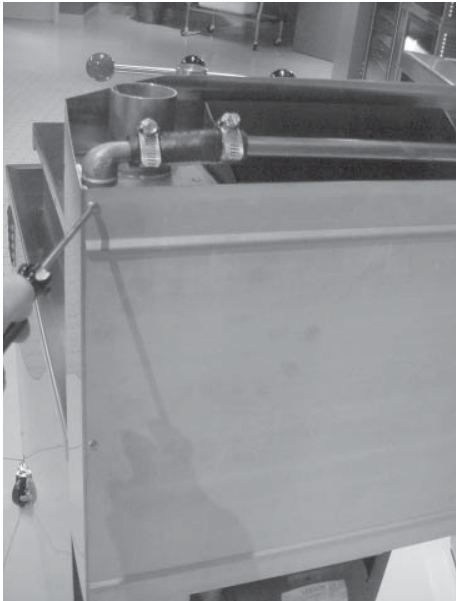
- b. Remove the solenoid bonnet assembly and the bonnet gasket.



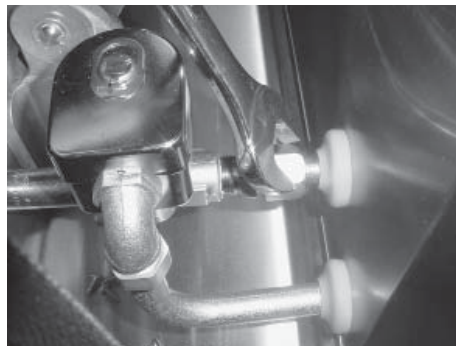
**Step 5c**

- c. Remove the core-disc assembly, core spring retainer, and the core spring.

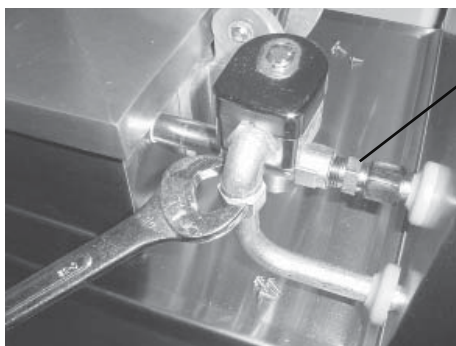
2-14. PRESSURE  
REGULATION/  
EXHAUST (Continued)



**Rear Cover Step a**



**Exhaust Fitting Step b**



**Conduit Fitting Step c**

- d. Wash all parts in soap and hot water.

**NOTICE**

If replacing Teflon seals, or complete valve, proceed to step 6, otherwise, assemble in reverse order of disassembly.

Assemble valve core and blade (6), with the smooth side of the hole towards the disc spring guide (9).  
(See drawing on next page)

- 6. A repair kit (Part No. 17120) is available if any of the seals are replaced. If any one seal is defective, all seals should be replaced.

**NOTICE**

Remove the solenoid body from fryer to replace seals. Refer to exploded view of solenoid on page 3-14 to help identify all parts.

- a. Remove back cover.

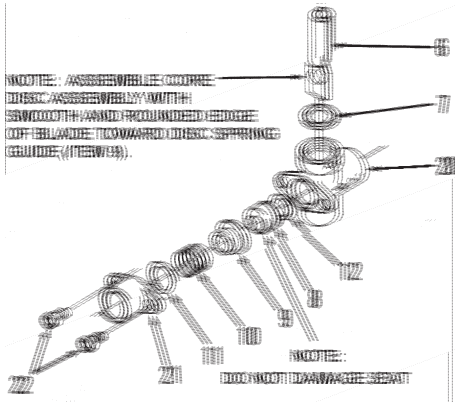
- b. Loosen both conduit and exhaust fittings.

- c. Remove nipple from solenoid body.

- d. Unthread body from fryer.

- e. A new solenoid can now be placed on the fryer, and reassembled in reverse order of previous steps, or continue on to step 7 to change the seals.

2-14. PRESSURE  
REGULATION/  
EXHAUST (Continued)



7. To change seals:
- a. Remove the two adapter screws (22) which attach the pipe adapter (21) to the solenoid body (20).
  - b. Remove disc spring (10), guide (9), and Teflon seat (8).
  - c. Clean the valve body.
  - d. Wet O-ring (12) around seat with water and insert O-ring assembly (flat side first) in valve, through IN side of body. Use a pencil eraser, and press in Teflon seat until it snaps into place. Be careful not to mark or nick seat.

**NOTICE**

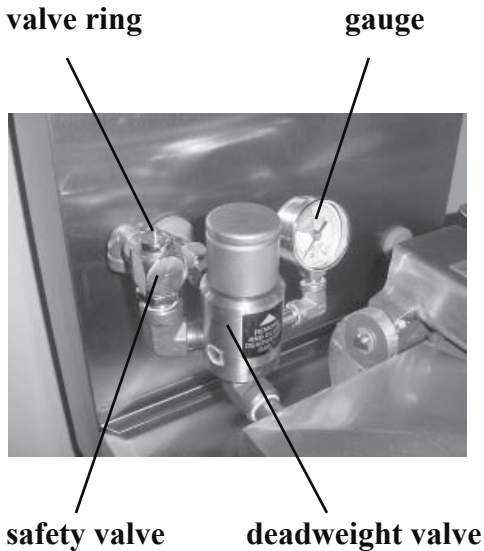
The smallest nick can cause a pressure leak. Replace all O-ring seals, found in the parts kit, and reassemble valve.

2-14. PRESSURE  
REGULATION/  
EXHAUST (Continued)

**Deadweight Valve**



**DO NOT ATTEMPT TO REMOVE THE VALVE CAP WHILE THE FRYER IS OPERATING. SEVERE BURNS, OR OTHER INJURIES COULD RESULT.**



The deadweight valve and safety relief valve are located side by side at the back of unit. The valve next to the pressure gauge is the operating control valve, and the other valve is a 14 1/2 lb. safety relief valve.

Valves are working properly, when OPERATING ZONE is indicated on gauge by the pointer. The gauge pointer should not normally exceed operating zone. At 14 1/2 psi, the safety relief valve opens to release steam pressure from the frypot.

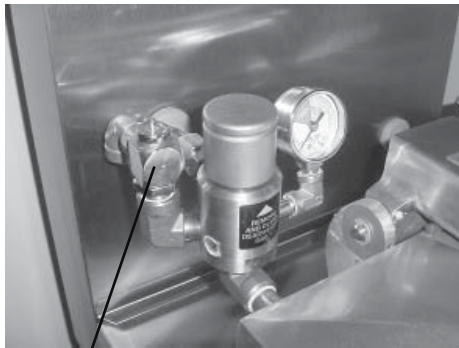


**DO NOT MANUALLY ACTIVATE THE SAFETY RELIEF VALVE. HOT STEAM RELEASES FROM THE VALVE WHEN THE RING IS PULLED. KEEP BODY PARTS AWAY FROM SAFETY VALVE EXHAUST, OR SEVERE BURNS COULD RESULT.**

**Cleaning Steps**

1. Clean the deadweight valve, at the end of each day. Turn the fryer OFF and release all the pressure. Open the lid and then remove the deadweight valve cap and deadweight.
2. Place both the cap and weight in hot detergent water and clean. Make certain to thoroughly clean inside cap, the weight seat, and around the deadweight orifice.
3. Rinse thoroughly with hot water. Dry parts and replace immediately to prevent damage or loss.

2-14. PRESSURE  
REGULATION/  
EXHAUST (Continued)



safety valve

**Removal and Cleaning  
of Safety Relief Valve**

The safety relief valve should be cleaned once a year.



**DO NOT ATTEMPT TO REMOVE VALVE WHILE  
FRYER IS OPERATING. SEVERE BURNS OR OTHER  
INJURIES COULD RESULT.**

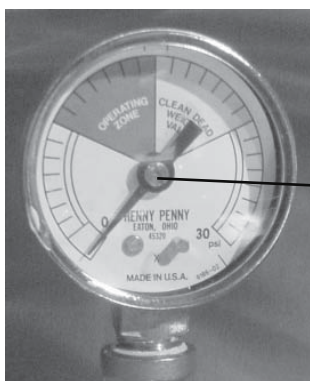
1. Open the lid and then remove the deadweight valve cap and deadweight.
2. Use a wrench to loosen the valve from the pipe elbow, turn counterclockwise to remove.
3. Clean the inside of the pipe elbow with hot detergent.
4. Immerse the safety relief valve in a soap water solution for 24 hours. Use a 1:1 dilution rate. The valve cannot be disassembled. It is factory preset to open at 14 1/2 pounds of pressure. If it does not open or close it must be replaced.



**TO AVOID PERSONAL INJURY, DO NOT DISASSEMBLE OR MODIFY THIS VALVE. TAMPERING WITH THIS VALVE WILL VOID AGENCY APPROVALS AND THE APPLIANCE WARRANTY, AND COULD CAUSE SERIOUS INJURIES.**

**Pressure Gauge**

The pressure gauge can be recalibrated should it be out of adjustment.



ADJUSTING  
SCREW

Step 2

**Calibration Steps**

1. Remove the rim and glass.
2. If the indicating hand shows a pressure or vacuum reading when it should stand at "0", turn the recalibrator screw in the same direction in which the indicating hand is to be moved until the hand stands at proper "0" position.
3. Replace the rim and glass.

2-14. PRESSURE  
REGULATION/  
EXHAUST (Continued)

**Pressure Gauge Cleaning Steps**

1. Remove gauge and check inside the pipe fittings from dead weight body. Make certain fittings are clean and open.
2. Clean and reinstall the gauge.

**Condensation Box Assembly**

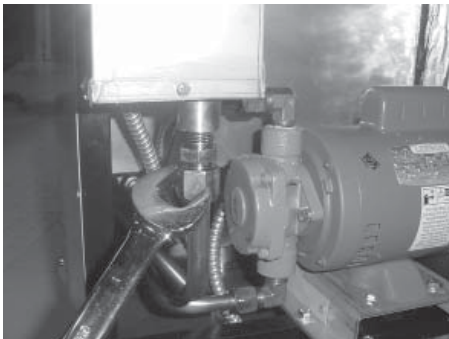
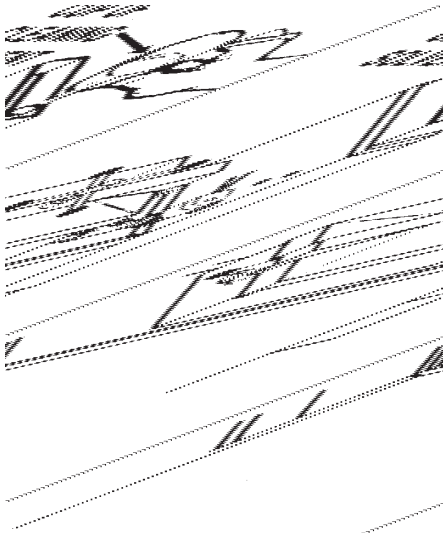
The deadweight valve and solenoid exhausts are directed into a condensation box, located in the rear of the fryer. Should this box become clogged, water would spew from the top of the box. The box can be cleaned by running a wire or long brush from the top of the box, through hole in the bottom of the box, or the bottom of the box can be removed to clean.

**Condensation Box Bottom Removal**  
Model 500-SN: KB021JB to HB013JB  
Model 600-SN: KA021JJ to GA085JB

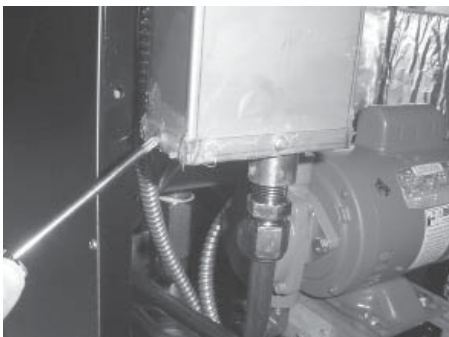
**NOTICE**

When cleaning the frypot, pour a cup of cleaning solution into the large exhaust hose at the top of the exhaust tank (see figure at left). This helps prevent the box from getting clogged.

1. Loosen fitting at the bottom of the box.
2. Using a Phillips head screwdriver, remove 4 screws securing the bottom of the box and pull bottom from assembly.
3. Clean outlet hole in box bottom and check condensation tube for clogs, and clean if necessary.
4. Reinstall box bottom and condensation line.
5. Seal box bottom with silicone sealant and unit is now ready for operation.



**Condensation Box Fitting Step 1**



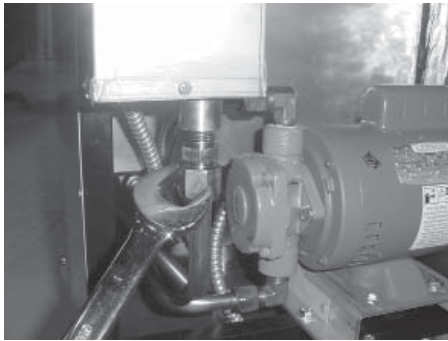
**Condensation Box Bottom Step 2**



2-14. PRESSURE  
REGULATION/  
EXHAUST (Continued)

**Condensation Box Disassembly  
Model 500-SN: HB014JB & Above  
Model 600-SN: GA086JB & Above**

Should the condensation box become clogged on these fryers, disassemble the condensation box as follows:



**Step 1**

1. Loosen fitting at the bottom of the box.

2. Remove the rear cover.



**Step 2**

3. Loosen hose clamp on the upper condensation line and pull the hose from the elbow.

4. Using a Phillips head screwdriver, remove screws securing the bottom of the box and pull bottom from assembly.

5. Cut the silicone seal between outside and inside panels of condensation box, and pull the inside from the outside panel.

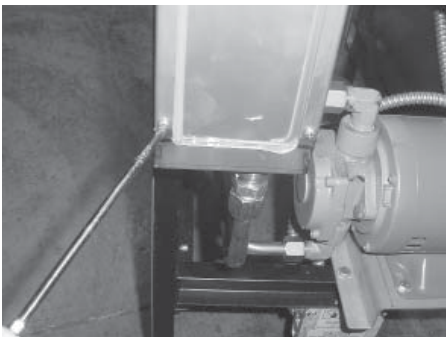


**Step 3**

6. Clean outlet hole in box bottom and check the condensation tube for clogs, and clean if necessary.

7. Reinstall the inside panel of the box to the outside panel.

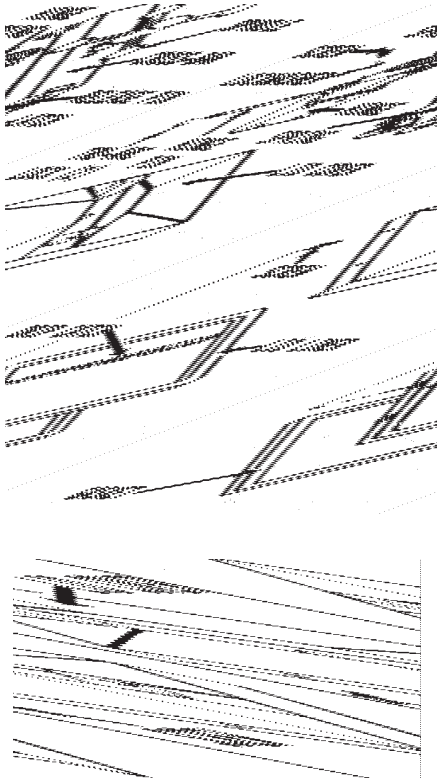
8. Reinstall the condensation hose.



**Step 4**

9. Seal box with silicone sealant and unit is now ready for use.

**2-14. PRESSURE  
REGULATION/  
EXHAUST (Continued)**



**Lid Cover Assembly**

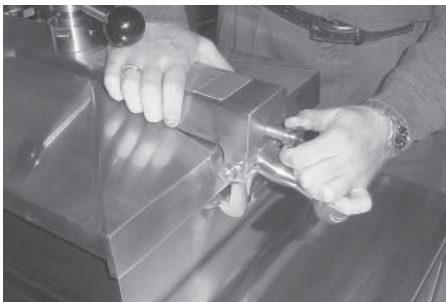
**Description**

Generally, the lid spindle, the limit stop, the cover, the hinge, the inner and the reversible gasket comprise the lid cover assembly.

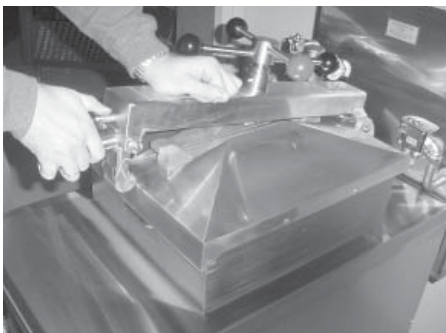
**Lid Cover Removal**

The lid cover is easily removable for cleaning or service.

1. Close lid cover and turn the spindle counterclockwise until it stops.
2. Pull the lid release pin on front of crossbar, lift the latch, and raise the crossbar.
3. The cover can now be removed from frypot.

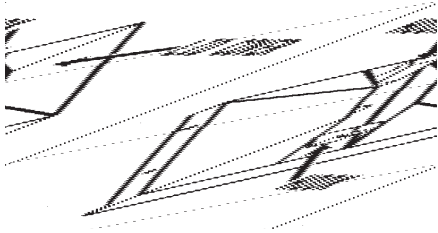


**Step 2**



**Step 3**

2-14. PRESSURE  
REGULATION/  
EXHAUST (Continued)



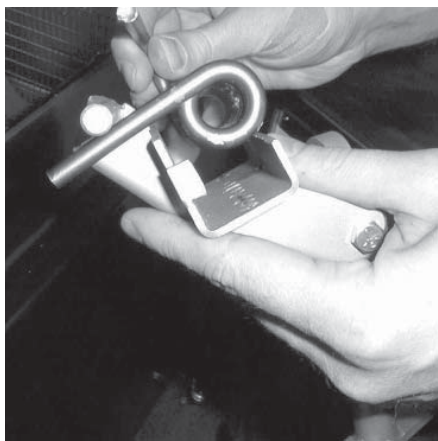
**Lid Cover Installation**

1. Place the lid cover on the frypot.
2. Thread the spindle counterclockwise until it is completely extended.
3. Align rear retaining hook on the lid cover in the center slot of the crossbar. Push the cross bar down and pull out on lid release pin.
4. Push the lid to rear of frypot and latch the cross bar to the lid cover. Release the pin.
5. Check that lid cover is fastened properly before raising.

**Lid Hinge Spring**

The hinge spring needs to be replaced if it is broken, cracked or otherwise loses its tension. A special spring installation tool greatly simplifies this procedure is available from the factory. (Henny Penny part number 21642)

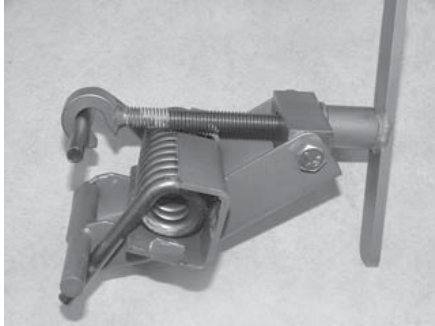
1. Pull out on retaining pin knob on the front of the cross bar to release lid cover. (Refer to lid cover removal instructions.)
2. Lift the cross bar up and away from the lid.
3. Remove the tru-arc locks and hinge pin if spring is broken. If the spring is not broken, use spring tool as described in steps 5, 6, and 7, then remove Tru-Arc lock and hinge pin.
4. Remove the broken spring.
5. The new spring is placed in loading tool so the spring coil is laying in the u-shaped center of tool. The perpendicular shaft is placed in stationary hook of the tool, and the parallel shaft is placed so the adjustable hook will tighten it down.



**Step 5**

2-14. PRESSURE  
REGULATION/  
EXHAUST (Continued)

**Lid Hinge Spring  
(Continued)**



**Step 6**

6. Tighten the handle on the tool as far as it will go.



**Step 7**

7. Place the spring (loaded in the tool) into position so that the u-shaped center of tool is toward the front of the fryer and the tool handle is toward the top of the fryer.

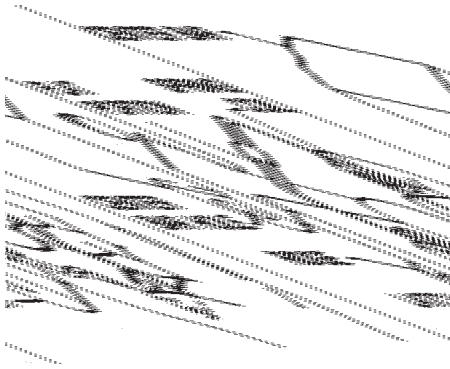
8. Replace hinge pin and Tru-Arc locks. Loosen and remove the tool.

9. Refer to the lid installation procedure and reinstall the lid.

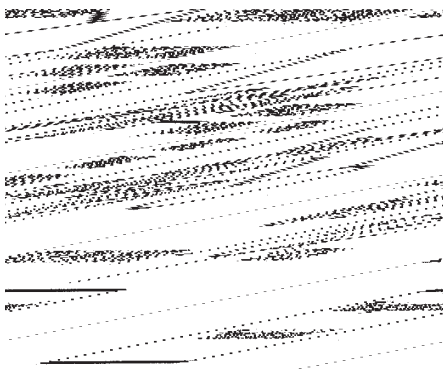
2-14. PRESSURE  
REGULATION/  
EXHAUST (Continued)

**Latch Spring  
Installation**

The latch on the crossbar must have the external coil-type latch spring mounted on the latch pin. If a latch spring is weak or broken, it must be replaced with a new spring, part number 33480.

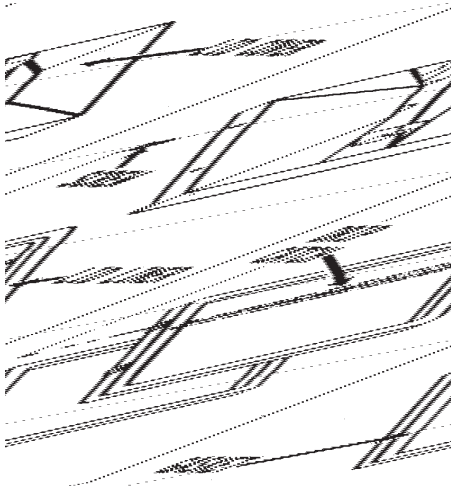


**To avoid severe burns and injuries make sure the lid is secure during a cook cycle. The latch spring must be in good working order and properly installed. (Refer to illustrations at left.) If the latch spring is weak, broken, or mounted backwards, it will provide little force against the latch.**



1. Replace the crossbar from the lid. (Refer to previous steps on Lid Cover Removal.)
2. With the crossbar in the upright position, remove one of the two Tru-Arc rings from latch pin.
3. Tap out pin from latch while grasping latch, and remove latch and latch spring.
4. Install new latch spring with the coils of spring extending forward. (Refer to illustrations at left.)
5. Secure spring in place with Tru-Arc ring.

2-14. PRESSURE  
REGULATION/  
EXHAUST (Continued)



**Lid Liner**

1. Remove the four lid liner screws.
2. Use a thin blade screwdriver to pry lid liner from the cover.
3. Clean the liner and the inside of the cover. Replace the liner and screws.

**Reversing the  
Lid Gasket**

The gray rubber gasket surrounding the inside of lid is designed to be reversed. Henny Penny recommends that this be done on a quarterly basis.

**Purpose**

Because of heat expansion and the pressure used for the cooking process, the gasket is constantly under extreme stress. Reversing the lid gasket on a quarterly basis will help to assure that the fryer will not lose pressure through leakage.

2-14. PRESSURE  
REGULATION/  
EXHAUST (Continued)

**Reversing the Lid Gasket**  
**(Continued)**



**Step 1**

1. There are two lid liner screws on either side of the lid cover. Back these four screws out about 1/2 inch.



**Step 2**

2. Open lid and, using a thin blade screwdriver, pry out the gasket at the corners. Remove the gasket.
3. Clean the gasket and gasket seat with hot water and cleaning detergent. Rinse with clean hot water.
4. Install the gasket with the good side facing out. Tighten the four screws.

2-14. PRESSURE  
REGULATION/  
EXHAUST (Continued)



**Reversing the Lid Gasket  
(Continued)**

**NOTICE**

Begin the installation by installing the four corners of the lid gasket.

**Lid Limit Stop Adjustment**

The lid limit stop, with proper adjustment, prevents unnecessary overtightening of the spindle, and as a result, extends the life of the lid gasket.



**Step 1**



**Step 2**

1. Loosen the Allen set screws on the bottom of the collar of the limit stop assembly.
2. Turn the inner collar of the limit stop clockwise as far as possible. Find small hole in the inner collar and use a small Allen wrench or Phillips head to help in turning the collar.
3. Close lid and turn spindle until lid gasket meets top of the frypot rim.
4. From this position, turn spindle at least 3/4 of a turn, but not over one full turn.
5. After rotating spindle to this point, slightly extend spindle past this position. The spindle should then be at the seven o'clock position.

**NOTICE**

The seven o'clock position is only to allow slight additional turning of the spindle to relieve any side pressure that could hold the locking pin in the locking collar after all pressure has been released from the frypot.



2-14. PRESSURE  
REGULATION/  
EXHAUST (Continued)

**Lid Limit Stop  
Adjustment (Continued)**

It may be necessary to remove knobs and change their position in order to align the red knob with the red knob on the lid cover lid latch. When in the normal operating position, both red knobs should be aligned.

6. Adjust the limit stop by turning it counterclockwise until it stops against the bottom hub of the spindle.
7. Tighten Allen set screws.
8. If the lid cover fails to seal properly, steam will escape around the gasket during the frying operation. The limit stop should be readjusted. This time turn the spindle screw one full turn after the initial contact of the lid gasket against top of the frypot rim.

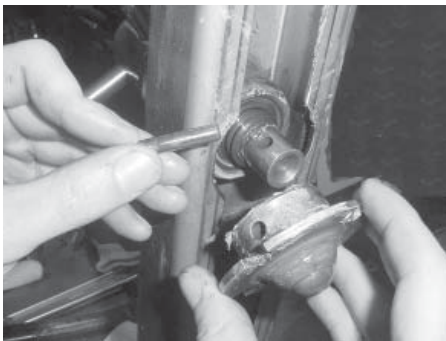
**Spindle Screw Assembly**

This assembly is used to tighten the lid cover against the frypot flange.

1. Loosen the set screw in the limit stop collar and loosen the limit stop.
2. Disengage the crossbar from the lid cover as described in the "Lid Cover Removal". Leave the lid cover in position on the frypot rim with the crossbar in the upright position.
3. Turn the spindle so the pin in the locking collar will be exposed.
4. Remove pin and locking collar. Use a small diameter punch and a hammer to drive out the pin from the locking collar. Remove the locking collar.

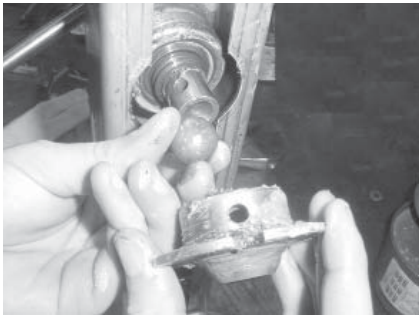


**Step 3**



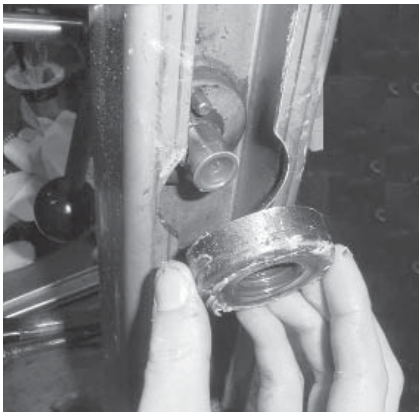
**Step 4**

2-14. PRESSURE  
REGULATION/  
EXHAUST (Continued)



**Step 5**

5. Remove the ball from the locking collar. This may be accomplished by lightly tapping steel ball with a hammer.



**Step 6**

6. Remove and inspect the idle nut.



**Step 7**

7. Thread the spindle out of the acme nut.



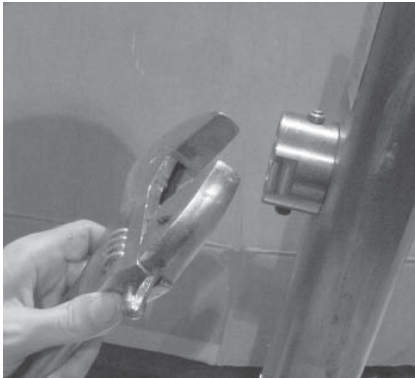
**Step 8**

8. Loosen the Allen set screw in the outer ring of limit stop. Thread the inside portion up and down several times to check for ease of operation. If thread feels tight or must be forced, threads may be damaged. Discard and replace with new limit stop assembly.

2-14. PRESSURE  
REGULATION/  
EXHAUST (Continued)

**NOTICE**

The acme nut must be changed when there is excessive play and movement between the spindle and the acme nut.



**Step 9**

9. Using a nylon tape type wrench unthread the limit stop collar from the acme nut.



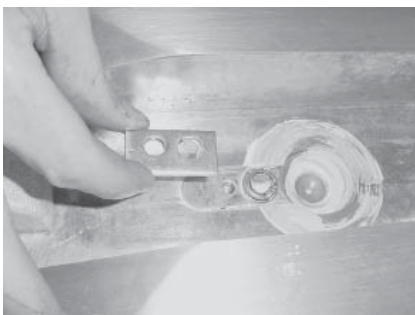
**Step 10**

10. Gently tap the acme nut from the center crossbar. Inspect the acme nut for thread damage. If the threads are thin and sharp or worn, replace with a new acme nut.



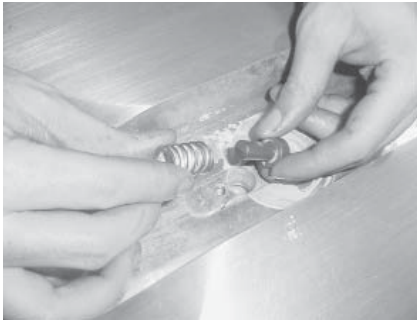
**Step 11**

11. Use an Allen wrench and ratchet to remove the retainer.



**Step 11**

2-14. PRESSURE  
REGULATION/  
EXHAUST (Continued)



**Step 12**

12. Remove the locking pin and spring. Inspect and replace if necessary.

**NOTICE**

When reinstalling the locking pin, be certain it is put back in its original position. The angled side of the pin should be to the right.



**Step 13**

13. Use a magnet to remove the ball seat. Inspect and replace if necessary.



**Step 13**

14. Install the acme nut and limit stop collar. Lubricate the acme nut with a special grease (product number 12124).

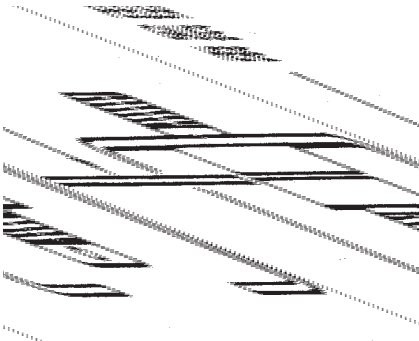
15. Thread the limit stop assembly into the limit stop collar.

16. Lubricate the spindle with special grease (product number 12124) every 30 days.



**Step 16**

2-14. PRESSURE  
REGULATION/  
EXHAUST (Continued)



2-15. FILTERING SYSTEM

17. Slip spindle through limit stop, hold idle nut against acme nut, and thread spindle through both. There should be 20 to 60 thousandths between acme nut and idle nut. To increase dimension, turn idle nut counterclockwise; to decrease turn clockwise.
18. Install the locking collar, locking pin and ball. Install the ball seat in the lid. Install the retainer and spring.
19. Reassemble the crossbar to the lid cover according to the “Lid Cover Installation” procedure.
20. Readjust the lid limit stop during the test cook cycle.

**Filter Rinse Hose**

The filtering system consists of the filter valve, motor and filter pump assembly, filter screen assembly, and tubing.



**SHORTENING WITH TEMPERATURE IN EXCESS OF 200°F FLOWS THROUGH THIS FILTER RINSE HOSE. HEAT CAUSES THE RUBBER HOSE TO AGE AND DETERIORATE. SEVERE BURNS WILL RESULT IF THIS RINSE HOSE ASSEMBLY LEAKS OR RUPTURES. THE HOSE AND FITTINGS SHOULD BE CHECKED DAILY. IF AGING OR DISCOLORATION IS SEEN, THE HOSE SHOULD NOT BE USED.**

**Removal**

1. Close the filter valve.
2. Turn the pump switch to the OFF position.
3. Detach the hose.



**THE HOSE AND FITTING WILL BE HOT. USE PROTECTIVE GLOVES OR CLOTH WHEN FOLLOWING THIS PROCEDURE, OR SEVERE BURNS COULD RESULT.**



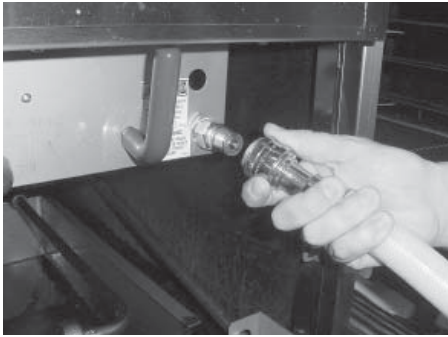
This hose is not connected to fryer during normal operation.



**Step 3**

## 2-15. FILTERING SYSTEM

(Continued)



Step 1

### Installation

1. Attach the filter rinse hose with its quick disconnect female fitting to the other half male fitting inside the door, next to the filter valve handle.
2. To do this slide back the spring ring on the female end of the quick disconnect fitting and let it snap into place over the other half male fitting.
3. With a quick tug on the hose, insure the quick disconnect is locked into position.

### Filter Valve Description

The filter valve is a 3/8 inch two-way stainless steel ball valve. If this valve should develop leaks the entire valve must be replaced.



**To avoid electrical shock or property damage, move the power switch to “OFF” and disconnect main circuit breaker, or unplug cord at wall receptacle.**

### Removal

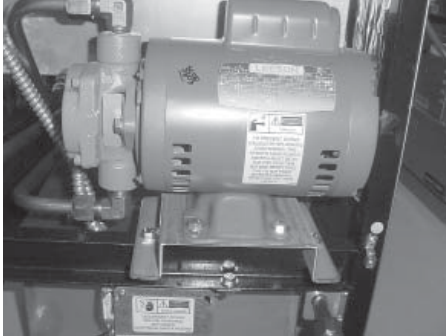
1. Drain the shortening from the frypot.
2. Remove the filter drain pan from the fryer.
3. Remove the cotter pin, handle, and extension rod.
4. Remove the pipe from between the filter pump and valve.

### NOTICE

If fryer is equipped with optional filter rinse hose attachment, disconnect pipe from filter valve.

5. Use an adjustable wrench and remove the valve.
6. Replace the valve and reassemble in reverse order.

**2-15. FILTERING SYSTEM**  
**(Continued)**



**Filter Pump Repair**

The two most common causes for a fryer's inability to pump shortening is that the pump is clogged with breading or solid shortening has cooled and solidified in the lines and pump.



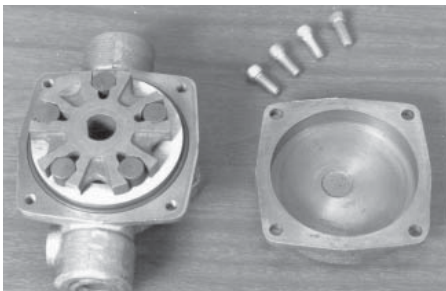
**To avoid electrical shock or property damage, move the power switch to OFF and disconnect main circuit breaker, or unplug cord at wall receptacle.**



**Step 1**

**Cover Removal**

1. Loosen the four Allen head screws on the end of pump and remove the cover.
2. The inside is now exposed leaving a rotor and five teflon rollers. Clean the rotor and rollers.
3. To reassemble, place rotor on drive shaft, and place roller into rotor.



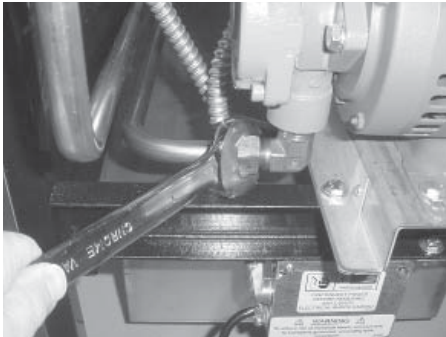
**Step 2**

**NOTICE**

A small amount of grease might be needed to hold the bottom roller into place until cover plate is put on. Make sure O-ring is in proper position on plate.

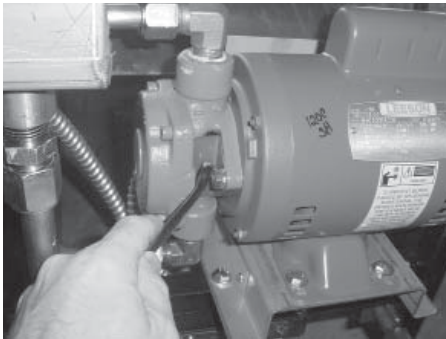
2-15. FILTERING SYSTEM  
(Continued)

**Pump Removal**



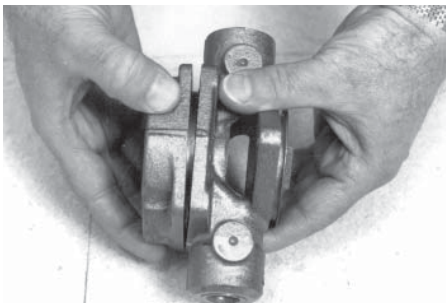
**Step 1**

1. If the pump needs to be replaced, loosen one inch nuts from the outflow and inflow lines. Then remove the two bolts holding the pump to the motor with a 1/2 inch wrench.
2. The shaft seal should remain on motor shaft, or if leaking, could be replaced at this time.



**Step 2**

3. To replace the pump, remove the four Allen screws, front plate, rotor, and rollers from pump. Place the pump onto shaft and against the shaft seal. Place the two 1/2 inch bolts through the pump and into the motor and tighten. Then replace rotor, rollers, front plate and tighten Allen screws.



**CAUTION**

*When removing a pump from a motor, note the positions of the inlet and outlet parts. Installation of the pump on the motor in any other position could cause damage to the fryer. There is an indicator on the side of the two halves of the pump, this mark must be together and face to the front of the fryer.*



2-15. FILTERING SYSTEM  
(Continued)

**Pump Removal**  
**(Continued)**

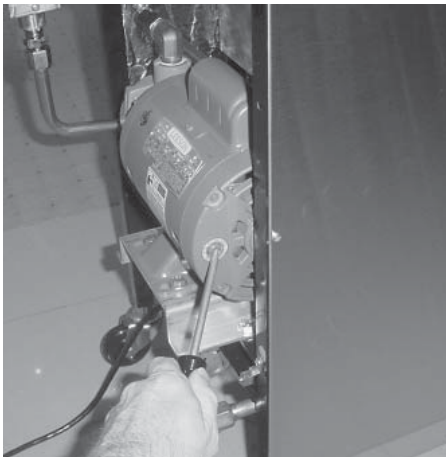
4. To replace the pump and motor assembly, insure the main power has been removed from the fryer.



**To avoid electrical shock or property damage, move the power switch to OFF and disconnect main circuit breaker, or unplug cord at wall receptacle.**

5. Remove the cover from the junction box and remove the wire nuts attaching wires leading into the flexible conduit going to the motor.
6. Loosen the two screws securing the flexible conduit to the 90° conduit connector (8). (Refer to Figure 3-25.)
7. Remove tubing to the pump. (Refer to Figures 3-21 and 3-24.)
8. Remove hardware attaching the motor to the motor base bracket and remove motor and pump assembly.

**Filter Pump Motor**  
**Protector - Manual Reset**



The filter pump motor is equipped with a manual reset button in the event the motor's thermal protector actuates. This reset button is located on the rear of the motor. Wait approximately 5 minutes before attempting to reset this protector device.



**To prevent burns caused by splashing shortening, the unit's main power switch must be in the OFF position before resetting the filter pump motor's manual reset protection device.**

## 2-16. GAS CONVERSION

Gas model fryers are factory available for either natural gas or propane gas. Factory conversion kits for natural gas and propane gas are available that require the burner jets, pilot jet and regulator assembly to be changed.

Refer to the Technical Manual illustrated parts breakdown for kit identification.



**Conversion must be accomplished by an authorized Henny Penny dealer or service representative, or personal injury could result.**

### **Service Hints**

On natural gas installation, the gas pressure regulator on the automatic gas control valve is factory set at 3.5 inch water column.

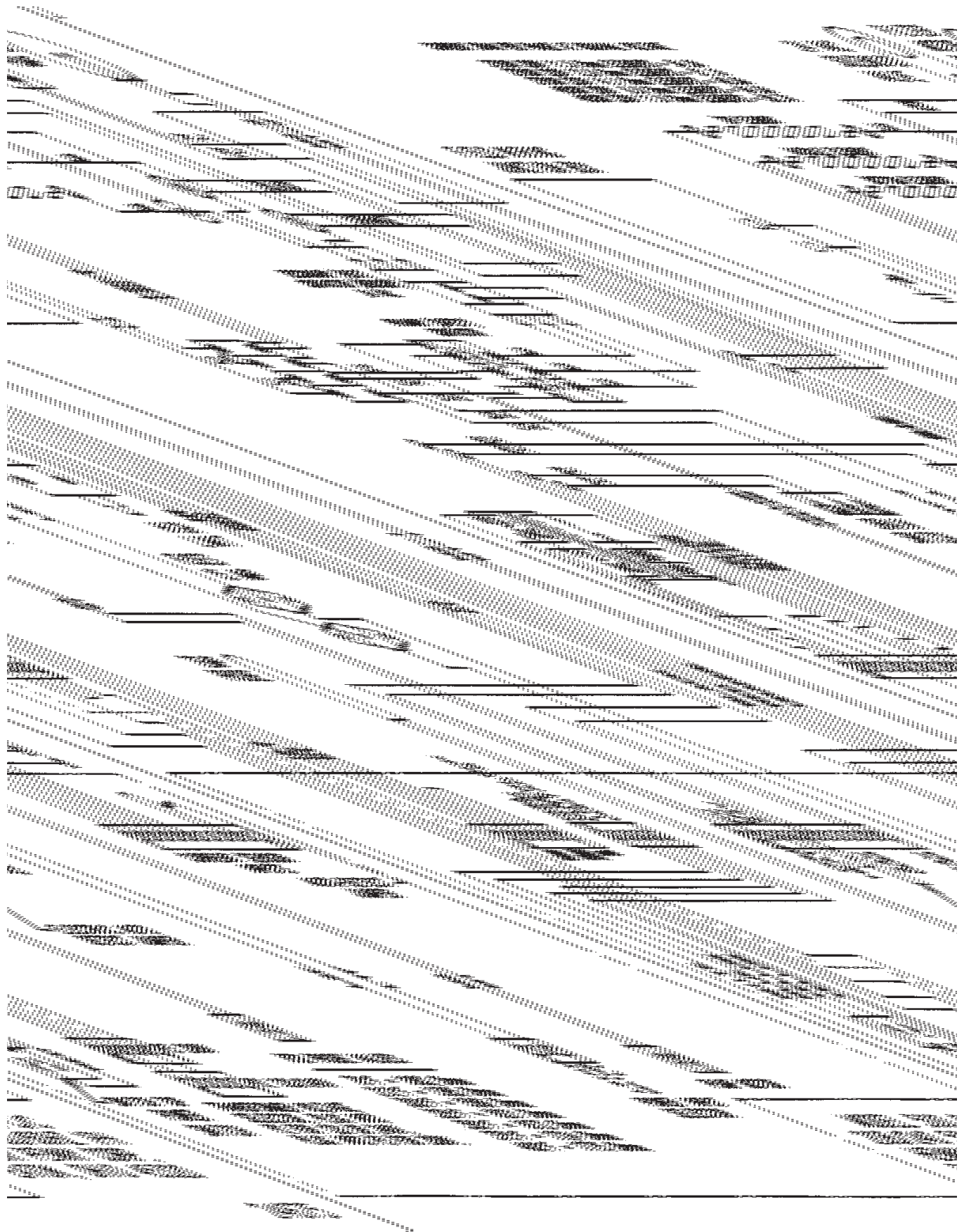
On propane gas installations, the gas pressure regulator on the automatic gas control valve is factory set at 10.0 inch water column.

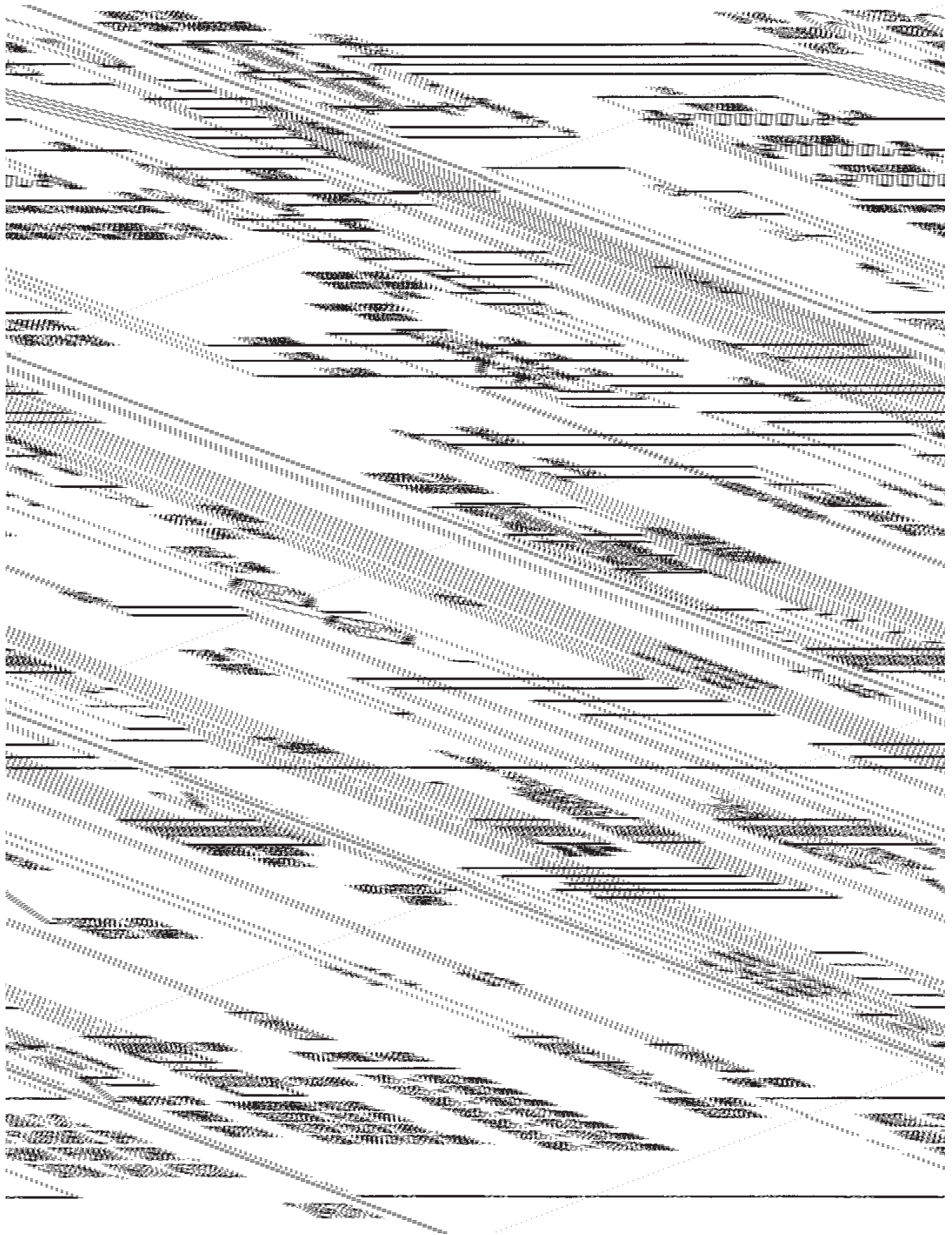
After converting the fryer, turn on the gas supply and check for leaks. A simple method is to brush all the connections with soapy water, and watch for bubbles which indicate escaping gas.

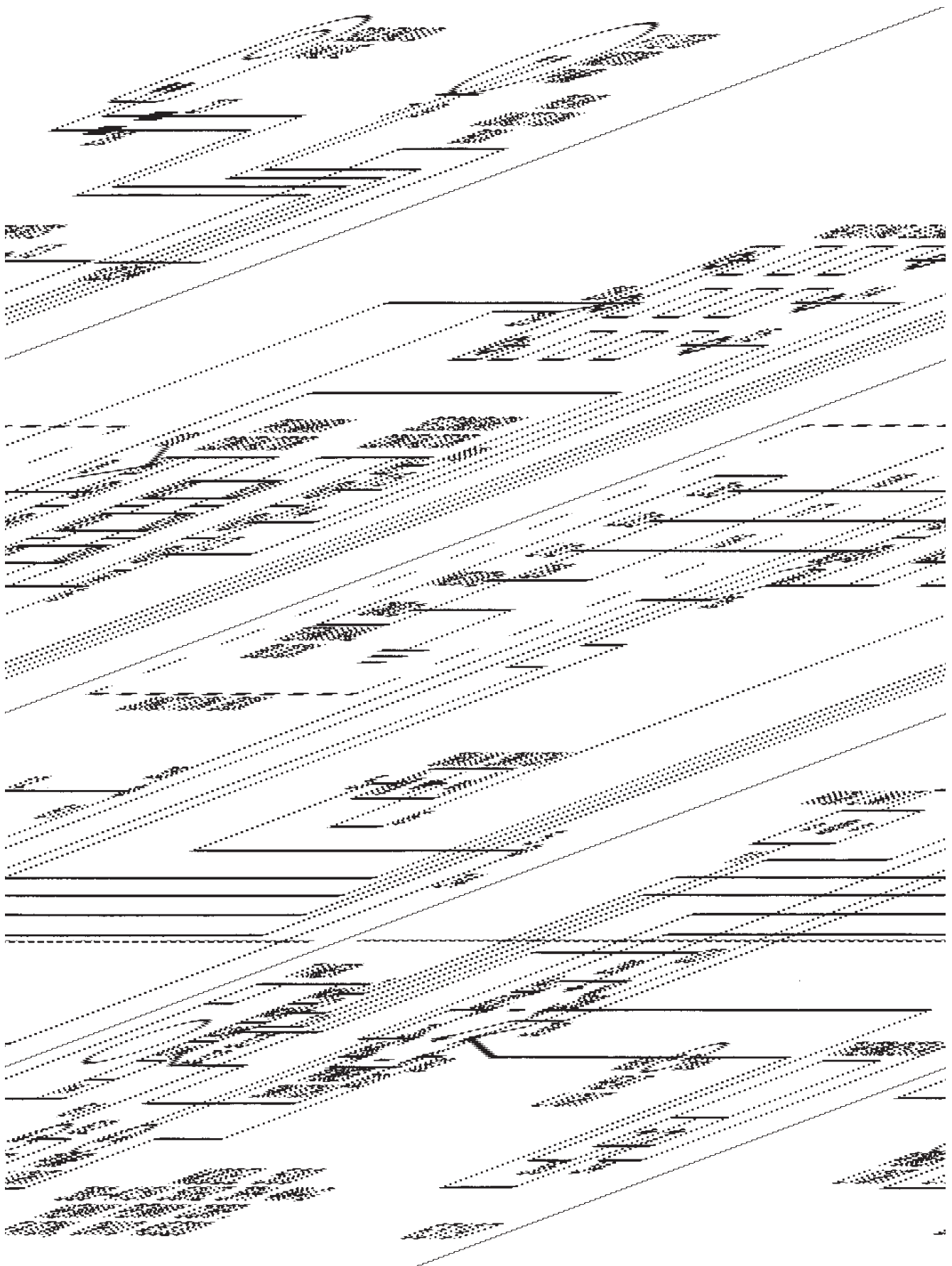


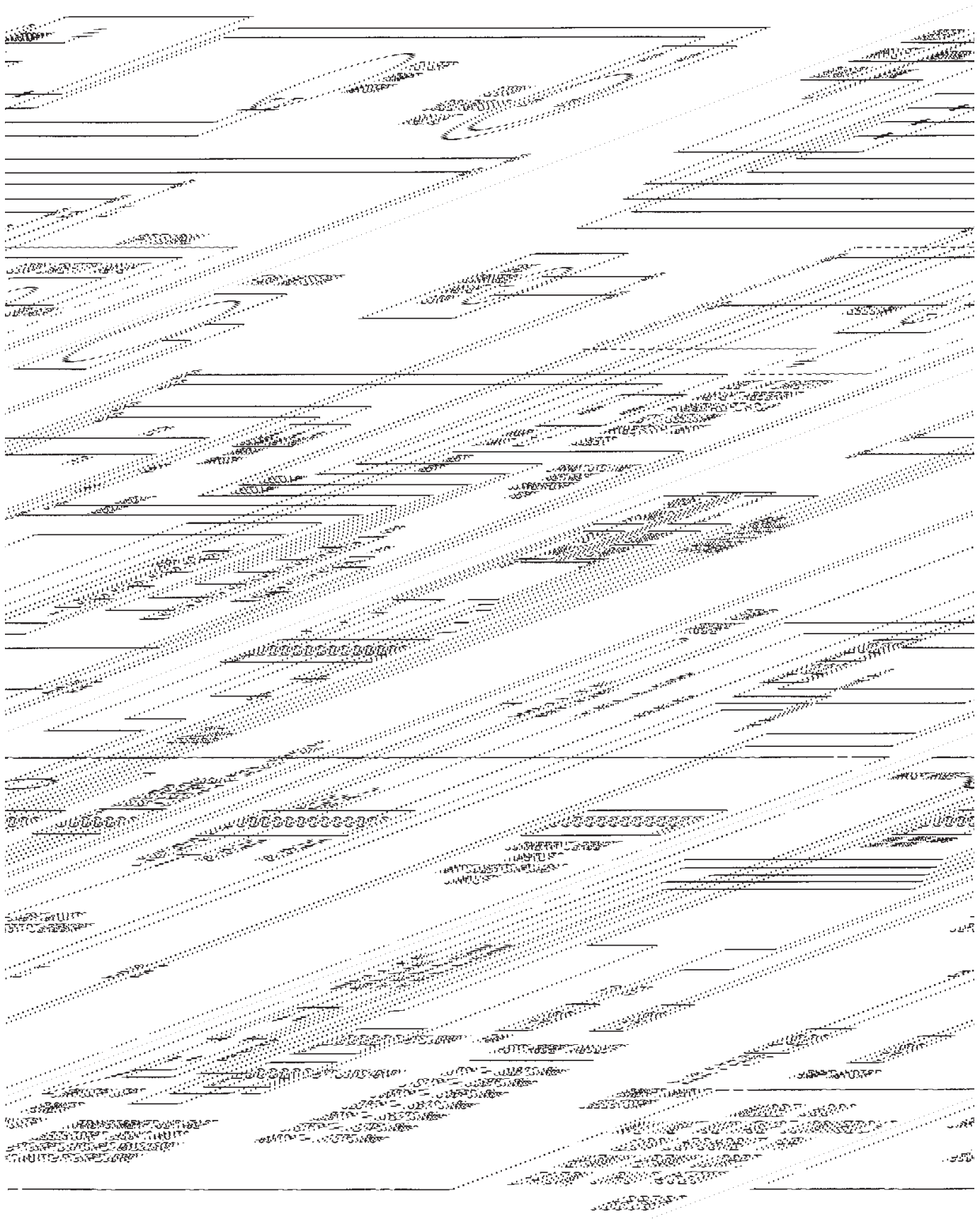
**NEVER USE AN OPEN FLAME TO TEST FOR LEAKS. ESCAPING GAS COULD CAUSE AN EXPLOSION, AND PERSONAL INJURY OR PROPERTY DAMAGE COULD RESULT.**

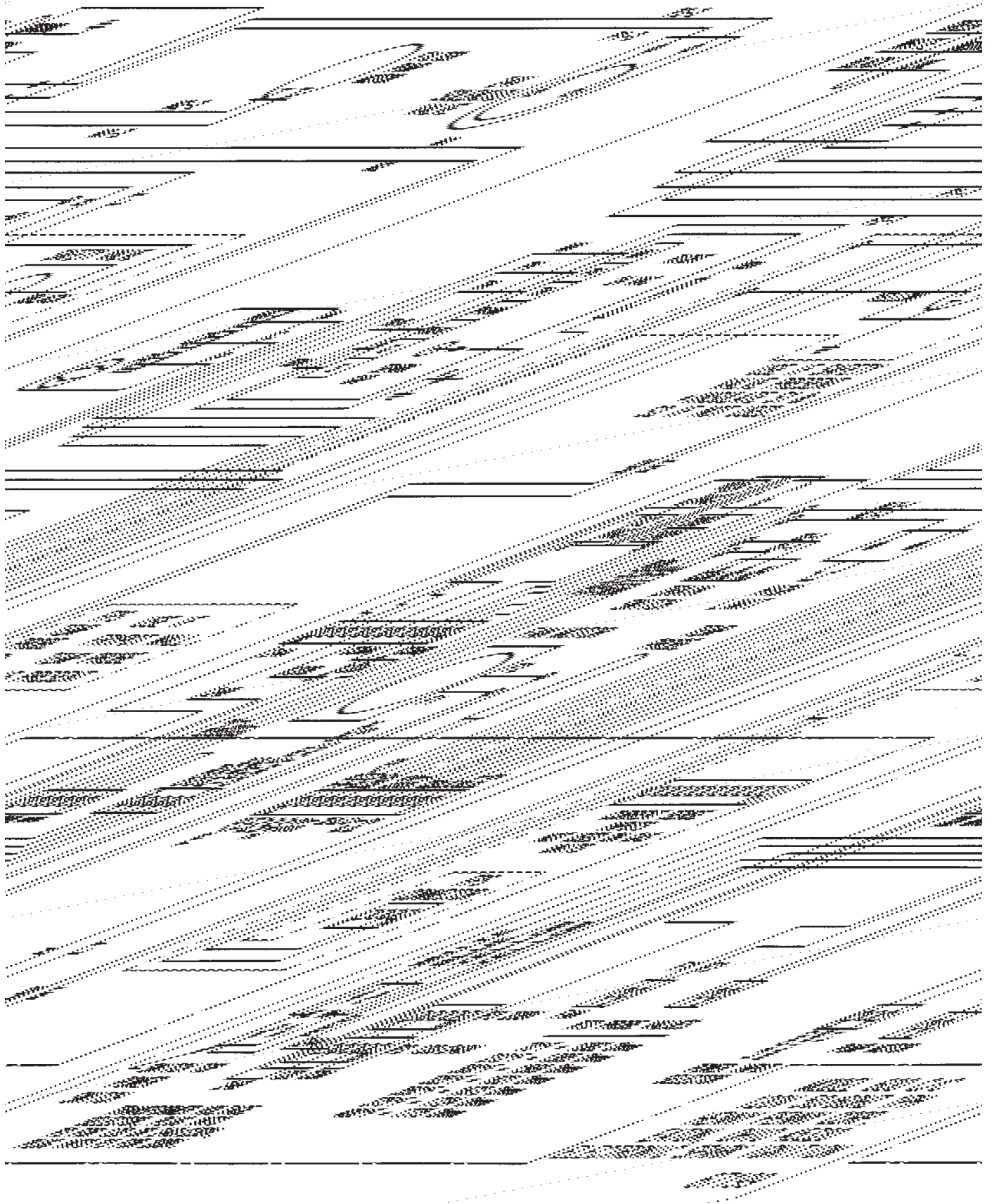














## Wiring Diagram Legend

ABBREVIATION	DEFINITION
C	CONTROL
CB	CIRCUIT BREAKER
D	DRAIN
DS	DRAIN SWITCH
F	FUSE
G	GROUND
H	HEAT
HL	HIGH LIMIT
HS	HEAT & SAFETY
L1	LINE 1
L2	LINE 2
L3	LINE 3
M	MOTOR
P	PRESSURE
PB	PROBE
R	RELAY
S	SAFETY
T	TIMER
TH	THERMOSTAT
TR	TRANSFORMER
/	TWO COMPONENTS TOGETHER
-	EXTENSION OF THE SAME SIGNAL

## **LIMITED WARRANTY FOR HENNY PENNY APPLIANCES**

Subject to the following conditions, Henny Penny Corporation makes the following limited warranties to the original purchaser only for Henny Penny appliances and replacement parts:

**NEW EQUIPMENT:** Any part of a new appliance, except lamps and fuses, which proves to be defective in material or workmanship within two (2) years from date of original installation, will be repaired or replaced without charge F.O.B. factory, Eaton, Ohio, or F.O.B. authorized distributor. To validate this warranty, the registration card for the appliance must be mailed to Henny Penny within ten (10) days after installation.

**REPLACEMENT PARTS:** Any appliance replacement part, except lamps and fuses, which proves to be defective in material or workmanship within ninety (90) days from date of original installation will be repaired or replaced without charge F.O.B. factory, Eaton, Ohio, or F.O.B. authorized distributor.

The warranty for new equipment and replacement parts covers only the repair or replacement of the defective part and does not include any labor charges for the removal and installation of any parts, travel, or other expenses incidental to the repair or replacement of a part.

**EXTENDED FRYPOT WARRANTY:** Henny Penny will replace any frypot that fails due to manufacturing or workmanship issues for a period of up to seven (7) years from date of manufacture. This warranty shall not cover any frypot that fails due to any misuse or abuse, such as heating of the frypot without shortening.

**0 TO 3 YEARS:** During this time, any frypot that fails due to manufacturing or workmanship issues will be replaced at no charge for parts, labor, or freight. Henny Penny will either install a new frypot at no cost or provide a new or reconditioned replacement fryer at no cost.

**3 TO 7 YEARS:** During this time, any frypot that fails due to manufacturing or workmanship issues will be replaced at no charge for the frypot only. Any freight charges and labor costs to install the new frypot as well as the cost of any other parts replaced, such as insulation, thermal sensors, high limits, fittings, and hardware, will be the responsibility of the owner.

Any claim must be presented to either Henny Penny or the distributor from whom the appliance was purchased. No allowance will be granted for repairs made by anyone else without Henny Penny's written consent. If damage occurs during shipping, notify the sender at once so that a claim may be filed.

THE ABOVE LIMITED WARRANTY SETS FORTH THE SOLE REMEDY AGAINST HENNY PENNY FOR ANY BREACH OF WARRANTY OR OTHER TERM. BUYER AGREES THAT NO OTHER REMEDY (INCLUDING CLAIMS FOR ANY INCIDENTAL OR CONSEQUENTIAL DAMAGES) SHALL BE AVAILABLE.

The above limited warranty does not apply (a) to damage resulting from accident, alteration, misuse, or abuse; (b) if the equipment's serial number is removed or defaced; or (c) for lamps and fuses. THE ABOVE LIMITED WARRANTY IS EXPRESSLY IN LIEU OF ALL OTHER WARRANTIES, EXPRESS OR IMPLIED, INCLUDING MERCHANTABILITY AND FITNESS, AND ALL OTHER WARRANTIES ARE EXCLUDED. HENNY PENNY NEITHER ASSUMES NOR AUTHORIZES ANY PERSON TO ASSUME FOR IT ANY OTHER OBLIGATION OR LIABILITY.



HENNY PENNY

Model 500/61/600

FIGURE & ITEM NO.	PART NUMBER	DESCRIPTION	UNITS PER ASSY
3-3		DEADWEIGHT VALVE ASSEMBLY	
1	16924	VALVE ASSEMBLY, Deadweight .....	1
2	56305	BODY, Deadweight Valve .....	1
3	16912	DECAL, DEADWEIGHT VALVE .....	1
4	PP91-127	1/2 x 1/2 90 Degree Street L. ....	1
5	59742	VALVE ASSEMBLY, Relief .....	1
6	16918	DEADWEIGHT ORIFICE .....	1
7	16903	DEADWEIGHT .....	1
8	16902	RING, Cap .....	1
9	56307	CAP, Deadweight Valve .....	1
10	16910	GUAGE, Pressure .....	1
11	16914	GLASS, Pressure Gauge .....	1
12	16909	ELBOW .....	1
13	56636	NIPPLE .....	1

**(SAMPLE)**

**3-5. SUBASSEMBLIES**

In some cases, items in the parts list can be purchased in groups (called subassemblies) instead of purchasing individual parts. The part list shows these subassemblies by indenting the description of the parts included within the subassembly. For example:

- TIMER, Automatic Reset
- SWITCH, Timer
- LIGHT, Timer Indicator
- COIL, Timer Buzzer

The items can be ordered separately (switch, light, or coil), or order the timer, and all three parts are included.

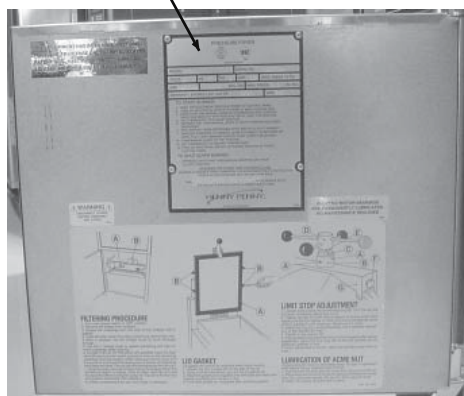
**3-6. HOW TO ORDER PARTS**

Once you have found the parts to be ordered, write down the following information:

1. From the parts list: (SAMPLE)

Figure number	<u>3-3</u>
Item number	<u>6</u>
Part number	<u>16918</u>
Description	<u>DEADWEIGHT ORIFICE</u>
Page number	<u>3-11</u>
Page date code	<u>401</u>

**DATA PLATE**



2. From the data plate on your unit: (SAMPLE)

Model number            500  
Serial number            10133

3. The following table has been provided as a sample format you to use in preparing your spare parts orders. By providing all the entries, your distributor will be able to send you the correct parts. Also, prepayment expedites your order.

From Parts List					Your Order		
Figure & Item No.	Part Number	Description	Page No.	Page Code	Quantity Ordered	Price Each	Total Price
(SAMPLE)							
3-1-16	16706	KNOB, Thermostat	3-7	1001	2	2.00	4.00
3-2-47	16102	KNOB, Spindle, Red	3-9	401	1	2.00	2.00
MODEL NO. <u>500</u> SERIAL NO. <u>10133</u>					<b>TOTAL ORDER</b>		<b>6.00</b>

**3-7. PRICES**

Your distributor has a priced parts list and will be glad to inform you of the cost of your parts order.

**3-8. DELIVERY**

Commonly replaced items are stocked by your distributor and are shipped when your order is received. Other parts are ordered, by your distributor, from Henny Penny Corporation. Normally, these are sent to your distributor within 3 working days.

**3-9. WARRANTY**

All replacement parts (except lamps and fuses) are warranted for 90 days against manufacturing defects and workmanship. If damage occurs during shipping, notify the sender and the carrier at once, so that a claim is properly filed. Refer to warranty in the front of this manual for other rights and limitations.

**3-10. RECOMMENDED SPARE PARTS FOR DISTRIBUTORS**

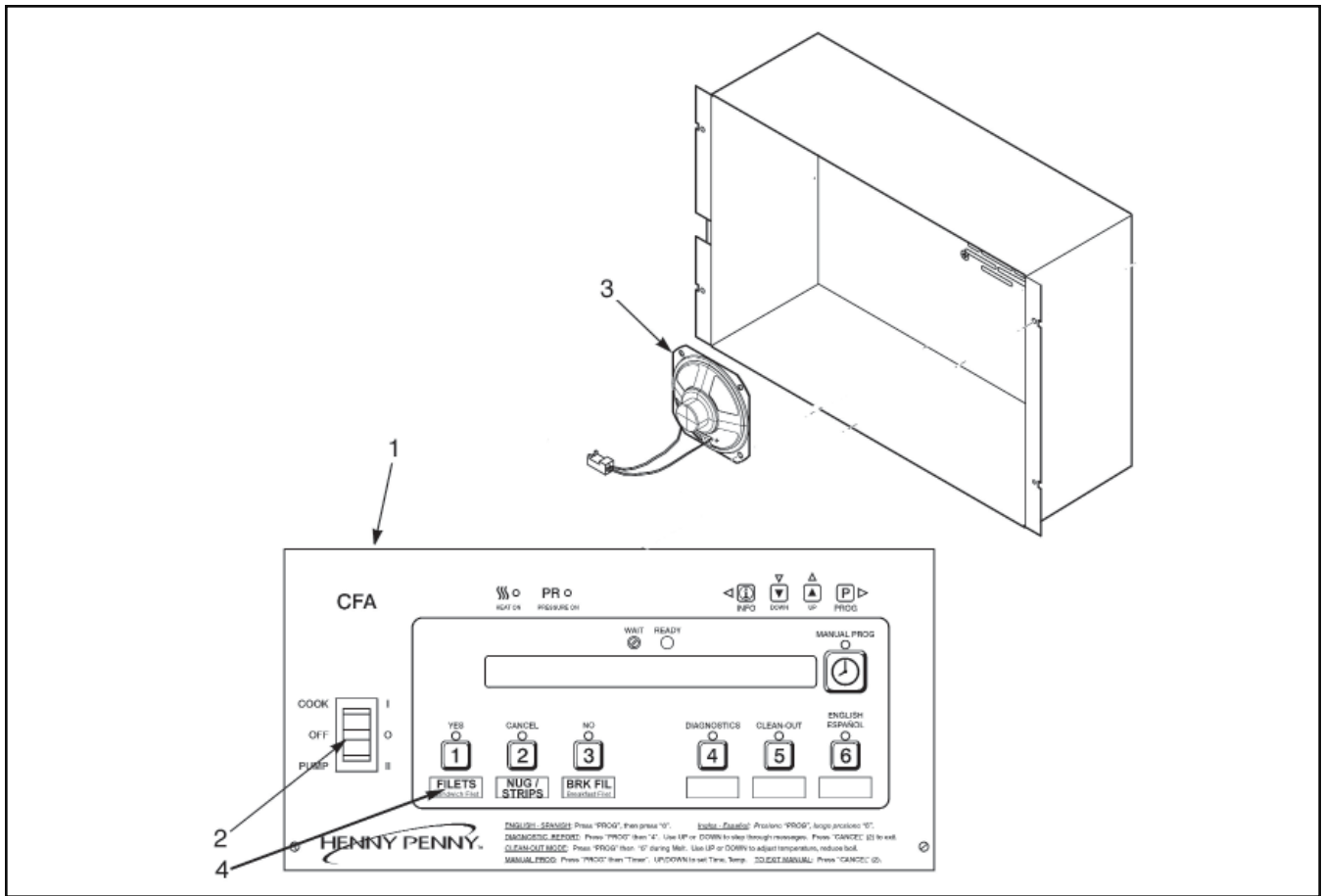
Recommended replacement parts, stocked by your distributor, are indicated with √ in the parts lists. Please use care when ordering recommended parts, because all voltages and variations are marked. Distributors should order parts based upon common voltages and equipment sold in their territory.

3-11. INDEX OF PARTS LIST ILLUSTRATIONS

<b>Title</b>	<b>Fig. No.</b>	<b>Page No.</b>
CONTROL SHROUD and COMPONENTS ..... (Electric Model) Single Phase	3-17	3-38
CONTROL SHROUD and COMPONENTS ..... (Three Phase Electric Model)	3-16	3-36
CONTROL PANEL .....	3-1	3-6
COUNTERTOP INSULATION ASSEMBLY (Gas Model).....	3-10	3-24
DEADWEIGHT VALVE ASSEMBLY.....	3-3	3-9
DRAIN VALVE ASSEMBLY (Electric Model).....	3-7	3-18
DRAIN VALVE ASSEMBLY (Gas Model).....	3-6	3-16
ELECTRIC CONDUIT ASSEMBLY.....	3-23	3-54
ELECTRONIC IGNITION ASSEMBLY.....	3-24	3-56
EXHAUST STACK ASSEMBLY.....	3-4	3-11
FAN and HIGH TEMPERATURE LIMIT CONTROL (Gas Model) .....	3-8	3-20
FILTER DRAIN PAN and FILTER SCREEN ASSEMBLY .....	3-19	3-43
FILTER MOTOR and PUMP .....	3-21	3-49
FIREBOX and FLUE ASSEMBLY (Gas Model).....	3-11	3-26
FIREBOX INSULATION ASSEMBLY (Gas Model).....	3-12	3-28
FRAME and CABINET ASSEMBLY .....	3-18	3-40

3-11. INDEX OF PARTS LIST ILLUSTRATIONS (continued)

<b>Title</b>	<b>Fig. No.</b>	<b>Page No.</b>
FRY BASKET.....	3-9	3-22
FRYPOT and GAS BURNER ASSEMBLY (Gas Model).....	3-14	3-32
GAS CONTROL VALVE .....	3-13	3-30
HEATING ELEMENT and HIGH LIMIT ASSEMBLY (Electric Model)....	3-15	3-34
LID ASSEMBLY .....	3-2	3-7
LOWER FILTER PLUMBING COMPONENTS .....	3-20	3-46
SOLENOID VALVE ASSEMBLY .....	3-5	3-14
UPPER FILTER PLUMBING COMPONENTS.....	3-22	3-51

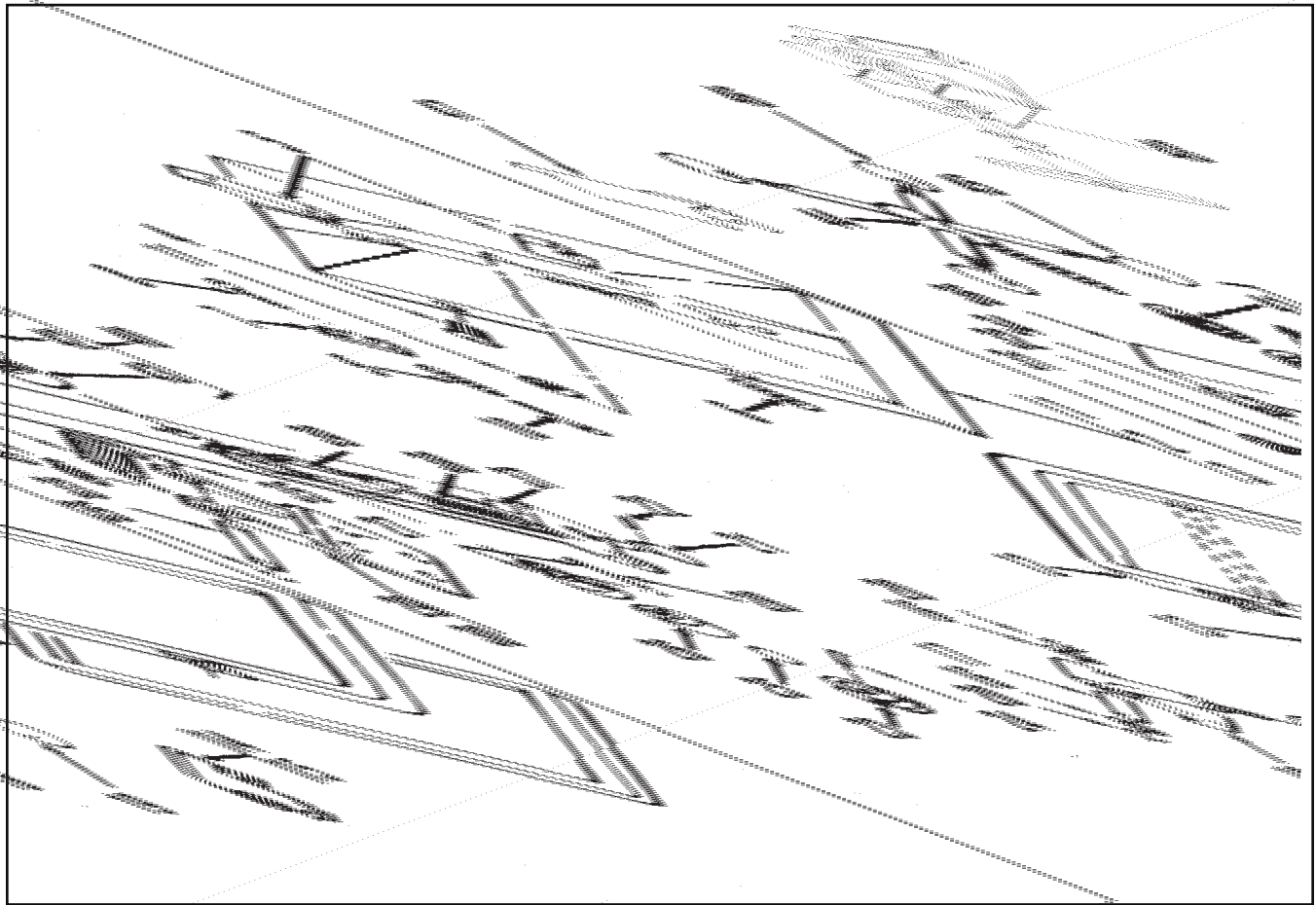


**Figure 3-1. Control Panel**

FIGURE & ITEM NO.	PART NUMBER	DESCRIPTION	UNITS PER ASSY
3-1			
√	67543RB	CONTROL PANEL COMPLETE - Bent Panel 500 - SN: KB020JJ & Below/600 - SN: KA020JJ & Below	1
√	67544RB	CONTROL PANEL COMPLETE - Flat Panel 500 - SN: KB021JJ to HB013JB/600 - KA021JJ to GA085JB	1
√	67830RB	CONTROL PANEL COMPLETE - Flat Panel 500 - SN: HB014JB & Above/600 - SN: GA086JB & Above	1
1	61576	DECAL, CFA - Bent Panel -SN: 500-KB020JJ & Below/600-SN: KA020JJ & Below	1
1	24281	DECAL, CFA - Flat Panel -SN: 500-KB021JJ to HB013JB/600-KA021JJ to GA085JB	1
1	32669	DECAL, CFA - Flat Panel '02 -SN: 500-HB014JB & Above/600-GA086JB & Above	1
√ 2	29898	COOK/PUMP SWITCH	1
√ 3	26974	SPEAKER ASSEMBLY	1
4	61725	MENU CARD - CFA COMPUTRON	1
5*	ME90-011	RELAY, 24VAC COIL (DPST)	1
6*	53669	GUARD, POWER SWITCH	1

√ Recommended Parts/\* not shown



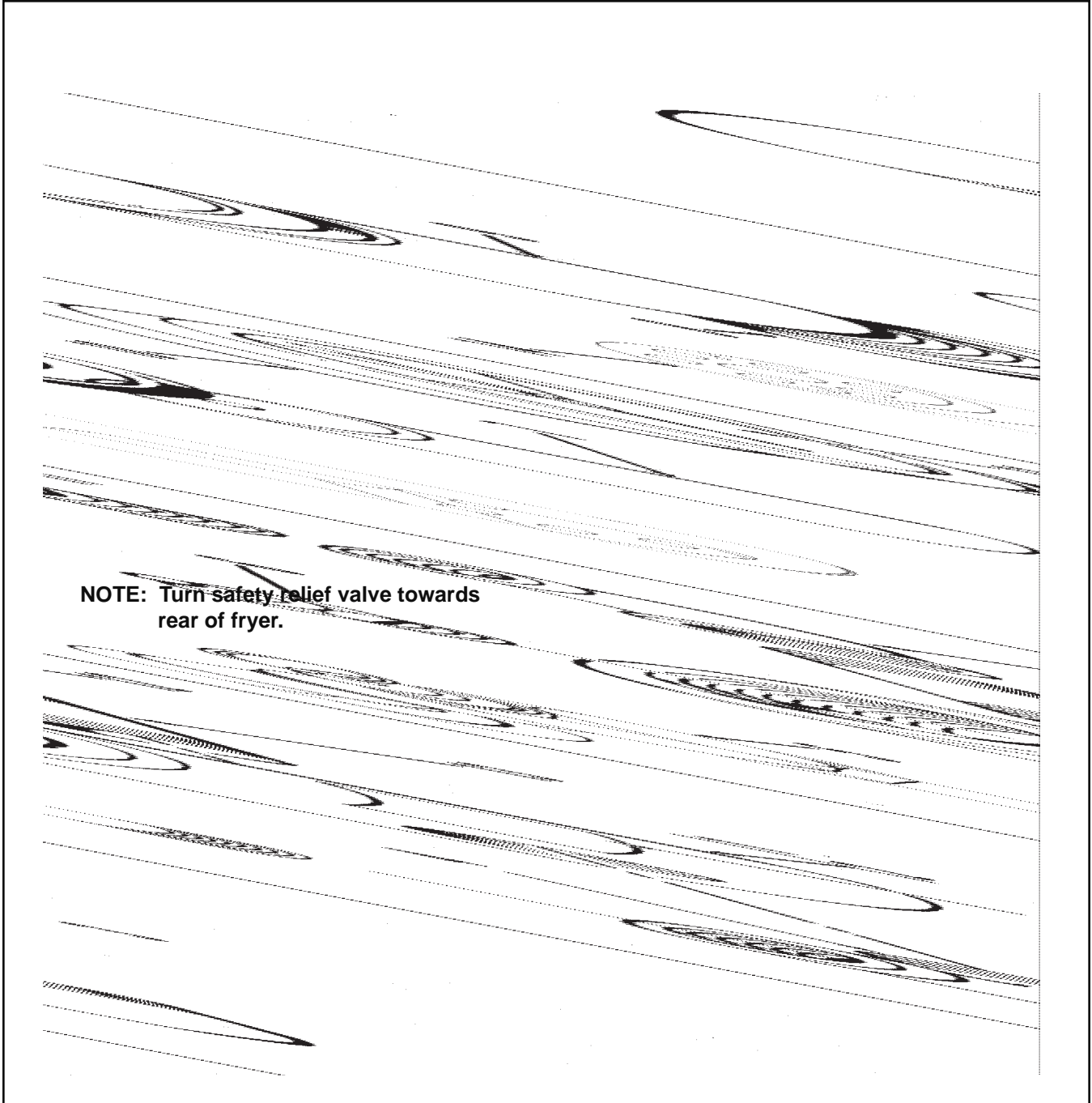


**Figure 3-2. Lid Assembly**

FIGURE & ITEM NO.	PART NUMBER	DESCRIPTION	UNITS PER ASSY
3-2		LID ASSEMBLY	
1	16170	LID ASSEMBLY .....	1
2	16169	COVER ASSEMBLY .....	1
3	16155	COVER, Lid .....	1
4	SC01-083	SCREW, Lid Cover .....	4
5	16133	HOOK, Cover Retaining .....	2
6	SC06-027	SCREW, Retaining Hook .....	4
7	16166	RETAINER .....	1
8	SC06-010	SCREW, Retaining Hook (Allen Head) .....	1
9	16165	SPRING, Return .....	1
10	16164	PIN, Locking .....	1
11	16163	BALL, Seat .....	1

FIGURE & ITEM NO.	PART NUMBER	DESCRIPTION	UNITS PER ASSY
3-2 Cont'd.			
12	16119	LINER, Inner Lid.....	1
√ 13	16120	GASKET, Reversible, Inner Lid Liner.....	1
√ 14	16199	KIT, Latch Spring.....	1
15	33480	SPRING.....	1
16	16198	SPACER.....	2
17	16197	PIN, Latch.....	1
√ 18	16116	LATCH, Lid.....	1
19	16102	KNOB, Latch.....	1
20	16121	RING, Tru-Arc Latch.....	2
21	16137	KNOB, Retaining Pin.....	1
22	16138	PIN, Knob Roll.....	1
23	16157	COLLAR, Locking.....	1
24	16158	PIN, Locking Collar.....	1
25	16159	BALL, Thrust.....	1
26	27326	NUT, Idle.....	1
27	27329	NUT, Acme.....	1
28	16162	PIN, Acme Nut.....	2
√ 29	16112	HINGE, Lid Assembly.....	1
30	40235	HINGE, Lid.....	1
31	SC01-081	SCREW, Lid Hinge.....	4
32	LW01-010	WASHER, Lock, Lid Hinge.....	4
33	16110	PIN, Lid Hinge.....	1
√ 34	16108	HINGE, Lid Spring.....	1
35	16111	RING, Retainer, Tru-Arc, Hinge.....	2
36	16154	BAR, Center Cross.....	1
37	36099	DECAL, DANGER.....	1
38	16136	SPRING, Retaining Pin.....	1
39	16135	COVER, Retaining Pin.....	1
40	16171	STOP, Limit Assembly.....	1
41	16153	STOP, Limit.....	1
42	16156	SCREW, Set, Limit Stop Collar.....	2
43	16152	COLLAR, Limit Stop.....	2
44	16168	SPINDLE ASSEMBLY.....	1
45	16102	KNOB, Spindle, Red.....	1
46	16101	KNOB, Spindle, Black.....	3
47	29587	COVER, Spring.....	1
√ 48	14960	KIT, Spring Loading Tool.....	1

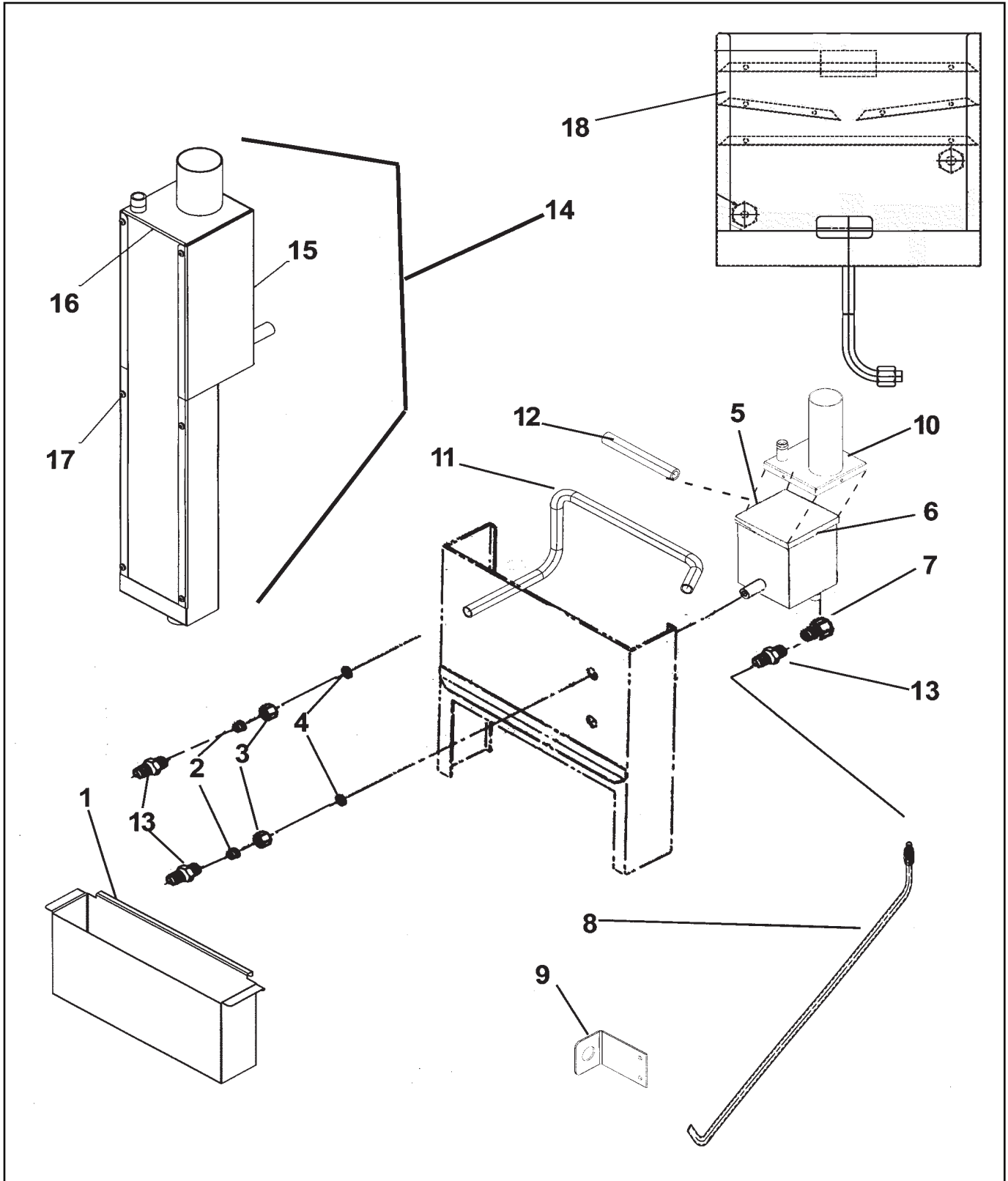
√ Recommended Parts



**Figure 3-3. Deadweight Valve Assembly**

FIGURE & ITEM NO.	PART NUMBER	DESCRIPTION	UNITS PER ASSY
3-3		DEADWEIGHT VALVE ASSEMBLY	
1	16924	VALVE ASSEMBLY, Deadweight .....	1
2	56305	BODY, Deadweight Valve.....	1
3	16912	DECAL, DEADWEIGHT VALVE .....	1
4	FP01-127	1/2 x 1/2 90 Degree Street L.....	1
√ 5	59742	VALVE ASSEMBLY, Relief .....	1
6	16918	DEADWEIGHT ORIFICE.....	1
7	16903	DEADWEIGHT .....	1
8	16902	RING, Cap.....	1
9	56307	CAP, Deadweight Valve .....	1
√ 10	16910	GAUGE, Pressure .....	1
11	16914	GLASS, Pressure Gauge.....	1
12	16909	ELBOW .....	1
13	56636	NIPPLE.....	1

√ Recommended Parts

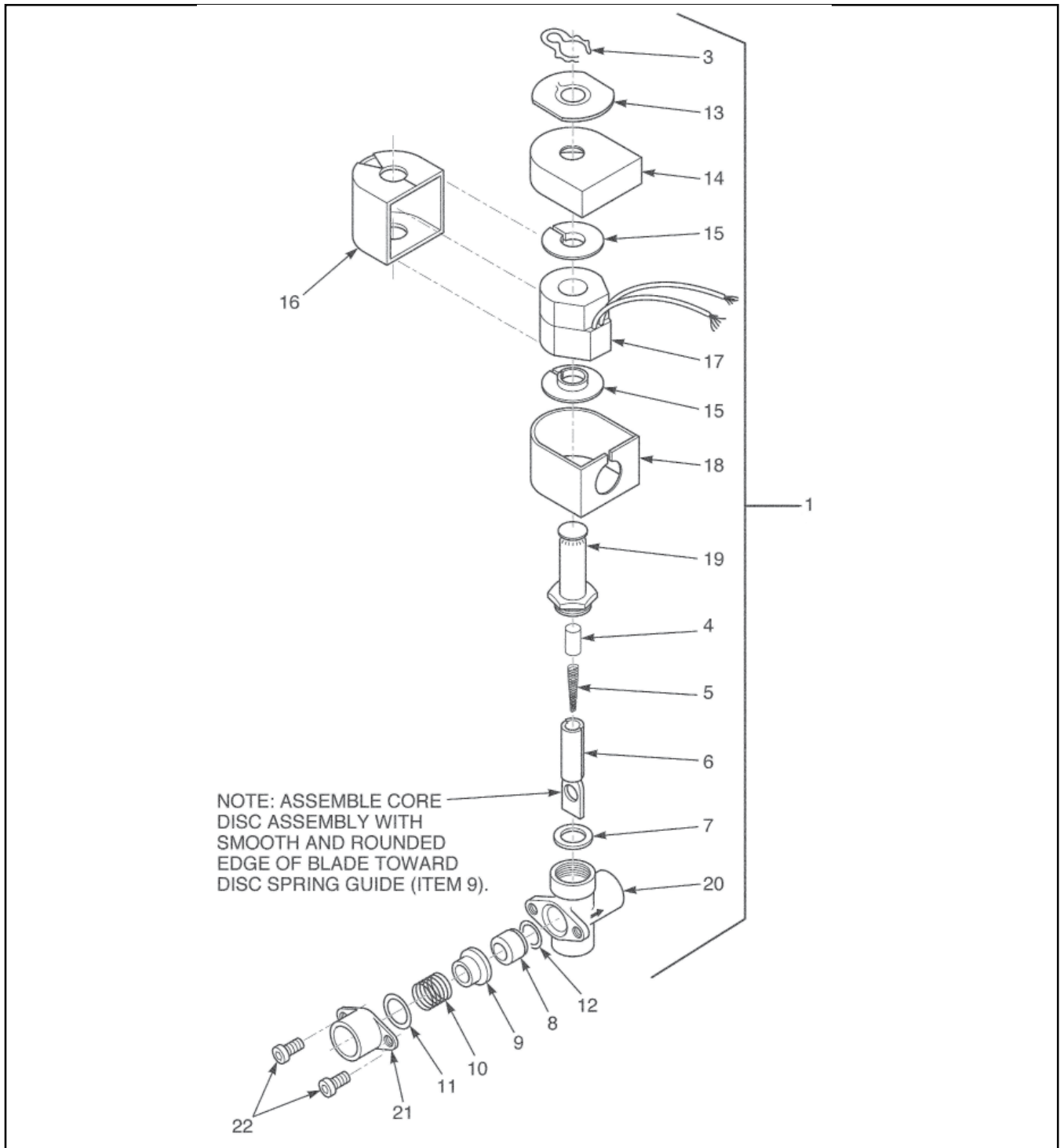


**Figure 3-4. Exhaust Stack Assembly**

FIGURE & ITEM NO.	PART NUMBER	DESCRIPTION	UNITS PER ASSY
3-4		EXHAUST STACK ASSEMBLY	
1	68086	PAN, Condensation Drain.....	1
1	64274	PAN, Condensation Drain - Short (CFA-SN: JB095JA to HB013JB) .....	1
2	16817	FITTING, Teflon Sleeve .....	2
3	16809	NUT, Fitting.....	2
4	16804	UMBRELLA GROMMET .....	2
5	58852	CONDENSATE BOX - Bottom- <b>See chart on next page....</b>	1
6	SC02-016	SCREW, #8-32-AB x 1/2 PH PHD S .....	4
7	FP01-122	REDUCER, 3/8 to 1/2 BI.....	1
8		TUBE, Condensation Assembly- <b>See chart on next page....</b>	1
9	63992	BRACKET, Condensation Hose.....	1
10	64013	CONDENSATE BOX - Top- <b>See chart on next page.....</b>	1
11		TUBE, Deadweight- <b>See chart on next page .....</b>	1
12		HOSE, Deadweight to Steam Box- <b>See chart on next page</b>	1
13	16807	CONNECTOR, Male.....	3
14	65724	ASSY, Condensate Box- <b>See chart on next page.....</b>	1
15	65725	WELD ASSY, Steam Box - Outer.....	1
16	65726	WELD ASSY, Steam Box - Inner .....	1
17	SC04-003	SCREW, #8-32 x 3/8 PH PHD S.....	6
18	21302	ASSY, Exhaust Stack - 500 - SN: KB020JJ & Below .....	1

**Exhaust Stack Assembly**

SN		500	600
KB020JJ & Below	Condensation Line Assy	18502	-
	KA020JJ & Below	Condensation Line Assy	-
	Dead Wt. Tube	-	16854
KB021JJ to BB016JA	Condensation Line Assy	14320	-
	Condensate Box Top	64013	-
	Dead Wt. Tube	59221	-
	DW To Steam Box Hose	63195	-
	Condensate Box	58852	-
KA021JJ to BA026JA	Condensation Line Assy	-	14320
	Condensate Box Top	-	64013
	Dead Wt. Tube	-	59221
	DW To Steam Box Hose	-	63195
	Condensate Box	-	58852
BB017JA to EB015JB	Condensation Line Assy	64016	-
	Condensate Box Top	64013	-
	Dead Wt. Tube	59221	-
	DW To Steam Box Hose	63195	-
	Condensate Box	58852	-
BA027JA to EA014JB	Condensation Line Assy	-	64016
	Condensate Box Top	-	64013
	Dead Wt. Tube	-	59221
	DW To Steam Box Hose	-	63195
	Condensate Box	-	58852
EB016JB to HB013JB (except EB018JB & EB019JB)	Condensation Line Assy	24998	-
	Condensate Box Top	use 65724	-
	Dead Wt. Tube	65621	-
	DW To Steam Box Hose	26866	-
	Condensate Box Bottom	use 65724	-
	Condensate Box	use 65724	-
EA015JB to GA085JB	Condensation Line Assy	-	24998
	Condensate Box Top	-	use 65724
	Dead Wt. Tube	-	65621
	DW To Steam Box Hose	-	26866
	Condensate Box Bottom	-	use 65724
	Condensate Box	-	use 65724
HB014JB & Above	Condensation Line Assy	69009	-
	Dead Wt. Tube	65621	-
	DW To Steam Box Hose	26866	-
	Condensate Box	65724	-
GA086JB & Above	Condensation Line Assy	-	69009
	Dead Wt. Tube	-	65621
	DW To Steam Box Hose	-	26866
	Condensate Box	-	65724

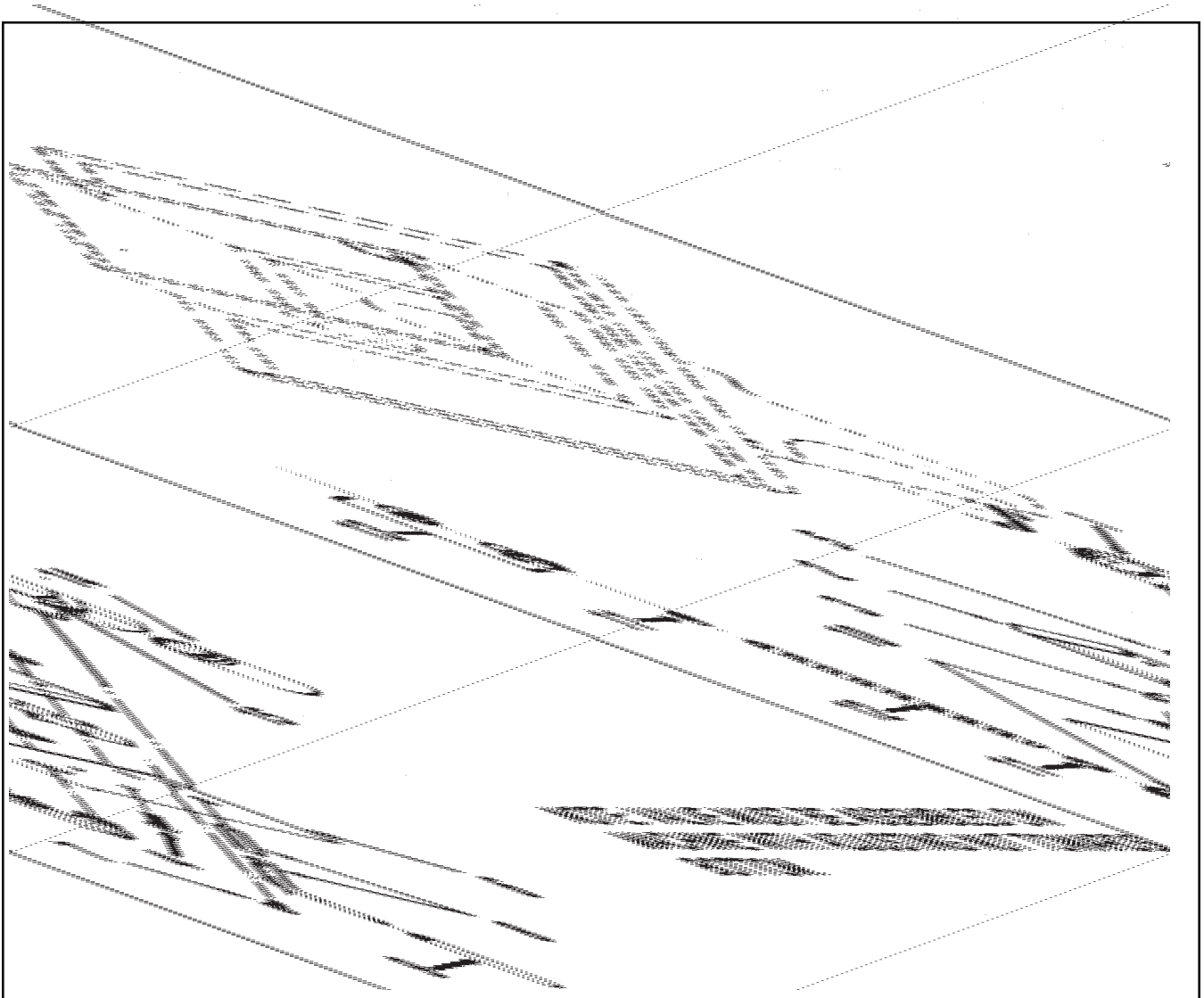


**Figure 3-5. Solenoid Valve Assembly**



FIGURE & ITEM NO.	PART NUMBER	DESCRIPTION	UNITS PER ASSY
3-5		SOLENOID VALVE ASSEMBLY (Gas and Electric Models)	
1	17121	VALVE, Solenoid, 120 Volt, 60 Hz .....	1
1	18724	VALVE, Solenoid, 208-240 Volt, 50 Hz .....	1
1	18721	VALVE, Solenoid, 208/240 Volt, 60 Hz .....	1
1	29515	VALVE, Solenoid, 24 Volt, 60 Hz .....	1
1	29698	VALVE, Solenoid, 24 Volt, 50 Hz .....	1
√ 2*	17120	KIT, Solenoid Valve Repair .....	1
3	17101	CLIP, Retaining .....	1
4	17109	RETAINER, Spring .....	1
5	17110	SPRING, Core .....	1
6	17111	CORE, Disc Assembly .....	1
7	17112	GASKET, Bonnet .....	1
8	17114	SEAT, Teflon .....	1
9	17115	GUIDE, Disc Spring .....	1
10	17116	SPRING, Disc .....	1
11	17117	RING, Spring Retainer.....	1
12	17122	SEAT, O-Ring Seal .....	1
√ 13	17102	PLATE, Solenoid Name .....	1
√ 14	17103	COVER, Coil Housing.....	1
√ 15	17104	WASHER, Coil .....	2
√ 16	17105	YOKE, Coil.....	1
√ 17	17106	COIL, 120 Volt, 60 Hz .....	1
√ 17	18706	COIL, 208/240 Volt, 60 Hz .....	1
√ 17	18726	COIL, 208-240 Volt, 50 Hz .....	1
√ 17	29547	COIL, 24 Volt, 60 Hz .....	1
√ 17	29575	COIL, 24 Volt, 50 Hz .....	1
√ 18	17123	HOUSING, Coil .....	1
√ 19	17108	BONNET, Solenoid.....	1
√ 20	17113	BODY, Solenoid Valve.....	1
√ 21	17118	ADAPTER, Pipe .....	1
√ 22	SC01-132	SCREW, Adapter.....	2

√ Recommended Parts  
\*not shown



**Figure 3-6. Drain Valve Assembly (Gas Model)**

FIGURE & ITEM NO.	PART NUMBER	DESCRIPTION	UNITS PER ASSY
3-6		<b>DRAIN VALVE ASSEMBLY (Gas Model)</b>	
1	17261	BODY, Drain Valve (June 1998 and above) .....	1
2	17210	COVER, Microswitch .....	1
1	55152	ASSY, Drain Valve and Coupling (May 1998 and below)	1
√ 3	18227	MICROSWITCH .....	1
4	SC01-058	SCREW, Microswitch .....	2
5	NS02-005	NUT, Microswitch .....	2
6	17211	BRACKET, Drain, Valve Rod .....	1
7	SC03-005	SCREW, Drain Bracket .....	2
8	17254	ROD, Drain Valve - Normally Closed .....	1
8	67661	ROD, Drain Valve - Normally Open.....	1
9	16293	COVER, Valve Handle .....	1
10	18644	CONNECTOR, 90° Flexible Conduit .....	1
		(Includes Nut)	
11	18105	INSULATOR .....	2
12	17214	CONDUIT, Flexible .....	1
13	18111	CONNECTOR, Flexible Conduit (Includes Nut).....	1
14	18819	EXTENSION NIPPLE (SN: KA020JJ and below) ...	1
14	18817	EXTENSION NIPPLE (SN: KA021JJ to GA085JB)	1
14	24647	EXTENSION & DEFLECTOR.....	1
		(SN: GA086JB and above)	
15	17255	PIN, Cotter .....	2
√ 16*	14652	KIT, PFG600 Norm Open Drain Switch.....	1

√ Recommended Parts

\*not shown

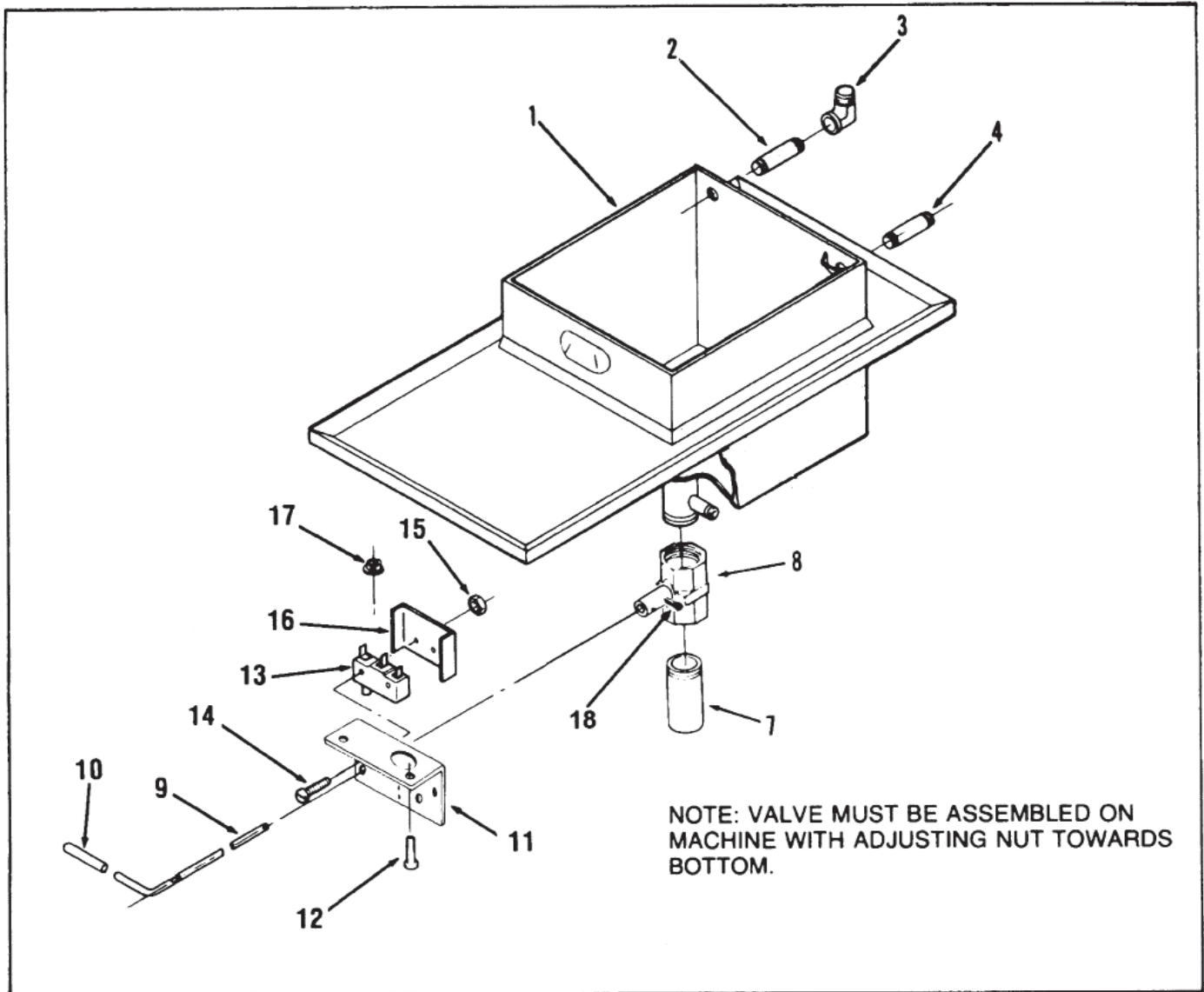
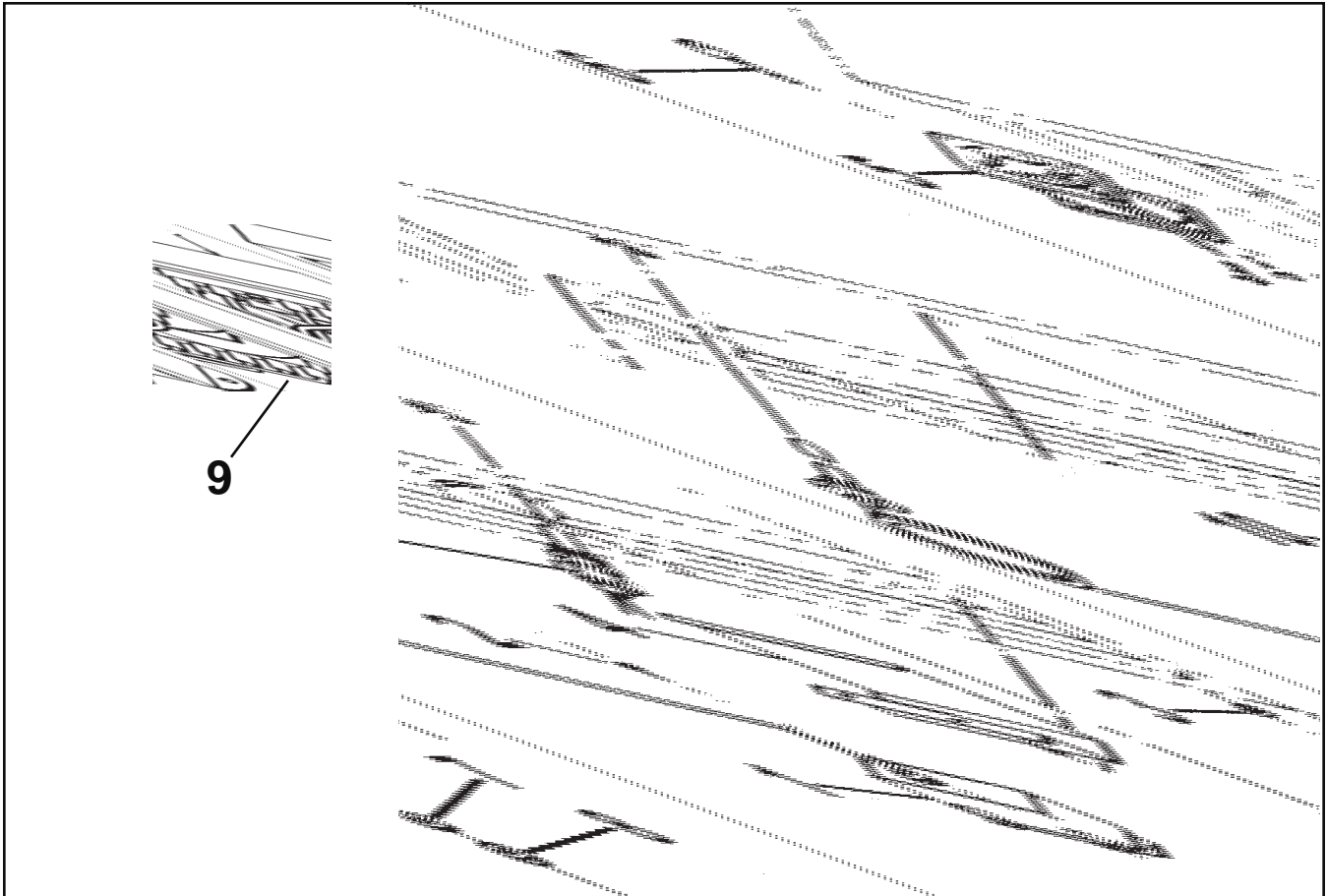


Figure 3-7. Drain Valve Assembly (Electric Model)

FIGURE & ITEM NO.	PART NUMBER	DESCRIPTION	UNITS PER ASSY
3-7		<b>DRAIN VALVE ASSEMBLY</b> (Electric Model)	
1	18921	TOP ASSEMBLY, Pot and Counter-SN: KB020JJ & Below	1
1	65025	TOP ASSEMBLY, Pot and Counter-KB021JJ & Above .....	1
2	18816	NIPPLE, Pipe .....	1
3	16239	ELBOW .....	1
4	18816	NIPPLE, Pipe .....	1
7	18817	NIPPLE, Drain Extension-SN: KB020JJ & Below.....	1
7	58851	NIPPLE, Drain Extension-SN: KB021JJ to HB013JB .....	1
7	24633	NIPPLE, Drain Extension & Deflector-SN: HB014JB & Above	1
8	17261	BODY, Drain Valve (SN: FB099IH and above).....	1
8	55152	ASSY, Drain Valve and Coupling (SN: FB098IH and below)	1
9	18818	ROD, Drain Valve Extension - Normally Closed.....	1
9	66123	ROD, Drain Valve Extension - Normally Open .....	1
10	16293	COVER, Valve Handle .....	1
11	18419	BRACKET, Filter & Drain Rod-SN: KB020JJ & Below ...	1
11	59219	BRACKET, Filter & Drain Rod-SN: KB021JJ to HB013JB	1
11	27412	BRACKET, Filter & Drain Rod-SN: HB014JB & Above ..	1
12	SC03-005	SCREW, Drain Valve Bracket .....	2
√ 13	18227	MICROSWITCH .....	1
14	SC01-058	SCREW, Microswitch .....	2
15	NS02-005	NUT, Microswitch .....	2
16	18528	COVER, Microswitch .....	1
17	EF02-004	BUSHING, Snap .....	1
18	17255	PIN, Cotter.....	2
√ 19*	14653	KIT, PFE500 Norm Open Drain Switch.....	1

√ Recommended Parts  
\*not shown



**Figure 3-8. Fan and High Temperature Limit Control (Gas Model)**

FIGURE & ITEM NO.	PART NUMBER	DESCRIPTION	UNITS PER ASSY
3-8		FAN AND HIGH TEMPERATURE LIMIT CONTROL (Gas Model)	
√ 1	16738	CONTROL, High Temperature Limit.....	1
2	SC02-018	SCREW, Thread Forming #8 .....	2
3	NS02-001	NUT, #10-32 Hex Keps .....	2
4	17216	BRACKET ASSY, High Limit Thermostat .....	1
√ 5	81208	FAN, 120 Volt .....	1
6	SC01-266	SCREW, Fan .....	4
7	WA01-006	WASHER, Fan .....	4
8	NS02-005	NUT, Fan.....	4
√ 9	72854	ASSY, TRANSFORMER - 24 VAC .....	1
√ 10	14331	KIT, Temperature Probe.....	1
11*	36097	PROBE GUARD .....	1

√ Recommended Parts

\*not shown

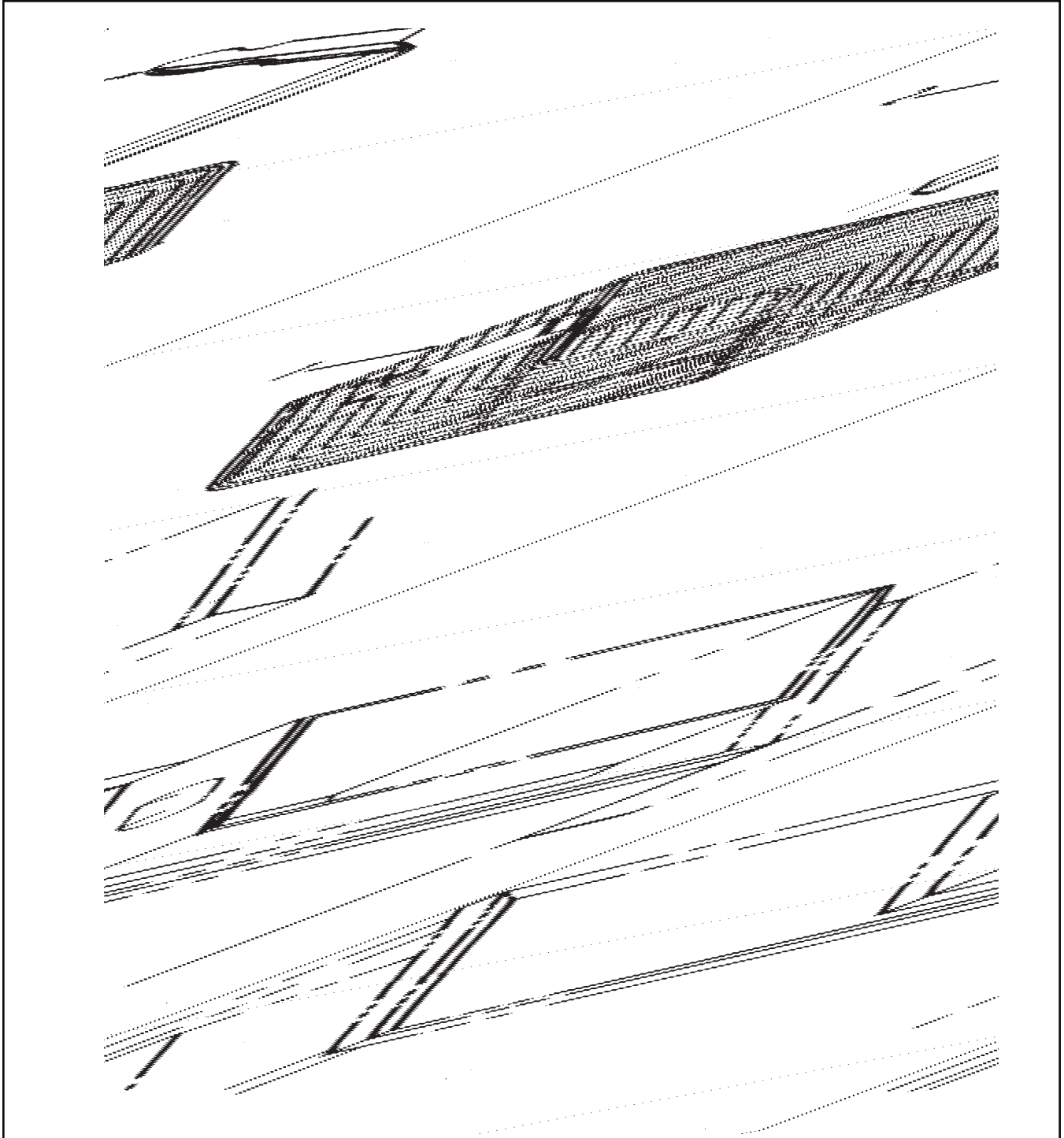
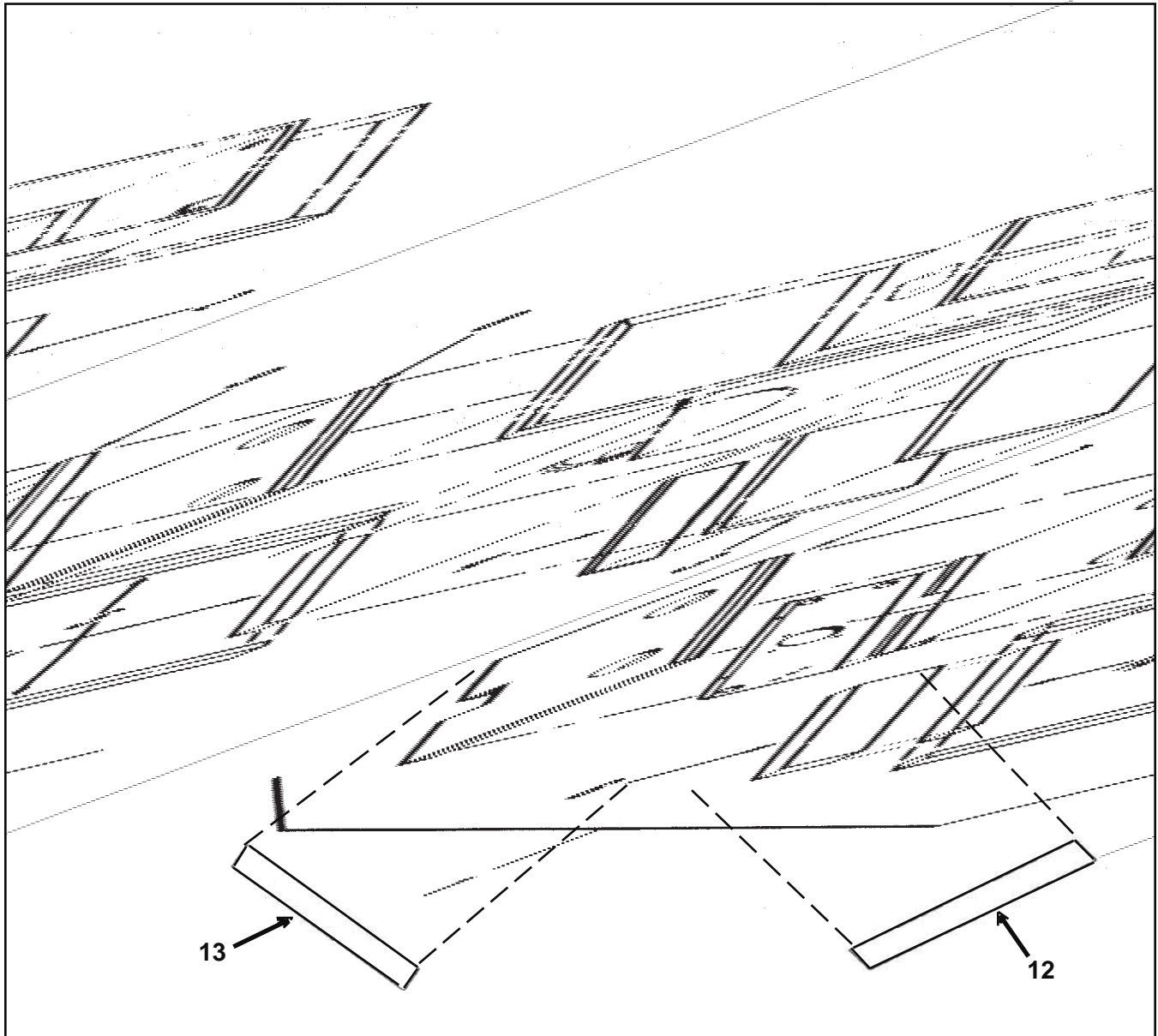


Figure 3-9. Fry Basket

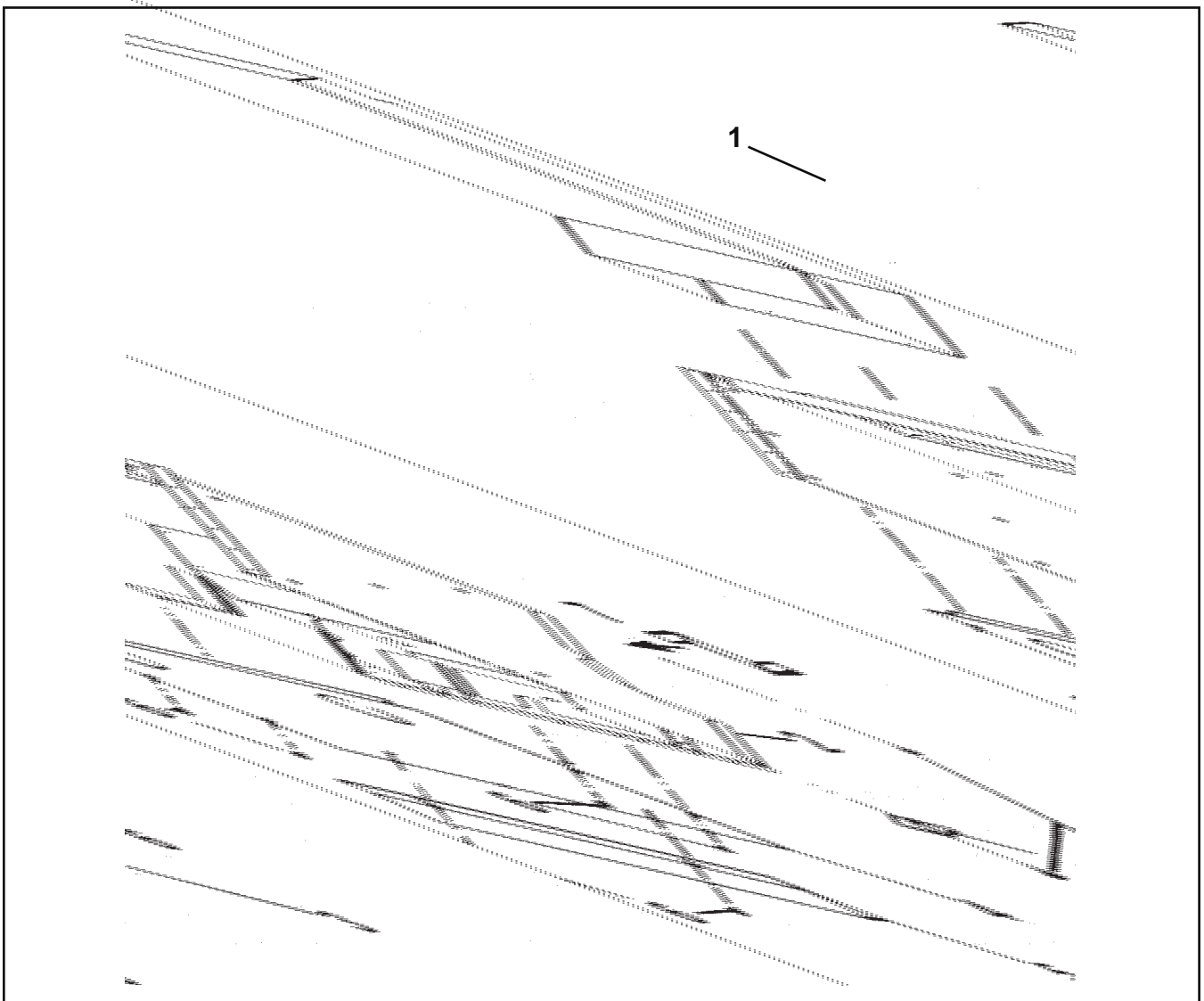


FIGURE & ITEM NO.	PART NUMBER	DESCRIPTION	UNITS PER ASSY
3-9		FRY BASKET (Gas and Electric Models)	
1	17801	BASKET, Without Legs, Gas Model Only .....	1
1	64058	BASKET, 3 Layer - Gas Model Only .....	1
1	19507	BASKET, Expanded Metal - Electric Model Only.....	1
2	19502	HANDLE .....	1
3*	29769	GRIP, Fryer Handle.....	1
*not shown			



**Figure 3-10. Countertop Insulation Assembly (Gas Model)**

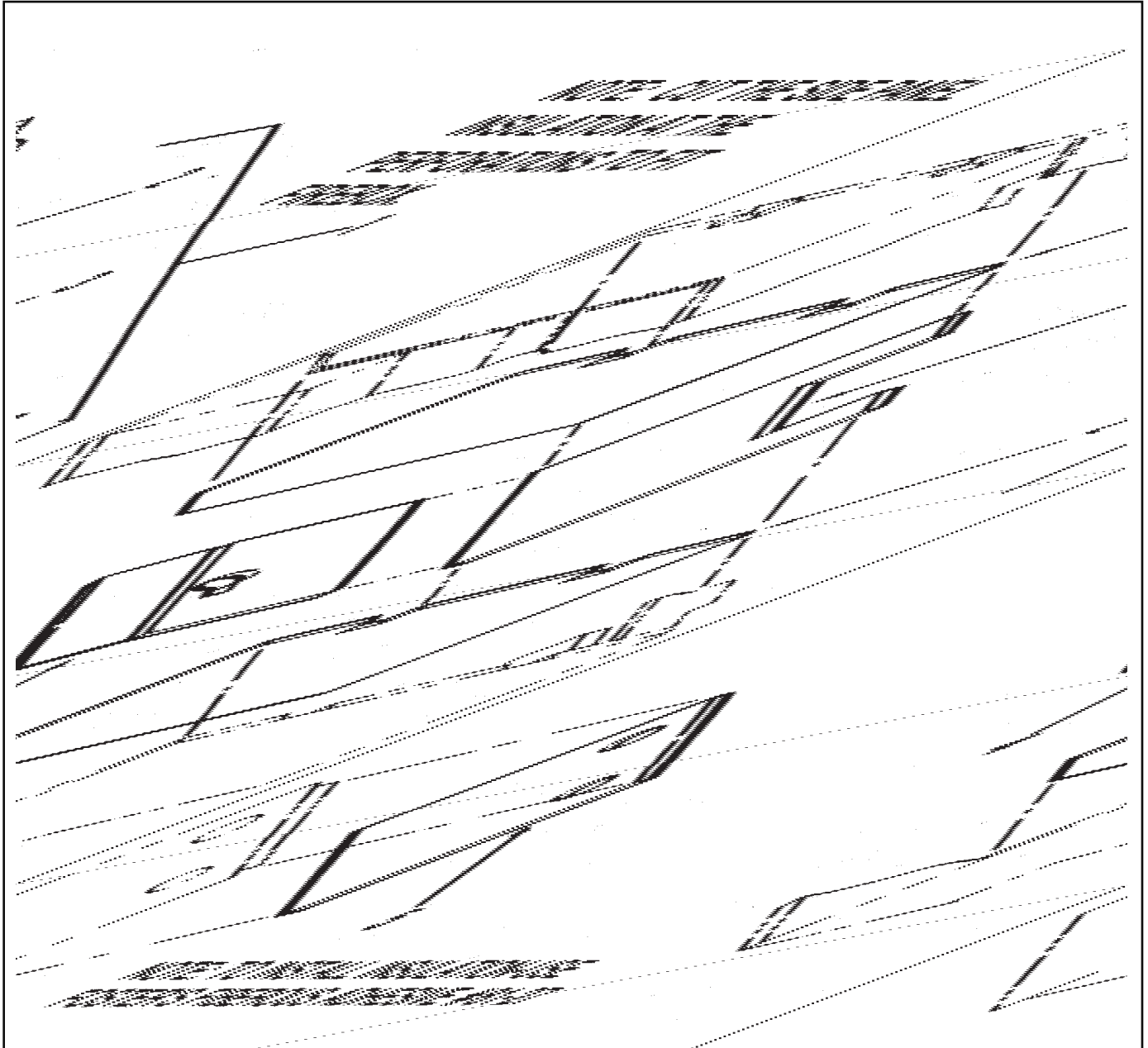
FIGURE & ITEM NO.	PART NUMBER	DESCRIPTION	UNITS PER ASSY
3-10		COUNTERTOP INSULATION ASSEMBLY . (Gas Model)	
1	14698	KIT, Complete Set - SN: KA020JJ & Above.....	1
1	16518	INSULATION, Complete Set-SN: 36886 to KA020JJ..... (Includes Part Nos. 16505,17605,16872, MS01-180, Bulk Cerefelt Insulation For Around Thermocouple, Pot Fittings, and Glue.)	1
2	63301	INSULATION, Fiberglass .....	1
3	63302	INSULATION, Cerefelt - Flue Top .....	1
4	16308	BOARD, Aircell .....	1
5	53807	INSULATION, Countertop-sides .....	2
6	16303	INSULATION, Fiberglass .....	1
7	63699	INSULATION, Fiberglass Notched .....	2
8	63623	INSULATION, Heat Shield, Inner.....	1
9	59232	HEAT SHIELD .....	1
12	59965	INSULATION, Countertop Side.....	2
13	59966	INSULATION, Countertop Front.....	1
14	53808	INSULATION, Countertop-Front/Rear .....	2



**Figure 3-11. Firebox and Flue Assembly (Gas Model)**

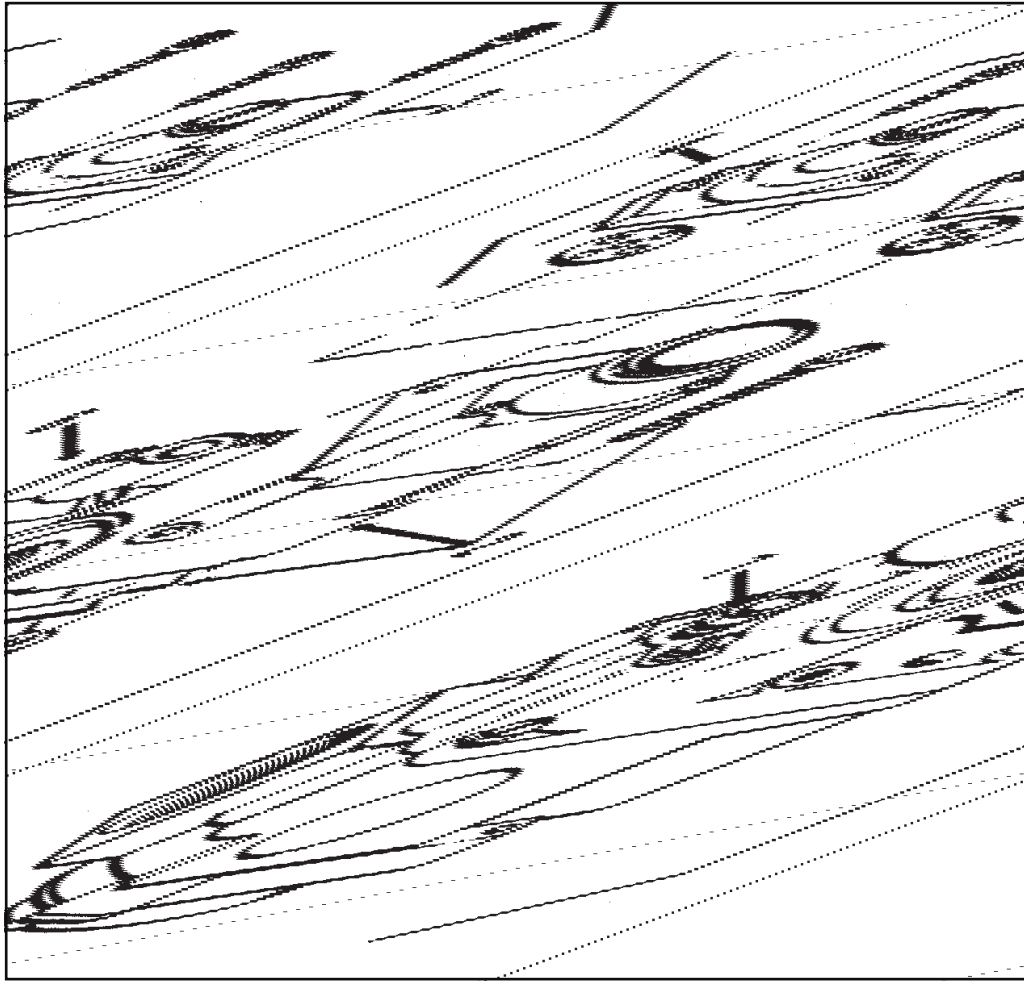
FIGURE & ITEM NO.	PART NUMBER	DESCRIPTION	UNITS PER ASSY
3-11		FIREBOX AND FLUE ASSEMBLY ..... (Gas Model)	
1	59728	STACK, Flue Exhaust - SN: KA021JJ & Above.....	1
1	54865	STACK, Flue Exhaust - SN: KA020JJ & Below.....	1
2	59223	CABINET ASSEMBLY, Firebox - SN: KA021JJ & Above	1
2	29679	CABINET ASSEMBLY, Firebox - SN: KA020JJ & Below	1
3	18625	BRACKET, Side Panel Insulation .....	2
4	87448	PANEL, Firebox Front .....	1
5	16406	DEFLECTOR, Heat Shield .....	1
6	SC03-005	SCREW, Sheet Metal .....	20
7	18626	BRACKET, Side Panel Insulation, Rear .....	2

\* not shown

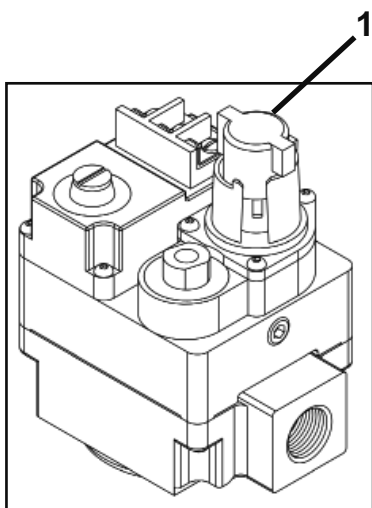


**Figure 3-12. Firebox Insulation Assembly (Gas Model)**

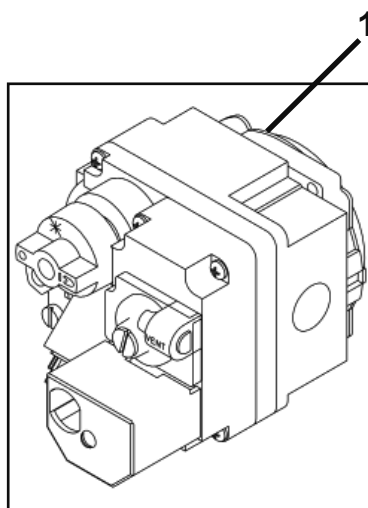
FIGURE & ITEM NO.	PART NUMBER	DESCRIPTION	UNITS PER ASSY
3-12		FIREBOX INSULATION ASSEMBLY ..... (Gas Model)	
1	16505	INSULATION, Firebox - Complete Set ..... Cerefelt, Inside Firebox	1
2	63111	INSULATION, Side Panel , Cerefelt .....	2
3	16502	INSULATION, Back Panel, Cerefelt .....	1
4	16503	INSULATION, Bottom Panel, Cerefelt .....	1
5	29690	INSULATION, Front Panel, Cerefelt .....	1



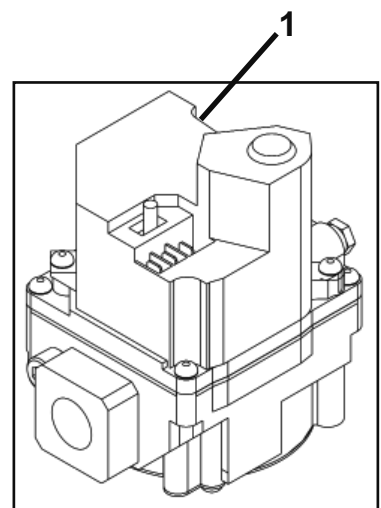
Style 1



Style 2



Style 3



Style 4

Figure 3-13. Gas Control Valve



FIGURE & ITEM NO.	PART NO.	DESCRIPTION	UNITS PER ASSY
3-13		<b>GAS CONTROL VALVE</b>	
√ 1	-----	VALVE, Gas Control -- <b>See Table 1 Below</b> .....	1
√ 2	16254	OPERATOR, Gas Control Valve, 120 Volt, Natural .....	1
√ 2	16386	OPERATOR, Gas Control Valve, 120 Volt, Propane .....	1
√ 3	16253	REGULATOR, Gas Control Valve, Natural Gas .....	1
√ 4	16352	REGULATOR, Gas Control Valve, Propane Gas .....	1
√ 6	16267	KNOB, Gas Control Valve .....	1
√ 7	16373	FITTING, Compression - Pilot Tube .....	2
8*	16247	KIT, Nat. to LP Conversion - KA020JJ & Below .....	1
8*	16248	KIT, LP to Nat. Conversion - KA020JJ & Below .....	1
8*	14324	KIT, Nat. to LP Conversion - KA021JJ to July 10, 2006 .....	1
8*	14325	KIT, LP to Nat. Conversion - KA021JJ to July 10, 2006 .....	1
8*	14723	KIT, Solid State Ign.-Nat. to LP Conversion -July 10, 2006 & after .....	1
8*	14724	KIT, Solid State Ign.-LP to Nat. Conversion -July 10, 2006 & after .....	1

√ Recommended Parts  
\* not shown

**TABLE 1**

Voltage	Nat. Electronic Ign.	LP Electronic Ign.	Nat. Std. Ign.	LP Std. Ign.	Town Gas
<b>120V</b>	†34439 (SN: KA020JJ and Below)	-----	†16216	†16217	Use †16262 and 16254
<b>240V</b>	-----	†21316	†16380	†16381	†16262
<b>24V</b>	◇140043 (SN: KA021JJ to AN0901028)	◇21332 (SN: KA021JJ to AN0901028)	#29614 (SN: KA020JJ and Below)	#29728 (SN: KA020JJ and Below)	-----
<b>24V</b>	◇80761 (SN: AN0901029 and Above)	◇80858 (SN: AN0901029 And Above)	‡58863 (SN: KA021JJ and Above)	‡64036 (SN: KA021JJ and Above)	-----
<b>24V/50Hz</b>	-----	-----	#34806	#34805	-----
<b>240V/50Hz</b>	-----	-----	#34804	#34803	-----

† - Style 1, Integral lead wires                      ‡ - Style 2, 3 screw terminals  
# - Style 3, 2 screw terminals and/or cover      ◇ - Style 4, 3 spade terminals and ON/OFF switch

NOTE: Part # 16216 and 16380 consist of items 2 and 3 and part # 16217 and 16381 consist of items 2 and 4.

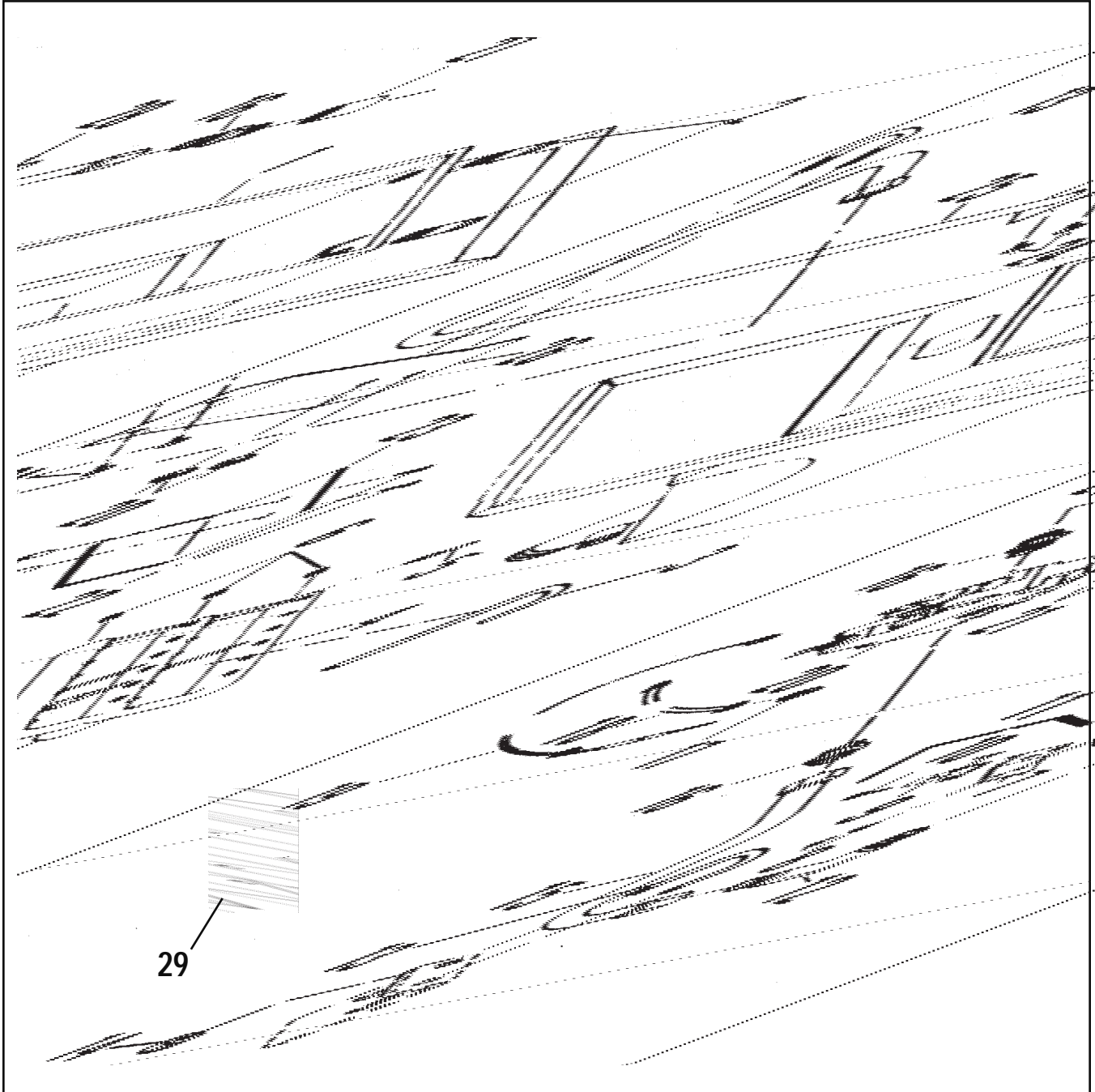
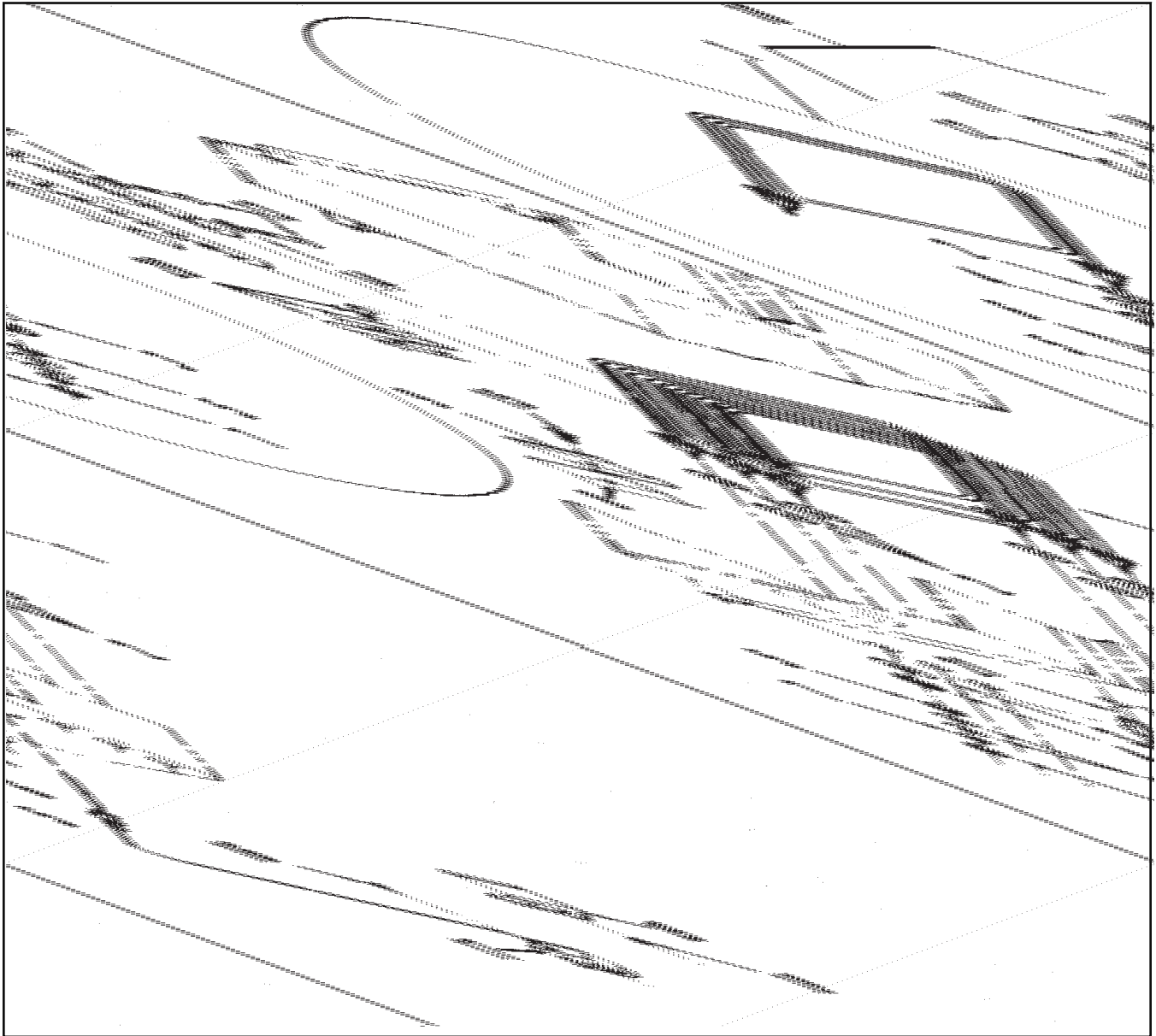


Figure 3-14. Frypot and Gas Burner Assembly

FIGURE & ITEM NO.	PART NUMBER	DESCRIPTION	UNITS PER ASSY
3-14		<b>FRYPOT AND GAS BURNER ASSEMBLY</b>	
1	16889	TOP ASSEMBLY, Pot and Counter (SN: KA020JJ & below) ...	1
1	65007	TOP ASSEMBLY, Pot and Counter (SN: KA021JJ & above) ...	1
2	18816	NIPPLE, Pipe S.S .....	2
3	53834	J-BOLT, Burner Hold Down .....	1
4	16205	CASTING Burner .....	1
5	17013-1	SET, Orifice, Natural Gas .....	1
5	16561-1	ORIFICE, Natural Gas, S.S .....	1
5	16562-1	ORIFICE, Natural Gas, Brass .....	23
5	17013-3	SET, Orifice, Propane Gas .....	1
5	16561-3	ORIFICE, Propane Gas, S.S .....	1
5	16562-3	ORIFICE, Propane Gas, Brass .....	23
6	FP01-020	PLUG, Burner Casting .....	3
7	29969	BRACKET, Pilot Holder .....	1
8	SC01-184	SCREW, Pilot Holder Bracket .....	2
9	Use #11	PILOT & ORIFICE ASSEMBLY .....	1
10	SC01-047	SCREW, Pilot Holder .....	1
11	30904	PILOT & BRACKET ASSEMBLY, LP .....	1
11	30913	PILOT & BRACKET ASSEMBLY, Nat .....	1
12	16336	ELBOW, Male .....	1
13	SC06-013	BOLT, U, Gas Line .....	2
14	NS02-002	NUT, Gas Supply Line Bolt .....	4
15	16333	LINE, Gas Burner to Control .....	1
16	16335	NIPPLE, Close .....	3
17	29820	ORIFICE, Pilot, Natural Gas .....	1
17	32407	ORIFICE, Pilot, Propane Gas .....	1
18	63198	PILOT ASSEMBLY, Gas Tube .....	1
√ 19	16219	THERMOCOUPLE .....	1
√ 20	-----	VALVE, Gas Control - 24V -- See Figure 3-13 .....	1
21	16221	SPACER, Heat Shield .....	2
22	SC01-054	SCREW, Heat Shield .....	2
23	58866	SHIELD, Heat, Aluminum .....	1
24	SC02-006	SCREW, Bracket .....	4
25	40304	LINE, Gas Supply (SN: KA020JJ & below) .....	1
25	16326	LINE, Gas Supply .....	1
26	16331	GAS LINE BRACKET .....	1
27	FP01-007	COUPLING, Pipe .....	1
28	16328	BRACKET, Gas Line .....	1
-	16329	Nut 37 Flare for 5/8 OD .....	2
-	16330	Sleeve 37 Flare for 5/8 .....	2
29	24687	GUARD, Gas Valve Adjustment Screw .....	1
30*	14484	KIT, 3/4 in. x 5 ft. Gas Line w/quick-disconnect .....	1

√ Recommended Parts

\* not shown



**Figure 3-15. Heating Element and High Limit Assembly (Electric Model)**

FIGURE & ITEM NO.	PART NUMBER	DESCRIPTION	UNITS PER ASSY
3-15		HEATING ELEMENT AND HIGH LIMIT ASSEMBLY, (Electric Models)	
√ 1	18233-1	ELEMENT COMPLETE, Heating ..... 208 Volts, 4500 Watts	3
√ 1	18233-2	ELEMENT COMPLETE, Heating ..... 230 Volts, 4500 Watts	3
√ 1	18233-5	ELEMENT COMPLETE, Heating ..... 230 Volts, 3750 Watts	3
√ 1	18233-4	ELEMENT COMPLETE, Heating ..... 208 Volts, 3750 Watts	3
√ 1	18233-6	ELEMENT COMPLETE, Heating ..... 480 Volts, 3750 Watts	3
√ 1	18233-7	ELEMENT COMPLETE, Heating ..... 480 Volts, 4500 Watts	3
2	16855	SEAL O-RING.....	6
3	WA01-005	WASHER, Heating Element, Metal.....	6
4	NS01-017	NUT, Heating Element, Brass.....	6
5	NS01-014	NUT, Heating Element.....	12
6	WA01-007	WASHER, Heating Element.....	12
7	LW01-008	WASHER, Lock, Heating Element.....	6
8	18720	CLAMP, Rear-Hi Limit.....	2
9	18248	CLAMP, Front-Hi Limit.....	2
√ 10	14685	KIT, Spreader Module.....	5
11	18225	SPREADER, Element.....	5
12	18226	BAR, Spreader Lock.....	5
13	SC01-055	SCREW, Element Spreader (including Firebars).....	10
14	LW02-005	WASHER, Lock, Element Spreader.....	10
15	SC01-053	SCREW, 8-32 x 1/2 PH RD SS.....	2
16	SC02-018	SCREW, Thread Forming #8.....	2
√ 17	16738	CONTROL, Hi Limit Temperature.....	1
18	NS02-001	NUT, #10-32 Hex Keps.....	2
19	17216	BRACKET ASS'Y, Hi Limit Thermostat.....	1
20	18211	HOLDER, Thermostat Bulb.....	1
√ 21	14785	ASSEMBLY, Probe/Compression Fitting.....	1

√ Recommended Parts



FIGURE & ITEM NO.	PART NUMBER	DESCRIPTION	UNITS PER ASSY
3-16		<b>CONTROL SHROUD AND COMPONENTS</b> (Three Phase Electric Model)	
1	18514	SHROUD, Three Phase (KB020JJ & below) .....	1
1	59233	SHROUD, Three Phase (KB021JJ to HB013JB) .....	1
1	65864	SHROUD, Three Phase (HB014JB & above).....	1
√ 2	29509	CONTACTOR - 24 Volt.....	1
√ 3	29510	CONTACTOR, Mercury - 24 VAC (Before SN: AA0909048) ....	1
√ 3	65073	CONTACTOR, EM - 24VAC (SN: AA0909048 & Above) .....	1
4	66717	STUD ASSY, Contactor Bracket.....	1
5	FP01-024	BUSHING, Pipe - 1/8-3/8.....	1
√ 6	14785	ASSY, Probe/Compression Fitting.....	1
√ 7	16738	CONTROL, High Limit Temperature.....	1
√ 8	72854	ASSY, Transformer - 24 VAC.....	1
9	17216	ASSY, Bracket - High Limit .....	1
√ 10	24347	ASSY, Current Sense Xformers .....	1
√ 11	18364	ASSY, Fuse Holder - 15 amp .....	2
√ 11	EF02-007	FUSE, 15 amp .....	2
√ 11	EF02-006	HOLDER, Fuse .....	2
12	58850	BRACKET, Double Contactor.....	1
13*	14034	KIT - 1 Phase to 3 Phase Conversion (KB020JJ & below) .....	1
13*	14679	KIT - 1 Phase to 3 Phase Conversion (KB021JJ to HB013JB) ....	1
13*	14680	KIT - 1 Phase to 3 Phase Conversion (HB014JB & above) .....	1

√ Recommended Parts  
\*not shown

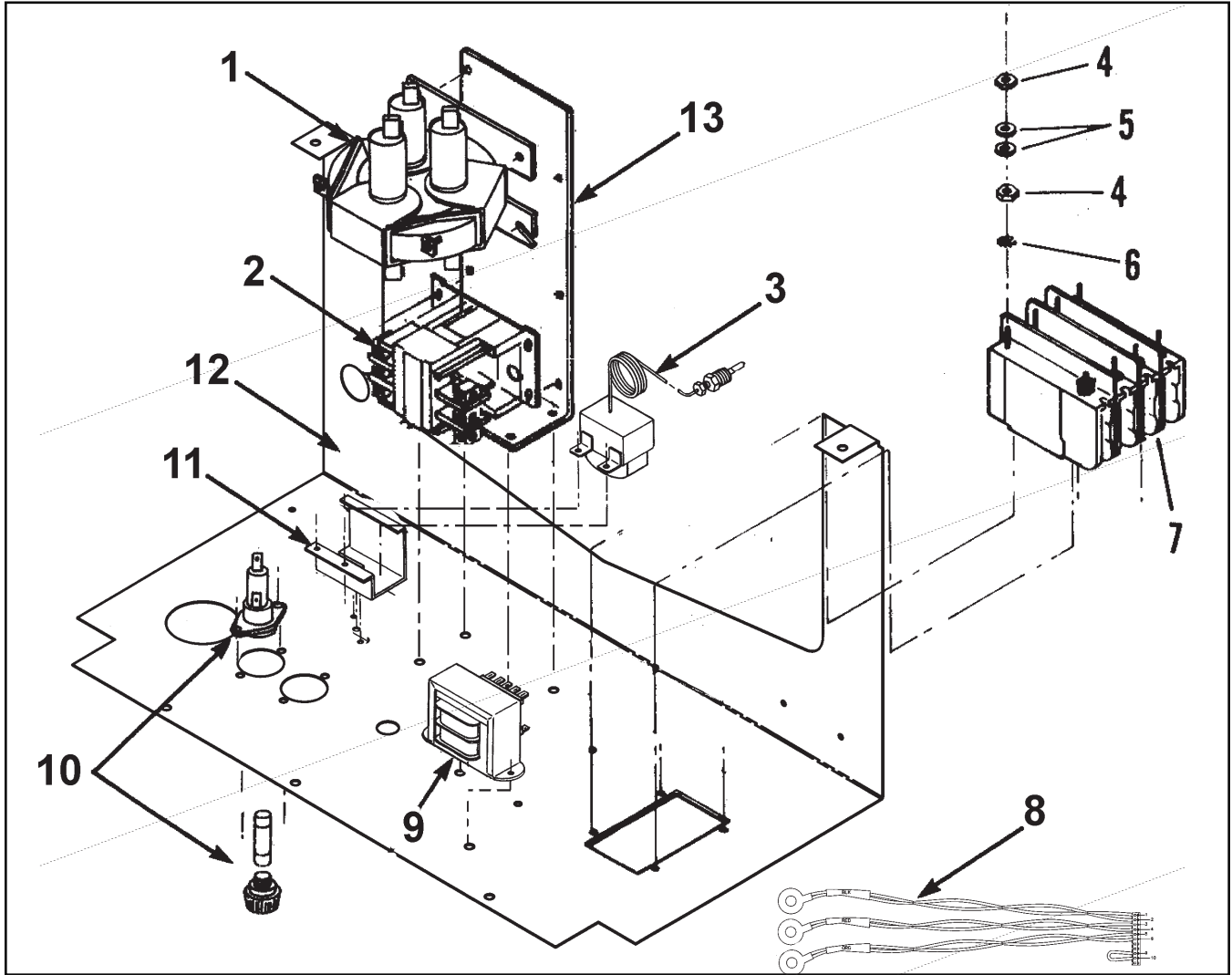


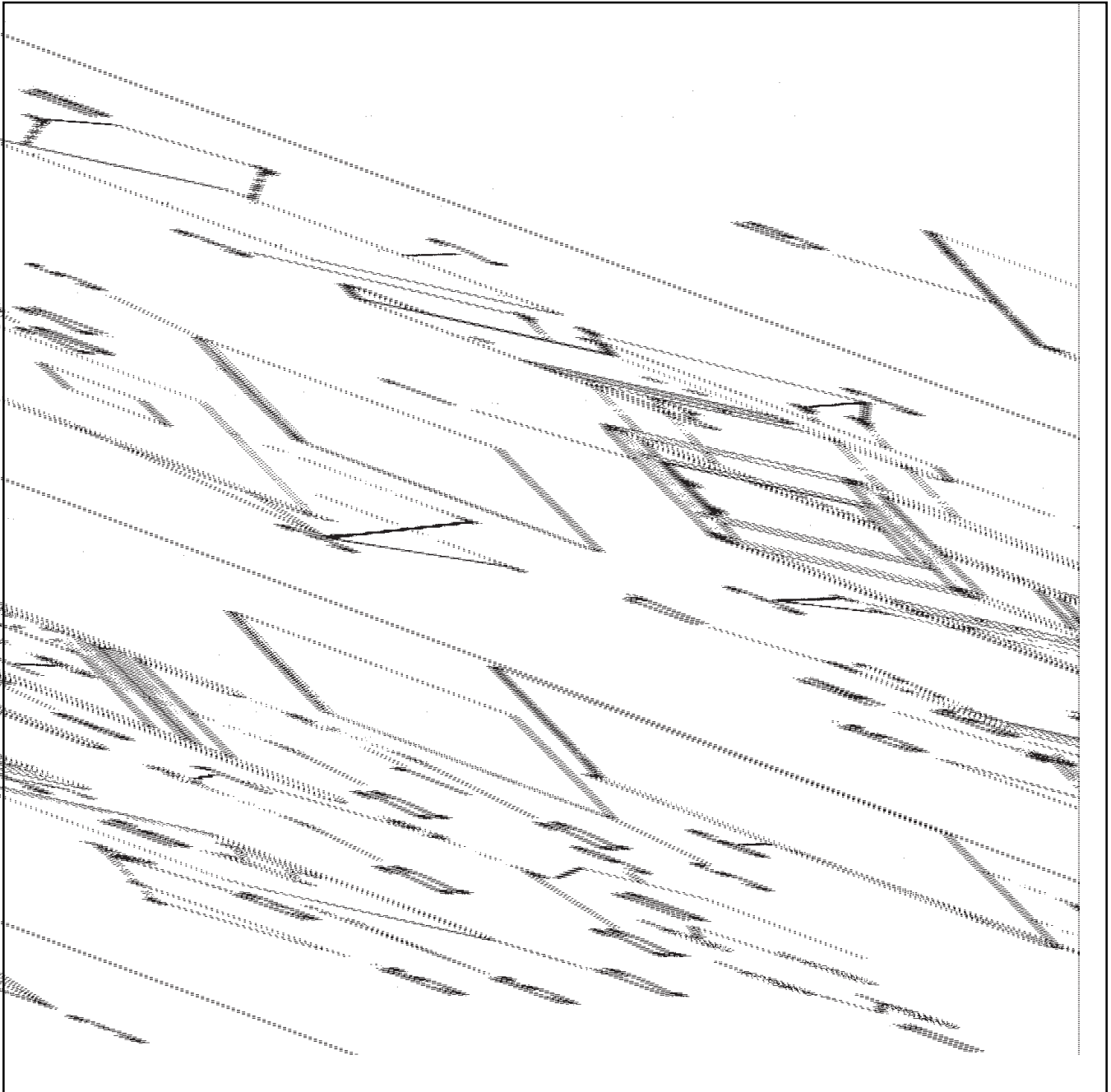
Figure 3-17. Control Shroud and Components (Single Phase Electric Model)



FIGURE & ITEM NO.	PART NUMBER	DESCRIPTION	UNITS PER ASSY
3-17		CONTROL SHROUD AND COMPONENTS, (Electric Model) Single Phase	
√ 1	29510	CONTACTOR, Mercury-24 VAC (Before SN: AA0909048)...	1
√ 1	65073	CONTACTOR, EM-24VAC (SN: AA0909048 & Above) .....	1
√ 2	29509	CONTACTOR - 24 Volt .....	1
√ 3	16738	CONTROL, High Limit Temperature .....	1
4	NS01-014	NUT, Hex .....	16
5	WA01-007	WASHER .....	16
6	LW02-005	LOCKWASHER.....	8
√ 7	18242	BREAKER, CIRCUIT 50 amp .....	1
√ 8	24347	ASSY, Current Sense Xformers .....	1
√ 9	72854	ASSY, Transformer - 24 VAC .....	1
√ 10	18364	ASSY, Fuse Holder - 15 amp .....	2
√ 10	EF02-007	FUSE, 15 amp .....	2
√ 10	EF02-006	HOLDER, Fuse.....	2
11	17216	ASSY, Bracket - High Limit .....	1
12	18244	SHROUD, Single Phase (KB020JJ & below).....	1
12	63226	SHROUD, Single Phase (KB021JJ to HB013JB).....	1
12	27418	SHROUD, Single Phase (HB014JB & above).....	1
13	29687	BRACKET, Double Contactor .....	1
14*	14033	KIT-3 Phase to 1 Phase Conversion (KB020JJ & below).....	1
14*	14677	KIT-3 Phase to 1 Phase Conversion (KB021JJ to HB013JB)...	1
14*	14678	KIT-3 Phase to 1 Phase Conversion (HB014JB & above).....	1

√ Recommended Parts

\*not shown



**Figure 3-18. Frame and Cabinet Assembly**

FIGURE & ITEM NO.	PART NUMBER	DESCRIPTION	UNITS PER ASSY
3-18		FRAME AND CABINET ASSEMBLY	
1		FRAME ASSEMBLY- <b>See chart on next page</b> .....	1
2		COVER, Back Shroud- <b>See chart on next page</b> .....	1
3	SC03-005	SCREW, Panels and Bracket, Sheet Metal .....	22
4		SHROUD ASSEMBLY- <b>See chart on next page</b> .....	1
5	59730	INSULATION, Side Panel, (Gas only).....	2
6		PANEL, Right Side, SS - <b>See chart on next page</b> .....	1
7	54225	INSERT, Aluminum Feet - 1 in. x 1 in.....	4
7	17612	INSERT, Aluminum Feet - 1 in. x 1-1/2 in. ....	4
8	59230	BRACKET, Magnetic Catch.....	1
8	17002	MAGNET .....	1
9	03007	CASTER, Assembly .....	1
10	17630	CASTER, Less Brake .....	2
11	17629	CASTER, w/Brake .....	2
12	17639	DOOR ASSEMBLY, Complete (KB020JJ & below-ele) (KA020JJ & below-gas)	1
12	58849	DOOR ASSEMBLY, Complete (KB021JJ & above-ele) (KA021JJ & above-gas)	1
13	17620	HINGE, Bottom Door.....	1
14	17618	HINGE, Top Door.....	1
15	SC01-072	SCREW, Door Hinge .....	8
16	41836	HANDLE, Door .....	1
17		PANEL, Front, Stainless Steel- <b>See chart on next page</b>	1
18	SC04-003	SCREW, Back Shroud .....	6
19		PANEL, Side Left, SS- <b>See chart on next page</b> .....	1
20	17627	LUG, Grounding.....	1
21	17611	SCREW, Grounding Lug .....	1
22	SC01-143	5/8-18x4 Hex Hd (bright finish) (adjust. legs).....	4
22	SC01-067	5/8-18x3-1/4 Hex Hd (black finish) (adjust. legs) .....	4
23*	NS03-050	NUTSERT, #8-32 Steel CAD Plated (hinge nutserts) ..	4
24*	SC01-234	SCREW, #8-32x1/2 PH Flat Hd (Door to Frame) .....	4

**Frame and Cabinet Assembly**

<b>SN</b>	<b>Item No.</b>	<b>Description</b>	<b>500</b>	<b>600</b>
KB020JJ & Below	2	Front Panel	17602	-
	6	Right Side Panel	17606	-
	19	Left Side Panel	17604	-
KA020JJ & Below	17	Front Panel	-	17602
	2	Back Shroud Cover	-	17346
	4	Shroud Assy	-	18740
	6	Right Side Panel	-	17606
	19	Left Side Panel	-	17604
KB021JJ to HB013JB	2	Back Shroud Cover	64255	-
	4	Shroud Assy	67900	-
	17	Front Panel	56974	-
	1	Frame Assy(long)	64018	-
	1	Frame Assy(short)	64017	-
	6	Right Side Panel	56972	-
	19	Left Side Panel	56973	-
KA021JJ to GA085JB	2	Back Shroud Cover	-	64255
	4	Shroud Assy	-	67900
	17	Front Panel	-	56974
	1	Frame Assy(long)	-	64018
	1	Frame Assy(short)	-	64017
	6	Right Side Panel	-	56972
	19	Left Side Panel	-	56973
HB014JB & Above	2	Back Shroud Cover	24534	-
	4	Shroud Assy	67900	-
	17	Front Panel	24515	-
	1	Frame Assy(short)	23679	-
	1	Frame Assy(long)	26854	-
	6	Right Side Panel	56972	-
	19	Left Side Panel	56973	-
GA086JB & Above	2	Back Shroud Cover	-	24534
	4	Shroud Assy	-	67900
	17	Front Panel	-	24515
	1	Frame Assy(short)	-	23679
	1	Frame Assy(long)	-	26854
	6	Right Side Panel	-	56972
	19	Left Side Panel	-	56973

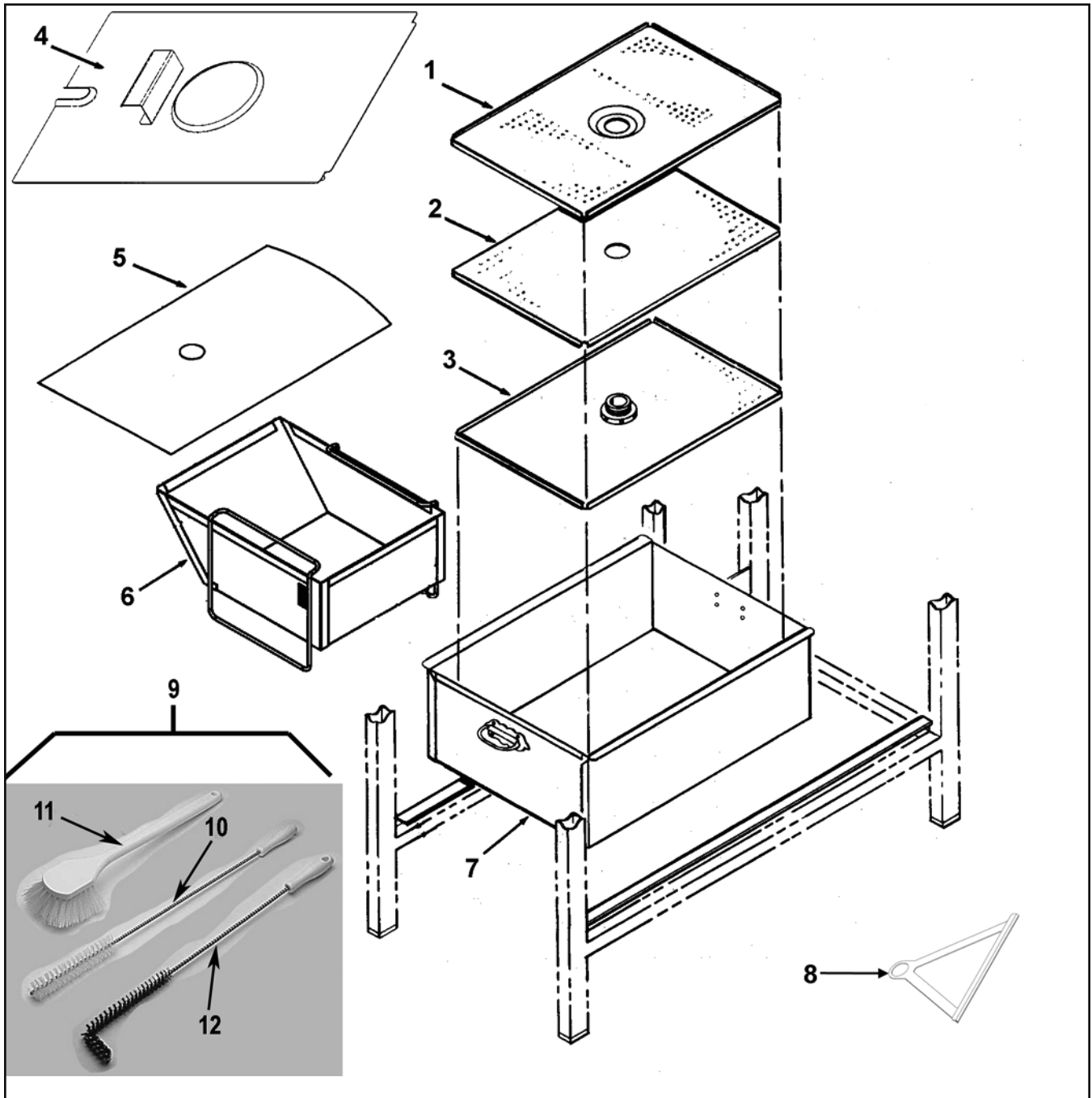


Figure 3-19. Filter Drain Pan and Filter Screen Assembly

FIGURE & ITEM NO.	PART NUMBER	DESCRIPTION	UNITS PER ASSY
3-19		FILTER DRAIN PAN AND FILTER SCREEN ASSEMBLY	
1	65211	CATCHER, Crumb - SS .....	1
2	NLA	SCREEN, Top Filter .....	1
3	Order 1, 3, & 8	SCREEN, Bottom Filter(SN: AA0503097 & below-500)..... (SN: AN0503086 & below-600)	1
3	65447	SCREEN, Bottom Filter-SS(SN: AA0503098 & above-500) 1 (SN: AN0503087 & above-600)	
4		COVER, Filter Drain Pan- <b>See chart on next page</b> .....	1
4		KIT, Cover/Drain Extension- <b>See chart on next page</b> .....	1
√ 5	12102	FILTER, Envelope Paper (100 per carton) .....	1
√ 5	24262	CARBON PAD, Filter Envelope (30 per carton) .....	1
√ 5	24263	CARBON, Filter Envelope (30 per carton) .....	1
6	03553	ASSY, Crumb Catcher-Model 500 (SN: HB013JB & below)	1
6	32882	ASSY, Crumb Catcher-Model 500 (SN: HB014JB & above)	1
6	03554	ASSY, Crumb Catcher-Model 600 (SN: GA085JB & below)	1
6	65127	ASSY, Crumb Catcher-Model 600 (SN: GA086JB & above)	1
7		PAN, Filter Drain Assembly- <b>See chart on next page</b> .....	1
7	23499	PAN, Filter Drain Assy. (CFA- SN: JB095JA to HB013JB) ..	1
8	62116	BAR, Filter Sealer .....	1
√ 9	14461	KIT, Brush Set .....	1
10	12112	BRUSH, Straight White .....	1
11	12116	BRUSH, Fryer - Gong - Long Handle.....	1
12	12126	BRUSH, Black L Tipped .....	1
13*		FILTER PAN DOLLY- <b>See chart on next page</b> .....	1

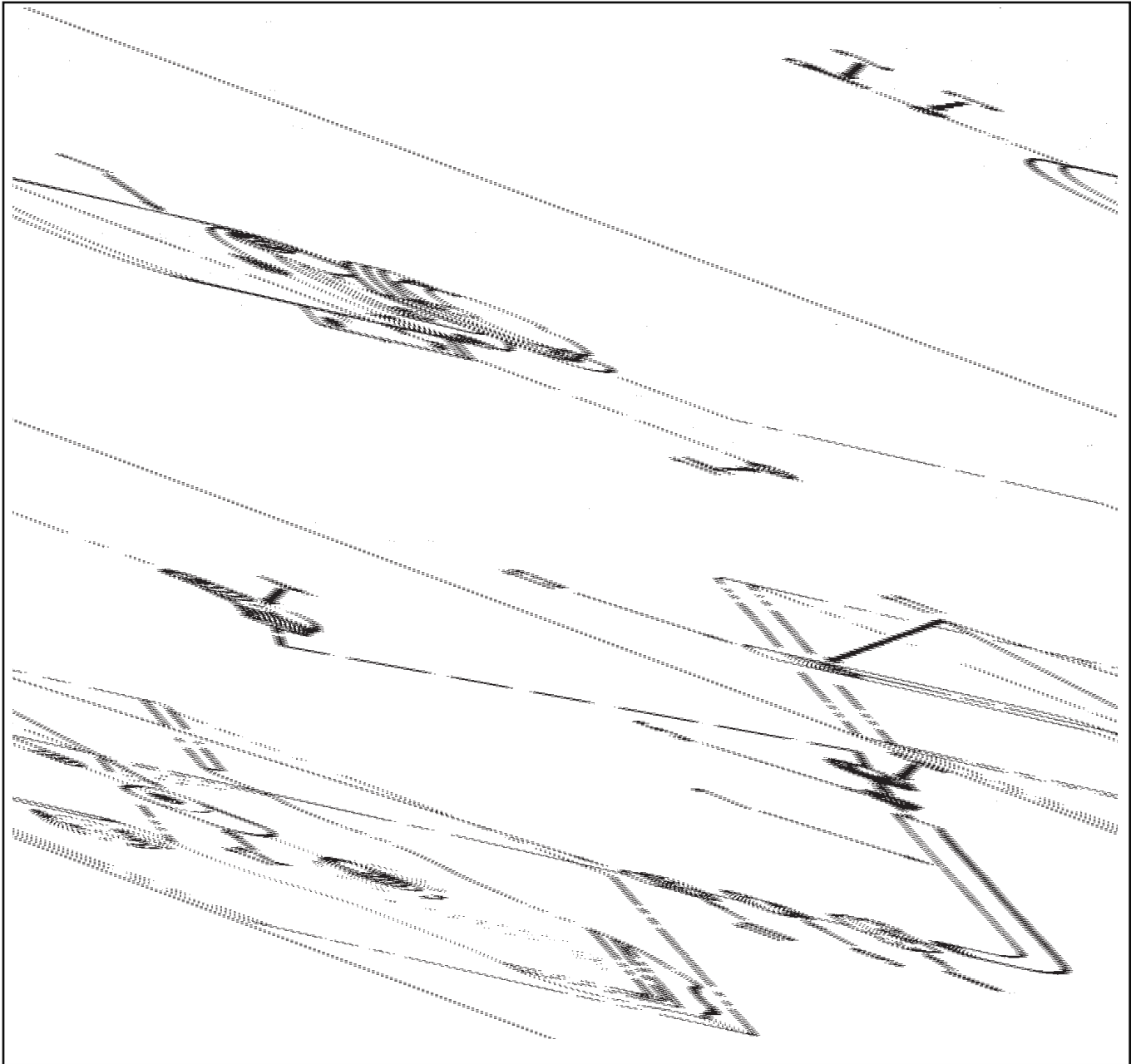
√ Recommended Parts

\*not shown

NLA - No Longer Available

**Standard Filter Pan & Cover Assys.**

<b>SERIAL NUMBER</b>	<b>DESCRIPTION</b>	<b>MODEL 500</b>	<b>MODEL 600</b>
KB020JJ & Below	Pan Cover	18915	----
	Pan	19206	----
	Pan Dolly	03387	----
KA020JJ & Below	Pan Cover	----	17512
	Pan	----	17506
	Pan Dolly	----	03352
KB021JJ to BB016JA	Pan Cover	64024	----
	Pan	58848	----
	Pan Dolly	03389	----
	Cover/Drain Ext. Kit	14414	----
KA021JJ to BA026JA	Pan Cover	----	64023
	Pan	----	58848
	Pan Dolly	----	03389
BB017JA to HB013JB	Pan Cover	64021	----
	Pan	64014	----
	Pan Dolly	03391	----
	Cover/Drain Ext. Kit	14415	----
BA027JA to GA085JB	Pan Cover	----	64020
	Pan	----	64014
	Pan Dolly	----	03391
HB014JB & Above	Pan Cover	68065	----
	Pan	24702	----
	Pan Dolly	03343	----
GA086JB & Above	Pan Cover	----	68066
	Pan	----	17506
	Pan Dolly	----	03352



**Figure 3-20. Lower Filter Plumbing Components**

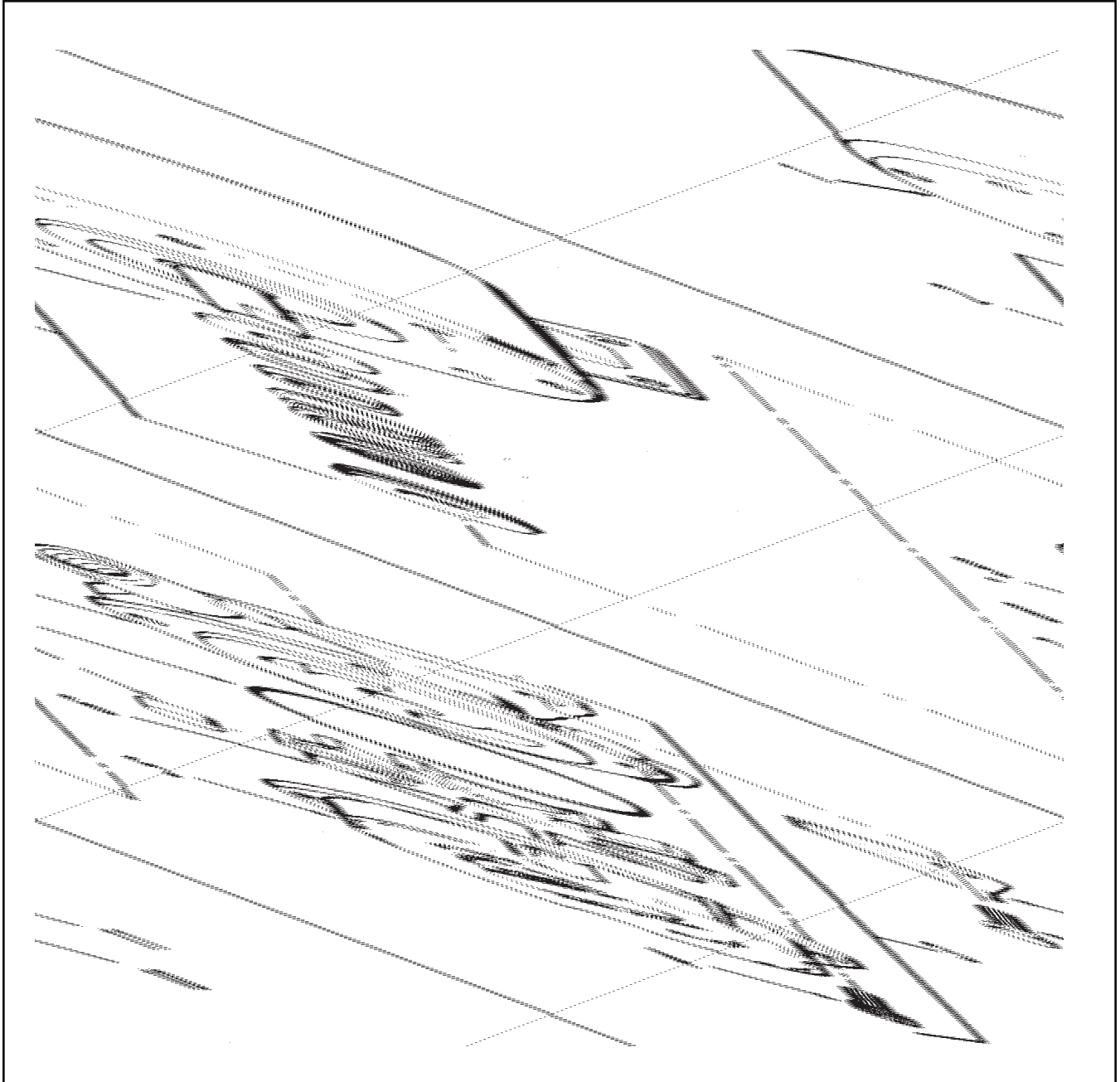


FIGURE & ITEM NO.	PART NUMBER	DESCRIPTION	UNITS PER ASSY
3-20		LOWER FILTER PLUMBING COMPONENTS (Gas and Electric Models)	
1	67589	MOTOR AND PUMP, Filter.....	1
√	67583	MOTOR Only - 1/2 Horse Power.....	1
	17437	PUMP Only.....	1
√	17476	SEAL KIT, Pump.....	1
2	SC01-022	SCREW, Motor .....	8
3	WA01-002	WASHER .....	8
4	17407	CONNECTOR, Male Elbow .....	1
5	16808	FITTING, Sleeve .....	1
6	16809	NUT Fitting.....	1
7		PUMP RETURN TUBE- <b>See chart next page</b> .....	1
√ 8	17432(use69289)	FITTING, Union Handle .....	1
√ 9	17431(use69289)	FITTING, Male Union.....	1
√ 10	17430(use69289)	FITTING, Female Union (Also included with item 11) .....	1
11		STANDPIPE ASSY, Filter Screen- <b>See chart next page</b> ....	1
12	65208	NUT, Filter Screen - SS .....	1
13		TUBING- <b>See chart next page</b> .....	1
14	NS02-002	NUT, Motor.....	4

√ Recommended Parts

### Lower Filter Plumbing Components

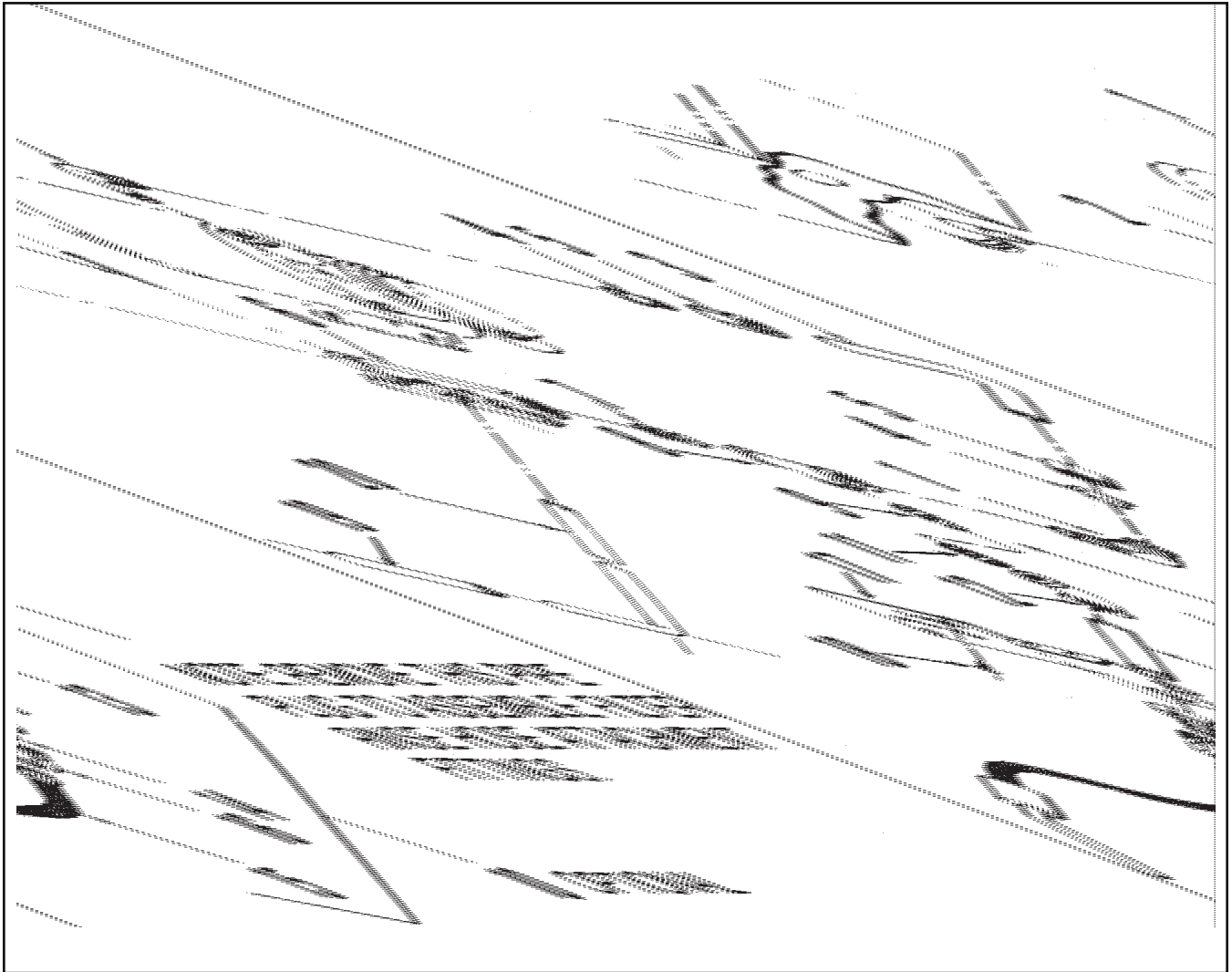
SN		500	600
KB020JJ & Below	Standpipe Assy	19102	-
	Standpipe Tube	19101	-
	Pump Return Tube Assy	16812 (includes 16808 & 16809)	-
	Pump Return Tube	64331 (use if pan has cover)	-
KA020JJ & Below	Standpipe Assy	-	17433
	Standpipe Tube	-	55367
	Pump Return Tube Assy	-	16812 (includes 16808 & 16809)
	Pump Return Tube	-	64331 (use if pan has cover)
KB021JJ to HB013JB	Standpipe Assy	14732	-
	Standpipe Tube	70061	-
	Pump Return Tube	58877	-
KA021JJ to GA085JB	Standpipe Assy	-	14732
	Standpipe Tube	-	70061
	Pump Return Tube	-	58877
HB014JB & Above	Standpipe Assy	14659	-
	Standpipe Tube	23951	-
	Pump Return Tube Assy	23800 (includes 16808 & 16809)	-
GA086JB & Above	Standpipe Assy	-	14664
	Standpipe Tube	-	24284
	Pump Return Tube Assy	-	23800 (includes 16808 & 16809)



**Figure 3-21. Filter Motor and Pump**

FIGURE & ITEM NO.	PART NUMBER	DESCRIPTION	UNITS PER ASSY
3-21		FILTER MOTOR AND PUMP	
√ 1	67583	MOTOR, 1/2 HP - 50/60 Hz .....	1
√ 2	17476	SEAL KIT .....	1
3	17437	PUMP ASSEMBLY.....	1
√ 4	SC01-132	SCREW, Pump Cover .....	1
√ 5	17451	COVER, Pump.....	1
√ 6	17447	ROTOR, Pump.....	1
√ 7	17446	ROLLER, Pump.....	5
√ 8	17453	O-RING.....	1
√ 9	17454	BODY, Pump .....	1
√ 10	17456	SHIELD, Pump.....	2
√ 11	SC01-026	SCREW, Pump Shield.....	1

√ Recommended Parts



**Figure 3-22. Upper Filter Plumbing Components**

FIGURE & ITEM NO.	PART NUMBER	DESCRIPTION	UNITS PER ASSY
3-22	UPPER FILTER PLUMBING COMPONENTS		
1	17407	CONNECTOR, Male Elbow .....	2
2	17255	PIN, Cotter, Valve .....	1
3		TUBING, Stainless Steel- <b>See chart next page</b> .....	1
4	16808	FITTING, Sleeve .....	2
5	16809	NUT, Fitting.....	2
√ 6	17308	VALVE ASSEMBLY, Filter .....	1
7	FP02-001	NIPPLE, Close.....	1
8	17306	TEE, Pipe .....	1
9	FP01-015	PLUG, Pipe.....	1
10	03001	HOSE ASSY, Filter Rinse Optional (models 500).....	1
10	03002	HOSE ASSY, Filter Rinse Optional (models 600).....	1
11	FP02-007	NIPPLE, Pipe.....	1
12	17319	ELBOW, Pipe.....	1
13		NIPPLE, Rinse Hose Pipe- <b>See chart next page</b> .....	1
14	17334	FITTING, Rinse Hose Disconnect, Male .....	1
15	03003	HOSE, Filter Rinse .....	1
16	17333	FITTING, Rinse Hose Disconnect - Female.....	1
17		BRACKET, Rinse Hose- <b>See chart next page</b> .....	1
18	SC03-005	SCREW, Rinse Hose Bracket .....	2
19	16293	COVER, Valve Rod .....	1
20	17311	ROD, Filter Valve Extension (model 600).....	1
20	18911	ROD, Filter Valve Extension (models 500) .....	1

√ Recommended Parts

**Pump to Valve Tube**

<b>SN</b>	<b>Item No.</b>		<b>500</b>	<b>600</b>
KB020JJ & Below	3	Pump to Valve Tube	18904	-
	13	Rinse Hose Pipe Nipple	17320	-
	17	Filter Valve & Rinse Hose Brkt	18419	-
KA020JJ & Below	3	Pump to Valve Tube	-	17329
	13	Rinse Hose Pipe Nipple	-	17320
	17	Filter Valve & Rinse Hose Brkt	-	17224
KB021JJ to HB013JB	3	Pump to Valve Tube	63134	-
	13	Rinse Hose Pipe Nipple	17320	-
	17	Filter Valve & Rinse Hose Brkt	63193	-
KA021JJ to GA085JB	3	Pump to Valve Tube	-	63246
	13	Rinse Hose Pipe Nipple	-	17320
	17	Filter Valve & Rinse Hose Brkt	-	17224
HB014JB & Above	3	Pump to Valve Tube	27405	-
	13	Rinse Hose Pipe Nipple	24982	-
	17	Filter Valve & Rinse Hose Brkt	23917	-
GA086JB & Above	3	Pump to Valve Tube	-	27456
	13	Rinse Hose Pipe Nipple	-	24982
	17	Filter Valve & Rinse Hose Brkt	-	27457

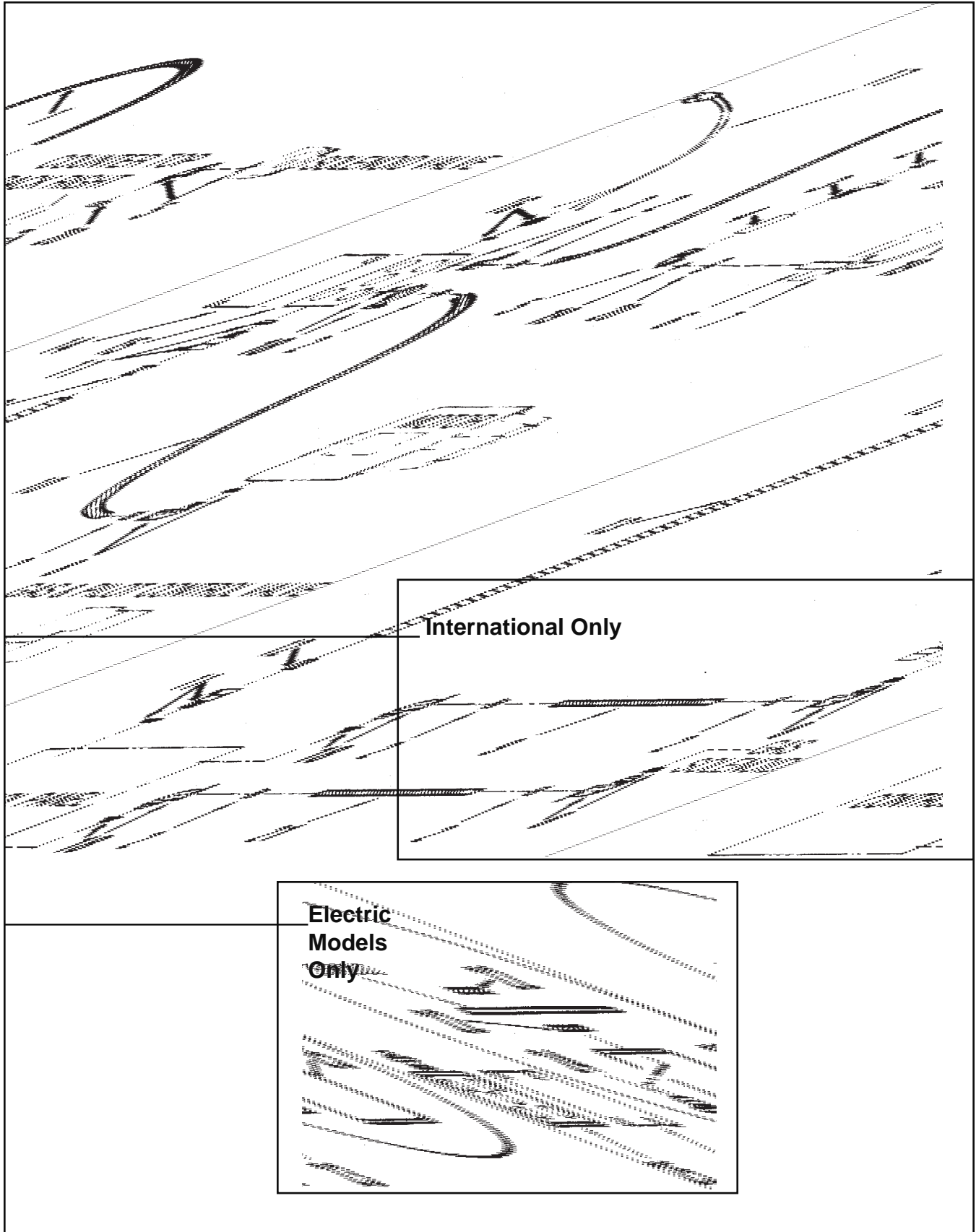


Figure 3-23. Electric Conduit Assembly



FIGURE & ITEM NO.	PART NUMBER	DESCRIPTION	UNITS PER ASSY
3-23		ELECTRIC CONDUIT ASSEMBLY	
1	18527	CONDUIT, Flexible.....	1
2	18105	BUSHING, Anti Short .....	8
3	18111	CONNECTOR, Conduit .....	2
4	FP01-018	COUPLING, Pipe .....	1
5	18113	CONNECTOR, Conduit, 90° .....	2
6	59218	TUBE, Conduit - Solenoid.....	1
7	16804	GROMMET, Umbrella .....	1
8	18107	CONNECTOR, Conduit, 90° .....	1
9	17221	CONDUIT, Flexible .....	1
10	30291	CONDUIT, Flexible .....	1
11	18104	CONNECTOR, Conduit .....	2
12	18108	BUSHING, Anti Short .....	2
13	33628	CONDUIT, Flexible .....	1
14	18101	COVER, Junction Box .....	1
15	18102	BOX, Junction .....	1
16	18103	CONNECTOR, Power Cord .....	1
17	53656	CORD, Power, With Grounded Plug - Gas Models only...	1
17	83889	CORD ASSY, 12 Gauge, CFA (480V).....	1
18	18644	CONDUIT CONNECTOR .....	1
19	16817	SLEEVE, Teflon.....	2
20	16809	NUT, Fitting.....	2
21	44814	CONDUIT, Flexible.....	1
22	19617	NUT, Lock, 3/4 inch .....	2
23	19708	COVER, Junction Box.....	1
24	19616	NIPPLE, 3/4 inch Chase .....	1
25	19707	BOX, Main Power Junction.....	1

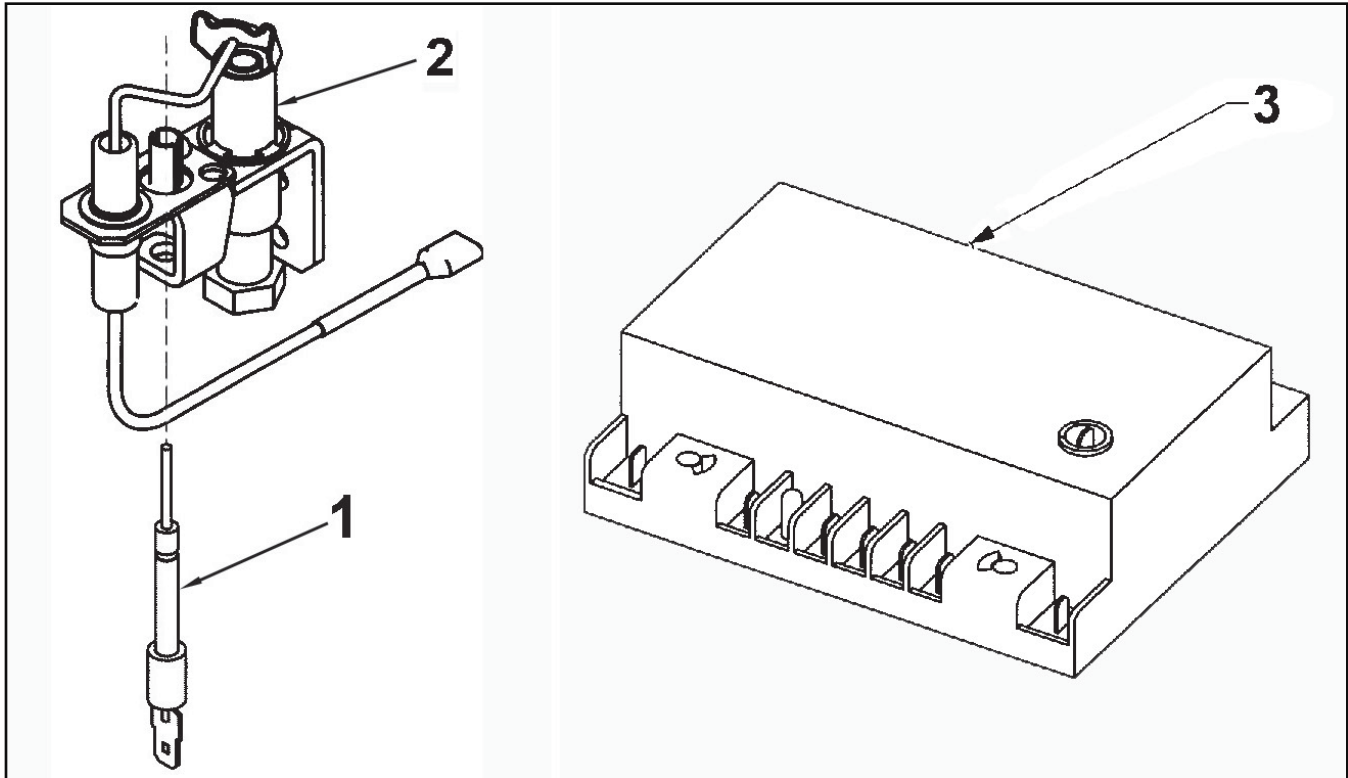


FIGURE & ITEM NO.	PART NUMBER	DESCRIPTION	UNITS PER ASSY
3-24		<b>ELECTRONIC IGNITION ASSEMBLY (July 10, 2006 and after)</b>	
√ 1	60292	SENSOR-FLAME, Pilot.....	1
√ 2	67227	ELECTRODE, Spark/Sense .....	1
√ 3	77839	IGNITION MODULE .....	1

√ Recommended Parts  
\*not shown