

Henny Penny Evolution Elite®

**Reduced Oil Capacity Open Fryers
(Split Vat & Full Vat– Electric)**

Model EEE-142

Model EEE-142

Model EEE-143

Model EEE-144

TECHNICAL MANUAL

TABLE OF CONTENTS

Section	Page
Section 1. TROUBLESHOOTING.....	1-1
1-1 Introduction	1-1
1-2 Safety	1-1
1-3 Troubleshooting.....	1-2
1-4 Error Code Table	1-6
Section 2. INFO & FILTER BUTTON STATS.....	2-1
2-1 INFO Button Stats	2-1
2-2 FILTER Button Stats	2-1
Section 3. INFORMATION MODE.....	3-1
3-1 Information Mode Details	3-1
Section 4. Product Program Mode	4-1
4-1 Modifying Product Settings.....	4-1
Section 5. LEVEL 2 PROGRAMMING	5-1
5-1 Special Program Mode	5-1
5-2 Do Not Disburb	5-10
5-3 Clock Set	5-11
5-4 Data Logging, Heat Control, Tech, Stat & Filter Control Modes	5-11
5-5 Tech Mode	5-12
5-6 Stats Mode	5-18
Section 6. MAINTENANCE SECTION.....	6-1
6-1 Intoduction.....	6-1
6-2 Maintenance Hints.....	6-1
6-3 Preventive Maintenance	6-1
6-4 Control Panel and Menu Card Replacement	6-2
6-5 High Temperature Limit Control.....	6-3
6-6 Breakers.....	6-7
6-7 Main Power switch.....	6-8

TABLE OF CONTENTS

Section	Page
Section 6. MAINTENANCE SECTION (Continued)	
6-8 Temperature Probe Replacement.....	6-8
6-9 Oil Channel Clean-Out.....	6-10
6-10 Element Safety Switch	6-11
6-11 Contactors.....	6-12
6-12 Solenoid Valves	6-14
6-13 Filter Pump & Motor	6-16
6-14 JIB Pump	6-19
6-15 Express Filter PC Board.....	6-19
6-16 Transformers.....	6-20
6-17 Filter Motor Relay	6-21
6-18 Drain Pan Switch.....	6-22
6-19 Filter Beacon®.....	6-23
6-20 Oil Level Probes.....	6-24
6-21 Drain Rod Switch.....	6-26
Wiring Diagrams - 208/240V	6-27
Wiring Diagrams - 380-415V	6-33
 Section 7. PARTS SECTION	
7-1 Introduction	7-1
7-2 Genuine Parts	7-1
7-3 How To Order.....	7-1
7-4 Prices	7-1
7-5 Delivery	7-1
7-6 Warranty	7-1
Spare Parts Lists	

SECTION 1. TROUBLESHOOTING

1-1. INTRODUCTION

This section provides troubleshooting information in the form of an easy to read table.

If a problem occurs during the first operation of a new fryer, recheck the installation per the Installation Section of this manual.

Before troubleshooting, always recheck the operation procedures per Section 3 of this manual.

1-2. SAFETY

Where information is of particular importance or safety related, the words DANGER, WARNING, CAUTION, and NOTICE are used. Their usage is described below.



SAFETY ALERT SYMBOL is used with DANGER, WARNING, or CAUTION which indicates a personal injury type hazard.



NOTICE is used to highlight especially important information.



CAUTION used without the safety alert symbol indicates a potentially hazardous situation which, if not avoided, may result in property damage.



CAUTION indicates a potentially hazardous situation which, if not avoided, may result in minor or moderate injury.



WARNING indicates a potentially hazardous situation which, if not avoided, could result in death or serious injury.



DANGER INDICATES AN IMMINENTLY HAZARDOUS SITUATION WHICH, IF NOT AVOIDED, WILL RESULT IN DEATH OR SERIOUS INJURY.



1-3. TROUBLESHOOTING

To isolate a malfunction, proceed as follows:

1. Clearly define the problem (or symptom) and when it occurs.
2. Locate the problem in the Troubleshooting table.
3. Review all possible causes. Then, one-at-a-time work through the list of corrections until the problem is solved.
4. Refer to the maintenance procedures in the Maintenance Section to safely and properly make the checkout and repair needed.



If maintenance procedures are not followed correctly, injuries and/or property damage could result.

Problem	Cause	Correction
POWER switch ON but fryer completely inoperative	<ul style="list-style-type: none"> Open circuit 	<ul style="list-style-type: none"> Plug fryer in Check breaker or fuse at supply box (Non-US/some Int'l. locations only) Breakers in fryer tripped-open left door and reset breaker on fryer; See below 
Oil will not heat but lights are on	<ul style="list-style-type: none"> All power cords not plugged-in 	<ul style="list-style-type: none"> Unit has 2 power cords; make sure both are plugged-in
Control error code "E-10"	<ul style="list-style-type: none"> Open high limit circuit 	<ul style="list-style-type: none"> Let unit cool down (15-20 minutes), reset the high limit using the high limit tool on the inside of the LH door and gently pushing it into the hole in the heating element hinge; if high limit does not reset, high limit must be replaced 
Vat is under-filled	<ul style="list-style-type: none"> JIB is low or empty JIB oil line is clogged or collapsed Filter pan needs cleaned 	<ul style="list-style-type: none"> Fill the JIB Check JIB line Clean filter pan and change paper or pad

Problem	Cause	Correction
Oil foaming or boiling over top of vat	<ul style="list-style-type: none"> • Water in oil • Improper or bad oil • Improper filtering • Improper rinsing after cleaning the vat 	<ul style="list-style-type: none"> • Drain and clean oil • Use recommended oil • Refer to filtering procedures • Clean and rinse vat and then dry thoroughly
Oil will not drain from vat	<ul style="list-style-type: none"> • Drain valve clogged with crumbs • Drain trough clogged 	<ul style="list-style-type: none"> • Open valve, force cleaning brush through drain • Remove right side panel and remove plug from end of trough and clean trough
Filter motor runs but pumps oil slowly	<ul style="list-style-type: none"> • Filter line connections loose • Filter paper or pad clogged 	<ul style="list-style-type: none"> • Tighten all filter line connections • Change filter paper or pad
Bubbles in oil during entire filtering process	<ul style="list-style-type: none"> • Filter pan not completely engaged • Filter pan clogged • Damaged O-ring on filter line receiver on fryer 	<ul style="list-style-type: none"> • Make sure filter pan return line is pushed completely into the receiver on the fryer • Clean pan and change paper or pad Change O-ring
Control error code "E-31"	<ul style="list-style-type: none"> • Elements are up 	<ul style="list-style-type: none"> • Lower elements back into vat
Filter motor will not run	<ul style="list-style-type: none"> • Power cord for vat #1 is not plugged-in • Open circuit • the thermal reset button on the rear of the pump motor is tripped 	<ul style="list-style-type: none"> • Plug power cord into receptacle • Breakers in fryer tripped; open left door and reset breaker on fryer • Allow time for the motor to cool and then, using a screwdriver, press hard against the button until it clicks 

DISPLAYED PROMPT SECTION		
“IS POT FILLED” filter error prompt	<ul style="list-style-type: none"> • All oil did not completely return after a filter cycle 	<ul style="list-style-type: none"> • Have manager follow prompts • Is JIB full? If not, fill JIB
“CHECK PAN” prompt	<ul style="list-style-type: none"> • Filter pad clogged 	<ul style="list-style-type: none"> • Replace filter pad/clean pan.
“FILTER PAN MISSING” prompt appears	<ul style="list-style-type: none"> • Filter pan not completely engaged • Filter pan missing • Filter pan interlock not engaged 	<ul style="list-style-type: none"> • Adjust filter pan • Find pan and replace • Adjust filter pan to engage interlock
“CHANGE FILTER PAD” prompt appears	<ul style="list-style-type: none"> • Filter pad has not been changed within a 24hr time period; Main power switch was turned off during filter pad change • Drain pan microswitch stuck 	<ul style="list-style-type: none"> • Replace old filter pad with NEW filter pad with main power switch turned on. *NOTE* 24/7 store replace filter twice a day. • Check microswitch

1-4. ERROR CODES

In the event of a control system failure, the digital display shows an error message. The message codes are shown in the DISPLAY column below. A constant tone is heard when an error code is displayed, and to silence this tone, press any button.

<u>DISPLAY</u>	<u>CAUSE</u>	<u>CORRECTION</u>
"E-4"	Control board overheating	Turn switch to OFF position, then turn switch back to ON; if display shows "E-4", the control board is getting too hot; check the louvers on each side of the unit for obstructions
"E-5"	Oil overheating	Turn switch to OFF position, then turn switch back to ON; if display shows "E-5", the heating circuits and temperature probe should be checked
"E-6A"	Temperature probe open	Turn switch to OFF position, then turn switch back to ON; if display shows "E-6A", the temperature probe should be checked
"E-6B"	Temperature probe shorted	Turn switch to OFF position, then turn switch back to ON; if display shows "E-6B", the temperature probe should be checked
"E-10"	High limit	Let unit cool down (15-20 minutes), using the high limit tool on the inside of the LH door and gently pushing it into the hole in the heating element hinge; if high limit does not reset, high limit must be replaced 
"E-15"	Drain Switch	Make sure drain knob is completely pushed-in; if E-15 persists, have drain switch checked
"E-18-A" "E-18-B" "E-18-C"	Left level sensor open Right level sensor open Both level sensors open	Turn switch to OFF position, then turn switch back to ON; if display still indicates a failed sensor, have the connections checked the control board; have sensor checked & replaced if necessary

1-4. ERROR CODES (Continued)

DISPLAY	CAUSE	CORRECTION
"E-21"	Slow heat recovery	Have a certified service technician check the fryer for correct voltage to the unit; have the contactors and heating element checked; have unit checked for loose or burnt wires
"E-31"	Elements are up	Lower elements back into the vat
"E-41", "E-46"	Programming failure	Turn switch to OFF, then back to ON; if display shows any of these error codes, have the controls re-initialized; if error code persists, have the control board replaced
"E-47"	Analog converter chip or 12 volt supply failure	Turn switch to OFF, then back to ON; if "E-47" persists, have the I/O board, or the PC board replaced; if speaker tones are quiet, probably I/O board failure; have the I/O board replaced
"E-48"	Input system error	Turn switch to OFF, then back to ON; have control PC board replaced if "E-48" persists
"E-54C"	Temperature input error	Turn switch to OFF, then back to ON; have control PC board replaced if "E-54C" persists
"E-60"	AIF PC board not communicating with control PC board	Turn switch to OFF, then back to ON; if "E-60" persists, have the 1.5 amp fuse on the AIF PC board checked; have the connector between the PC boards checked; replace AIF PC board or control PC board if necessary
"E-93-A" "24 VDC" "SUPPLY TRIPPED"	Autolift motor malfunction or failure	If AutoLift feature is not operating, have each of the AutoLift motors checked.

SECTION 2. INFO & FILTER BUTTON STATS

2-1. INFO BUTTON STATS

Actual Oil Temperature

1. Press  and the actual oil temperature shows in the display, for each vat.

Set-point Temperature

2. Press  twice and SP shows in the display, along with the set-point (preset) temperature of each vat.

Recovery Information for each Vat

1. Press  3 times and REC shows in the left display and the recovery time that oil temperature went from 250°F (121°C) to 300°F (149°C) shows in the right display. For example,

REC	5:30
-----	------

 means it took 5 minutes and 30 seconds for the oil temperature to recover to 300°F (149°C) from 250°F (121°C).

NOTICE

If no buttons are pressed within 5 seconds in any of stats modes, the controls revert back to normal operation.

2-2. FILTER BUTTON STATS

Cook Cycles Remaining before Filtering

1. Press and release either  button and the left display shows “COOKS REMAINING” and the right display shows the number of cook cycles before the next auto filter. For example,

REMA	INING	3	6
------	-------	---	---

means after 3 more cook cycles on the left vat, the controls asks the operator if they are ready to filter or not. But, 6 more cook cycles remain on the right vat.

Time and Date

2. Press either  twice and ‘FILTERED’ shows in the displays, along with the time-of-day and date of the last filter.

SECTION 3. INFORMATION MODE

This historic information can be recorded and used for operational and technical help and allows you to view the following:



- 1. E-LOG
- 2. LAST LOAD
- 3. DAILY STATS
- 4. OIL STATS
- 5. REVIEW USAGE
- 6. INPUTS
- 7. OUTPUTS
- 8. OIL TEMP
- 9. CPU TEMP
- 10. COMMUNICATION INFO
- 11. ANALOG INFO
- 12. ACTIVITY LOG
- 13. OIL LEVELS
- 14. PUMP VALVE INFO
- 15. AIF INFO

NOTICE

Not all Information Mode functions are discussed in this section. To ensure proper operation of fryer, please consult Henny Penny Corp. before changing any of these settings. For more information on these functions, contact Technical Support at 1-800-417- 8405, or 1-937-456-8405.



3-1. INFORMATION MODE DETAILS

1. E-LOG (error code log)

Press  and  buttons at the same time and “*INFO

MODE*” shows in the display, followed by “1. E-LOG”.

NOTICE

Press  and  to exit Information Mode at any time.

Press  and “A. (date & time) *NOW* show in displays. This is the present date and time.

Press  and if a error was recorded, “B. (date, time, and error code information)” shows in display. This is the latest error code that the controls recorded.



Press  and the next latest error code information can be seen.

Up to 10 error codes (B to K) can be stored in the E-LOG section.

3-1. INFORMATION MODE
DETAILS (Continued)

2. LAST LOAD (Information on recent cook cycles)

Press  and “2. LAST LOAD” show in displays.

Press a timer button  or  for the product you want to view the cook data and the LED flashes.

Press  button to start viewing the cook data.

For example, if the left  LED is flashing, “PRODUCT FRY L1” show in displays.

If the right  LED is flashing, “PRODUCT FRY R2” show in displays.

Press  button to start viewing the cook data.

FUNCTION	DISPLAY EX:
Product (Last product cooked)	PRODUCT FRY L1
Time of day the last Cook Cycle was started	STARTED FEB 4 2:25P
Actual Elapsed cook Time (Real seconds)	ACTUAL TIME 1:06
Programmed cook Time	PROG TIME 1:00
Max Temp during Cook Cycle	MAX TEMP 350°F
Min Temp during Cook Cycle	MIN TEMP 313°F
Avg Temp during Cook Cycle	AVG TEMP 322°F
Heat On (percentage) during Cook Cycle	HEAT ON 45%
Ready? (Was fryer Ready before start?)	READY? YES
When Cook Cycle was stopped: Early	QUIT AT 0:10 REM OR
After complete Cook Cycle	*DONE* +6 SEC
Difference (%) between actual and programmed cook time	ACT/PROG 1%

3-1. INFORMATION MODE
DETAILS (Continued)

3. DAILY STATS (Operational info of fryer for last 7 days)

Press  and “3. DAILY STATS” show in displays.

Press  button to start viewing the cook data.

Press the right  to view data for other days of week.

FUNCTION

DISPLAY EX:

Day this data was recorded for	APR-30	TUE*
Number of Hours:Minutes the fryer was on	(L/R) ON HRS	TUE* 3:45
Number of times filtered	(L/R) FILTERED	TUE* 4
Number of times filter skipped	(L/R) SKIPPED	TUE* 4
Number of times oil added	(L/R) ADD OIL	TUE* 4
Number of times oil discarded	(L/R) DISPOSE	TUE* 0
Oil temperature recovery time	(L/R) RECOVERY	TUE* 1:45
Total number of cook cycles that day	(L/R) TOT CK	TUE* 38
Number of cycles stopped before *DONE*	QUIT CK	TUE* 2
Cook Cycles for Product #1	TUE* COOK -1-	17
Cook Cycles for Product #2	TUE* COOK -2-	9
Cook Cycles for Product #3	TUE* COOK -3-	5
Cook Cycles for Product #4	TUE* COOK -4-	0
Cook Cycles for Product #5	TUE* COOK -5-	0
Cook Cycles for Product #6	TUE* COOK -6-	6
Cook Cycles for Product #7	TUE* COOK -7-	0
Cook Cycles for Product #8	TUE* COOK -8-	0
Cook Cycles for Product #9	TUE* COOK -9-	1
Cook Cycles for Product #0	TUE* COOK -0-	0

3-1. INFORMATION MODE
DETAILS (Continued)

4. OIL STATS (info of current oil and avg. of last 4 batches of oil)

Press  and “4. OIL STATS” show in displays.

Press  button to start viewing the cook data.

FUNCTION

DISPLAY EX:

Start date of new oil	NEW OIL	MAR-23
Number of days oil in use	(L/R) OIL USE	4 DAYS
Number of filters on this oil	(L/R) FILTERED	4
Number of times filter skipped	(L/R) SKIPPED	0
Number of cook cycles on this oil	(L/R) TOT CK	38
Average number of days per oil change	(L/R) AVG DAYS PER OIL CHANGE	13.8 DAYS
Average number cook cycles per oil change	(L/R) AVG CKS PER OIL CHANGE	388 CKS

Press and hold a product button (1 to 4) to view the data from one of the previous 4 batches of oil used.

Press  to view oldest oil data: Ex: OIL-4 14 DAYS

Press  to view 3rd oldest oil data: Ex: OIL-3 12 DAYS

Press  to view 2nd oldest oil data: Ex: OIL-2 15 DAYS

Press  to view previous batch of oil: Ex: OIL-1 13 DAYS

NOTICE

To obtain the most accurate oil information, use the “3.DISPOSE” step in the Filter Menu (press and hold ) to drain the oil from the vat.

3-1. INFORMATION MODE
DETAILS (Continued)

5. REVIEW USAGE(accumulated info since the data was reset)

Press  and “5. REVIEW USAGE” show in displays.

Press  button to start viewing the cook data.

FUNCTION

DISPLAY EX:

Day the usage data was previously reset	SINCE	APR-19 3:00P
Number of Hours the fryer was on	(L/R) ON HRS	4
Number of times filtered	(L/R) FILTERED	4
Number of times filter skipped	(L/R) SKIPPED	0
Number of times oil added	(L/R) ADD OIL	4
Number of times oil discarded	(L/R) DISPOSE	1
Total number of cook cycles	(L/R) TOT CK	38
Number of cycles stopped before *DONE*	QUIT CK	2
Cook Cycles for Product #1	COOK -1-	17
Cook Cycles for Product #2	COOK -2-	9
Cook Cycles for Product #3	COOK -3-	5
Cook Cycles for Product #4	COOK -4-	0
Cook Cycles for Product #5	COOK -5-	0
Cook Cycles for Product #6	COOK -6-	6
Cook Cycles for Product #7	COOK -7-	0
Cook Cycles for Product #8	COOK -8-	0
Cook Cycles for Product #9	COOK -9-	1
Cook Cycles for Product #0	COOK -0-	0
Reset usage data: Enter the Usage Code - 1, 2, 3 on this step to zero out all the usage information	RESET USAGE / ENTER CODE	-----

3-1. INFORMATION MODE
DETAILS (Continued)

6. INPUTS

Press  and “6. INPTS” and “HDE” show in displays.

H = HIGH LIMIT - If “H” is present, the high limit is good. If “-” shows then the high limit is tripped out (overheated) or disconnected.

D = DRAIN SWITCH - If “D” is present, the drain handle (when applicable) is closed. If “-” shows then the drain is open or the switch is faulty.

E = ELEMENT SWITCH - If “E” is present, the element switch is good. If “-” shows in the display, the element is in the upright position, or the switch is faulty.

Press  button and an underscore (“_”) indicates the input is not presently detected. A Checkmark (“√”) indicates the signal is detecting a normal input. A blinking (“X”) indicates the signal is presently detected, but is detected as a half-wave (partially failed) input.

NOTICE



The H, D, E signals above are wired in series. The first signal missing out of this sequence generally causes all signals to the right of it to be missing as well.

7. OUTPUTS

Press  and “7. OUPPTS” and “S-H-” show in displays.

S = SAFETY CONTACTOR - Press  to turn off and on the safety (primary) contactor

H = HEAT CONTACTOR - Press  to turn off and on the heat contactor.

( turns off and on the safety (primary) contactor for the left vat of a split vat fryer, and  turns off and on the heat contactor.)

8. OIL TEMPERATURE

Press  and “8.OIL TMP” shows in the left display and the oil temperature shows in the right display.

9. CPU TEMPERATURE

Press  and “9.CPU TMP” shows in the left display and the current PC board temperature shows in the right display.

SECTION 4. PRODUCT PROGRAM MODE





This mode allows you to program the following:

- Change Product Name
- Assign Button
- Change Times & Temp
- Change Cook ID
- Alarms
- Quality Timers
- Include in Filter Count (Global)
- Filter at X no. of loads (Mixed)
- Load Compensation
- Load Compensation Reference
- Full Heat
- PC Factor

4-1. MODIFYING PRODUCT SETTINGS

1. Press and hold  button until “PROG” shows in the display, followed by “ENTER CODE”.
2. Enter code 1, 2, 3 (first 3 product buttons). “PRODUCT” and “PROGRAM” show in the displays, followed by “SELECT PRODUCT” and “-P 1-” (ex: NUG).

Change Product Names

3. Use the  and  buttons to scroll through the 40 products, or press the desired product button.
4. Press  button and “NAME” shows in the left display and the product (ex: NUGGETS) shows in the right display.
5. Press  button and the first letter in the name flashes. Press a product button and the flashing letter changes to the first letter under the product button that was pressed. For example, if  is pressed, the flashing letter changes to an “A”.

Press the same button again and the flashing letter changes to a “B”. Press it again and the flashing letter changes to a “C”. Once the desired letter shows in the display, press  button to continue to the next letter and repeat the procedure.





Press and hold the right **X** button to exit Program Mode, or press  button to continue on to “COOK TIME”.



Assign Button

6. Press  button until “ASSIGN BTN” shows in the display, along with the product (ex: NUGGETS). If this product already has a product button assigned to it, that LED will be lit. To assign other product buttons to that product, press and hold the product button for 3 seconds and that LED stays lit. To remove a product from a button, press and hold the product button with a lit LED and the LED goes out.



4-1. MODIFYING PRODUCT SETTINGS (Continued)

To Change Times and Temperatures



7. Press  button until “COOK TIME” shows in the display, and then use the product buttons, or the  and  buttons, to change the time in minutes and seconds, to a maximum of 59:59.
8. Press  button and “TEMP” shows in the display, along with the preset temperature on the right side of the display.

Press the product buttons, or the  and  buttons, to change the temperature. The temperature range is 190°F (88°C) to 375°F (191°C).

Cook ID Change

9. Press  button until “COOK ID” shows in the display along with the product ID. For example, NUG would be the ID for nuggets. Use the product buttons, or the  and  buttons, to change the ID.



Alarms (1 & 2)

11. Press  button until “ALRM 1” shows in the left display, and an alarm time in the right display. Press the product buttons, or the  and  buttons, to set an alarm.

Ex., If a Cook Cycle was set at 3 minutes, and an alarm was to go off after 30 seconds into the Cook Cycle, “2:30” would be set in the display at this time. When the timer counts down to 2:30 the alarm sounds.



After the alarm time is set, press  button and “ALRM 2” shows in the display, and a second alarm can be programmed.

Quality Timer (hold time)

12. Press  button until “QUAL TMR” shows in the display along with the preset holding time. Press the product buttons, or the  and  buttons, to adjust holding time, up to 59:59.

Global Filter Tracking



Include in Filter Count

- 13a. Press  button until “INCL IN FLTR CNT” flashes in the display along with “YES” or “NO”. Using  and  buttons, change the display to “YES” if that product’s Cook Cycles are to be counted as part of the recommended filter process. Set to “NO” if it is not to be included.

4-1. MODIFYING PRODUCT SETTINGS (Continued)



Mixed Filter Tracking



Filter After X Number of Loads



13b. Press  button until “FILTER AFTER...” flashes in the left display along, and the number of cook cycles between filters shows in the right display. Press the product buttons, or the  and  buttons, to change this value of 0 to 99 loads. This needs set for each product.



>Load Compensation, Load Compensation Reference, Full Heat, PC Factor<

14. Press  button until “LD COMP” shows in the display, along with the load compensation value. This automatically adjusts the time to account for the size and temperature of the cooking load.



Press the product buttons, or the  and  buttons, to change this value of 0 to 20.

15. Press  button until “LCMP REF” shows in the display along with the load compensation average temperature. (if load compensation is set to “OFF”, then “_ _ _” shows in display and setting cannot be programmed) This is the average cooking temperature for each product. The timer speeds up at temperatures above this setting and slows down at temperatures below this setting. Press the product button, or the  and  buttons, to change this value.

16. Press  button until “FULL HT” shows in the display along with the full heat value in seconds, which means the heat is on as soon as a timer button is pressed, for the programmed length of time. Press the product buttons, or the  and  buttons, to change this value of 0 to 90 seconds.

17. Press  button until “PC FACTR” shows in the display along with the proportional temperature, which helps to keep the oil from over-shooting the setpoint temperature. Press the product buttons, or the  and  buttons, to change this value of 0 to 50 degrees.

NOTICE

- Use  button to go back to previous menu items.
- Press  button when finished with the current product, to return to the “SELECT PRODUCT” step.
- Press and hold  button to exit PRODUCT PROGRAM Mode.

SECTION 5. LEVEL 2 PROGRAMMING

- Used to access the following:
- Special Program Mode
 - Clock Set
 - Data Communication
 - Heat Control
 - Tech Mode
 - Stats
 - Filter Control

5-1. SPECIAL PROGRAM MODE

The Special Program Mode is used to set more detailed programming, such as:

- SP-1** • Degrees Fahrenheit or Celsius
- SP-2** • Language: English, Russian, Swedish (SVENSKT), German (DEUTSCHE), Portuguese, Spanish (ESPANOL) and French (FRANCAIS)
- SP-3** • System Initialization (Factory Presets)
- SP-4** • Audio Volume
- SP-5** • Audio Tone
- SP-6** • Melt Cycle Select - 1.LIQUID; 2.SOLID
- SP-7** • Idle Mode Enabled - YES or NO
- SP-7A** • Use "0" for IDLE
- SP-7B** • Auto Idle Minutes
- SP-7C** • Idle Set-point Temperature
- SP-8** • Filter Tracking Mode - 1.MIXED or 2.GLOBAL
- SP-8A** • Suggest Filter At... - 75% to 100% (**MIXED**)
- SP-8B** • Filter Lockout Enabled? - YES or NO (**MIXED**)
- SP-8A** • Left Vat Filter Cycles - 0 to 99 (**GLOBAL**)
- SP-8B** • Right Vat Filter Cycles - 0 to 99 (**GLOBAL**)
- SP-8C** • Filter Lockout Enabled? - YES or NO (**GLOBAL**)
- SP-9** • Polish Duration - X:XX M:SS
- SP-10** • Change Pad Reminder Time - XX HRS
- SP-11** • Clean-Out Time - XX MIN
- SP-12** • Clean-Out Temperature - XXX °F or °C
- SP-13** • Cooking User IO - After Cook Cycle, display shows previous menu item or "----"
- SP-14** • Number of Baskets - 2-BASKETS or 4 BASKETS
- SP-15** • Show Cooking Indicator - YES or NO
- SP-16** • 2nd Language: English, Russian, Swedish (SVENSKT), German (DEUTSCHE), Portuguese, Spanish (ESPANOL) and French (FRANCAIS)
- SP-17** • 2nd AudioVolume
- SP-18** • Energy Save Enabled? - YES or NO
- SP-19** • Fryer Type - GAS or ELECTRIC
- SP-20** • Vat Type - SPLIT or FULL
- SP-21** • Autolift Enabled? - NO LIFT or YES LIFT
- SP-22** • Bulk Oil Supply? - YES or NO
- SP-23** • Bulk Oil Dispose? - YES or NO
- SP-24** • Serial No. of Fryer
- SP-25** • Change Mgr. Code- 1 = YES
- SP-26** • Change Usage Code - 1 = YES
- SP-27** • Dispose Requires Code ? - YES or NO
- SP-28** • Longer Fill Time Enabled - YES or NO
- SP-29** • Let User Exit Fill? - YES or NO
- SP-30** • Skip 'SKIM' Prompt? - YES or NO
- SP-31** • 2-Stage Wash Enabled? - YES or NO

5-1. SPECIAL PROGRAM MODE (Continued)

Press and hold the **P** button for 5 seconds until “LEVEL 2” followed by, “SP PROG” and “ENTER CODE” show in the display.

Enter code 1,2,3, and “SP-1”, “TEMP”, “FORMAT” show in the displays.

NOTICE

If a bad code is entered, a tone sounds and “BAD CODE” shows on the display. Wait a few seconds, the controls revert back to the cook mode, and repeat the above steps.

To exit from the Special Program Mode at any time, press and hold **P** button for 2 seconds.

Degrees Fahrenheit or Celsius (SP-1)

The left display flashes “SP-1” and “TEMP”, “FORMAT”. Press the ▲ or ▼ buttons to choose °F or °C.

NOTICE

- Use ◀ button to go back to previous menu items
- Press ▶ button when finished with the current Level 2 step

Language (SP-2)

Press ▶ button and “SP-2” and “LANGUAGE” flash on the left display. Press the ▲ or ▼ buttons to select the desired language.

System Initialization (SP-3)



Press ▶ button and “SP-3” and “DO SYSTEM INIT” flash in the display, along with “INIT” on the right display. To reset the controls to factory default settings, press and hold √ button and control counts down “IN 3”, “IN2”, “IN 1”. Once display shows “-INIT-” & *DONE* the controls are reset to factory defaults.

Audio Volume (SP-4)

Press ▶ button and “SP-4” and “VOLUME” flash in the left display. Press the ▲ or ▼, or use product buttons, to adjust the volume of the speaker, 10 being the maximum value and 1 the minimum.



**5-1. SPECIAL PROGRAM
MODE (Continued)**

Audio Tone (SP-5)

Press  button and “SP-5” and “TONE” flash in the left display. Press the  or , or use product buttons, to adjust the tone of the speaker, 2000 being the maximum value and 50 the minimum.



Liquid or Solid Cooking Oil Used (SP-6)





Press  button until “SP-6 MELT CYCLE SELECT” scrolls in the left display. Unless solid oil is being used in the vats the right display should show “1.LIQUID”.



If solid oil is used, the unit **MUST BE** equipped to handle solid oil. Use the  and  buttons to change the right display to “2.SOLID”

Idle Mode Enabled (SP-7)



An Idle Mode allows the oil temperature to drop to a lower temperature when not in use. This saves on oil and utilities.

Press  button and “SP-7” and “IDLE MODE ENABLED?” flash in the left display. Press the  or  buttons to choose “YES” or “NO”.

With “YES” in the display, press  button and “SP-7A” and “USE ‘0’ FOR IDLE” flash on the left display. Press the  or  buttons to select “YES” or “NO”. If “YES” is selected, an Idle Mode can be programmed in product button .

Press  button and “SP-7B” and “AUTOIDLE MINUTES” flash in the left display. Press the  or  or use product buttons, to set the time (0 to 60 minutes) fryer stays idle before the auto-idle is enabled.



Ex., “30” means, if product is not cooked in that vat for 30 minutes, the control automatically cools the oil down to the idle setpoint temperature

Press  button and “SP-7C” and “IDLE SETPT” flash in the left display. Press the  or , or use product buttons, to set the idle temperature 200° to 375 °F (93 to 191 °C).

5-1. SPECIAL PROGRAM
MODE (Continued)

Filter Tracking Mode (SP-8)

Filter Tracking signals the operator when the oil needs filtering by counting the number Cook Cycles between filters.

Press  button and “SP-8” and “FILTER TRACKING MODE” show in the display. Use the  and  buttons to choose either “1.MIXED” filter tracking or “2.GLOBAL”.

NOTICE



GLOBAL means all the products have the same number of cook cycles between filters.

MIXED means each product may be set with different number of cook cycles between filters. The controls adds the cycle counts (see example at left) and when the counts equal 1 or greater, filtering is suggested. Ex: 1 load of fish, 2 loads of french fries, a load of chicken equals 1.



Product	No. Cook Cycles	Cycle Count
Fish	2	1/2
French Fries	8	1/8
Chicken	4	1/4

$$1/2 + 1/8 + 1/8 + 1/4 = 1.$$



MIXED

If MIXED is selected, press  button and “SP-8A” and “SUGGEST FILTER AT ...” shows in the left display, and a value between 75% and 100% shows on the right display. Press the  and  buttons to change this value.

The lower the value, the sooner the control recommends to filter. Ex: If set to 75%, the control suggest filtering after 3/4 of the programmed cook cycles is met, whereas at 100%, all the cook cycles must be completed before the control suggest filtering.

Press  and “SP-8B” and “LOCKOUT ENABLED?” shows in the left display. Press the  and  buttons to choose YES or NO.

If set to YES, when the controls suggest filtering, “FILTER LOCKOUT”/”YOU *MUST* FILTER NOW”, shows in the display, and it refuses further cook cycles until the vat is filtered.

Press  and “SP-8C” and “LOCKOUT AT...” shows in the left display and a value between 100% and 250% shows on the right display. Press the  and  buttons to change this value. The lower the value, the sooner the “lockout” occurs.

Ex: If set at 100%, “lockout” occurs when the cycle counts reaches 1 or greater. Set at 200%, twice as many cycles are counted before “lockout” occurs. See example above.

**5-1. SPECIAL PROGRAM
MODE (Continued)**

Filter Tracking Mode (SP-8) (Continued)

GLOBAL

If GLOBAL is selected, press ► button.

Split Vat

If unit is a split vat, “SP-8A” and “LEFT VAT FILTER CYCLES” shows in the left display, and the number of cook cycles between filters shows on the right display (0 to 99). Use ▲ and ▼ to change this number.

Press ► button and “SP-8B” and “RIGHT VAT FILTER CYCLES” shows in the left display, and the number of cook cycles between filters shows on the right display (0 to 99).

Press ► button and “SP-8C” and “LOCKOUT ENABLED?” shows in the left display. Press the ▲ and ▼ buttons to choose YES or NO.

If set to YES, when the controls suggest filtering, “FILTER LOCKOUT”/”YOU *MUST* FILTER NOW”, shows in the display, and it refuses further cook cycles until the vat is filtered.

Full Vat

If unit is a full vat, “SP-8A” and “FULL VAT FILTER CYCLES” shows in the left display, and the number of cook cycles between filters shows on the right display (0 to 99). Use ▲ and ▼ to change this number.

Press ► button and “SP-8C” and “LOCKOUT ENABLED?” shows in the left display. Press the ▲ and ▼ buttons to choose YES or NO.

If set to YES, when the controls suggest filtering, “FILTER LOCKOUT”/”YOU *MUST* FILTER NOW”, shows in the display, and it refuses further cook cycles until the vat is filtered.

5-1. SPECIAL PROGRAM
MODE (Continued)

Polish Duration (SP-9)

Press ► button and “SP-9 POLISH TIME” flashes in the left display. Press the ▲ or ▼ , or use product buttons, to change polish time, from 0 to 10 minutes.

Change Filter Pad Reminder Time (SP-10)

Press ► button and “SP-10 CHANGE PAD REMINDER” flashes in the left display. Press the ▲ or ▼ , or use product buttons, to change the time from 0 to 100 hours.

Clean-Out Time (SP-11)

Press ► button and “SP-11 CLEAN-OUT TIME” flashes in left display. Press the ▲ or ▼ , or use product buttons, to change the time from 0 to 99 minutes.

Clean-Out Temperature (SP-12)

Press ► button and “SP-12 CLEAN-OUT TEMP” flashes in the left display. Press the ▲ or ▼ , or use product buttons, to change the temperature from 0 to 195° F (90° C).

Cooking User IO (SP-13)

Press ► button and “SP-13 COOKING USER IO” flashes in the display. Press the ▲ or ▼ buttons to choose “SHOWPREV” or “SHOW----”.

Setting SP-13 to SHOWPREV means after a cook cycle the display shows the last menu item cooked. SHOW---- means after a cook cycle “----” shows in the display and a menu item needs selected before starting the next cook cycle.

Number of Baskets (SP-14)



Press ► button and “SP-14 NUMBER OF BASKETS” flashes in the left display. Press the ▲ or ▼ buttons to choose 2 or 4 baskets per well.

Cooking Indicator (SP-15)

Press ► button and “SP-15 SHOW COOKING INDICATOR” flashes in the left display. Press the ▲ or ▼ buttons to choose YES, and during a cook cycle, “*” shows which timer is counting-down. Choose NO and “*” will not show during a cook cycle.

5-1. SPECIAL PROGRAM MODE (Continued)



2nd Language (SP-16)

Press  button and “SP-16 2ND LANGUAGE” flashes on the left display. Press the  or  buttons to select the desired 2nd language.

By setting a 2nd language in the controls, 2 languages can now be chosen by pressing  button during normal operation.

One language shows in the left display and the second language shows in the right display. Pressing the  button selects the language in the displays.



2nd Volume (SP-17)

Press  button and “SP-17 2ND VOLUME” flashes on the left display. Press the  or  buttons, or the product buttons to select the desired 2nd volume.

By setting a 2nd volume in the controls, 2 volumes can now be chosen by pressing  button twice during normal operation.



One volume setting shows in the left display (NONE to 10; 10 being the loudest) and the second volume shows in the right display. To select the volume, press the  button under the desired volume .

Engery Save Mode (SP-18)



Press  button and “SP-18 ENERGY SAVE EN- ABLED?” flashes in the left display. Press the  or  buttons to choose “YES” or “NO”.

If set to YES, during times of non-use the fryer automatically starts an Energy Save Mode, which turns-off the blowers. Then once a product is selected to start a cook cycle, the blowers and heat come back on. If set to NO, the blowers are on constantly.

Fryer Type (SP-19)



Press  button and “SP-19 FRYER TYPE” flashes in the left display. Press the  or  buttons to choose “GAS” or “ELEC”.

Vat Type (SP-20)

Press  button and “SP-20 VAT TYPE” flashes in the left display. Press the  or  buttons to choose “SPLIT” or “FULL”.



**5-1. SPECIAL PROGRAM
MODE (Continued)**

Autolift Enabled (SP-21)

Press  button and “SP-21 AUTOLIFT ENABLED?” flashes in the left display. Press the  or  buttons to choose “YES LIFT” or “NO LIFT”.



If fryer is fitted with the auto-lift option, SP-21 must be set to “YES LIFT”, otherwise, set SP-21 to “NO LIFT”.

Bulk Oil Supply (SP-22)

Press  button and “SP-22 BULK OIL SUPPLY?” flashes in the left display. Press the  or  buttons to choose “YES SUPL” or “NO SUPL”.

Set to YES if the oil is pumped into the vats from an outside oil reservoir. Otherwise, set SP-22 to NO.

Bulk Oil Disposal (SP-23)

Press  button and “SP-23 BULK OIL DISPOSE?” flashes in the left display. Press the  or  buttons to choose “YES DISP” or “NO DISP”.



Set to “YES DISP” if the oil is pumped from the vats to an outside oil reservoir when disarding the oil. Otherwise, set SP-23 to “NO DISP”.

Serial Number Log (SP-24)

Press  button and “SP-24 S/N ✓ EDIT” flashes in the displays, along with the serial number of the unit. THIS SERIAL NUMBER SHOULD MATCH THE SERIAL NUMBER ON THE DATA PLATE, ON THE DOORS. IF NOT, IT CAN BE RECORDED.

Program Code Change (SP-25)

This allows the operator to change the program code (factory set at 1, 2, 3) used to access Product Programming and Level 2 Program Mode.

Press  button and “SP-25 CHANGE MGR CODE? 1=YES” flash in the display. Press  and “ENTER NEW CODE, P=DONE, I=QUIT” show scrolls through the display. Press the product buttons for new code.

If satisfied with code, press  and “REPEAT NEW CODE, P=DONE, I=QUIT, shows in display. Press same code buttons.

**5-1. SPECIAL PROGRAM
MODE (Continued)**

Program Code Change (SP-25) (Continued)

If satisfied with code, press **P** and “*CODE CHANGED*” shows in display.

If not satisfied with code, press **i** and “*CANCEL” shows in display, then reverts back to “SP-25” and “CHANGE, MGR CODE? 1=YES”. Now the above steps can be repeated.

Usage Code Change (SP-26)

This allows the operator to change the reset usage code (factory set at 1, 2, 3) to reset the usage amounts of each product. See Review Usage step in Information Mode.

Press **▶** button and “SP-26 CHANGE USAGE CODE? 1=YES” flashes in the display. Press **1** and “ENTER NEW CODE, P=DONE, I=QUIT show scrolls through display. Press product buttons for new code.

If satisfied with code, press **P** and “REPEAT NEW CODE, P=DONE, I=QUIT, shows in display. Press same code buttons.

If satisfied with code, press **P** “*CODE CHANGED*” shows in display.

If not satisfied with code, press **i** and “*CANCEL” shows in display, then reverts back to “SP-26” and “CHANGE, USAGE CODE? 1=YES”. Now the above steps can be repeated.

Dispose Requires Code ? (SP-27)

Press **▶** button and “SP-27 DISPOSE REQUIRES CODE ?” flashes in the left display. Press the **▲** or **▼** buttons to choose YES or NO. If set to YES, code 1, 2, 3 must be entered to discard the oil from the vat, using the Dispose Mode.

Longer Fill Time (SP-28)



Press **▶** button and “SP-28 LONGER FILLTIME ENABLED?” flashes in the left display. Press the **▲** or **▼** buttons to choose YES or NO.

Let User Exit Fill (SP-29)



Press **▶** button and “SP-29 LET USER EXIT FILL” flashes in the left display. Press the **▲** or **▼** buttons to choose YES or NO. If YES is chosen, the user can exit the Express Filter™ fill operation.

**5-1. SPECIAL PROGRAM
MODE (Continued)**

Skip 'SKIM' Prompt (SP-30)













Press  button and "SP-30 SKIP 'SKIM' PROMPT?" flashes in the left display. Press the  or  buttons to choose YES or NO.

2-Stage Wash Enabled (SP-31)

Press  button; "SP-31 2-STAGE WASH ENABLED?" flashes in the left display. Press the  or  buttons to choose YES or NO.

5-2. DO NOT DISTURB

Time periods of peak operations during which the "FILTER NOW?" message will not appear, may be programmed into the fryer. There are three groupings of days - Monday thru Friday (M-F), Saturday (SAT), and Sunday (SUN). Within each day grouping, up to 4 time periods (M-F 1 thru M-F 4, SAT 1 thru SAT 4, and SUN 1 thru SUN 4) may be programmed. A time period may be anywhere from 1 to 180 minutes in length.

1. Press and hold the  button for 5 seconds until "LEVEL 2", followed by, "SP PROG" and "ENTER CODE" show in the display.
2. Press  button once more and "DO NOT DISTURB" and "ENTER CODE" flash in the left display.
3. Enter code 1, 2, 3 (first 3 product buttons).
4. "DO NOT DISTURB ENABLED?" flashes in the left display and YES or NO appears in the right display. Press the  or  buttons to choose YES or NO.
5. Press  button and "M-F 1" shows in the left display and the time flashes in the right display. Press the  or , or use product buttons, to change the time.
6. Press  button and "M-F 1" shows in the left display and "A" or "P" flashes in the right display. Use the  or  buttons to choose AM or PM.
7. Press  button and "M-F 1" shows in left display and far right character display flashes. Press product buttons to enter amount of time (up to 180 minutes) during which filtering will be inhibited, after time entered in step 5.
8. Press  button to move to the next timer period, M-F 2.
9. Repeat steps 5, 6, 7, and 8 for other desired time periods.

5-3. CLOCK SET

1. Press and hold the **P** button for 5 seconds until “LEVEL 2”, followed by, “SP PROG” and “ENTER CODE” show in the display.
2. Press the **P** button again and “CLK SET” and “ENTER CODE” flash in the left display.
3. Enter code 1, 2, 3 (first 3 product buttons).
4. “CS-1 ENTER DATE MM-DD-YY” flashes in the left display. Use the product buttons to set the date in the right display.
5. Press **▶** button and “CS-2 ENTER TIME” flashes in the left display and the time flashes in the right display. Press the **▲** or **▼**, or use product buttons, to change the time.
6. Press **▶** button and “CS-2 ENTER TIME” flashes in the left display and “AM” or “PM” flashes in the right display. Use the **▲** or **▼** buttons to choose AM or PM.
7. Press **▶** button and “CS-3 TIME FORMAT” flashes in the left display and “12-HR” or “24-HR” shows in the right display. Use the **▲** or **▼** buttons to choose a 12 hour time format or a 24 hour time format.
8. Press **▶** button and “CS-4 DAYLIGHT SAVING TIME” flashes in the left display. Use the **▲** or **▼** buttons to choose daylight saving time for your area: 1.OFF; 2.US (2007 & after); 3.EURO; or 4.FSA (US before 2007).

5-4. DATA LOGGING, HEAT CONTROL, TECH, STAT, AND FILTER CONTROL MODES

The Data Logging, Heat Control, Tech, Stat and Filter Control Modes are advanced diagnostic and program modes, mainly for Henny Penny use only. For more information on these modes, contact the Service Department at 1-800-417- 8405 or 1-937-456-8405.

5-5. TECH MODE





The TECH Mode has self-diagnostic information, which can be used by certified technicians for troubleshooting purposes, such as:

- T-1** • Software
- T-2** • Fryer Type (Gas or Elec.)
- T-3** • Push Button Test
- T-4** • All On Display Test
- T-5** • Display Segment Test
- T-6** • Display Digits Test
- T-7** • Display Decimal Point Test
- T-8** • LED's Test
- T-9** • Left Temp. Probe Calibration & Offset
- T-10** • Left Level 1 Probe Calibration & Offset
- T-11** • Left Level 2 Probe Calibration & Offset
- T-12** • Right Temp. Probe Calibration & Offset
- T-13** • Right Level 1 Probe Calibration & Offset
- T-14** • Right Level 2 Probe Calibration & Offset
- T-15** • CPU Control Temp. Calibration/Offset/Highest
- T-16** • View A - D Channel
- T-17** • Digital Inputs
- T-18** • AIF Info
- T-19** • Outputs Test
- T-20** • Pumps & Valves Test
- T-21** • Recovery Test Limit
- T-22** • Drain Light Stay On?
- T-23** • Heat Err Enabled?
- T-24** • Change Tech Code?
- T-25** • Total Initialization

NOTICE

Not all Tech Mode functions are discussed in this section. To ensure proper operation of fryer, please consult Henny Penny Corp. before changing any of these settings. For more information on these functions, contact the Service Department at 1-800-417- 8405, or 1-937-456-8405.

5-5. TECH MODE (Continued)



1. Press and hold the  button for 5 seconds until “LEVEL 2”, followed by, “SP PROG” and “ENTER CODE” show in the display.
2. Press the  button 4 times and “TECH” and “ENTER CODE” flash in the left display.
3. Enter code 1, 1, 2, 2, 1, 1, 2, 2 (first 2 product buttons).
4. “T-1 SOFTWARE” flashes in the left display and “EV-ELITE” shows in the right display. Use the  and  buttons to select the steps.

NOTICE

If a bad code is entered, a tone sounds and “BAD CODE” shows on the display. Wait a few seconds, the controls revert back to the cook mode, and repeat the above steps.

Press and hold  button at anytime to return to normal operation.

T-1 - SOFTWARE

- Press  to view HP Part No. of eeprom
- Press  to view software ID
- Press  to view software version

T-2 - FRYER TYPE - GAS or ELEC

T-3 - PUSH-BUTTON TEST

Press any of the control buttons to test operation. You should hear a beep, and the LED should light and/or a display.

T-4 - ALL ON DISPLAY TEST

Press any of the product buttons and all the LEDs and display segments should light.

T-5 - SEGMENTS TEST

Press  button to view the different segments of the display characters.

T-6 - DIGITS TEST

Press  button to view all segments of each digit across the displays.

5-5. TECH MODE (Continued)

T-7 - DECIMAL PTS TEST

Press  button to view all decimal points across the displays.

T-8 - LED'S TEST

Press  buttons to view each LED across the control panel.

T-17 - DIGITAL INPUTS - HDE

H = HIGH LIMIT - If "H" is present, the high limit is good. If "-" shows then the high limit is tripped out (overheated) or disconnected.

D = DRAIN SWITCH - If "D" is present, the drain handle (when applicable) is closed. If "-" shows then the drain is open or the switch is faulty.

E = ELEMENT SWITCH - If "E" is present, the element switch is good. If "-" shows in the display, the element is in the upright position, or the switch is faulty.

Press  button and an underscore ("_") indicates the input is not presently detected. A Checkmark ("√") indicates the signal is detecting a normal input. A blinking ("X") indicates the signal is presently detected, but is detected as a half-wave (partially failed) input.

NOTICE

The H, D, E signals above are wired in series. The first signal missing out of this sequence I generally causes all signals to the right of it to be missing as well.



T-18 - AIF INFO (AIF PCB communicating with control PCB?)

An "AIF √" means normal communications between the AIF PCB and the control PCB. "AIF X" means a problem with the communications between the PCBs.

T-19 - OUTPUTS

S = SAFETY CONTACTOR - Press  to turn off and on the safety (primary) contactor



H = HEAT CONTACTOR - Press  to turn off and on the heat contactor.

( turns off and on the safety (primary) contactor for the left vat of a split vat fryer, and  turns off and on the heat contactor.)

5-5. TECH MODE (Continued)

T-20 - PUMPS & VALVES

Press ▼ button and “LIGHTS” “DLT_” shows in displays.

Press  and left Filter Beacon® lights (split vats) and press  button and right Filter Beacon® lights (display shows “DLTo” when on)

Press ▼ button and “VALVES” “DcRc” shows in displays.

Press  to open and close the return valve.

“DcRc” means valve is closed, “DcRo” means valve is open.
(Driven by the control board)

Press ▼ button and “DISCARDc” and “JIBFILLc” shows in the displays. (Driven by the AIF board)

Press  to open and close the RTI discard valve (display shows “DISCARD0” when open)

Press  to open and close the RTI JIB fill valve (display shows “JIBFILL0” when open)

Press ▼ button and “PUMP FP_” and “JP_ NP_” shows in the displays. (Driven by the AIF board)

Press  to turn off and on the filter pump (display shows “FP*” when on)

Press  to turn off and on the JIB pump (display shows “JP*” when on)

Press  to turn off and on the new oil pump (if available - display shows “NP*” when on)

5-5. TECH MODE (Continued)

Press ▼ button and “AIF REQ” and “RQ=Y OK=Y” shows in the displays.

“REQ=Y” means that this particular control is currently requesting control of the AIF Board outputs.

“OK=Y” means that the AIF Board has granted this control the authority to control the AIF Board outputs.

Press ▼ button and “FILR IN” and “USE BY 1(ex)” shows in the displays. These displays shows which controls are using the filtering system.

“USE = 0” = not in use

“USE = 7” = used by AIF

“USE = 1 to 5” = used by control PCB

Press ▼ button and “CPU POSN” and “1 OF 3(ex)” shows in the displays. These displays shows which controls are plugged into which port on the AIF board.

For example, the left control should be plugged into port 1, and on a 3 control fryer, shows “1 OF 3” on the display.

If the right control is unplugged, then the left control would show “1 OF 2” instead of “1 OF 3”.

Press ▼ button and “INP E_P_” and “JL_Rx DF_” shows in the displays.

AIF Board Inputs:

E = Stop button

P = Drain Pan

JL = JIB

R = RTI

DT = Discard Tank

Ex = E-Stop pressed.

Px = drain pan is missing.

Jx = JIB oil level is low.

Rx = RTI System NOT Detected

DTx = tank full

5-5. TECH MODE (Continued)

Press ▼ button and “OUT F_J_” and “N_DI_oJF_” shows in the displays.

AIF Board Outputs:

Current outputs status from AIF board.

F = Filter Pump. (Fx = Filter pump is on)

J = JIB Pump. (Jx = JIB pump is on)

N = New Oil Pump. (Nx = RTI new oil pump on)
(if present)

DI = Discard Valve. (DIo = Disc. valve open/DIc=closed)
(if present)

JF = JIB Fill Valve. (JFo = JIB fill valve open/JFc=closed)

Press ▼ button and “REQ F_J_” and “N_DI_JF_” shows in the displays.

AIF Board Outputs Requested by the Control Board:

Current outputs status from AIF board.

F = Filter Pump. (Fx = Filter pump is on)

J = JIB Pump. (Jx = JIB pump is on)

N = New Oil Pump. (Nx = New oil pump on)
(if present)

DI = Discard Valve. (DIo = Disc. valve open/DIc=closed)
(if present)

JF = JIB Fill Valve. (JFo = RTI JIB fill valve open/
JFc=closed)

5-6. STATS MODE

This mode allows a technician to view advanced information on the operation of the fryer and controls.

1. Press and hold the **P** button for 5 seconds until “LEVEL 2”, followed by, “SP PROG” and “ENTER CODE” show in the display.
2. Press the **P** button 5 times and “STATS” and “ENTER CODE” flash in the left display.
3. Enter code 1, 1, 2, 2, 1, 1, 2, 2 (first 2 product buttons).
4. “ST-1 STATS LAST RESET ON...” flashes in the left display and the date shows in the right display. Use the ◀ and ▶ buttons to select the steps.

NOTICE

If a bad code is entered, a tone sounds and “BAD CODE” shows on the display. Wait a few seconds, the controls revert back to the cook mode, and repeat the above steps.

Press and hold **P** button at anytime to return to normal operation.

- | | | | |
|--------------|-------------------------------------|--------------|---|
| ST-1 | • Stats Last Reset Date | ST-16 | • System RAM Fade Count |
| ST-2 | • Fryer Total Running Hours | ST-17 | • Cook RAM Fade Count |
| ST-3 | • Left Vat Melt Cycle Hours | ST-18 | • Product RAM Fade Count |
| ST-4 | • Left Vat Cook Cycle Hours | ST-19 | • Stat RAM Fade Count |
| ST-5 | • Left Vat Idle Hours | ST-20 | • RAM Data Error Count |
| ST-6 | • Right Vat Melt Cycle Hours | ST-21 | • Data Total Loss Count |
| ST-7 | • Right Vat Cook Cycle Hours | ST-22 | • User Initialization Count |
| ST-8 | • Right Vat Idle Hours | ST-23 | • Automatic Initialization Count |
| ST-9 | • Power-Ups Count | ST-24 | • Cooks Count per Product |
| ST-10 | • Error Counts | ST-25 | • Cook Cycle Stop Counts |
| ST-11 | • Left Vat Heat On Hours | | - “A” = number of stops in first 30 seconds |
| ST-12 | • Right Vat Heat On Hours | | - “B” = 0 |
| ST-13 | • Highest Left Vat Oil Temperature | | - “C” = 0 |
| ST-14 | • Highest Right Vat Oil Temperature | | - “D” = complete cook cycles counted |
| ST-15 | • Highest CPU Temperature | ST-26 | • Reset All Stats |

SECTION 6. MAINTENANCE

6-1. INTRODUCTION

This section provides checkout and replacement procedures, for various parts of the fryer. Before replacing any parts, refer to the Troubleshooting Section to aid you in finding the cause of the malfunction.

6-2. MAINTENANCE HINTS

1. A multimeter will help you to check the electric components.
2. When the manual refers to the circuit being closed, the multimeter should read zero unless otherwise noted.
3. When the manual refers to the circuit being open, the multimeter should read infinity.



Do not move the fryer with hot oil in the vat or filter pan. Severe burns can result from splashing hot oil.

6-3. PREVENTIVE MAINTENANCE

To ensure a long life of the fryers and their components, regular maintenance should be performed. Refer to the chart below.

Frequency	Action
Daily	Filter the oil (See Daily Filtering Instructions Section in Operator's Manual)
Daily	Change Filter Pad (See Changing Filter Pad Section in Operator's Manual)
Every filter pad change	Lubricate filter pan o-rings
Quarterly	Inspect/Change Filter Pan O-Rings (See Check/Replace Filter Drain Pan O-Ring Section)
When oil smokes, foams-upviolently, or tastes bad	Change oil
Every change of oil	Clean Vat (See Clean-Out Mode Section in Operator's Manual)

**6-4. CONTROL PANEL &
MENU CARD
REPLACEMENT**



Should the control panel become inoperative, or the menu card needs changed, follow these instructions:

1. Remove electrical power supplied to the vat.



To avoid electrical shock or property damage, move the power switch to OFF and disconnect main circuit breaker, or unplug cord at wall receptacle.

2. Remove the two screws securing the control panel.



3. Pull the top of the panel down, allowing the panel to be supported by the 2 brackets in the slots in the control shroud. (If changing control panel, continue onto step 5.)



4. If changing the menu card, loosen the tape securing the menu card at the bottom, side of the control panel and pull menu card from panel. Carefully, slide changed menu card back into slot in panel and secure with tape.

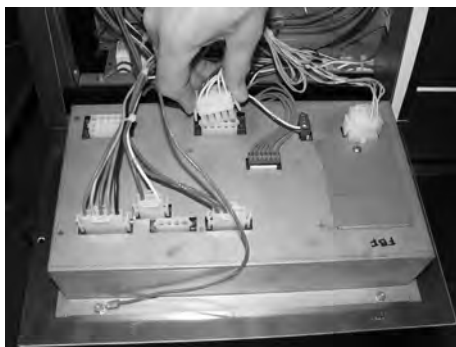

5. Unplug the connectors going to the control board.

6. Install a new control panel in reverse order.

6-5. HIGH TEMPERATURE LIMIT CONTROL



This is a safety, manual reset control, which senses the temperature of the oil. If the oil temperature exceeds 425°F (218°C), this switch opens and shuts off the heat to the vat. When the temperature of the oil drops to a safe operation limit, manually reset the control by pressing the reset button.

The reset button is located in the hinge of the element. Use a small screwdriver or Allen wrench, gently push it into the hole in the heating element hinge; if high limit does not reset, high limit must be replaced. If high limit resets, the oil starts heating.

NOTICE

Checkout:

The oil temperature must be below 380°F (193°C) to accurately perform this check.



To avoid electrical shock or property damage, move the power switch to OFF and disconnect main circuit breaker, or unplug cord at wall receptacle.

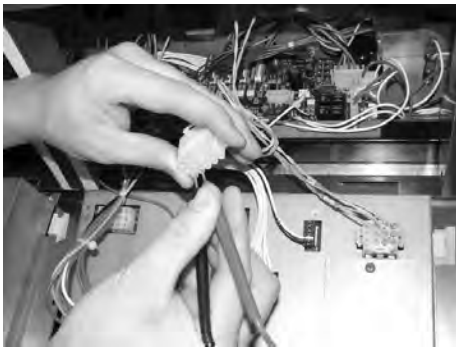

1. Remove control panel and hinge it down.
2. Referring to the decal on the rear of the control panel, locate P9 connector (left vat-split vat) or P10 connector (full or right vat).
3. Attempt to reset the high limit and then pull the connector from the board and check for continuity between the 2 appropriate pins. If the circuit is open then continue replacement procedure. (If the circuit is closed, the high limit is not defective.



Replacement

If the tube is broken or cracked, the control opens, shutting off electrical power. The control cannot be reset.

1. Using a Phillip's-head screwdriver, or screw gun, remove the rear panel (9 screws).
2. Using 3/8" wrench or socket, remove the 2 acorn nuts securing bracket to unit.
3. Using a Phillip's-head screwdriver, remove the 2 screws securing the high limit to the bracket.



**6-5. HIGH TEMPERATURE
LIMIT CONTROL
(Continued)**

Replacement (continued)



4. Use the lift tool and lift the hinged element from the vat.

CAUTION

Avoid putting the lift tool in the center of the elements, at the same area as the high limit bulb, or damage to the high limit could result.



5. Pull the high limit from the bracket, pull back the cardboard protector, and remove the two electrical wires from the high limit control.



6. Pull-out on the drain valve knob and drain the oil from the vat.



7. While holding the top-side capillary bracket, use a Phillip's-head screwdriver and remove the screws securing the capillary bulb to the lower element bracket. Remove both front and rear capillary brackets.

**6-5. HIGH TEMPERATURE
LIMIT CONTROL
(Continued)**

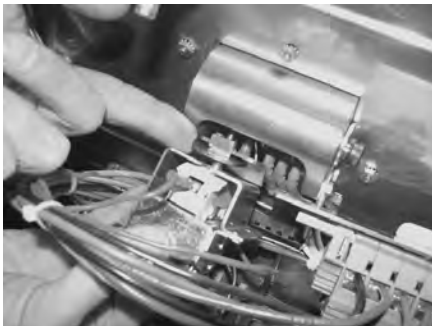

Replacement (continued)

8. Using a Phillip's-head screwdriver, remove the screws securing the capillary bulb to the upper element brackets.
9. Remove high limit bulb from element and carefully straighten the capillary tube and pull the high limit control from the rear of the unit.

It's important not to damage the capillary bulb when removing or installing the high limit from the unit. Undamaged high limits returned for warranty can be evaluated for cause of failure.

Capillary bulbs or tubes damaged during installation causes high limit to fail prematurely. See damaged capillary bulb below.

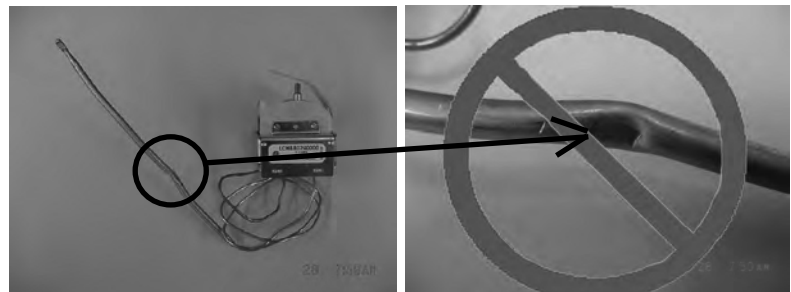

10. Insert new high limit capillary through hole in rear of fryer and slide high limit into bracket and then secure with the 2 screws.
11. Slide bracket and high limit assembly into place, making sure a 1/8" (2-3mm) gap remains between the red high limit button and the reset place, and then secure with the 2 acorn nuts removed in step 3.
12. Carefully slide capillary bulb up through the element, from the rear of the elements.

**6-5. HIGH TEMPERATURE
LIMIT CONTROL
(Continued)**

Replacement (continued)

13. Using the capillary brackets removed in step 3 (see below), attach the capillary to the lower brackets, aligning the capillary so it does NOT touch the element. (See side-view drawing for proper installation)

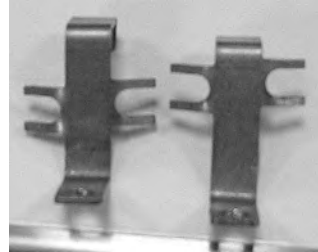

Left-Front/Right-Rear

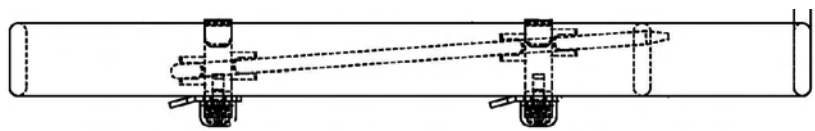

Element Side View



14. Secure the capillary to the upper brackets.
15. Replace rear cover and reconnect power to vat.
16. Lower element back into vat and close drain. Fill vat by pressing and holding **F** button until *FILTER**MENU* shows in the display. Then once "1.EXPRESS FILTER" shows in the display, press **▶** 4 times until "5.FILL FROM PAN" shows in the display. Press **√** button and "PUMP" "EXIT" shows in the display. Press **√** button again, and oil fills vat. Once vat is full, press **X** twice to return to normal operation.

6-6. BREAKERS

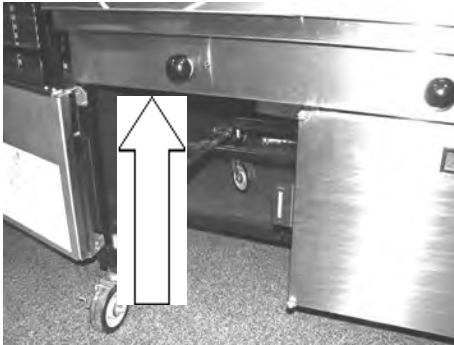

There are 4 breaker on the electric fryers. To reset the breaker, open the left door and and locate breakers behind drain knob plate. Push on the plunger on the breaker to reset.



To avoid electrical shock or property damage, move the power switch to OFF and disconnect main circuit breaker, or unplug cord at wall receptacle.



Checking Procedure for Breaker

Remove the left control panel and pull the wires from the breaker. Using a multimeter or continuity light, check across the terminals. The circuit should be closed. If not, replace the breaker (HP# EF02-125).



To replace breaker, remove left control panel and pull wires from breaker.

Use a 9/16" wrench and loosen the nut securing the breaker from underneath and then pull the breaker from the control panel area.

6-7. MAIN POWER SWITCH

This is a covered rocker switch, which in the ON position, sends power to all the controls and filter motor.



To avoid electrical shock or property damage, move the power switch to OFF and disconnect main circuit breaker, or unplug cord at wall receptacle.



1. Remove right side panel.
2. Label and remove wires from the switch.
3. From the inside of the control area, squeeze in on the tabs on the back of the switch and push the switch out the front of the control area.

Checkout

4. Check across the two sets of terminals of the switch for continuity. With the switch in the ON position, the circuit should be closed. With the switch in the OFF position, the circuit should be open.

If the switch is found to be defective, replace it by connecting the wires to it (as labeled) and push new switch into place.

6-8. TEMPERATURE PROBE REPLACEMENT

The temperature probe relays the actual shortening temperature to the control. If it becomes disabled, "E-6" shows in the display. Also, if the temperature is out of calibration more than 10°F, or 10°C, the temperature probe should be replaced. (See Section 5-4. TECH MODE for probe calibration steps.)

Temp. F	Temp. C	Resistance Ohms	Temp. F	Temp. C	Resistance Ohms
50	10.00	1039.02	250	121.11	1464.79
60	15.56	1060.65	260	126.67	1485.71
70	21.11	1082.24	270	132.22	1506.58
80	26.67	1103.80	280	137.78	1527.43
90	32.22	1125.32	290	143.33	1548.23
100	37.78	1146.81	300	148.89	1569.00
110	43.33	1168.26	310	154.44	1589.73
120	48.89	1189.67	320	160.00	1610.43
130	54.44	1211.05	325	162.78	1620.77
140	60.00	1232.39	330	165.56	1631.08
150	65.56	1253.70	340	171.11	1651.72
160	71.11	1274.97	350	176.67	1672.31
170	76.67	1296.20	360	182.22	1692.86
180	82.22	1317.40	365	185.00	1703.13
185	85.00	1327.99	370	187.78	1713.38
190	87.78	1338.57	380	193.33	1733.87
200	93.33	1359.69	390	198.89	1754.31
210	98.89	1380.79	400	204.44	1774.72
212	100.00	1385.00	410	210.00	1795.10
220	104.44	1401.84	420	215.56	1815.44
230	110.00	1422.86	430	221.11	1835.74
240	115.56	1443.85	440	226.67	1856.01

An Ohm check can be performed also. See chart at left and Checkout instructions on next page.

**6-8. TEMPERATURE PROBE
REPLACEMENT
(Continued)**

Checkout:



To avoid electrical shock or property damage, move the power switch to OFF and disconnect main circuit breaker, or unplug cord at wall receptacle.



1. Remove control panel and hinge it down.
2. Referring to the decal on the rear of the control panel, locate the 12-pin probe connector in the upper, right-hand corner. (An ohm chart is also shown on the decal.)
3. Pull the connector from the panel and using a multimeter, take an ohm reading on the appropriate Oil Temp pins. If ohm reading is significantly different than the chart, continue with replacement instructions.



Replacement:

1. Pull-out on the drain valve knob and drain the oil from the vat.



2. Remove the rear panel (9 screws).
3. Using a 1/2" wrench, remove the nut on the compression fitting, and remove the temperature probe from the vat.



4. Follow the probe wires and disconnect the 2 probe connectors. (These may be found behind the control panel or behind the side panels, depending upon which vat is being serviced.)

**6-8. TEMPERATURE PROBE
REPLACEMENT
(Continued)**

5. Follow probe installation instructions below:

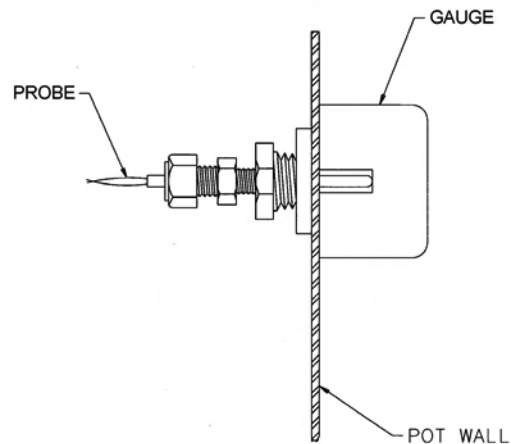

- NOTE:
1.) LOCATE TEMPERATURE PROBE THRU POT WALL.
2.) PLACE GAUGE AGAINST POT WALL AS SHOWN.
3.) PUSH TEMPERATURE PROBE THRU UNTIL IT MAKES CONTACT WITH GAUGE.
4.) TIGHTEN TEMPERATURE PROBE IN PLACE.

CAUTION

Excess force will damage temperature probe. Hand-tighten nut and then 1/2 turn with a wrench.

6. Connect new temperature probe to the 2 fryer connections.
7. Replace rear cover and reconnect power to vat.
8. Lower element back into vat and close drain. Fill vat by pressing and holding **F** button until *FILTER* *MENU* shows in the display. Then once "1.EXPRESS FILTER" shows in the display, press **▶** 4 times until "5.FILL FROM PAN" shows in the display. Press **√** button and "PUMP" "EXIT" shows in the display. Press **√** button again, and oil fills vat. Once vat is full, press **X** twice to return to normal operation.

**6-9. OIL CHANNEL
CLEAN-OUT**



Should the drain channel, under the vats, become clogged, access to a clean-out plug is available by removing the right or left side panels.

6-10. ELEMENT SAFETY SWITCH

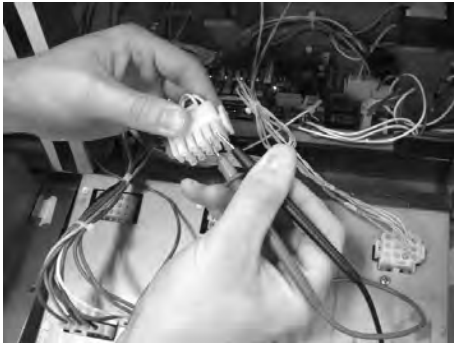

This switch cuts power to the element when the element is raised.

If a constant “E-31” “HEATING ELEMENTS ARE UP”, is shown on the display, when the elements are lowered into the vat, check the element safety switch.



To avoid electrical shock or property damage, move the power switch to OFF and disconnect main circuit breaker, or unplug cord at wall receptacle.

Checkout:

1. Remove control panel and hinge it down.
2. Referring to the decal on the rear of the control panel, locate P9 connector (left vat-split vat) or P10 connector (full or right vat).
3. Pull the connector from the panel and using a multimeter, check for continuity between the 2 appropriate pins (labeled HEAT SWITCH). With the plunger on the safety switch pushed in (element lowered), the circuit should be closed. With the element raised, the circuit is should be open. If the switch proves to be faulty, continue with replacement instructions.



Replacement:

1. Remove the rear panel (9 screws).
2. Pull the wires from the switch.
3. Use Phillip's-head screwdriver and remove the 2 screws securing the switch.
4. Reassemble with new switch, making sure the plate pushes-in the switch plunger, activating the switch, and then reconnect power to the fryer.



6-11. CONTACTORS

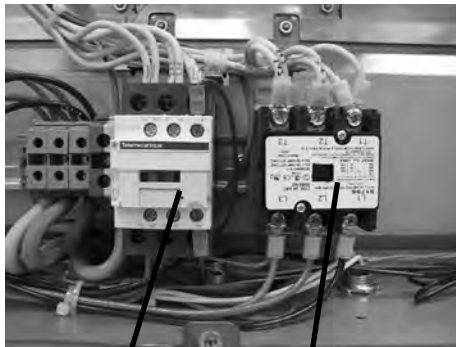

Heat

Safety

The Evolution Elite® fryer requires two switching, 24V contactors per vat: a primary and a heat contactor. The primary contactor energizes (contacts close) any time the main power switch is in the ON position, and the temperature of the shortening is below 420° F (215° C). The high limit cuts power at the primary contactor if the temperature of the shortening is above 420° F (215° C). The primary contactor supplies power to one side of the heat contactor.

The heat contactor is controlled by the computer controller. When the  button is pressed and the controller calls for heat, the heat contactor applies power to one side of the heating elements. When the heat contactor and primary contactor are energized (contacts closed) the electric heating elements heat the shortening.



Checkout

1. Remove electrical power supplied to the fryer.



To avoid electrical shock or property damage, move the power switch to OFF and disconnect main circuit breaker, or unplug cord at wall receptacle.

2. Remove the top, rear panel.

3. Label and remove wires from contactors and perform a check on both contactors as follows:

<u>Test Points</u>	<u>Results</u>
From 30 to 34	open circuit
From 31 to 35	open circuit
From 32 to 36	open circuit
From 33 to 37 (coil)	ohm reading 5 to 6



To avoid electrical shock, make connections before applying power, take reading, and remove power before removing meter leads. The following checks are performed with the wall circuit breaker closed and the main power switch in the ON position.

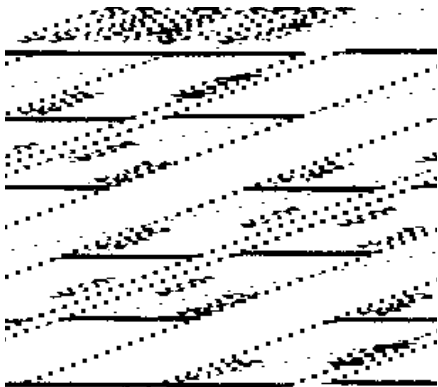

6-11. CONTACTORS **(Continued)**



4. With power reapplied and in a heat-up mode, check the power going to both contactor coils. Power should be going to both contactors.

If no voltage is found going into the primary contactor coil, check wiring, high limit, and element switch.

If no voltage at heat contactor coil check wiring and connections at PC board.

Replacement

If either contactor proves defective, replace as follows:



To avoid electrical shock or property damage, move the power switch to OFF and disconnect main circuit breaker, or unplug cord at wall receptacle.



1. Label and remove only those wires directly connected to the contactor being replaced.



2. Using a 3/8" wrench or socket, remove the 2 mounting nuts on the base plate of the contactor being replaced and remove contactor.

3. When replacing the heat contactor, slide it from the mounting rail.

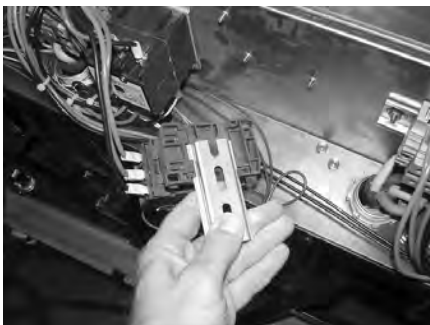

4. Install new contactor in reverse order.

5. Replace rear panel and reconnect power to the fryer and test for proper operation.

6-12. SOLENOID VALVES

Each vat has a solenoid plumbed-into the oil return lines. They are normally closed, but open when power is supplied, such as, the controls are filling the vats.

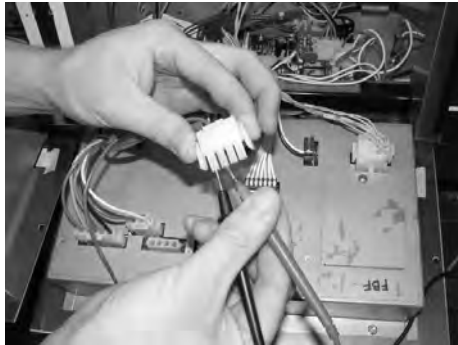

To avoid electrical shock or property damage, move the power switch to OFF and disconnect main circuit breaker, or unplug cord at wall receptacle.

1. Remove control panel and hinge it down.
2. Referring to the decal on the rear of the control panel, locate P3 connector (left vat-split vat) or P4 connector (full or right vat).
3. Pull the connector from the panel and using a multimeter, take an ohm reading on the appropriate pins. If ohm reading is significantly different than the chart below, continue with replacement instructions.

120Volts-60Hertz	50 Ohms
220-240Volts-50Hertz	230 Ohms

Replacement

1. Remove the rear panel (9 screws).
2. Remove the plastic retaining clip on top of the coil housing.
3. Push-down and then lift-up on name-plate and remove the name-plate, cover and coil housing from solenoid stem.
4. Using a 1" wrench, loosen the fitting on the right side of the solenoid.

6-12. SOLENOID VALVES
(Continued)



5. Pull the elbow away from the 1" nut, and using a 1-1/16" wrench or adjustable wrench, hold the solenoid in place while using another wrench to remove the elbow from the solenoid. Attach elbow to new solenoid, using pipe sealant on the threads.



6. Pull the coil housing from the solenoid stem. Hold the pipe nipple in place with a pipe wrench and using a 1-1/16" wrench or adjustable wrench, remove the solenoid from the nipple.



7. Remove the conduit from the fryer and pull the coil assembly from the fryer.

8. Disconnect conduit at coil.



9. Thread the wires of the new solenoid through the conduit and reattach the conduit to the fryer.

10. Wire nut the solenoid wires onto the fryer wires, and then, attach the solenoid assembly onto the fittings of the fryer.

11. Replace rear cover and reconnect power to the fryer.

6-13. FILTER PUMP & MOTOR



The 2 most common causes for a fryer not to pump oil are that the pump is clogged, or the thermal overload switch has been tripped on the motor. The pump and motor is located on the rear of the fryer.

To remove debris from pump:

1. Loosen the four Allen head screws on the end of pump and remove the cover. (Removing the bottom rear panel may help in accessing the set screws.)
2. The inside is now exposed leaving a rotor and five teflon rollers. Clean the rotor and rollers.
3. To reassemble, place rotor on drive shaft, and place roller into rotor.

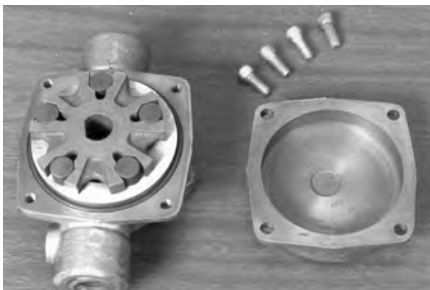

NOTICE

A small amount of grease might be needed to hold the bottom roller into place until cover plate is put on. Make sure O-ring is in proper position on plate.



CAUTION

There is an indicator on the side of the two halves of the pump, this mark must be together



To reset the thermal overload switch:

1. Locate the pump and motor in the rear of the fryer and if the motor is hot, allow it to cool for about 5 minutes.
2. Since it takes some effort to reset the switch, use a tool, such as a Phillip's-head screwdriver, to press against the reset button until a "click" is heard.

6-13. FILTER PUMP & MOTOR
(Continued)



To avoid electrical shock or property damage, move the power switch to OFF and disconnect main circuit breaker, or unplug cord at wall receptacle.

Motor Removal:

1. Remove JIB from fryer.



2. Remove the rear panel and the right side panel.

3. Using a 7/8" wrench, loosen the front, flexible line fitting, on the pump.



4. Using a 1" wrench, loosen the rear pump fitting.

5. Using Phillip's-head screwdriver, remove the rear cover from motor, exposing the wires.



6. Loosen the conduit clamp and pull the wires through the conduit clamp.

6-13. FILTER PUMP & MOTOR
(Continued)



7. Using a 7/16 in. wrench, remove the 4 bolts securing the motor to the motor bracket and pull the pump and motor assembly from fryer.
8. Pull pump and motor out, from front of fryer, across the JIB shelf.

To replace pump on motor:

1. Using a 1/2 in. wrench, remove the 2 bolts securing the pump to the motor and pull the pump from the motor.
2. Install a new seal kit (part no. 17476) onto shaft of motor.
3. Align the shaft of the motor with the rotor on the inside of the pump and push pump onto shaft of motor.
4. Secure the pump onto the motor with the 2 bolts.

6-14. JIB PUMP



6-15. EXPRESS FILTER PC BOARD



This pump keeps the vats filled and is used in the Oil Guardian™ process.

Replacement



To avoid electrical shock or property damage, move the power switch to OFF and disconnect main circuit breaker, or unplug cord at wall receptacle.

1. Remove the right side panel.
2. Using a 1” wrench, loosen fitting on right side of pump.
3. Remove the hose from the pump.
4. Remove the 4 bolts securing the bottom of pump.
5. Disconnect the wires in the rear of the pump and pull assembly from fryer.
6. Pull fittings from faulty pump and attach the fittings to the new pump, in the same orientation.
7. Install new pump assembly in fryer, in reverse order and then reconnect power to fryer.

This electronic board controls the Automatic Intermittant Filtering process.

Replacement



To avoid electrical shock or property damage, move the power switch to OFF and disconnect main circuit breaker, or unplug cord at wall receptacle.

1. Hinge-down the center control panel (right panel on 2 vat units).
2. Pull connectors from PC board, located behind control panel.
3. Using a 5/16” socket, remove the 6 nuts securing the board and remove it from the fryer.
4. Install in reverse order. The control connectors are colored-coded; Left-Red; Middle-White; Right-Blue.

6-16. TRANSFORMERS

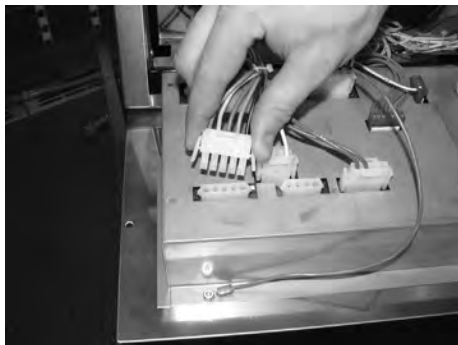

Control Transformer Connector

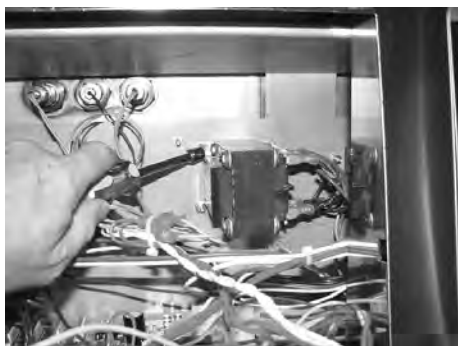
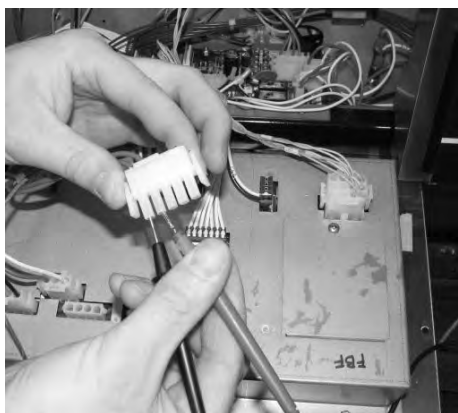

Express Filter Transformer



Control Transformer

Both the Express Filter transformer and the control transformer are the same part number. These components drop the line voltage to low voltage components such as, control board, Express Filter board and contactors.

Checkout:



To avoid electrical shock or property damage, move the power switch to OFF and disconnect main circuit breaker, or unplug cord at wall receptacle.

1. Hinge-down the control panel to access the desired transformer.
2. Pull the appropriate white connector, either from the Express Filter PC board or from the control PC board.



To avoid electrical shock, use care when checking the transformer. The following checks are performed with the wall circuit breaker closed and the main power switch in the ON position.

3. With the power on, take a voltage reading on the appropriate pins, using the chart and drawing below. If transformer proves faulty, continue with replacement instructions.

Pin 1-2 = 24 VAC
Pin 4-5 = 240 VAC
Pin 3-5 = 208 VAC

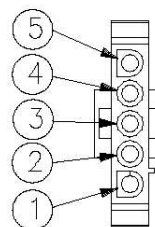

Replacement

1. Disconnect power and using a 5/16" socket, remove the nuts securing the transformer and pull the transformer from unit.
2. Replace transformer in reverse order.

6-17. FILTER MOTOR RELAY

This component is located behind the left control panel and regulates voltage to the filter motor.



Replacement:



To avoid electrical shock or property damage, move the power switch to OFF and disconnect main circuit breaker, or unplug cord at wall receptacle.

1. Hinge-down the left control panel.
2. Label and remove wires from relay.
3. Using a 5/16" wrench, remove the nuts securing the relay and remove relay from fryer.
4. Install new relay in reverse order.

6-18. DRAIN PAN SWITCH

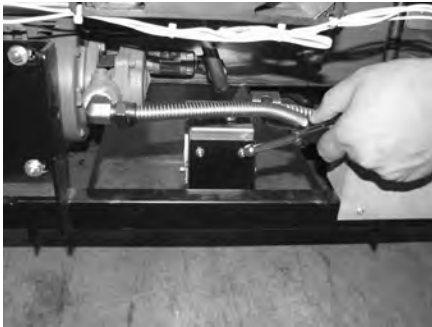

This switch closes when the drain pan is pushed properly in place under the fryer. If the drain pan is not properly in place, or the drain switch is faulty, display prompts such as, “CHECK PAN”; “FILTER PAN MISSING”; “CHANGE FILTER PAD” shows in the display.



To avoid electrical shock or property damage, move the power switch to OFF and disconnect main circuit breaker, or unplug cord at wall receptacle.

1. Remove control panel and hinge it down.
2. Locate the 8-pin connector on the Express Filter PC board and pull the connector from the board.
3. Check for normally open circuit between the pins with wires labeled D1 & D2. If the circuit shows closed, continue with the replacement instructions below.

Replacement:

1. Drain pan switch is located on the rear of the fryer. Using a 3/8” socket or nut driver, remove the nuts securing the drain switch bracket to the fryer.
2. Using a 1/8” Allen wrench, remove the shoulder bolt securing the cover and remove cover.
3. Using a Phillips-Head screwdriver, remove the screws securing the switch to the bracket and remove switch from bracket.
4. Label and remove wires from switch
5. Replace faulty switch, placing wires on new switch on the normally open and common terminals.

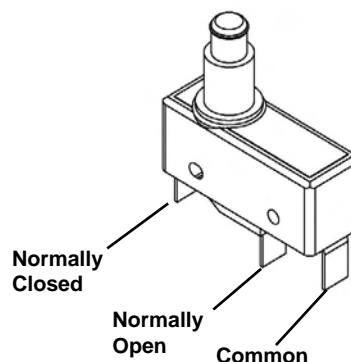

6-19. FILTER BEACON®

Replacement



To avoid electrical shock or property damage, move the power switch to OFF and disconnect main circuit breaker, or unplug cord at wall receptacle.

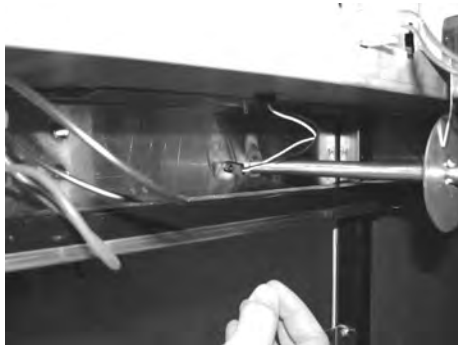

1. Remove right or left side panel for end vats, or hinge-down the control panel for center vats.

2. Pull apart the light by pulling on the rear of the light and removing the front part of the light from the front of the fryer.

3. Locate and cut the light wires and pull the light from unit.

4. Connect new light wires, using wirenuts and install light in reverse order.

5. Restore power to the unit.

6-20. OIL LEVEL PROBES



Oil level probes

The oil level probes (left & right-see photo at left) monitor the oil level by temperature differences. If they becomes disabled, the display shows: “E-18A”= left probe; “E18-B”= right probe; “E18C”= both.

Also, if any of the probes are out of calibration more than 10°F, or 10°C, the temperature probe should be replaced. (See Section 5-4. TECH MODE for probe calibration steps.) An Ohm check can be performed also. See chart below.

Checkout:



To avoid electrical shock or property damage, move the power switch to OFF and disconnect main circuit breaker, or unplug cord at wall receptacle.

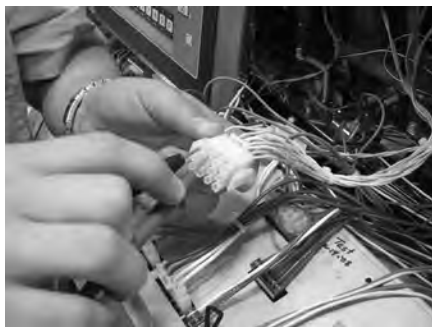

1. Remove control panel and hinge it down.
2. Referring to the decal on the rear of the control panel, locate the 12-pin probe connector in the upper, right-hand corner. (An ohm chart is also shown on the decal.)

Temp. F	Temp. C	Resistance Ohms	Temp. F	Temp. C	Resistance Ohms
50	10.00	1039.02	250	121.11	1464.79
60	15.56	1060.65	260	126.67	1485.71
70	21.11	1082.24	270	132.22	1506.58
80	26.67	1103.80	280	137.78	1527.43
90	32.22	1125.32	290	143.33	1548.23
100	37.78	1146.81	300	148.89	1569.00
110	43.33	1168.26	310	154.44	1589.73
120	48.89	1189.67	320	160.00	1610.43
130	54.44	1211.05	325	162.78	1620.77
140	60.00	1232.39	330	165.56	1631.09
150	65.56	1253.70	340	171.11	1651.72
160	71.11	1274.97	350	176.67	1672.31
170	76.67	1296.20	360	182.22	1692.86
180	82.22	1317.40	365	185.00	1703.13
185	85.00	1327.99	370	187.78	1713.38
190	87.78	1338.57	380	193.33	1733.87
200	93.33	1359.69	390	198.89	1754.31
210	98.89	1380.79	400	204.44	1774.72
212	100.00	1385.00	410	210.00	1795.10
220	104.44	1401.84	420	215.56	1815.44
230	110.00	1422.86	430	221.11	1835.74
240	115.56	1443.85	440	226.67	1856.01

3. Pull the connector from the panel and using a multimeter, take an ohm reading on the appropriate Level Probe pins. If ohm reading is significantly different than the chart, continue with replacement instructions on next page.

6-20. OIL LEVEL PROBES
(Continued)

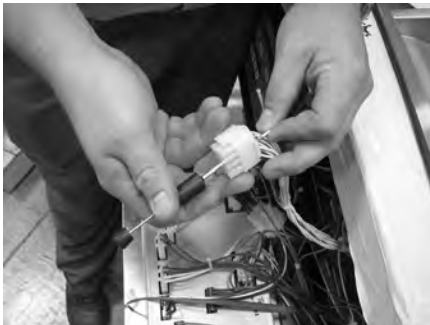

Replacement:

1. Pull-out on the drain knob and drain oil from vat.
2. Using a 1/2" wrench, remove the nut on the compression fitting, and remove the temperature probe from the vat.
3. Using a terminal extractor, remove the probe terminals from the connector and pull remove probe from unit.
4. Place the nut and new ferrule on the new temperature probe and insert the temperature probe into the compression fitting.

Follow probe installation instructions below:

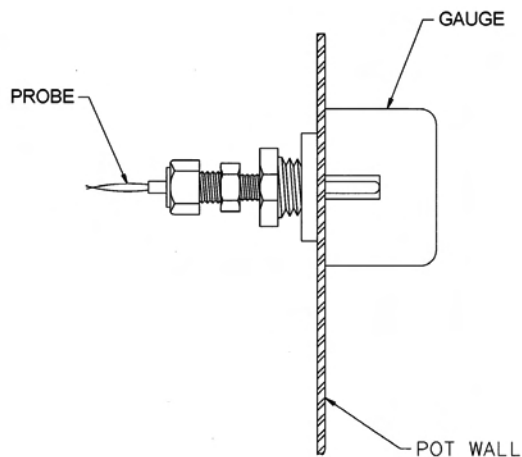

- NOTE:
- 1.) LOCATE TEMPERATURE PROBE THRU POT WALL.
 - 2.) PLACE GAUGE AGAINST POT WALL AS SHOWN.
 - 3.) PUSH TEMPERATURE PROBE THRU UNTIL IT MAKES CONTACT WITH GAUGE.
 - 4.) TIGHTEN TEMPERATURE PROBE IN PLACE.

CAUTION

Excess force will damage temperature probe. Hand-tighten nut and then 1/2 turn with a wrench.

6-20. OIL LEVEL PROBES
(Continued)

5. Connect new temperature probe to the connector and fasten connector onto control panel.
6. Replace control panel and reconnect power to vat.
7. Fill vat by pressing and holding **F** button until *FILTER* *MENU* shows in the display. Then once "1.EXPRESS FILTER" shows in the display, press **▶** 4 times until "5.FILL FROM PAN" shows in the display. Press **√** button and "PUMP" "EXIT" shows in the display. Press **√** button again, and oil fills vat. Once vat is full, press **X** twice to return to normal operation.

This component prevents the elements from heating while the drain is open by disrupting the power to the heat contactor.

6-21. DRAIN ROD
MICROSWITCH

Checkout:



To avoid electrical shock or property damage, move the power switch to OFF and disconnect main circuit breaker, or unplug cord at wall receptacle.

1. Remove control panel and hinge it down.
2. Referring to the decal on the rear of the control panel, locate P9 connector (left vat-split vat) or P10 connector (full or right vat).
3. Check for normally open circuit between the 2 appropriate pins. If the circuit shows closed, continue with the replacement instructions below.

Replacement:

1. Remove right or left side panel, depending upon what side the faulty switch is on.
2. Pull connector from behind control panel area.
3. Using Phillip's-head screwdriver and a 5/16" socket, remove the nut and screw securing the switch and remove switch from unit.
4. Remove wires from switch and place on new switch, placing them on the normally open and common terminals.
5. Install new switch in reverse order.

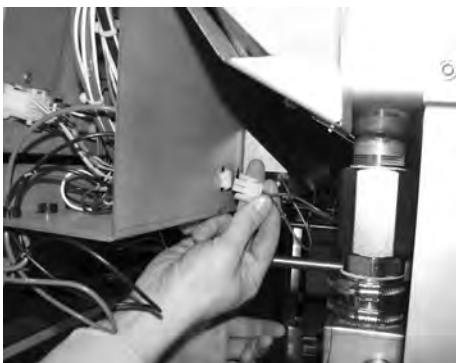

The legend below helps in identifying the components of the wiring diagrams on the following wiring diagrams.

LEGEND	
ABBREV	DEFINITION
CB	CIRCUIT BREAKER
CP	CONTROL POWER
D	DRAIN
DISV	OIL DISPOSAL VALVE
DS	DRAIN SWITCH
FL	FILTER LIGHT
G	GROUND
J	JUMPER
JM	JIB MOTOR
JMF	JIB MOTOR FUSE
JP	JUMPER POWER
L1	LINE 1
L2	LINE 2

LEGEND	
ABBREV	DEFINITION
L3	LINE 3
LDS	LEFT DRAIN SWITCH
LH	LEFT HEAT
LHL	LEFT HIGH LIMIT
LRV	LEFT RETURN VALVE
LS	LEFT SAFETY
LTS	LEFT TILT SWITCH
M	MOTOR
PB	PROBE
PS	POWER SWITCH
R	RELAY
RDS	RIGHT DRAIN SWITCH
RH	RIGHT HEAT

LEGEND	
ABBREV	DEFINITION
RHL	RIGHT HIGH LIMIT
N	NEUTRAL
RRV	RIGHT RETURN VALVE
RS	RIGHT SAFETY
RTS	RIGHT TILT SWITCH
TR	TRANSFORMER
-	EXT. OF THE SAME SIGNAL
LAL	LEFT AUTOLIFT
RAL	RIGHT AUTOLIFT

208/240 VOLT WIRING DIAGRAMS

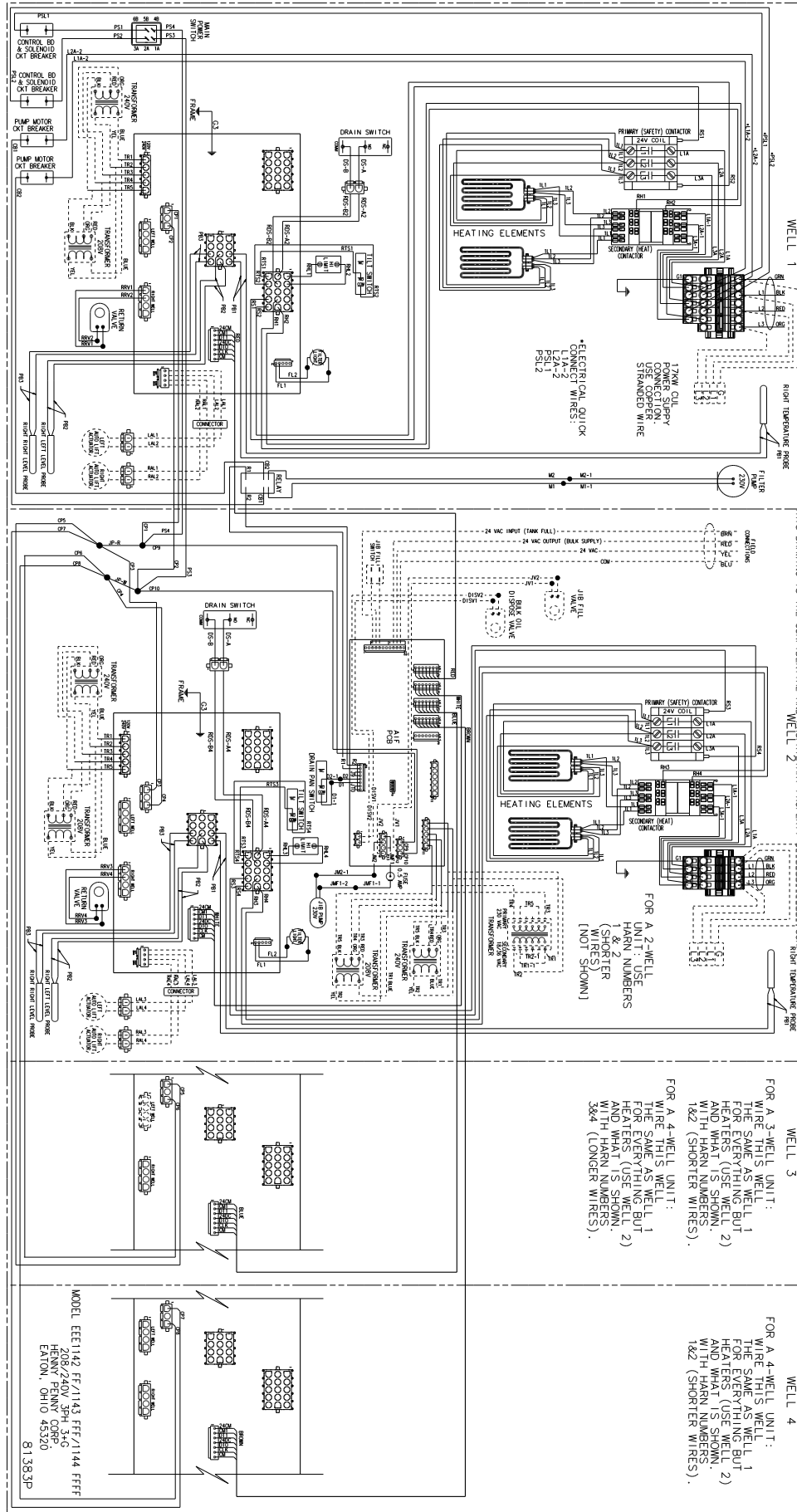

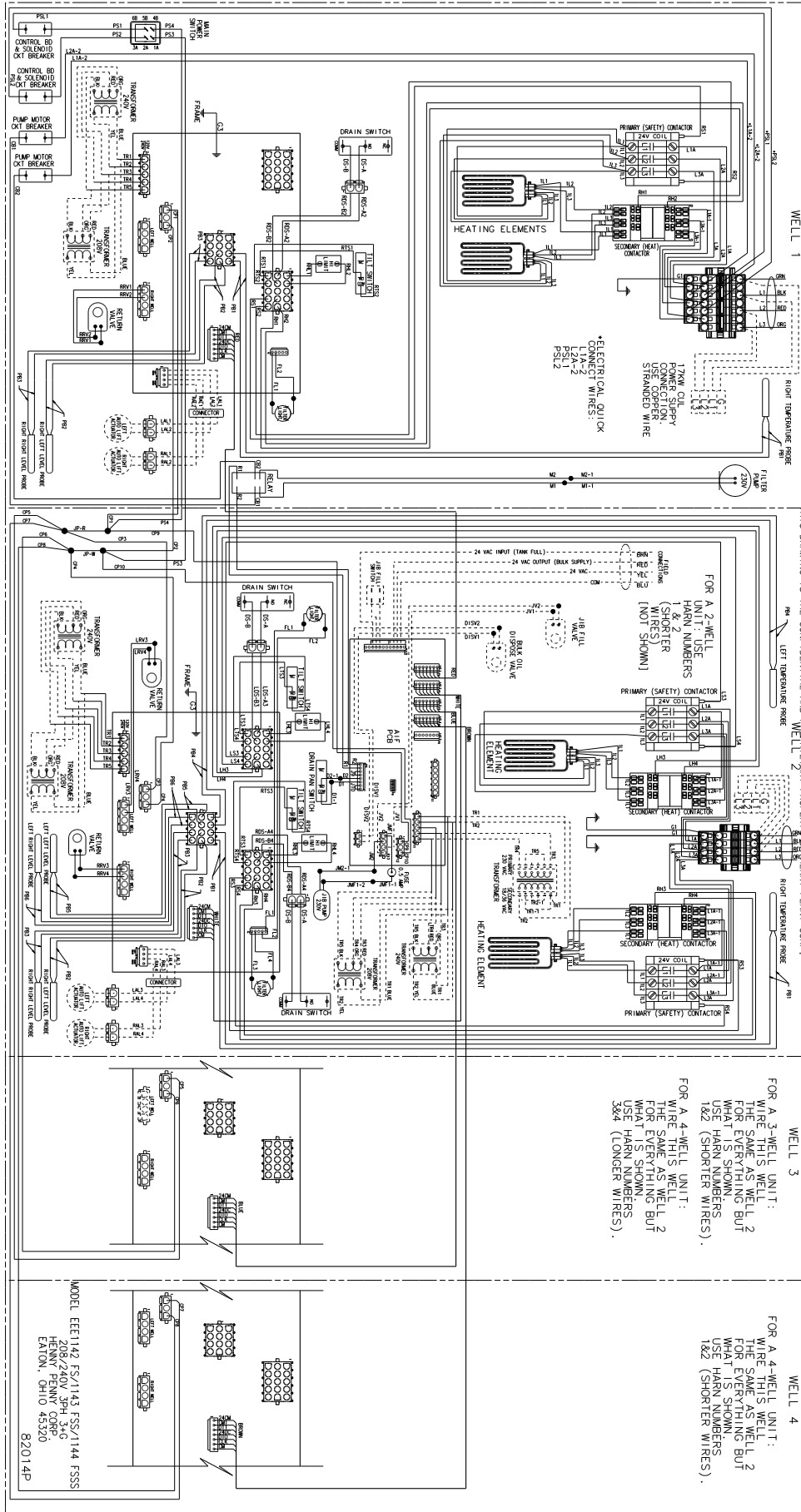

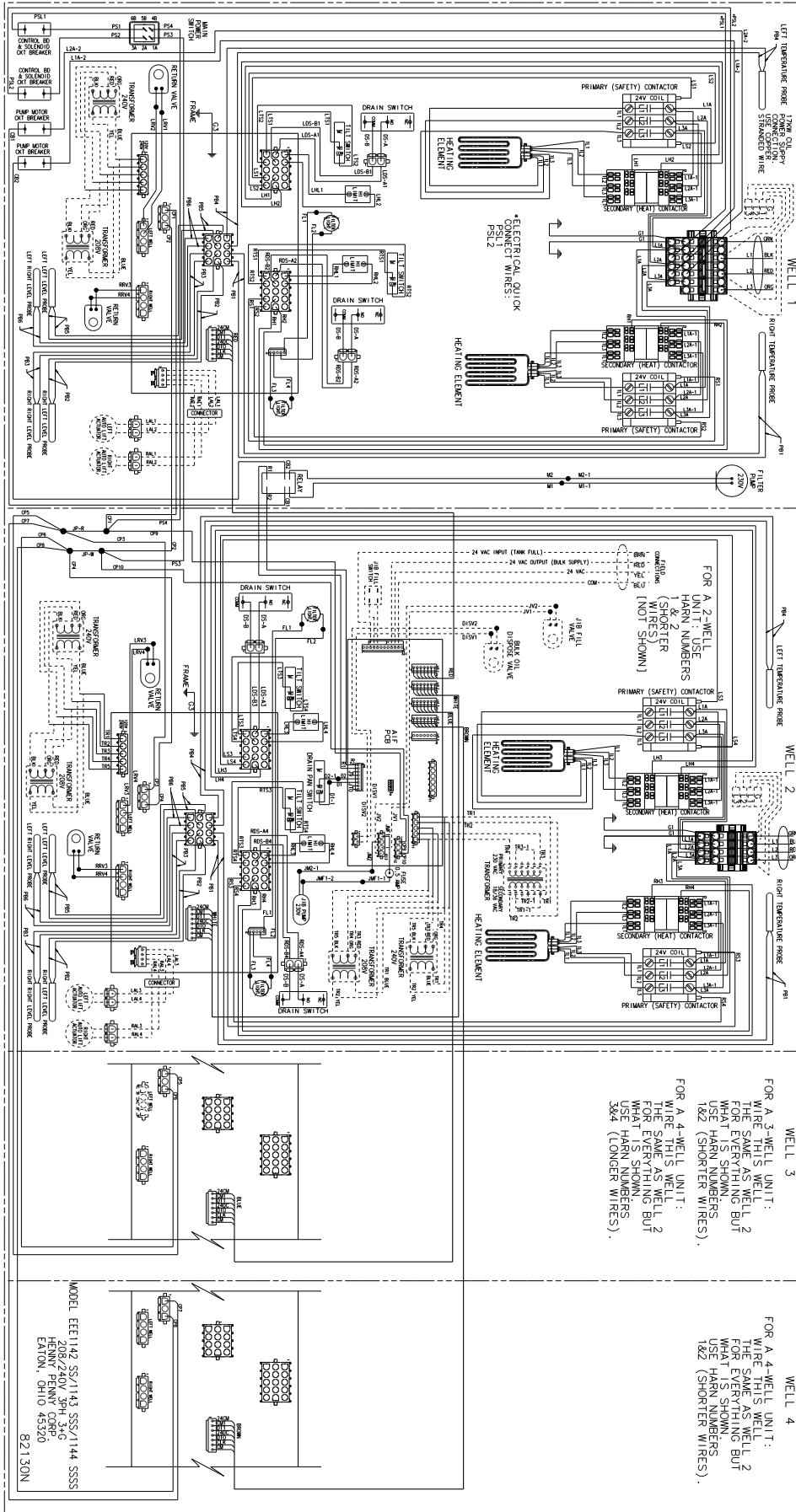

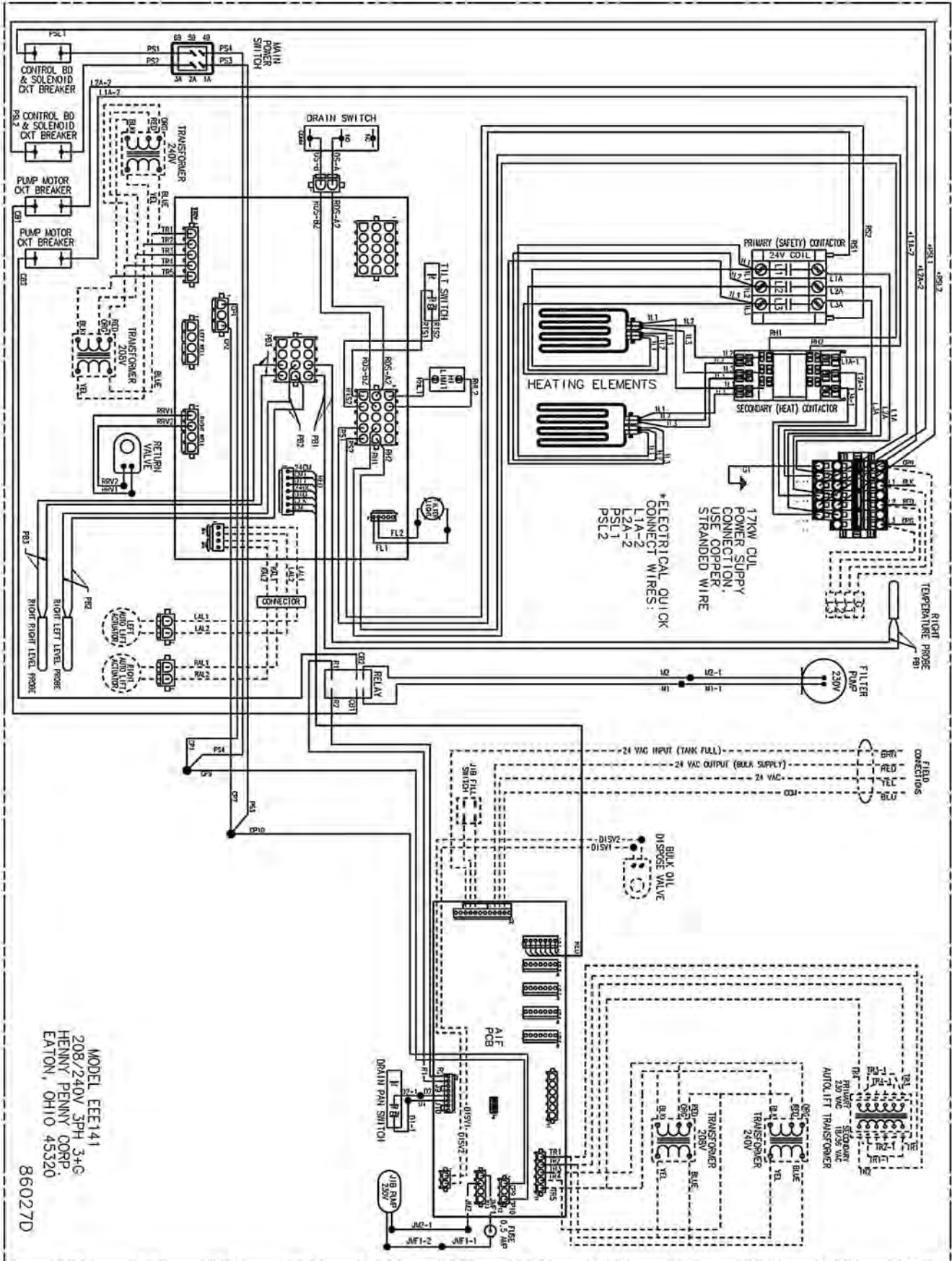

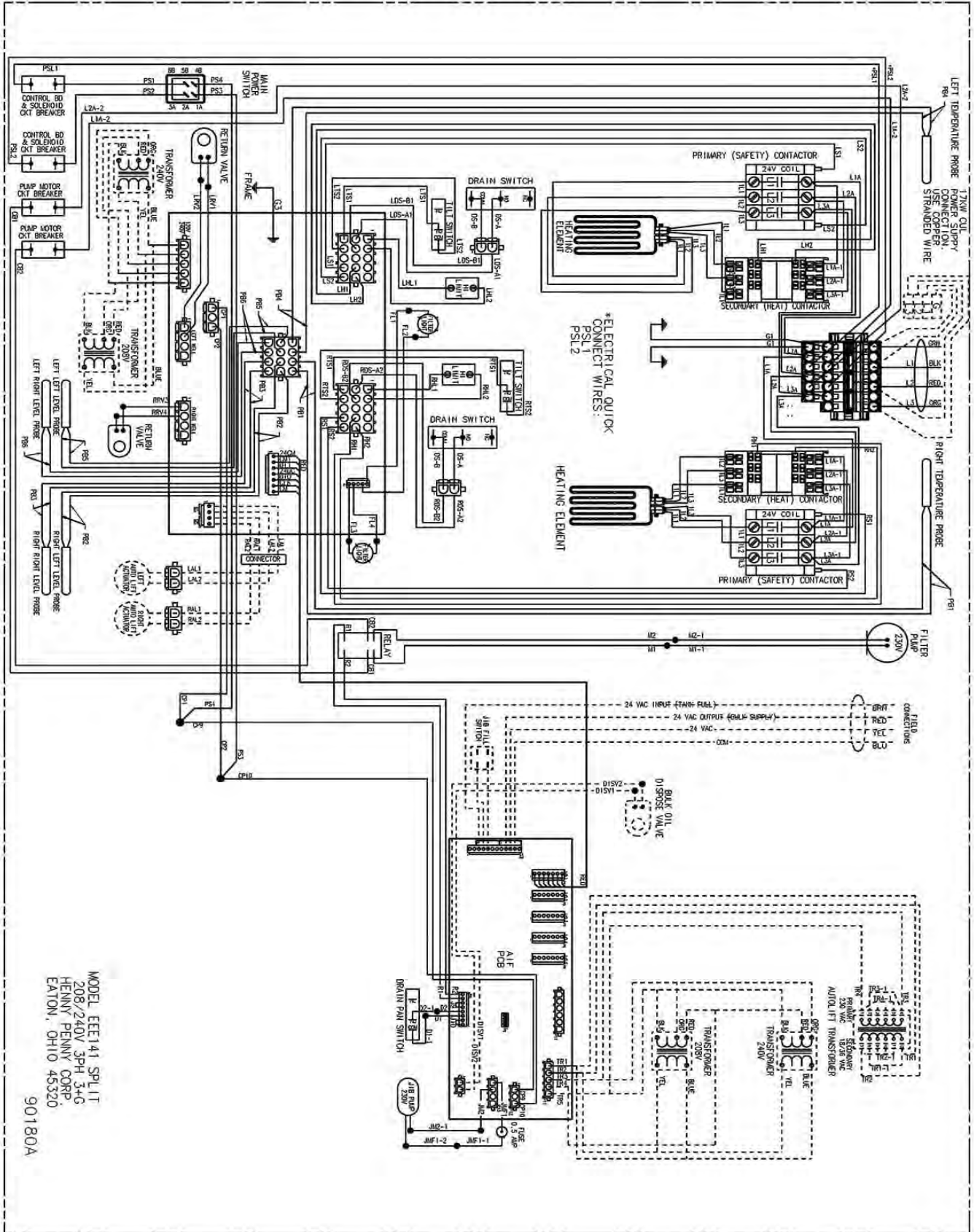

MODEL EEE141 SPLIT
208/240V 3PH 3-C
HENNY PENNY CORP.
EATON, OHIO 45320
90180A

The legend below helps in identifying the components of the wiring diagrams on the following wiring diagrams.

LEGEND	
ABBREV	DEFINITION
CB	CIRCUIT BREAKER
CP	CONTROL POWER
D	DRAIN
DISV	OIL DISPOSAL VALVE
DS	DRAIN SWITCH
FL	FILTER LIGHT
G	GROUND
J	JUMPER
JM	JIB MOTOR
JMF	JIB MOTOR FUSE
JP	JUMPER POWER
L1	LINE 1
L2	LINE 2

LEGEND	
ABBREV	DEFINITION
L3	LINE 3
LDS	LEFT DRAIN SWITCH
LH	LEFT HEAT
LHL	LEFT HIGH LIMIT
LRV	LEFT RETURN VALVE
LS	LEFT SAFETY
LTS	LEFT TILT SWITCH
M	MOTOR
PB	PROBE
PS	POWER SWITCH
R	RELAY
RDS	RIGHT DRAIN SWITCH
RH	RIGHT HEAT

LEGEND	
ABBREV	DEFINITION
RHL	RIGHT HIGH LIMIT
N	NEUTRAL
RRV	RIGHT RETURN VALVE
RS	RIGHT SAFETY
RTS	RIGHT TILT SWITCH
TR	TRANSFORMER
-	EXT. OF THE SAME SIGNAL
LAL	LEFT AUTOLIFT
RAL	RIGHT AUTOLIFT

380-414 VOLT WIRING DIAGRAMS

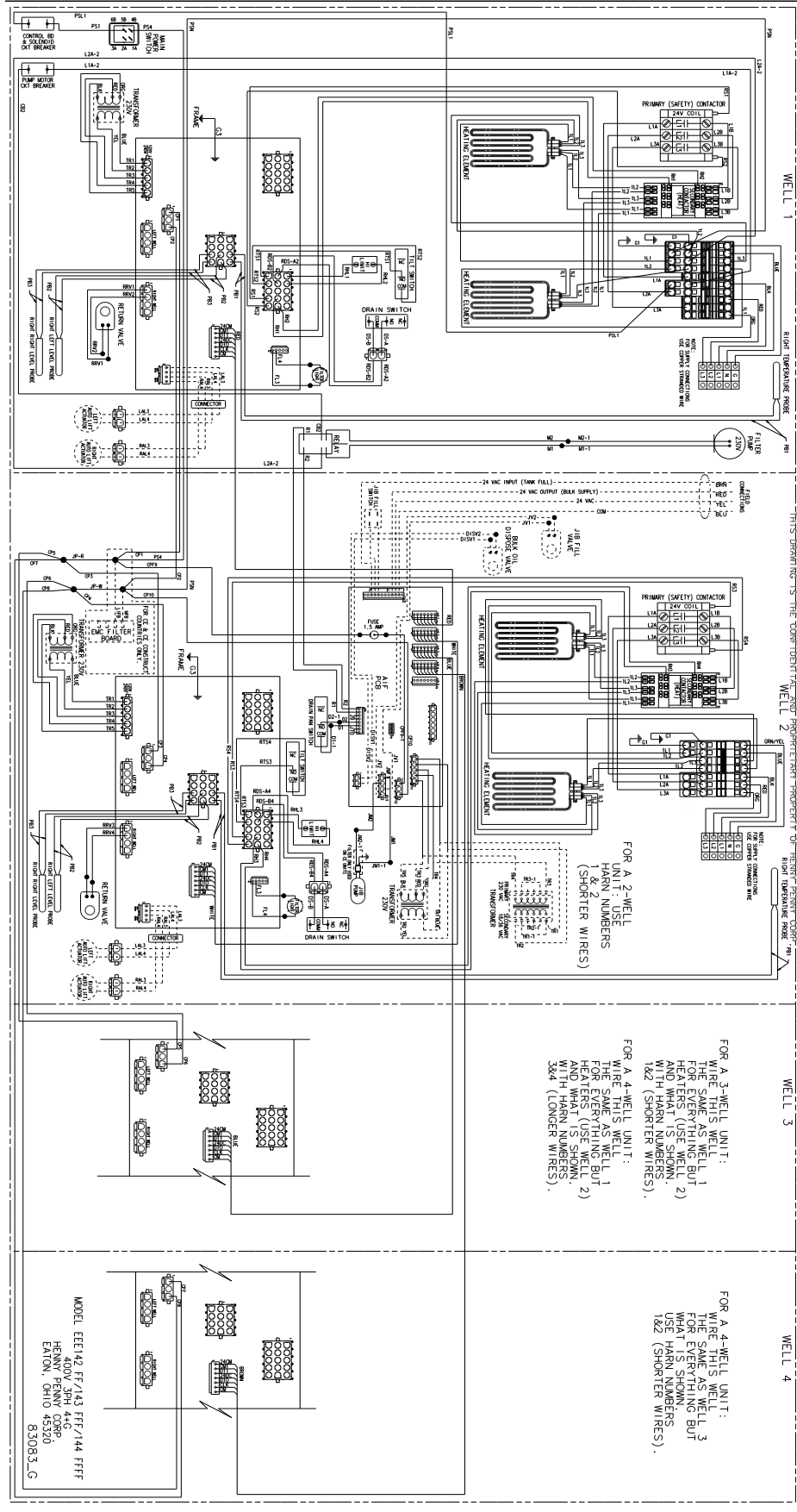

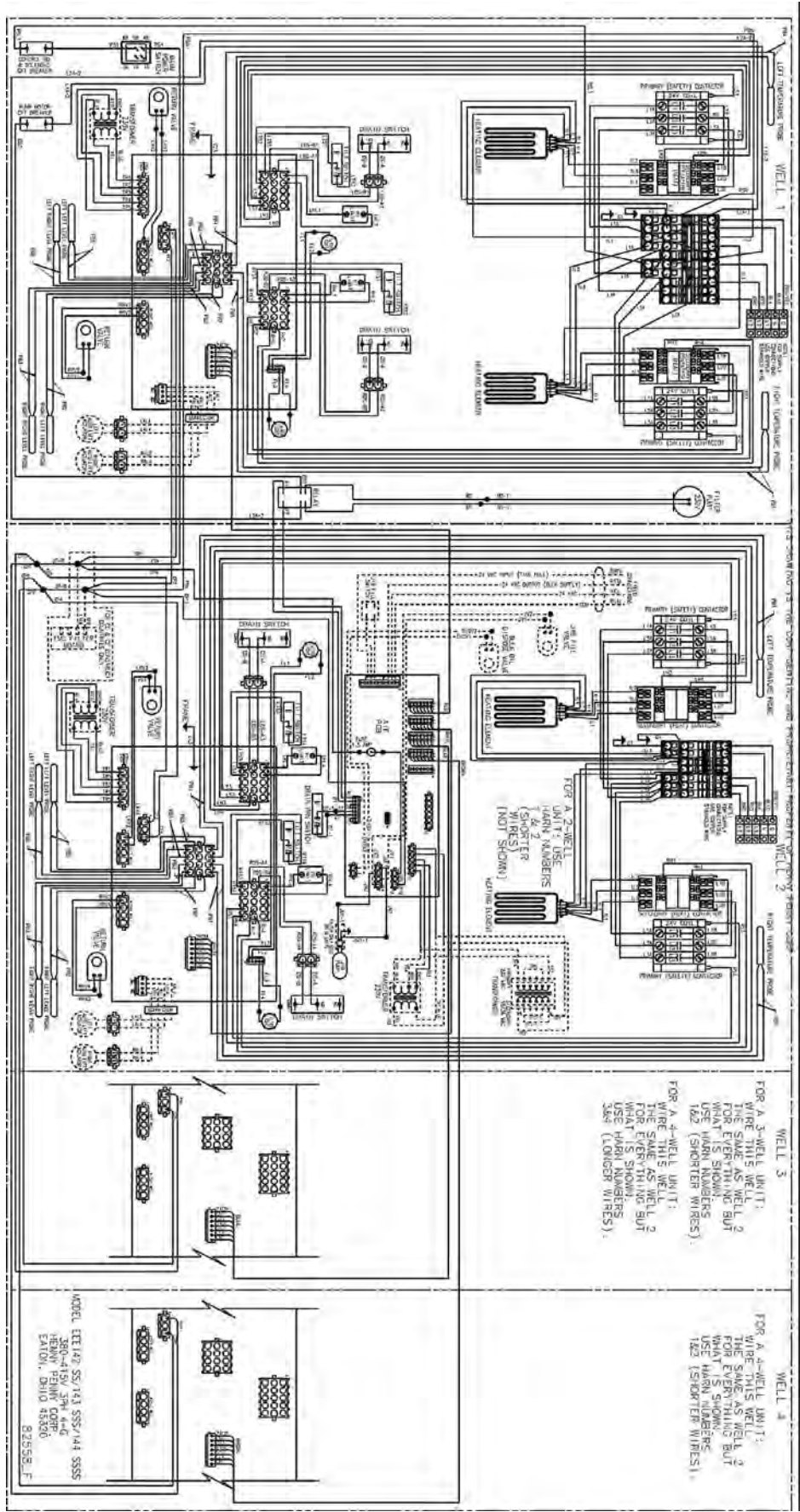

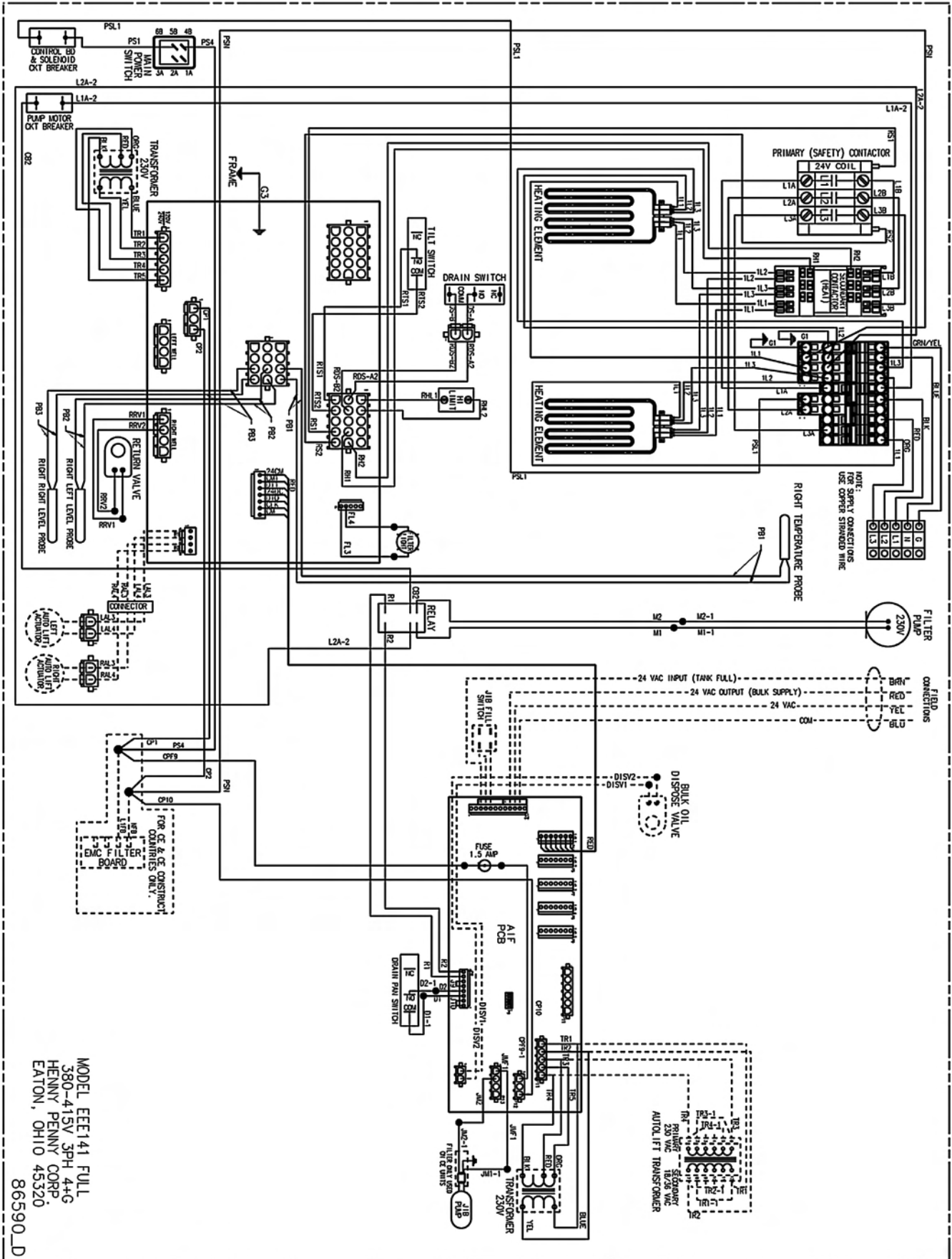

SECTION 7. PARTS INFORMATION

7-1. INTRODUCTION

This section lists the replaceable parts of the Henny Penny Evolution Elite® fryer.

7-2. GENUINE PARTS

Use only genuine Henny Penny parts in your fryer. Using a part of lesser quality or substitute design may result in damage to the unit or personal injury.

7-3. WHEN ORDERING PARTS

Once the parts that you want to order have been found in the parts list, write down the following information:

Item Number	<u>2</u>	Example:
Part Number	<u>60241</u>	
Description	<u>High Limit</u>	

From the data plate, list the following information:

Product Number	<u>01100</u>	Example:
Serial Number	<u>0001</u>	
Voltage	<u>208</u>	

7-4. PRICES

Your distributor has a price parts list and will be glad to inform you of the cost of your parts order.

7-5. DELIVERY

Commonly replaced items are stocked by your distributor and will be sent out when your order is received. Other parts will be ordered, by your distributor, from Henny Penny Corporation. Normally, these will be sent to your distributor within three working days.

7-6. WARRANTY

All replacement parts (except lamps and fuses) are warranted for 90 days against manufacturing defects and workmanship. If damage occurs during shipping, notify the carrier at once so that a claim may be properly filed. Refer to warranty in the front of this manual for other rights and limitations.

7-7. RECOMMENDED SPARE PARTS FOR DISTRIBUTORS

Recommended replacement parts are indicated with A or B in the parts lists:

A = parts to be stocked on service vans or trucks

B = parts to be stocked at the distributor/KES location.

Inventory on all other parts not identified, should be based upon usage in the territory. Please use care when ordering recommended parts, because all voltages and variations are marked. Distributors should order parts based upon common voltages and equipment sold in their territory.

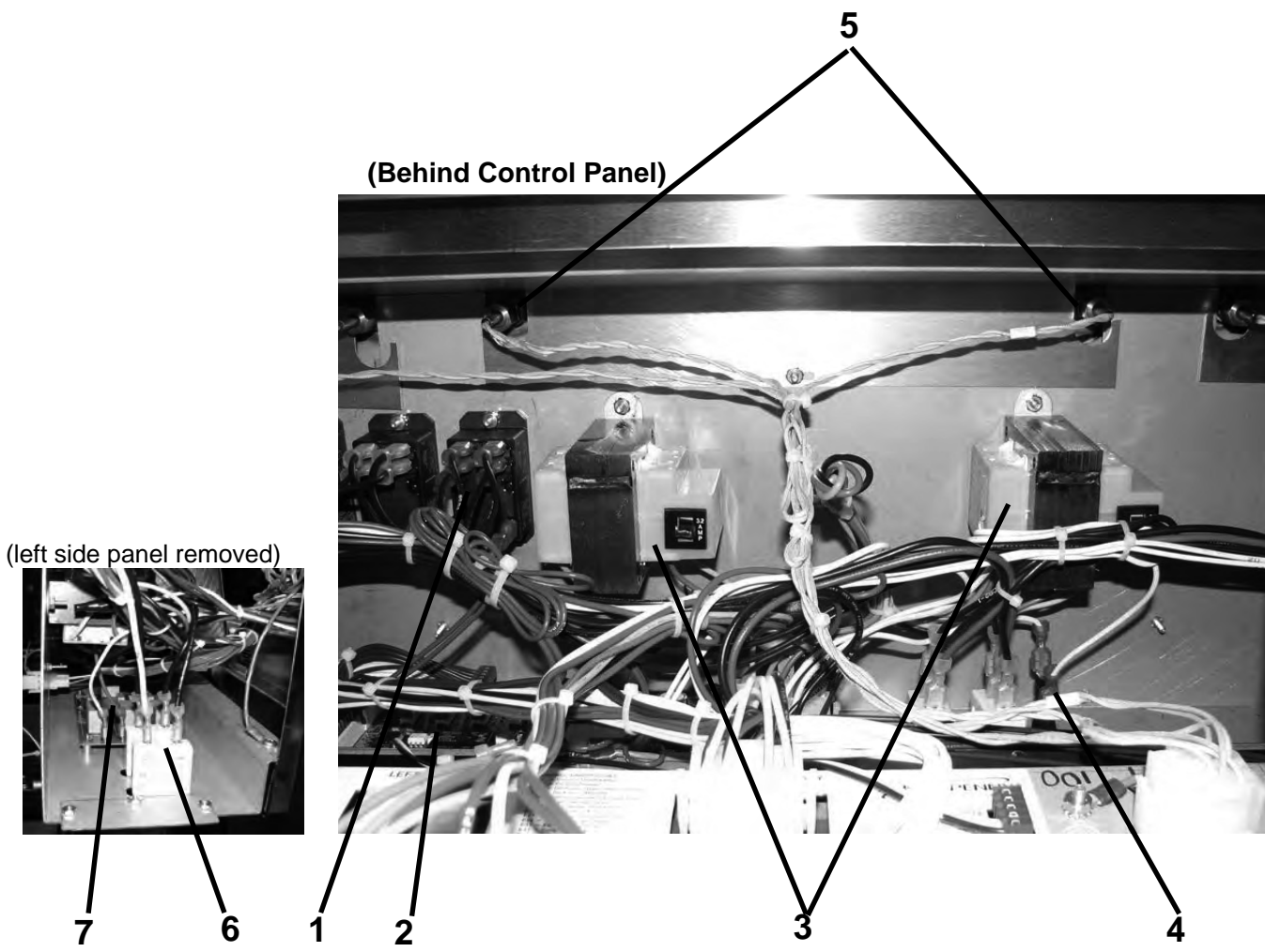

Electrical Components

ASSY-24V/208V 75VA
TRANSFORMER
Item No. Part No.

Item No.	Part No.	Description	Quantity
B 1	ME90-008	RELAY - PUMP MOTOR- 12 VDC - 30 AMP.....	AR
B 2	84454RB	PC BOARD - EXPRESS FILTER.....	1
A 3	140057	KIT-TRANSFORMER - Before 11/25/2009	1/vat**
A 3	84134	24V/208V 75VA TRANSFORMER- 11/25/2009 & After.....	1/vat**
A 3	140061	KIT-TRANSFORMER - Before 11/25/2009	1/vat**
A 3	84135	TRANSFORMER (CE) - 11/25/2009 & After.	1/vat**
A 4	EF02-104	FUSE HOLDER - 20A-250V	1
A	FA52-010	FUSE - 1 AMP (208/240V FRYERS)before SN: BK0911009 .	1
A	FA52-005	FUSE - .5 AMP (208/240V FRYERS)SN: BK0911009 & after	1
A	FA52-015	FUSE - 1.5 AMP (380/400/415V FRYERS).....	1
B 5	14974	LEVEL SENSOR - PROBES - 2.5 in.....	2/vat
A 6	EF02-125	BREAKER-PUSH BUTTON RESET - 15 AMP	AR
B 7	51065	EMC FILTER PCB - CE	1
B 8*	TS22-012	TRANSFORMER - AUTO-LIFT	1/WELL

Recommend Parts: A=Truck Stock/B=Dist. Stock / *not shown

AR=As Required

**Only wells with the Express Filter PC board behind the control panel (as shown) has 2 transformers

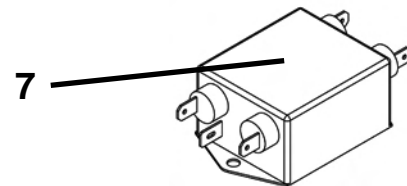
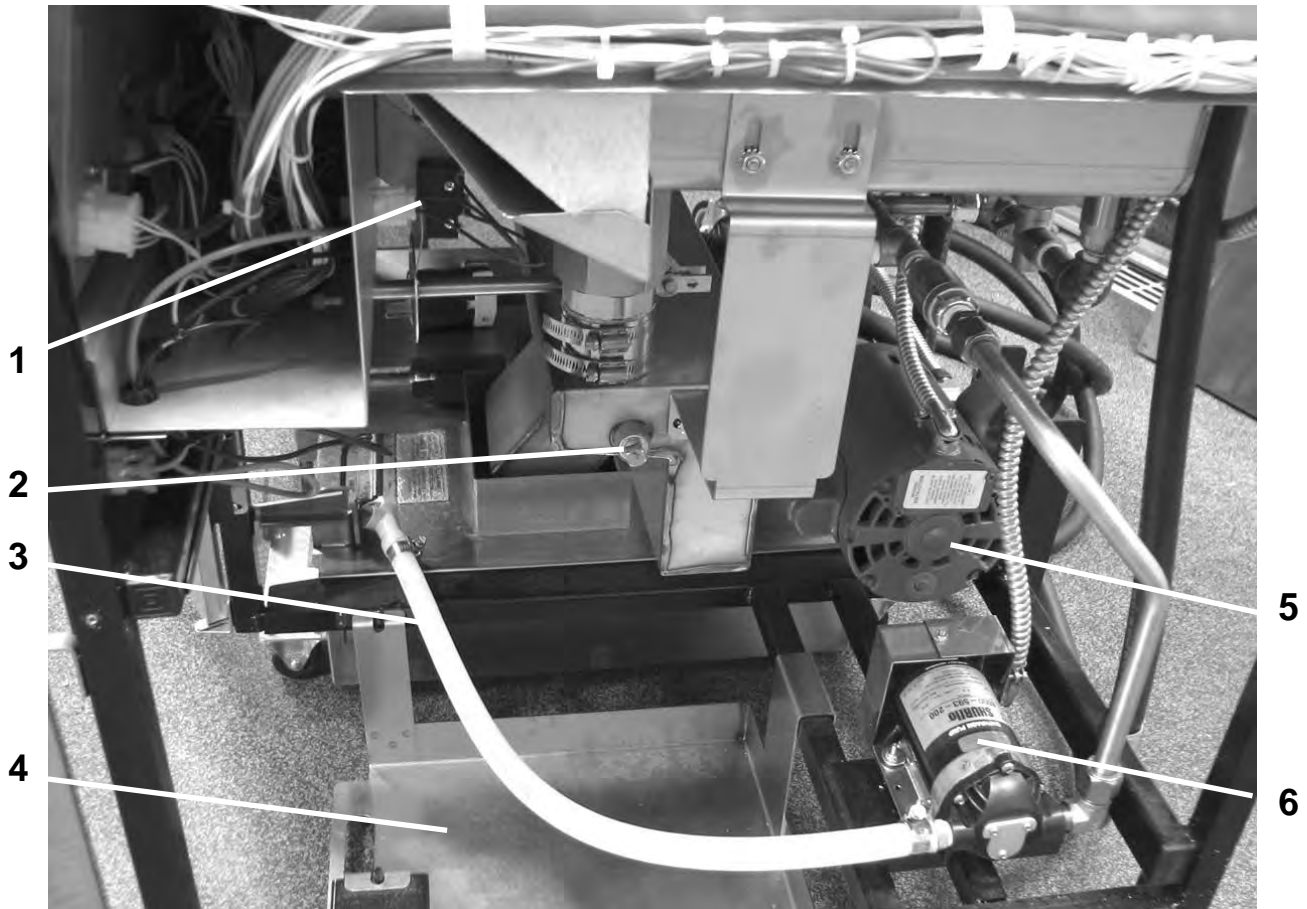

Recommend Parts: A=Truck Stock/B=Dist. Stock

Right Side Panel Removed

Item No.	Part No.	Description	Quantity
1	81027	ASSY - LEVER SWITCH & BRACKET	1/vat
A	50764	MICROSWITCH - RIGID LEVER.....	1/vat
	81017	HARNESS LEVER SWITCH	1/vat
	81495	BRACKET - LEVER SWITCH MOUNTING.....	1/vat
2	FP01-099	PLUG-PIPE 3/8 NPT SS	1
B 3	81513	ASSY - HOSE.....	1
4	85966	WELD ASSY - JIB SHELF	1
5	67589	PUMP & MOTOR ASSY.....	1
A	67583	MOTOR - 1/2 HORSE.....	1
B	17437	PUMP - FILTER - EEE.....	1
A	17476	SEAL KIT	1
B 6	74583	PUMP - OIL TOP OFF - 230V	1
B 7	80728	EMI FILTER - CE.....	1

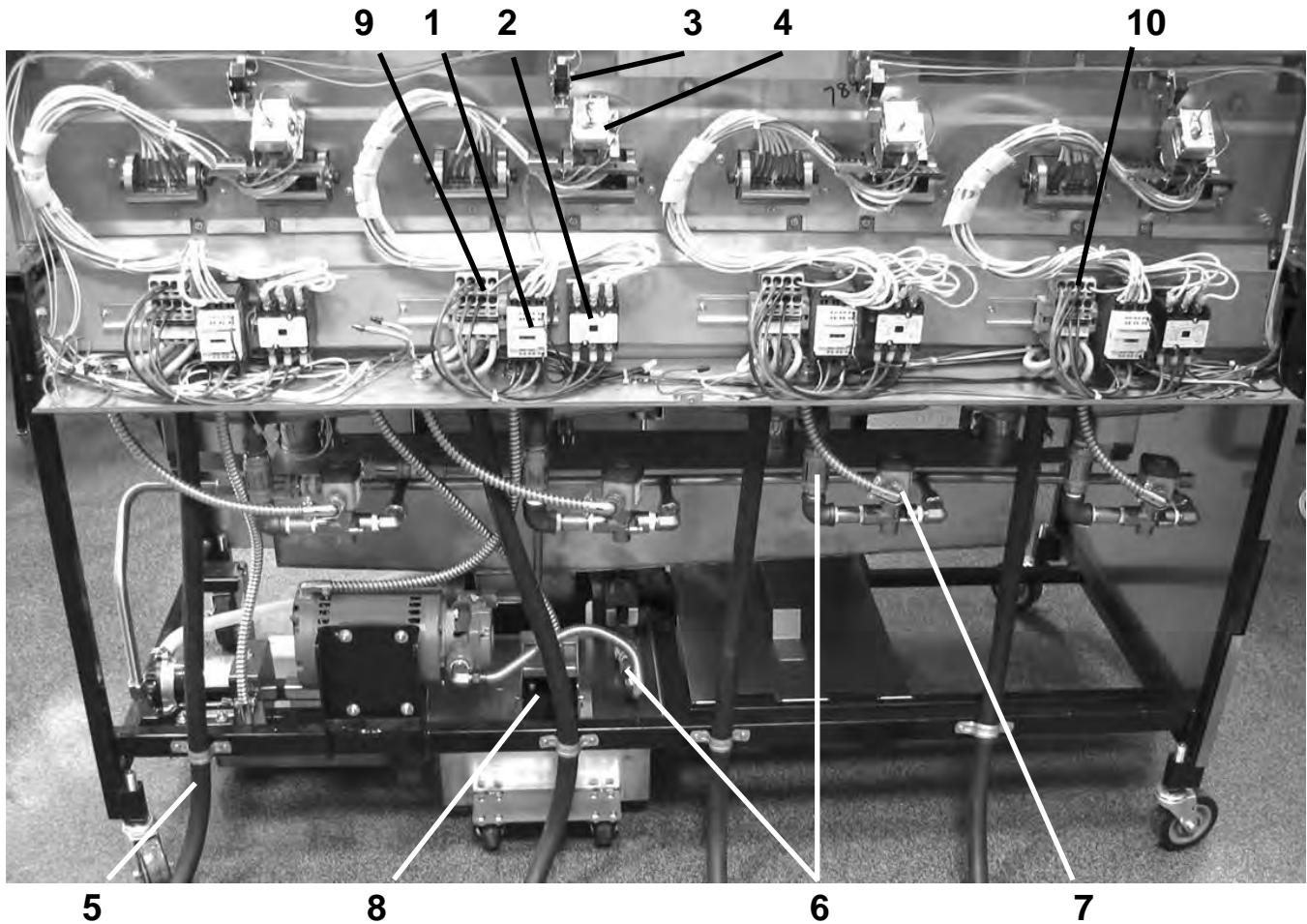

Rear View

Item No.	Part No.	Description	Quantity
A 1	78753	CONTACTOR - 24V COIL (Heat Contactor).....	1/vat
A 2	29509	CONTACTOR - 24V COIL (Primary Contactor)	1/vat
A 3	18227	SWITCH - ELEMENT LIFT	1/vat
A 4	140253	KIT - HIGH LIMIT - 425 F	1/vat
5	75381	ASSY - POWER CORD - 208-240V-60 AMP.....	1/vat
5	82087	ASSY - POWER CORD - 208-240V-50 AMP.....	1/vat
5	79364	ASSY - CE POWER CORD	1/vat
A 6	74469	VALVE - CHECK - 1/2" (Vat Fill).....	1/vat
A 7	74582	VALVE - SOLENOID 220-240V - 1/2N (Vat Fill Solenoids).....	1/vat
	140229	KIT- SOLENOID REPAIR.....	A/R
A 8	80148	ASSY-DRAIN SWITCH W/BOOT	1
B 9	78702	ASSY - TERMINAL BLOCK - DOM.....	1/vat
B 9	86835	ASSY-TERM. BLOCK-DOM-EEE-141 ONLY (inside junction box)...	1
B 9	65427	ASSY-TERM. BLOCK - CE - EEE-141 ONLY (inside junction box)...	1
B 9	78705	ASSY-TERMINAL BLOCK-INT'L (LEFT VAT ONLY-before July 2010)	1
B 9	78706	ASSY-TERMINAL BLOCK-INT'L (ALL BUT LEFT VAT)	1/vat
B 10	87033	ASSY-TERMINAL BLOCK-DOM (LEFT VAT ONLY-July 2010 & after)	1
B 10	87034	ASSY-TERMINAL BLOCK-INT'L(LEFT VAT ONLY-July 2010 & after)	1

Recommend Parts: A=Truck Stock/B=Dist. Stock *not shown

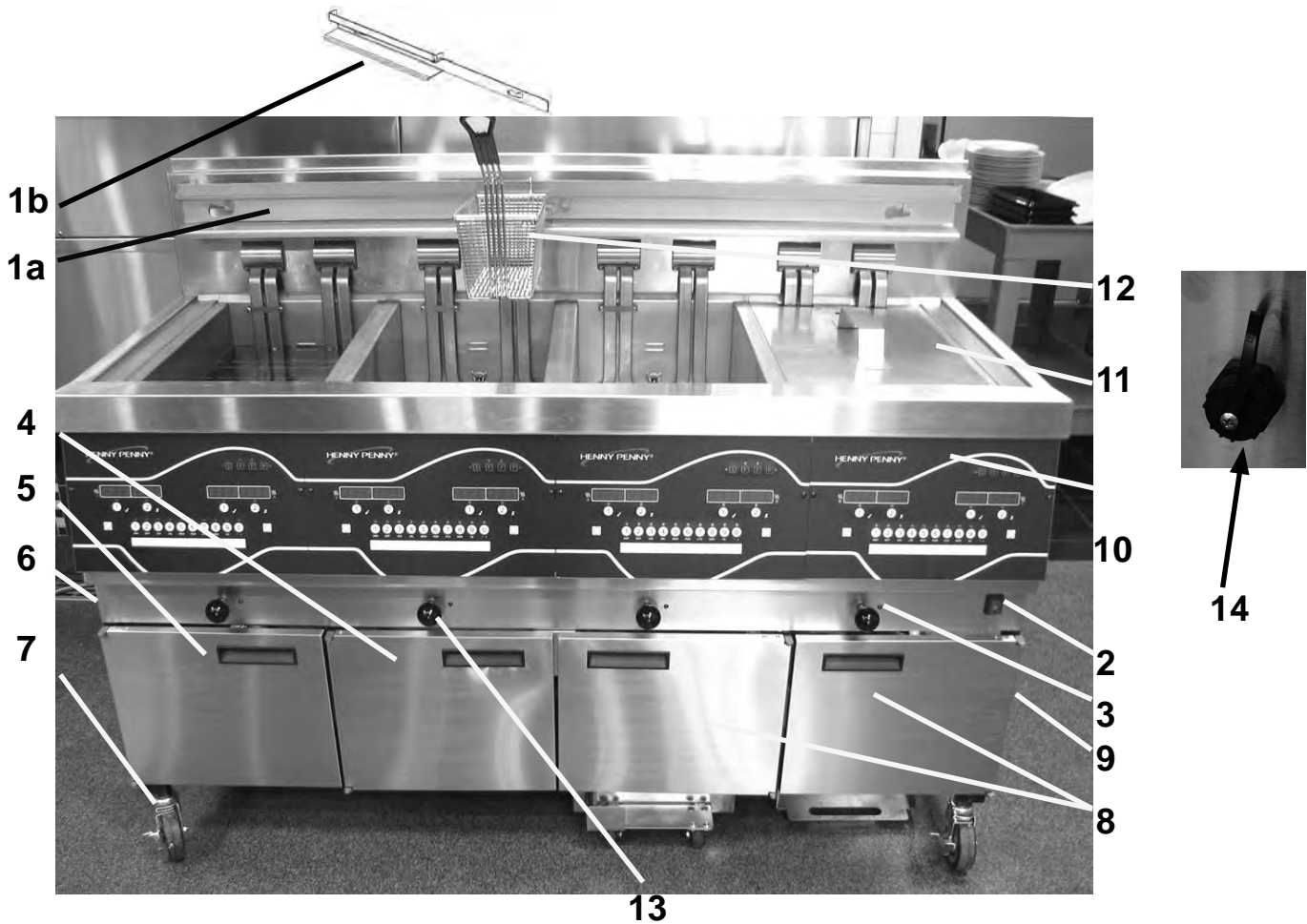

Front View

Item No.	Part No.	Description	Quantity
1a	85520	HANGER-BASKET - EEE-141	1
1a	77842	HANGER-BASKET - EEE-142.....	1
1a	77709	HANGER-BASKET - EEE-143.....	1
1a	77934	HANGER-BASKET - EEE-144.....	1
1b	91164	HANGER-BASKET - EEE-142 Auto-Lift.....	1
A 2	52224	SWITCH - POWER.....	1
B 3	81980	LED - 5 mm BLUE	1/vat
4	81185	ASSY-LH DOOR	1
5	81847	ASSY-LH DOOR - EEE-144 ONLY	1
		(See door breakdown on next page)	
6	74460	PANEL - LH SIDE	1
7	77575	CASTER - 4" - W/BRAKE.....	2
8	81190	ASSY - RH DOOR.....	1 or 2
		(See door breakdown on next page)	
9	74461	PANEL - RH SIDE	1
B 10	81943RB	ASSY - EEE14X CONTROL	+
B 10	84417RB	ASSY - EEE14X AUTO-LIFT CONTROL	+
B 10	140402	KIT-EEX CONTROL W/THUMB DRIVE (Smart Touch) .	+
11	03623	WELD ASSY - COVER - SPLIT VAT.....	1/vat
11	03624	WELD ASSY - COVER - FULL VAT.....	1/vat

..... Continued next page

+ EEE141=1; EEE142=2; EEE143=3; EEE144=4

Recommend Parts: A=Truck Stock/B=Dist. Stock

Front View (Continued)

Item No.	Part No.	Description	Quantity
12	81915	BASKET - 1/2 SIZE - COATED HANDLE.....	2/vat
12	83449	BASKET-1/2 SIZE-TIERED-FRONT/REAR HOOK	2/vat
12	86907	BASKET-1/2 DIVIDED-FRONT HOOK	2/vat
12	85136	BASKET-FULL SIZE-COATED HANDLE	1/vat
13	16101	KNOB - SPINDLE - BLACK.....	1/vat
14	152487	CABLE-USB PORT AND	1/vat
14	152488	CAP-USB.....	1/vat
15*	77679	CASTER - 4"	2
16*	140119	KIT-FDS210 TO EEE141 JOINING	1
16*	140051	KIT-FDS210 TO EEE142 JOINING	1
16*	140052	KIT-FDS210 TO EEE143/144 JOINING	1

*not shown

EEE-144 Door Break Down

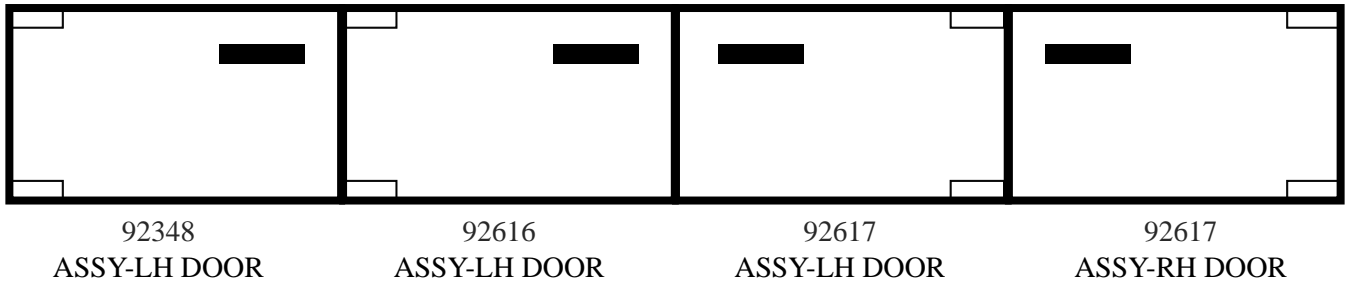

EEE-143 Door Break Down

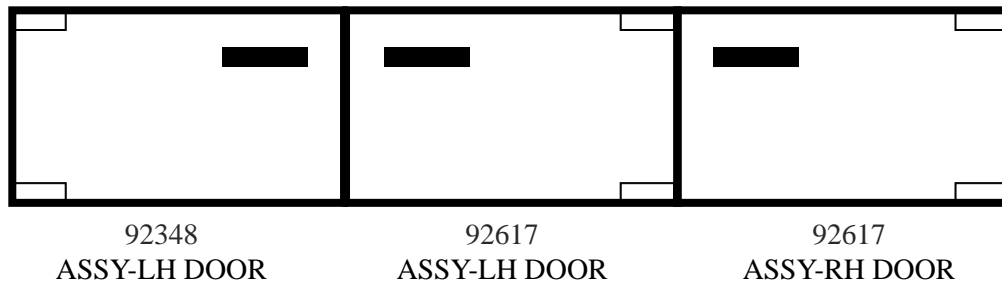

EEE-142 Door Break Down

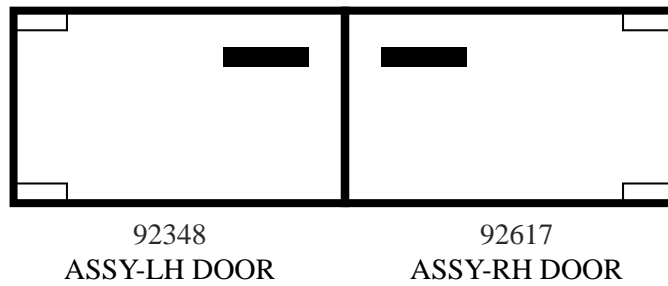

EEE-141 Door Break Down

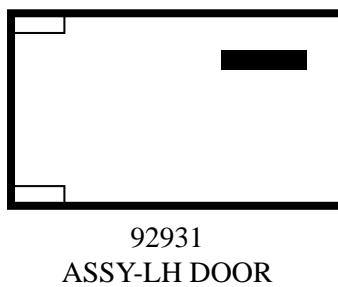

Door Hinge Chart					
Door	Top Hinge (Frame)	Top Hinge (Door)	Bottom Hinge (Door)	Bottom Hinge (Frame)	Bushing
92931	92080	92342	92340	92079	39752
92348	92080	92342	92340	92079	39752
92617	92620	92618	92619	92621	39752
92616	92080	92342	92340	92079	39752

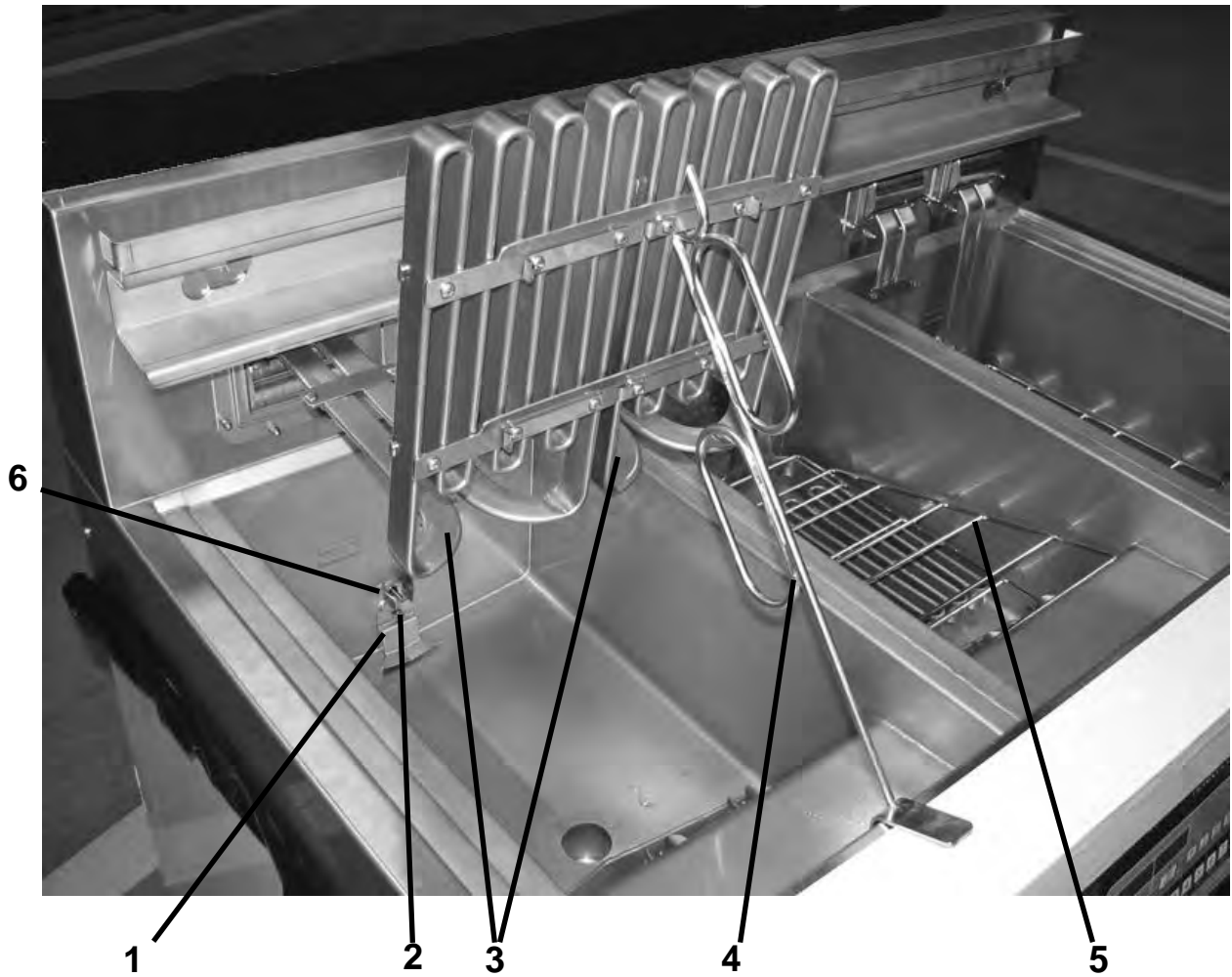

Top View

Item No.	Part No.	Description	Quantity
1	77838	WELD ASSY- LOW OIL DIVERTER	1/vat
2	NS03-044	NUT - ACORN - #10-24 - SS	1/vat
B 3	78484-001	ELEMENT-HEATING - 7 KW-208V	2/full; 1/split
B 3	78484-002	ELEMENT-HEATING - 7 KW-230V	2/full; 1/split
B 3	78484-003	ELEMENT-HEATING - 7 KW-480V	2/full; 1/split
B 3	78484-004	ELEMENT-HEATING - 7 KW-200V	2/full; 1/split
B 3	78484-005	ELEMENT-HEATING - 7 KW-220V	2/full; 1/split
B 3	78484-006	ELEMENT-HEATING - 7 KW-240V	2/full; 1/split
B 3	86731-001	ELEMENT-HEATING - 8.5 KW-208V	2/full; 1/split
B 3	86731-002	ELEMENT-HEATING - 8.5 KW-220V	2/full; 1/split
B 3	86731-003	ELEMENT-HEATING - 8.5 KW-230V	2/full; 1/split
B 3	86731-004	ELEMENT-HEATING - 8.5 KW-240V	2/full; 1/split
B 4	74725	HANDLE - ELEMENT LIFT	1
B 5	84362	RACK - SPLIT VAT	1/vat
B 5	74916	RACK - FULL VAT	1/vat
A 6	14984	PROBE - TEMPERATURE.....	1/vat

Recommend Parts: A=Truck Stock/B=Dist. Stock *not shown

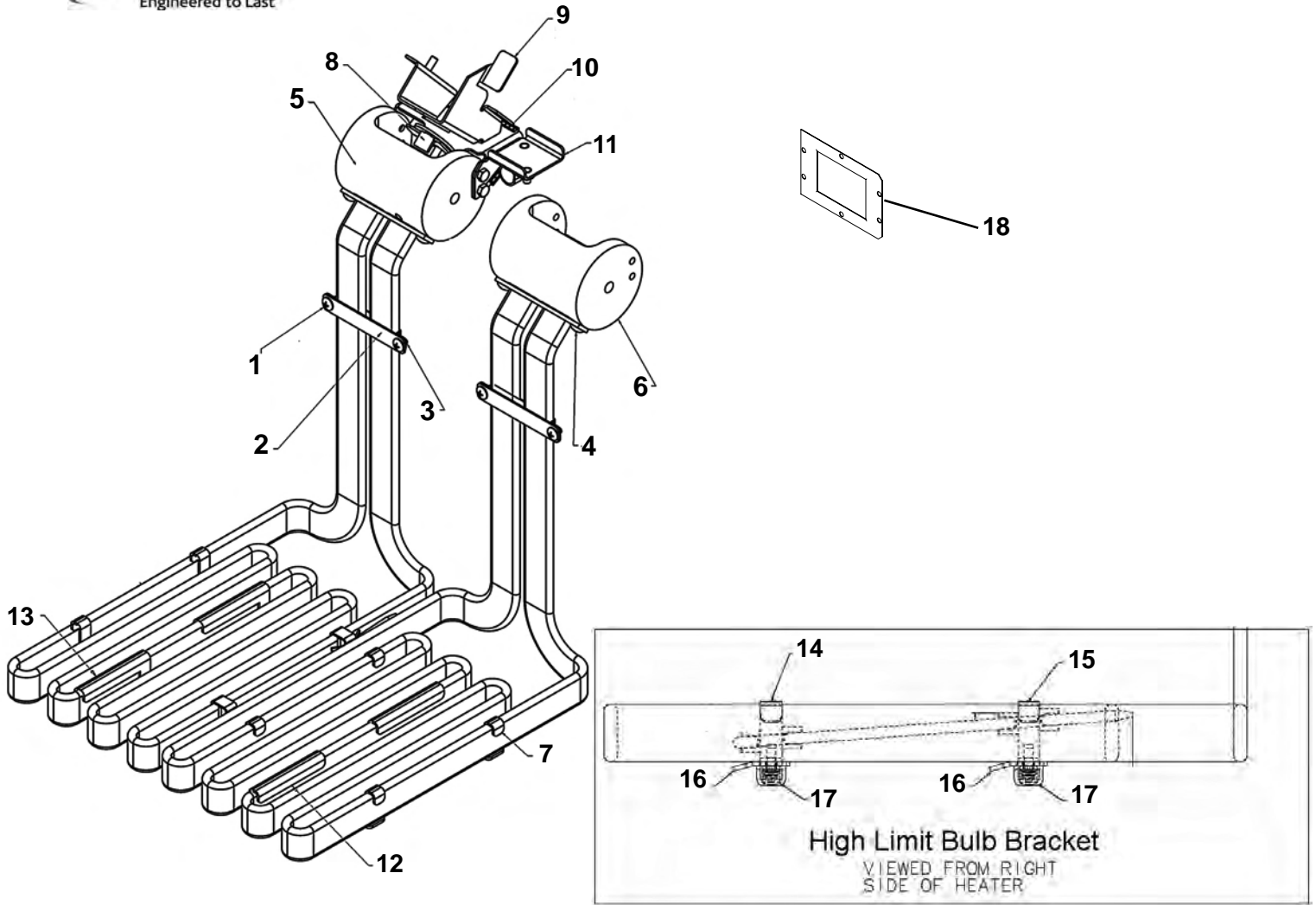

Item No.	Part No.	Description	Quantity
1	SC01-076	SCREW #8-32 X 1/4 PH THD S.....	2/vat
2	75819	PLATE - FRONT CAPILLARY.....	1/vat
3	75818	PLATE - REAR CAPILLARY.....	1/vat
4	SC01-074	SCREW #10-32 X 1/2 PH THD S.....	4/vat
5	74209	HOUSING - ELEMENT PIVOT.....	1/vat
6	82459	HOUSING - ELEMENT PIVOT - RH FULL.....	1/vat
7	78499	STRAP - SPREADER.....	6/vat
8	73713	WELD ASSY - HI LIMIT RESET PIN.....	1/vat
9	77147	WELD ASSY - PIVOT HI LIMIT BRACKET.....	1/vat
10	78780	BRACKET - HI LIMIT MOUNTING.....	1/vat
11	78896	STUD ASSY - GRND & WIRE MOUNTING.....	1/vat
12	85735	STRAP - SPREADER RH-EEE 14X-SN:BK0912003 & after.....	2/vat
13	85736	STRAP - SPREADER LH-EEE 14X-SN:BK0912003 & after.....	2/vat
14	78614	GUARD - FULL FRONT HI LIMIT.....	1/vat
15	78615	GUARD - FULL REAR HI LIMIT.....	1/vat
16	78494	WELD ASSY - SPREADER - FULL.....	2/vat
17	SC04-003	SCREW #8-32 X 3/8 PH PHD S.....	12/vat
B 18	76964	GASKET - PIVOT HUB.....	2/vat
A 19*	OR01-004	O-RING (Fits on element against items #5 & 6).....	2/element

Recommend Parts: A=Truck Stock/B=Dist. Stock

*not shown

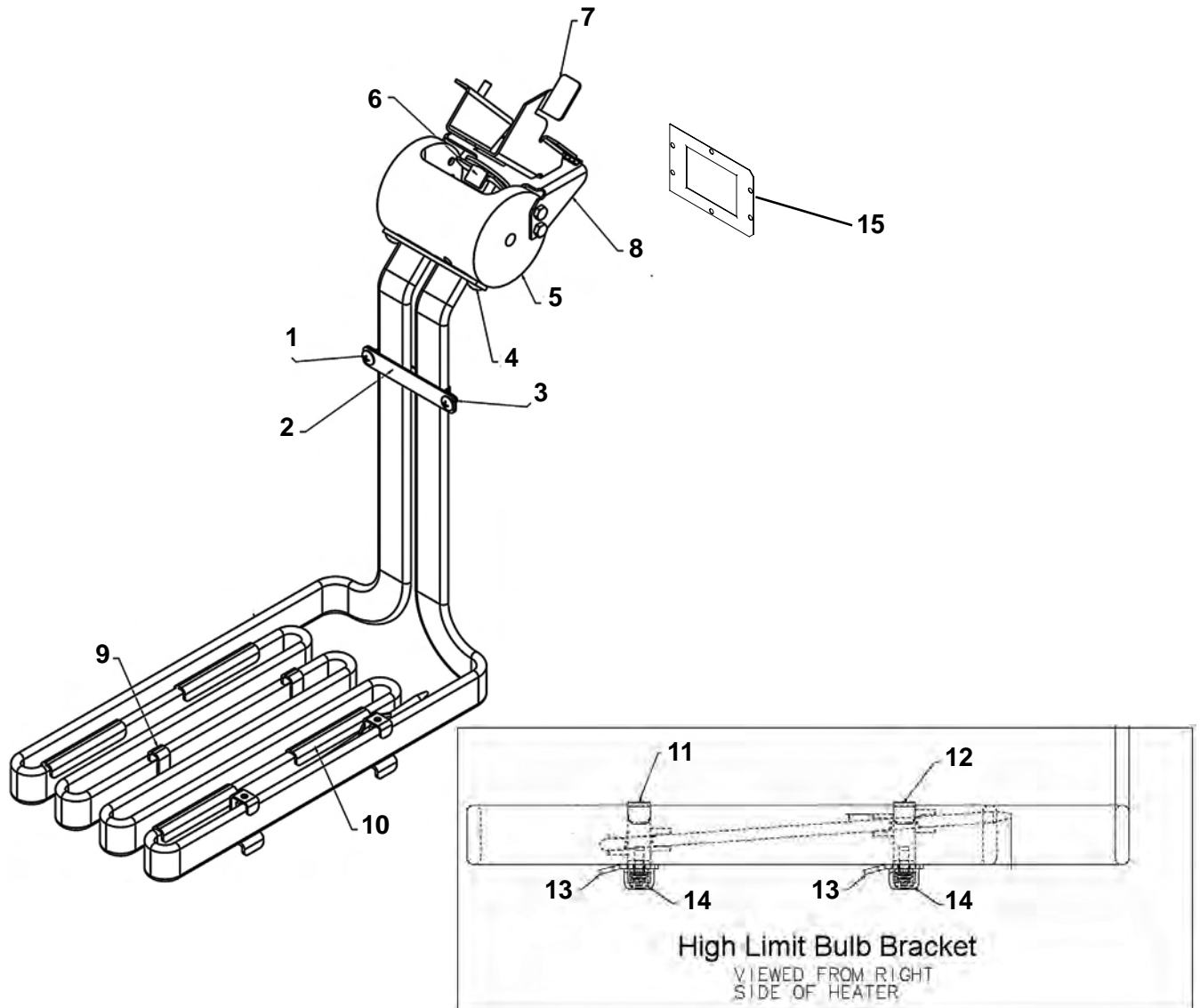

Item No.	Part No.	Description	Quantity
1	SC01-076	SCREW #8-32 X 1/4 PH THD S	2/vat
2	75819	PLATE - FRONT CAPILLARY	1/vat
3	75818	PLATE - REAR CAPILLARY	1/vat
4	SC01-074	SCREW #10-32 X 1/2 PH THD S	2/vat
5	74209	HOUSING - ELEMENT PIVOT	1/vat
6	73713	WELD ASSY - HI LIMIT RESET PIN	1/vat
7	77147	WELD ASSY - PIVOT HI LIMIT BRACKET	1/vat
8	78780	BRACKET - HI LIMIT MOUNTING.....	1/vat
9	78499	STRAP - SPREADER	4/vat
10	85735	STRAP - SPREADER RH-EEE 14X-SN:BK0912003 & after	4/vat
11	78601	GUARD - FULL FRONT HI LIMIT	1/vat
12	78602	GUARD - FULL REAR HI LIMIT	1/vat
13	78617	WELD ASSY - SPREADER - FULL	2/vat
14	SC04-003	SCREW #8-32 X 3/8 PH PHD S	6/vat
B 15	76964	GASKET - PIVOT HUB	1/vat
A 16*	OR01-004	O-RING (Fits on element against items #5 & 6)	2/element

Recommend Parts: A=Truck Stock/B=Dist. Stock / *not shown

Control Panel Assembly

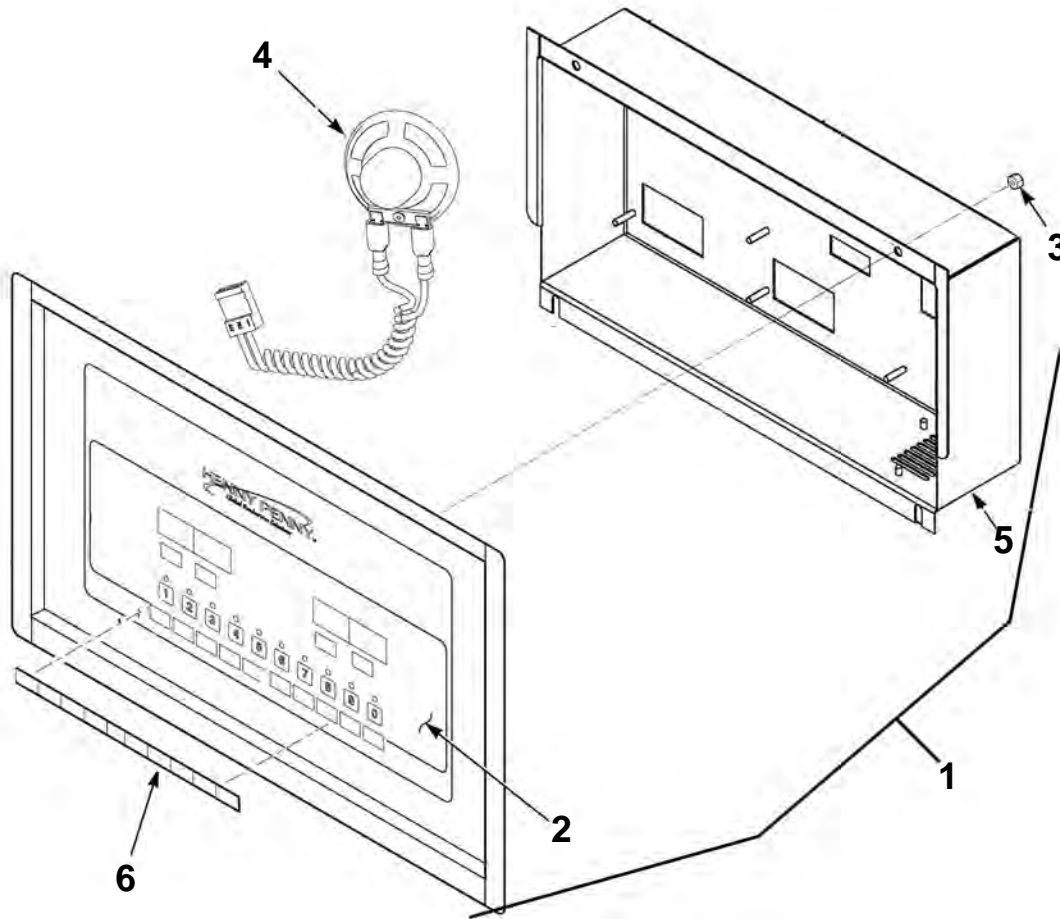

Control Assembly

Item No.	Part No.	Description	Quantity
B 1	81943RB	ASSY - EEE14X CONTROL	+
B 1	84417RB	ASSY - EEE14X AUTO-LIFT CONTROL.....	+
2	81354	DECAL - EVOLUTION ELITE® CONTROL	1/control
2	83206	DECAL - EE AUTO-LIFT CONTROL.....	1/control
3	NS02-005	NUT - HEX KEPS #6-32 C	23/control
B 4	26974	ASSY - SPEAKER	1/control
5	82085	STUD ASSY - CONTROL PANEL COVER	1/control
6	81613	MENU CARD - BLANK - EVOLUTION	1/control
A 7*	MS01-571	TOOL - TERMINAL EXTRACTOR	1
8*	84910	ASSY - MMC/SD EVENT LOGGER.....	1

Recommend Parts: A=Truck Stock/B=Dist. Stock

*not shown

+ EEE141=1; EEE142=2; EEE143=3; EEE144=4

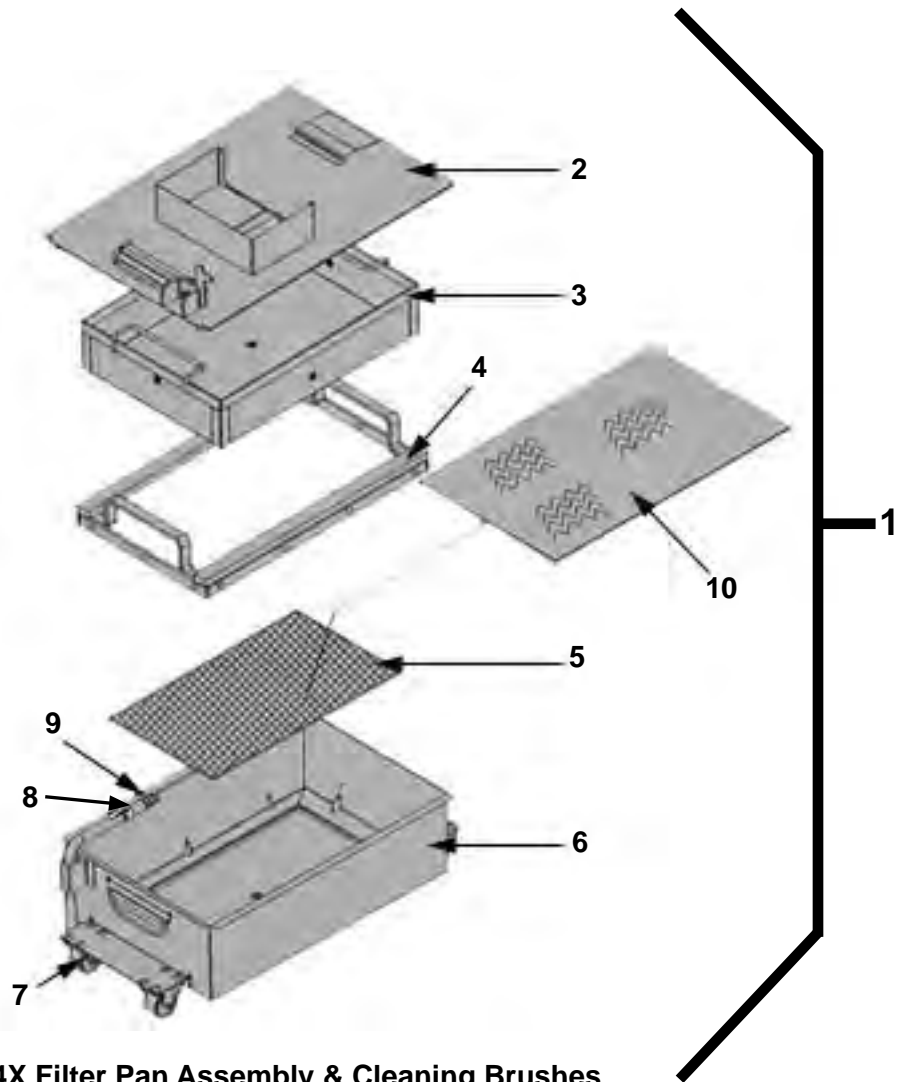

EEE-14X Filter Pan Assembly & Cleaning Brushes

Item No.	Part No.	Description	Quantity
1	77531	ASSY - DRAIN PAN.....	1
1	87609	ASSY - DRAIN PAN - EEE-141 Only	1
2	82673	ASSY-DRAIN PAN COVER.....	1
2	82674	ASSY-DRAIN PAN COVER - EEE-141 Only	1
3	76259	WELD ASSY-CRUMB CATCHER.....	1
4	76179	WELD ASSY-FILTER WEIGHT.....	1
5	76375	FILTER-SECTION.....	1
6	82672	WELD ASSY-DRAIN PAN.....	1
7	52487	CASTER - FILTER PAN.....	4
8	74573	ADAPTOR - PUMP TO PICKUP TUBE.....	1
A 9	74189	O-RING-PICKUP TUBE.....	3
B 10	12074	SMART FILTER PAD - 30 COUNT-.....	1
B 10	12076	SMART FILTER PAPER - 100 COUNT-.....	1
B 10	12078	FILTER EE PLEATED DUAL LAYER - 30 COUNT-.....	1
B 11	12126	BRUSH - BLACK L.....	1
B 12	12112	BRUSH - STRAIGHT WHITE.....	1
B 13	12116	BRUSH - FRYER - LONG HANDLE.....	1
14*	03671	240V - GM SEMI-SOLID OIL MELTER.....	1
14*	03675	120v - GM SEMI-SOLID OIL MELTER.....	1

Recommend Parts: A=Truck Stock/B=Dist. Stock *not shown

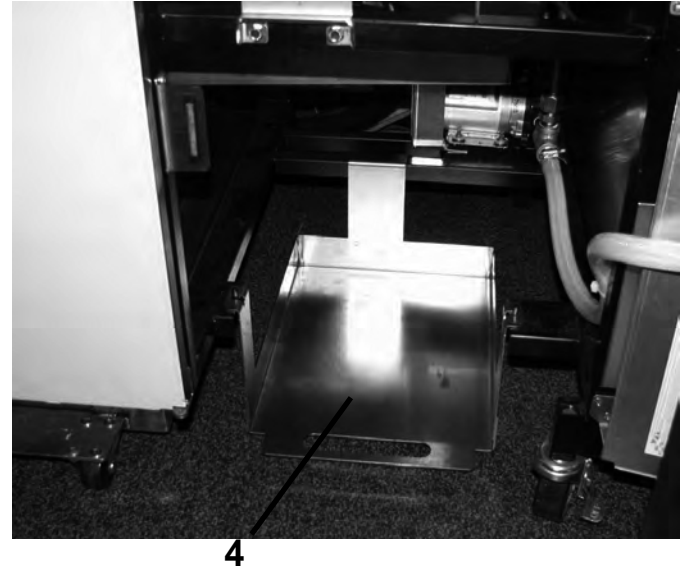
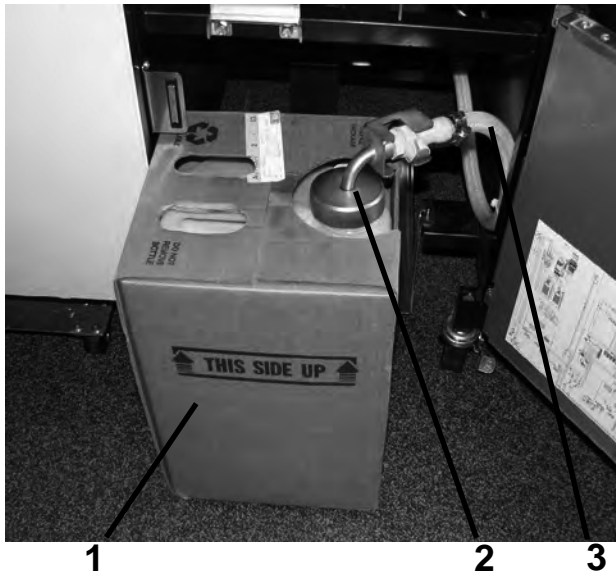

JIB System - EEE-142, 143, 144

Item No.	Part No.	Description	Quantity
1	03617	ACCESSORY-JUG-AUTO TOP OFF (EMPTY)	1
B 2	78992	ASSY-JIB TUBE & QUICK DISC	1
B 2	80490	ASSY-INT'L. JIB TUBE & QUICK DISC.....	1
B 3	81513	ASSY - HOSE	1
4	85966	WELD ASSY - JIB SHELF.....	1

Recommend Parts: A=Truck Stock/B=Dist. Stock

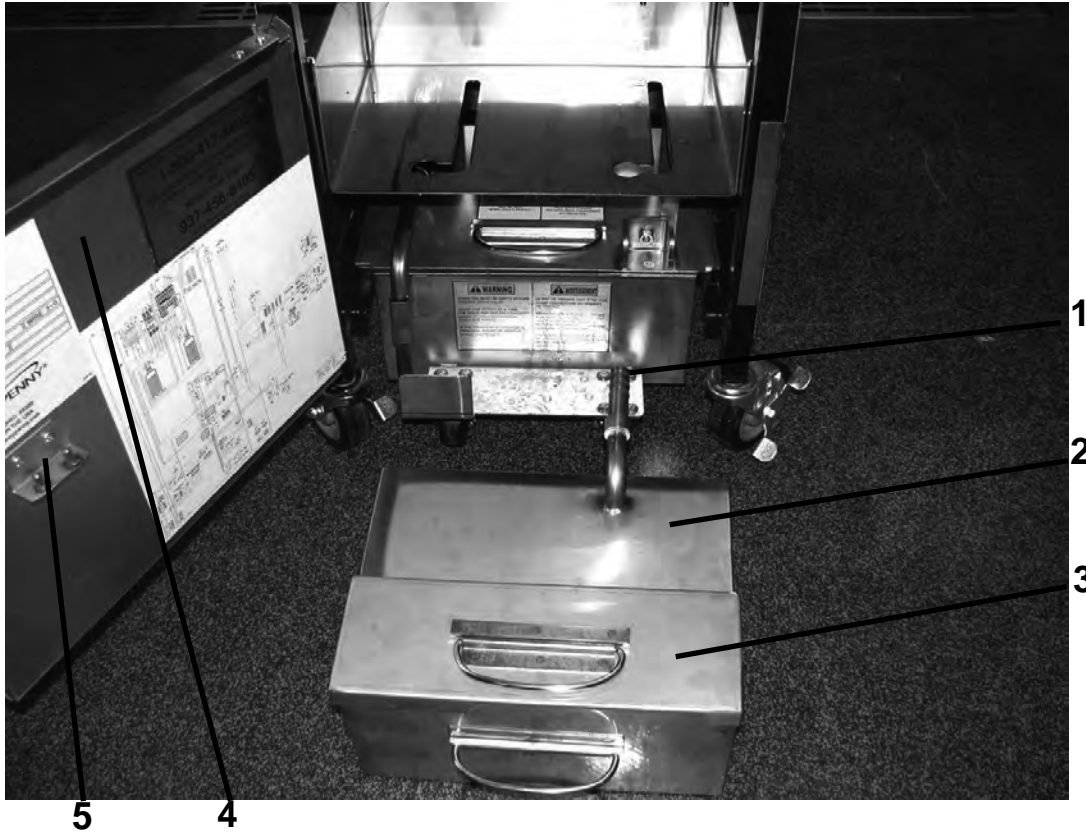

Oil Pan & Door Assembly - EEE-141

Item No.	Part No.	Description	Quantity
A 1	74189	O-RING-PICKUP TUBE.....	3
2	85969	OIL BOX WELD ASSY - FULL VAT	1
2	89736	OIL BOX WELD ASSY - SPLIT VAT	1
3	86065	OIL BOX COVER ASSY	1
4	85163	DOOR ASSY - EEX-141	1
5	86566	LID HANGER BRACKET STUD ASSY	1

Recommend Parts: A=Truck Stock/B=Dist. Stock

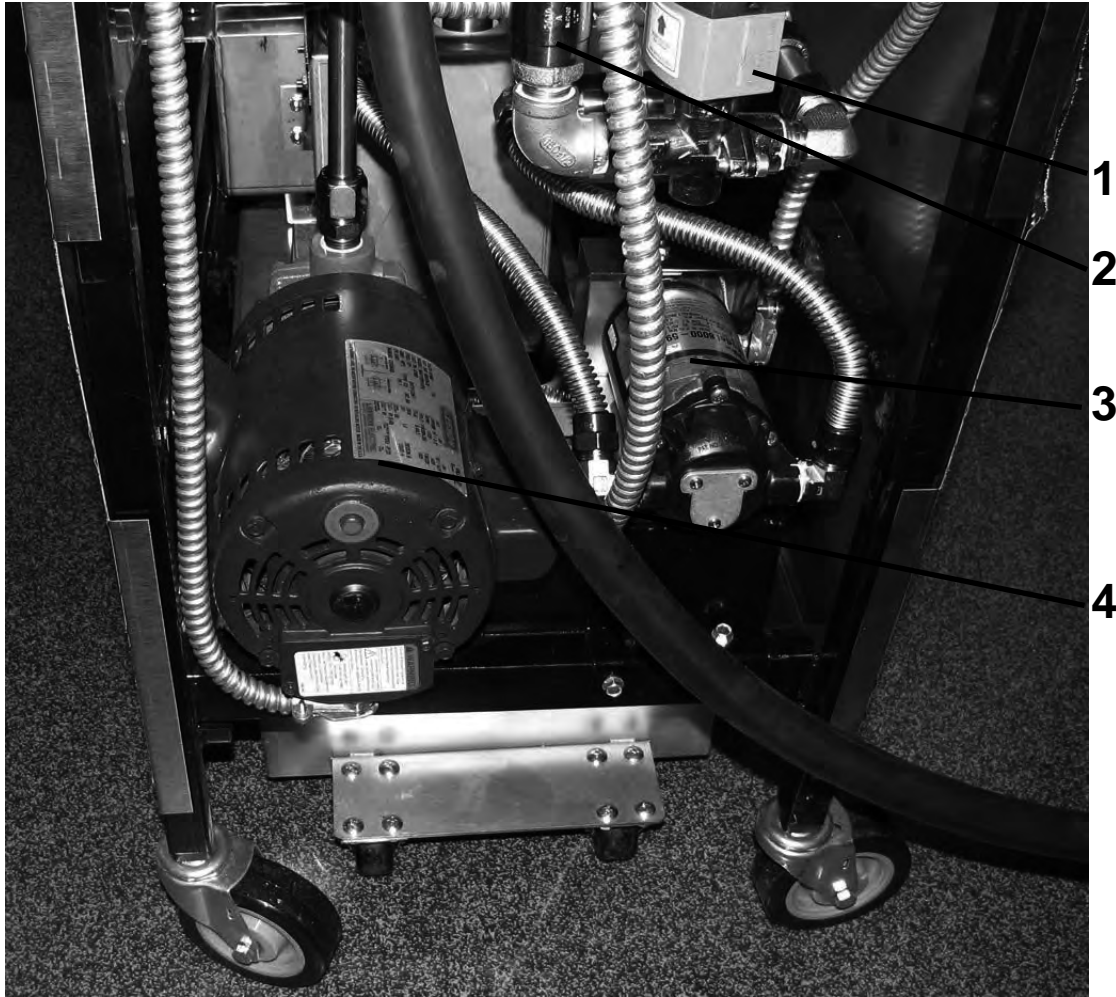

Oil Management Components - EEE-141

Item No.	Part No.	Description	Quantity
A 1	74582	VALVE - SOLENOID 220-240V - 1/2N (Vat Fill Solenoids) .	1
A 2	74469	VALVE - CHECK - 1/2" (Vat Fill)	1
B 3	74583	PUMP - OIL TOP OFF - 230V	1
4	85777	PUMP & MOTOR ASSY.....	1
A	67583	MOTOR - 1/2 HORSE.....	1
B	17437	PUMP - FILTER	1
A	17476	SEAL KIT	1

Recommend Parts: A=Truck Stock/B=Dist. Stock

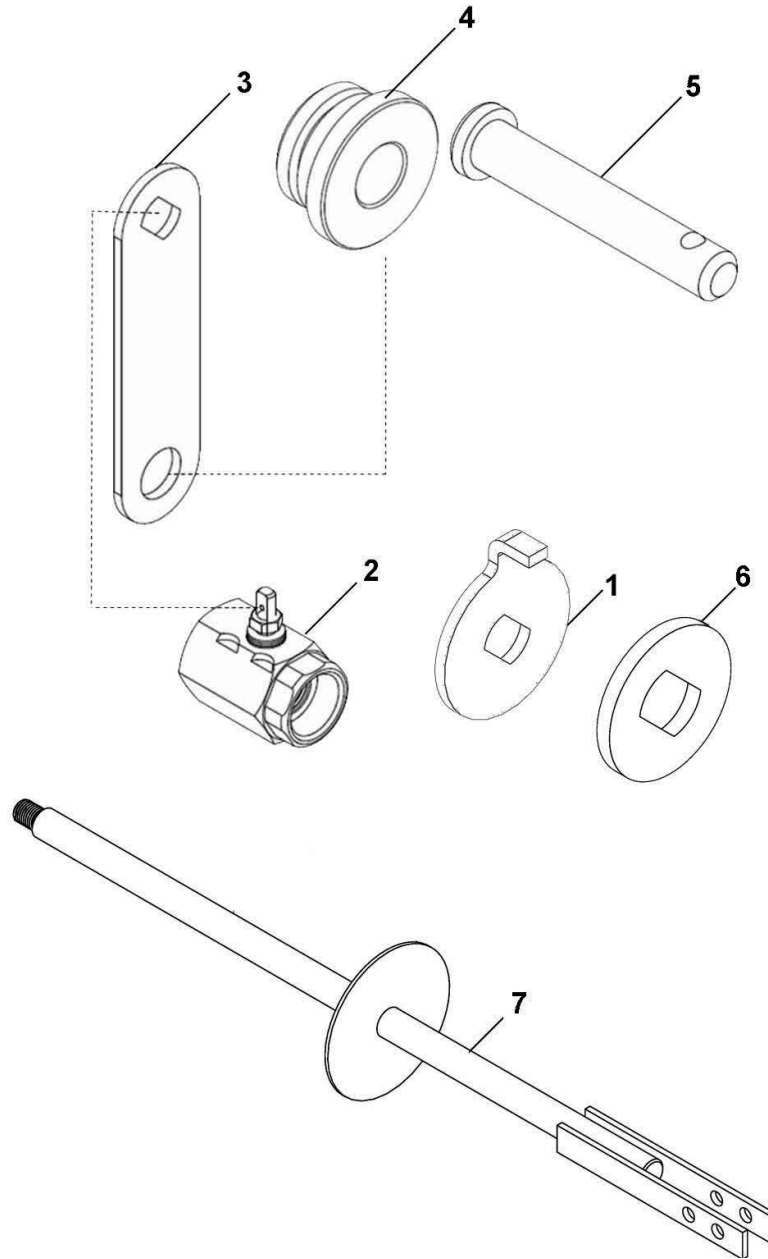

Drain Valve Linkage Parts

Item No.	Part No.	Description	Quantity
1	XXXXX	See Chart on next page	1/vat
B 2	79590	VALVE-DRAIN 1.250 PORT W/O HDL	1/vat
B 2	83732	VALVE-DRAIN 1-1/2 NPT X 1 NPT - EEE141 ONLY	1
B 2	81911	ASSY-ACTUATOR DRAIN W/O-RINGS (Smart Touch)	1/vat
A 3	73994	HANDLE - PIVOT - DRAIN	1/vat
4	74568	PIVOT - BUSHING - ACTUATOR	1/vat
B 5	PN01-012	PIN - CLEVIS - 1/4 x 1 IN SS	1/vat
6	74571	SPACER - PIVOT DRAIN HANDLE	1/vat
7	81183	ASSY - DRAIN EXTENSION ROD	1/vat
8*	PN01-001	PIN - COTTER	1/vat

Recommend Parts: A=Truck Stock/B=Dist. Stock / *not shown

Pivot Stop Drain Handle				
Models	Kit / Part Numbers			
		74626 17255 NS03-103	81753 17255 NS03-103	140175
<i>Full Vats:</i> EEE-141, 142, 143 & 144	SN: BK1201020 & After (Jan. 25, 2012)		Before SN: BK1201020	
<i>Split Vats:</i> EEE-141, 142, 143 & 144		SN: BK1202011 & After (Feb. 27, 2012)		Before SN: BK1202011

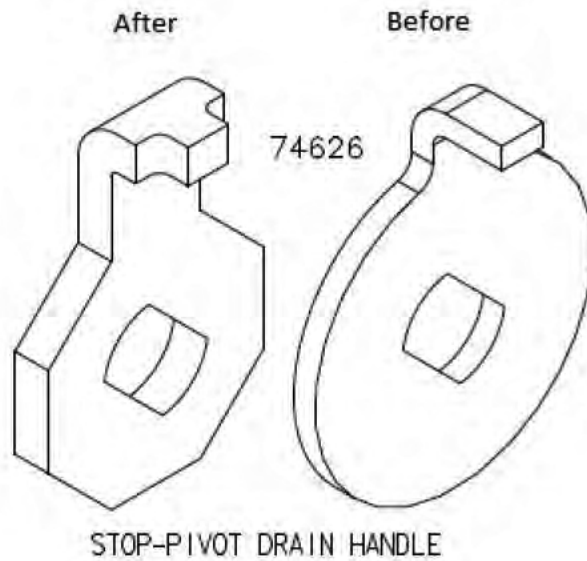

AUTO-LIFT PARTS

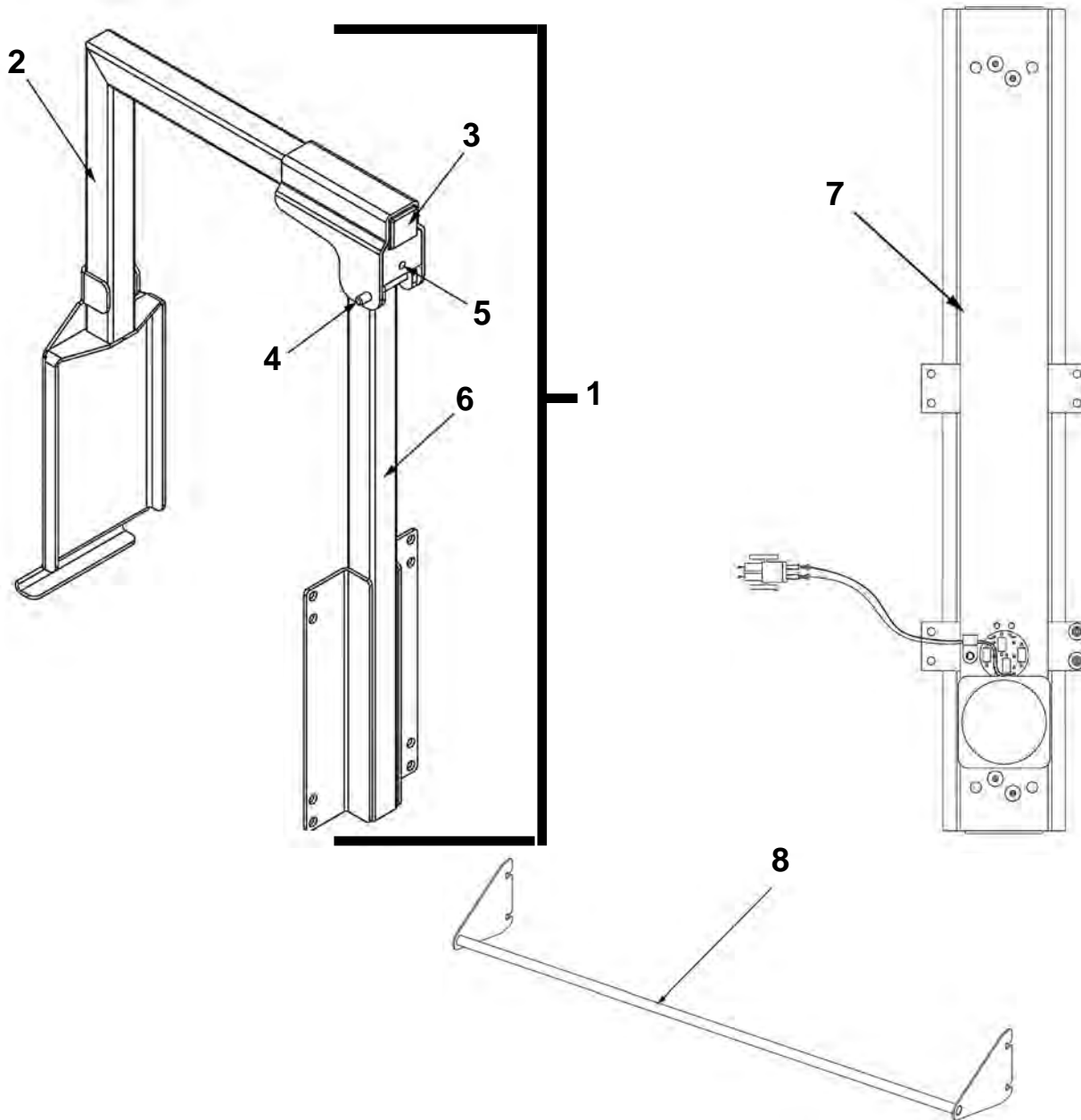

Item No.	Part No.	Description	Quantity/Vat
1	83982	ASSY - BREAKAWAY HINGE.....	2/full; 1/split
2	84279	WELD ASSY - HINGED BASKET HANGER	2/full; 1/split
3	15212	PLUG - TUBING SQUARE.....	2/full; 1/split
4	83925	PIN - 1/4 x 2.25 HINGE.....	2/full; 1/split
4*	MS01-578	SHIM	6/full; 3/split
5*	SC01-267	SCREW - 1/4-28 x 1 HEX HD SS	2/full; 1/split
5*	NS01-018	NUT	2/full; 1/split
6	83680	WELD ASSY - BREAKAWAY HINGE	2/full; 1/split
B 7	85022	ASSY - EE AUTOLIFT ACTUATOR & CONNECTOR.....	2/full; 1/split
8	84470	WELD ASSY - AUTOLIFT REAR GUARD - 2 WELL	1
8	84913	WELD ASSY - AUTOLIFT REAR GUARD - 3 WELL	1
8	84918	WELD ASSY - AUTOLIFT REAR GUARD - 4 WELL	1
9*	140273	EE-AUTOLIFT ACTUATOR MOTOR	A/R
9*	140274	EE-AUTOLIFT ACTUATOR SWITCH.....	A/R

Recommend Parts: A=Truck Stock/B=Dist. Stock / *not shown

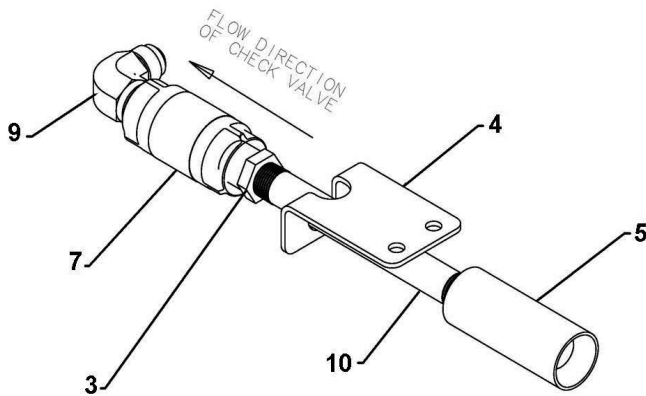

EEE-141

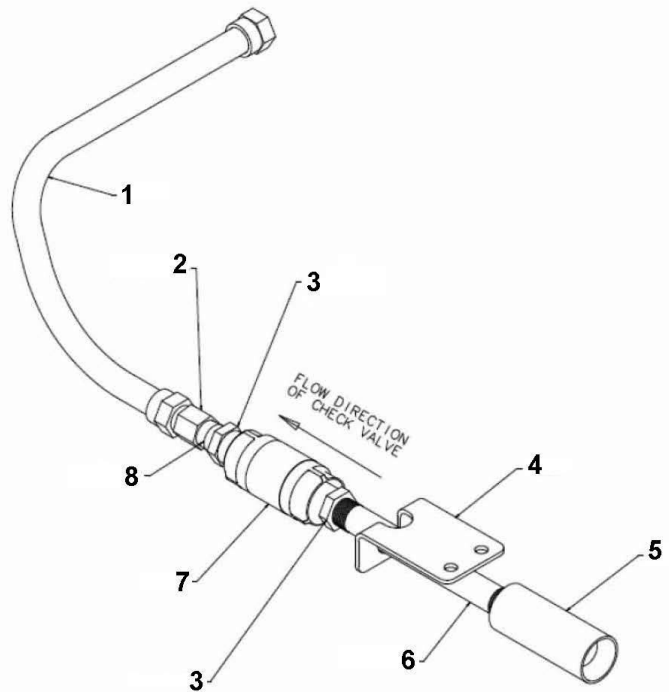

EEE-142, EEE-143. EEE-144

Filter Return Line Assembly

Item No.	Part No.	Description	Quantity
1	77523-002	TUBE-SUCTION 18 IN L DORMONT.....	1
2	FP01-206	CONNECTOR-3/8 NPT FEM 45 FLARE	1
3	FP01-029	REDUCER 1/2NPT M-3/8NPT F SS	2
4	77259	BRACKET-PLUG AND PLAY	1
5	77248	ADAPTER-TUBE END	1
6	FP01-204	NIPPLE-3/8 NPT X 6IN L BLACK.....	1
A 7	74469	VALVE-1/2 CHECK.....	1
8	FP02-024	NIPPLE-3/8 NPT CLOSE B.I.	1
9	FP01-205	ELBOW - 1/2 NPT	1
10	FP02-087	NIPPLE-3/8 NPT X 5 LG BI	1

Recommend Parts: A=Truck Stock/B=Dist. Stock

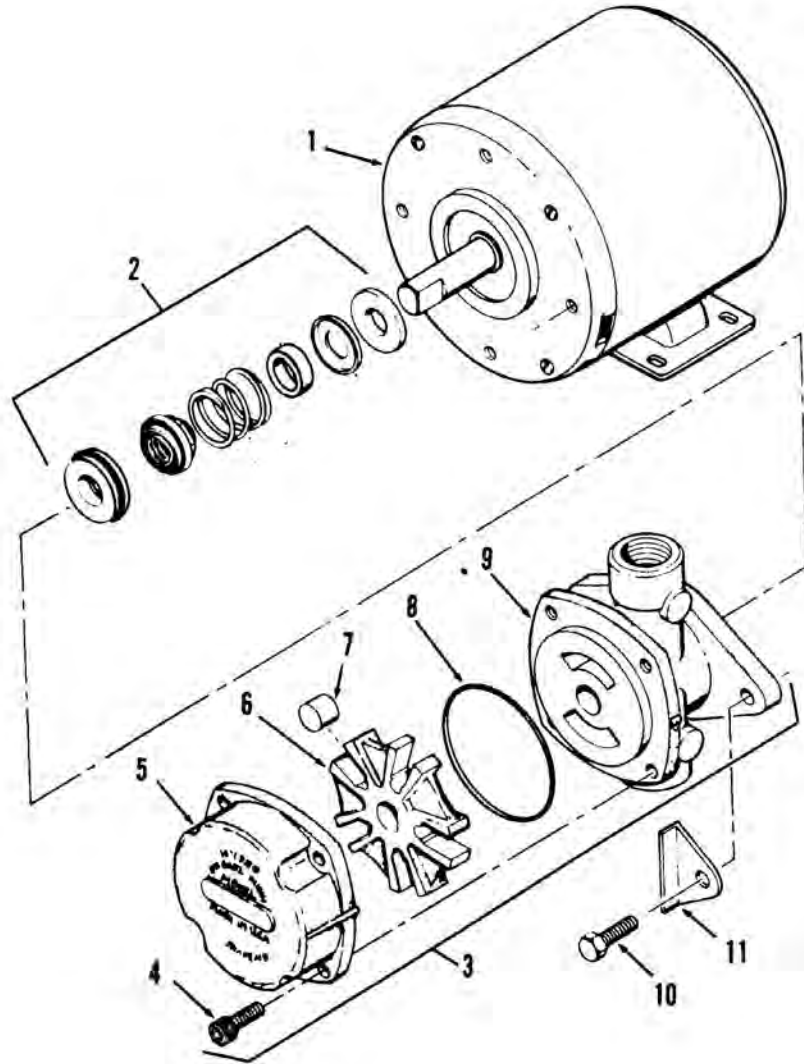

Filter Motor and Pump

Item No.	Part No.	Description	Quantity
A 1	67583	MOTOR, 1/2 HP - 50/60 Hz.....	1
A 2	17476	SEAL KIT	1
B 3	17437	PUMP ASSEMBLY	1
4	SC01-132	SCREW, Pump Cover	1
5	17451	COVER, Pump.....	1
B 6	17447	ROTOR, Pump.....	1
A 7	17446	ROLLER, Pump.....	5
A 8	17453	O-RING.....	1
9	17454	BODY, Pump	1
10	17456	SHIELD, Pump.....	2
11	SC01-026	SCREW, Pump Shield.....	1

Recommend Parts: A=Truck Stock/B=Dist. Stock

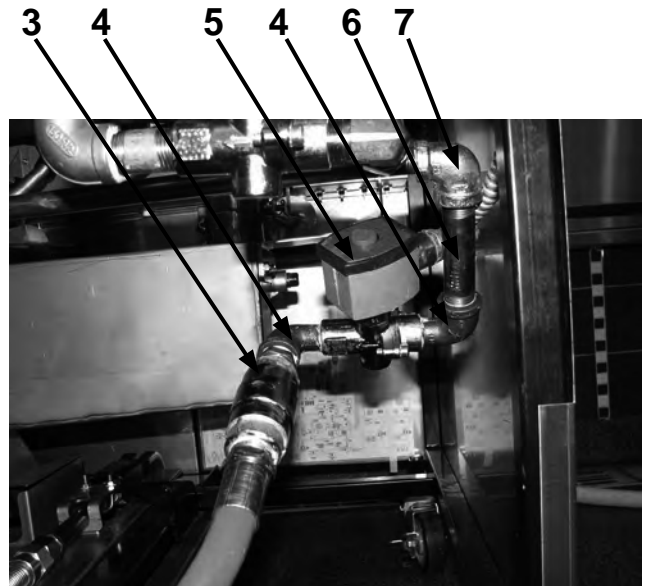
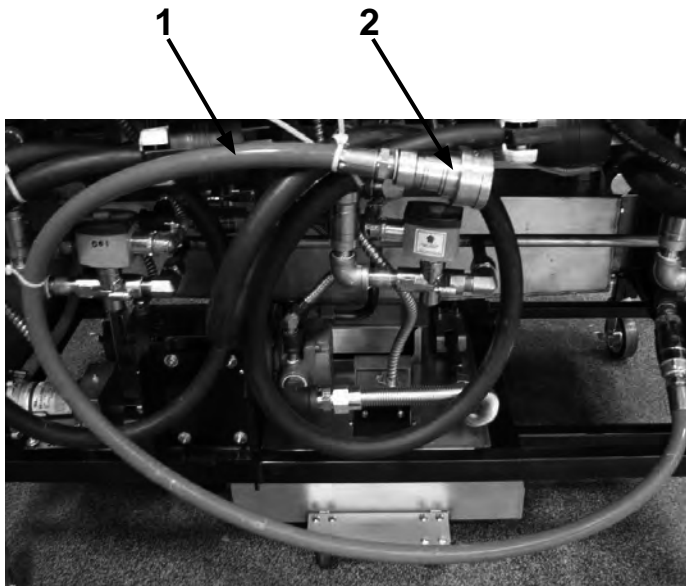

Bulk Dispose - EEE-142, 143, 144

Item No.	Part No.	Description	Quantity
*	140053	KIT - EEE BULK DISPOSE RETROFIT	1
B 1	67662	ASSY - DIRECT CONNECT HOSE	1
B 2	21612	DISCONNECT - FEMALE	1
B 3	21800	VALVE - 3/4 CHECK	1
4	FP01-088	ELBOW - STREET 1/2 X 90 BI	2
B 5	74582	VALVE - 220-240V - SOLENOID - 1/2 NPT	1
6	FP02-052	NIPPLE - 1/2 X 4 LG BI	1
7	FP01-001	ELBOW - REDUCING 1/2 TO 3/8	1
B 8*	21611	DISCONNECT - MALE	1

Recommend Parts: A=Truck Stock/B=Dist. Stock

* not shown

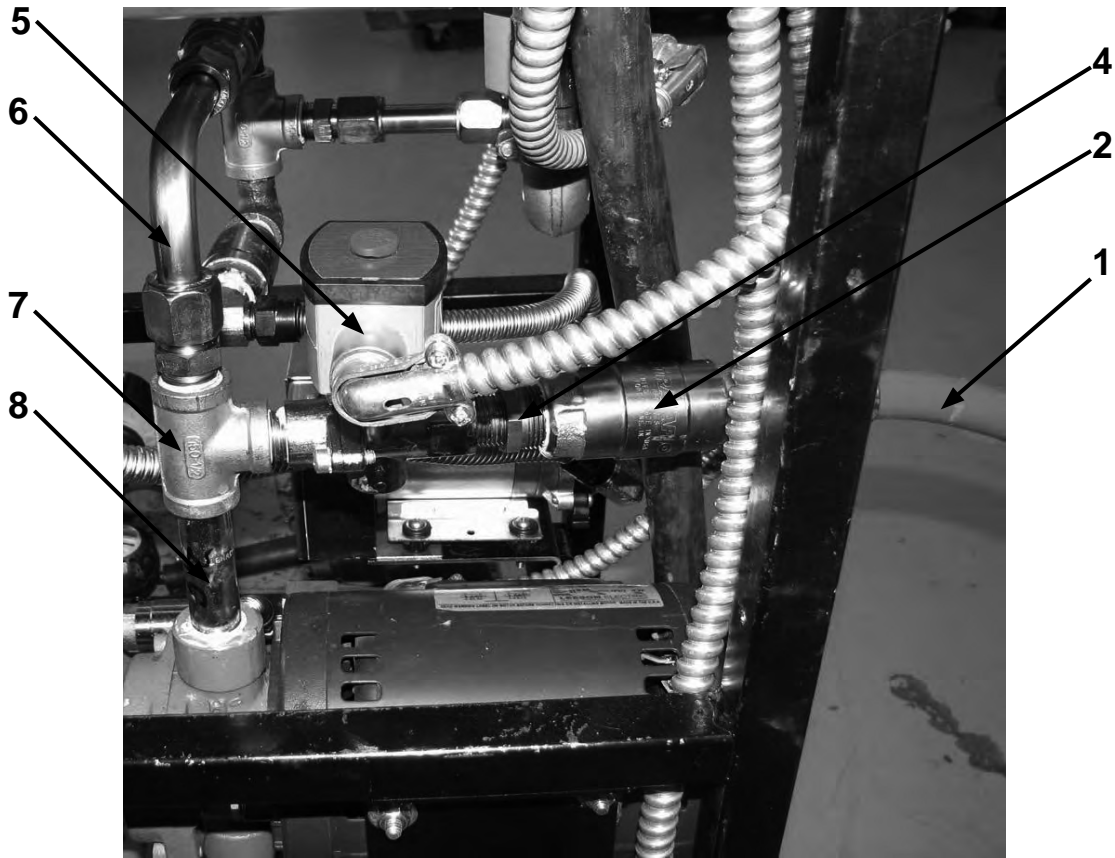

Bulk Dispose - EEE-141

Item No.	Part No.	Description	Quantity
*	140118	KIT - EEE-141 ONLY BULK DISPOSE	1
B 1	67662	ASSY - DIRECT CONNECT HOSE	1
B 2	21800	VALVE - 3/4 CHECK.....	1
B 3*	21612	DISCONNECT - FEMALE.....	1
4	FP01-028	NIPPLE - CLOSE 1/2 NPT SS 1 LG.....	2
B 5	74582	VALVE - 220-240V - SOLENOID - 1/2 NPT	1
6	88942	ASSY - JIB PUMP TO CHECK VALVE TUBE	1
7	FP01-011	1/2 NPT PIPE TEE 304 SS	1
B 8	18226	NIPPLE - 1/2 X 3-1/2 SS PIPE.....	1
B 9*	21611	DISCONNECT - MALE.....	1

Recommend Parts: A=Truck Stock/B=Dist. Stock

* not shown

Front Bulk Dispose - EEE-141 & 142 (Australia)

EEE-141 - FULL			EEE-142		
Part No.	Description	Qty	Part No.	Description	Qty
B 17333	RINSE HOSE DISCONNECT FEMALE	1	B 17333	RINSE HOSE DISCONNECT FEMALE	1
B 74582	VALVE-220-240V SOLENOID 1/2NPT	1	B 74582	VALVE-220-240V SOLENOID 1/2NPT	1
91353	ASSY-CHK VALVE MANF EEE-141 FD	1	77523-008	TUBE-SUCTION DORMONT-7 IN	1
16807	FITTING CONNECTOR MALE	1	91351	ASSY-2WELL FS RET OIL CHK V FD	1
B 74469	VALVE-1/2 CHECK	2	81878	WELD ASSY-FS 2WELL MANIFOLD	1
FP01-028	NIPPLE, CLOSE 1/2 NPT SS 1 LG	2	81879	ASSY-2WELL JIB OIL CHECK VALVE	1
FP01-088	ELBOW-STREET 1/2 X 90 BL IRON	2	17407	CONNECTOR 1/2 MALE ELBOW	1
FP01-197	CROSS-1/2 NPT BI	1	B 74469	VALVE-1/2 CHECK	1
FP01-205	ELBOW-1/2 IN NPT MALE 45 FLARE	1	81876	ASSY-JIB PUMP TO CHECK V TUBE	1
FP01-035	NIPPLE 1/2 NPT SS - 1 1/2 L	1	FP01-029	REDUCER 1/2NPT M-3/8NPT F SS	1
FP01-206	CONNECTOR-3/8 NPT FEM 45 FLARE	1	FP02-001	NIPPLE 3/8 CLOSE	1
FP01-238	FTG-3/8 NPT STR 45 DEG FLARE	1	91350	ASSY-2WELL RTN OIL CH VALVE FD	1
FP01-029	REDUCER 1/2NPT M-3/8NPT F SS	1	16807	FITTING CONNECTOR MALE	1
60344	FITTING-RETURN LINE MTG	1	B 74469	VALVE-1/2 CHECK	1
77523-011	TUBE-SUCTION DORMONT 10.000	1	91167	ASSY-142 RTN OIL TUBE FR DISP	1
FP02-001	NIPPLE 3/8 CLOSE	1	FP01-029	REDUCER 1/2NPT M-3/8NPT F SS	1
SC01-031	SCREW 1/4-20 X 3/4 PH THD	1	FP01-087	STREET ELBOW-3/8 NPT SS	1
			FP02-001	NIPPLE 3/8 CLOSE	1
			FP01-121	TEE-3/8NPT FEMALE SS	1
			FP01-206	CONNECTOR-3/8 NPT FEM 45 FLARE	1
			FP01-238	FTG-3/8 NPT STR 45 DEG FLARE	1
			60344	FITTING-RETURN LINE MTG	1
			SC01-031	SCREW 1/4-20 X 3/4 PH THD	2
			FP02-001	NIPPLE 3/8 CLOSE	1
			FP01-029	REDUCER 1/2NPT M-3/8NPT F SS	1
EEE-141 - SPLIT					
Part No.	Description	Qty			
16807	FITTING CONNECTOR MALE	1			
B 17333	RINSE HOSE DISCONNECT FEMALE	1			
74582	VALVE-220-240V SOLENOID 1/2NPT	1			
77523-008	TUBE-SUCTION DORMONT-7 IN	1			
91192	WELD ASSY-141 SPLIT MANF FD	1			
FP01-122	REDUCER 3/8 TO 1/2 B.I.	1			
FP01-206	CONNECTOR-3/8 NPT FEM 45 FLARE	1			
FP01-238	FTG-3/8 NPT STR 45 DEG FLARE	1			
FP02-042	NIPPLE-3/8 X 2 LG BI	1			
60344	FITTING-RETURN LINE MTG	1			
FP01-029	REDUCER 1/2NPT M-3/8NPT F SS	1			
FP02-001	NIPPLE 3/8 CLOSE	1			
SC01-031	SCREW 1/4-20 X 3/4 PH HD	2			

Recommend Parts: A=Truck Stock/B=Dist. Stock
* not shown

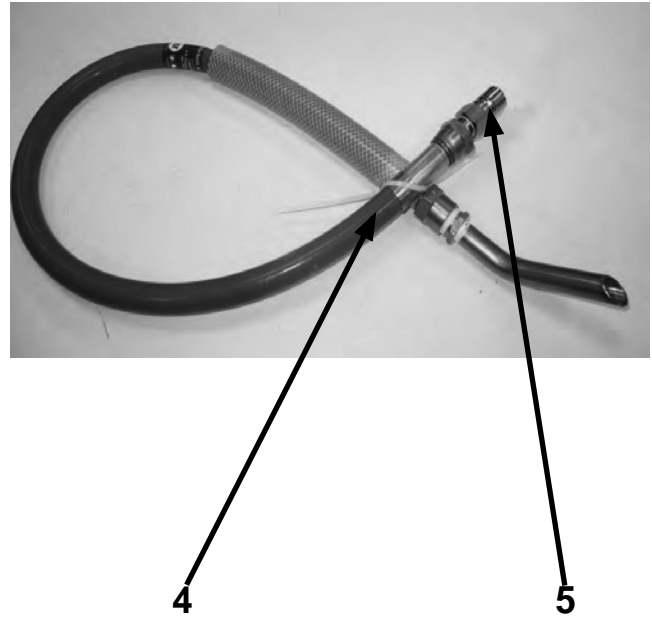

Front Bulk Dispose - EEE-141 (France)

Item No.	Part No.	Description	Quantity
B 1	17333	DISCONNECT - FEMALE.....	1
2	84790	LABEL.....	1
B 3	84987	SWITCH - MOMENTARY - SPLASH	1
4	140153	ASSY - HOSE DISPOSE	1
B 5	17334	DISCONNECT - MALE.....	1

Recommend Parts: A=Truck Stock/B=Dist. Stock