



OPERATOR'S M A N U A L

WENDY'S EVOLUTION ELITE™ (Gas)

REDUCED OIL CAPACITY OPEN FRYER

MODEL

EEG-253

EEG-254



HENNY PENNY
Engineered to Last

REGISTER WARRANTY ONLINE AT WWW.HENNYPENNY.COM

NOTICE

This manual should be retained in a convenient location for future reference.

A wiring diagram for this appliance is located on the inside of the door.

Post in a prominent location, instructions to be followed in event user smells gas. This information shall be obtained by consulting the local gas supplier.

Do not obstruct the flow of combustion and ventilation air. Adequate clearance must be left all around appliance for sufficient air to the combustion chamber.

The Model EEG-10X open fryer is equipped with a continuous pilot. But the open fryer cannot be operated without electric power, and no attempt should be made to operate the fryer during a power outage. The unit will automatically return to normal operation when power is restored.

CAUTION

To avoid a fire, keep appliance area free and clear from combustibles.



Improper installation, adjustment, alteration, service, or maintenance can cause property damage, injury, or death. Read the installation, operating, and maintenance instructions thoroughly before installing or servicing this equipment.



DO NOT STORE OR USE GASOLINE OR OTHER FLAMMABLE VAPORS AND LIQUIDS IN THE VICINITY OF THIS OR ANY OTHER APPLIANCE. FIRE OR EXPLOSION COULD RESULT.

Technical Data for CE/AGA Marked Products

Nominal Heat Input: (Net)	Natural (I_{2H}) = 19,8, kW (67,560 Btu/h) Natural (I_{2E}) = 19.8 kW (67,560 Btu/h) Natural (I_{2E+}) = 19.8 kW (67,560 Btu/h) Natural (I_{2L}) = 19.8 kW (67,560 Btu/h) Natural (I_{2HS}) = 19.8 kW (67,560 Btu/h) Liquid Propane (I_{3P}) = 19,8, kW (67,560 Btu/h)
Nominal Heat Input: (Gross)	Natural (I_{2H}) = 21,98 kW (75,000 Btu/h) (79.13 MJ/h) Natural (I_{2E}) = 21,98 kW (75,000 Btu/h) Natural (I_{2E+}) = 21,98 kW (75,000 Btu/h) Natural (I_{2L}) = 21,98 kW (75,000 Btu/h) Natural (I_{2HS}) = 21,98 kW (75,000 Btu/h) Liquid Propane (I_{3P}) = 21,98 kW (75,000 Btu/h) (79.13 MJ/h)
Supply Pressure:	Natural (I_{2H}) = 20 mbar (2.0 kPa) Natural (I_{2E}) = 20 mbar Natural (I_{2E+}) = 20/25 mbar Natural (I_{2L}) = 25 mbar Natural (I_{2HS}) = 25 mbar Liquid Propane (I_{3P}) = 30/37/50 mbar (3.0/3.7/5.0 kPa)
Test Point Pressure:	Natural (I_{2H}) = 8.7 mbar (.87 kPa) Natural (I_{2E}) = 8,7 mbar Natural (I_{2E+}) = N/A Natural (I_{2L}) = 8.7 mbar Natural (I_{2HS}) = 8.7 mbar Liquid Propane (I_{3P}) = 25 mbar (2.5 kPa)
Injector Size:	Natural (I_{2H}) = 2.08 mm Natural (I_{2E}) = 2.08 mm Natural (I_{2E+}) = 1.70 mm Natural (I_{2L}) = 2.30 mm Natural (I_{2HS}) = 2.30 mm Liquid Propane (I_{3P}) = 1.30 mm

This appliance must be installed in accordance with the manufacturer's instructions and the regulations in force and only used in a suitable ventilated location. Read the instructions fully before installing or using the appliance.

Noise generated from this equipment is less than 70 dB(A)

TABLE OF CONTENTS

INTRODUCTION	1
1-1 Safety	1
1-2 Introduction	3
1-3 Features.....	3
1-4 Proper Care.....	3
1-5 Assistance	3
INSTALLATION	4
2-1 Introduction	4
2-2 Unpacking.....	4
2-3 Selecting the Fryer Location.....	5
2-4 Leveling the Fryer	5
2-5 Ventilation of Fryer.....	5
2-6 Gas Supply.....	6
2-7 Gas Leak Test	9
2-8 Gas Pressure Regulator Setting	9
2-9 Electrical Requirements.....	9
2-10 Motor Bearings.....	10
2-11 Lighting and Shutdown of the Burners.....	10
2-12 Testing the Fryer	10
2-13 Dimensions	11
OPERATION	13
3-1 Operating Components	13
3-2 Set-Up Mode.....	17
3-3 Filling or Adding Oil	18
3-4 Morning Start-Up Procedures.....	19
3-5 Basic Operation	20
3-6 Idle Mode.....	20
3-7 Oil Guardian™ (Auto Top-Off).....	21
3-8 Selecting a Product with a Different Setpoint	21
3-9 Replacing the BIB	21
3-10A Filter - Manual.....	22
3-10B Filter - Smart Touch.....	24
3-11A Manual - Daily Filtering.....	26
3-11B Smart Touch - Daily Filtering.....	28
3-12 Discarding Oil from Vat Using Optional Discard Shuttle	30
3-13 Discarding Oil from Vat Using Optional Bulk Oil Dispose System	31
3-14 Discarding Oil Using Optional Oil Discard Shuttle - ODS-400	32
3-15 Discarding Oil Using Optional Oil Discard Shuttle - ODS-450	35
3-16 Changing the Filter Pad	38
3-17 Removing and Cleaning Basket Rest	41
3-18A Clean-Out Mode - Manual.....	41
3-18B Clean-Out Mode - Smart Touch	44
3-19 Check/Replace Filter Drain Pan O-Rings.....	48
3-20 Info Button Stats.....	45
3-21 Filter Button Stats.....	45
3-22 Preventive Maintenance Schedule.....	49
3-23 Clean Blower & Vents	50

INFORMATION MODE	51
4-1 Information Mode Details	51
PRODUCT PROGRAM MODE	56
5-1 Modifying Product Settings.....	56
LEVEL 2 PROGRAMMING.....	59
6-1 Special Program Mode	59
6-2 Do Not Disturb	67
6-3 Clock Set.....	68
6-4 Data Logging, Heat Control, Tech, Stat, and Filter Control Mode	68
TROUBLESHOOTING.....	69
7-1 Troubleshooting Guide	69
7-2 Error Codes.....	71

SECTION 1: INTRODUCTION

1-1 SAFETY

The instructions in this manual have been prepared to aid you in learning the proper procedures for your equipment. Where information is of particular importance or is safety related, the words NOTICE, CAUTION, or WARNING are used. Their usage is described below.

If a problem occurs during the first operation of a new unit, recheck the Installation Section of the Operator's Manual.

Before troubleshooting, always recheck the Operation Section of the Operator's Manual.

Where information is of particular importance or is safety related, the words DANGER, WARNING, CAUTION, or NOTICE are used. Their usage is described as follows:



SAFETY ALERT SYMBOL is used with DANGER, WARNING or CAUTION which indicates a personal injury type hazard.

NOTICE

NOTICE is used to highlight especially important information.

CAUTION

CAUTION used without the safety alert symbol indicates a potentially hazardous situation which, if not avoided, may result in property damage.

 **CAUTION**

CAUTION used with the safety alert symbol indicates a potentially hazardous situation which, if not avoided, could result in minor or moderate injury.

 **WARNING**

WARNING indicates a potentially hazardous situation which, if not avoided, could result in death or serious injury.

 **DANGER**

DANGER INDICATES AN IMMINENTLY HAZARDOUS SITUATION WHICH, IF NOT AVOIDED, WILL RESULT IN DEATH OR SERIOUS INJURY.

**1-1.
SAFETY
(CONT.)**



Equipotential Ground Symbol



Waste Electrical and Electronic Equipment (WEEE) Symbol

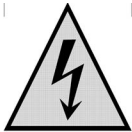

OR



Shock Hazard Symbols



OR



Hot Surface Symbols

**1-2.
INTRODUCTION**



**1-3.
FEATURES**

**1-4.
PROPER CARE**

**1-5.
ASSISTANCE**

The Henny Penny open fryer is a basic unit of food processing equipment designed to cook foods better and easier. The micro computer-based design helps make this possible. This unit is used only in institutional and commercial food service operations, and operated by qualified personnel.

- As of August 16, 2005, the Waste Electrical and Electronic Equipment directive went into effect for the European Union. Our products have been evaluated to the WEEE directive. We have also reviewed our products to determine if they comply with the Restriction of Hazardous Substances directive (RoHS) and have redesigned our products as needed in order to comply. To continue compliance with these directives, this unit must not be disposed as unsorted municipal waste. For proper disposal, please contact your nearest Henny Penny distributor.

- Easily cleaned
- Uses 40% less oil
- Full vat or split vat
- Computer control
- Stainless steel construction
- Automatic oil top off
- Self-diagnostic system built into controls
- Built in filter with automatic filtration
- Propane or natural gas; 75,000 BTU/vat (21.97 kw)

As in any unit of food service equipment, the Henny Penny open fryer does require care and maintenance. Requirements for the maintenance and cleaning are contained in this manual and must become a regular part of the operation of the unit at all times.

NOTICE

Contact a qualified service technician in case of major maintenance or repairs to the unit.

Should you require outside assistance, call your local independent distributor in your area, or call Henny Penny Corp. at 1-800-417-8405 or 1-937-456-8405.

SECTION 2: INSTALLATION

2-1. INTRODUCTION

This section provides the installation and unpacking instructions for the Henny Penny Evolution Elite® fryer.

NOTICE

Installation of this unit should be performed only by a qualified service technician.



Do not puncture the fryer with any objects such as drills or screws as component damage or electrical shock could result.

NOTICE

Any shipping damage should be noted in the presence of the delivery agent and signed prior to his or her departure.

2-2. UNPACKING

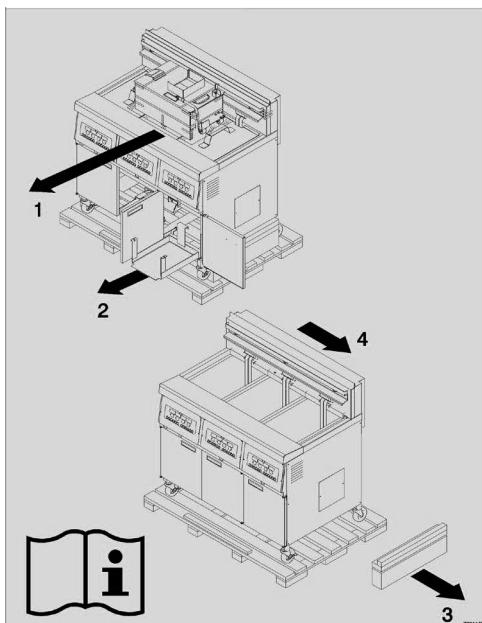

1. Cut and remove the metal bands from the carton.
2. Remove carton lid and lift the main carton off the fryer.
3. Remove corner packing supports (4).
4. Cut the stretch film from around the carrier/rack box and remove it from the top of the fryer lid.
5. Cut and remove the metal bands holding the fryer to the pallet, and remove fryer from pallet.

CAUTION

Remove filter drain pan and BIB shelf from fryer before removing fryer from pallet or damage to the unit could result. Figure 1.



Take care when moving the fryer to prevent personal injury. The fryer weighs approximately 600 lbs. (272 kg) to 800 lbs. (363 kg).

**2-3.
SELECTING THE
FRYER LOCATION**

The proper location of the fryer is very important for operation, speed, and convenience. The location of the open fryer should allow clearances for servicing and proper operation. Choose a location which will provide easy loading and unloading without interfering with the final assembly of food orders. Operators have found that frying from raw to finish, and holding the product in warmers provides fast continuous service. Keep in mind, the best efficiency will be obtained by a straight line operation, i.e. raw in one side and finished out the other side. Order assembly can be moved away with only a slight loss of efficiency.

**CAUTION
FIRE HAZARD**

To avoid fire, install the open fryer with minimum clearance from all combustible materials, 2 inches (5.08 cm) from the side and 4 inches (10.16 cm) from the back. Minimum clearance from all non-combustible materials, 0 inches (0.00 cm) from the side and 0 inches (0.00 cm) from the back. If installed properly, the open fryer is designed for operation on non-combustible floors only

Do not spray aerosols in the vicinity of this appliance while it is in operation.

**WARNING
BURN RISK**

To prevent severe burns from splashing hot oil, position and install fryer to prevent tipping or movement. Restraining ties may be used for stabilization.

**2-4.
LEVELING THE
FRYER**

For proper operation, the open fryer should be level from side-to-side and front to back. Using a level placed on the flat areas around the vat collar, on the middle well, and then adjust the casters until the unit is level.

**2-5.
VENTILATION OF
FRYER**

The fryer should be located with provision for venting into an adequate exhaust hood or ventilation system. This is essential to permit efficient removal of the steam exhaust and frying odors. Special precaution must be taken in designing an exhaust canopy to avoid interference with the operation of the fryer. We recommend you consult a local ventilation or heating company to help in designing an adequate system.

NOTICE

Ventilation must conform to local, state, and national codes. Consult your local fire department or building authorities.

**2-6.
GAS SUPPLY**



When installing the gas open fryer, do not attach an extension to the gas flue exhaust stack. This may impair proper operation of the burner, causing malfunctions and possible negative back draft.

The gas open fryer is factory available for either natural or propane gas. Check the data plate inside the left front door of the cabinet to determine the proper gas supply requirements. The minimum supply for natural gas is 7 inches water column (1.7 kPa) (17.0 mbar), and 10 inches water column (2.49 kPa) (24.9 mbar) for propane.



Do not attempt to use any gas other than that specified on the data plate. Incorrect gas supply could cause a fire or explosion resulting in severe injuries and/or property damage.

Please refer below for the recommended hookup of the fryer to main gas line supply.



To avoid possible serious personal injury:

- Installation must conform with local, state, and national codes, the American National Standard Z223.1/NFPA 54_-(the latest edition) National Fuel Gas Code, and the local municipal building codes. In Canada, the Natural Gas and Propane Installation Code is CSA B149.1 & Installation Codes - Gas Burning Appliances and local codes. In Australia, in accordance with Australian Gas Authority rules AS5601.1/2-2010.
- The fryer and its manual shutoff valve must be disconnected from the gas supply piping system during any pressure testing of that system at test pressures in excess of 1/2 PSIG (3.45 kPa) (34.5 mbar).

- The fryer must be isolated from the gas supply piping system by closing its individual manual shutoff valve during any pressure testing of the gas supply piping system at test pressures equal to or less than 1/2 PSIG (3.45 kPa) (34.5mbar).
- A standard one inch (2.54 cm), black steel pipe and malleable fittings should be used for gas service connections for 3 & 4 well open fryers, and 3/4 inch (1.91 cm) for 2 wells.
- Do not use cast iron fittings.
- Although one inch (2.54 cm) size pipe is recommended for 3 & 4 wells and 3/4 inch (1.91 cm) for 2 wells, piping should be of adequate size and installed to provide a supply of gas sufficient to meet the maximum demand without undue loss of pressure between the meter and the open fryer. The pressure loss in the piping system should not exceed 0.3 in. water column (0.747 mbar).

**2-6.
GAS SUPPLY
(CONT.)**

Provisions should be made for moving the open fryer for cleaning and servicing. This may be accomplished by:

1. Installing a manual gas shutoff valve and a disconnect or union.
2. Installing a heavy-duty design CSA certified connector. In order to be able to service this appliance, which is provided with casters, a connector complying with ANSI Z21.69-CAN 6.16 or CAN 1-6.10m88 and a quick-disconnect device, complying with ANSI Z21.41 or CAN 1-6.9m70, must be installed. It must also be installed with restraining means to guard against transmission of strain to the connector as specified in the appliance manufacturer's instructions.
3. See the illustration on the following page for the proper connection of flexible gas line and cable restraint.

NOTICE

The cable restraint limits the distance the open fryer can be pulled from the wall. For cleaning and servicing the unit, the cable must be unsnapped from the open fryer and the flexible gas line disconnected. This allows better access to all sides of the open fryer. The gas line and cable restraint must be reconnected once the cleaning or servicing is complete.

**2-6.
GAS SUPPLY
(CONT.)**

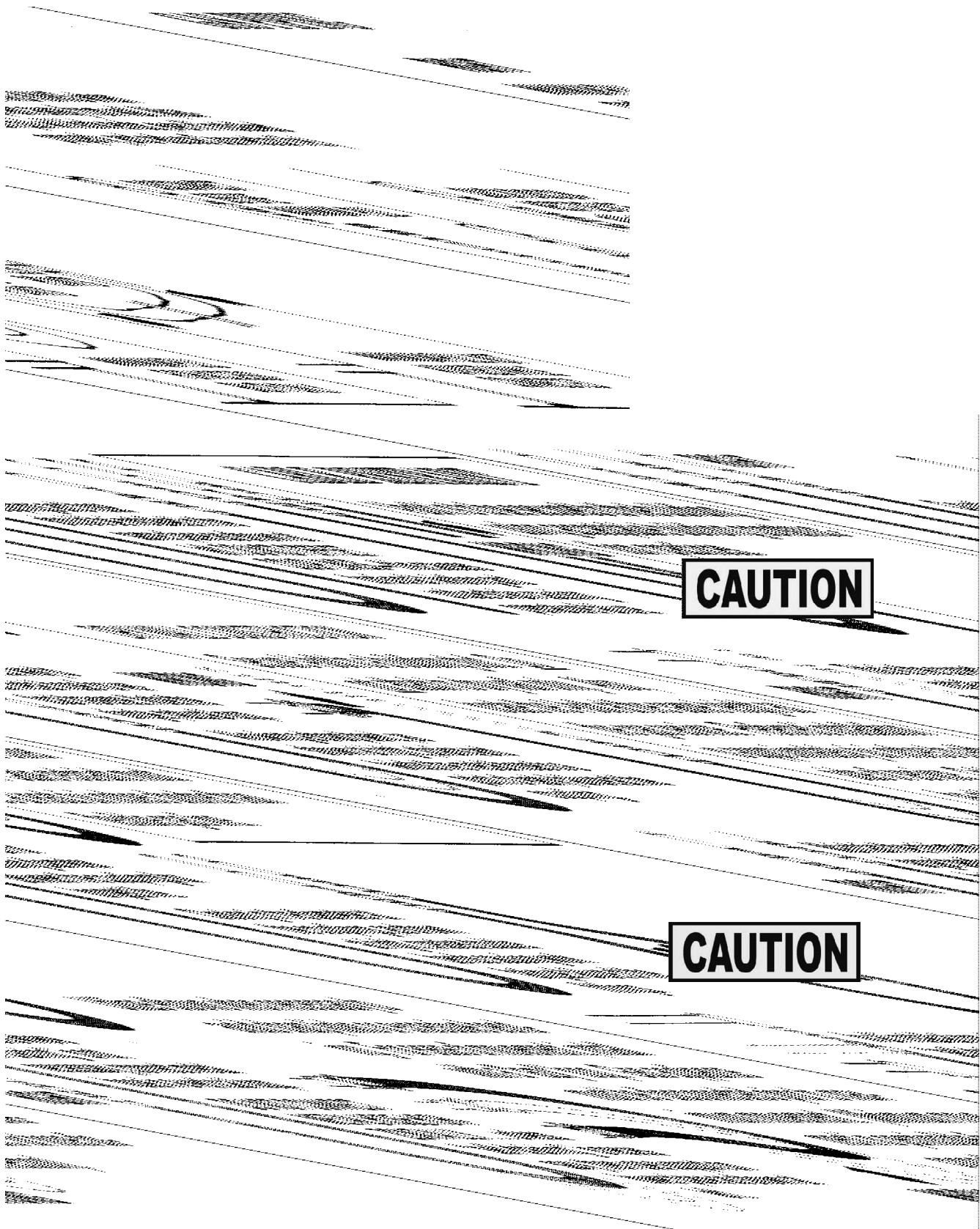

**2-7.
GAS LEAK TEST**

NOTICE

Prior to turning the gas supply on, be sure the gas valve knob on the gas control valve is in the off position.

Upon initial installation, and after moving the unit, the piping and fittings should be checked for gas leaks. A simple checking method is to turn on the gas and brush all connections with a soap solution. If bubbles occur, it indicates escaping gas. In this event, the piping connection must be redone.



To avoid fire or explosion, never use a lighted match or open flame to test for gas leaks. Ignited gas could result in severe personal injury and/or property damage.

**2-8.
GAS PRESSURE
REGULATOR
SETTING**

The gas pressure regulator on the gas control valve is factory set as follows:

- Natural: 3.5 inches water column (0.87 kPa) (8.72 mbar).
- Propane 10.0 inches water column (2.49 kPa) (24.9 mbar).

NOTICE

The gas pressure regulator has been set by Henny Penny and is not to be adjusted by the user.

**2-9.
ELECTRICAL
REQUIREMENTS**

- 120 V, 50/60 Hz, 1 PH, 12 A
- 230 V, 50 Hz, 1 PH, 7 A

The 120 volt gas fryer is factory equipped with a grounded (earthed) cord and plug for your protection against shock, and should be plugged into a three-prong grounded (earthed) receptacle. Do not cut or remove grounding (earthing) prong. Any 230 volt plug used on the 230 volt unit must conform to all local, state, and national codes.



To avoid electrical shock, this appliance must be equipped with an external circuit breaker which incorporates a 3mm disconnection in all ungrounded (unearthed) conductors. The main power switch on this appliance does not disconnect all line conductors.

**2-9.
ELECTRICAL
REQUIREMENTS
(CONT.)**



To avoid electrical shock, do not disconnect the ground (earth) plug. This fryer must be adequately and safely grounded (earthed). Refer to local electrical codes for correct grounding (earthing) procedures or in absence of local codes, with The National Electrical Code, ANSI/NFPA No. 70-(the current edition). In Canada, all electrical connections are to be made in accordance with CSA C22.2, Canadian Electrical Code Part 1, and/or local codes.

Disconnect power supply before a thorough cleaning or servicing the fryer.

**2-10.
MOTOR BEARINGS**

The electric motor bearings are permanently lubricated. **DO NOT LUBRICATE.**

**2-11.
LIGHTING AND
SHUTDOWN OF THE
BURNERS**

1. Turn the power switch to the OFF position.
2. Wait at least 5 minutes and then turn power switch to the ON position.
3. Press  button on the controls (left or right).
4. The burner lights and operates in a Melt Cycle until the shortening reaches a preset temperature.
5. Once the display shows a product selection or a double dashes, press the desired product button.

NOTICE

The fryer is equipped with a ignition spark module which has a set ignition safety time (TSA) of 90 seconds.

To shutdown burner:

1. Press  button on the controls (left or right).
2. Turn the power switch to the OFF position.
NOTE: This turns off all vats.

**2-12.
TESTING THE
FRYER**

Each Henny Penny open fryer was completely checked and tested prior to shipment. However, it is good practice to check the unit for proper operation.

**2-13.
DIMENSIONS**

3-WELL

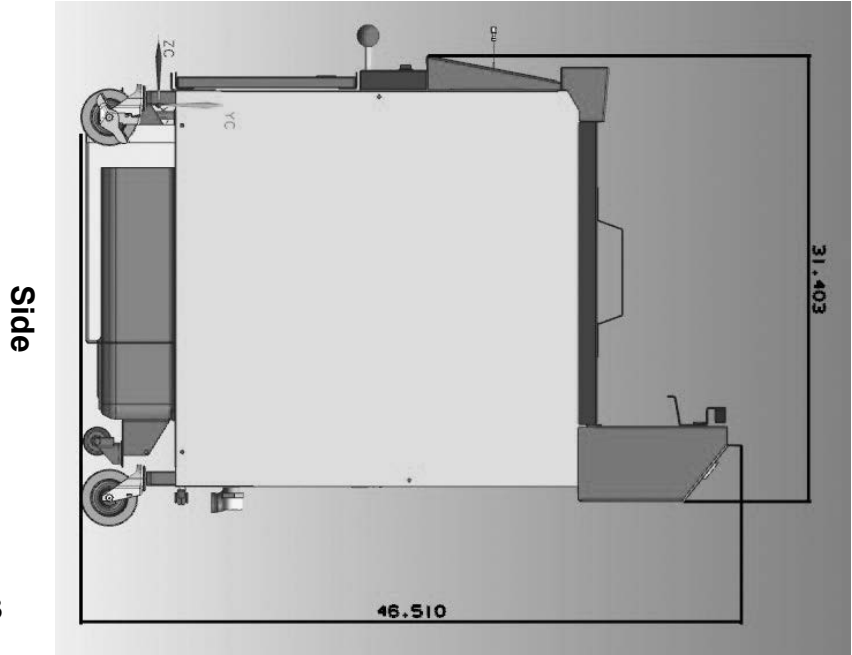
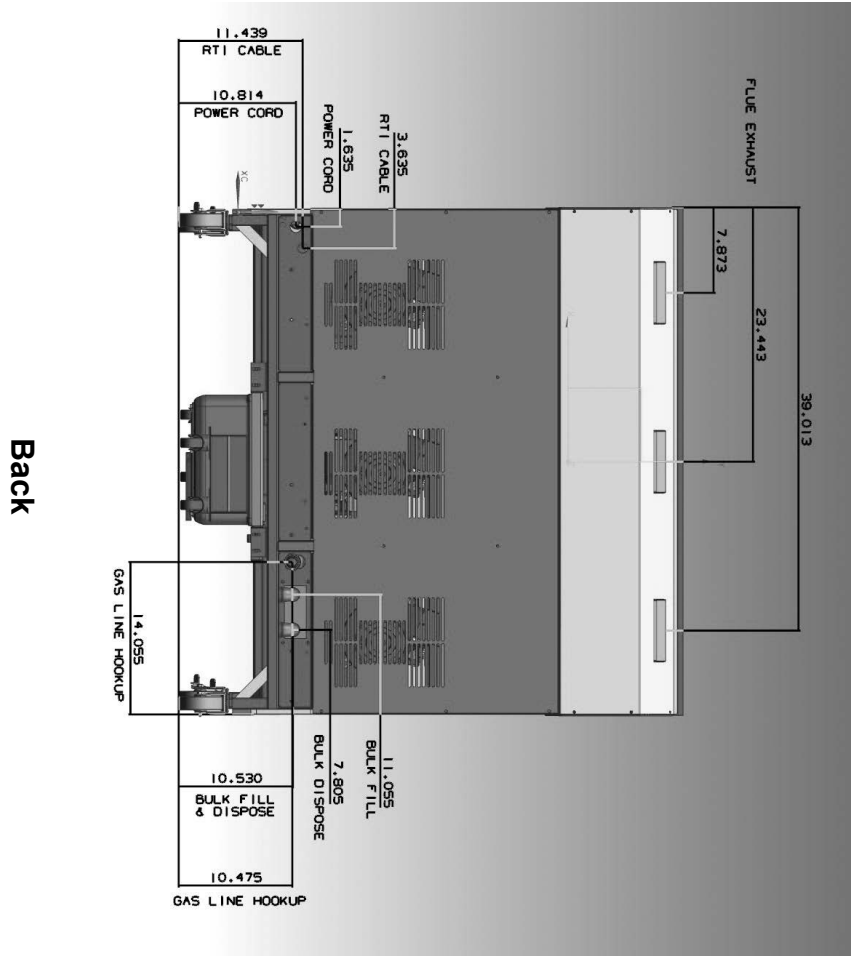

Side dimensions are the same for both 153 & 154 units.

**2-13.
DIMENSIONS
(CONT.)**

4 WELL

Back

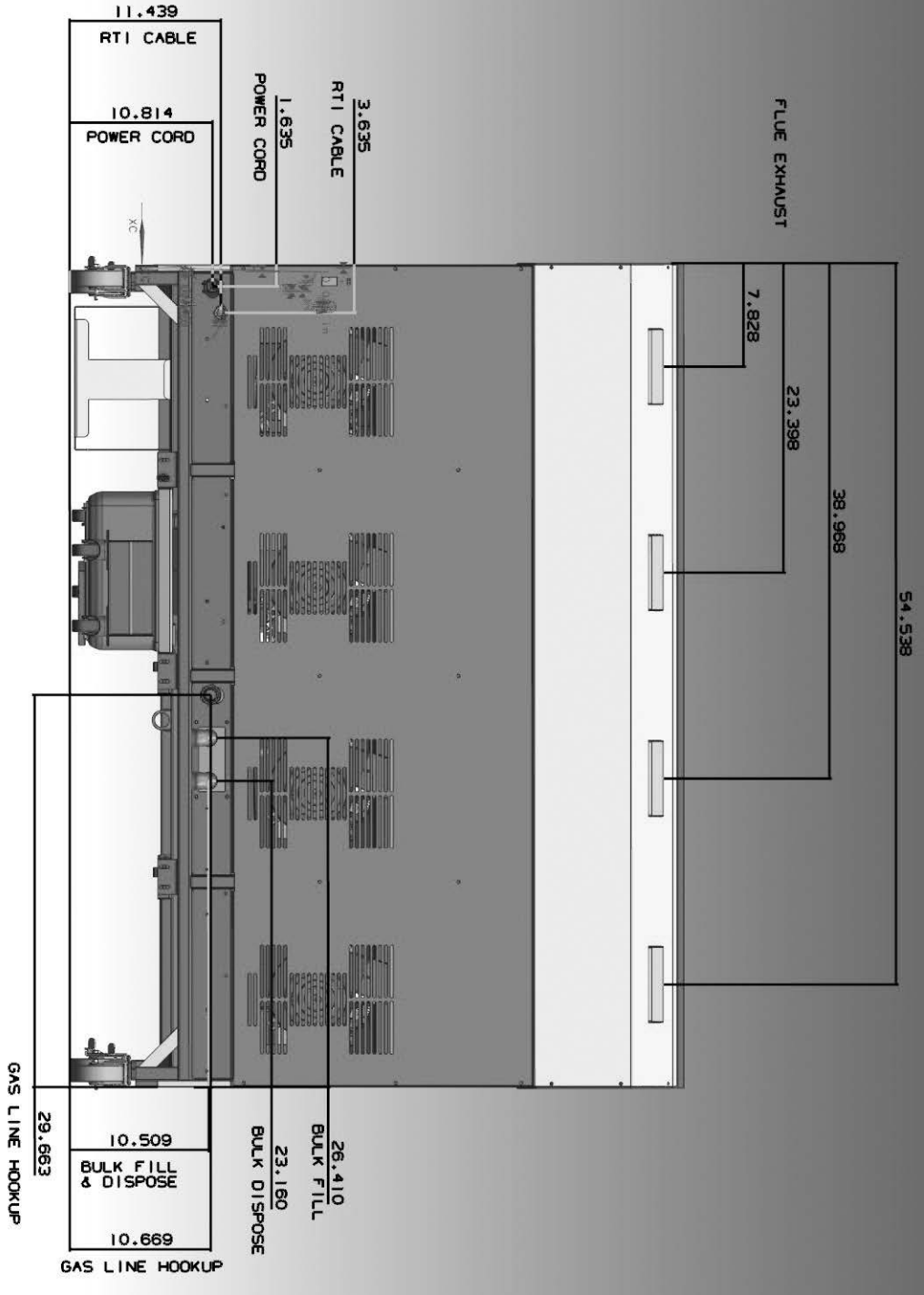

SECTION 3: OPERATION

3-1. OPERATING COMPONENTS

Refer to explanations on the next pages.

Figure 3-1

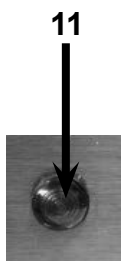
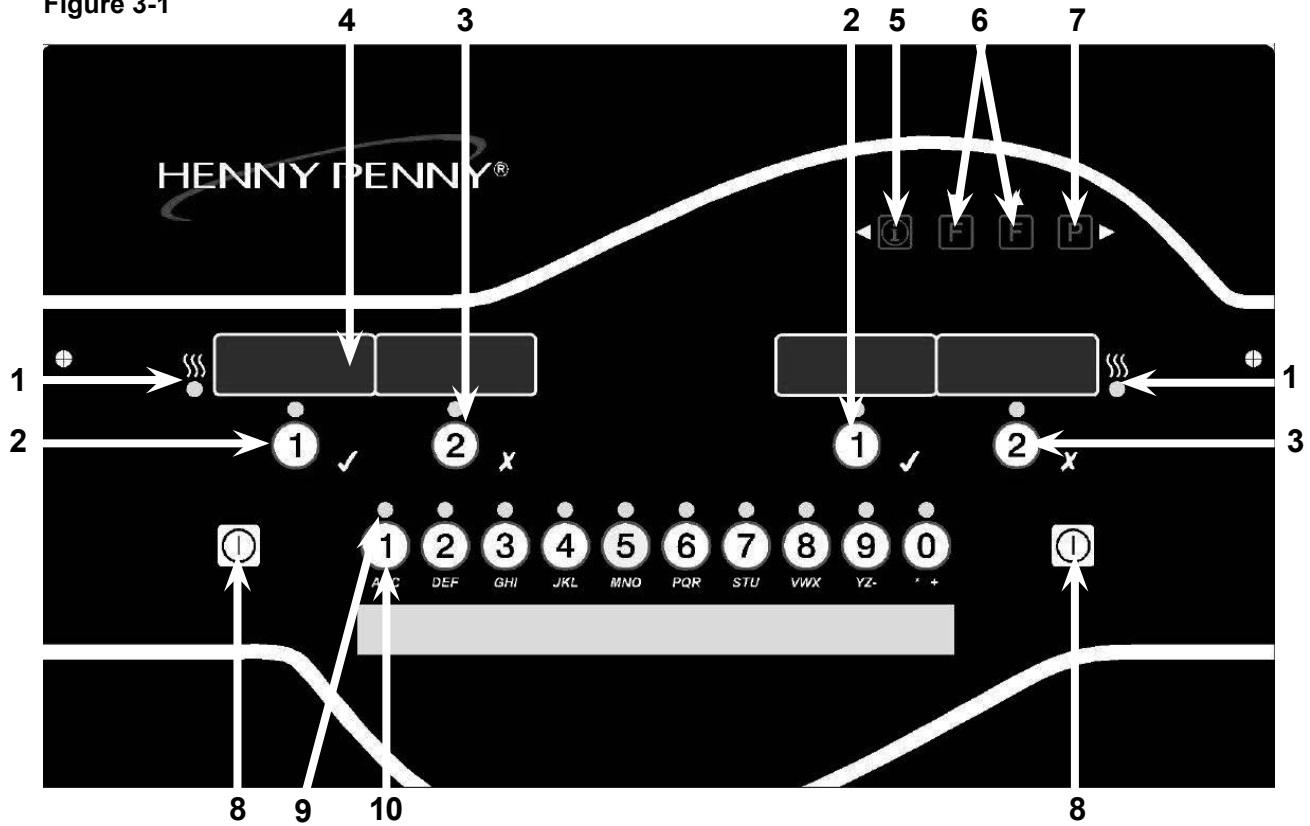

Figure 3-2

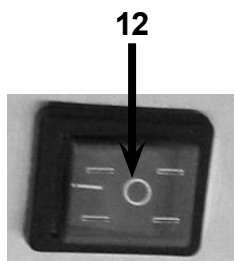

Figure 3-3

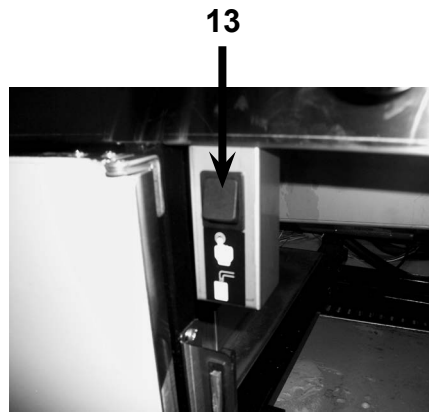











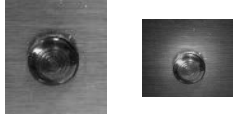



Figure 3-4

**3-1.
OPERATING
COMPONENTS
(CONT.)**

Fig.	Item No.	Description	Function
3-1	1		This LED lights when the control calls for heat for the left/ right vat, and the burners ignite and heat the oil
3-1	2		During normal operation, press this button to start and stop cook cycles for the left basket; press to change displayed product; also used for ✓ to indicate YES or to confirm
3-1	3		During normal operation, press this button to start and stop cook cycles for the left basket; press to change displayed product; also used for X to indicate NO or cancel
3-1	4	Digital Display	Shows the product codes; shows the timer countdown during cook cycles; shows the prompts during the filter modes; shows the selections in the Program Mode; shows the temperature of the oil by pressing  ; shows error codes (also displays in several languages)
3-1	5		Press once to view actual oil temperature; press twice to view oil set-point temperature; and press three times to view recovery information for each vat from 250°F-300°F (121°C-149°C). Used in Programming Modes; used as ◀ button to back-up to a previous parameter in Program and Filter Modes.
3-1	6		Used to access the Filter Menu; also used for ▲ or ▼ buttons; press once to view the number of cook cycles before next filter in Global Filter or the mode or percentage of filter allowance in Mixed Filter; press twice to view the time and date of the most recent filter on each vat; press three times to view the number of hours of use of the filter pad presently in the drain pan.
3-1	7		Used to access the Program Modes; used as ▶ button to advance to the next parameters in Program and Filter Modes; press to select 2nd languages and volumes
3-1	8		Press to turn on and off the heat system for the left vat(s); on full vats either button can be used
3-1	9		Each product button LED lights when that particular product has been selected, or when it is compatible with cook temperature.
3-1	10		Press to select the desired product; press to place the letters under the button, during naming a product in Program Mode The  can be used to start an Idle Mode if enabled in Special Program Mode

**3-1.
OPERATING
COMPONENTS
(CONT.)**

Fig.	Item No.	Description	Function
3-2	11		A Filter Beacon® is found beside each black drain knob; when lit blue, indicates the oil should be filtered at this time; beacon flashes when the drain needs opened or closed
3-3	12		When the power switch is turned to the ON position, power is supplied to the controls and pumps
3-4	13		For fryers with a bulk oil supply, press this button to fill the BIB

**3-1.
OPERATING
COMPONENTS
(CONT.)**

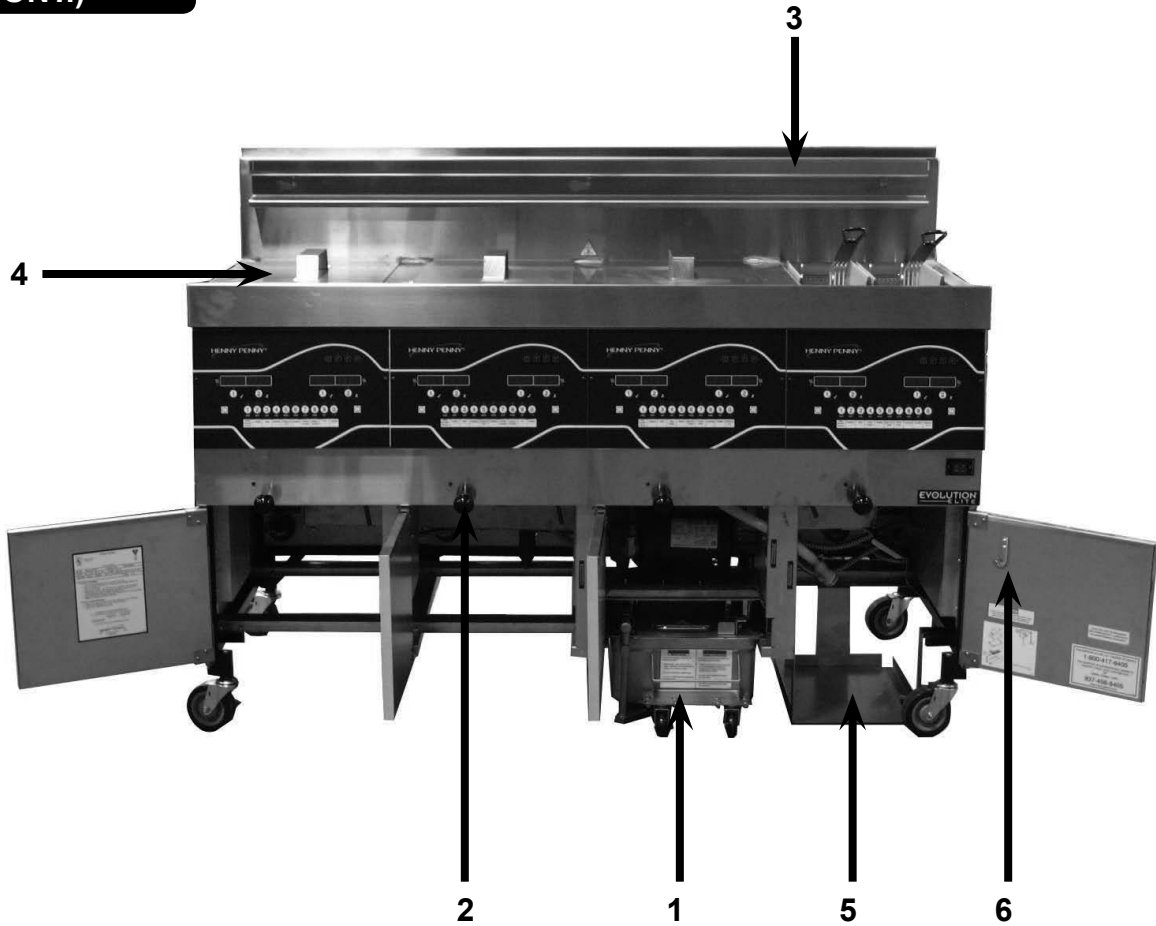

Item No.	Description	Function
1	Filter Drain Pan Assy.	Oil is drained into this pan and then is pumped through filters to help prolong the use of the oil
2	Drain Valve Knob	Pull-out on black knobs to open drain valve and oil drains from vat; Push-in to close drain valve and oil can be pumped into vat
3	Basket Rest	The baskets hang on this when not in use, or to drain the product after a cook cycle
4	Vat Covers	Covers the vat when not in use
5	BIB Support	Area that holds the Jug-in-a-Box; holds oil to be pumped into vats to top-off the oil level by the Oil Guardian™ process
6	Quick Reference Cards Hook	Holds operational cards

**3-2.
SET-UP MODE**

Upon initial start-up, the controls will ask to confirm the settings for the fryer.

When main power switch is turned on, "OFF" shows in both displays. Press **[1]** on either side and *SETUP* *ENTER CODE* shows in display. Press 1, 2, 3, and "LANGUAGE" shows on the left display, "ENGLISH" on the right display.

Use **▲** or **▼** buttons to change the operation display to: Greek "ΕΛΛΗΝΙΚΑ", Russian "РУССКИЙ", Swedish "SVENSKA", German "DEUTSCHE", Portuguese "PORTUG.", Spanish "ESPAÑOL", or French "FRANCAIS".

Press **▶** to continue with the other set-up items which include:

- TEMP FORMAT - °F or °C
- TIME FORMAT - 12-HR or 24-HR
- ENTER TIME - Time of day (use product buttons to change)
- ENTER TIME - AM or PM
- DATE FORMAT - MM-DD-YY or DD-MM-YY
- ENTER DATE - Today's date (use product buttons to change)
- DAYLIGHT SAVING TIME - 1.OFF; 2.US (2007 & after); 3.EURO; 4.FSA (US before 2007)
- FRYER TYPE - ELEC or GAS
- VAT TYPE - FULL OR SPLIT
- AUTOLIFT ENABLED? - NO LIFT or YES LIFT
- BULK OIL SUPPLY - YES or NO
- BULK OIL DISPOSE? - YES or NO
- S/N - Shows serial number of the unit or can be recorded (THIS SERIAL NUMBER SHOULD MATCH THE SERIAL NUMBER ON THE DATA PLATE, ON THE DOORS.)
- 2nd LANGUAGE - By setting a second language in the controls, 2 languages can now be easily chosen by pressing **[P]** during normal operation. One language shows in left display and second language shows in right display. Pressing the **√** button under desired language, selects that language seen in displays.
- 2nd VOLUME - By setting a second volume in the controls, 2 volumes can now be easily chosen by pressing **[P]** twice during normal operation. One volume setting shows in left display (NONE to 10; 10 being the loudest) and a second volume shows in right display. To select volume, press **√** button under desired volume.
- SETUP COMPLETE - OFF is displayed and unit shuts down.

NOTICE

Unless otherwise indicated, use **▲** or **▼** to change settings.

Setup Mode can also be accessed by re-initializing the controls, in Special Program Mode, in Level 2 programming (SP-3).

**3-3.
FILLING OR ADDING
OIL**



Figure 1



Figure 2



Figure 3

CAUTION

The oil level must always be above the burner tubes when the fryer is heating and at the oil level indicators on the rear of the vat. Failure to follow these instructions could result in a fire and/or damage to the fryer.

Solid oil is not recommended. Solid oil could cause clogging and pump failures.

1. It is recommended that a high quality frying oil be used in the open fryer. Some low grade oils have a high moisture content and causes foaming and boiling over.

2. Oil Capacities:

Full-size vats = 15 quarts/30 lbs (14.2 liters/13.6 kg)

3. All vats have 2 level indicator lines inscribed on the rear wall of the vat. The upper-most line shows the oil at the proper level when heated. Figure 1.

3. Place basket support inside of vat and fill vat with cold oil to the lower indicator. Figure 2.

**WARNING
BURN RISK**

Wear gloves to avoid severe burns when pouring hot oil into vat. Oil and all metal parts that are in contact with the oil are extremely hot; take care to avoid splashing.

Filling Vat from Bulk Supply (Must be equipped with optional accessories & controls set to “YES” for “Bulk Oil Supply?” in Set-Up Mode)

1. Turn the main power switch to the ON position.
2. Place basket support inside of vat. Figure 2.
3. Press and hold **F** (on either side) until display shows *FILTER MENU*, along with 1.EXPRESS FILTER?
4. Press and release **▶** button 6 times until display shows “7. FILL FROM BULK”.
5. Press **√** button and display shows “FILL VAT” and then “√=PUMP” “X=DONE”. Press and hold **√** button again to fill vat and display shows “FILLING”.
6. Once oil is to the lower fill line, release **√** button and display returns to “FILL VAT” “√=PUMP” “X=DONE”. Press **X** button twice to return to normal operation.

NOTICE

Press and hold the black button behind the right door to fill the BIB from the Bulk Supply as needed. Figure 3.

**3-4.
MORNING START-UP
PROCEDURES**

1. Make sure basket support is in vat and vat is filled with oil to the proper level.
2. Move power switch to the ON position and then press to turn on heat for the desired vat. If display shows “IS POT FILLED?” make sure oil is at the proper level (see Section 3-2) and then press √ button for “YES”.
3. Unit automatically goes into the Melt Cycle until the oil temperature reaches 180°F (82°C) and then control automatically exits the Melt Cycle.

NOTICE

The Melt Cycle may be bypassed, if desired, by pressing √ button or X button and holding it for 5 seconds.

The control then shows “EXIT MELT” and “YES NO”. Press √ button for “YES” and vat heats continuously until the set-point temperature is reached.

CAUTION

Do not leave fryer unattended and do not bypass the Melt Cycle unless enough oil has melted to completely cover all of the burner tubes. If the Melt Cycle is bypassed before the burner tubes are covered, excessive smoking of oil, or a fire will result.



 **DANGER**
OVERFLOW RISK

DO NOT OVERLOAD, OR PLACE PRODUCT WITH EXTREME MOISTURE CONTENT INTO THE BASKETS. 3 LBS. (1.4 KG.) IS THE MAXIMUM AMOUNT OF PRODUCT PER FULL VAT AND 1-1/2 LBS. (.68 KG.) FOR THE SPLIT VATS. FAILURE TO FOLLOW THESE INSTRUCTIONS CAN RESULT IN OIL OVERFLOWING THE VAT WHICH COULD CAUSE SERIOUS BURNS, PERSONAL INJURY, FIRE AND/OR PROPERTY DAMAGE.

IF THE SHORTENING TEMPERATURE EXCEEDS 420°F (216°C), IMMEDIATELY SHUT OFF THE POWER AT THE MAIN CIRCUIT BREAKER AND HAVE THE FRYER REPAIRED. IF OIL TEMPERATURE EXCEEDS ITS FLASHPOINT, FIRE WILL OCCUR, RESULTING IN SEVERE BURNS AND/OR PROPERTY DAMAGE.



**3-5.
BASIC OPERATION**

The Evolution Elite fryer is available as non-auto-lift and auto-lift models. The auto-lift controls, allow the baskets to be automatically lowered into the shortening at the beginning of the cook cycle, and raised from the shortening at the end of the cycle.

1. Once out of the Melt Cycle, LOW TEMP flashes until the setpoint temperature has been reached. Once the setpoint temperature has been reached, the product name now shows in the display, ex: FRY, and product now can be placed in the oil.
2. Press a timer button  or .
3. Display shows the name of the product cooking (ex: "FRY") and the timer counting down.
4. When cook cycle is complete, an alarm sounds and display shows "DONE".
5. Press the timer button under "DONE" to stop the alarm, and lift basket from vat.
6. If a Quality Timer (hold timer) has been programmed, the hold time starts automatically when the user presses the timer button to end the cook cycle. While the quality timer counts down, the display shows the three-digit product abbreviation followed by "Qn", where "n" is the number of minutes remaining. ex: "FRY" / "Q5" / "FRY" / "Q5" / "FRY" / "Q4", etc.

At the end of the timer countdown, control beeps and the display shows "QUAL" followed by the three-digit product name: "QUAL" / "FRY" / "QUAL" / "FRY". Press the timer button to cancel the timer.

NOTICE

To stop a cook cycle at any time, press and hold the timer button  or .

**3-6.
IDLE MODE**

Once programmed, Idle Mode help saves on oil and utility costs by lowering set-point of oil when vat is not being used. To activate Idle Mode, press  button, or can be programmed to activate automatically after "X" minutes of inactivity on the vat.

The oil is maintained at a lower temperature until the  button is pressed, and then the oil is heated to cooking temperature. See Special Program Modes SP-7, SP-7A, SP-7B, & SP-7C.

**3-7.
OIL GUARDIAN™
(AUTO TOP-OFF)**

During normal operation, the control automatically monitors vat oil level. If the control senses oil level is too low, unit automatically pumps oil from BIB into vat to keep oil at the proper level.

Manual Top-Off

If oil level is a little low, oil can be added to vat at any time from BIB to raise oil level to the proper level by following steps below. This procedure is NOT to be used to fill an empty vat.

1. Press and hold **F** (either one-full vat) until display shows “*FILTER MENU*” followed by “1.EXPRESS FILTER”.
2. Press **▶** 5 times until “6.FILL FROM BIB” shows in display.
3. Press **√** button, “FILL VAT” “√=PUMP” “X=DONE” is displayed.
4. Press and hold **√** button; display shows “FILLING” and oil is pumped from the BIB to the vat.
5. Once vat is full, release **√** button, “FILL VAT” “√=PUMP” “X=DONE” displays. Press X button twice for normal operation.

**3-8.
SELECTING A
PRODUCT WITH
A DIFFERENT
SETPOINT**

When selecting a product, if “XXX XXX” shows in display, the setpoint temperature is not correct for this product. To change the setpoint temperature for the desired product:

1. Press product button, for ex: **1** (FRY).
2. Display shows “XXX XXX”.
3. Press and hold a timer button **1** or **2** for 5 seconds and then “FRY” shows in display.
4. Allow oil temperature to reach setpoint temperature before dropping product.

**3-9.
REPLACING THE BIB**



Figure 1

1. Control displays “BIB IS LOW” and an alarm sounds.
2. Open right door, pull BIB from unit, pull cap from BIB top, discard empty BIB, and replace with full one. Figure 1.

**3-10. A
FILTER - MANUAL**



Figure 1



Figure 2



Figure 3

1. During normal operation and after a certain number of cook cycles, the Filter Beacon® illuminates on the front of the fryer (Figure 1), and the control periodically shows “FLTR NOW?” “YES NO”.

If X for NO is pressed, fryer resumes normal operation and control suggests filter later.

2. Check Filter Pan: If the filter drain pan or cover is not in place, the display shows “CHK PAN”. Make sure that the filter pipe is tightly connected, and that the filter drain pan is as far back under fryer as it will go and the filter pan cover is in place.
3. Press √ button for YES and display shows “SKIM VAT” followed by “CONFIRM” “YES NO”. Skim vat, press √ button for YES and display shows “OPEN DRAIN”. Pull drain knob (Figure 2) out, display shows “DRAINING” and oil drains from the vat.



To avoid overfilling the drain pan, drain only 1 vat at a time. The drain pan holds 1 full vat, or 2 split vats of oil. Overfilling the drain pan may cause slippery floors, which may result in personal injury.

NOTICE

If filtering is NOT desired, press ①, the display shows “STOPPED” followed by “CONTINUE FILTER” “YES NO”. Press X button, display shows “QUIT FILTER” “YES NO”, press √ button; SmartFilter is canceled, the blue light goes out, and controls return to normal operation. Controls will suggest filtering after several more cook cycles.

If the drain is clogged by food soil, the display will show “VAT EMPTY”, followed by “YES NO”. Use straight white brush to clear drain, press the √ button, and display shows “DRAINING”. Controls will proceed with filtering process.

4. At end of drain cycle, “VAT EMPTY” followed by “YES NO” is displayed. Visually check vat is empty and press √ button, “WASHING” is displayed. Once filter process is complete, display shows “CLOSE DRAIN”. Push-in on drain knob to close drain (Figure 3). Display shows “FILLING” and vat re-fills with oil.

**3-10. A
FILTER - MANUAL
(CONT.)**

5. Once vat is filled, display shows “IS POT FILLED?” “YES NO”. Make sure vat is full and then press √ button for YES and the control turns “OFF”.
6. If the oil has not pumped back to the proper level in the vat during the SmartFilter Express™ process, press X button for NO and pump runs for another 30 seconds.
7. Display shows “IS POT FILLED?” “YES NO”. Make sure vat is full and then press √ button and display shows and the control returns to normal operation. Press X button and pump runs for another 30 seconds. You can try to fill the vat 3 times.

Filter Error

8. After trying to fill the vat 3 times without success, the display shows “*CHANGE* *FILTER* *PAD* CLOGGED?”. Press √ button and controls turn OFF. Change filter pad following procedures in Changing the Filter Pad Section.
9. If filter pad is not changed, the “CHANGE FILTER PAD?” reminder will display every 4 minutes until pad is changed.
10. During the next SmartFilter Express™ with a new filter pad, if the vat is not filled after 3 tries, the display shows “FILTER SERVICE REQUIRED-SEE TROUBLE-SHOOTING GUIDE” followed by “YES”. Press √ button and controls turn unit OFF.

NOTICE

To help ensure vat fills completely, clean the filter pan at least once a day, change the filter pad at least once a day, and make sure BIB is full and that “O” rings on the filter pan are in good condition. If your store operates 24 hours a day, clean the filter pan and change the filter pad twice a day.

3-10. B
FILTER - SMART TOUCH

This section describes how to run an automatic filter procedure using the push-button feature.

1. During normal operation and after a certain number of cook cycles, the blue light illuminates on the front of the fryer, and the control periodically shows “FLTR NOW?” “YES NO”.
2. If filtering is desired, press \checkmark button for YES and display shows “SKIM VAT”, followed by “CONFIRM” “YES NO”.
3. Once the crumbs are skimmed off the top of the oil, press \checkmark button for YES and display shows “DRAINING” drain opens and the oil drains from the vat. (If control suspects oil in drain pan “CAUTION IS THERE OIL IN PAN? YES NO” may show in display. Make sure drain pan is empty before proceeding.)
4. If filtering is NOT desired, press X button and the AIF (Automatic Intermittent Filter) is canceled. The blue light goes out and the controls return to normal operation. The controls will suggest filtering after several more cook cycles.

NOTICE

If drain is clogged, see Section 3-22 to prevent damage to the fryer.

CAUTION

If display shows “VAT EMPTY”, followed by, “YES NO”, check that drain is clear and vat is empty. Press \cup button and display shows “WASHING” followed by “FILLING”.

NOTICE

The WASH step of the first Autofilter on a new filter pad lasts an extra 45 seconds to “break in” the pad.

5. If the display shows “IS POT FILLED?” “YES NO”, make sure vat is full and then press \cup button for YES and control returns to normal operation.

Filter Error

6. If the oil has not pumped back to the proper level in the vat during the AIF process, press X button for NO and display shows “0:30” and counts down to “0:00”.
7. Display shows “IS POT FILLED?” “YES NO”. Press \checkmark button and control returns to normal operation. Press X button and pump runs for another 30 seconds. You can try to fill the vat 3 times.

**3-10. B
FILTER - SMART TOUCH
(CONT.)**

8. After trying to fill the vat 3 times without success, the controls then shows “CHANGE FILTER PAD?” “YES NO”. If changing the filter pad at this time, press √ and change filter pad following the procedures in the Changing the Filter Pad or Paper Section. Controls return to normal operation.

If filter pad is to be changed at a later time, press X button and “CHANGE FILTER PAD?” reminder shows 15 minutes later.

9. During the next AIF with a new filter pad, if the vat is not filled after 3 tries, the display shows “FILTER SERVICE REQUIRED-SEE TROUBLESHOOTING GUIDE”.
10. If the “Service Required” message appears, then every 15 minutes the display shows “FILTER PROBLEM FIXED? YES NO”. If the problem has not been fixed, press X button. Once the problem has been resolved, press √ and controls return to normal operation.

NOTICE

To help ensure the vat fills completely, make sure filter pan is cleaned at least daily, filter pad is changed, make sure JIB is full and that “O” rings on the filter pan are in good condition.

**3-11. A
MANUAL DAILY
FILTERING**



Figure 1



Figure 2

This filtering procedure allows for a more thorough cleaning of the vat and should be done once a day. The vat can be filtered during any non-frying times.



To avoid burns from hot oil, use approved safety equipment including, apron, face shield and gloves before starting filtering procedure.

Also, to avoid overfilling the drain pan, drain only 1 vat at a time. The drain pan holds 1 full vat, or 2 split vats of oil. Overfilling the drain pan may cause slippery floors, which may result in personal injury.

1. Check Filter Pan: A new filter pad should be used on the first filter of each day, but the same filter pad can be used the rest of the day, except for fish vats. After filtering a fish vat, be sure to change the filter pad.
2. Make sure filter pan cover is in place, filter drain tube is secured, and filter drain pan is pushed in and locked into place. If filter drain pan and cover are not latched into place, display shows “CHK PAN”.
3. Press and hold **F** until display shows “1.EXPRESS FILTER?”
4. Press **▶** button and display shows “2.DAILY FILTER?”
5. Press **√** button for YES and display shows “CONFIRM”, followed by “YES NO”.
6. Press **√** button for YES and display shows “OPEN DRAIN”. Pull-out on the drain knob (Figure 1), display shows “DRAINING” and oil drains from the vat, or press **X** button for NO and controls return to normal operation.
7. Once oil has drained from vat, remove basket support from vat.
Figure 2.



Use protective cloth or gloves when lifting the basket support. Support may be hot and burns could result.

**3-11. A
MANUAL DAILY
FILTERING
(CONT.)**

8. Scrape or brush the sides and the bottom of the vat. Be careful not to damage the sensing probes.

CAUTION

Do not use steel wool, other abrasive cleaners or cleaners/sanitizers containing chlorine, bromine, iodine or ammonia chemicals, as these will deteriorate the stainless steel material and shorten the life of the unit.

Do not use a water jet (pressure sprayer) to clean the unit, or component damage could result.

9. Once vat is clean, display shows “SCRUB VAT COMPLETE?” “YES NO”. Press √ button for YES and display shows “WASH VAT” “YES NO”.
10. Press √ button, display shows “WASHING” and oil circulates through vat for a few minutes. When wash cycle is complete, display shows “WASH AGAIN?” “YES NO”.

NOTICE

The Wash step of the first filter on a new filter pad lasts an extra 45 seconds to “break in” the pad.



Figure 3



Figure 4

11. Press √ button for YES if another wash is needed, otherwise press X button for NO and the display shows “CLOSE DRAIN”. Push-in on drain knob to close drain (Figure 3), the display shows “RINSING”, and vat fills with oil.
12. Once vat is filled, “OPEN DRAIN” shows in display. Pull out on drain knob to open the drain (Figure 4) and display shows “RINSING”. When rinsing is complete, display shows “RINSE AGAIN?” “YES NO”.
13. Press √ button for YES if another rinse is needed, otherwise press X button for NO. Display shows “POLISH” “YES”.
14. Press √ button for YES and oil is “polished” by circulating it through the filtering system. The display shows “5:00 X=STOP”. If desired, press X button to stop the polishing, otherwise the oil is polished for 5 minutes.
15. Once the oil is polished, the display shows “FILL VAT?” “YES”. Press √ button and display shows “CLOSE DRAIN”. Push-in on drain knob to close drain (Figure 3), display shows “FILLING” and vat then re-fills with oil.

**3-11. A
MANUAL DAILY
FILTERING
(CONT.)**

16. Once full, display shows “IS POT FILLED?” “YES NO” Press √ button for YES; fryer returns to normal operation.
17. If X button is pressed, display shows “FILLING”. You can try to fill vat 4 times; then control shows “ADD QUIT”. Press and hold √ button and BIB pump runs filling vat from BIB. When vat is full, press X button and display shows “IS POT FILLED?” “YES NO”. Press √ button for YES and fryer returns to normal operation.

**3-11. B
AUTO DAILY
FILTERING**



Put on protective gear: Be sure to use all McDonald’s approved safety equipment including, apron, face shield and gloves. Never begin filtering until you’re wearing all safety gear. Hot oil can cause severe burns.

Moving the fryer or filter drain pan while containing hot oil is not recommended. Hot oil can splash out and severe burns could result.

1. Check Filter Pan: Use a new filter pad on the first filter of each day, but the same filter pad can be used the rest of the day, except for fish vats. Change the filter pad after filtering a fish vat.

Make sure that the filter pipe is tightly connected, and that the filter drain pan is as far back under fryer as it will go and the filter pan cover is in place. If the filter drain pan or cover is not in place, the display shows “CHK PAN”

2. Make sure oil is hot: The best results are obtained when the frying oil is filtered at the normal frying temperature.
3. Press and hold  until display shows “1.AUTO FILTER?”.
4. Press and release ▼ button and display shows 2.MAINT FILTER?
5. Press ũ button for YES and display shows “MAN FILTER” YES NO.
6. Press √ button for YES and display shows “DRAINING” and the oil drains from the vat, or press X button for NO and controls return to normal operation. (If control suspects oil in drain pan “CAUTION IS THERE OIL IN PAN? YES NO” shows in display. Make sure drain pan is empty before proceeding)
7. Once oil has drained from vat, remove the basket support from the vat. Figure 2



Use protective cloth or gloves when lifting the basket support. The support may be hot and burns could result.

**3-11. B
AUTO DAILY
FILTERING
(CONT.)**

- Use the Hi-Temp Pad Holder, pad, and a small amount of KAY QSR Fryer Cleaner to scrub the walls, corners and bottom of the inside of the vat. Use the Hi-Temp Detail Brush to clean in between and underneath burner tubes, corners of vats and other hard-to-reach areas. Be careful not to damage sensing probes.

CAUTION

Do not use steel wool, other abrasive cleaners or cleaners/sanitizers containing chlorine, bromine, iodine or ammonia chemicals, as these will deteriorate the stainless steel material and shorten the life of the unit.

Do not use a water jet (pressure sprayer) to clean the unit, or component damage could result.

- Once the vat is clean and the display shows “SCRUB VAT COMPLETE?” “YES NO”. Press √ button for YES and the display shows “WASH VAT” “YES NO”.

NOTICE

The WASH step of the first Maintenance Filter on a new filter pad lasts an extra 45 seconds to “break in” the pad.

- Press √ button and display shows “WASHING”. The oil circulates through the vat for several minutes. Once the wash cycle is complete, display shows “WASH AGAIN?” “YES NO”.
- Press √ button for YES if another wash is needed, otherwise press X button for NO and the display shows RINSING and fryer automatically rinses the vat. When rinsing is complete, display shows “RINSE AGAIN?” “YES NO”.
- Press √ button for YES if another rinse is needed, otherwise press X button for NO. The display shows “POLISH?” “YES”.
- Press √ button for YES, the oil is “polished” by circulating it through the filtering system and the display shows “5:00 STOP”.
- Once oil is polished, display shows “FILL VAT?”, along with “YES”. Press √ button; the display shows “FILLING” and vat fills with oil.
- Once full, the display shows “IS POT FILLED?” “YES NO”. Press √ button for YES and fryer returns to normal operation.

If X button is pressed, the display shows “FILLING” and pump runs for 30 seconds and stops, display shows “IS POT FILLED?” “YES NO”. After 3 tries, display shows “ADD QUIT”. Press and hold √ button to fill pot and release. Press X button and display shows “IS POT FILLED?” “YES NO”. Press √ button and controls return to normal operation.

**3-12.
DISCARDING OIL
FROM VAT USING
OPTIONAL OIL
DISCARD SHUTTLE**



WITH PROLONGED USE, THE FLASHPOINT OF OIL IS REDUCED. DISCARD OIL IF IT SHOWS SIGNS OF EXCESSIVE SMOKING OR FOAMING. SERIOUS BURNS, PERSONAL INJURY, FIRE, AND/ OR PROPERTY DAMAGE COULD RESULT.



Figure 1



Figure 2



Figure 3

1. Open the door, lift-up on the drain pan stop and pull-out the drain pan assembly, using the handle on the drain pan. Figures 1 & 2.
2. Press and hold **F** (either one) until display shows “*FILTER MENU*”, along with “1.EXPRESS FILTER?”.
3. Press and release **▶** button twice until display shows “3.DISPOSE?”. Press **√** button and display shows “DISPOSE?” “YES NO”.
4. Press **√** button and “IS DISPOSAL UNIT IN PLACE” “YES NO” shows in display.
5. With discard shuttle rolled into place (Figure 3), press **√** button and display shows “OPEN DRAIN”. Pull-out on drain knob to open drain and display shows “DRAINING”. Oil now drains from the vat into the shuttle.
6. Display shows “VAT EMTY “YES NO”. Verify that vat is empty, and press **√** button.
7. Display shows “CLEAR OLD OIL FROM OIL LINES” “**√** PUMP” “X= DONE”. Press and hold **√** button for a few seconds to clear old oil from lines. Once cleared, press X button.

**3-12.
DISCARDING OIL
FROM VAT USING
OPTIONAL OIL
DISCARD SHUTTLE
(CONT.)**

8. Display shows “CLN VAT COMPLETE” “YES NO”. Once vat is clean, press √ button and display shows “CLOSE DRAIN”. Push-in on the drain knob.
9. Display shows “MANUAL FILL VAT”, followed by “IS POT FILLED?”, along with “YES NO”. Fill vat to the lower indicator line on the rear of the vat. See Filling or Adding Oil instructions from Section 3-3.

Press √ button and fryer returns to normal operation.

10. Remove discard shuttle from under fryer and replace with the filter pan assembly.

**3-13.
DISCARDING OIL
FROM VAT USING
OPTIONAL BULK OIL
DISPOSE SYSTEM**

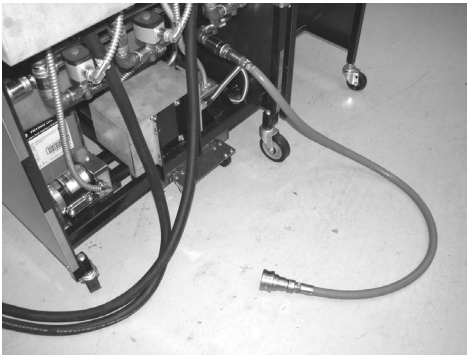

Figure 1



Figure 2

1. Connect female quick disconnect attached to the hose at the rear of fryer, to the correct male quick disconnect at the wall. Once attached, the hose can remain connected unless the fryer is moved. Figures 1 & 2.

NOTICE

“BULK OIL DISPOSE?” in the Special Program Mode or Set-Up Mode, must to set to “YES” for the Bulk Oil Dispose System to operate. Also, a password code step (1, 2, 3) can be added in Special Programming, SP-27.

2. Press and hold **F** (left or right for split vats) until display shows “*FILTER MENU*”, and “1.EXPRESS FILTER?”.
3. Press and release ► button twice until display shows “3.DISPOSE”. Press √ button and display shows “DISPOSE?” “YES NO”, or enter code 1, 2, 3, if SP-27 is set to YES.
4. Press √ button; “DRAIN VAT? YES NO” shows in display. Press X button if drain pan has oil in it. Skip to step 9.
5. Press √ button and display shows “OPEN DRAIN”. Pull-out on drain knob to open drain and display shows “DRAINING”. Oil drains from vat into drain pan.
6. Display shows “VAT EMTY “YES NO”. Verify that vat is empty, and press √ button.
7. Display shows “CLEAR OLD OIL FROM OIL LINES” “√ =PUMP” “X= DONE”. Press and hold √ button for a few seconds to clear old oil from lines. Once cleared, press X button.

**3-13.
DISCARDING OIL
FROM VAT USING
OPTIONAL BULK OIL
DISPOSE SYSTEM
(CONT.)**

8. Display shows “CLN VAT COMPLETE” “YES NO”. Once vat is clean, press √ button.
9. Display shows “DISPOSE” and then “√=PUMP” “X=DONE. Press √ button.
10. Display shows “DISPOSING...” “X=STOP” and oil is pumped from drain pan to bulk oil container. When all oil is pumped from pan, press X button (STOP).
11. Display shows “DISPOSE” and then “√=PUMP” “X=DONE. Press X button; display shows “CLOSE DRAIN”. Close drain.
12. Display shows “MANUAL FILL VAT” (or “FILL VAT FROM BULK if equipped), followed by “IS POT FILLED?”, along with “YES NO”. Fill the vat to the lower indicator line on the rear of the vat. See Filling or Adding Oil instructions from Section 3-3.
13. Press √ button and fryer returns to normal operation

**3-14.
DISCARDING OIL
USING OPTIONAL
OIL DISCARD
SHUTTLE-ODS-400**



Figure 1



Figure 2



WITH PROLONGED USE, THE FLASHPOINT OF OIL IS REDUCED. DISCARD OIL IF IT SHOWS SIGNS OF EXCESSIVE SMOKING OR FOAMING. SERIOUS BURNS, PERSONAL INJURY, FIRE, AND/OR PROPERTY DAMAGE COULD RESULT.

1. Open the door, lift-up on the drain pan stop and pull-out the drain pan assembly, using the handle on the drain pan. Figures 1 & 2.
2. Release cover latch, and hinge back cover on oil disposal shuttle. Figure 3. Make sure crumb catcher is in place.



Figure 3

**3-14.
DISCARDING OIL
USING OPTIONAL
OIL DISCARD
SHUTTLE-ODS-400
(CONT.)**



Figure 4

3. Roll oil disposal shuttle under fryer until it stops. Make sure drain aligns with opening in shuttle. Figure 4.



TO AVOID PERSONAL INJURY, BURNS, SPILLS, AND CORROSION:

- **DO NOT OVERFILL. SHUTTLE HOLDS OIL FROM ONE FULL SIZE VAT OR TWO SPLIT VATS ONLY**
- **DO NOT PUT WATER AND/OR CLEANER IN THE SHUTTLE; OIL ONLY**
- **DO NOT TRANSPORT OIL WITHOUT COVER IN PLACE**

4. Press and hold **F** (either one) until display shows “*FILTER MENU*”, along with “1.EXPRESS FILTER?”.
5. Press and release **▶** button twice until display shows “3.DISPOSE”. Press **✓** button and display shows “DISPOSE?” “YES NO”. (If control suspects oil in drain pan “CAUTION IS THERE OIL IN PAN? YES NO” may show in display. Make sure drain pan is empty before proceeding).
6. Press **✓** button and “IS DISPOSAL UNIT IN PLACE? “YES NO” shows in display.
7. With discard shuttle rolled into place (Figure 3), press **✓** button and display shows “OPEN DRAIN”. Pull-out on drain knob to open drain and display shows “DRAINING”. Oil now drains from the vat into the shuttle.
8. Display shows “VAT EMTY “YES NO”. Verify that vat is empty, and press **✓** button.
9. Display shows “CLEAR OLD OIL FROM OIL LINES” “**✓** =PUMP” “X= DONE”. Press and hold **✓** button for a few seconds to clear old oil from lines. Once cleared, press **X** button.
10. Display shows “CLN VAT COMPLETE” “YES NO”. Once vat is clean, press **✓** button and display shows “CLOSE DRAIN”. Push-in on the drain knob.

**3-14.
DISCARDING OIL
USING OPTIONAL
OIL DISCARD
SHUTTLE-ODS-400
(CONT.)**



Figure 5

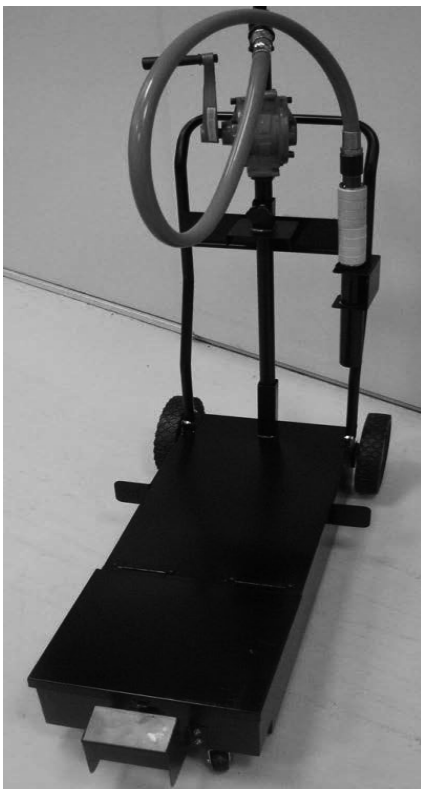

Figure 6

11. Display shows “MANUAL FILL POT”, followed by “IS POT FILLED?”, along with “YES NO”. Fill the vat to the lower indicator line on the rear of the vat and then press ✓ button.
12. Remove the oil disposal shuttle from under fryer and replace with the filter pan assembly.
13. Close and latch the cover and roll oil disposal shuttle to disposal container.
14. Grasp the wooden handle and remove the hose assembly from the holder. Figure 5.
15. Make sure the hose nozzle is pointed into the disposal container and turn pump handle rapidly (fast) in order to prime the pump and to get oil to flow through pump.



Use care to prevent burns caused by splashing of hot shortening.

16. Once shuttle is empty, return the hose assembly to the holder. Figure 6.

**3-15.
DISCARDING OIL
USING OPTIONAL
OIL DISCARD
SHUTTLE-ODS-450**



Figure 1



Figure 2



Figure 3



Figure 4

! DANGER
FIRE HAZARD

WITH PROLONGED USE, THE FLASHPOINT OF OIL IS REDUCED. DISCARD OIL IF IT SHOWS SIGNS OF EXCESSIVE SMOKING OR FOAMING. SERIOUS BURNS, PERSONAL INJURY, FIRE, AND/OR PROPERTY DAMAGE COULD RESULT.

1. Open the door, lift-up on the drain pan stop and pull-out the drain pan assembly, using the handle on the drain pan. Figures 1 & 2.
2. Release cover latch, and hinge back cover on oil disposal shuttle. Figure 3. Make sure crumb catcher is in place.
3. Roll oil disposal shuttle under fryer until it stops. Make sure drain aligns with opening in shuttle. Figure 4.

! DANGER

TO AVOID PERSONAL INJURY, BURNS, SPILLS, AND CORROSION:

- **DO NOT OVERFILL. SHUTTLE HOLDS OIL FROM ONE FULL SIZE VAT OR TWO SPLIT VATS ONLY**
- **DO NOT PUT WATER AND/OR CLEANER IN THE SHUTTLE; OIL ONLY**
- **DO NOT TRANSPORT OIL WITHOUT COVER IN PLACE**

4. Press and hold **F** (either one) until display shows “*FILTER MENU*”, along with “1.EXPRESS FILTER?”.
5. Press and release **▶** button twice until display shows “3.DISPOSE”. Press **✓** button and display shows “DISPOSE?” “YES NO”. (If control suspects oil in drain pan “CAUTION IS THERE OIL IN PAN? YES NO” may show in display. Make sure drain pan is empty before proceeding).

! WARNING

To reduce the risk of fire or electrical shock, do not empty more than one full vat or two split vats at one time.

**3-15.
DISCARDING OIL
USING OPTIONAL
OIL DISCARD
SHUTTLE-ODS-450
(CONT.)**

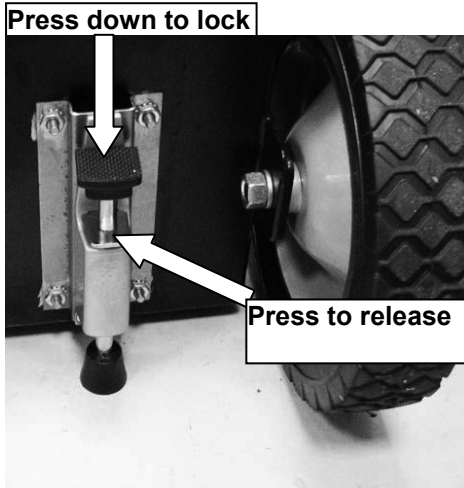

Figure 5



Figure 6

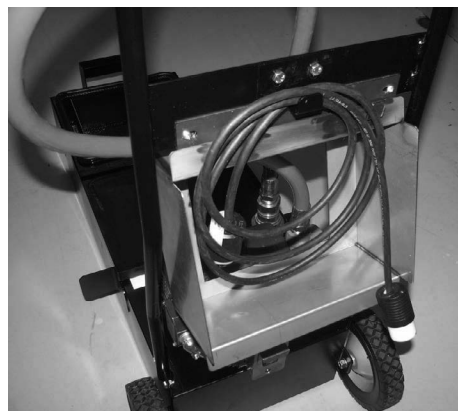

Figure 7



Figure 8

6. Press ✓ button and “IS DISPOSAL UNIT IN PLACE? “YES NO” shows in display.
7. With discard shuttle rolled into place (Figure 3), press ✓ button and display shows “OPEN DRAIN”. Pull-out on drain knob to open drain and display shows “DRAINING”. Oil now drains from the vat into the shuttle.
8. Display shows “VAT EMTY “YES NO”. Verify that vat is empty, and press ✓ button.
9. Display shows “CLEAR OLD OIL FROM OIL LINES” “✓ =PUMP” “X= DONE”. Press and hold ✓ button for a few seconds to clear old oil from lines. Once cleared, press X button.
10. Display shows “CLN VAT COMPLETE” “YES NO”. Once vat is clean, press ✓ button and display shows “CLOSE DRAIN”. Push-in on the drain knob.
11. Display shows “MANUAL FILL POT”, followed by “IS POT FILLED?”, along with “YES NO”. Fill the vat to the lower indicator line on the rear of the vat and then press ✓ button.
12. Remove the oil disposal shuttle from under fryer and replace with the filter pan assembly.
13. Close and latch the cover and roll oil disposal shuttle to disposal container.
14. Press down on top of brake to secure unit in place. Figure 5.
15. Disconnect fitting from top of ODS and connect to disposal container. Figure 6.
16. Using the power cord on the back of the shuttle handle, plug it into the short cord from the junction box. Figures 7 & 8.

17. Turn power switch to the ON position. Figure 8.

**3-15.
DISCARDING OIL
USING OPTIONAL
OIL DISCARD
SHUTTLE-ODS-450
(CONT.)**



Figure 9

18. Plug the shuttle electrical cord into the receptacle under the disposal container control, and then press & hold switch on container controls to pump oil from shuttle to the container. Figure 9

19. Once shuttle is empty, release switch and unplug the electrical cord and wrap back onto the hook on the shuttle handle.



Figure 10

20. Using gloves or protective cloth, disconnect the fitting from the disposal container and connect it back onto the shuttle. Figure 10.



Disconnect fitting could be hot! Use protective cloth or gloves when disconnecting fitting, or severe burns could result.

**3-16.
CHANGING THE
FILTER PAD**



Figure 1



Figure 2

In order to assure good oil pumping performance, the filter pad (or paper) should be changed at least once per day. However, in stores open 24 hours a day, the pad should be changed twice a day.

NOTICE

If filter pad has not been changed, a reminder shows on the display, "CHANGE PAD". Press \checkmark button to cancel the message, but it reappears every 4 minutes until the filter pad has been changed.

1. Make sure the main power switch is in the ON position.
2. Open the door, lift-up on the drain pan stop and pull-out the drain pan assembly, using the handle on the drain pan. Figures 1 & 2.

WARNING
BURN RISK

This pan could be hot! Use protective cloth or glove, or severe burns could result.

If the filter pan is moved while full of oil, use care to prevent splashing, or burns could result.

**3-16.
CHANGING THE
FILTER PAD
(CONT.)**

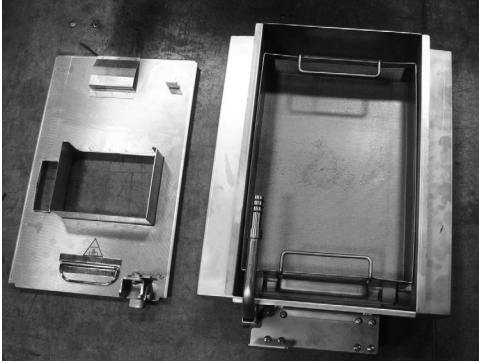

Figure 3

3. Lift the pan cover from the drain pan. Figure 3.

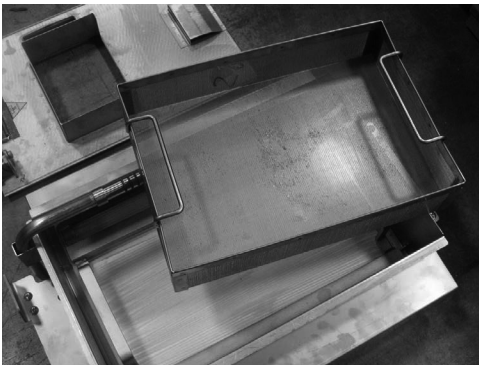

Figure 4

4. Lift the crumb basket from the drain pan. Wipe the oil and crumbs from the crumb basket. Clean the crumb basket with soap and water, then thoroughly rinse with hot water. Figure 4.



Figure 5

5. Remove the filter pad retaining ring and clean thoroughly with soap and water. Rinse thoroughly with hot water. Figure 5.

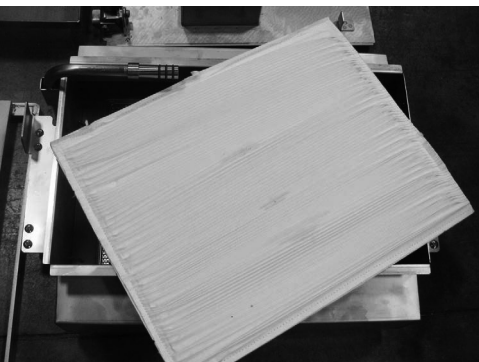

Figure 6

6. Pull the filter pad from the pan and discard pad. Figure 6.

**3-16.
CHANGING THE
FILTER PAD
(CONT.)**

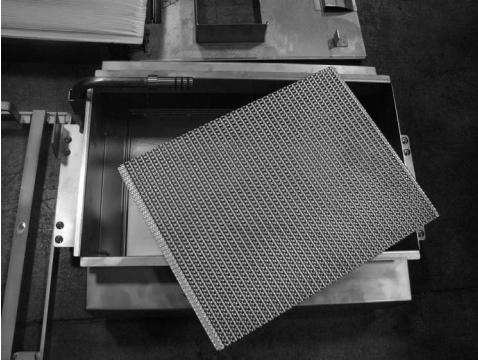

Figure 7



Figure 8



Figure 9

7. Remove the bottom screen from pan and clean thoroughly with soap and water. Rinse thoroughly with hot water. Figure 7.

8. Wipe the oil and crumbs from the drain pan. Clean the drain pan with soap and water, then thoroughly rinse with hot water.

NOTICE

Be sure that drain pan, bottom screen, crumb catcher, and the retaining ring are thoroughly dry before placing filter pad into pan as water will dissolve the filter pad.

9. Reassemble in reverse order, placing the bottom screen into the filter pan first, followed by the filter pad, retaining ring and the crumb catcher.

10. Push the filter pan assembly back underneath the fryer, making sure the filter tube on the pan makes a good connection with the fitting underneath the fryer. Figure 8.

11. Make sure the drain pan stop is engaged and the fryer is now ready for normal operation. Figure 9

**3-17.
REMOVING AND
CLEANING BASKET
REST**



The basket rest, on the rear shroud of the fryer, should be removed and cleaned periodically.



Use protective gloves when removing the basket rest. The basket rest may be hot and burns could result.

1. Grasp basket rest with 2 hands; lift and pull off the studs.
2. Wash rest in a sink with soap and water. Dry thoroughly.
3. Clean the area behind the basket rest and then reinstall it.



The filter drain pan must be as far back under fryer as it will go, and the cover in place. Be sure filter drain pan is latched into place and hole in the cover lines up with the drain before opening drain. Failure to follow these instructions causes splashing of shortening and could result in personal injury.

Moving the fryer or filter drain pan while containing hot shortening is not recommended. Hot shortening can splash out and severe burns could result.

Always wear chemical splash goggles or face shield and protective rubber gloves when cleaning the frypot as the cleaning solution is high in alkaline. Avoid splashing or other contact of the solution with your eyes or skins. Severe burns may result. Carefully read instructions on the cleaner. If solution comes in contact with your eyes rinse thoroughly with cool water and see a physician immediately.

Also, to avoid overfilling drain pan, drain only 1 vat at a time. The drain pan holds 1 full vat, or 2 split vats of oil. Overfilling the drain pan may cause slippery floors which may result in personal injury.

1. Cover adjoining vats to avoid accidentally contaminating oil with fryer cleaning solution.

NOTICE

Do not cook product in adjoining vat when clean-out mode is in progress to avoid contaminating oil and/or product.

**3-18.A
CLEAN-OUT MODE -
MANUAL**



**3-18.A
CLEAN-OUT MODE -
MANUAL
(CONT.)**

2. Press and hold **F** until display shows “1.EXPRESS FILTER?”.
3. Press and release **▶** button several times until display shows “CLEAN-OUT”.
4. Press **√** button; display shows “OIL RMVD” “YES NO”.
5. If oil has already been removed, press **√** button and control skips down to “Solution Added?” step.

If vat still has oil, press X button; display shows “DISPOSE?” “YES NO”. Press **√** button to dispose of the oil, or press X button to exit Clean-Out Mode.

Display shows “IS DISPOSAL UNIT IN PLACE” “YES NO”. If “NO” is selected, display shows “INSERT DISPOSAL UNIT”. Once disposal unit is in place, press **√** button for YES; display shows “OPEN DRAIN”. Open drain, display shows “DRAINING” and oil drains from vat. Display shows “VAT EMTY” “YES NO”. Press **√** button when ready; display shows “CLOSE DRAIN”; close drain.

Bulk Oil Systems Only! Display shows “CHK PAN” if the filter drain pan is missing. Once pan is in place, display shows “OPEN DRAIN”. Pull-out drain knob and display shows “DRAINING” and oil drains from vat. Display then shows “**√**=PUMP” “X=DONE. Press **√** button, display shows “DISPOSING” and oil is pumped from drain pan. Once pan is empty, press X button twice and close drain.

6. Display shows “SOLUTION ADDED?” “YES NO”. Fill vat with hot water to 1 in. (25 mm) above the top fill line, add 4 ozs. (0.12 liters) of open fryer cleaner, and mix thoroughly. Press **√** button and display shows “START CLEAN” “YES NO”.
7. Press **√** button, display shows “CLEANING” and a count-down timer. Heat regulates to 195°F (91°C) for this step for one hour.

Add water as needed during cleaning process to keep solution 1 in. (25 mm) above the top fill line.

To stop cleaning cycle early, press X button; display shows “QUIT CLEANING” “YES NO”. Press **√** button to cancel the rest of countdown time and proceed to the rinse steps.

8. Using the open fryer brush (never use steel wool), scrub the inside of the vat. At the end of the one hour, display shows “CLN DONE” and beeps. Press **√** button and display shows “REMOVE SOLUTION FROM VAT”.

**3-18.A
CLEAN-OUT MODE -
MANUAL
(CONT.)**

9. Empty filter drain pan of internal filtering components and move components to a sink to be cleaned. Return empty filter drain pan and cover to fryer, making sure it is pushed securely into place and the latch fully engaged.
10. Pull-out drain knob and drain half the vat contents into filter drain pan. Remove drain pan from unit and dispose of cleaning solution.



To avoid burns when pouring hot solution, wear gloves and protective gear and take care to avoid splashing.

11. Return empty filter drain pan to fryer and press $\sqrt{\quad}$ button. Display then shows “VAT EMTY” “YES NO”.
12. Once vat is empty, press $\sqrt{\quad}$ button and display shows “SCRUB VAT COMPLETE” “YES NO”. Use brush and scour pad to clean vat, if needed.



Do not use steel wool, other abrasive cleaners, or cleaners/ sanitizers containing chlorine, bromine, iodine, or ammonia chemicals as these will deteriorate the stainless steel material and shorten the life of the unit.

Do not use a water jet (pressure sprayer) to clean unit or component damage could result.

13. Once vat is clean, press the $\sqrt{\quad}$ button and display shows “RINSE VAT”. (If drain is not open, display shows “OPEN DRAIN” Open the drain.)
14. Pour clean water and approximately 8 ozs. (0.24 liters) of distilled vinegar solution into vat to rinse vat and allow rinse water to drain into drain pan. Rinse at least 3 times, but be careful not to overfill the drain pan. Display now shows “RINSE COMPLETE” “YES NO”
15. Once vat is completely rinsed, press the $\sqrt{\quad}$ button and display shows “CLEAR SOLUTION FROM OIL LINES” “ $\sqrt{\quad}$ =PUMP” “X=DONE”.

To make sure no cleaning solution remains in the oil lines, press and hold $\sqrt{\quad}$ button for a few seconds. Once lines are clear, press X button and display shows VAT DRY?” “YES NO”. Press $\sqrt{\quad}$ button and display shows “CLOSE DRAIN”. Push drain knob in to close drain. Controls return to normal operation.

**3-18.A
CLEAN-OUT MODE -
MANUAL
(CONT.)**

16. Pull drain pan from under fryer and dispose of rinse water.
17. Thoroughly dry the vat with a towel, and then press the $\sqrt{\quad}$ button. Controls return to normal operations.
18. Make sure drain is closed.

CAUTION

Make sure the inside of the vat, the drain valve opening, and all the parts that come in contact with the new oil are as dry as possible.

19. Clean and thoroughly dry the filter pan assembly and return, with new filter pad, to the fryer. Fill vat with oil following the Filling or Adding Oil instructions from Section 3-3.

**3-18.B
CLEAN-OUT MODE -
SMART TOUCH**

**WARNING
BURN RISK**

The filter drain pan must be as far back under fryer as it will go, and the cover in place. Be sure filter drain pan is latched into place and hole in the cover lines up with the drain before opening drain. Failure to follow these instructions causes splashing of shortening and could result in personal injury.

Moving the fryer or filter drain pan while containing hot shortening is not recommended. Hot shortening can splash out and severe burns could result.

Always wear chemical splash goggles or face shield and protective rubber gloves when cleaning the frypot as the cleaning solution is high in alkaline. Avoid splashing or other contact of the solution with your eyes or skins. Severe burns may result. Carefully read instructions on the cleaner. If solution comes in contact with your eyes rinse thoroughly with cool water and see a physician immediately.

Also, to avoid overfilling drain pan, drain only 1 vat at a time. The drain pan holds 1 full vat, or 2 split vats of oil. Overfilling the drain pan may cause slippery floors which may result in personal injury.

1. Cover adjoining vats to avoid accidentally contaminating oil with fryer cleaning solution.

NOTICE

Do not cook product in adjoining vat when clean-out mode is in progress to avoid contaminating oil and/or product.



**3-18.B
CLEAN-OUT MODE -
SMART TOUCH
(CONT.)**

2. Press and hold **F** until display shows “1.EXPRESS FILTER?”.
3. Press and release **▶** button several times until display shows “CLEAN-OUT”.
4. Press **√** button; display shows “OIL RMVD” “YES NO”.
5. If oil has already been removed, press **√** button and control skips down to “Solution Added?” step.

If vat still has oil, press X button; display shows “DISPOSE?” “YES NO”. Press **√** button to dispose of the oil, or press X button to exit Clean-Out Mode.

Display shows “IS DISPOSAL UNIT IN PLACE” “YES NO”. If “NO” is selected, display shows “INSERT DISPOSAL UNIT”. Once disposal unit is in place, press **√** button for YES; the drain will open automatically and display shows “DRAINING” and oil drains from vat. Display shows “VAT EMTY” “YES NO”. Press **√** button when ready.

Bulk Oil Systems Only! Display shows “CHK PAN” if the filter drain pan is missing. Once pan is in place, the drain will open automatically and display will show “DRAINING” and oil drains from vat. Display then shows “**√**=PUMP” “X=DONE. Press **√** button, display shows “DISPOSING” and oil is pumped from drain pan. Once pan is empty, press X button twice and close drain.

6. Display shows “SOLUTION ADDED?” “YES NO”. Fill vat with hot water to 1 in. (25 mm) above the top fill line, add 4 ozs. (0.12 liters) of open fryer cleaner, and mix thoroughly. Press **√** button and display shows “START CLEAN” “YES NO”.
7. Remove the disposal shuttle and empty filter drain pan of internal filtering components and move components to a sink to be cleaned. Return empty filter drain pan and cover to fryer, making sure it is pushed securely into place and the latch fully engaged.
8. Press **√** button, display shows “CLEANING” and a count-down timer. Heat regulates to 195°F (91°C) for this step for one hour.

Add water as needed during cleaning process to keep solution 1 in. (25 mm) above the top fill line.

To stop cleaning cycle early, press X button; display shows “QUIT CLEANING” “YES NO”. Press **√** button to cancel the rest of countdown time and proceed to the rinse steps.

**3-18.B
CLEAN-OUT MODE -
SMART TOUCH
(CONT.)**

9. Using a 1/2 gal. (2 liter) stainless steel pitcher, remove the solution from the vat, pouring it into a heat-resistant pail for disposal. Any remaining solution can be drained into the drain pan for disposal
10. Using the open fryer brush (never use steel wool), scrub the inside of the vat. At the end of the one hour, display shows "CLN DONE" and beeps. Press √ button and display shows "REMOVE SOLUTION FROM VAT".



To avoid burns when pouring hot solution, wear gloves and protective gear and take care to avoid splashing.

11. Return empty filter drain pan to fryer and press √ button. Display then shows "VAT EMTY" "YES NO".
12. Once vat is empty, press √ button and display shows "SCRUB VAT COMPLETE" "YES NO". Use brush and scour pad to clean vat, if needed. The drain will open automatically.



Do not use steel wool, other abrasive cleaners, or cleaners/ sanitizers containing chlorine, bromine, iodine, or ammonia chemicals as these will deteriorate the stainless steel material and shorten the life of the unit.

Do not use a water jet (pressure sprayer) to clean unit or component damage could result.

13. Once vat is clean, press the √ button and display shows "RINSE VAT".
14. Pour clean water and approximately 8 ozs. (0.24 liters) of distilled vinegar solution into vat to rinse vat and allow rinse water to drain into drain pan. Rinse at least 3 times, but be careful not to overfill the drain pan. Display now shows "RINSE COMPLETE" "YES NO"
15. Once vat is completely rinsed, press the √ button and display shows "CLEAR SOLUTION FROM OIL LINES" "√=PUMP" "X=DONE".

To make sure no cleaning solution remains in the oil lines, press and hold √ button for a few seconds. Once lines are clear, press X button and display shows "VAT DRY?" "YES NO". Press √ button and the drain closes.

**3-18.B
CLEAN-OUT MODE -
SMART TOUCH
(CONT.)**

16. Thoroughly dry the vat with a towel, and then press the \checkmark button. Controls return to normal operations.
17. Make sure drain is closed.

CAUTION

Make sure the inside of the vat, the drain valve opening, and all the parts that come in contact with the new oil are as dry as possible.

18. Clean and thoroughly dry the filter pan assembly and return, with new filter pad, to the fryer. Fill vat with oil following the Filling or Adding Oil instructions from Section 3-3.

**3-19.
CHECK/REPLACE
FILTER DRAIN PAN
O-RINGS**



Figure 1



Figure 2



Figure 3



Figure 4

To prevent oil leaking, and to keep filtering process operating properly, the filter drain pan o-rings should be inspected for nicks and tears at least every 3 months. Figure 1

1. Open the door, lift-up on the drain pan stop and pull-out the filter drain pan assembly, using the handle on the drain pan. Figures 2 & 3

**WARNING
BURN RISK**

This pan could be hot! Use protective cloth or glove, or severe burns could result.

2. Visually check 3 o-rings on filter drain pan tube for any cracks or breaks and replace, if necessary. Figure 1.
3. To replace o-ring, use a small, flat-bladed screwdriver, pry up on the o-ring and pull off of end of tube. Roll new o-ring into notch on tube. Before pushing the filter drain pan back into position, lubricate the o-rings on the filter tube with fresh, cold oil. Figure 4.

**3-20.
INFO BUTTON
STATS**

Actual Oil Temperature

1. Press **i** and the actual oil temperature shows in the display, for each vat.

Set-point Temperature

2. Press **i** twice and SP shows in the display, along with the set-point (preset) temperature of each vat.

Recovery Information for each Vat

3. Press **i** 3 times and REC shows in the left display and the recovery time that oil temperature went from 250°F (121°C) to 300°F (149°C) shows in the right display.

For example,

REC	5:30
-----	------

 means it took 5 minutes

and 30 seconds for the oil temperature to recover to 300°F (149°C) from 250°F (121°C).

NOTICE

If no buttons are pressed within 5 seconds in any of stats modes, the controls revert back to normal operation.

**3-21.
FILTER BUTTON
STATS**

Cook Cycles Remaining before Filtering

1. Press and release either **F** button and the left display shows “COOKS REMAIN” and the right display hows the number of cook cycles before the next auto filter.

For example,

REMA	IN
------	----

 ,

3	6
---	---

 means

after 3 more cook cycles on the left vat, the controls asks the operator if they are ready to filter or not. But, 6 more cook cycles remain on the right vat.

Time and Date

2. Press either **F** button twice and “FILTERED” shows in the displays followed by the time-of-day and the date of the last filter.

3. Press either **F** button three times and “FLTR PAD” “XX HOURS” shows in displays to indicate the number of hours the existing filter has been used.

**3-22.
PREVENTIVE
MAINTENANCE
SCHEDULE**

As in all food service equipment, the Henny Penny open fryer does require care and proper maintenance. The table below provides a summary of scheduled maintenance procedures to be performed by the operator.

<u>Procedure</u>	<u>Frequency</u>
Filtering of shortening	Daily
Changing the filter pad	Daily
Lubricate filter pan o-rings	Every filter pad change
Changing of oil	When oil smokes, foams up violently, or tastes bad
Cleaning the vat	Every change of oil
Inspect filter pan o-rings	Quarterly
Clean blower & vents	Semi-Annually

**3-23.
CLEAN BLOWER &
VENTS**



Figure 1



Figure 2



Figure 3



Figure 4

To ensure proper burner operation, clean the blowers and blower vents twice a year.

1. Press the main power switch to the OFF position.
2. Unplug power cord and turn gas shut-off handle clockwise to turn off the gas, and then disconnect the gas line.
3. Disconnect cable restraint and then carefully roll the fryer from the hood far enough to get behind the fryer.



To avoid burns, use care when moving the fryer to prevent hot cooking oil from splashing.

4. Using a cloth or paper towel, clean the blower intake slots to ensure sufficient air flow to the blowers. Figure 1.
5. Using a Phillip's-Head screwdriver, remove lower, rear panel. Figure 2.
6. Using a cloth or paper towel, clean each blower opening. Figure 3.
7. Clean the vent slots on the inside of rear panel, and then replace panel. Figure 4.
8. Reattach the gas line and turn the shut-off handle counter-clockwise to turn on the gas and reconnect the cable restraint to the fryer.
9. Reattach the plug to electrical receptacle and roll fryer back into place.

SECTION 4: INFORMATION MODE

This historic information can be recorded and used for operational and technical help and allows you to view the following:



- 1. E-LOG
- 2. LAST LOAD
- 3. DAILY STATS
- 4. OIL STATS
- 5. REVIEW USAGE
- 6. INPUTS
- 7. OUTPUTS
- 8. OIL TEMP
- 9. CPU TEMP
- 10. COMMUNICATION INFO
- 11. ANALOG INFO
- 12. ACTIVITY LOG
- 13. OIL LEVELS
- 14. PUMP VALVE INFO
- 15. AIF INFO
- 16. USB SUPPORT

NOTICE

Not all Information Mode functions are discussed in this section. To ensure proper operation of fryer, please consult Henny Penny Corp. before changing any of these settings. For more information on these functions, contact Technical Support at 1-800-417- 8405, or 1-937-456-8405.

4-1. INFORMATION MODE DETAILS

1. E-LOG (error code log)

Press  and  buttons at the same time and “*INFO MODE*” shows in the display, followed by “1. E-LOG”.

Press  and  to exit Information Mode at any time.

Press  and “A. (date & time) *NOW* show in displays. This is the present date and time.

Press  and if an error was recorded, “B. (date, time, and error code information)” shows in display. This is the latest error code that the controls recorded. Sometimes the characters “L.” and “R.” appear in front of the error code on the display which refers to the left or right vat of a split vat.

Press  and the next latest error code information can be seen.

Up to 10 error codes (B to K) can be stored in the E-LOG section.

**4-1.
INFORMATION MODE
DETAILS
(CONT.)**

2. LAST LOAD (Information on recent cook cycles)

Press **▶** and “2. LAST LOAD” show in displays.

Press **1** or **2** button for the product for which you want to view the cook data and the LED flashes.

Press **▼** button to start viewing the cook data.

For example, if left **1** button LED is flashing, “PRODUCT FRY L1” show in displays.

If right **2** button LED is flashing, “PRODUCT FRY R2” show in displays.

Press **▼** button to start viewing the cook data.

FUNCTION	DISPLAY EX:
Product (Last product cooked)	PRODUCT FRY L1
Time of day last Cook Cycle was started	STARTED FEB-04 2:25P
Actual Elapsed cook Time (Real seconds)	ACTUAL TIME 1:06
Programmed cook Time	PROG TIME 1:00
Max Temp during Cook Cycle	MAX TEMP 350°F
Min Temp during Cook Cycle	MIN TEMP 313°F
Avg Temp during Cook Cycle	AVG TEMP 322°F
Heat On (percentage) during Cook Cycle	HEAT ON 45%
Ready? (Was fryer Ready before start?)	READY? YES
When Cook Cycle was stopped: Early	QUIT AT 0:10 REM
After complete Cook Cycle	OR *DONE* +6 SEC
Difference (%) between actual and programmed cook time	ACT/PROG 1%

**4-1.
INFORMATION MODE
DETAILS
(CONT.)**

3. DAILY STATS (Operational info of fryer for last 7 days)

Press ► and “3. DAILY STATS” show in displays.

Press ▼ button to start viewing the cook data.

Press the right  button to view data for other days of week.

FUNCTION

DISPLAY EX:

Day this data was recorded for	APR-30	TUE ----
Number of Hours:Minutes the fryer was on	(L/R) ON HRS	TUE 3:45
Number of times filtered	(L/R) FILTERED	TUE 4
Number of times filter skipped	(L/R) SKIPPED	TUE 4
Number of times oil added	(L/R) ADD OIL	TUE 4
Number of times oil discarded	(L/R) DISPOSE	TUE 0
Oil temperature recovery time	(L/R) RECOVERY	TUE 1:45
Total number of cook cycles that day	(L/R) TOT CK	TUE 38
Number of cycles stopped before *DONE*	QUIT CK	TUE 2
Cook Cycles for Product #1	COOK -1-	TUE 17
Cook Cycles for Product #2	COOK -2-	TUE 9
Cook Cycles for Product #3	COOK -3-	TUE 5
Cook Cycles for Product #4	COOK -4-	TUE 0
Cook Cycles for Product #5	COOK -5-	TUE 0
Cook Cycles for Product #6	COOK -6-	TUE 6
Cook Cycles for Product #7	COOK -7-	TUE 0
Cook Cycles for Product #8	COOK -8-	TUE 0
Cook Cycles for Product #9	COOK -9-	TUE 1
Cook Cycles for Product #0	COOK -0-	TUE 0

**4-1.
INFORMATION MODE
DETAILS
(CONT.)**

4. OIL STATS (info of current oil and avg. of last 4 batches of oil)

Press ► and “4. OIL STATS” show in displays.

Press ▼ button to start viewing the cook data.

FUNCTION	DISPLAY EX:
Start date of new oil	(L/R) NEW OIL MAR-23
Number of days oil in use	(L/R) OIL USE 4 DAYS
Number of filters on this oil	(L/R) FILTERED 4
Number of times filter skipped	(L/R) SKIPPED 0
Number of cook cycles on this oil	(L/R) TOT CK 38
Average number of days per oil change	(L/R) AVG DAYS PER OIL CHANGE 13.8 DAYS
Average number cook cycles per oil change	(L/R) AVG CKS PER OIL CHANGE 388 CKS

Press and hold a product button (1 to 4) to view the data for the Average number of days per oil change and the Average number of cook cycles per oil change from one of the previous 4 batches of oil used.

Press  to view oldest oil data: Ex: OIL-4 14 DAYS

Press  to view 3rd oldest oil data: Ex: OIL-3 12 DAYS

Press  to view 2nd oldest oil data: Ex: OIL-2 15 DAYS

Press  to view previous batch of oil: Ex: OIL-1 13 DAYS

**4-1.
INFORMATION MODE
DETAILS
(CONT.)**

5. REVIEW USAGE(accumulated info since the data was reset)

Press ► and “4. REVIEW USAGE” show in displays.

Press ▼ button to start viewing the cook data.

FUNCTION	DISPLAY EX:
Day the usage data was previously reset	SINCE APR-19 2011
Number of Hours the fryer was on	(L/R) ON HRS 4
Number of times filtered	(L/R) FILTERED 4
Number of times filter skipped	(L/R) SKIPPED 0
Number of times oil added	(L/R) ADD OIL 4
Number of times oil discarded	(L/R) DISPOSE 1
Total number of cook cycles	(L/R) TOT CK 38
Number of cycles stopped before *DONE*	QUIT CK 2
Cook Cycles for Product #1	COOK -1- 17
Cook Cycles for Product #2	COOK -2- 9
Cook Cycles for Product #3	COOK -3- 5
Cook Cycles for Product #4	COOK -4- 0
Cook Cycles for Product #5	COOK -5- 0
Cook Cycles for Product #6	COOK -6- 6
Cook Cycles for Product #7	COOK -7- 0
Cook Cycles for Product #8	COOK -8- 0
Cook Cycles for Product #9	COOK -9- 1
Cook Cycles for Product #0	COOK -0- 0
Reset usage data: Enter the Usage Code - 1, 2, 3 on this step to zero out all the usage information	RESET USAGE / ENTER CODE -----

16. USB SUPPORT

1. Press the ▼ button and display shows “REPORTS/(type of report) PRINT”

This will print the type of report chosen. To select a report, press √.

2. Press the ▼ button and “READ SP FROM USB”.

This will upload the product set points from a specific file on the USB stick. To select set points, press the √.

3. Press the ▼ button and the display shows “REMOVE USB?”.

This will indicate when it is safe to remove the USB stick.

4. Press the ▼ button and display will show “SAVE SP TO USB”.

This will download the product set points from memory and save them to the USB stick.

SECTION 5: PRODUCT PROGRAM MODE

This mode allows you to program the following:

- Change Product Name
- Assign Button
- Change Times & Temp
- Change Cook ID
- Alarms
- Quality Timers
- Include in Filter Count (Global)
- Filter at X no. of loads (Mixed)
- Load Compensation
- Load Compensation Reference
- Full Heat
- PC Factor

5-1. MODIFYING PRODUCT SETTINGS

1. Press and hold  button until “PROG” shows in the display, followed by “ENTER CODE”.
2. Enter code 1, 2, 3 (first 3 product buttons). “PRODUCT” and “PROGRAM” show in the displays, followed by “SELECT PRODUCT” and “-P 1-” (ex: NUG).

Change Product Names

3. Use the ▲ and ▼ buttons to scroll through the 40 products, or press the desired product button.
4. Press ► button and “NAME” shows in the left display and the product (ex: NUGGETS) shows in the right display.
5. Press √ button and the first letter in the name flashes. Press a product button and the flashing letter changes to the first letter under the product button that was pressed. For example, if  is pressed, the flashing letter changes to an “A”.

Press the same button again and the flashing letter changes to a “B”. Press it again and flashing letter changes to a “C”. Once the desired letter shows in display, press ► button to continue to next letter and repeat the procedure.

Press and hold the right X button to exit Program Mode, or press ► button to continue on to “COOK TIME”.

Assign Button

6. Press ► button until “ASSIGN BTN” shows in the display, along with the product (ex: NUGGETS). If this product already has a product button assigned to it, that LED will be lit. To assign other product buttons to that product, press and hold the product button for 3 seconds and that LED stays lit. To remove a product from a button, press and hold the product button with a lit LED and the LED goes out.

**5-1.
MODIFYING
PRODUCT SETTINGS
(CONT.)**

To Change Times and Temperatures

7. Press ► button until “COOK TIME” shows in the display, and then use the product buttons, or the ▲ and ▼ buttons, to change the time in minutes and seconds, to a maximum of 59:59.
8. Press ► button and “TEMP” shows in the display, along with the preset temperature on the right side of the display.

Press the product buttons, or the ▲ and ▼ buttons, to change the temperature. The temperature range is 190°F (88°C) to 375°F (191°C).

Cook ID Change

9. Press ► button until “COOK ID” shows in the display along with the product ID. For example, NUG would be the ID for nuggets. Use the product buttons, or the ▲ and ▼ buttons, to change the ID.

Alarms (1 & 2)

10. Press ► button until “ALRM 1” shows in the left display, and an alarm time in the right display. Press the product buttons, or the ▲ and ▼ buttons, to set an alarm.

Ex., If a Cook Cycle was set at 3 minutes, and an alarm was to go off after 30 seconds into the Cook Cycle, “2:30” would be set in the display at this time. When the timer counts down to 2:30 the alarm sounds.

After alarm time is set, press ▲ button and “ALRM 2” shows in display, and a second alarm can be programmed.

Quality Timer (hold time)

11. Press ▲ button until “QUAL TMR” shows in the display along with the preset holding time. Press the product buttons, or the ▲ and ▼ buttons, to adjust holding time, up to 2 hours:59 minutes.

Global Filter Tracking

Include in Filter Count

12. A. Press ► button until “INCL IN FLTR CNT” flashes in display along with “YES” or “NO”. Using ▲ and ▼ buttons, change the display to “YES” if that product’s Cook Cycles are to be counted as part of the recommended filter process. Set to “NO” if it is not to be included.

Mixed Filter Tracking

Filter After X Number of Loads

12. B. Press ► button until “FILTER AFTER...” flashes in the left display along, and the number of cook cycles between filters shows in the right display. Press the product buttons, or the ▲ and ▼ buttons, to change this value of 0 to 99 loads. This needs set for each product.

**5-1.
MODIFYING
PRODUCT SETTINGS
(CONT.)**

>Load Compensation, Load Compensation Reference, Full Heat, PC Factor<

13. Press ► button until “LD COMP” shows in the display, along with the load compensation value. This automatically adjusts the time to account for the size and temperature of the cooking load. Press the product buttons, or the ▲ and ▼ buttons, to change this value of 0 to 20.

14. Press ► button until “LCMP REF” shows in the display along with the load compensation average temperature. (if load compensation is set to “OFF”, then “_ _ _” shows in display and setting cannot be programmed) This is the average cooking temperature for each product. The timer speeds up at temperatures above this setting and slows down at temperatures below this setting. Press the product button, or the ▲ and ▼ buttons, to change this value.

15. Press ► button until “FULL HT” shows in the display along with the full heat value in seconds, which means the heat is on as soon as a timer button is pressed, for the programmed length of time. Press the product buttons, or the ▲ and ▲ buttons, to change this value of 0 to 90 seconds.

16. Press ► button until “PC FACTR” shows in the display along with the proportional temperature, which helps to keep the oil from over-shooting the setpoint temperature. Press the product buttons, or the ▲ and ▼ buttons, to change this value of 0 to 50 degrees.

NOTICE

- Use ◀ button to go back to previous menu items.
- Press the ► button when finished with the current product, return to the “SELECT PRODUCT” step.
- Press and hold **P** button to exit PRODUCT PROGRAM Mode.

SECTION 6: LEVEL 2 PROGRAMMING

6-1. SPECIAL PROGRAM MODE

The Special Program Mode is used to set more detailed programming, such as:

Used to access the following:

- Special Program Mode
- Clock Set
- Data Communication
- Heat Control
- Tech Mode
- Stats
- Filter Control

- SP-1** • Degrees Fahrenheit or Celsius
- SP-2** • Language: English, Greek, Russian, Swedish, German, Portuguese, Spanish, and French
- SP-3** • System Initialization (Factory Presets)
- SP-4** • Audio Volume
- SP-5** • Audio Tone
- SP-6** • Melt Cycle Select - 1.LIQUID; 2.SOLID
- SP-7** • Idle Mode Enabled - YES or NO
- SP-7A** • Use “0” for IDLE
- SP-7B** • Auto Idle Minutes
- SP-7C** • Idle Set-point Temperature
- SP-8** • Filter Tracking Mode - 1.MIXED or 2.GLOBAL
- SP-8A** • Suggest Filter At... - 75% to 100% (MIXED)
- SP-8B** • Filter Lockout Enabled? - YES or NO (MIXED)
- SP-8A** • Left Vat Filter Cycles - 0 to 99 (**GLOBAL**)
- SP-8B** • Right Vat Filter Cycles - 0 to 99 (**GLOBAL**)
- SP-8C** • Filter Lockout Enabled? - YES or NO (**GLOBAL**)
- SP-9** • Polish Duration - X:XX M:SS
- SP-10** • Change Pad Reminder Time - XX HRS
- SP-11** • Clean-Out Time - XX MIN
- SP-12** • Clean-Out Temperature - XXX °F or C
- SP-13** • Cooking User IO - After Cook Cycle, display shows previous menu item or “---”
- SP-14** • Number of Baskets - 2-BASKETS or 4 BASKETS
- SP-15** • Show Cooking Indicator - YES or NO
- SP-16** • 2nd Language: Greek, Russian, Swedish, German, Portuguese, Spanish, and French
- SP-17** • 2nd AudioVolume
- SP-18** • Energy Save Enabled? - YES or NO
- SP-19** • Fryer Type - GAS or ELECTRIC
- SP-20** • Vat Type - SPLIT or FULL
- SP-21** • Autolift Enabled? - NO LIFT or YES LIFT
- SP-22** • Bulk Oil Supply? - YES SUPL or NO SUPL
- SP-23** • Bulk Oil Dispose? - YES DISP or NO DISP
- SP-24** • Serial No. of Fryer
- SP-25** • Change Mgr. Code- 1 = YES
- SP-26** • Change Usage Code - 1 = YES
- SP-27** • Dispose Requires Code ? - YES or NO
- SP-28** • Longer Fill Time Enabled - YES or NO
- SP-29** • Let User Exit Fill? - YES or NO
- SP-30** • Skip ‘SKIM’ Prompt? - YES or NO
- SP-31** • 2-Stage Wash Enabled? - YES or NO

**6-1.
SPECIAL PROGRAM
MODE
(CONT.)**

Press and hold the **P** button for 5 seconds until “LEVEL 2” followed by, “SP PROG” and “ENTER CODE” show in the display.

Enter code 1,2,3, and “SP-1 TEMP FORMAT” flashes in the displays.

NOTICE

If a bad code is entered, a tone sounds and “BAD CODE” shows on the display. Wait a few seconds, the controls revert back to the cook mode, and repeat the above steps.

To exit from the Special Program Mode at any time, press and hold **P** button for 2 seconds.

Degrees Fahrenheit or Celsius (SP-1)

The left display flashes “SP-1 TEMP FORMAT”. Press the ▲ or ▼ buttons to choose °F or °C.

NOTICE

- Use ◀ button to go back to previous menu items
- Press ▶ button when finished with the current Level 2 step

Language (SP-2)

- Press ▶ button and “SP-2 LANGUAGE” flashes on the left display. Press the ▲ or ▼ buttons to select the desired language.

System Initialization (SP-3)

- Press ▶ button and “SP-3 DO SYSTEM INIT” flashes in left display, along with “INIT” in right display. To reset the controls to factory default settings, press and hold √ button and control counts down “IN 3”, “IN2”, “IN 1”. Once display shows “-INIT-” & *DONE* the controls are reset to factory defaults.

Audio Volume (SP-4)

- Press ▶ button and “SP-4 VOLUME” flashes in the left display. Press the ▲ or ▼ , or use product buttons, to adjust the volume of the speaker, 10 being the maximum value and 1 the minimum.

Audio Tone (SP-5)

- Press ▶ button and “SP-5” and “TONE” flash in the left display. Press the ▲ or ▼ , or use product buttons, to adjust the tone of the speaker, 2000 being the maximum value and 50 the minimum.

**6-1.
SPECIAL PROGRAM
MODE
(CONT.)**

Liquid or Solid Cooking Oil Used (SP-6)

- Press ► button until “SP-6 MELT CYCLE SELECT” scrolls in the left display. Unless solid oil is being used in the vats the right display should show “1.LIQUID”.
- If solid oil is used, the unit **MUST BE** equipped to handle solid oil. Use the ▲ and ▼ buttons to change the right display to “2.SOLID”

Idle Mode Enabled (SP-7)

An Idle Mode allows the oil temperature to drop to a lower temperature when not in use. This saves on oil and utilities.

- Press ► button and “SP-7 IDLE MODE ENABLED?” flashes in the left display. Press the ▲ or ▼ buttons to choose YES” or “NO”.
- With “YES” in the display, press ► button and “SP-7A USE ‘0’ FOR IDLE” flashes on the left display. Press the ▲ or ▼ buttons to select “YES” or “NO”. If “YES” is selected, an Idle Mode can be programmed in product button .
- Press ▼ button and “SP-7B AUTOIDLE MINUTES” flashes in the left display. Press the ▲ or ▼, or use product buttons, to set the time (0 to 60 minutes) fryer stays idle before the auto-idle is enabled.
- Ex., “30” means, if product is not cooked in that vat for 30 minutes, the control automatically cools the oil down to the idle setpoint temperature
- Press ► button and “SP-7C IDLE SETPT” flashes in the left display. Press the ▲ or ▼, or use product buttons, to set the idle temperature 200° to 375 °F (93 to 191 °C).

Filter Tracking Mode (SP-8)

Filter Tracking signals the operator when the oil needs filtering by counting the number Cook Cycles between filters

- Press ► button and “SP-8” and “FILTER TRACKING MODE” flash in the display. Use the ▲ and ▼ buttons to choose either “1.MIXED” filter tracking or “2.GLOBAL”.

NOTICE

GLOBAL means all the products have the same number of cook cycles between filters.

MIXED means each product may be set with different number of cook cycles between filters. The controls adds the cycle counts (see example at left) and when the counts equal 1 or greater, filtering is suggested. Ex: 1 load of fish, 2 loads of french fries, a load of chicken equals 1. $1/2 + 1/8 + 1/8 + 1/4 = 1$.

Product	No. Cook Cycles	Cycle Count
Fish	2	1/2
French Fries	8	1/8
Chicken	4	1/4

**6-1.
SPECIAL PROGRAM
MODE
(CONT.)**

MIXED

- If MIXED is selected, press ► button and “SP-8A” and “SUGGEST FILTER AT ...” flash in the left display, and a value between 75% and 100% shows on the right display. Press the ▲ and ▼ buttons to change this value.
- The lower the value, the sooner the control recommends to filter.
Ex: If set to 75%, the control suggest filtering after 3/4 of the programmed cook cycles is met, whereas at 100%, all the cook cycles must be completed before the control suggest filtering.
- Press ► and “SP-8B” and “LOCKOUT ENABLED?” flash in the left display. Press the ▲ and ▼ buttons to choose YES or NO.
- If set to YES, when controls suggest filtering, “FILTER LOCKOUT”/”YOU *MUST* FILTER NOW”, shows in the display, and it refuses further cook cycles until the vat is filtered.
- Press ► and “SP-8C” and “LOCKOUT AT...” flash in the left display and a value between 100% and 250% shows on the right display. Press the ▲ and ▼ buttons to change this value. The lower the value, the sooner the “lockout” occurs.
- Ex: If set at 100%, “lockout” occurs when the cycle counts reaches 1 or greater. Set at 200%, twice as many cycles are counted before “lockout” occurs. See example above.

GLOBAL

- If GLOBAL is selected, press ► button.

Full Vat

- If unit is a full vat, “SP-8A FULL VAT FILTER CYCLES” flashes in the left display, and the number of cook cycles between filters shows on the right display (0 to 99). Use ▲ and ▼ to change this number, or product buttons.
- Press ► button and “SP-8B LOCKOUT ENABLED?” flashes in the left display. Press the ▲ and ▼ buttons to choose YES or NO.
- If set to YES, press ► button and the left display flashes “SP-8C FULL VAT LOCKOUT CYCLES” and the number of cook cycles before filter lock-out shows on the right display (0 to 99). Use ▲ and ▼ to change this number, or product buttons.
- Once this number of cook cycles is reached, “FILTER LOCKOUT”/”YOU *MUST* FILTER NOW”, shows in the display, and it refuses further cook cycles until the vat is filtered.

**6-1.
SPECIAL PROGRAM
MODE
(CONT.)**

Polish Duration (SP-9)

- Press ► button and “SP-9 POLISH TIME” flashes in the left display. Press the ▲ or ▼ , or use product buttons, to change polish time, from 0 to 10 minutes.

Change Filter Pad Reminder Time (SP-10)

- Press ► button and “SP-10 CHANGE PAD’ REMINDER” flashes in the left display. Press the ▲ or ▼ , or use product buttons, to change the time from 0 to 100 hours.

Clean-Out Time (SP-11)

- Press ► button and “SP-11 CLEAN-OUT TIME” flashes in left display. Press the ▲ or ▼ , or use product buttons, to change the time from 0 to 99 minutes.

Clean-Out Temperature (SP-12)

- Press ► button and “SP-12 CLEAN-OUT TEMP” flashes in the left display. Press the ▲ or ▼ , or use product buttons, to change the temperature from 0 to 195° F (90° C).

Cooking User IO (SP-13)

- Press ► button and “SP-13 COOKING USER IO” flashes in the display. Press the ▲ or ▼ buttons to choose “SHOWPREV” or “SHOW----”.
- Setting SP-13 to SHOWPREV means after a cook cycle the display shows the last menu item cooked. SHOW----means after a cook cycle “----” shows in the display and a menu item needs selected before starting the next cook cycle.

Number of Baskets (SP-14)

- Press ► button and “SP-14 NUMBER OF BASKETS” flashes in the left display. Press the ▲ or ▼ buttons to choose 2 or 4 baskets per well.

Cooking Indicator (SP-15)

- Press ► button and “SP-15 SHOW COOKING INDICATR” flashes in the left display. Press the ▲ or ▼ buttons to choose YES, and during a cook cycle, “*” shows which timer is counting-down. Choose NO and “*” will not show during a cook cycle.

**6-1.
SPECIAL PROGRAM
MODE
(CONT.)**

2nd Language (SP-16)

- Press ► button and “SP-16 2ND LANGUAGE” flashes on the left display. Press the ▲ or ▼ buttons to select the desired 2nd language.
- By setting a 2nd language in the controls, 2 languages can now be chosen by pressing **P** button during normal operation.
- One language shows in the left display and the second language shows in the right display. Pressing the √ button selects the language in the displays.

2nd Volume (SP-17)

- Press ► button and “SP-17 2ND VOLUME” flashes on the left display. Press the ▲ or ▼ buttons, or the product buttons to select the desired 2nd volume.
- By setting a 2nd volume in the controls, 2 volumes can now be chosen by pressing **P** button twice during normal operation.
- One volume setting shows in the left display (NONE to 10; 10 being the loudest) and the second volume shows in the right display. To select the volume, press the √ button under the desired volume .

Energy Save Mode (SP-18)

- Press ► button and “SP-18 ENERGY SAVE ENABLED?” flashes in the left display. Press the ▲ or ▼ buttons to choose “YES” or “NO”.
- If set to YES, during times of non-use the fryer automatically starts an Energy Save Mode, which turns-off the blowers. Then once a product is selected to start a cook cycle, the blowers and heat come back on. If set to NO, the blowers are on constantly.

Fryer Type (SP-19)

- Press ► button and “SP-19 FRYER TYPE” flashes in the left display. Press the ▲ or ▼ buttons to choose “GAS” or “ELEC”.

Vat Type (SP-20)

- Press ► button and “SP-20 VAT TYPE” flashes in the left display. Press the ▲ or ▼ buttons to choose “SPLIT” or “FULL”.

Autolift Enabled (SP-21)

- Press ► button and “SP-21 AUTOLIFT ENABLED?” flashes in the left display. Press the ▲ or ▼ buttons to choose “YES LIFT” or “NO LIFT”.
- If fryer is fitted with the auto-lift option, SP-21 must be set to “YES LIFT”, otherwise, set SP-21 to “NO LIFT”.

**6-1.
SPECIAL PROGRAM
MODE
(CONT.)**

Bulk Oil Supply (SP-22)

- Press ► button and “SP-22 BULK OIL SUPPLY?” flashes in the left display. Press the ▲ or ▼ buttons to choose “YES SUPL” or “NO SUPL”.
- Set to YES if the oil is pumped into the vats from an outside oil reservoir. Otherwise, set SP-22 to NO.

Bulk Oil Disposal (SP-23)





- Press ► button and “SP-23 BULK OIL DISPOSE?” flashes in the left display. Press the ▲ or ▼ buttons to choose “YES DISP” or “NO DISP”.
- Set to “YES DISP” if the oil is pumped from the vats to an outside oil reservoir when disarding the oil. Otherwise, set SP-23 to “NO DISP”.

Serial Number Log (SP-24)

- Press ► button and “SP-24 S/N √EDIT” flashes in the displays, along with the serial number of the unit. THIS SERIAL NUMBER SHOULD MATCH THE SERIAL NUMBER ON THE DATA PLATE, ON THE DOORS. IF NOT, IT CAN BE RECORDED.

Program Code Change (SP-25)





This allows the operator to change the program code (factory set at 1, 2, 3) used to access Product Programming and Level 2 Program Mode.

- Press ► button and “SP-25 CHANGE MGR CODE? 1=YES” flashes in the display. Press  and “ENTER NEW CODE, P=DONE, I=QUIT scrolls through the display. Press the product buttons for new code.
- If satisfied with code, press  and “REPEAT NEW CODE, P=DONE, I=QUIT, shows in display. Press same code buttons.
- If satisfied with code, press  and “*CODE CHANGED*” shows in display.
- If not satisfied with code, press  and “*CANCEL” shows in display, then reverts back to “SP-25” and “CHANGE, MGR CODE? 1=YES”. Now the above steps can be repeated.

**6-1.
SPECIAL PROGRAM
MODE
(CONT.)**

Usage Code Change (SP-26)

This allows the operator to change the reset usage code (factory set at 1, 2, 3) to reset the usage amounts of each product. See Review Usage step in Information Mode.

- Press ► button and “SP-26 CHANGE USAGE CODE? 1=YES” flashes in the display. Press  and “ENTER NEW CODE, P=DONE, I=QUIT” show scrolls through display. Press product buttons for new code.
- If satisfied with code, press  and “REPEAT NEW CODE, P=DONE, I=QUIT” shows in display. Press same code buttons.
- If satisfied with code, press  “*CODE CHANGED*” shows in display.
- If not satisfied with code, press  and “*CANCEL” shows in display, then reverts back to “SP-26” and “CHANGE, USAGE CODE? 1=YES”. Now the above steps can be repeated.

Dispose Requires Code ? (SP-27)

- Press ► button and “SP-27 DISPOSE REQUIRES CODE ?” flashes in the left display. Press the ▲ or ▼ buttons to choose YES or NO. If set to YES, code 1, 2, 3 must be entered to discard the oil from the vat, using the Dispose Mode.

Longer Fill Time (SP-28)

- Press ► button and “SP-28 LONGER FILLTIME ENABLED?” flashes in the left display. Press the ▲ or ▼ buttons to choose YES or NO.

Let User Exit Fill (SP-29)

- Press ► button and “SP-29 LET USER EXIT FILL” flashes in the left display. Press the ▲ or ▼ buttons to choose YES or NO. If YES is chosen, the user can exit the Express Filter™ fill operation.

Skip ‘SKIM’ Prompt (SP-30)

- Press ► button and “SP-30 SKIP ‘SKIM’ PROMPT?” flashes in the left display. Press the ▲ or ▼ buttons to choose YES or NO.

6-2.
DO NOT DISTURB

Time periods of peak operations during which the “FILTER NOW?” message will not appear, may be programmed into the fryer. There are three groupings of days - Monday thru Friday (M-F), Saturday (SAT), and Sunday (SUN). Within each day grouping, up to 4 time periods (M-F 1 thru M-F 4, SAT 1 thru SAT 4, and SUN 1 thru SUN 4) may be programmed. A time period may be anywhere from 1 to 180 minutes in length.

1. Press and hold the **P** button for 5 seconds until “LEVEL 2”, followed by, “SP PROG” and “ENTER CODE” show in the display.
2. Press **P** button once more and “DO NOT DISTURB” and “ENTER CODE” flash in the left display.
3. Enter code 1, 2, 3 (first 3 product buttons).
4. “DO NOT DISTURB ENABLED?” flashes in the left display and YES or NO appears in the right display. Press the ▲ or ▼ buttons to choose YES or NO.
5. Press **P** button and “M-F 1” shows in the left display and the time flashes in the right display. Press the ▲ or ▼, or use product buttons, to change the time.
6. Press **P** button and “M-F 1” shows in the left display and “A” or “P” flashes in the right display. Use the ▲ or ▼ buttons to choose AM or PM.
7. Press **P** button and “M-F 1” shows in left display and far right character display flashes. Press product buttons to enter amount of time (up to 180 minutes) during which filtering will be inhibited, after time entered in step 5.
8. Press **P** button to move to the next timer period, M-F 2.
9. Repeat steps 5, 6, 7, and 8 for other desired time periods.

**6-3.
CLOCK SET**

1. Press and hold the **P** button for 5 seconds until “LEVEL 2”, followed by, “SP PROG” and “ENTER CODE” show in the display.
2. Press the **P** button twice more and “CLK SET” and “ENTER CODE” flash in the left display.
3. Enter code 1, 2, 3 (first 3 product buttons).
4. “CS-1 ENTER DATE MM-DD-YY” flashes in the left display. Use product buttons to set the date in right display.
5. Press **▶** button and “CS-2 ENTER TIME” flashes in the left display and the time flashes in the right display. Press the **▲** or **▼**, or use product buttons, to change the time.
6. Press **▶** button and “CS-2 ENTER TIME” flashes in the left display and “AM” or “PM” flashes in the right display. Use the **▲** or **▼** buttons to choose AM or PM.
7. Press **▶** button and “CS-3 TIME FORMAT” flashes in the left display and “12-HR” or “24-HR” shows in the right display. Use the **▲** or **▼** buttons to choose a 12 hour time format or a 24 hour time format.
8. Press **▶** button and “CS-4 DAYLIGHT SAVING TIME” flashes in the left display. Use the **▲** or **▼** buttons to choose daylight saving time for your area: 1.OFF; 2.US (2007 & after); 3.EURO; or 4.FSA (US before 2007).
9. Press and hold **P** button to exit.

**6-4.
DATA LOGGING,
HEAT CONTROL,
TECH, STAT, AND
FILTER CONTROL
MODES**

The Data Logging, Heat Control, Tech, Stat and Filter Control Modes are advanced diagnostic and program modes, mainly for Henny Penny use only. For more information on these modes, contact the Service Department at 1-800-417- 8405 or 1-937-456-8405.

SECTION 7: TROUBLESHOOTING

7-1. TROUBLE SHOOTING GUIDE

Problem	Cause	Correction
POWER switch ON but fryer completely inoperative	<ul style="list-style-type: none"> Open circuit 	<ul style="list-style-type: none"> Plug fryer in Check breaker or fuse at supply box
Control error code "E-10"	<ul style="list-style-type: none"> Oil temperature too high 	<ul style="list-style-type: none"> Let unit cool down (15-20 minutes), push up on metal reset button under right side of the controls; if high limit does not reset, high limit must be replaced 
Vat is under-filled	<ul style="list-style-type: none"> BIB is low or empty BIB oil line is clogged or collapsed Filter pan needs cleaned 	<ul style="list-style-type: none"> Fill the BIB Check BIB line Clean filter pan and change paper or pad

**7-1.
TROUBLE SHOOTING
GUIDE
(CONT.)**

Problem	Cause	Correction
Oil foaming or boiling over top of vat	<ul style="list-style-type: none"> • Water in oil • Improper or bad oil • Improper filtering • Improper rinsing after cleaning the vat 	<ul style="list-style-type: none"> • Drain and clean oil • Use recommended oil • Refer to filtering procedures • Clean and rinse vat and then dry thoroughly
Oil will not drain from vat	<ul style="list-style-type: none"> • Drain valve clogged with crumbs • Drain trough clogged 	<ul style="list-style-type: none"> • Open valve, force cleaning brush through drain • Remove right side panel and remove plug from end of trough and clean trough
Filter motor runs but pumps oil slowly	<ul style="list-style-type: none"> • Filter line connections loose • Filter paper or pad clogged • Filter not reassembled correctly 	<ul style="list-style-type: none"> • Tighten all filter line connections • Change filter paper or pad • Refer to assembly instructions on inside door
Bubbles in oil during entire filtering process	<ul style="list-style-type: none"> • Filter pan not completely engaged • Filter pan clogged • Damaged O-ring on filter line receiver on fryer 	<ul style="list-style-type: none"> • Make sure filter pan return line is pushed completely into the receiver on the fryer • Clean pan and change paper or pad • Change O-ring
Filter motor will not run	<ul style="list-style-type: none"> • The thermal reset button on the rear of the pump motor is tripped <div data-bbox="496 1220 870 1344" data-label="Image"> </div> <p>To prevent burns caused by splashing shortening, turn the unit's POWER switch to the OFF position before resetting the filter pump motor's manual reset protection device.</p>	<ul style="list-style-type: none"> • Open the number two door from the right side of the unit (operator's view) and allow time for the motor to cool. Using a screwdriver, press hard against the button until it clicks <div data-bbox="927 1308 1458 1705" data-label="Image"> </div>

**7-2.
ERROR CODES**

In the event of a control system failure, the digital display shows an error message. The message codes are shown in the DISPLAY column below. A constant tone is heard when an error code is displayed, and to silence this tone, press any button.

DISPLAY	CAUSE	CORRECTION
"E-4"	<ul style="list-style-type: none"> Control board overheating 	Turn switch to OFF position, then turn switch back to ON; if display shows "E-4", the control board is getting too hot; check the louvers on each side of the unit for obstructions
"E-5"	<ul style="list-style-type: none"> Oil overheating 	Turn switch to OFF position, then turn switch back to ON; if display shows "E-5", the heating circuits and temperature probe should be checked
"E-6A"	<ul style="list-style-type: none"> Temperature probe open 	Turn switch to OFF position, then turn switch back to ON; if display shows "E-6A", the temperature probe should be checked
"E-6B"	<ul style="list-style-type: none"> Temperature probe shorted 	Turn switch to OFF position, then turn switch back to ON; if display shows "E-6B", the temperature probe should be checked
"E-10"	<ul style="list-style-type: none"> Hight limit 	Let unit cool down (15-20 minutes), push up on metal reset button under right side of the controls; if high limit does not reset, high limit must be replaced
		
"E-15"	<ul style="list-style-type: none"> Drain switch 	Make sure drain knob is completely pushed-in; if E-15 persists, have drain switch checked
"E-18-A" "E-18-B" "E-18-C"	<ul style="list-style-type: none"> LH level sensor open RH level sensor open Both sensors open 	Turn switch to OFF position, then turn switch back to ON; if display still indicates a failed sensor, have the connectors checked at the control board; have sensor checked & replace if necessary

**7-2.
ERROR CODES
(CONT.)**

DISPLAY	CAUSE	CORRECTION
“E-20-A” “FAN SENSOR STUCK CLOSED”	<ul style="list-style-type: none"> • Pressure Switch failure • Wiring problem • I/O board failure 	<ul style="list-style-type: none"> • If fan is not running, have pressure switch checked; should be open circuit if no air pressure • If fan is running, wiring error, or relay on I/O board closed
“E-20-B” “NO DRAFT” “CHECK FAN”	<ul style="list-style-type: none"> • Pressure switch failure/ hose loose • Draft fan failure/ low voltage • Flue or hood obstruction 	<ul style="list-style-type: none"> • Press power button to vat off and back on again, if E-20-B persists, have pressure switch checked; should be open circuit if no air pressure; make sure hose is connected to fan and pressure switch • Have draft fan checked; low voltage going to fan • Check the fryer flue and hood system for obstructions
“E-20-D” IGNITION FAILURE”	<ul style="list-style-type: none"> • Failure to ignite/ no flame sense 	<ul style="list-style-type: none"> • Press power button to vat off and back on again, if E-20-D persists, check gas line connections; check gas shut-off valve; have ignition module checked; gas valve checked; flame sensor gap checked; gas valve and ignition module wiring checked
“E-21”	<ul style="list-style-type: none"> • Slow heat recovery 	<ul style="list-style-type: none"> • Have a certified service technician check the fryer for correct voltage to the unit; have heat circuit checked; have unit checked for loose or burnt wire
“E-22” “NO HEAT” “CHECK GAS VALVE”	<ul style="list-style-type: none"> • Burner not igniting 	<ul style="list-style-type: none"> • Have gas valve and heat circuit checked
“E-41 “ / “E-46”	<ul style="list-style-type: none"> • Programming failure 	<ul style="list-style-type: none"> • Press power button to vat off and back on again, if any of the error codes, have the controls re-initialized; if error code persists, have the control board replaced
“E-47”	<ul style="list-style-type: none"> • Analog converter chip or 12 volt supply failure 	<ul style="list-style-type: none"> • Press power button to vat off and back on again, if “E-47” persists, have the I/O board, or the PC board replaced; if speaker tones are quiet, probably I/O board failure; have the I/O board replaced
“E-48”	<ul style="list-style-type: none"> • Input system error 	<ul style="list-style-type: none"> • Have PC board replaced
“E-54-C”	<ul style="list-style-type: none"> • Temperature input error 	<ul style="list-style-type: none"> • Turn switch to OFF, then back to ON; have control PC board replaced if “E-54C” persists
“E-60” “FILTER IN USE”	<ul style="list-style-type: none"> • AIF PC board not communicating with control PC board 	<ul style="list-style-type: none"> • Press power button to turn vat off, wait 15 seconds, and turn back on again. If “E-60” persists, have connector between the PC boards checked; replace AIF PC board or control PC board, if necessary
“E-70C”	<ul style="list-style-type: none"> • Drain valve jumper wire missing or disconnected 	<ul style="list-style-type: none"> • Have the jumper wire checked on the PC board at drain switch interlock position
“E-83-A”	<ul style="list-style-type: none"> • Pressure too high 	<ul style="list-style-type: none"> • Check filter system in Vat #1
“E-83-B”	<ul style="list-style-type: none"> • Pressure too high 	<ul style="list-style-type: none"> • Check filter system in Vat #2

**7-2.
ERROR CODES
(CONT.)**

DISPLAY	CAUSE	CORRECTION
"E-83-C"	<ul style="list-style-type: none"> • Pressure too high 	<ul style="list-style-type: none"> • Check filter system in Vat #3
"E-83-D"	<ul style="list-style-type: none"> • Pressure too high 	<ul style="list-style-type: none"> • Check filter system in Vat #4
"E-83-E"	<ul style="list-style-type: none"> • Pressure too high 	<ul style="list-style-type: none"> • Check filter system in Vat #5
"E-83-J"	<ul style="list-style-type: none"> • Bulk BIB FILL switch ON when pressure too high 	<ul style="list-style-type: none"> • Check BIB fill valves
"E-83-R"	<ul style="list-style-type: none"> • Bulk Dispose switch ON when pressure too high 	<ul style="list-style-type: none"> • Check Bulk Dispose quick-disconnect behind fryer
"E-93-1" "24 VDC SUPPLY TRIPPED"	<ul style="list-style-type: none"> • Autolift motor malfunction or failure 	<ul style="list-style-type: none"> • If AutoLift feature is not operating, have each of the AutoLift motors checked.



Henny Penny Corporation
P.O.Box 60
Eaton, OH 45320

1-937-456-8400
1-937-456-8402 Fax

Toll free in USA
1-800-417-8417
1-800-417-8434 Fax

www.hennypenny.com

* FM08-325-B* Henny Penny Corp., Eaton, Ohio 45320, Revised 4-27-15