

HENNY PENNY™

Global Foodservice Solutions

**Henny Penny
Heated Merchandiser**

Model CM-5/7

Model CMT-5/7

Model HM-3/5/7

Model HMT-3/5/7

Model HS/HST-3

SERVICE MANUAL

Henny Penny Heated Merchandiser

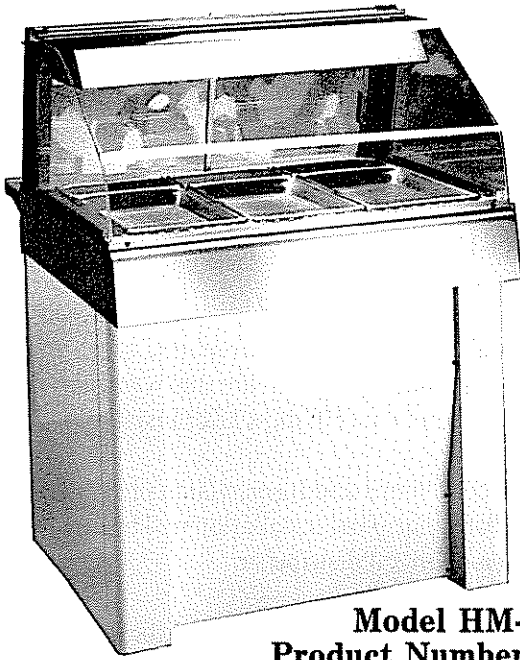

Model HM-3
Product Number 05334

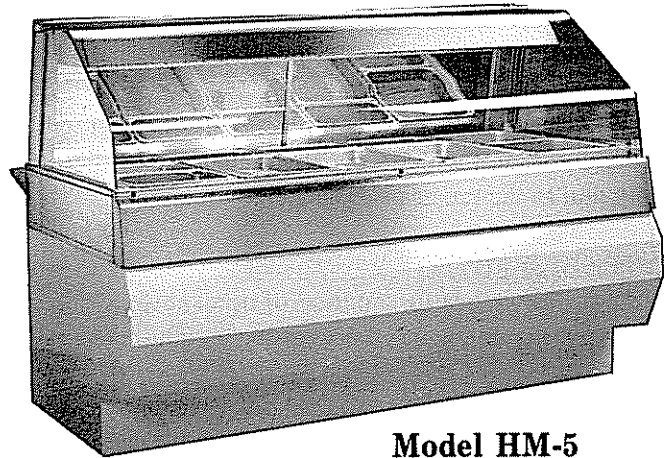

Model HM-5
Product Number 05336

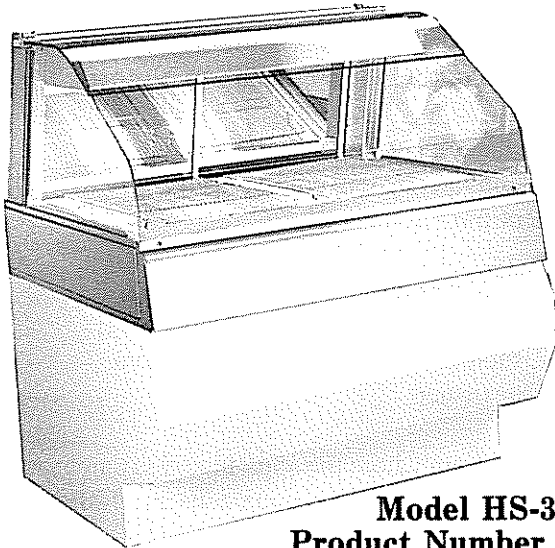

Model HS-3
Product Number 05381

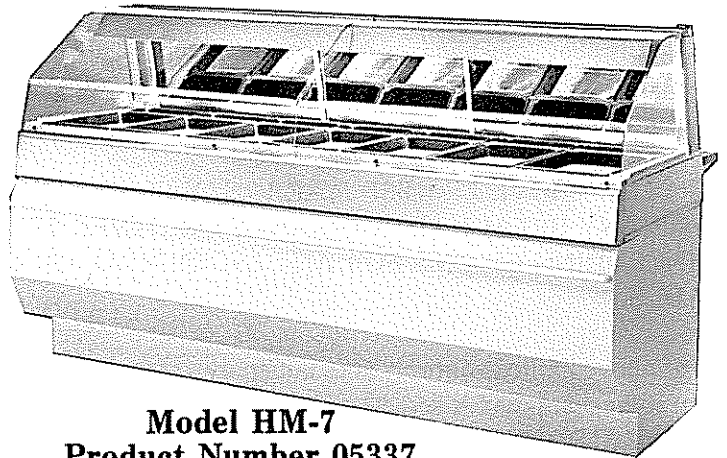

Model HM-7
Product Number 05337

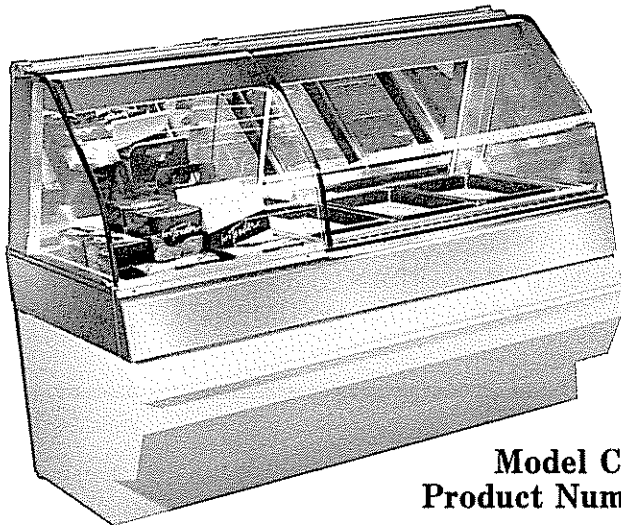

Model CMT-5
Product Number 05418

LIMITED WARRANTY FOR HENNY PENNY APPLIANCES

Subject to the following conditions, Henny Penny Corporation makes the following limited warranties to the original purchaser only for Henny Penny appliances and replacement parts:

NEW EQUIPMENT: Any part of a new appliance, except lamps and fuses, which proves to be defective in material or workmanship within two (2) years from date of original installation, will be repaired or replaced without charge F.O.B. factory, Eaton, Ohio, or F.O.B. authorized distributor. To validate this warranty, the registration card for the appliance must be mailed to Henny Penny within ten (10) days after installation.

REPLACEMENT PARTS: Any appliance replacement part, except lamps and fuses, which proves to be defective in material or workmanship within ninety (90) days from date of original installation will be repaired or replaced without charge F.O.B. factory, Eaton, Ohio, or F.O.B. authorized distributor.

The warranty for new equipment and replacement parts covers only the repair or replacement of the defective part and does not include any labor charges for the removal and installation of any parts, travel or other expenses incidental to the repair or replacement of a part.

EXTENDED FRYPOT WARRANTY: Henny Penny will replace any frypot that fails due to manufacturing or workmanship issues for a period of up to seven (7) years from date of manufacture. This warranty shall not cover any frypot that fails due to any misuse or abuse, such as heating of the frypot without shortening.

0 TO 3 YEARS: During this time, any frypot that fails due to manufacturing or workmanship issues will be replaced at no charge for parts, labor, or freight. Henny Penny will either install a new frypot at no cost or provide a new or reconditioned replacement fryer at no cost.

3 TO 7 YEARS: During this time, any frypot that fails due to manufacturing or workmanship issues will be replaced at no charge for the frypot only. Any freight charges and labor costs to install the new frypot as well as the cost of any other parts replaced, such as insulation, thermal sensors, high limits, fittings, and hardware, will be the responsibility of the owner.

Any claim must be presented to either Henny Penny or the distributor from whom the appliance was purchased. No allowance will be granted for repairs made by anyone else without Henny Penny's written consent. If damage occurs during shipping, notify the sender at once so that a claim may be filed.

THE ABOVE LIMITED WARRANTY SETS FORTH THE SOLE REMEDY AGAINST HENNY PENNY FOR ANY BREACH OF WARRANTY OR OTHER TERM. BUYER AGREES THAT NO OTHER REMEDY (INCLUDING CLAIMS FOR ANY INCIDENTAL OR CONSEQUENTIAL DAMAGES) SHALL BE AVAILABLE.

The above limited warranty does not apply (a) to damage resulting from accident, alteration, misuse, or abuse; (b) if the equipment's serial number is removed or defaced; or (c) for lamps and fuses. THE ABOVE LIMITED WARRANTY IS EXPRESSLY IN LIEU OF ALL OTHER WARRANTIES, EXPRESS OR IMPLIED, INCLUDING MERCHANTABILITY AND FITNESS, AND ALL OTHER WARRANTIES ARE EXCLUDED. HENNY PENNY NEITHER ASSUMES NOR AUTHORIZES ANY PERSON TO ASSUME FOR IT ANY OTHER OBLIGATION OR LIABILITY.

TABLE OF CONTENTS

Section	Page
Section 1. INTRODUCTION	1-1
1-1. Heated Merchandiser	1-1
1-2. Features	1-1
1-3. Assistance	1-1
1-4. Model Variations	1-2
1-5. Safety	1-2
Section 2. INSTALLATION	2-1
2-1. Introduction	2-1
2-2. Unpacking	2-1
2-3. Electrical Connection	2-2
2-4. Electrical Data Table	2-2
2-5. Cabinet Dimensions	2-3
Section 3. OPERATION	3-1
3-1. Operating Controls	3-1
3-2. Start-Up	3-4
3-3. Operation With Product	3-5
3-4. Recommended Settings for Heated Merchandiser	3-6
3-5. Shut Down and Clean Up	3-6
Section 4. PROGRAMMING	4-1
4-1. Entering Program Mode	4-1
4-2. Programming Upper Heat	4-1
4-3. Programming Water Heat	4-1
4-4. Programming Air Temperature	4-1
4-5. Special Program Mode	4-1
4-6. Error Codes	4-2
Section 5. MAINTENANCE	5-1
5-1. Introduction	5-1
5-2. Removing Front Glass	5-1
5-3. Radiant Heaters	5-3
5-4. Light Socket	5-3
5-5. Water Heater	5-4
5-6. Base Heaters	5-5
5-7. Air Blowers	5-6
5-8. Heat Probe (Air)	5-6
5-9. Transformer	5-7
5-10. Product Probe Outlet	5-7
5-11. Heat Relay	5-8

TABLE OF CONTENTS (Continued)

Section	Page
Section 5. MAINTENANCE (Continued)	5-8
5-12. Cooling Fan	5-8
5-13. Printed Circuit Board	5-9
5-14. Gas Shocks	5-9
5-15. Fuse and Fuse Holder	5-10
5-16. Power and Light Switch	5-11
5-17. Wiring Diagrams	5-12
 Section 6. TROUBLESHOOTING	 6-1
6-1 Introduction	6-1
6-2 Troubleshooting	6-1
 Section 7. PARTS INFORMATION	 7-1

Henny Penny Distributor List

SECTION 1. INTRODUCTION

1-1. HEATED MERCHANDISER

The Henny Penny Heated Merchandiser is a basic unit of food processing equipment used to display the food product and maintain the temperature of hot foods in a commercial food service operation. Using a combination of precise heat, humidity and slowly circulating air, Henny Penny's even heat process creates the ideal environment to maintain the taste and quality of freshly-cooked foods for hours.

1-2. FEATURES

- Unique THERMA-VEC even heat process re-circulates heated air, keeping temperature precise and stable throughout the case.
- Contemporary curved glass cases present 100 per cent product visibility.
- Individually controlled radiant heaters over each well.
- Air heating elements under pans.
- Humidity controlled with heated water pan.
- Touch pad electronic controls and LED readouts.
- Incandescent lighting for attractive food presentation.
- Fold-down cutting board.

1-3. ASSISTANCE

Should you require outside assistance, just call your local, independent Henny Penny distributor maintained by Henny Penny Corporation. In addition, feel free to contact our corporate headquarters in Eaton, Ohio. Dial 1-800-543-6243 toll free, except in Ohio, dial 1-800-762-2964.

1-4. MODEL VARIATIONS

This manual covers the HM-3, three well merchandiser, the HM-5, five well merchandiser, the HM-7, seven well merchandiser, and the HS-3 self serve merchandiser.

Model Number	Product Number
HM-3	05334
HM-5	05336
HM-7	05337
HS-3	05381

1-5. SAFETY

The only way to ensure safe operation of the Henny Penny Heated Merchandisers is to fully understand the proper installation, operation and maintenance procedures. The instructions in this manual have been prepared to aid you in learning the proper procedures. Where information is of particular importance or is safety related, the words NOTE, CAUTION, or WARNING are used. Their usage is described below.

NOTE

The word NOTE is used to highlight especially important information.

CAUTION

The word CAUTION is used to alert you to a procedure that, if not performed properly, may damage the unit.

WARNING

The word WARNING is used to alert you to a procedure that, if not performed properly, may cause personal injury.

SECTION 2. INSTALLATION

2-1. INTRODUCTION

This section provides the installation instructions for the Henny Penny Heated Merchandiser.

NOTE

Installation of this unit should be performed only by a qualified service technician.

WARNING

Do not puncture the skin or glass of the Heated Merchandiser with drills or screws, as component damage or electrical shock could result.

NOTE

This unit is no longer shipped with legs included; if you want to mount this unit on legs they must be ordered as an accessory item (Henny Penny part number 54003, 4 required). If this unit is placed directly on a countertop, it must be sealed using a NSF approved silicone sealant.

2-2. UNPACKING

The Henny Penny Heated Merchandiser is tested, inspected and expertly packed to insure arrival at its destination in the best possible condition. The unit has been bolted to a wooden skid. All items have been packed and taped inside of the unit. The merchandiser is then packed inside a triple wall corrugated carton with sufficient padding to withstand normal shipping treatment. Any shipping damages should be noted in the presence of delivery agent and signed prior to his or her departure.

Step 2

To remove the Heated Merchandiser from the carton, you should:

1. Carefully cut banding straps.
2. Open flaps of carton and remove packing.
3. Lift carton from unit.
4. Remove four bolts mounting the merchandiser to the skid.
5. If installing the unit to Merchandiser Base, use existing bolts to mount unit.
6. If installing on countertop, use four legs supplied with each unit.

Step 3

**2-2. UNPACKING
(Continued)**

7. Unpack doors, cutting board, and pan supports, and install.
8. The heated merchandiser is now ready for location and set-up.

**2-3. ELECTRICAL
CONNECTION**

The Heated Merchandiser is available from the factory wired for 120/208-240 volts, single phase, 3 wire plus ground (includes neutral). The proper power service cable is provided with each unit.

CAUTION

The unit must be adequately and safely grounded. Refer to local electrical codes for correct grounding procedures.

A separate disconnect switch with proper capacity fuses or breakers must be installed at a convenient location between the unit and the power source.

**2-4. ELECTRICAL DATA
TABLE**

Model	Volts	Phase	KW	Amps	Product Number
HM/HMT-3	120/208-240	1	2.8	12.0	05403/05334
HM/HMT-5	120/208-240	1	4.3	18.0	05398/05336
HM/HMT-7	120/208-240	1	6.2	25.8	05399/05337
HS/HST-3	120/208-240	1	2.4	10.0	05397/05381
CM/CMT-5	120/208-240	1	4.3	18.0	05404/05405
CM/CMT-7	120/208-240	1	5.7	23.5	05426/05427

2-5. CABINET DIMENSIONS

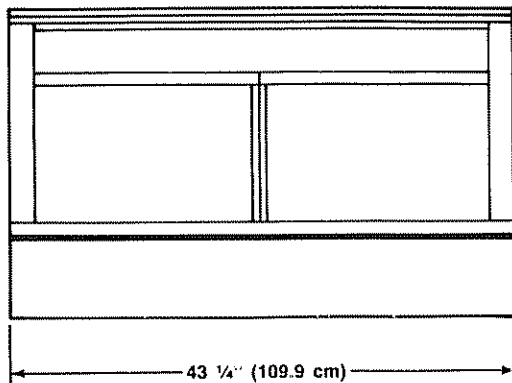

Model HM-3/HS-3
Model HMT-3/HST-3

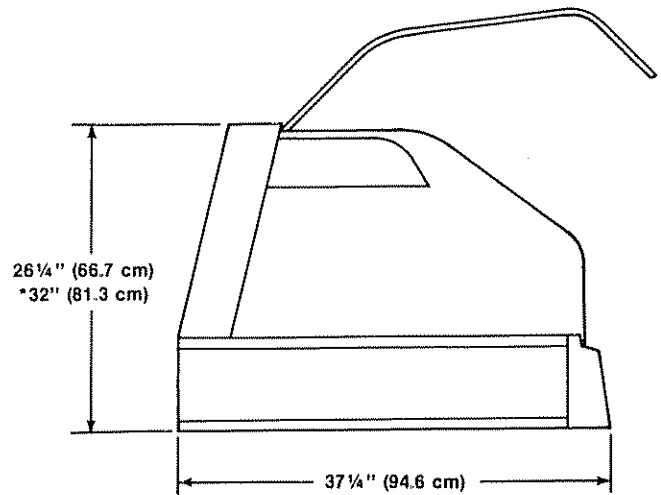

Model HM-3/HS-3/HM-5
*Model HMT-3/HST-3
*Model HMT-5/CMT-5

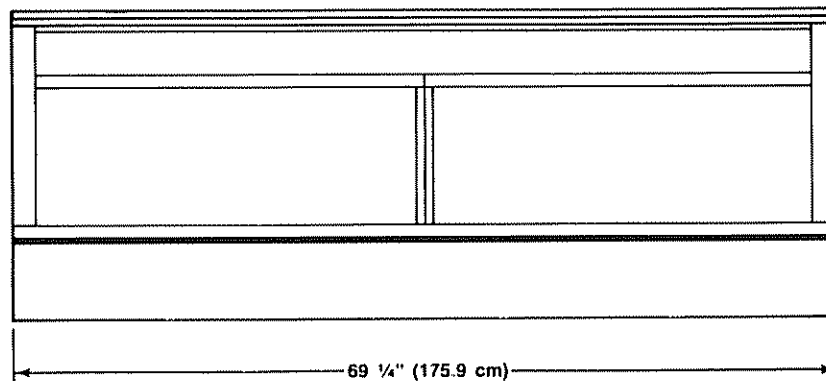

Model HM-5/CM-5
Model HMT-5/CMT-5

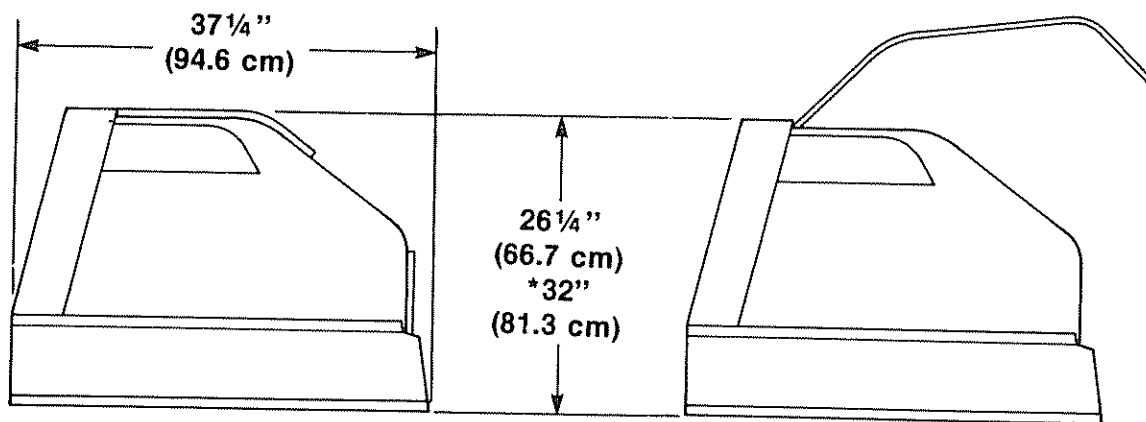
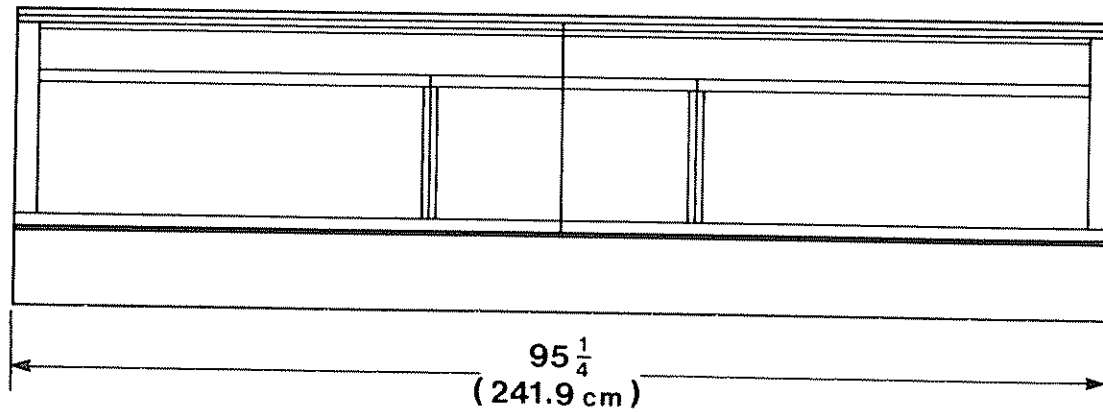

Model HM-7/CM-7
*Model HMT-7/CMT-7

SECTION 3. OPERATION

3-1. OPERATING CONTROLS

This section describes the functions of all operating controls.

Item No.	Description	Function
1	Increase Switch	The increase switch is used during programming to increase the displayed value by one setting. It is also used to enter special program mode.
2	Decrease Switch	The decrease switch is used during programming to decrease the displayed value by one setting. It is also used to enter special program mode.
3	Air Heat Switch	This switch is depressed to set the air heat temperature set point.
4	Water Heat Switch	This switch is depressed to set the water heat.
5	Upper Heat - 1, 2, 3, 4, and 5.	<p>These switches are depressed to set the radiant heaters.</p> <p style="text-align: center;">NOTE</p> <p style="text-align: center;">HM-3 will have 1, 2, and 3. HM-7 will have 1 through 7.</p>
6	Temperature Display	The temperature display is a three-digit red LED display. The display is used to show the air and product temperatures. It is also used to display control error messages, and during programming to show the parameter being programmed.
7	Ready LED	This LED turns on when the merchandiser is ready to hold product. It turns on to indicate the air temperature is near the set point.
8	Display Air Temp LED	This LED turns on when the merchandiser air temperature is shown in the display.
9	Display Probe Temp LED	This LED turns on when the product probe temperature is shown in the display.
10	UPPER HEAT 1, 2, 3, 4, and 5 LED's	<p>These LED's turn on during operation when the associated radiant heater turns on.</p> <p style="text-align: center;">NOTE</p> <p style="text-align: center;">The HM-3 has three LED's. The HM-7 has seven LED's.</p>

Item No.	Description	Function
11	Water Heat LED	This LED turns on during operation when the water heater is on.
12	Air Heat LED	This LED turns on during operation when the air heater is on.
13	Power Switch	The power switch is a two-position switch used to switch electrical current to the unit.
14	Light Switch	The light switch is a two-position switch that turns the lights off and on.
15	Fuse	The fuse (2) is a protective device for the PCB control, motor, and lights circuit. The fuses are a 15 amp rating and must be replaced by a fuse of the same size and rating.

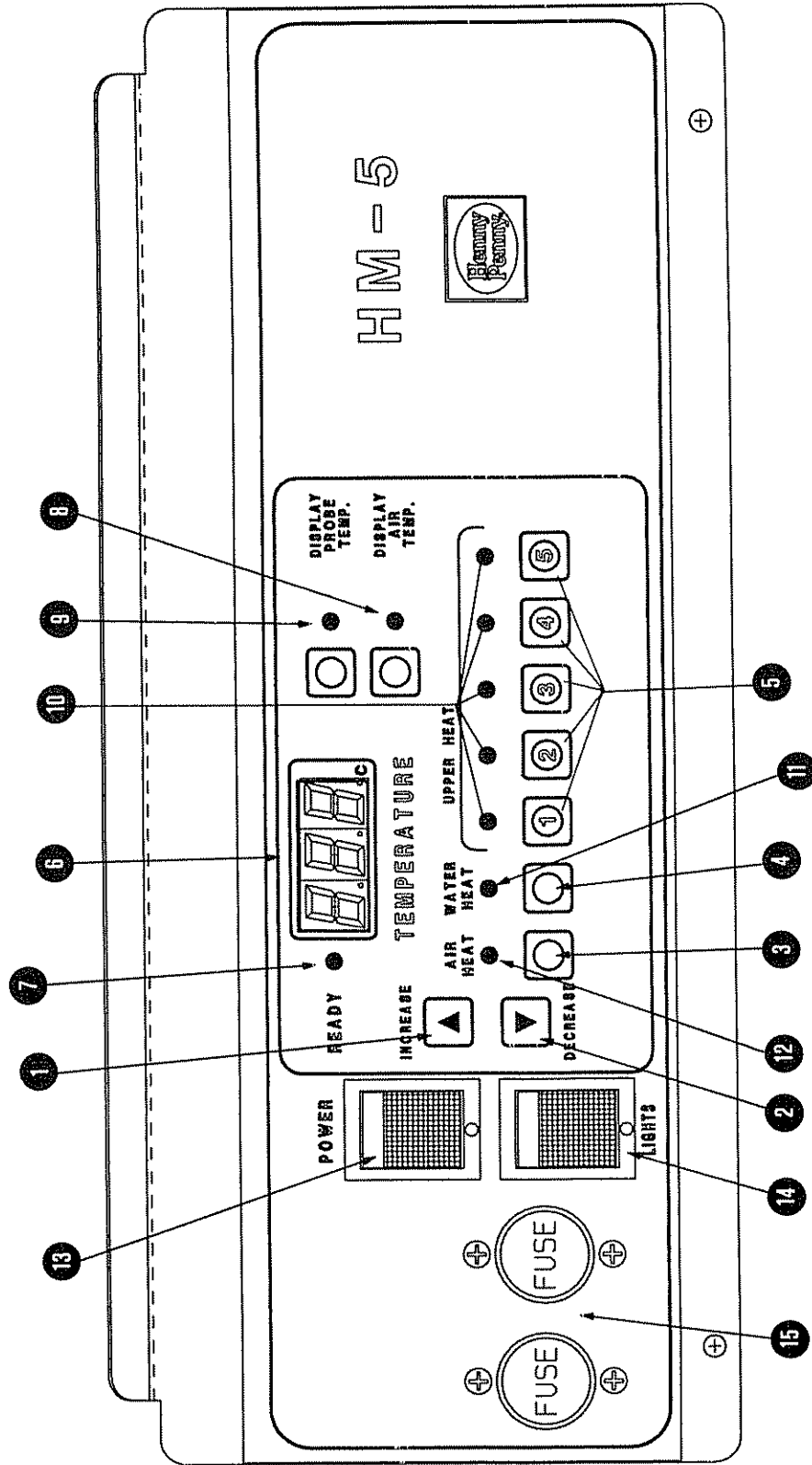

3-2. START-UP

Normal Operation

1. Turn POWER and LIGHTS to the ON position.
2. Fill water pan with approximately one quart of water (1 inch in water pan).
3. Allow approximately 30 minutes preheat time.
4. Check air temperature setting by depressing switch marked AIR HEAT.
5. Check water temperature setting by depressing switch marked WATER HEAT.

NOTE

Water heat settings read 1, 2, 3, etc. One meaning the heat is on 10% of the time, and ON meaning the heat is on 100% of the time. Refer to programming section for correct setting changes. If you wish to operate unit with no humidity, program water heat to OFF.

6. Check upper heat settings by depressing numbered switch corresponding to each well.

NOTE

HM-3 is numbered 1 through 3; HM-5 is number 1 through 5; HM-7 is numbered 1 through 7. Refer to "Recommended Settings for HM-3, HM-5, and HM-7."

7. As a rule, a lower upper heat setting, such as 3 or 4, holds dense foods like macaroni and cheese or cherry cobbler. Use higher upper heat settings for less dense foods, such as fried chicken.
8. If using a probe to check product temperature, plug probe into probe outlet (just left of the control panel) and place probe into the product you are testing.
9. Depress switch marked PROBE TEMP DISPLAY.

3-3. OPERATION WITH PRODUCT

1. Rotate food from front to back.
2. Food in half-full pans does not hold as well as food in full pans. Rotate pan to back of merchandiser where it is directly under upper heating elements or move food to a smaller pan that has been preheated.
3. When "freshening" foods such as macaroni and cheese with added water, heat the water in a clean container until it is 10 to 20 degrees above the desired holding temperature of the food. This will keep food at a safe serving temperature. Depending on the amount of water, the temperature can drop 10 to 20 degrees in as little as five minutes.
4. When transferring hot foods in the heated merchandiser to clean pans, preheat the clean pan. Transferring hot foods to room temperature pans can cause the temperature of the food to drop 20 degrees or more, thus causing food to be at an unsafe serving temperature.
5. To keep hot foods from drying too fast, keep a clean misting bottle (such as you find in a garden supply store) with a mixture of 1/3 vegetable oil and 2/3 water on hand. Set the nozzle for a fine mist. Shake the vegetable oil and water mixture well. Spray surface of food immediately, shaking the bottle between each entree. Frequency foods need to be misted will depend upon the unique characteristics of the food, the water heat setting in the case and atmospheric conditions. Do not use this mixture on foods with a pastry crust or crumb toppings where a dry surface is desirable.
6. If prepackaging foods, place containers directly under upper heating elements (in back of the case) for maximum holding time. Upper heat may need to be increased slightly.

3-4. RECOMMENDED SETTINGS FOR HM-3, HM-5, and HM-7

Food Item	Water Heat Setting (Humidity)	Air Temperature Setting	*Upper Heat Setting
Fried Foods (chicken, fish, potato wedges, finger foods)	5 – 8	160°	5- 7
Convenience Entrees	7 to "ON"	145° -150°	3- 5
Barbecue Spareribs	7 "ON"	145° - 150°	4 - 5
Roast Chicken	7 "ON"	145° - 150°	4 - 5

*Upper heat settings desired depend somewhat on the unique characteristics of the foods placed together in the same well. Always keep foods that lose heat the most readily to the back of the unit, where they will be directly under the upper heating elements.

Foods that do not hold heat as well as others include items like chicken and noodles, salisbury steak, escalloped apples and small sized fried foods (fried mushrooms, french fries and some types of cheese sticks).

Foods that hold heat better than others include lasagna, fruit cobblers and some types of macaroni and cheese.

Holding properties of a given food vary according to quality and recipe brand.

3-5. SHUT DOWN AND CLEAN UP

1. Remove all power from unit by unplugging the cord or turning the wall circuit breaker off.
2. Allow unit to cool before cleaning.
3. Remove rear doors and open front glass.
4. Remove pans, pan supports, and water pan and clean with soap and water at sink.
5. Clean all surfaces with a soft cloth, soap, and water. **DO NOT USE ABRASIVE CLEANSERS.**



When cleaning under the bottom elements, lift them carefully and **DO NOT** lift them too high, or damage to the elements will result.

6. Clean around electrical controls and components with a damp cloth.
7. Clean doors and glass with a non-streaking liquid glass cleaner. **DO NOT USE ABRASIVE CLEANER.**
8. Leave doors open until ready to load and use again.

SECTION 4. PROGRAMMING

<p>4-1. ENTERING PROGRAM MODE</p>	<p>Program mode is entered by depressing and holding a parameter switch. Parameter switches are AIR HEAT, WATER HEAT, and the UPPER HEAT switches.</p>
<p>4-2. PROGRAMMING UPPER HEAT</p>	<p>Depress and hold switch marked UPPER HEAT.</p> <p>Using the INCREASE or DECREASE switches, program the desired percentage on time of the radiant heater. The display will be numbered 1 through 9. One meaning 10%; 2 meaning 20%, etc. "OFF" means the heater is always off - "ON" means the heater is always on. Repeat procedures until all radiant heaters are programmed.</p>
<p>4-3. PROGRAMMING WATER HEAT</p>	<p>The procedure for programming the water heat is identical to that of programming the radiant heat, except that the WATER HEAT LED flashes.</p>
<p>4-4. PROGRAMMING AIR TEMPERATURE</p>	<p>Depress switch marked AIR HEAT.</p> <p>Using the INCREASE or DECREASE button, program desired air temperature. Air temperature can be programmed between 120°F and 175°F.</p>
<p>4-5. SPECIAL PROGRAM MODE</p>	<p>Special program mode is used to perform the following functions:</p> <ul style="list-style-type: none"> • Calibrating the air and product temperature probes. • Initializing the program. • Changing the control for Fahrenheit 0 /Celsius". <p>To enter the special program mode, depress and hold the INCREASE switch and turn the power switch to the "ON" position. Display will read "SP" for special program. To exit special program, turn the power switch to "OFF".</p> <p>To calibrate air temperature, depress and hold the DISPLAY AIR TEMP switch. Display will show the actual air temperature seen by the probe. Use your INCREASE/DECREASE switch to adjust the displayed temperature. Temperature can be adjusted plus or minus 15 degrees.</p>

4-5. SPECIAL PROGRAM MODE (Continued)

To calibrate the product probe, depress and hold the DISPLAY PROBE TEMP switch. Use the INCREASE or DECREASE switch and adjust the displayed temperatures. Temperatures can be adjusted plus or minus 15 degrees.

Due to unusual conditions, such as lightning storms, low voltages, etc., it may be necessary to initialize the program. By following these procedures, you can erase any errors or false memory from the program. You then can reprogram the control to the correct times and temperatures.

Depress and hold the WATER HEAT switch. Display will show "INI". Depress the INCREASE or DECREASE switch and display will flash "INI". Initialization is complete when the buzzer sounds and the display stops flashing. Release the WATER HEAT switch. Air temperature will be at minimum of 145° F. Water and radiant heat will be off. Air probe and product probe calibration will be at 0. Unit may be reprogrammed.

To set the display for Fahrenheit or Celsius temperature, depress and hold the AIR HEAT switch. Display will read "F" for Fahrenheit or "C" for Celsius. Depress INCREASE or DECREASE to change the setting.

NOTE

To change the displays on the uprights from Fahrenheit to Celsius, turn unit off, and press and hold the button under the display. Turn unit back on, then release button when CAL shows on the display. Press the button once and °FC shows on the display. Press button once again, the °C should show on the display. Turn unit off and back on again and unit is ready for use.

4-6. ERROR CODES

NOTE

E06 can occur on the left control panel on HM/HMT-7's. To reset the controls, turn the power switch off and press and hold the increase button on the left control panel. Then turn the unit back on while holding in on the increase button. Then release the increase button and press and hold the #1 upper heat button. While holding in on the #1 button, press and release the increase button to toggle the display from "air" to "prd". Turn unit off and back on.

The following table explains the error codes:

- E05 (Software High Limit)
- E46 (Memory Scrambled - Must be initialized and reprogrammed.)
- E06 (Air Probe Error)
- PRB (Product Probe Error)

If an error code occurs during normal operation, temperature display will show the error code and the buzzer will sound continuously until any switch on the control is pressed. When the switch is pressed, the buzzer will stop sounding but error must be corrected.

NOTE

A product probe error will be displayed as "PRB" when depressing the DISPLAY PROBE TEMP switch only. Buzzer will not sound as an error code.

SECTION 5. MAINTENANCE

5-1. INTRODUCTION

This section provides procedures for the replacement of the various parts used within the merchandiser.

5-2. REMOVING FRONT GLASS

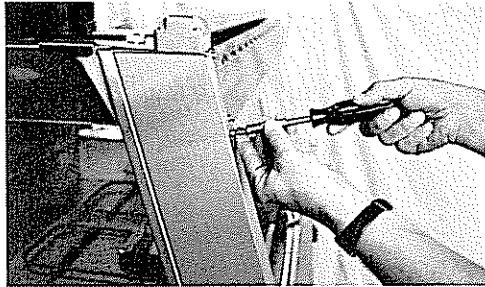

Step 1

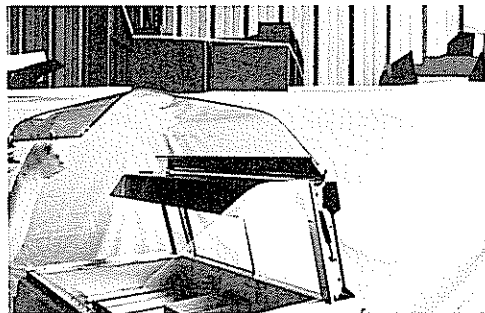

Step 2

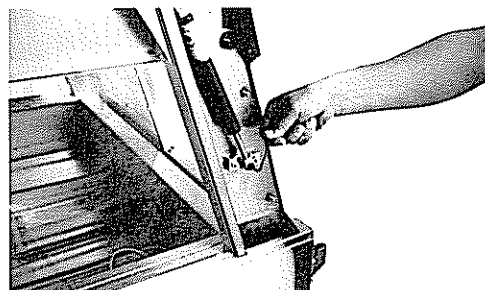

Step 3

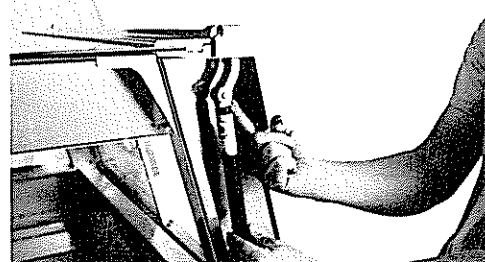

Step 4

WARNING

Place power switch in OFF position, shut off power at fuse or breaker box. Failure to do so could result in electrical shock.

WARNING

The following procedure must be followed exactly to prevent personal injury. The gas shocks **must** be removed first before any maintenance can be performed on the front glass.

1. Remove two screws holding access panel on both sides of unit.
2. A person needs to hold front glass open as far as possible.
3. With a 3/8" allen wrench, remove shoulder bolt from bottom of gas shock and let shock hang.
4. Unthread shock from upper head of shock.

5-2. REMOVING FRONT GLASS (Continued)

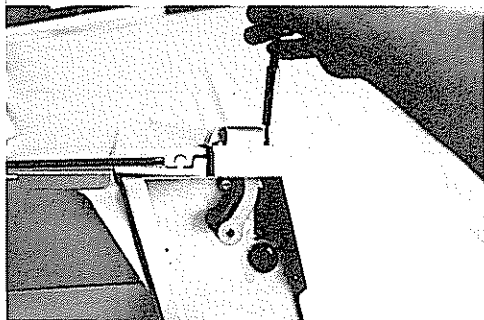

Step 5

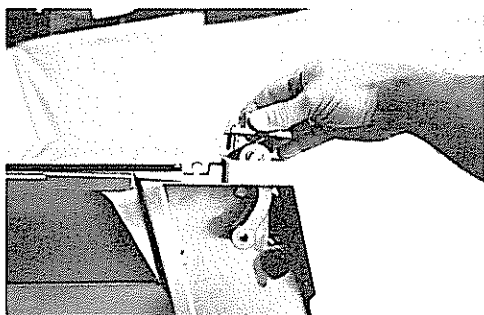

Step 5

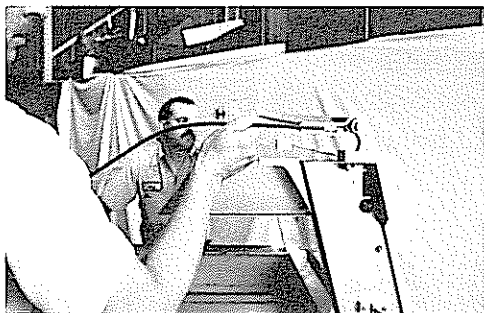

Step 6

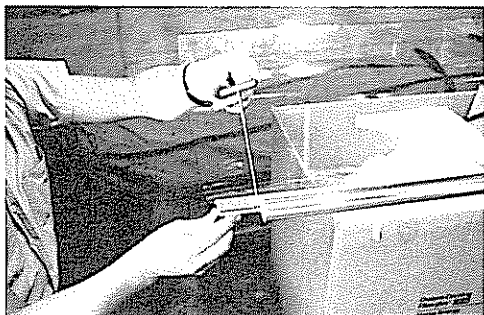

5. Remove four screws holding hinge plate and remove plate.

6. Remove glass as an assembly.

7. Install new front glass.

5-3. RADIANT HEATERS

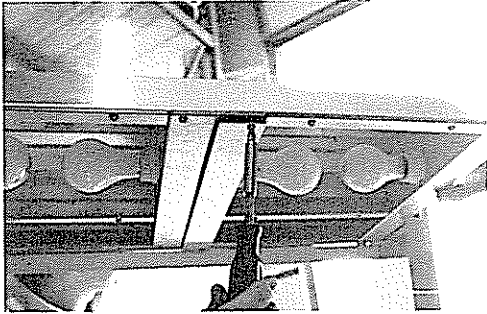

Step 1

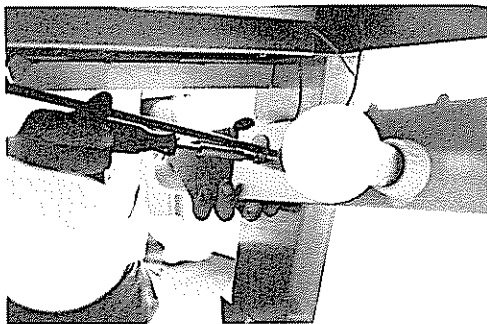

Step 2

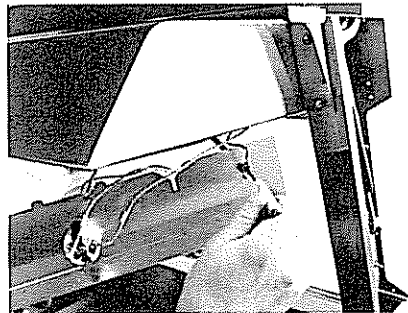

Step 3

WARNING

Place power switch in OFF position, shut off the power at the fuse or breaker box. Failure to do so could result in electrical shock.

1. Remove access panel on both sides of radiant heater and let light socket and heater hang.

2. Remove screw from inner side of heater.

3. Remove wires from heater and pull radiant heater from panel.

4. Install new radiant heater.

5-4. LIGHT SOCKET

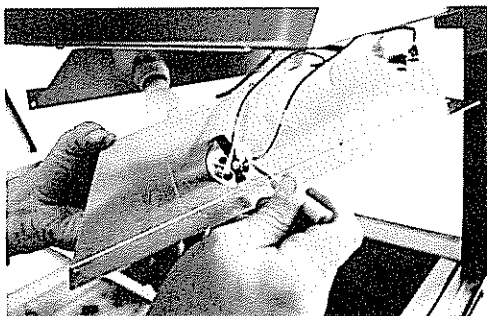

Step 2

WARNING

Place power switch in OFF position, shut off the power at the fuse or breaker box. Failure to do so could result in electrical shock.

1. Remove access panels from both sides of light socket.

**5-4. LIGHT SOCKET
(Continued)**

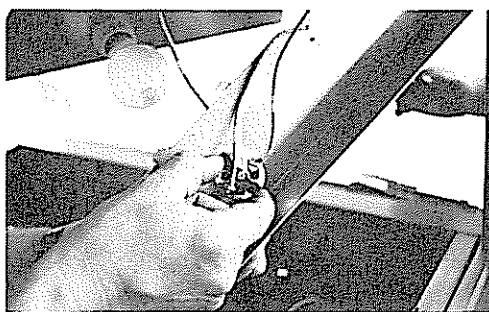

Step 3

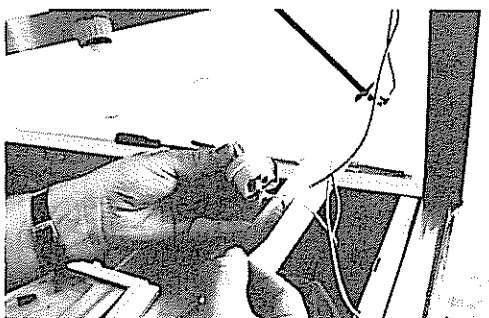

Step 4

2. Remove wires from light socket.
3. Depress retainer on light socket and push through panel.
4. Install new light socket.

5-5. WATER HEATER

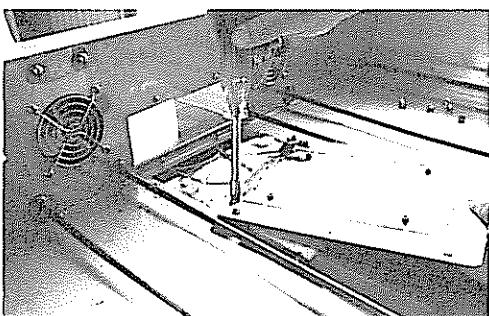
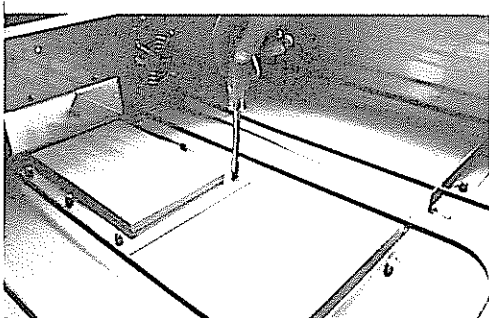

Step 3

WARNING

Place power switch in OFF position, shut off the power at the fuse or breaker box. Failure to do so could result in electrical shock.

1. Remove 3/8" acorn nuts from heater mounting plate.
2. Pry heater and mounting plate from studs and turn heater over.

**5-5. WATER HEATER
(Continued)**

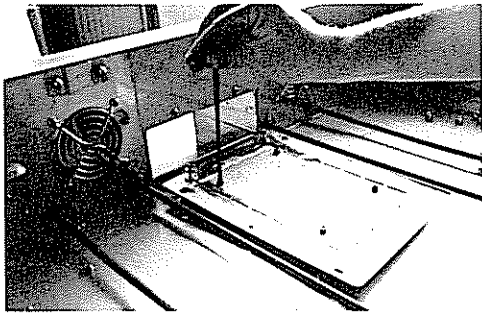

Step 4

3. Remove wires from heater.
4. Remove four allen screws mounting heater to plate.
5. Install new water heater.

5-6. BASE HEATERS

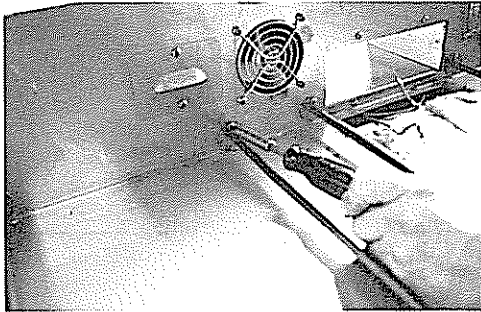

Step 1

WARNING

Place power switch in OFF position, shut off the power at the fuse or breaker box. Failure to do so could result in electrical shock.

1. Remove heater screws from inside of well.

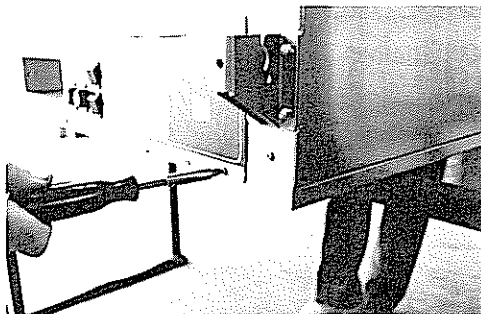

Step 2

2. Remove panel board or access cover.

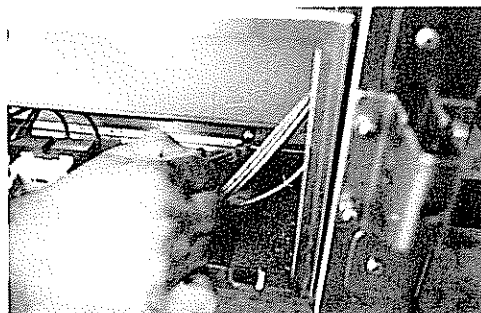

Step 3

3. Unplug wires from heater.
4. Pull heater from inside of well.
5. Install new heater.

5-7. AIR BLOWERS (2)

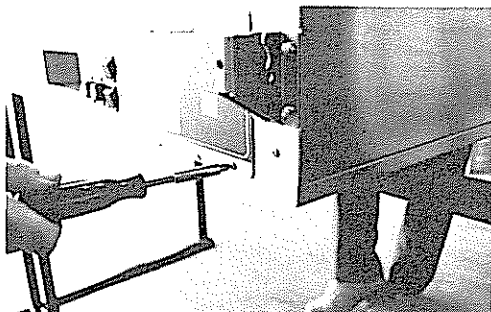

Step 1

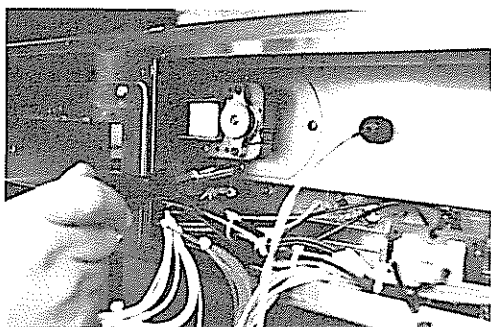

Step 2

WARNING

Place power switch in OFF position, shut off the power at the fuse or breaker box. Failure to do so could result in electrical shock.

1. Remove panel board or access cover.
2. Remove three screws mounting blowers to cabinet.
3. Cut wires to blower.
4. Install new blower and splice cut wires.

5-8. HEAT PROBE (AIR)

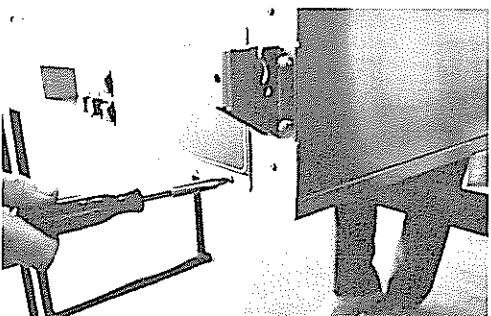

Step 1

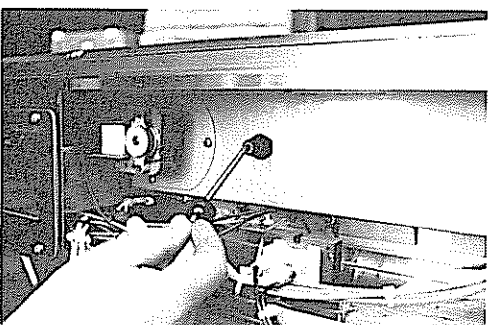

Step 2

WARNING

Place power switch in OFF position, shut off the power at the fuse or breaker box. Failure to do so could result in electrical shock.

1. Remove panel board.
2. Loosen plastic nut from bulkhead and pull probe straight out.
3. Unplug probe from PC board.
4. Install new probe.

5-9. TRANSFORMER

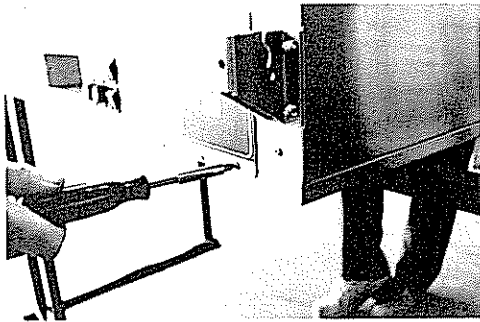

Step 1

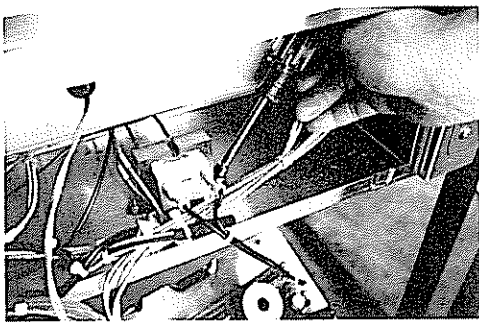

Step 2

WARNING

Place power switch in OFF position, shut off the power at the fuse or breaker box. Failure to do so could result in electrical shock.

1. Remove two 3/8" nuts mounting transformer to housing.
2. Unplug wires from transformer.

NOTE

Mark wires before unplugging from transformer.

3. Install new transformer.

5-10. PRODUCT PROBE OUTLET

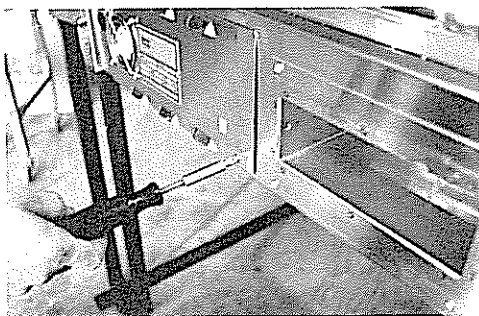

Step 1

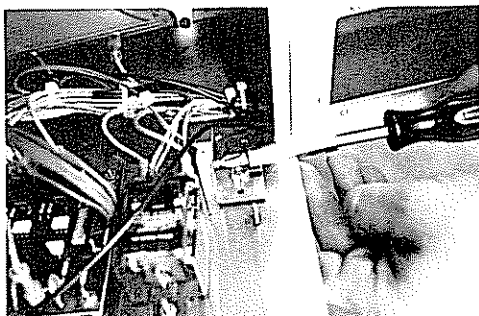

Step 2

WARNING

Place power switch in OFF position, shut off the power at the fuse or breaker box. Failure to do so could result in electrical shock.

1. Remove left side access panel.
2. Remove probe outlet and bracket.
3. Unplug from PC board.
4. Install new outlet.

5-11. HEAT RELAY

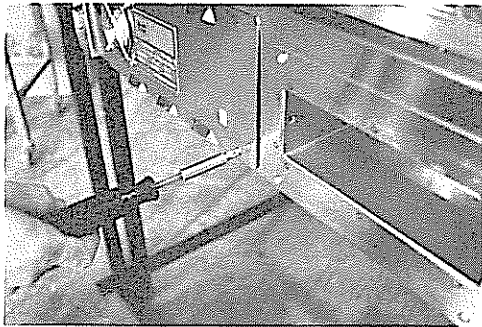

Step 1

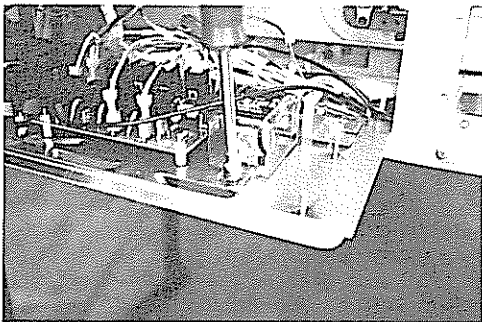

Step 2

WARNING

Place power switch in OFF position, shut off the power at the fuse or breaker box. Failure to do so could result in electrical shock.

1. Remove left access panel.
2. Remove 1/4" nuts mounting heat relay to housing.
3. Remove wires from defective relay and transfer to new heat relay.

NOTE

Mark wires before removing.

5-12. COOLING FAN



Step 1

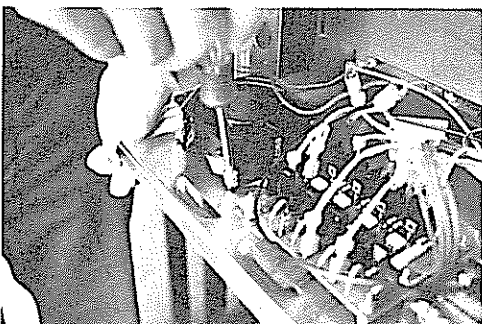

Step 2

WARNING

Place power switch in OFF position, shut off the power at the fuse or breaker box. Failure to do so could result in electrical shock.

1. Remove left access panel.
2. Remove four 15/16" nuts and screws securing fan to housing.
3. Cut wires to defective fan.
4. Install new fan and splice wires.

NOTE

Air flow should be blowing out. Check air flow arrows on fan.

5-13. PRINTED CIRCUIT BOARD

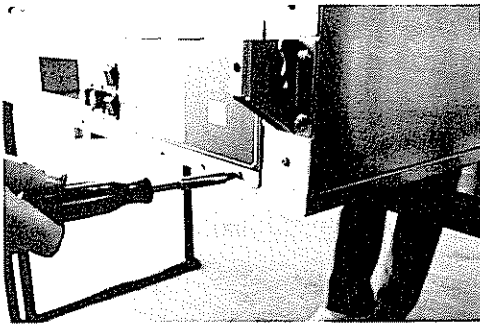

Step 1

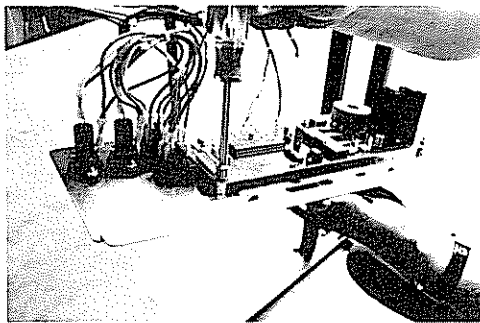

Step 2

WARNING

Place power switch in OFF position, shut off the power at the fuse or breaker box. Failure to do so could result in electrical shock.

1. Unplug probe, transformer, product probe outlet, and nine pin connector from PC board.
2. Remove five 1/4" nuts securing board to housing.
3. Install new PC board.

5-14. GAS SHOCKS

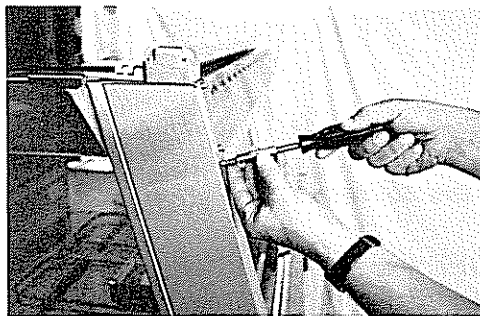

Step 1

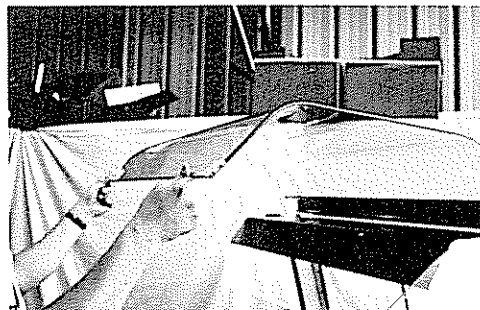

Step 2

WARNING

Place power switch in OFF position, shut off the power at the fuse or breaker box. Failure to do so could result in electrical shock.

1. Remove two screws holding access cover on both sides of unit.
2. Have someone hold front glass as far open as possible.

5-14. GAS SHOCKS (Continued)

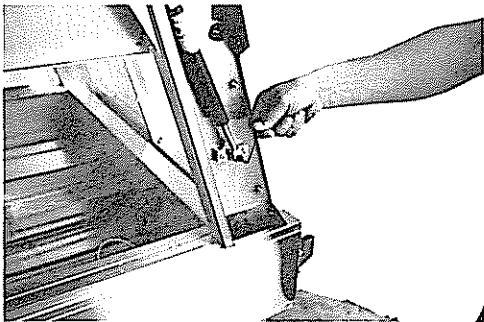

Step 3

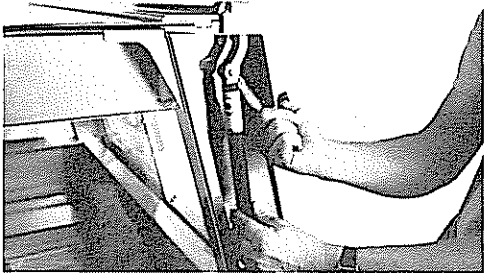

Step 4

WARNING

When removing gas shocks, there is no tension on front glass. Hold glass open and lower carefully if necessary. Failure to do so could result in personal injury.

3. With a 1/8" allen wrench, remove shoulder bolt from bottom of gas shock and let shock hang.
4. Unthread shock from upper head of gas shock.
5. Install new gas shock.

5-15. FUSE AND FUSE HOLDER

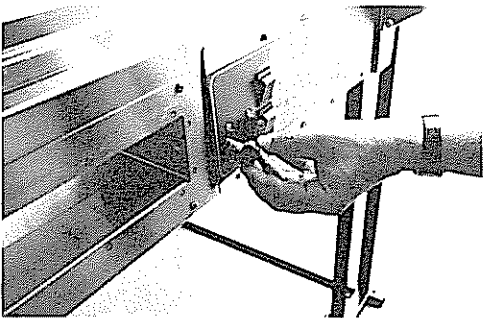

Step 2

WARNING

Place power switch in OFF position, shut off the power at the fuse or breaker box. Failure to do so could result in electrical shock.

1. Remove cap from the fuse holder by turning it counterclockwise.
2. Pull fuse from holder.
3. Install new fuse and replace cap.

5-16. POWER AND LIGHT SWITCH

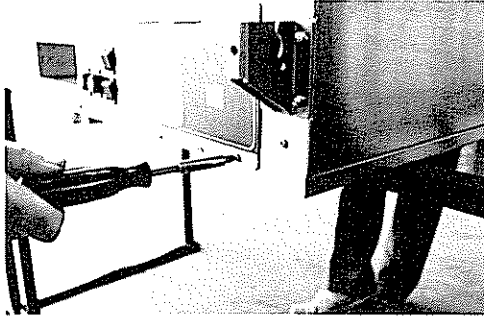

Step 1

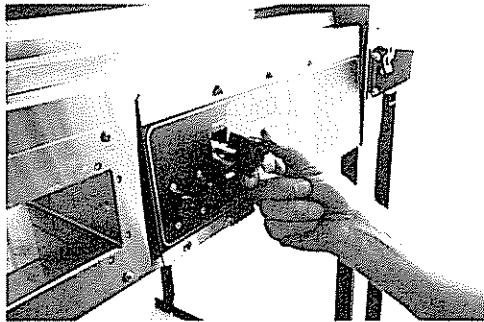

Step 2

WARNING

Place power switch in OFF position, shut off the power at the fuse or breaker box. Failure to do so could result in electrical shock.

1. Remove wires from switch.

NOTE

Mark wires before removing.

2. Pushing in on retainers, push switch out through front of unit.
3. Install new switch and replace wires.

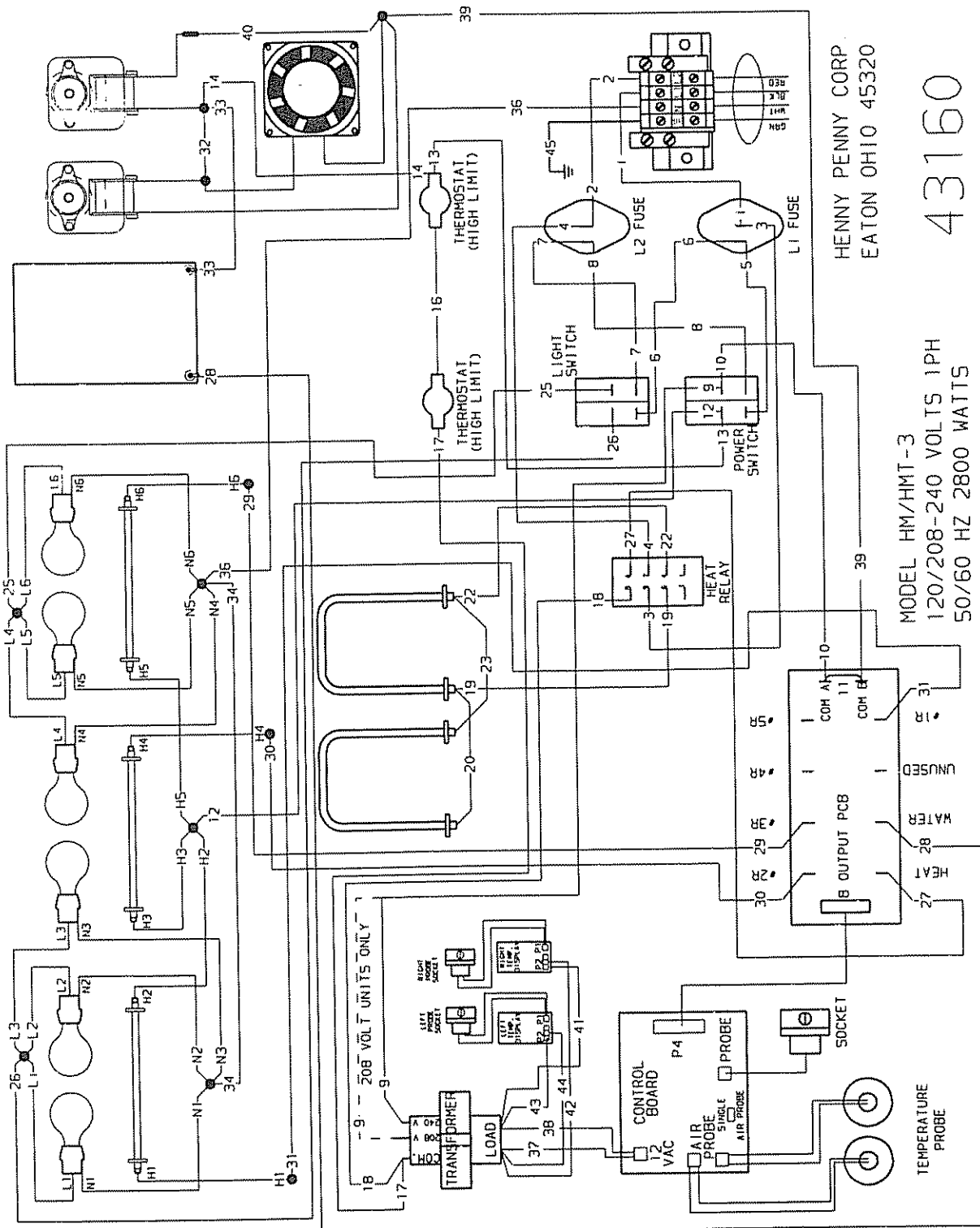

HENNY PENNY CORP.
EATON OHIO 45320

MODEL HM/HMT-3
120/208-240 VOLTS 1PH
50/60 HZ 2800 WATTS

43160

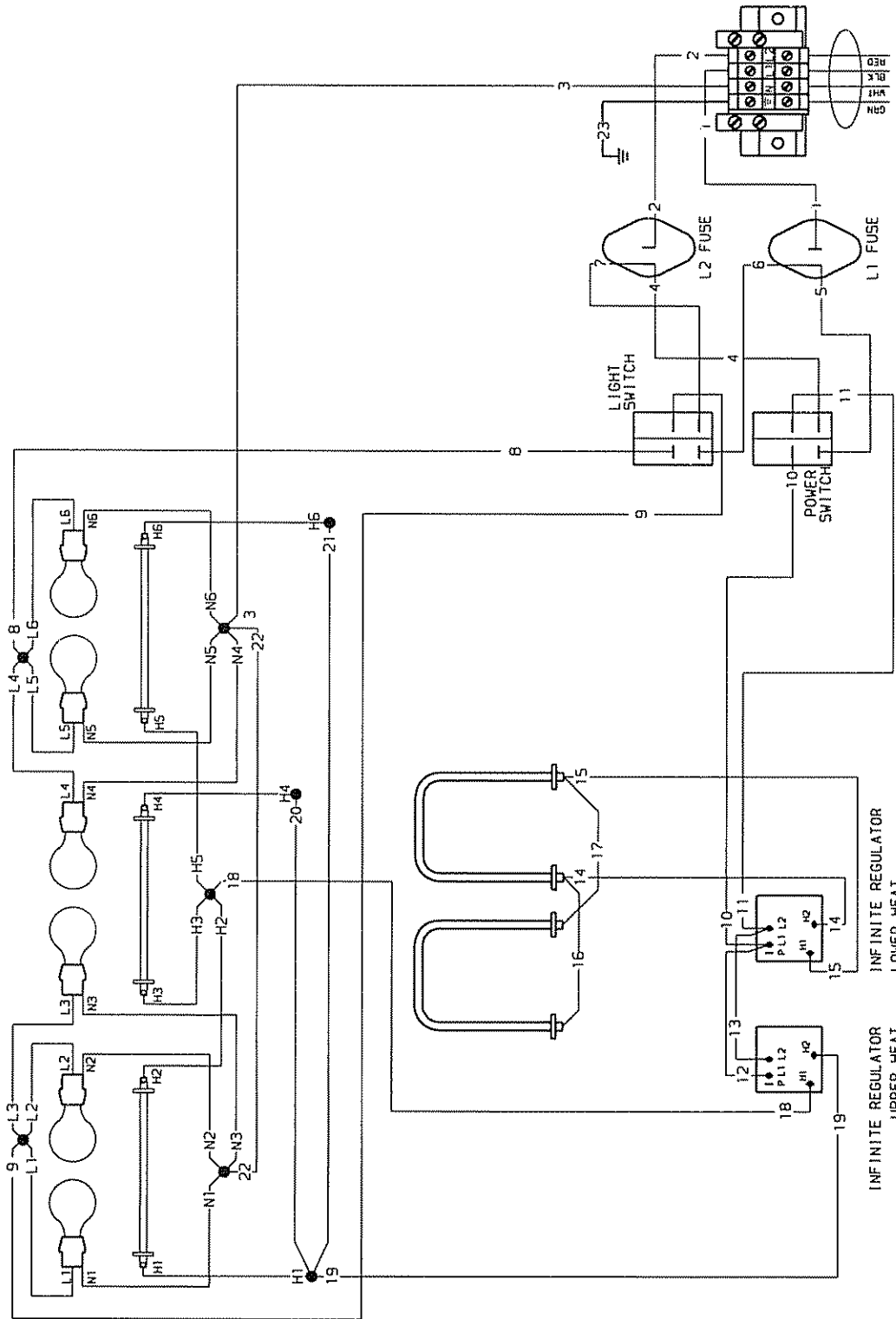

HENNY PENNY CORP.
EATON OHIO 45320

MODEL HS/HST-3 2400 WATTS
120/208-240 VOLTS 3+G
50/60 HZ SINGLE PHASE

38389

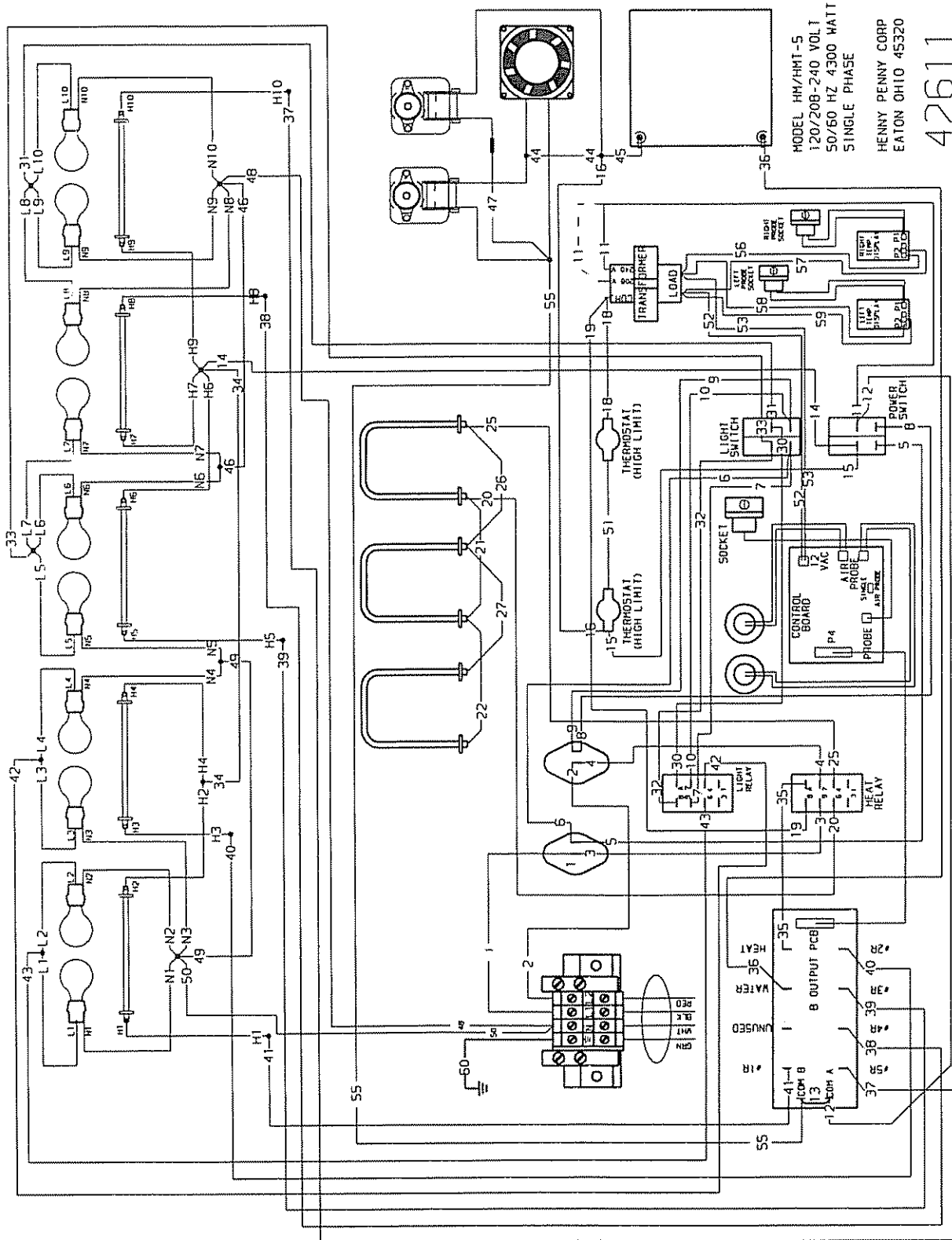

MODEL HM/HMT-5
120/208-240 VOL I
50/60 HZ 4300 WATT
SINGLE PHASE
HENNY PENNY CORP
EATON OHIO 45320

42611

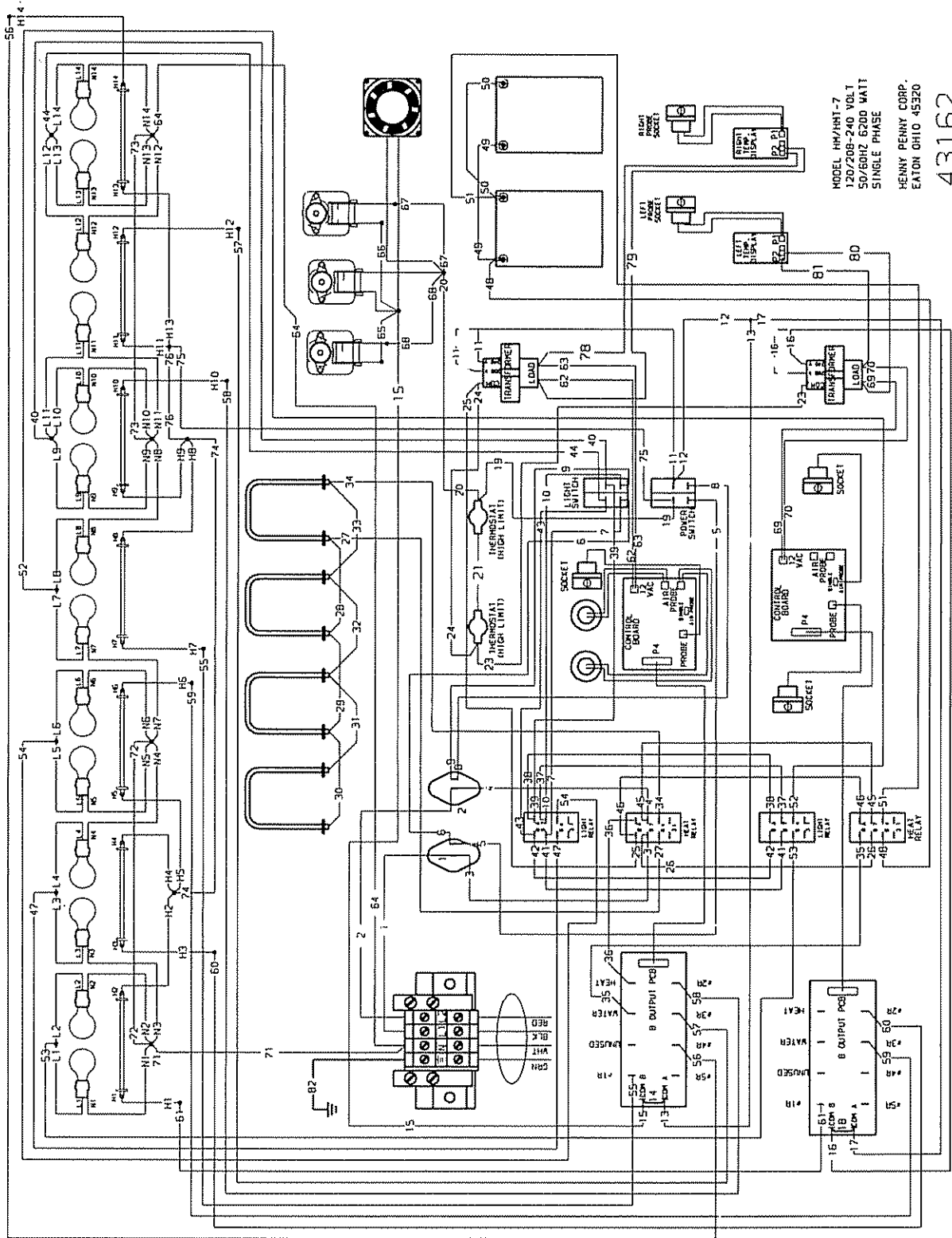

MODEL HM/HMT-7
120/208-240 VOLTS
50/60HZ 6200 WATT
SINGLE PHASE
HENNY PENNY CORP.
EATON OHIO 45320

43162

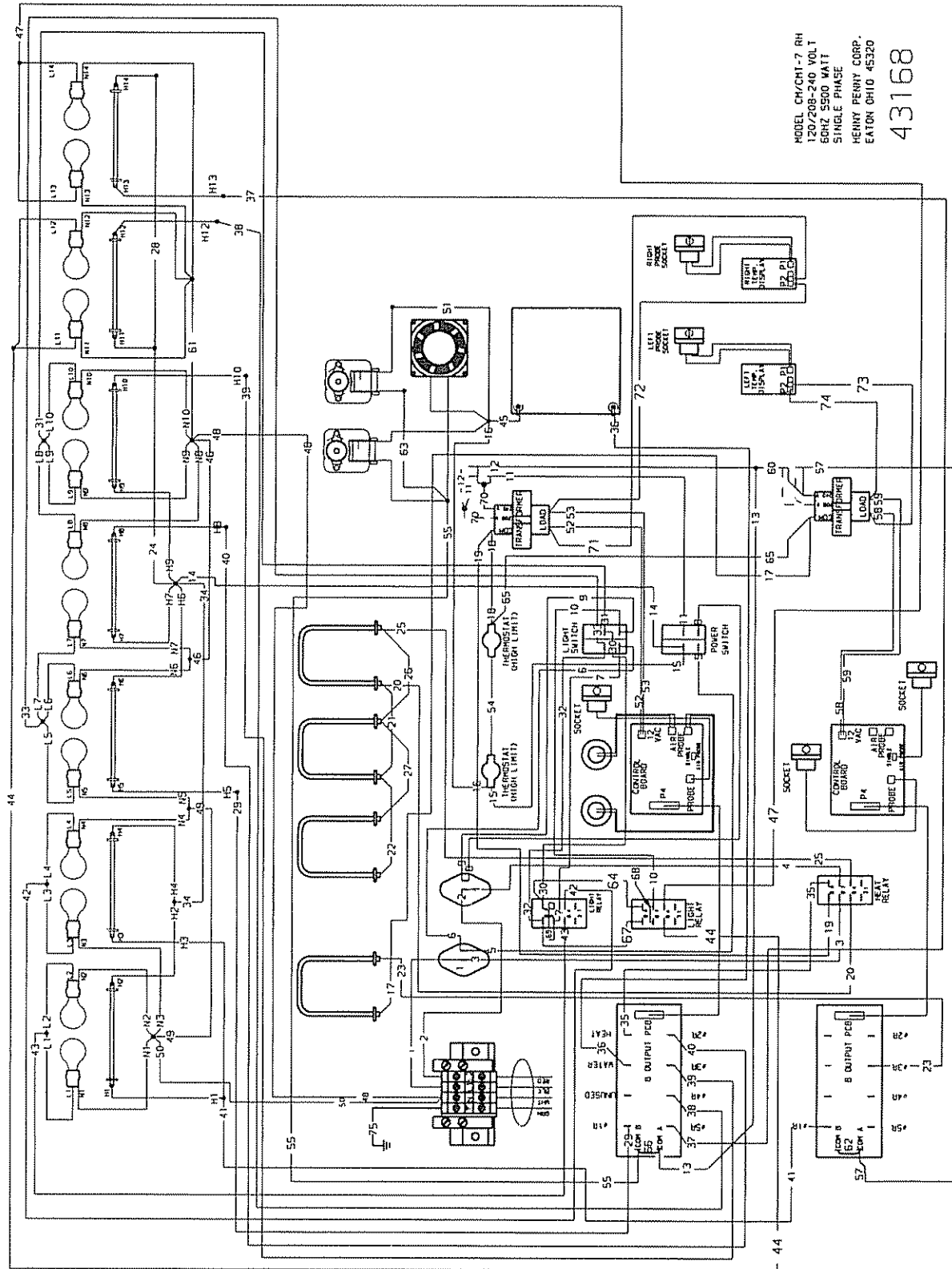

MODEL CH/CMT-7 RH
120/208-240 VOLT
60HZ 5500 WATT
SINGLE PHASE
HENNY PENNY CORP.
EATON OHIO 45320
43168

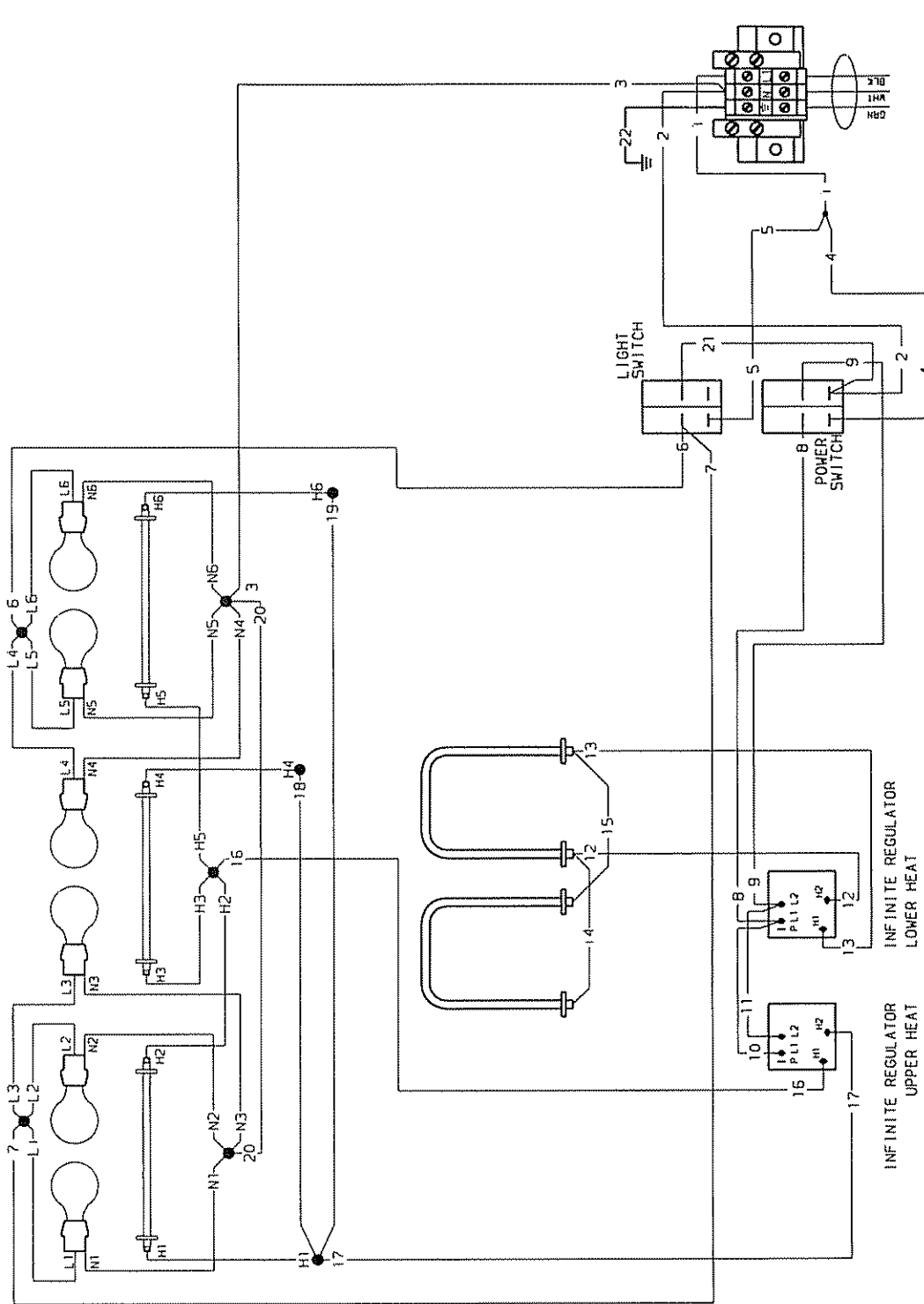

HENNY PENNY CORP.
EATON OHIO 45320

MODEL HS/HST-3
2400 WATTS 220-240 VOLTS
50/60 HZ 1 PH, 2+G WIRE

39330

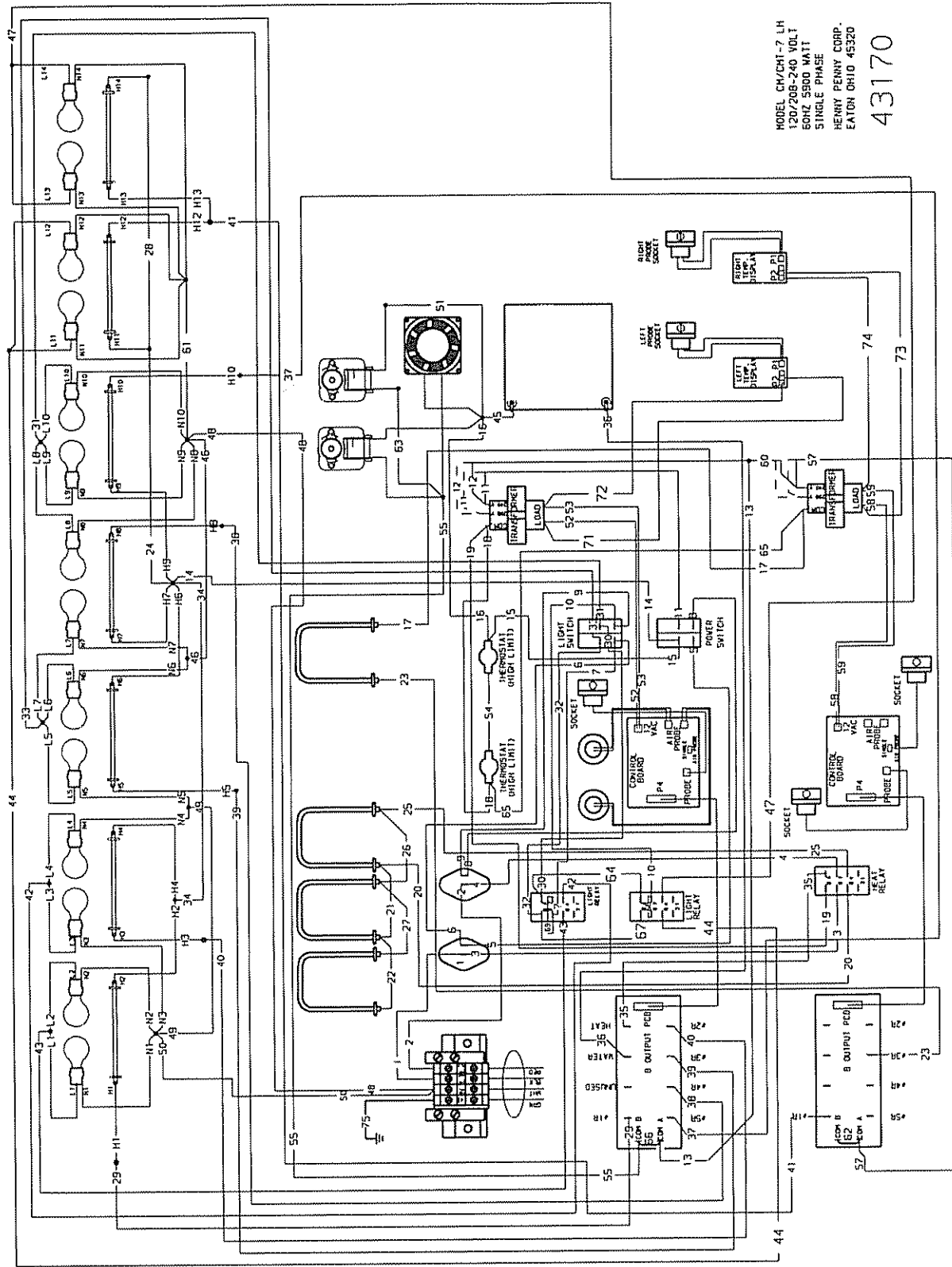

MODEL CM/CMT-7 LH
120/208-240 VOLT
60HZ 5500 WATT
SINGLE PHASE
HENNY PENNY CORP.
EATON OHIO 45320

43170

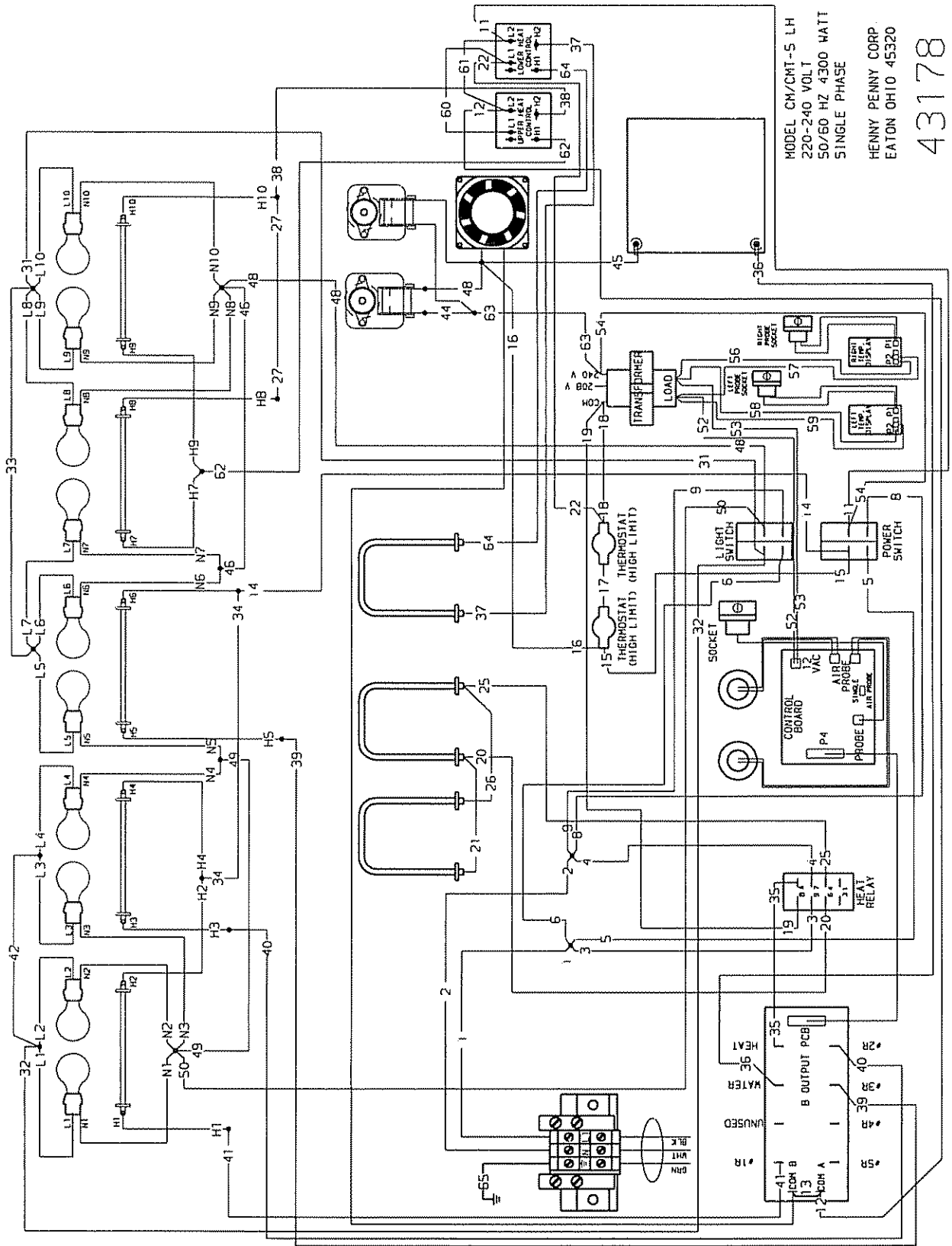

MODEL CM/CMT-5 LH
 220-240 VOLT
 50/60 HZ 4300 WATT
 SINGLE PHASE
 HENNY PENNY CORP.
 EATON OHIO 45320

43178

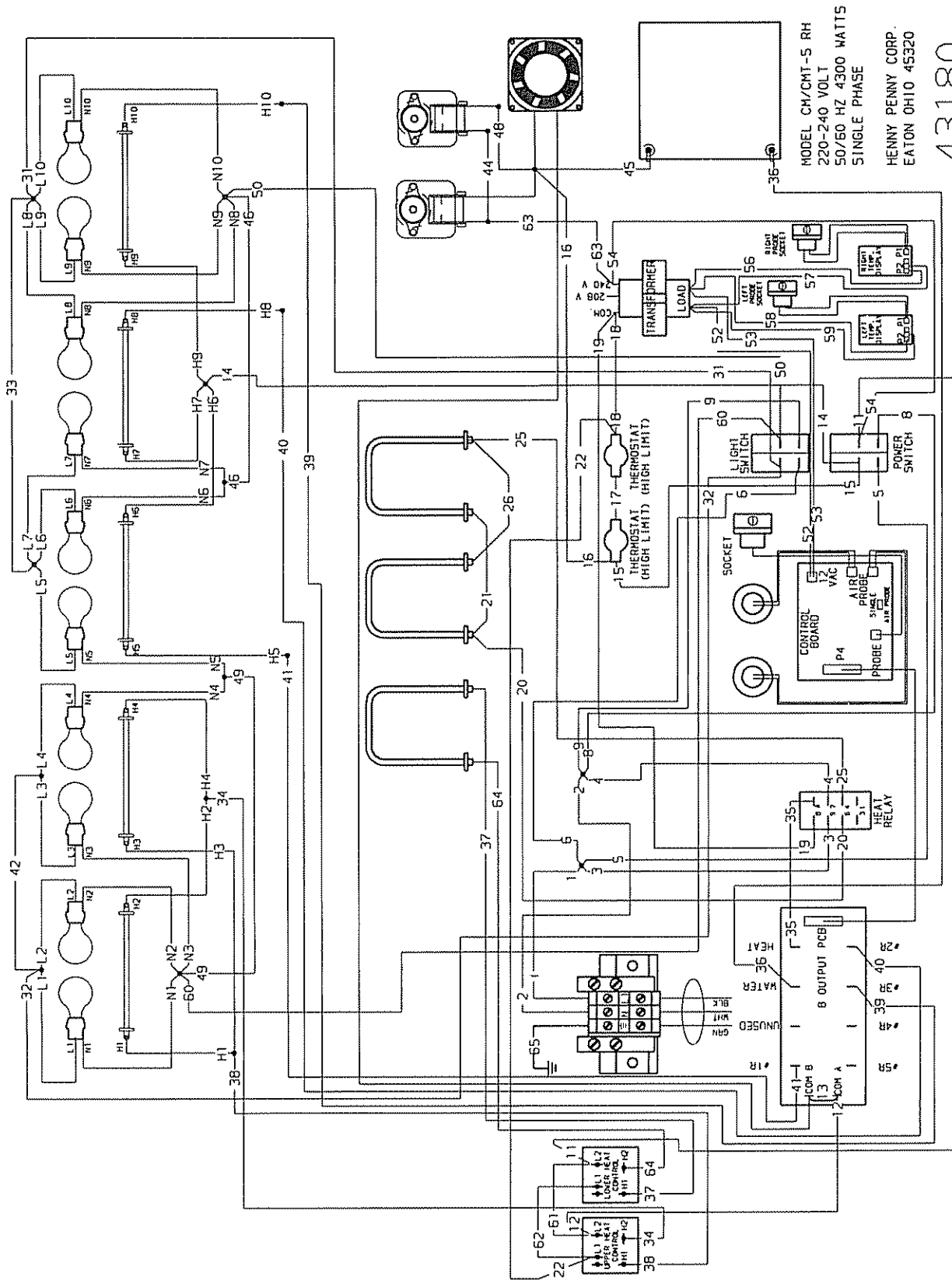

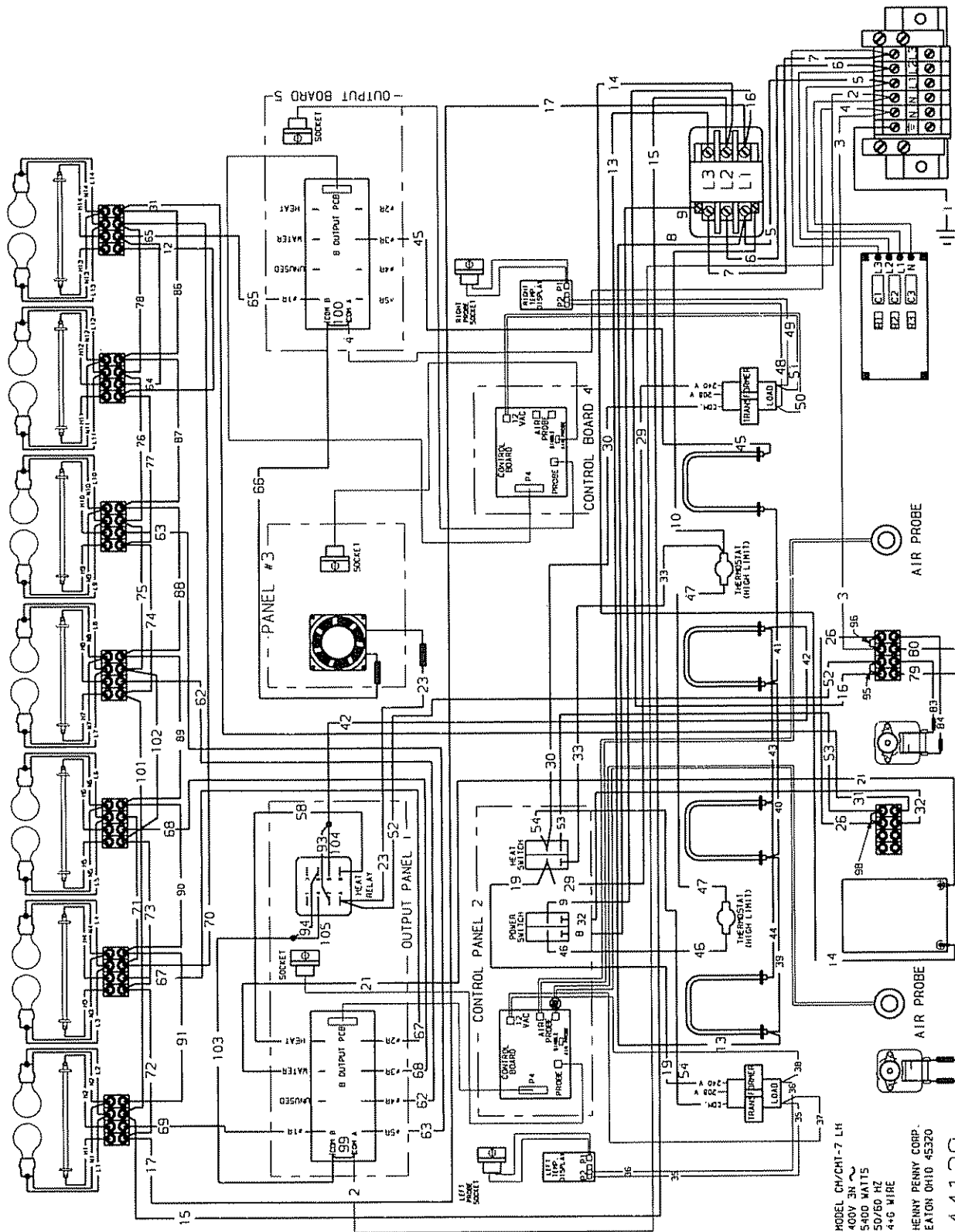

MODEL CM/CHT-7 LH
 400V 3Ø ~
 5400 WATTS
 50/60 HZ
 4*6 WIRE
 HENNY PENNY CORP.
 EATON OHIO 45320

44129

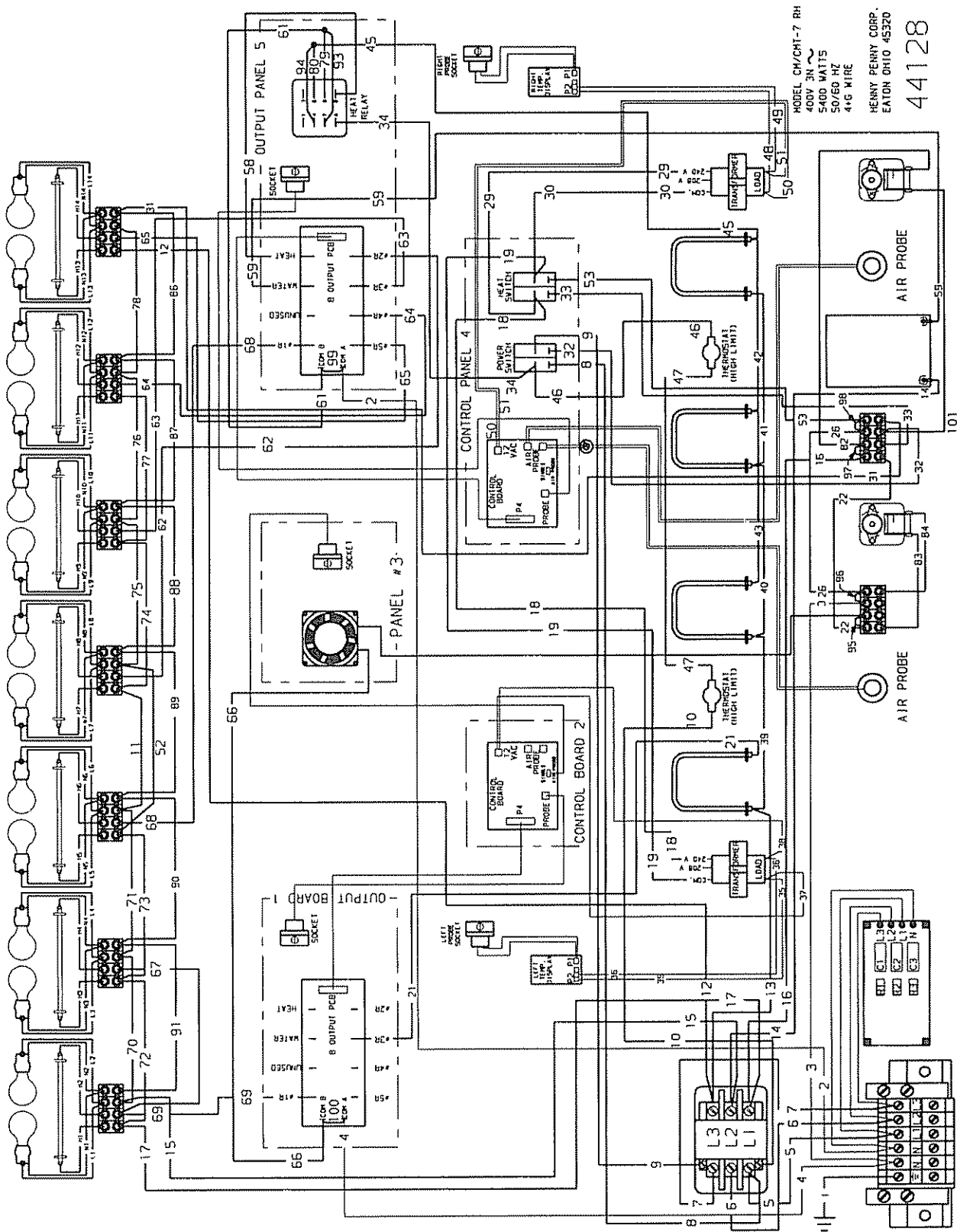

MODEL CH/CHT-7 RH
400V 3N
5400 WATTS
50/60 HZ
4-G WIRE
HENNY PENNY CORP.
EATON ONTO 45320
44128

MODEL HM/HMT-5
400 V, 3N
50/60 HZ 4000 WATTS

HENNY PENNY CORP.
EATON OHIO 45320
41365

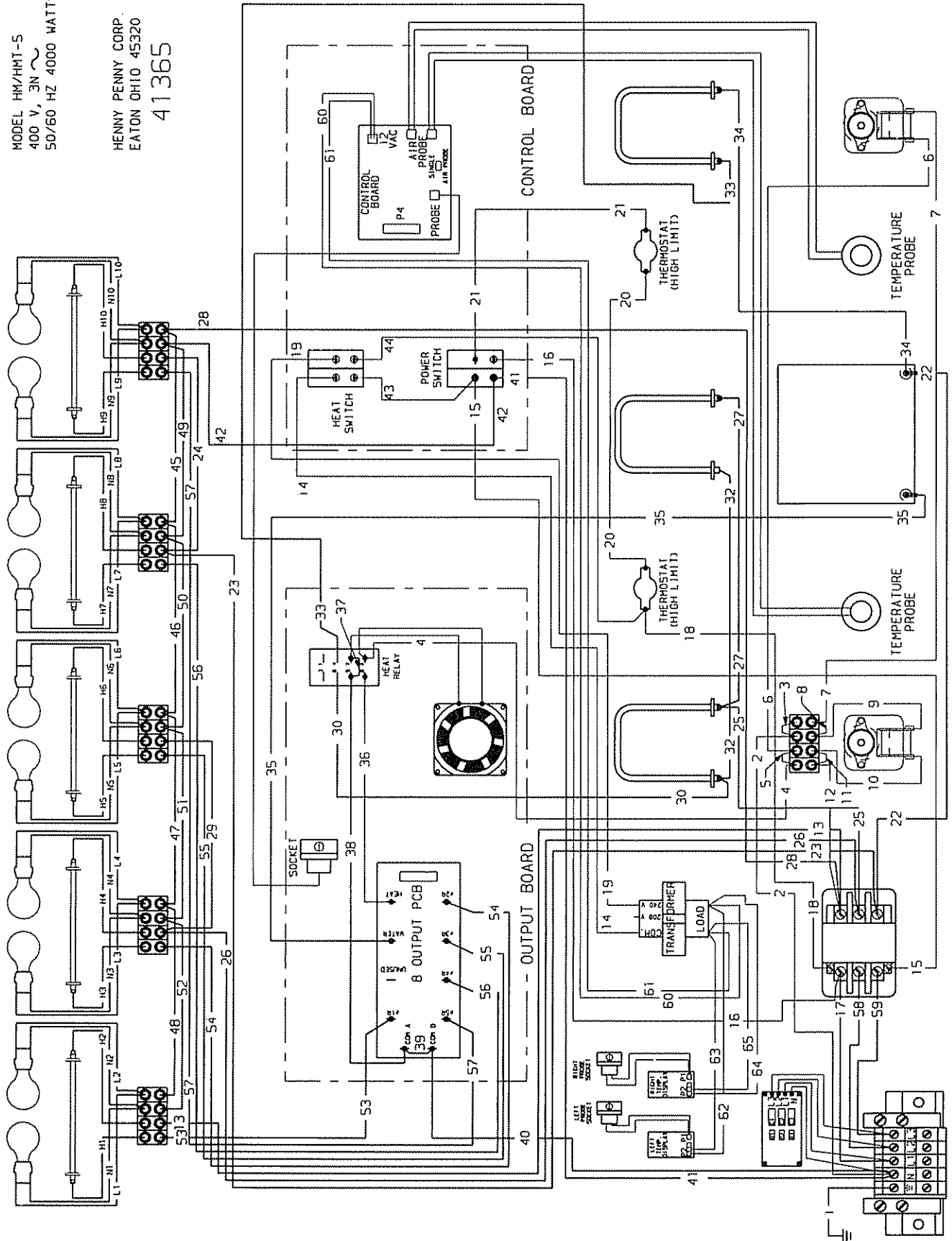

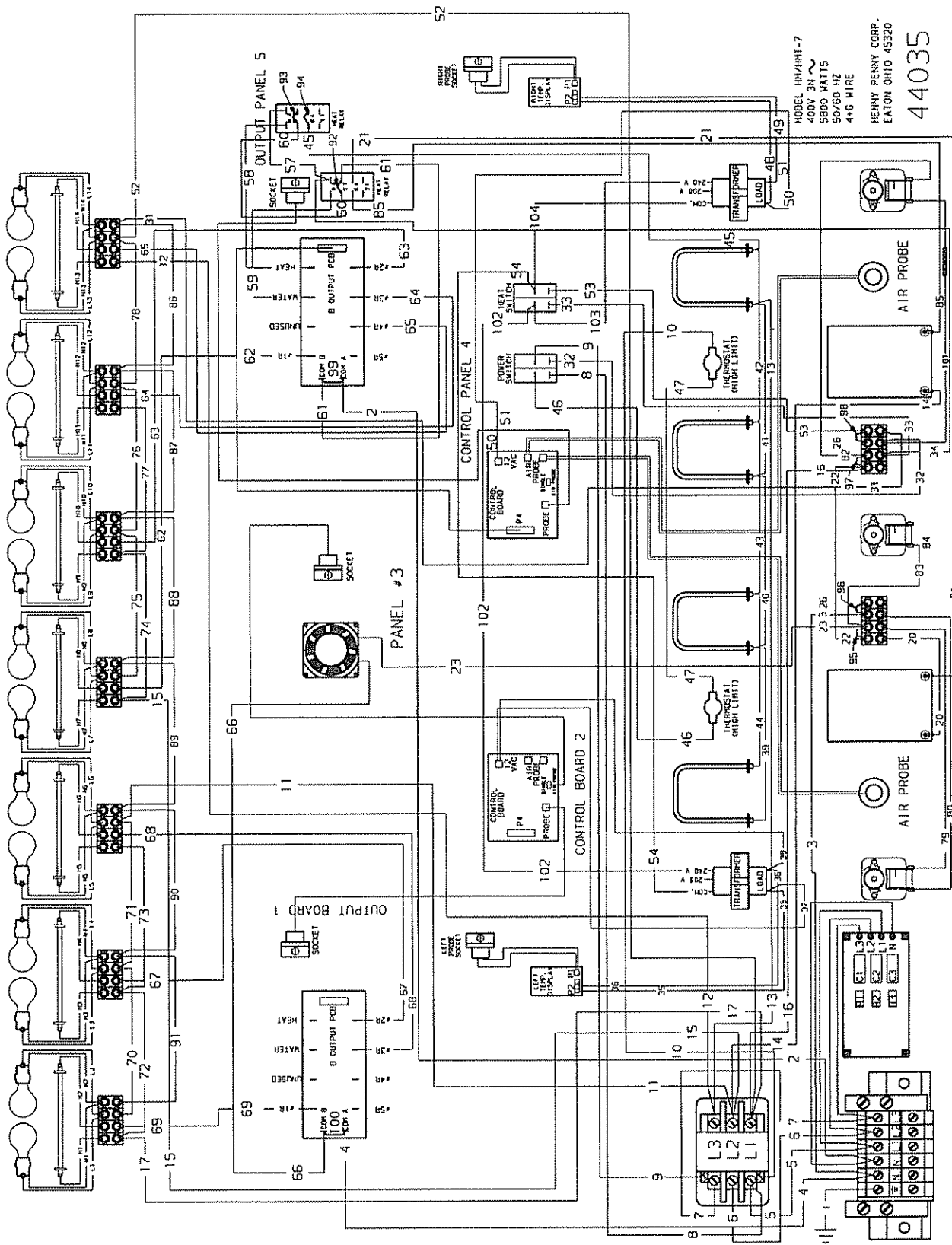

MODEL HM/HMT-7
400Y 3H
5600 WATT'S
50/60 HZ
4*6 WIRE
HENNY PENNY CORP.
EATON OHIO 45320
44035

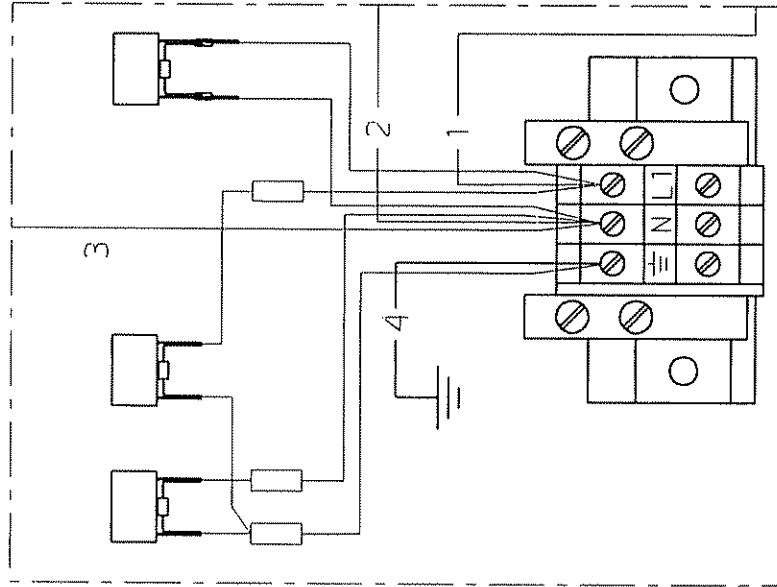

TERMINAL BLOCK CONNECTIONS
2 x SCALE

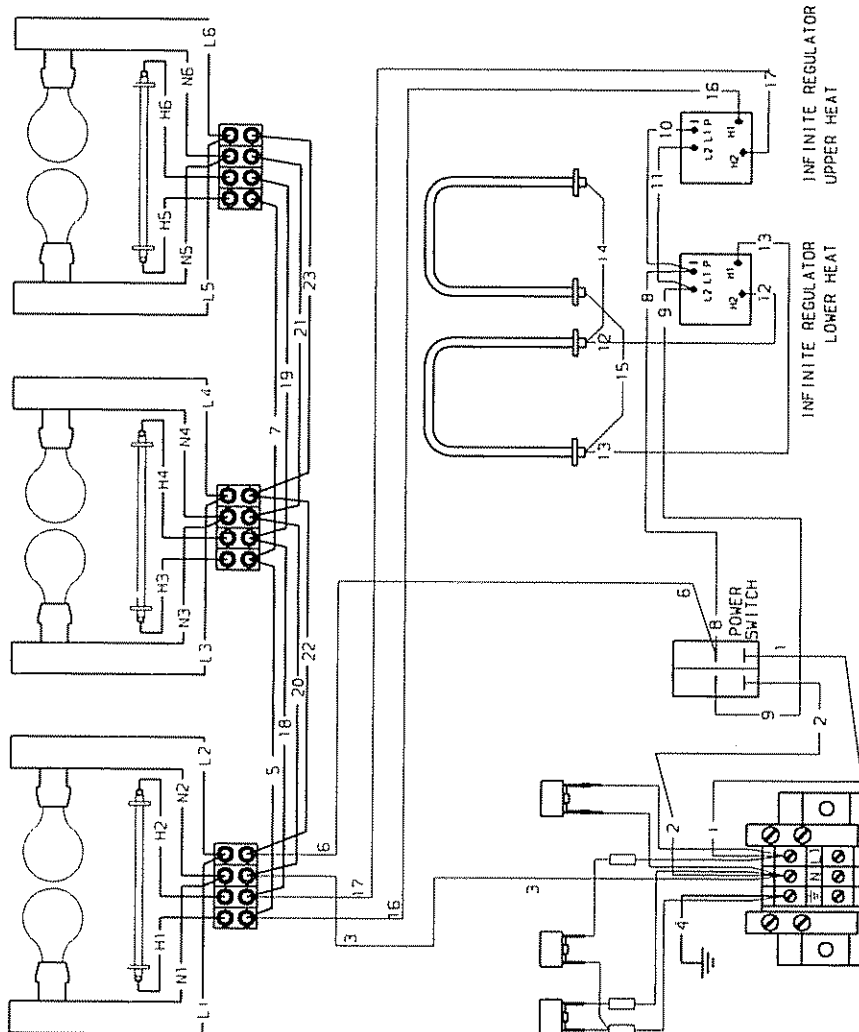

HENNY PENNY CORP.
EATON OHIO 45320

MODEL HS/HST-3 1N~
2300 WATTS 230 VOLTS
50/60 HZ

45513

MODEL H5/HST-5
400 V. 3 ϕ ~
50/60 HZ 3300 WATTS

HENNY PENNY CORP.
EATON OHIO 45320
44088

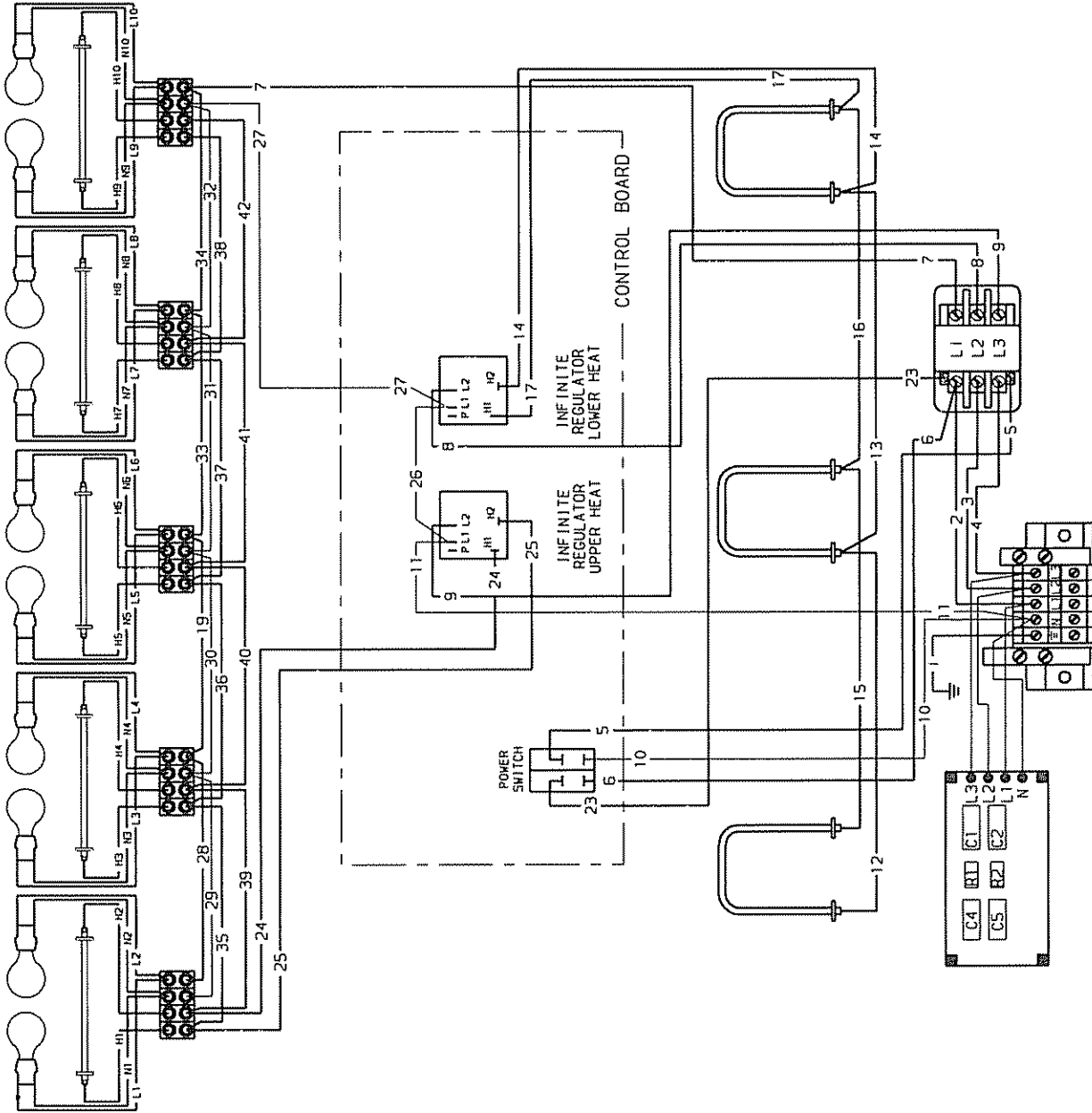

MODEL HM/HMT-3
 230 VOLT, 1N ~
 50/60 HZ, 2800 WATT
 HENNY PENNY CORP
 EATON, OHIO 45320

41437

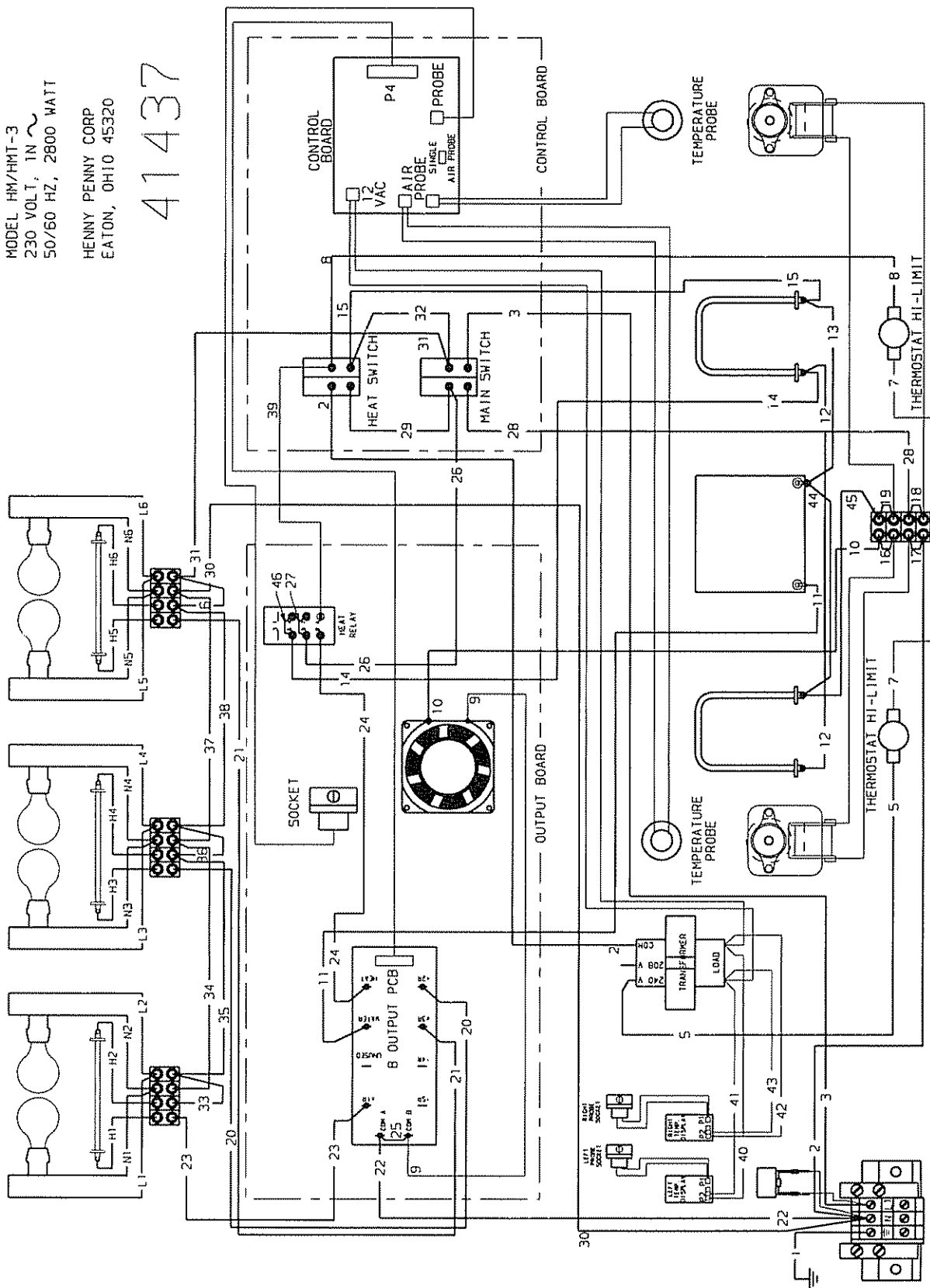

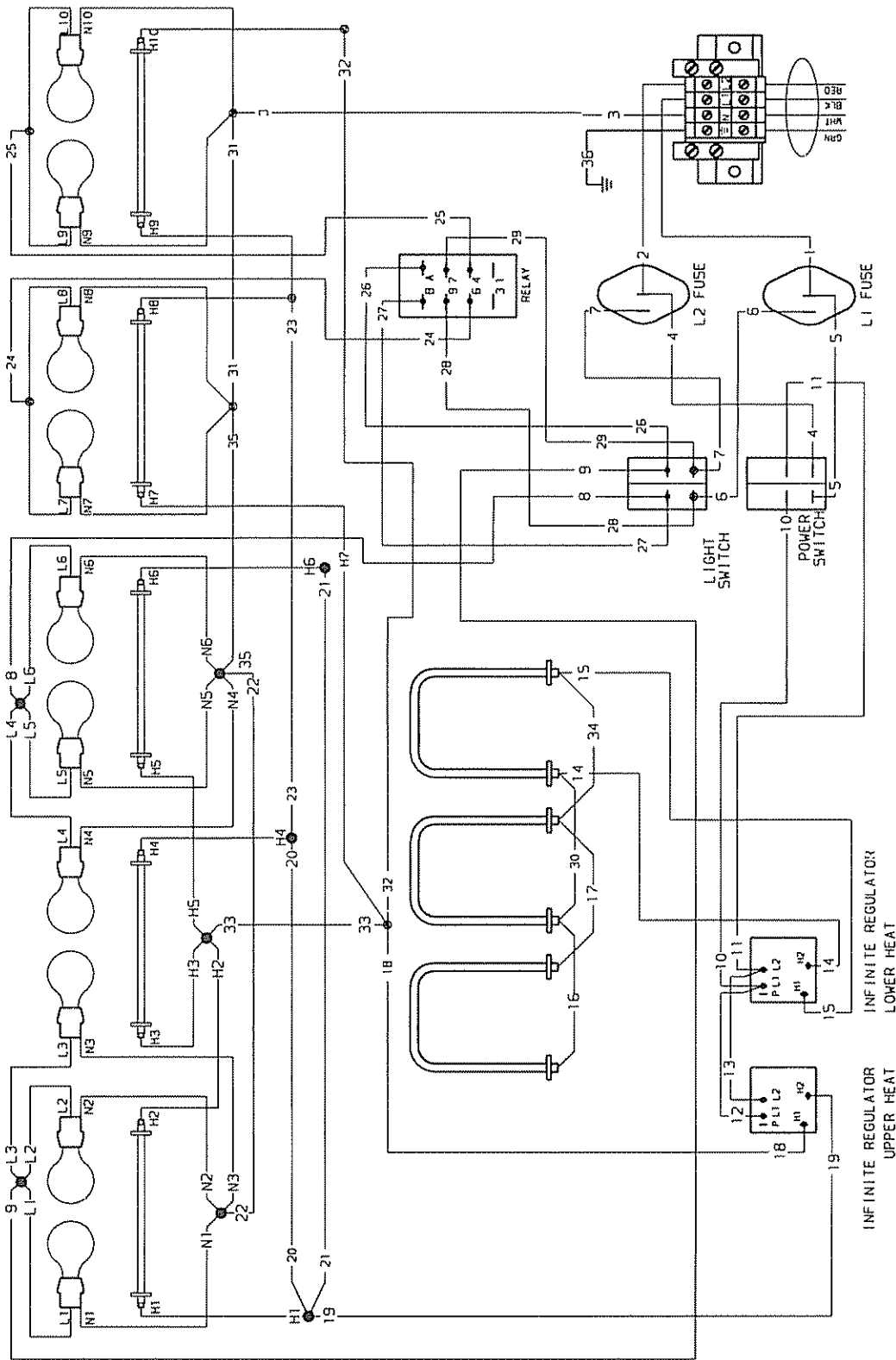

HENNY PENNY CORP.
EATON OHIO 45320

MODEL HS/HST-5 3800 WATTS
15.8 AMP 120/208-240 VOLT
50/60 HZ SINGLE PHASE

42249

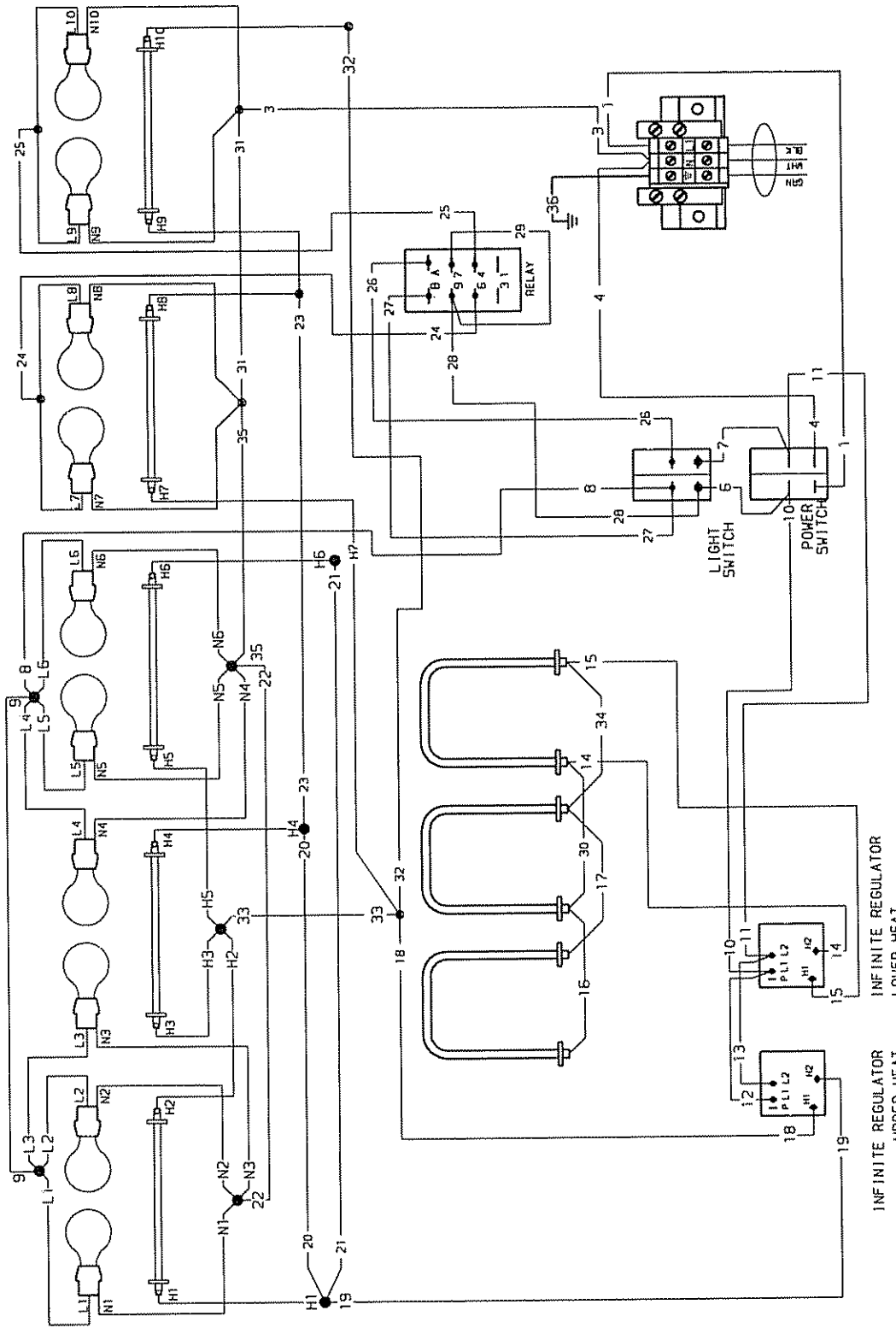

HENNY PENNY CORP.
EATON OHIO 45320

42250

MODEL HS/HST-5 3800 WATTS
15.8 AMP 230 VOLT
50/60 HZ SINGLE PHASE

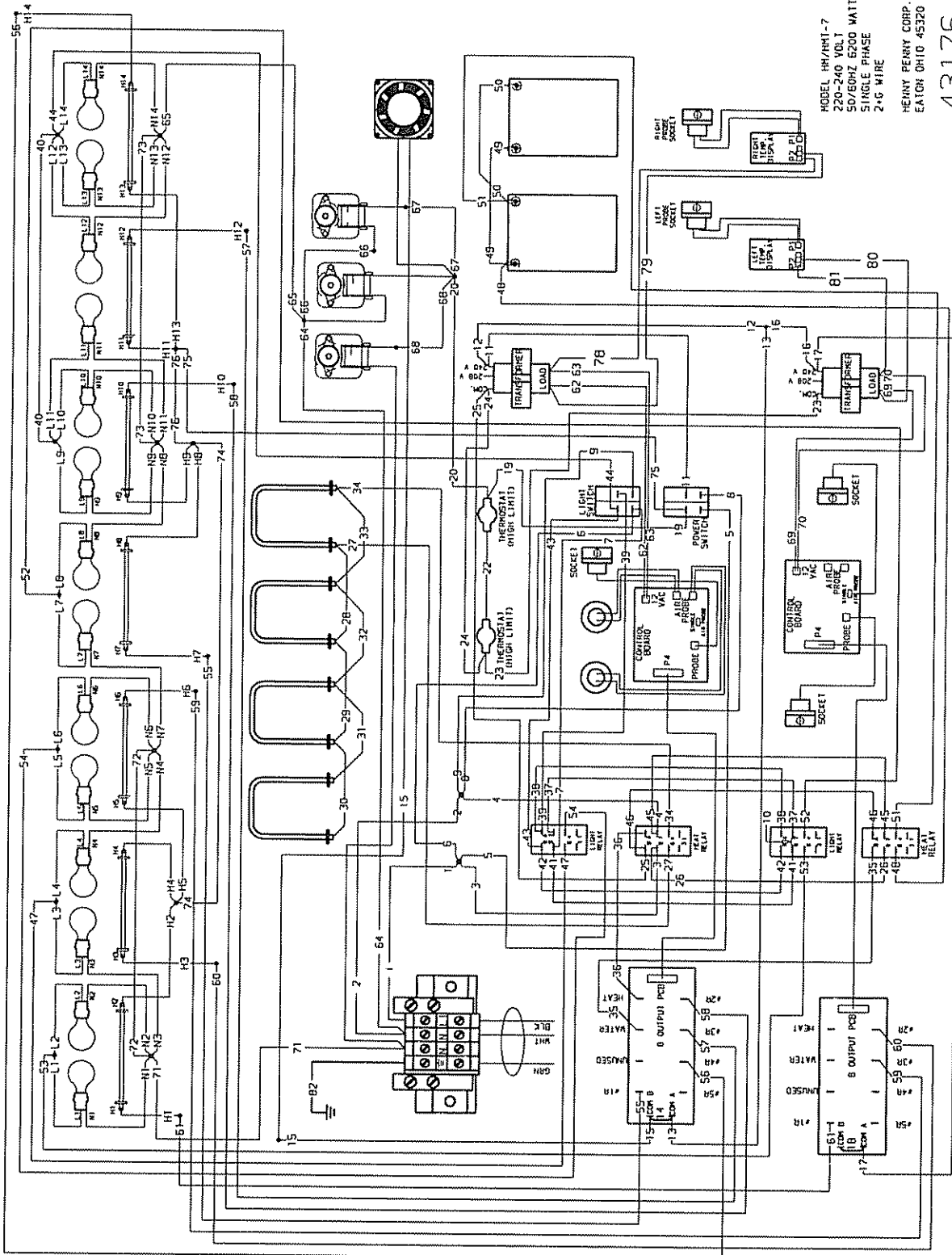

MODEL HM/HMT-7
220-240 VOLTS
50/60HZ 6200 WATT
SINGLE PHASE
2-1/8 WIRE
HENNY PENNY CORP.
EATON OHIO 45320

43176

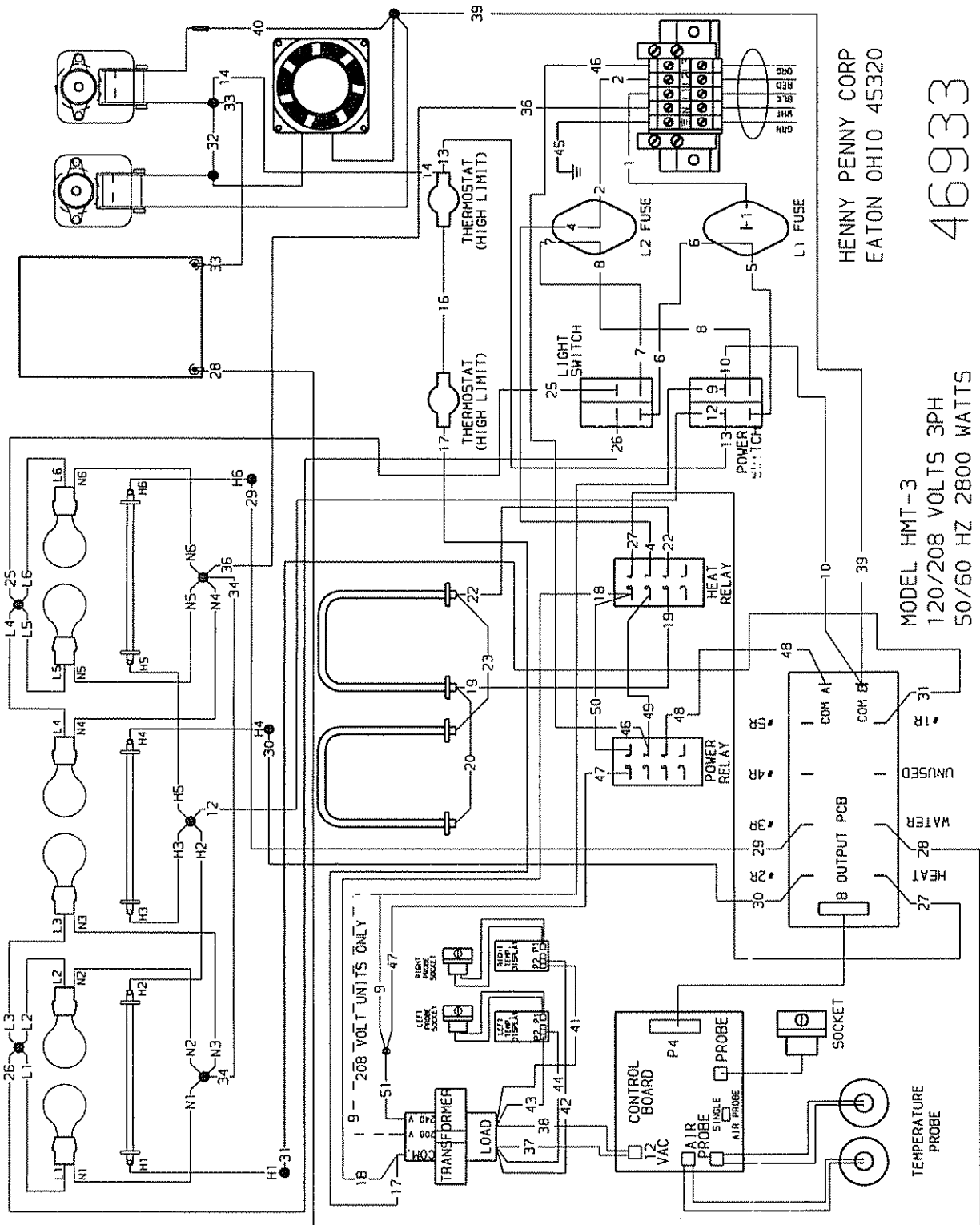

HENNY PENNY CORP
EATON OHIO 45320

46933

MODEL HMT-3
120/208 VOLTS 3PH
50/60 HZ 2800 WATTS

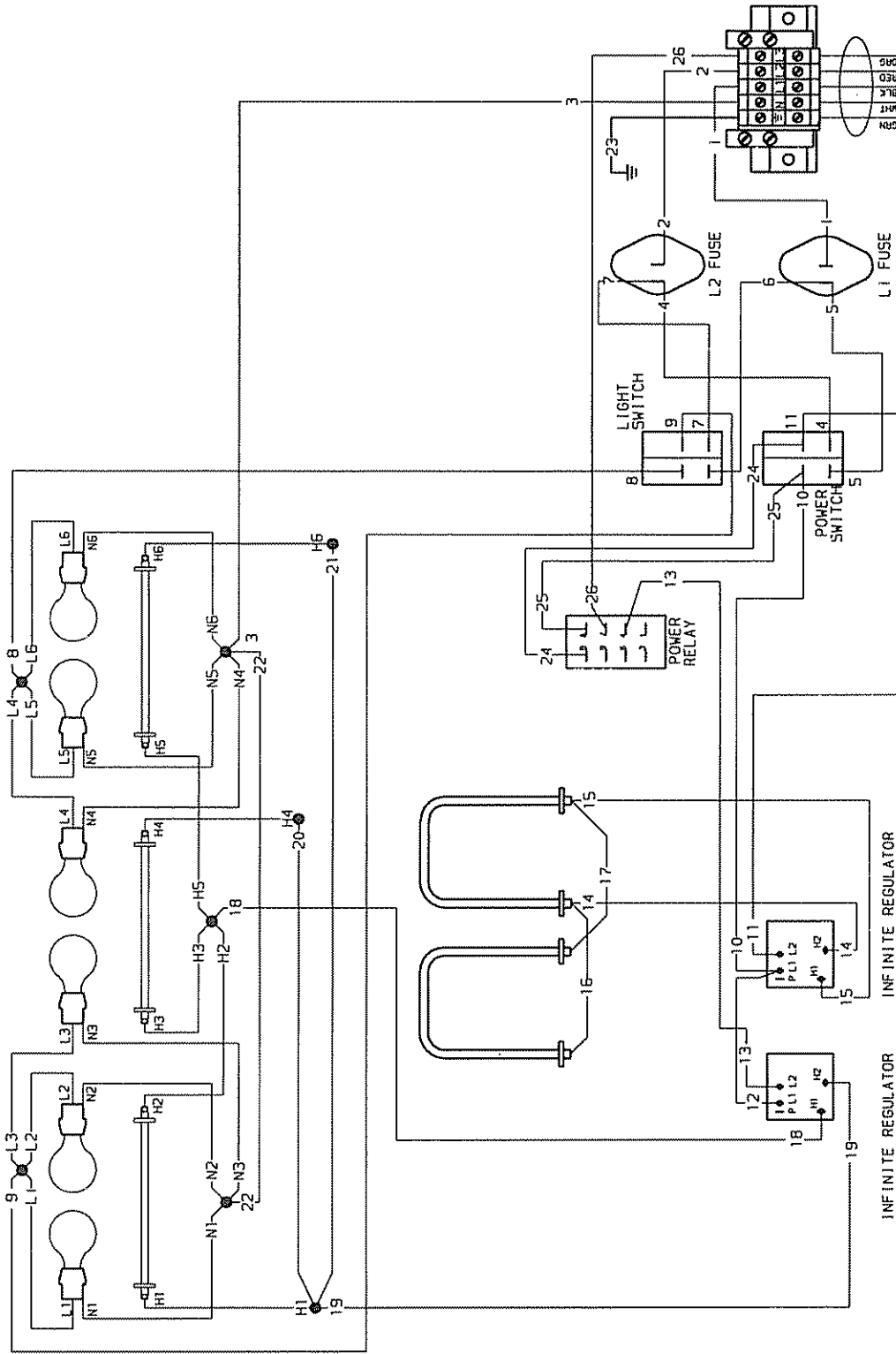

HENNY PENNY CORP.
EATON OHIO 45320

MODEL HST-3
120/208 VOLTS 3PH
50/60 HZ 2400 WATTS

46935

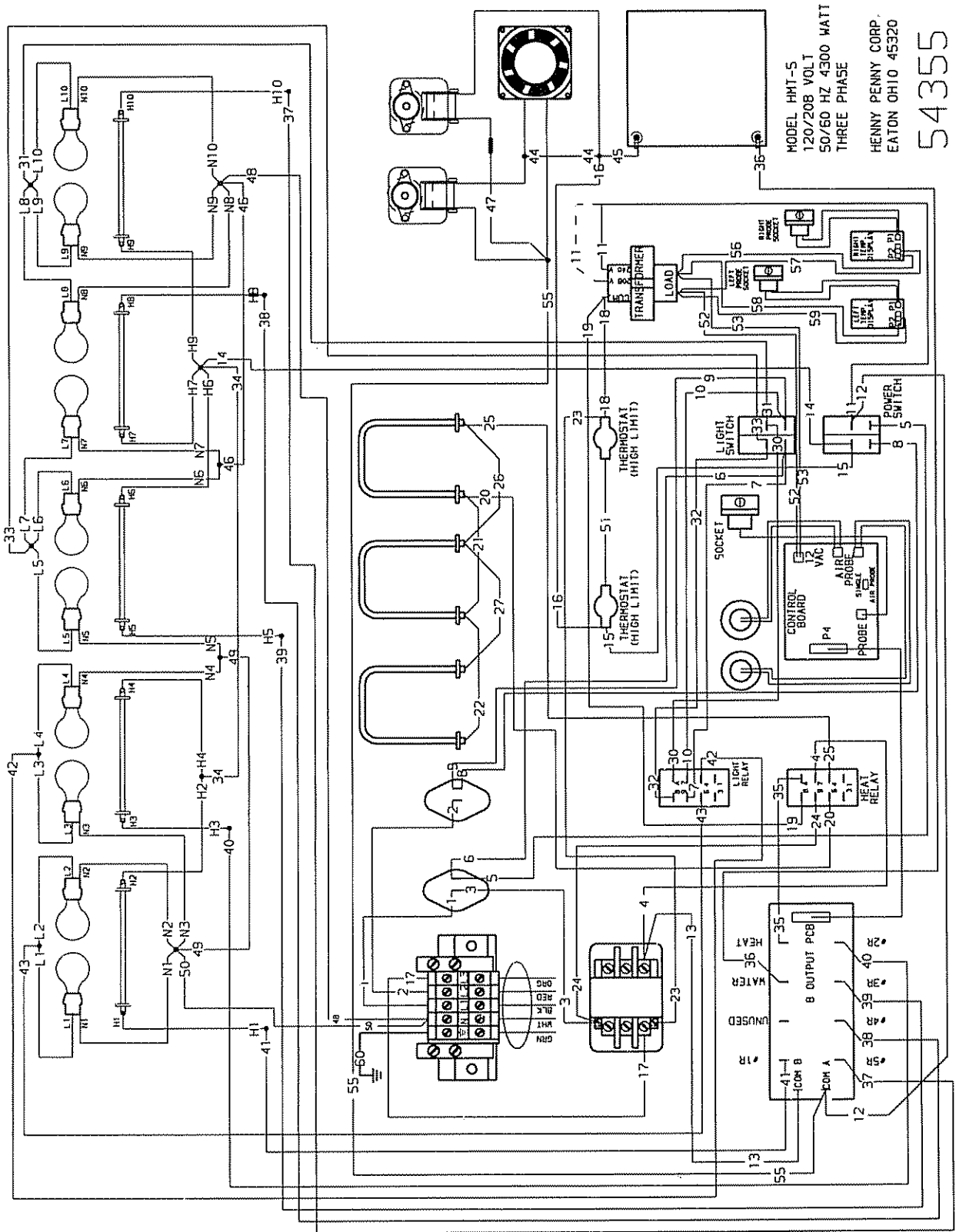

MODEL HMT-5
120/208 VOLT
50/60 HZ 4300 WATT
THREE PHASE
HENNY PENNY CORP.
EATON OHIO 45320
54355

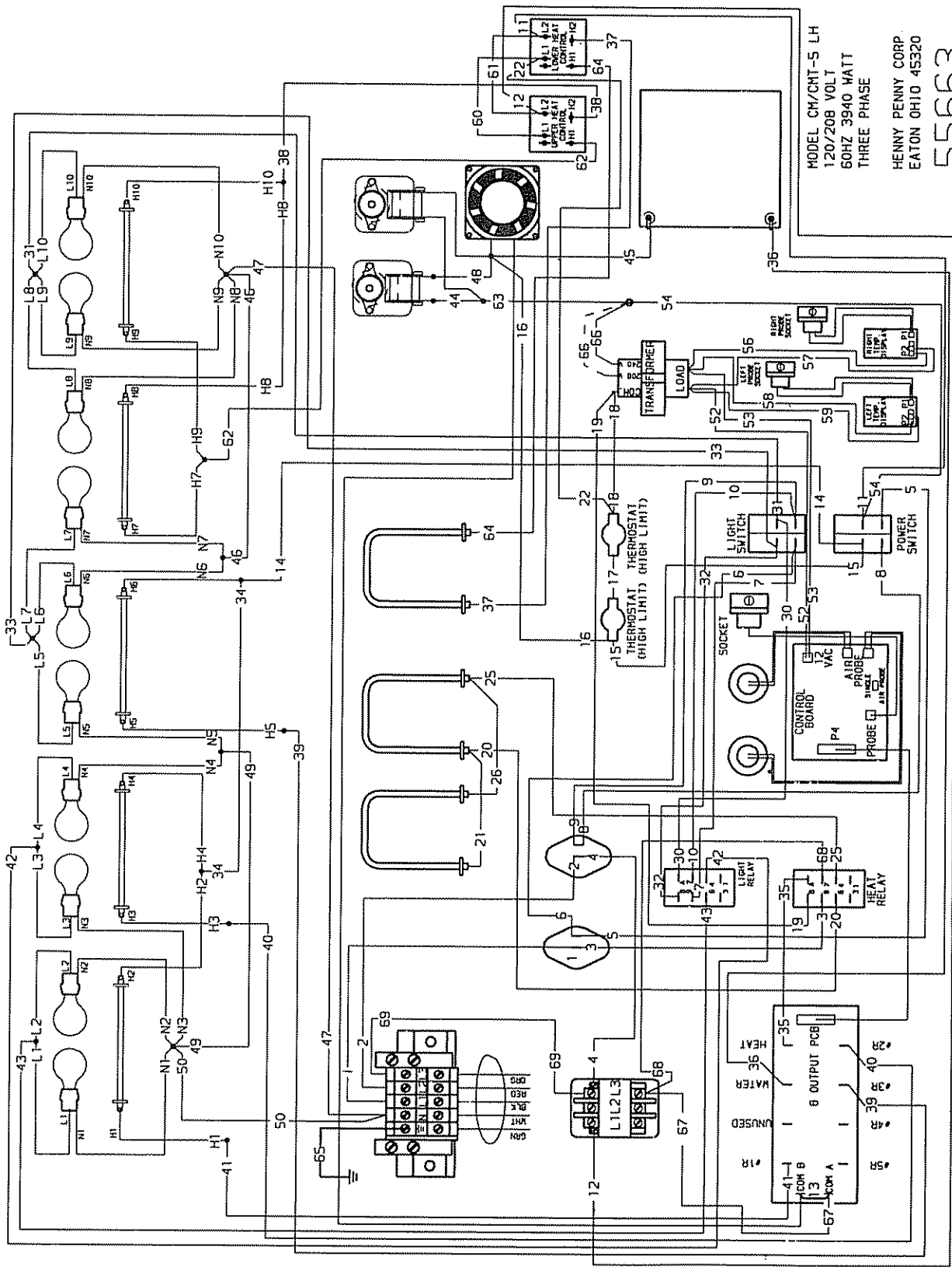

MODEL CM/CMT-5 LH
120/208 VOLT
60HZ 3940 WATT
THREE PHASE
HENNY PENNY CORP.
EATON OHIO 45320
55663

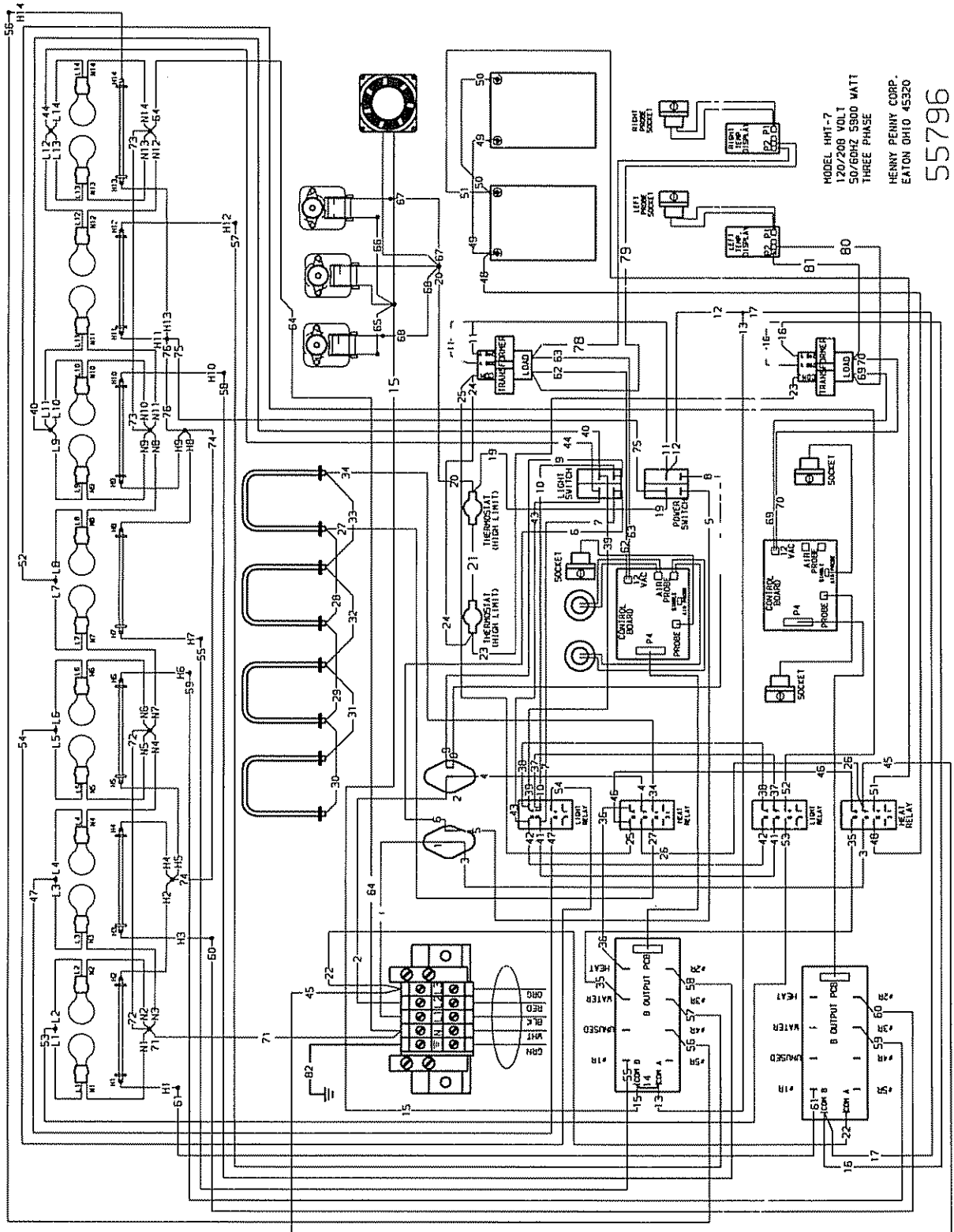

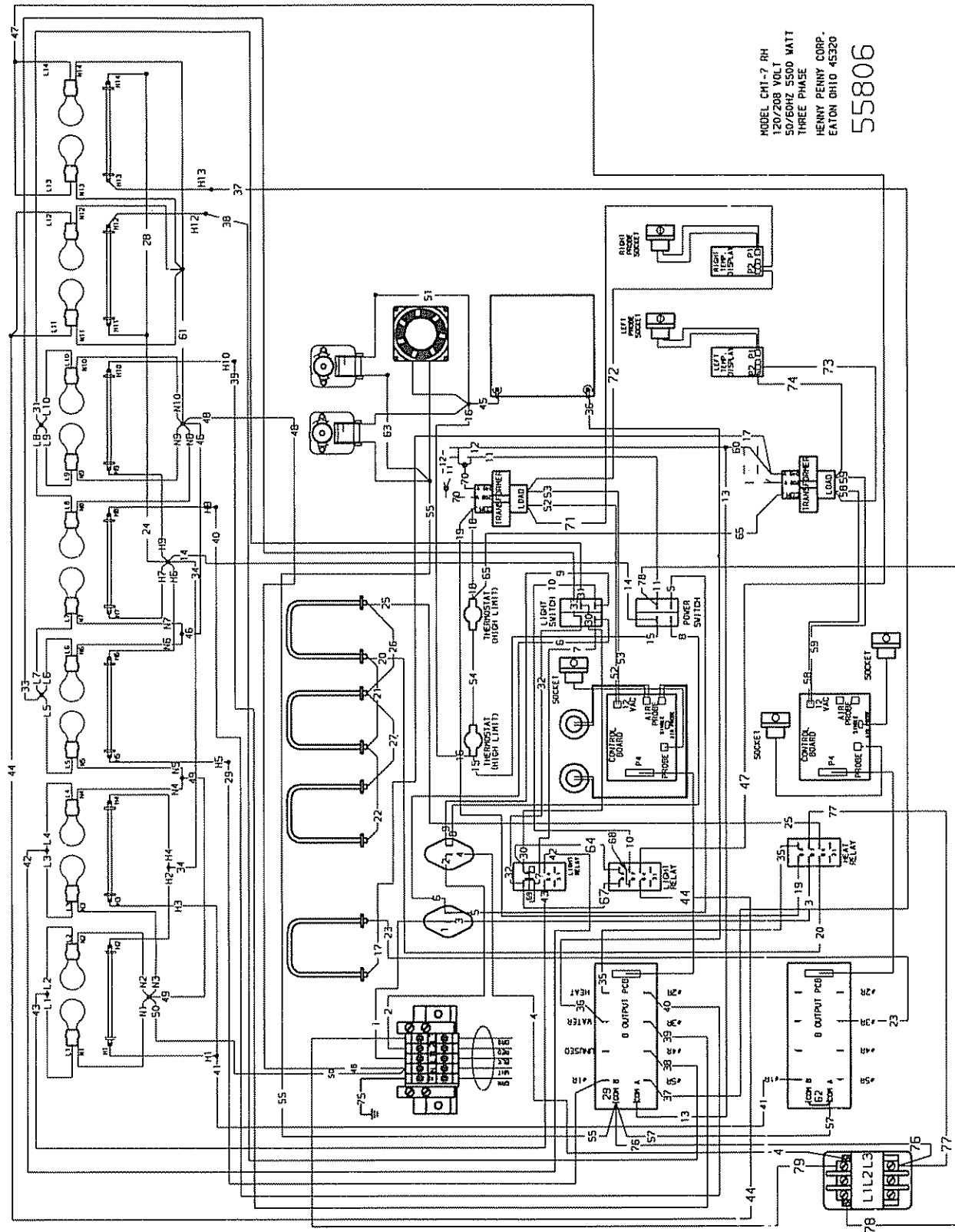

MODEL CMT-7 RH
120/208 VOLT
50/60HZ 5500 WATT
THREE PHASE
HENNY PENNY CORP.
EATON OHIO 45320
55806

LIMITED WARRANTY FOR HENNY PENNY APPLIANCES

Subject to the following conditions, Henny Penny Corporation makes the following limited warranties to the original purchaser only for Henny Penny appliances and replacement parts:

NEW EQUIPMENT: Any part of a new appliance, except lamps and fuses, which proves to be defective in material or workmanship within two (2) years from date of original installation, will be repaired or replaced without charge F.O.B. factory, Eaton, Ohio, or F.O.B. authorized distributor. To validate this warranty, the registration card for the appliance must be mailed to Henny Penny within ten (10) days after installation.

REPLACEMENT PARTS: Any appliance replacement part, except lamps and fuses, which proves to be defective in material or workmanship within ninety (90) days from date of original installation will be repaired or replaced without charge F.O.B. factory, Eaton, Ohio, or F.O.B. authorized distributor.

The warranty for new equipment and replacement parts covers only the repair or replacement of the defective part and does not include any labor charges for the removal and installation of any parts, travel or other expenses incidental to the repair or replacement of a part.

EXTENDED FRYPOT WARRANTY: Henny Penny will replace any frypot that fails due to manufacturing or workmanship issues for a period of up to seven (7) years from date of manufacture. This warranty shall not cover any frypot that fails due to any misuse or abuse, such as heating of the frypot without shortening.

0 TO 3 YEARS: During this time, any frypot that fails due to manufacturing or workmanship issues will be replaced at no charge for parts, labor, or freight. Henny Penny will either install a new frypot at no cost or provide a new or reconditioned replacement fryer at no cost.

3 TO 7 YEARS: During this time, any frypot that fails due to manufacturing or workmanship issues will be replaced at no charge for the frypot only. Any freight charges and labor costs to install the new frypot as well as the cost of any other parts replaced, such as insulation, thermal sensors, high limits, fittings, and hardware, will be the responsibility of the owner.

Any claim must be presented to either Henny Penny or the distributor from whom the appliance was purchased. No allowance will be granted for repairs made by anyone else without Henny Penny's written consent. If damage occurs during shipping, notify the sender at once so that a claim may be filed.

THE ABOVE LIMITED WARRANTY SETS FORTH THE SOLE REMEDY AGAINST HENNY PENNY FOR ANY BREACH OF WARRANTY OR OTHER TERM. BUYER AGREES THAT NO OTHER REMEDY (INCLUDING CLAIMS FOR ANY INCIDENTAL OR CONSEQUENTIAL DAMAGES) SHALL BE AVAILABLE.

The above limited warranty does not apply (a) to damage resulting from accident, alteration, misuse, or abuse; (b) if the equipment's serial number is removed or defaced; or (c) for lamps and fuses. THE ABOVE LIMITED WARRANTY IS EXPRESSLY IN LIEU OF ALL OTHER WARRANTIES, EXPRESS OR IMPLIED, INCLUDING MERCHANTABILITY AND FITNESS, AND ALL OTHER WARRANTIES ARE EXCLUDED. HENNY PENNY NEITHER ASSUMES NOR AUTHORIZES ANY PERSON TO ASSUME FOR IT ANY OTHER OBLIGATION OR LIABILITY.

SECTION 6. TROUBLESHOOTING

6-1. INTRODUCTION

This section provides troubleshooting information in the form of an easy to read table.

If a problem occurs during the first operation of a new unit, recheck the installation per Section 2 of this manual.

Before troubleshooting, always recheck the operating procedure per Section 3 of this manual.

6-2. TROUBLESHOOTING

To isolate a malfunction, proceed as follows:

1. Clearly define the problem (or symptom) and when it occurs.
2. Locate the problem in the troubleshooting table.
3. Review all possible causes. Then, one-at-a-time work through the list of corrections until the problem is solved.

WARNING

Refer to the maintenance procedures in Section 5 to safely and properly make the checkout and repair needed. If maintenance are not followed correctly, injuries and/or property damage could result.

PROBLEM	CAUSE	CORRECTION
With power switch in POWER position, unit is completely inoperative (NO POWER)	<ul style="list-style-type: none"> • Open Circuit • Control board defective. • Transformer defective. 	<ul style="list-style-type: none"> • Check to see that unit is plugged in. • Check breaker or fuse at supply box. • Check control panel fuses per paragraph 5-15. • Check voltage at wall receptacle. • Check MAIN POWER switch per section 5-16. Replace if defective. • Check cord and plug for loose connections • Check for 12 volt input from transformer. Replace if defective. • Check input and output voltage. Replace if defective.
Unit will not heat	<ul style="list-style-type: none"> • Control board not calling for heat. • Power on, board has no display. 	<ul style="list-style-type: none"> • Check set point reading. If unit below setpoint and not calling for heat, control board defective. • Hi limit tripped. Check for defective hi limit, or defective blower motor.
No air heat.	<ul style="list-style-type: none"> • Faulty heat relay. • Faulty air heater. • Unit not pre heated 	<ul style="list-style-type: none"> • Check and replace per section 5-11. • Check and replace per section 5-6. • Pre heat unit with pans in place before loading product.

PROBLEM	CAUSE	CORRECTION
No radiant heat.	<ul style="list-style-type: none"> • Faulty input/output board. • Faulty radiant heater. 	<ul style="list-style-type: none"> • Replace input/output board. • Replace radiant heater per section 5-3.
No water heat.	<ul style="list-style-type: none"> • Faulty input/output board. • Faulty water heater. 	<ul style="list-style-type: none"> • Replace input/output board. • Replace water heater per section 5-5.
No lights.	<ul style="list-style-type: none"> • Light switch defective. • Light relay defective • Light socket shorted • Light bulb blown 	<ul style="list-style-type: none"> • Replace per section 5-16. • Replace per section 5-11 (Same as heat relay) • Replace per section 5-4. • Replace light bulb.
Canopy glass fogging.	<ul style="list-style-type: none"> • Air blowers not circulating heated air across glass. • Water heat setting too high. • Radiant heat setting too low. 	<ul style="list-style-type: none"> • Replace blower motor per section 5-7. • Lower water heat setting as per section 4. • Raise radiant heat setting as per section 4.
Product not holding temperature.	<ul style="list-style-type: none"> • Doors are left open. • Heat settings too low. • Low or improper voltage. • Product held too long. • Product not placed correctly in unit. 	<ul style="list-style-type: none"> • Keep doors closed except to load and unload product. • Adjust heat settings as per section 4. • Using meter, compare receptacle voltage to data plate voltage. • Hold product only for recommended time. • Place product in unit as per section 3-3.

SECTION 6. PARTS INFORMATION

HM-3/5/7 Service Parts List

Part No.	Number	Description	Qty. Per Unit		
			3	5	7
1	37000	Front Viewing Glass - 3 Pan (Before July 1, 1994)	1	-	-
1	54033	Front Viewing Glass Assy. - Complete - 3 Pan	1	-	-
1	37001	Front Viewing Glass Assy. - 5 Pan (Before July 1,1994)	-	1	-
1	54031	Front Viewing Glass Assy. - Complete - 5 Pan	-	1	-
1	39027	Front Viewing Glass Assy. - 7 Pan (Before July 1,1994)	-	-	2
1	54129	Front Viewing Glass Assy. Complete - RH - 7 Pan	-	-	1
1	54130	Front Viewing Glass Assy. Complete - LH - 7 Pan	-	-	1
2	68256	Sliding Door Assembly - 3 Pan	2	-	-
2	68334	Sliding Door Assembly - 5 Pan	-	2	-
2	68346	Sliding Door Assembly - 7 Pan	-	-	2
3	37638	Water Pan Assembly (Before July 1, 1994)	1	1	2
3	41507	Water Pan Assembly	1	1	2
4	40833*	Probe Bracket	1	1	2
√ 5	42440*	Temperature Probe PC Board Assy.	1	1	2
√ 6	39216	Blower Motor	2	2	3
√ 7	40097	Series Regulating Thermostat	2	2	2
√ 8	28979	Transformer	1	1	2
9	PL01-006*	Plug - Bottom	2	2	2
10	18135	End Clamp	2	2	2
11	MS01-162	Mounting Channel	-	-	-
12	22609	Terminal Block	3	3	3
13	22610	Barrier	2	2	2
14	ME50-003*	Spacer	2	2	2
15	NS03-013*	Cage Nut	4	4	4
16	EF02-040*	Bushing - Snap	2	2	2
17	37230	Bracket - Drop Shelf	2	2	4
18	37757	Side Viewing Panel	2	2	2
18	42969	Side Viewing Panel - (Mir)-Left	2	2	2
18	43794	Side Viewing Panel - (Mir)-Right	2	2	2
19	39974	Fan Blade	2	2	3
20	16685	Fan Guard	4	4	5
√ 21	37059	Heater - Lower - 240v	2	3	4
√ 21	44976	Heater - Lower - 208v	2	3	4
√ 22	37060	Heater - Water - 240v	1	1	2
√ 22	48020	Heater - Water - 208v	1	1	2
√ 23	39795	Light Socket	6	10	14
√ 23	54041	Light Socket - CE	6	10	14
√ 24	BL01-009	Light Bulb - 120v - 100w	6	10	14
√ 24	BL01-015	Light Bulb - 240v - 60w	6	10	14
√ 25	54181	Heater - Upper Radiant - 240v – “S”-Shaped	3	5	7
√ 25	64257	Heater - Upper Radiant - 208v – “S”-Shaped	3	5	7
26	38413	Decal - Control Panel - 7 Pan - Left	-	-	1
26	37536	Decal - Control Panel - 3 Pan	1	-	-
26	37537	Decal - Control Panel - 5 Pan	-	1	-
26	38412	Decal - Control Panel - 7 Pan	-	-	1
√ 27	36900	PC Board Assembly - Display	1	1	2
√ 28	37127*	Bracket for Plug	1	1	3
√ 29	30723*	Relay - 3 Pan	1	2	4
√ 30	59363	Probe- 5 ft.	1	1	3
√ 31	37815	Receptacle Assy. - Probe (Control Panel)	1	1	3
√ 31	42341	Receptacle Assy. - Probe (Uprights)	2	2	2
√ 32	16688	Cooling Fan	1	1	1
33	37128	Gas Shock - 3 Pan (Before May 1, 1994)	2	-	2

Recommended replacement parts, stocked by your distributor, are indicated with √ in the parts lists. Please use care when ordering recommended parts, because all voltages and variations are marked. Distributors should order parts based upon common voltages and equipment sold in their territory.

√ recommended parts/*not shown

**Front Viewing Glass before July 1, 1994, 02736 Tape Kit must also be ordered.

HM-3/5/7 Service Parts List – Continued

No.	Part Number	Description	Qty. Per Unit		
			3	5	7
33	37129	Gas Shock - 5 Pan (Before May 1, 1994)	-	2	2
33	41751	Gas Shock - 3 Pan	2	-	-
33	41750	Gas Shock - 5 Pan	-	2	-
33	42620	Gas Shock Assy. - 7 Pan	-	-	2
34	43258	Cutting Board - 3 Pan	1	-	2
34	39181	Cutting Board (Poly) - 3 Pan	1	-	2
34	43262	Cutting Board - 5 Pan	-	1	-
34	39840	Cutting Board (Poly) - 5 Pan	-	1	-
35	37841	Power Cord Assy. - 3 Pan	1	-	-
35	37849	Power Cord Assy. - 5 Pan	-	1	-
35	41233	Power Cord Assy. - 7 Pan	-	-	1
36	PN01-016*	Clevis Pin	2	2	4
37	PN01-017*	Cotter Pin	2	2	4
38	LW01-004*	Lockwasher	2	2	4
39	37044	Hinge Cap (Before May 1, 1994)	2	2	3
39	41760	Hinge Cap	2	2	3
40	37231	Hinge Block Assy. (Before May 1, 1994)	2	2	2
40	42088	Hinge Block Assy.	2	2	2
40	39180	Hinge Block Assy. - Center - 7 Pan	-	-	1
41	41154	Hinge Pin	2	2	2
41	39026	Hinge Pin - Center	-	-	2
42	54011	Tape - Acrylic Foam	1	2	2
43	41024	Crank (Before April 1, 1994)	4	4	4
43	42844	Crank	4	4	4
44	37061	Hinge Extrusion - 3 Pan	1	-	-
44	37062	Hinge Extrusion - 5 Pan	-	1	-
44	39008	Hinge Extrusion - 7 Pan - Right	-	-	1
44	39009	Hinge Extrusion - 7 Pan - Left	-	-	1
45	37063	Clamp Extrusion - 3 Pan	1	-	-
45	37064	Clamp Extrusion - 5 Pan	-	1	-
45	39010	Clamp Extrusion - 7 Pan	-	-	1
46	37130	Pivot Support (Before May 1, 1994)	2	2	4
46	41778	Pivot Support	2	2	4
√ 47	EF02-007	Fuse - 15 Amp	2	2	-
√ 47	EF02-083	Fuse - 20 Amp	-	-	2
√ 48	EF02-006	Fuse Holder - 15 Amp	2	2	-
√ 48	EF02-085	Fuse Holder - 20 Amp	-	-	2
√ 49	43768	Power Switch	2	2	2
√ 51	37770RB	PC Board - Output	1	1	2
52	SC06-045*	Shoulder Screw	1	1	2
53	37184	Lower Track - 3 Pan	1	-	-
53	37185	Lower Track - 5 Pan	-	1	-
53	39025	Lower Track - 7 Pan	-	-	1
54	37182	Upper Track - 3 Pan	1	-	-
54	37183	Upper Track - 5 Pan	-	1	-
54	39024	Upper Track - 7 Pan	-	-	1
55	42183*	Air Deflector - 3 Pan	1	-	-
55	42595	Air Deflector - 5 Pan - Alb.	-	1	-
55	42291*	Air Deflector - 5 Pan	-	1	-
55	42468*	Air Deflector - 7 Pan - Right	-	-	1
55	42469*	Air Deflector - 7 Pan – Left	-	-	1
√ 58	36210*	Replaceable Beeper	1	1	2
√ 59	29523*	Probe	2	2	2
60	54003*	Legs	4	4	4

√ recommended parts

*not shown

HM-3/5/7 Service Parts List - Continued

No.	Part Number	Description	Qty. Per Unit		
			3	5	7
61	41056	Seal - Canopy Glass - 3 Pan (Before May 1, 1994)	1	-	-
61	41055*	Seal - Canopy Glass - 5 Pan (Before May 1, 1994)	-	1	-
61	41057*	Seal - Canopy Glass - 7 Pan (Before May 1, 1994)	-	-	1
62	41162*	Seal - Side Glass - 3 Pan	2	-	-
62	41163*	Seal - Side Glass - 5/7 Pan	-	2	2
62	42661*	Seal - Side Glass - Alb.	2	2	2
63	14151*	Kit - Digital Display Uprights - O/S	2	2	2
63	14155*	Kit - Digital Display Uprights - 90°	2	2	2
64	37159*	Pan Support - Long	2	4	6
65	37371*	Pan - Cross Support	6	10	14
67	43568	Upright Stud Assy. - Right - 90° w/probe guard	1	1	1
67	43569	Upright Stud Assy. - Left - 90 ° w/probe guard	1	1	1
67	43666	Upright Stud Assy. - Left - O/S w/probe guard	1	1	1
67	43667	Upright Stud Assy. - Right - O/S w/probe guard	1	1	1
68	55870*	Right Water Pan Support Bracket	1	1	1
69	55871*	Left Water Pan Support Bracket	1	1	1

*not shown

HMT-3/5/7 Service Parts List

No.	Part Number	Description	Qty Per Unit		
			3	5	7
1	37000	Front Viewing Glass - 3 Pan (Before July 1, 1994)	1	-	-
1	54032	Front Viewing Glass Assy. - Complete - 3 Pan	1	-	-
1	54128	Front Viewing Glass Assy. Complete - 3 Pan - Huss	1	-	-
1	54127	Front Viewing Glass Assy. Complete - 3 Pan - Tyler	1	-	-
1	37001	Front Viewing Glass Assy. - 5 Pan (Before July 1,1994)	-	1	-
1	54030	Front Viewing Glass Assy. Complete - 5 Pan	-	1	-
1	54035	Front Viewing Glass Assy. Complete - 5 Pan - Huss	-	1	-
1	54034	Front Viewing Glass Assy. Complete - 5 Pan - Tyler	-	1	-
1	39027	Front Viewing Glass Assy. - 7 Pan (Before July 1,1994)	-	-	2
1	54036	Front Viewing Glass Assy. Complete - RH - 7 Pan	-	-	1
1	54037	Front Viewing Glass Assy. Complete - LH - 7 Pan	-	-	1
1	54134	Front Viewing Glass Assy. Complete - 7 Pan - Huss RH	-	-	1
1	54135	Front Viewing Glass Assy. Complete - 7 Pan - Huss. LH	-	-	1
1	54132	Front Viewing Glass Assy. Complete - 7 Pan - Tyler RH	-	-	1
1	54133	Front Viewing Glass Assy. Complete - 7 Pan - Tyler LH	-	-	1
2	68310	Sliding Door Assy. - 3 Pan	2	-	-
2	68338	Sliding Door Assy. - 5 Pan	-	2	-
2	68342	Sliding Door Assy. - HMT-5 (4 doors)	-	4	-
2	68350	Sliding Door Assembly - 7 Pan	-	-	4
3	37638	Water Pan Assembly (Before July 1, 1994)	1	1	2
3	41507	Water Pan Assembly	1	1	2
4	40833*	Probe Bracket	1	1	2
√ 5	42440*	Temperature Probe PC Board Assy.	2	2	2
√ 6	39216	Blower Motor	2	2	3
√ 7	40097	Series Regulating Thermostat	2	2	2
√ 8	28979	Transformer	1	1	2
9	PL01-006*	Plug - Bottom	2	2	2
10	18135	End Clamp	2	2	2

**Front viewing glass before July 1, 1994, 02736 Tape Kit must also be ordered.

√ recommended parts/*not shown

Henny Penny
HMT-3/5/7 Service Parts List - Continued

Model CM/CMT-5/7 HM/HMT-3/5/7 HS/HST-3

Part No.	Number	Description	Qty. Per Unit		
			3	5	7
11	MS01-162	Mounting Channel	-	-	-
12	22609	Terminal Block	3	3	3
13	22610	Barrier	2	2	2
14	ME50-003*	Spacer	2	2	2
15	NS03-013*	Cage Nut	4	4	4
16	EF02-040*	Bushing - Snap	2	2	2
17	37230	Bracket - Drop Shelf	2	2	4
17	49297	Cutting Board Brace - KFC	1	1	-
18	39938	Side Viewing Panel	2	2	2
18	42229	Side Viewing Panel (Mir)-Left	2	2	2
18	43791	Side Viewing Panel (Mir)-Right	2	2	2
18	42003	Side Viewing Panel - Hussmann	2	2	2
18	42230	Side Viewing Panel - Hussmann (Mir)-Left	2	2	2
18	43793	Side Viewing Panel - Hussmann (Mir)-Right	2	2	2
18	42009	Side Viewing Panel - Tyler	2	2	2
18	42231	Side Viewing Panel - Tyler (Mir)-Left	2	2	2
18	43792	Side Viewing Panel - Tyler (Mir)-Right	2	2	2
19	39974	Fan Blade	2	2	3
20	16685	Fan Guard	4	4	5
√ 21	37059	Heater - Lower - 240 v	2	3	4
√ 21	44976	Heater - Lower - 208 v	2	3	4
√ 22	37060	Heater - Water - 240 v	1	1	2
√ 22	48020	Heater - Water - 208 v	1	1	2
√ 23	39795	Socket - Light	6	10	14
√ 23	54041	Socket - Light - CE	6	10	14
√ 24	BL01-009	Light Bulb - 120v - 100w	6	10	14
√ 24	BL01-015	Light Bulb - 240v - 60w	6	10	14
√ 25	54181	Heater - Upper Radiant - 240 v - "S"-Shaped	3	5	7
√ 25	64257	Heater - Upper Radiant - 208 v - "S"-Shaped	3	5	7
26	41019	Decal - Control Panel - 3 Pan	1	-	-
26	41020	Decal - Control Panel - 5 Pan	-	1	-
26	41021	Decal - Control Panel - 7 Pan	-	-	1
26	38413	Decal - Control Panel - 7 Pan - Left	-	-	1
26	49046	Decal - Control Panel - KFC	1	1	-
√ 27	36900	PC Board Assembly - Control	1	1	2
28	37127	Bracket for Plug	1	1	3
√ 29	30723	Relay	1	2	4
√ 30	59363	Probe - 5 ft.	1	1	3
√ 31	37420	Plug - Probe	1	1	3
√ 31	37815	Receptacle Assy. - Probe (Control Panel)	1	1	3
√ 31	42341	Receptacle Assy. - Probe (Uprights)	2	2	2
√ 32	16688	Cooling Fan	1	1	1
33	37128	Gas Shock - 3 Pan (Before April 1, 1994)	1	1	4
33	41751	Gas Shock - 3 Pan	2	-	-
33	37128	Gas Shock - 5 Pan (Before April 1, 1994)	1	1	-
33	41750	Gas Shock - 5 Pan	-	2	-
33	46502	Gas Shock Assy. - HM-7	-	-	2
34	43258	Cutting Board - 3 Pan	1	-	2
34	39181	Cutting Board (Poly) - 3 Pan	1	-	2
34	43262	Cutting Board - 5 Pan	-	1	-
34	39840	Cutting Board (Poly) - 5 Pan	-	1	-
34	49308	Cutting Board - KFC - HMT-3	1	-	-
34	49309	Cutting Board - KFC - HMT-5	-	1	-
35	37841	Power Cord Assy. - 3 Pan	1	-	-
35	37849	Power Cord Assy. - 5 Pan	-	1	-
35	41233	Power Cord Assy. - 7 Pan	-	-	1
36	PN01-016*	Clevis Pin	2	2	4
37	PN01-017*	Cotter Pin	2	2	4
38	LW01-004*	Lockwasher	2	2	4

√ recommended parts/*not shown

Henny Penny
HMT-3/5/7 Service Parts List - Continued

Model CM/CMT-5/7 HM/HMT-3/5/7 HS/HST-3

No.	Part Number	Description	Qty. Per Unit		
			3	5	7
39	37044	Hinge Cap (Before April 1, 1994)	2	2	3
39	41760	Hinge Cap	2	2	3
40	37231	Hinge Block Assy. (Before April 1, 1994)	2	2	2
40	42088	Hinge Block Assy.	2	2	2
40	39180	Hinge Block Assy. - Center - 7 Pan	-	-	1
41	41154	Hinge Pin	2	2	2
41	39026	Hinge Pin - Center - 7 Pan	-	-	2
42	54011	Tape - Acrylic Foam	1	2	2
43	41024	Crank (Before April 1, 1994)	4	4	4
43	41761	Crank	4	4	4
44	37061	Hinge Extrusion - 3 Pan	1	-	-
44	37062	Hinge Extrusion - 5 Pan	-	1	-
44	39008	Hinge Extrusion -7 Pan - Right	-	-	1
44	39009	Hinge Extrusion - 7 Pan-Left	-	-	1
45	37063	Clamp Extrusion -3 Pan	1	-	-
45	37064	Clamp Extrusion - 5 Pan	-	1	-
45	39010	Clamp Extrusion - 7 Pan	-	-	1
46	37130	Pivot Support	2	2	4
√ 47	EF02-007	use - 15 Amp	2	2	-
√ 47	EF02-083	use - 20 Amp	-	-	2
√ 48	EF02-006	use Holder - 15 Amp	2	2	-
√ 48	EF02-085	use Holder - 20 Amp	-	-	2
√ 49	43768	ower Switch	2	2	2
√ 51	37770	PC Board - Output	1	1	2
52	SC06-045*	Shoulder Screw	1	1	-
52	SC06-060*	Shoulder Screw - HMT-7	-	-	1
53	39961	Lower Track - 3 Pan	1	-	-
53	39942	Lower Track - 5 Pan	-	1	-
53	39025	Lower Track - 7 Pan	-	-	1
54	37182	Upper Track - 3 Pan	1	-	-
54	37183	Upper Track - 5 Pan	-	1	-
54	39024	Upper Track - 7 Pan	-	-	1
55	39978*	Air Deflector - 3 Pan	1	-	-
55	39977*	Air Deflector - 5 Pan	-	1	-
55	39979*	Air Deflector - 7 Pan	-	-	1
58	36210*	Replaceable Beeper	1	1	2
√ 59	29523*	Probe	2	2	2
√ 60	54003*	Legs	4	4	4
61	41056*	Seal - Canopy Glass - 3 Pan (Before April 1, 1994)	1	-	-
61	41055*	Seal - Canopy Glass - 5 Pan (Before April 1, 1994)	-	1	-
61	41057*	Seal - Canopy Glass - 7 Pan (Before April 1, 1994)	-	-	1
62	38932*	Seal - Side Glass	2	2	2
62	46624*	Seal - Side Glass - Huss.	2	2	2
62	43549*	Seal - Side Glass - Tyler	2	2	2
63	14122	Kit - Digital Display Uprights - 90'	2	2	2
63	14123	Kit - Digital Display Uprights - O/S	2	2	2
64	37159*	Pan Support - Long	2	4	6
65	37371*	Pan - Cross Support	6	10	14
67	42333	Upright Stud Assy. - Left - 90° - D/D - Probe Guard	1	1	1
67	42340	Upright Stud Assy. - Rt. - 90° - D/D - Probe Guard	1	1	1
67	43562	Upright Stud Assy. - Right - O/S -D/D- Probe Guard	1	1	1
67	43563	Upright Stud Assy. - Left - O/S- D/D- Probe Guard	1	1	1
68	05835	Bun Pan Insert - KFC - KMT-5	-	1	-
68	05387	Bun Pan Insert - KFC - KMT-3	1	-	-
69	55870*	Right Water Pan Support Bracket	1	1	1
70	55871*	Left Water Pan Support Bracket	1	1	1
√ 71	19405	Contacto- 3 ph Albertsons	1	1	1
72	42509*	Decal – Meat Probe Temp. Display	2	2	2

√ recommended parts/*not shown

CM/CMT-5/7 Service Parts List

No.	Part Number	Description	Qty. Per Unit		
			5	7	
1	37000	Front Viewing Glass - CM/CMT-5 (before July 1, 1994)	1	-	
1	54109	Front Viewing Glass Assy. Complete. - CM-5 RH	1	-	
1	54111	Front Viewing Glass Assy. Complete - CM-5 LH	1	-	
1	54105	Front Viewing Glass Assy. Complete - CMT-5 RH	1	-	
1	54107	Front Viewing Glass Assy. Complete - CMT-5 LH	1	-	
1A	54110	Glass-Canopy Guard - Assy. Complete - CM-5/7 RH	1	1	
1A	54112	Glass-Canopy Guard - Assy. Complete - CM-5/7 LH	1	1	
1	37001	Front Viewing Glass - CM/CMT-7 (before July 1, 1994)	-	1	
1	54136	Front Viewing Glass Assy. - CM-7 RH	-	1	
1	54138	Front Viewing Glass Assy. - CM-7 LH	-	1	
1	54140	Front Viewing Glass Assy. - CMT-7 RH	-	1	
1	54142	Front Viewing Glass Assy. - CMT-7 LH	-	1	
1A	54106	Glass Canopy Guard Complete - CMT-5/7 RH	1	1	
1A	54108	Glass Canopy Guard Complete- CMT-5/7 LH	1	1	
1	54119	Front View Glass Assy. Complete - CMT-5-Huss. LH	1	1	
1	54117	Front View Glass Assy. Complete - CMT-5-Huss. RH	1	-	
1	54113	Front Viewing Glass Assy. Complete - CMT-5-Tyler RH	1	1	
1	54115	Front Viewing Glass Assy. Complete - CMT-5-Tyler LH	1	-	
1	54150	Front Viewing Glass Assy. Complete - CMT-7-Huss. RH	-	1	
1	54146	Front Viewing Glass Assy. Complete - CMT-7-Huss. LH	-	1	
1A	54120	Glass Canopy Guard Assy. Complete - CMT-5/7-Huss. LH	1	1	
1A	54118	Glass Canopy Guard Assy. Complete - CMT-5/7-Huss. RH	1	1	
1	54148	Front Viewing Glass Assy. Complete - CMT-7-Tyler RH	-	1	
1	54144	Front Viewing Glass Assy. Complete - CMT-7-Tyler LH	-	1	
1A	54116	Glass Canopy Guard Assy. Complete - CMT-5/7-Tyler LH	1	1	
1A	54114	Glass Canopy Guard Assy. Complete - CMT-5/7-Tyler RH	1	1	
2	68334	Sliding Door Assembly - CM-5	2	2	
2	68346	Sliding Door Assembly - CM-7	-	2	
2	68338	Sliding Door Assembly - CMT-5	2	2	
2	68350	Sliding Door Assembly - CMT-7	-	4	
3	37638	Water Pan Assembly (Before July 1, 1994)	1	1	
3	41507	Water Pan Assembly	1	1	
4	40833*	Probe Bracket	1	1	
√	4	42440*	Temperature Probe PCB Assembly	2	2
√	6	39216	Blower Motor	2	2
√	7	40097	Series Regulating Thermostat	2	2
√	8	28979	Transformer	1	2
9	PL01-006*	Plug-Bottom	1	1	
10	18135	End Clamp	2	2	
11	MS01-162	Mounting Channel .292	-	-	
12	22609	Terminal Block	3	3	
13	22610	Barrier	1	1	
14	ME50-013	Spacer	2	2	
15	NS03-013	Cage Nut	4	4	
16	EF02-040	Bushing- Snap	2	2	
17	37230	Bracket - Drop Shelf	2	4	
18A	38995	Glass - Center Panel - CM-5/7	1	1	
18	37757	Side Viewing Panel - CM-5/7	2	2	
18	42969	Side Viewing Panel - Mir.-CM-5/7-Left	2	2	
18	43794	Side Viewing Panel - Mir.-CM-5/7-Right	2	2	
18A	38993	Glass - Center Panel - CMT-5/7	1	1	
18	39938	Side Viewing Panel - CMT-5/7	2	2	
18	42229	Side Viewing Panel - Mir.-CMT-5/7-Left	2	2	
18	43791	Side Viewing Panel - Mir.-CMT-5/7-Right	2	2	
18A	42871	Glass - Center Panel - CMT-5/7-Huss.	1	1	
18	42230	Side Viewing Panel - CMT-5/7-Mir.-Huss.-Left	2	2	
18	43793	Side Viewing Panel - CMT-5/7-Mir.-Huss.-Right	2	2	
18	42003	Side Viewing Panel - CMT-5/7-Huss.	2	2	
18A	42871	Glass - Center Panel - CMT-5/7-Huss.	1	1	
18A	42872	Glass - Center Panel - CMT-5/7-Tyler	1	1	
18	42009	Side Viewing Panel - CMT-5/7-Tyler	2	2	
18	42231	Side Viewing Panel - CMT-5/7-Mir.-Tyler-Left	2	2	
18	43792	Side Viewing Panel - CMT-5/7-Mir.-Tyler-Right	2	2	
19	39974	Fan Blade	2	2	
20	16685	Fan Guard	4	4	
√	21	37059	Heater - Lower - 240 v	3	4
√	21	44976	Heater - Lower - 208 v	3	4
√	22	37060	Heater - Water - 240 v	1	1
√	22	48020	Heater - Water - 208 v	1	1

√ recommended parts/*not shown

**Front Viewing Glass before July 1, 1994, 02736 Tape Kit must also be ordered.

CM/CMT-5/7 Service Parts List - Continued

No.	Part Number	Description	Qty. Per Unit	
			5	7
√ 23	39795	Socket- Light	10	14
√ 23	54041	Socket- Light - CE	10	14
√ 24	BL01-009	Light Bulb - 120v - 100w	10	14
√ 24	BL01-015	Light Bulb - 240v - 60w	10	14
√ 25	54181	Heater - Upper Radiant – 240 v – “S”-Shaped	5	7
√ 25	64257	Heater – Upper Radiant – 208 v – “S”-Shaped	5	7
26	41159	Decal - Control Panel - CM/CMT-7-Left	-	1
26	41160	Decal - Control Panel - CM-7-Right	-	1
26	41052	Decal - Control Panel - CM-5 - O/S (single controls)	1	-
26	41053	Decal - Control Panel - CMT-5 - O/S (single controls)	1	-
26	48264	Decal - Control Panel - CM-5 (dual controls)	1	-
26	48263	Decal - Control Panel - CMT-5 (dual controls)	1	-
26	41151	Decal - Control Panel - CMT-7-Right	-	1
26	48265	Decal - Control Panel - Self Serve - CM/CMT-5	1	-
√ 27	36900	PC Board Assembly - Display	1	2
√ 28	37420	Plug for Probe	2	3
√ 29	30723*	Relay	2	4
√ 30	59363	Probe- 5 ft.	1	3
31	37127	Bracket for Plug	1	3
√ 31	37815	Receptacle Assy. - Probe - (Control Panel)	1	1
√ 31	42341	Receptacle Assy. - Probe - (Uprights)	2	2
√ 32	16688	Cooling Fan	1	1
33	37128	Gas Shock - 3 Pan (Before April 1, 1994)	2	2
33	41751	Gas Shock - 3 Pan	2	-
33	37129	Gas Shock - 5 Pail (Before April 1, 1994)	1	1
33	42925	Gas Shock	1	1
33	42620	Gas Shock Assy. (CM/CMT-5 & CM-7)	1	1
33	44608	Gas Shock Assy. (CM/CMT-5 T&H only)	1	1
33	48845	Gas Shock - CMT-7	-	1
34	43258	Cutting Board - 3 Pan	-	2
34	43262	Cutting Board - 5 Pan	1	-
35	37849	Power Cord Assembly - 5 Pan	1	-
35	39215	Power Cord Assembly - 7 Pan	-	1
36	PN01-016*	Clevis Pin	3	3
37	PN01-107*	Cotter Pin	3	3
38	LW01-004*	Lockwasher	3	3
39	37044	Hinge Cap (Before April 1, 1994)	3	3
39	41760	Hinge Cap	3	3
40	37231	Hinge Block Assy. (Before April 1, 1994)	2	2
40	42088	Hinge Block Assembly	2	2
40	39180	Hinge Block Assembly - Center - 7 Pan	-	1
41	37026	Hinge Pin Center	2	2
41	41154	Hinge Pin	2	1
41	41154	Hinge Pin CM/CMT-7	-	1
42	54011	Tape - Acrylic Foam	2	2
43	41024	Crank - Steel - CM-5/7 (Before April 1, 1994)	2	4
43	42844	Crank - Steel - CM-5/7	2	4
43	41024	Crank - Steel - CMT-5/7 (Before April 1, 1994)	4	4
43	41761	Crank - Steel - CMT-5/7	4	4
44	41217	Hinge Extrusion - LH - CM/CMT-7	-	2
44A	41101	Hinge Extrusion - RH - CM/CMT-5/7	1	1
44	41102	Hinge Extrusion - RH - CM/CMT-5	1	-
44	41145	Hinge Extrusion - RH - CM/CMT-7	-	2
44	41008	Hinge Extrusion - LH - CM/CMT-5	1	-
44	41009	Hinge Extrusion - LH - CM/CMT-5/7	1	-
45	37063	Clamp Extrusion - CM/CMT-5	1	-
45	37064	Clamp Extrusion - CM/CMT-7	-	1

√ recommended parts/*not shown

Henny Penny
CM/CMT-5/7 Service Parts List - Continued

Model CM/CMT-5/7 HM/HMT-3/5/7 HS/HST-3

No.	Part Number	Description	Qty. Per Unit	
			5	7
45	41010	Clamp Extrusion - CM/CMT-5/7	1	1
46	37130	Pivot Support (Before April 1, 1994)	3	4
46	41778	Pivot Support	3	4
√ 47	EF02-006	Fuse Holder - 15 Amp	2	-
√ 47	EF02-085	Fuse Holder - 20 Amp	-	2
√ 48	EF02-007	Fuse - 15 Amp	2	-
√ 48	EF02-083	Fuse - 20 Amp	-	2
√ 49	43768	Power Switch	2	2
√ 51	37770	PC Board - Output	1	2
52	SC06-045*	Shoulder Screw - CM-5/7	3	2
52	SC06-045*	Shoulder Screw - CMT-5	3	-
52	SC06-060*	Shoulder Screw - CMT-7	-	2
53	37185	Lower Track - CM-5	1	-
53	39025	Lower Track - CMT-7	-	1
53	39942	Lower Track - CMT-5	1	-
53	39968	Lower Track - CMT-7	-	1
54	39024	Upper Track - CM/CMT-7	-	1
54	37183	Upper Track - CM/CMT-5	-	1
55	42824	Air Deflector - CM/CMT-7	-	1
55	42819	Air Deflector - CM/CMT-5	1	-
56	39797	Well Cover - 2"	1	1
56	49420	Flat Well Cover	1	1
56	55406	Well Cover- 3/8"	1	1
57	41041	Viewing Window - CM/CMT-5/7	1	1
√ 58	36210*	Replaceable Beeper	1	2
√ 59	29523*	Probe - Temperature	2	2
60	54003*	Legs	4	4
61	41055*	Seal - Canopy Glass - 7 Pan (Before April 1, 1994)	-	1
61	41056*	Seal - Canopy Glass - 5 Pan (Before April 1, 1994)	1	-
62	38932*	Seal - Side Glass	2	2
62	46624*	Seal - Side Glass - Huss.	2	2
62	43549*	Seal - Side Glass - Tyler	2	2
63	44489*	Seal - Middle Glass	1	1
64	41413*	Viewing Window Bracket	1	1
65	37159*	Pan Support - Long	2	4
66	37371*	Pan - Cross Support	6	10
67	42333	Upright Stud Assy. - Left - 90° - D/D - Probe Guard	1	1
67	42340	Upright Stud Assy. - Rt. - 90° - D/D - Probe Guard	1	1
67	43562	Upright Stud Assy. - Rt. - O/S-D/D - Tall - Probe Guard	1	1
67	43563	Upright Stud Assy. - Lt - O/S-D/D - Tall - Probe Guard	1	1
√ 68	23560*	Infinite Switch	1	1
69	22046*	Infinite Switch Knob	1	1
70	55804*	Power Cord Assy- 30A 3 Ph	-	1
71	55870*	Right Water Pan Support Bracket	1	1
72	55871*	Left Water Pan Support Bracket	1	1
√ 73	19405*	Contactora- 3ph Albertsons	1	1
74	42509*	Decal - Meat Probe Temp. Display	2	2

√ recommended parts/*not shown

C E Parts

46076	Lamp holder	48070	Decal - Control Panel - CM-7
46209	Decal - Control Panel - HMT-5	48071	Decal - Control Panel - CMT-7
48063	Decal - Control Panel - HMT-3	48072	Decal - Control Panel - HS-5
48064	Decal - Control Panel - HMT-3	48073	Decal - Control Panel - HST-5
48065	Decal - Control Panel - HM-5	48074	Decal - Control Panel - HS-3
48066	Decal - Control Panel - HM-7	48075	Decal - Control Panel - HST-3
48067	Decal - Control Panel - HMT-7	48078	Decal - Output Panel - HM 7
48068	Decal - Control Panel - CM-5	48079	Decal - Output Panel - CM-7
48069	Decal - Control Panel - CMT-5	51058	Filter Board - HS/HST-3/5
		51062	Filter Board - HM/HMT/CM/CMT-3/5/7

HS/HST-3/5 Service Parts List

No.	Part Number	Description	Qty. Per Unit		
			3	5	
1A	54028	Canopy Guard Assy. Complete - HST-3	1	-	
1A	54125	Canopy Guard Assy. Complete - HST-3-Tyler	1	-	
1A	54126	Canopy Guard Assy. Complete - HST-3-Huss	1	-	
1A	54038	Canopy Guard Assy. Complete - HST-5	-	1	
1A	54122	Canopy Guard Assy. Complete - HST-5-Tyler	-	1	
1A	54123	Canopy Guard Assy. Complete - HST-5-Huss	-	1	
1A	54124	Canopy Guard Assy. Complete - HS-3	1	-	
1A	54121	Canopy Guard Assy. Complete - HS-5	-	1	
2	68310	Sliding Door Assembly - HST-3	2	-	
2	68256	Sliding Door Assembly - HS-3	2	-	
2	68334	Sliding Door Assembly - HS-5	-	2	
9	PL01-006*	Plug - Bottom	1	1	
10	18135	End Clamp	2	2	
11	MS01-162	Mounting Channel .292	-	-	
12	22609	Terminal Block	3	3	
13	22610	Barrier	1	1	
14	ME50-013	Spacer .250 TH, .281 LG, .171 I.D.	2	2	
15	NS03-013	Cage Nut	4	4	
16	EF02-040	Bushing - Snap	1	1	
17	37230	Bracket - Drop Shelf	2	2	
18	37757	Side Viewing Panel - HS-3/5	2	2	
18	42969	Side Viewing Panel - HS-3/5 (Mir)-Left	2	2	
18	43794	Side Viewing Panel - HS-3/5 (Mir)-Right	2	2	
18	39938	Side Viewing Panel - HST-3/5	2	2	
18	42229	Side Viewing Panel - HST-3/5 (Mir)-Left	2	2	
18	43791	Side Viewing Panel - HST-3/5 (Mir)-Right	2	2	
18	42003	Side Viewing Panel - HST-5-Huss.	2	2	
18	42230	Side Viewing Panel - HST-5-Huss (Mir)-Left	2	2	
18	43793	Side Viewing Panel - HST-5-Huss (Mir)-Right	2	2	
18	42009	Side Viewing Panel - HST-5-Tyler	2	2	
18	42231	Side Viewing Panel - HST-5-Tyler (Mir)-Left	2	2	
18	43792	Side Viewing Panel - HST-5-Tyler (Mir)-Right	2	2	
√	21	37059	Heater - Lower - 240 v	2	3
√	21	44976	Heater - Lower - 208 v	2	3
√	23	39795	Socket - Light	6	10
√	23	54041	Socket - Light - CE	6	10
√	24	BL01-009	Light Bulb - 120 V - 100 W	6	10
√	24	BL01-015	Light Bulb - 240 V - 60 W	6	10
√	25	54181	Heater - Upper Radiant - 240 v - "S"-Shaped	3	5
√	25	64257	Heater - Upper Radiant - 208 v - "S"-Shaped	3	5
	26	39199	Decal - Control Panel - HS-3	1	-
	26	43017	Decal - Control Panel - HS-5	-	1
	26	41022	Decal - Control Panel - HST-3	1	-
	26	42245	Decal - Control Panel - HST-5	-	1
√	29	30723	Relay - HS/HST-5 only	-	1
	33	37128	Gas Shock (Before April 1, 1994)	1	1
	33	42925	Gas Shock - HS/HST-3	1	-
	33	41751	Gas Shock - HS/HST-5	-	1
	34	43258	Cutting Board - 3 Pan	1	-
	34	39181	Cutting Board (Poly) - 3 Pan	1	-
	34	43262	Cutting Board - 5 Pan	-	1
	34	39840	Cutting Board (Poly) - 5 Pan	-	1
	35	43766	Wire Grid - HS/HST-3	1	-
	35	43767	Wire Grid - HS/HST-5	-	1
	35	37841	Power Cord Assembly - 3 Pan	1	-
	35	37849	Power Cord Assembly - 5 Pan	-	1

√ recommended parts/*not shown

HS/HST-3/5 Service Parts List - Continued

No.	Part Number	Description	Qty. Per Unit	
			3	5
36	PN01-016*	Clevis Pin	1	1
37	PN01-017*	Cotter Pin - HS	2	2
37	PN01-017*	Cotter Pin - HST	1	1
38	LW01-004*	Lockwasher	2	2
39	37044	Hinge Cap (Before April 1, 1994)	2	2
39	41760	Hinge Cap	2	2
40	37231	Hinge Block Assy. (Before April 1, 1994)	2	2
40	42088	Hinge Block Assy.	2	2
41	41154	Hinge Pin	2	2
42	54011	Tape - Acrylic Foam	1	2
43	41024	Crank-HS (Before May 1, 1994)	4	4
43	41024	Crank-HST (Before April 1, 1994)	2	2
43	42844	Crank-HS	4	4
43	41761	Crank-HST	2	2
44A	37061	Hinge Extrusion - HS/HST-3	1	-
44A	37062	Hinge Extrusion - HS/HST-5	-	1
45	37063	Clamp Extrusion - HS/HST-3	1	1
45	37064	Clamp Extrusion - HS/HST-5	-	1
46	37130	Pivot Support (Before May 1 1994)	1	1
46	41778	Pivot Support	1	1
√ 47	EF02-007	Fuse 2	2	-
√ 48	EF02-006	Fuse Holder	2	2
√ 49	43768	Power Switch	2	2
52	SC06-045	Shoulder Screw	1	1
53	37184	Lower Track - HS-3	1	-
53	37185	Lower Track - HS-5	-	1
53	39961	Lower Track - HST-3	1	-
53	39942	Lower Track - HST-5	-	1
54	37182	Upper Track - HS/HST-3	1	-
54	37183	Upper Track - HS/HST-5	-	1
56	39185	Well Cover - HS/HST-3 (Bun Pans)	1	-
56	42479	Well Cover-3/8"- HS/HST-3	1	-
56	42477	Well Cover-2"- HS/HST-3	1	-
56	42463	Well Cover-3/8"- HS/HST-5	-	1
56	42413	Well Cover-2"- HS/HST-5	-	1
56	46419	Well Cover-Flat - HS-3	1	-
56	46420	Well Cover-Flat - HS-5	-	1
57	39196	Viewing Window - HS/HST-3	1	-
57	42253	Viewing Window - HS/HST-5	-	1
60	54003*	Legs	4	4
61	41161*	Seal-Canopy Glass (Before April 1, 1994)	1	-
61	41162*	Seal- Side Glass - HS-3	2	2
62	41163*	Seal-Side Glass - HS-5	2	2
62	41080*	Seal-Side Glass - HST-3/5	2	2
64	41436*	Viewing Window Bracket - HS/HST-3	1	-
64	42210*	Viewing Window Bracket - HS/HST-5	-	1
65	41442*	Pan Insert Assy.-HS/HST - 3 (Before May 1, 1994)	1	-
66	42255*	Seal-Front Viewing Glass - HS/HST-5	-	1
66	41161*	Seal-Front Viewing Glass - HS/HST-3	1	-
68	37159*	Pan Support-Long	2	4
68	37371*	Pan-Cross Support	6	10
√ 69	23560*	Infinite Switch	1	2
70	22045*	Infinite Switch Knob	1	2
71	05863*	Sneeze Guard - HST-3	1	-
71	05864*	Sneeze Guard - HST-5	-	1
72	51058*	Filter Board - CE	1	1
73	19405*	Contactora- 3ph Albertsons	-	1

√ recommended parts/*not shown

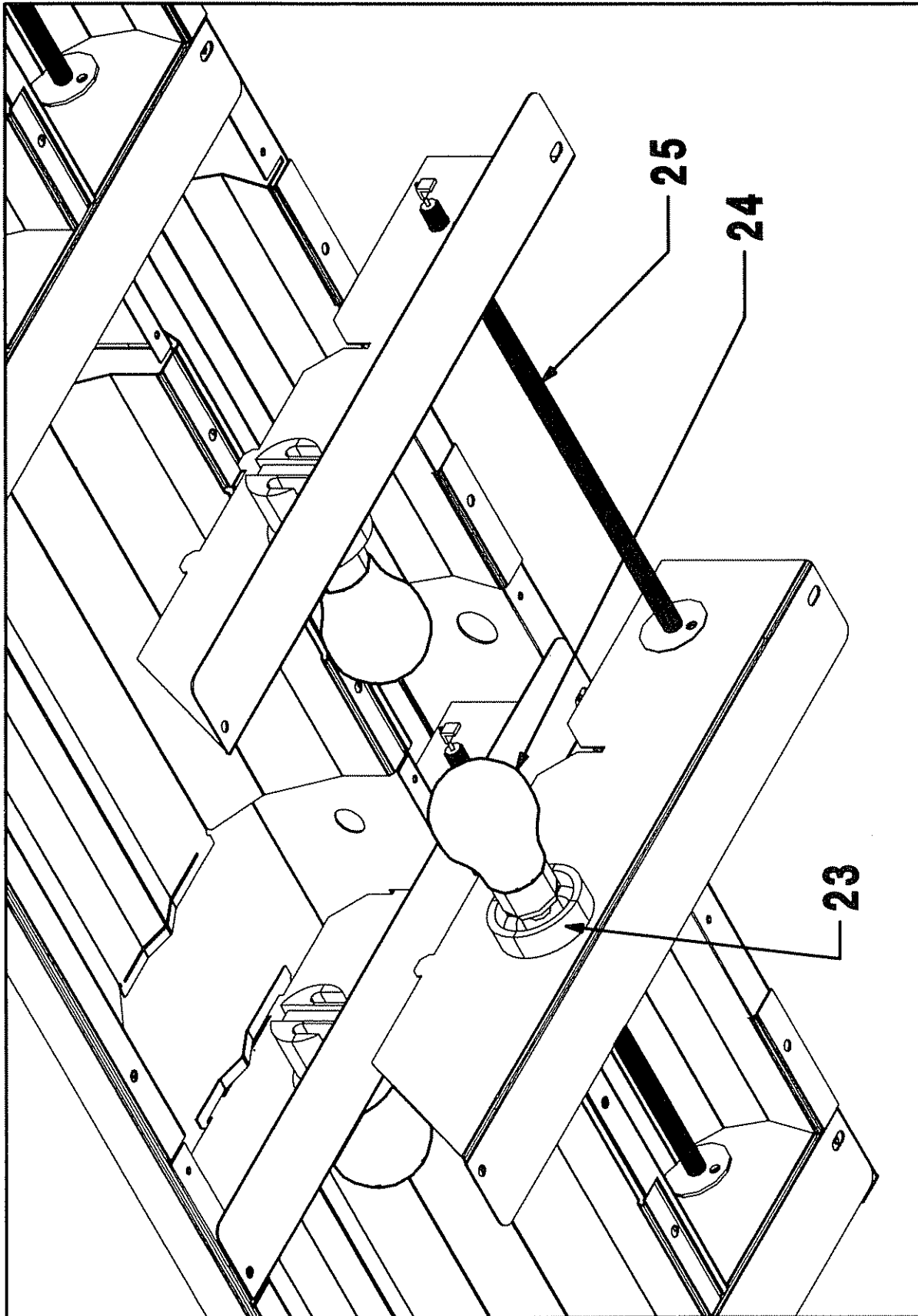

LIGHT CANOPY ASSEMBLY

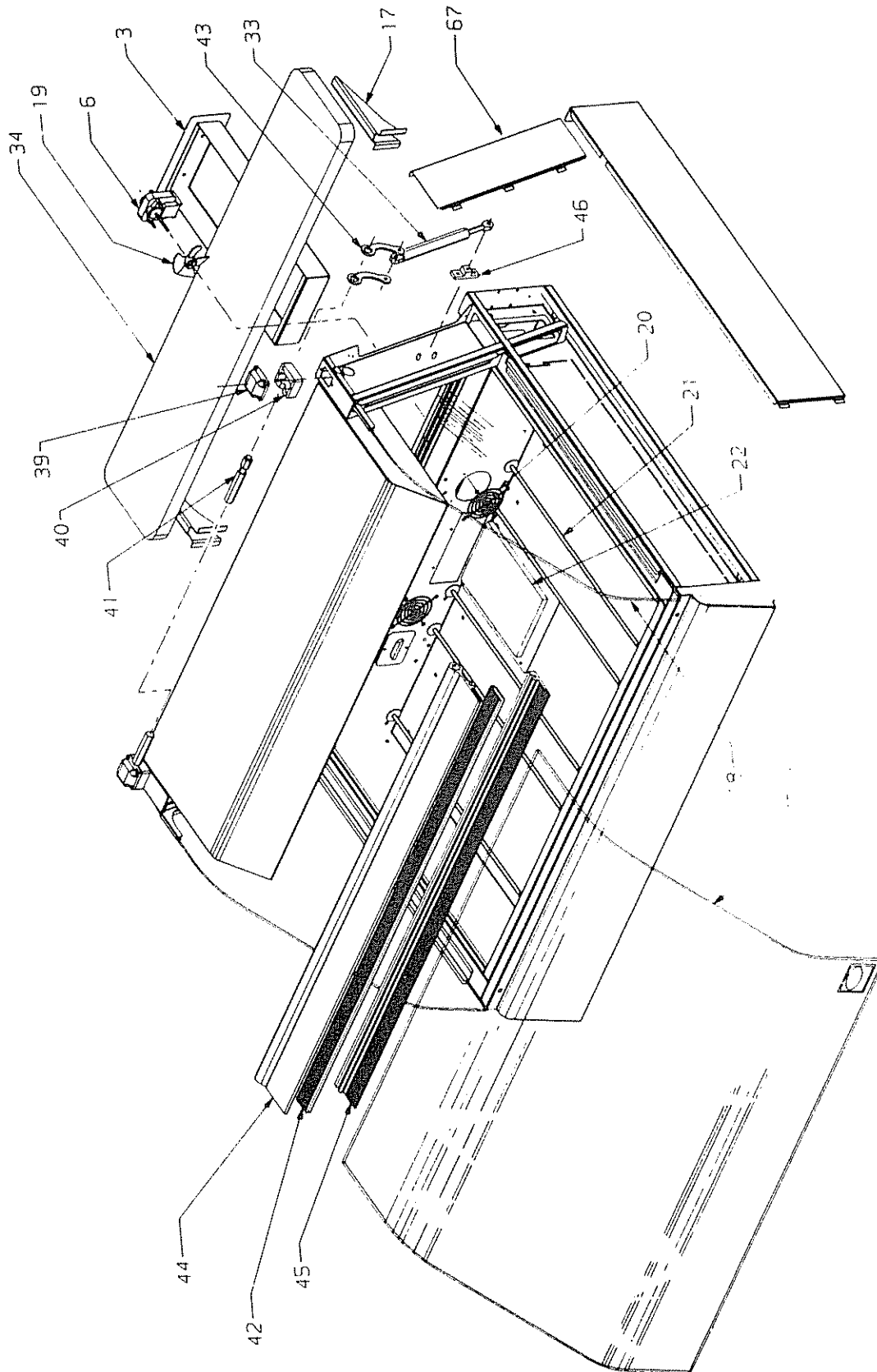

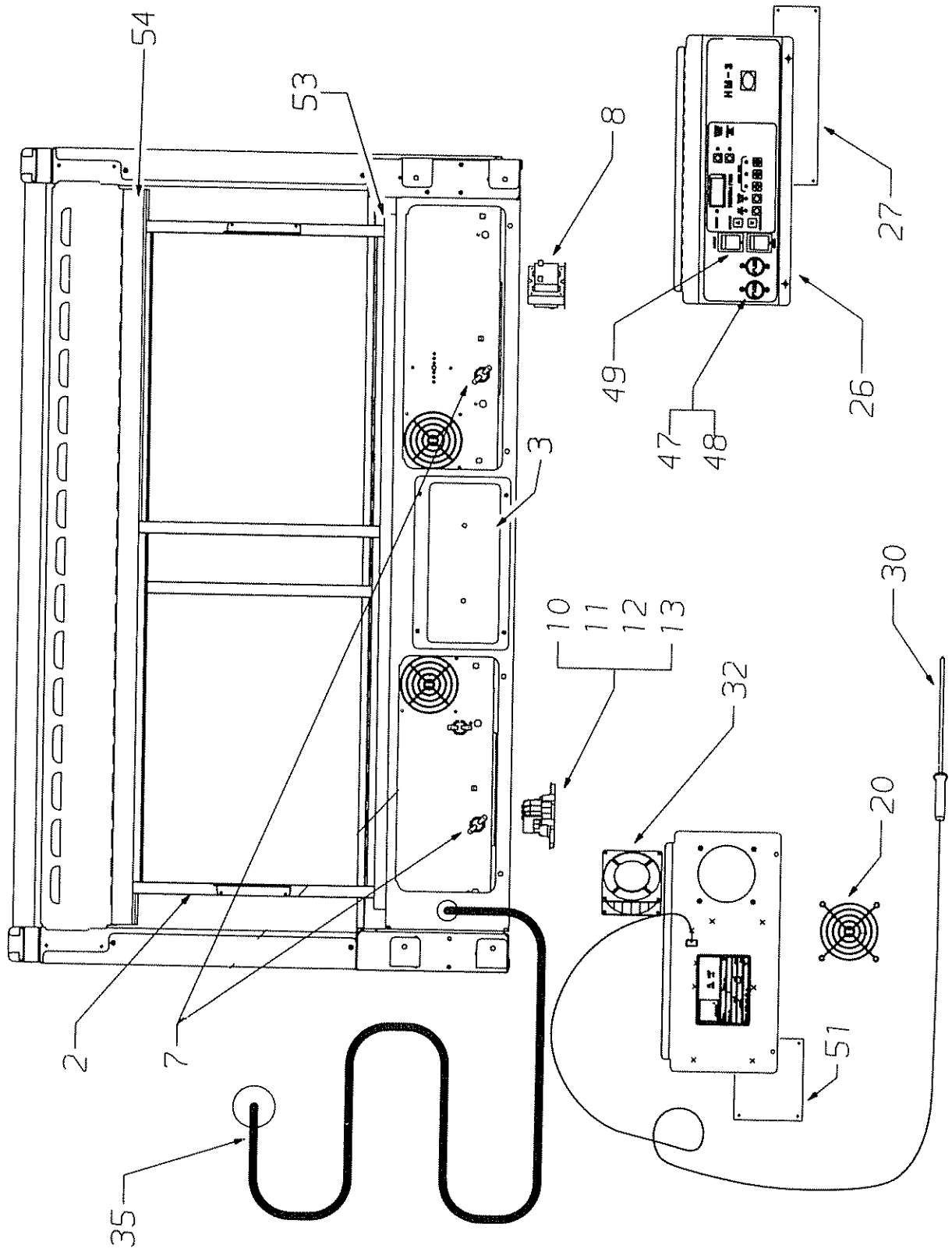

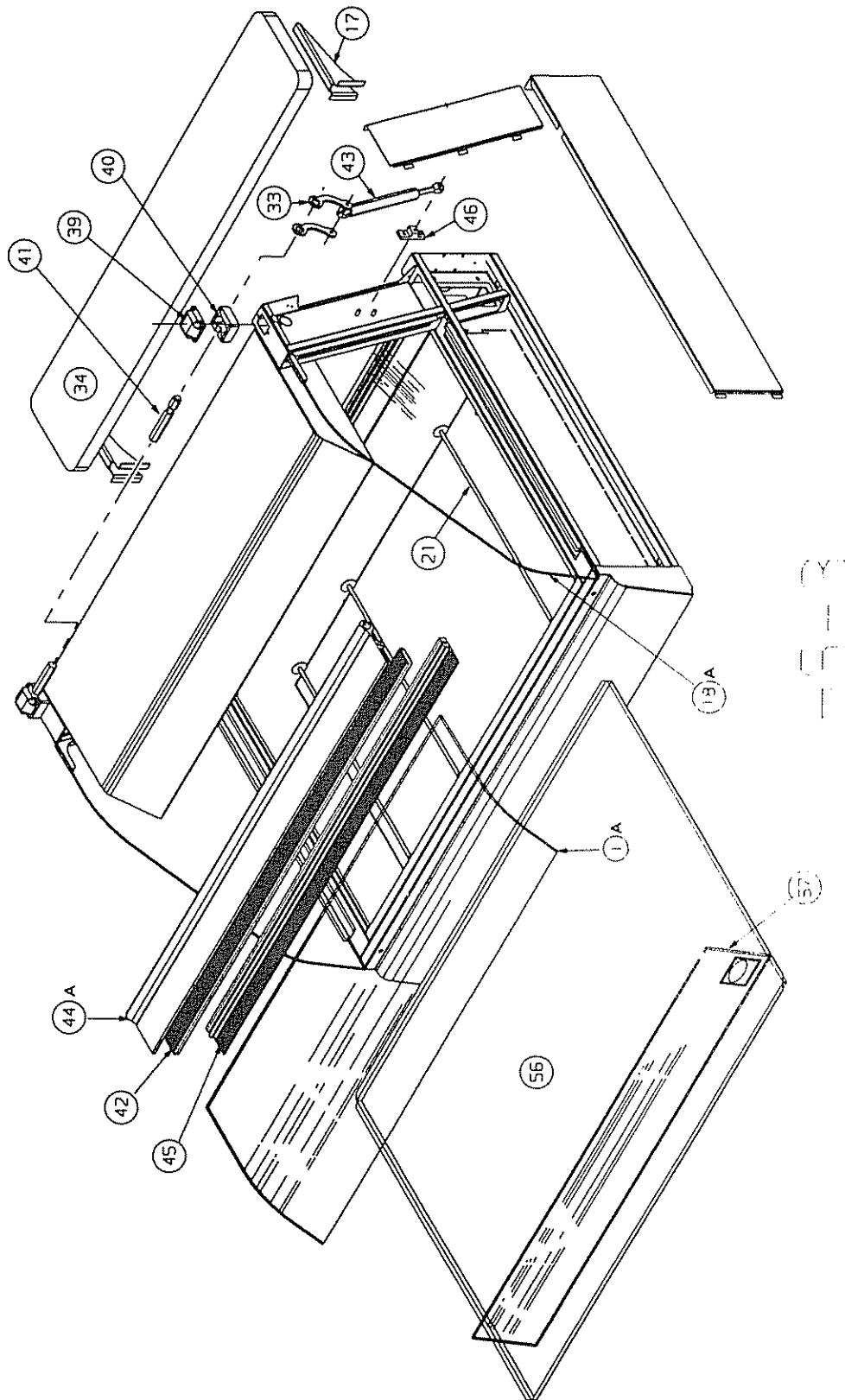

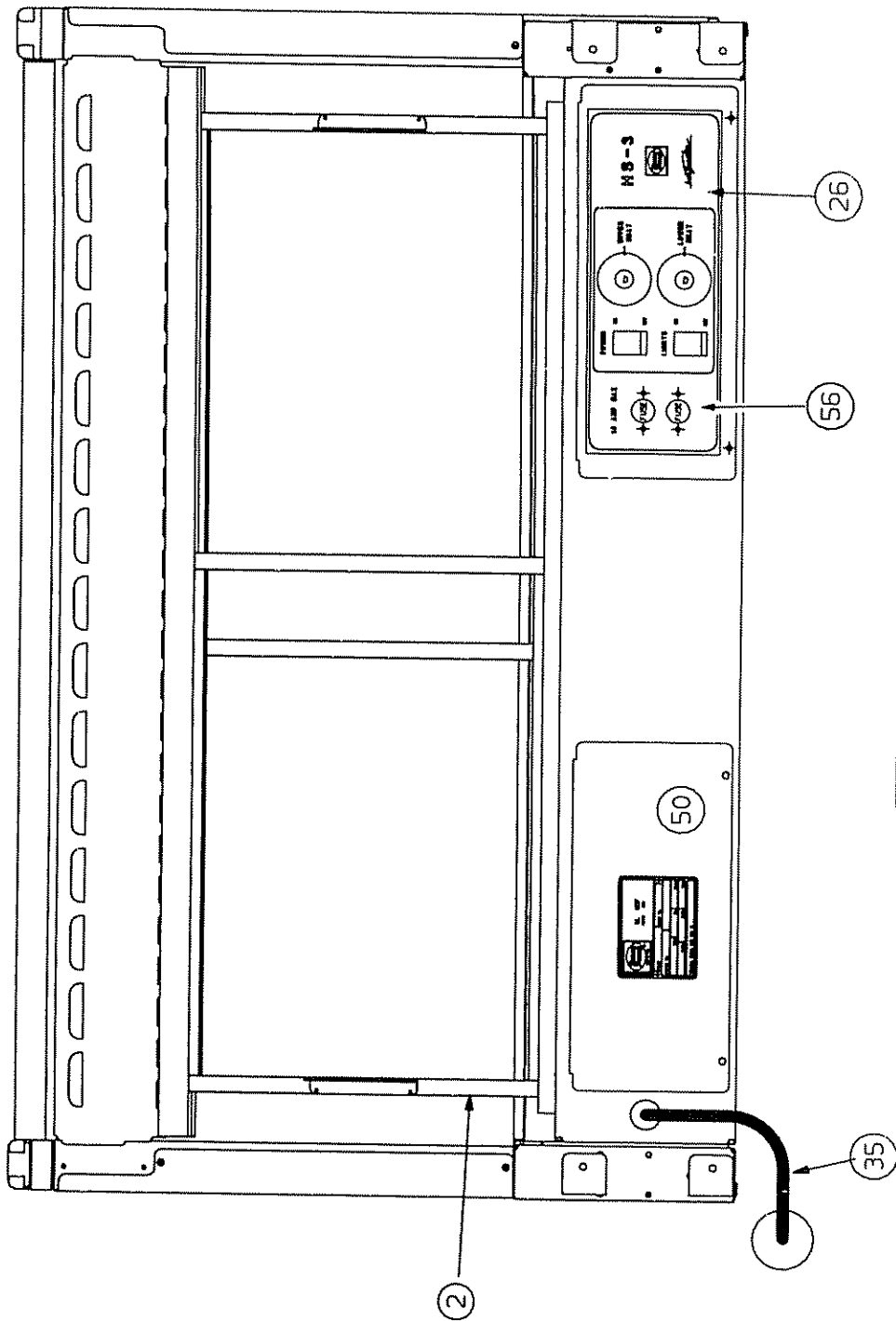

HS-3, REAR VIEW