



Henny Penny Open Fryer

Model OFE-290
Model OFE-292

OPERATOR'S MANUAL

LIMITED WARRANTY FOR HENNY PENNY EQUIPMENT

Subject to the following conditions, Henny Penny Corporation makes the following limited warranties to the original purchaser only for Henny Penny appliances and replacement parts:

NEW EQUIPMENT: Any part of a new appliance, except baskets, lamps, and fuses, which proves to be defective in material or workmanship within two (2) years from date of original installation, will be repaired or replaced without charge F.O.B. factory, Eaton, Ohio, or F.O.B. authorized distributor. Baskets will be repaired or replaced for ninety (90) days from date of original installation. Lamps and fuses are not covered under this Limited Warranty. To validate this warranty, the registration card for the appliance must be mailed to Henny Penny within ten (10) days after installation.

FILTER SYSTEM: Failure of any parts within a fryer filter system caused by the use of the non-OEM filters or other unapproved filters is not covered under this Limited Warranty.

REPLACEMENT PARTS: Any appliance replacement part, except lamps and fuses, which proves to be defective in material or workmanship within ninety (90) days from date of original installation will be repaired or replaced without charge F.O.B. factory, Eaton, Ohio, or F.O.B. authorized distributor.

The warranty for new equipment covers the repair or replacement of the defective part and includes labor charges and maximum mileage charges of 200 miles round trip for a period of one (1) year from the date of original installation.

The warranty for replacement parts covers only the repair or replacement of the defective part and does not include any labor charges for the removal and installation of any parts, travel, or other expenses incidental to the repair or replacement of a part.

EXTENDED FRYPOT WARRANTY: Henny Penny will replace any frypot that fails due to manufacturing or workmanship issues for a period of up to seven (7) years from date of manufacture. This warranty shall not cover any frypot that fails due to any misuse or abuse, such as heating of the frypot without shortening.

0 TO 3 YEARS: During this time, any frypot that fails due to manufacturing or workmanship issues will be replaced at no charge for parts, labor, or freight. Henny Penny will either install a new frypot at no cost or provide a new or reconditioned replacement fryer at no cost.

3 TO 7 YEARS: During this time, any frypot that fails due to manufacturing or workmanship issues will be replaced at no charge for the frypot only. Any freight charges and labor costs to install the new frypot as well as the cost of any other parts replaced, such as insulation, thermal sensors, high limits, fittings, and hardware, will be the responsibility of the owner.

Any claim must be presented to either Henny Penny or the distributor from whom the appliance was purchased. No allowance will be granted for repairs made by anyone else without Henny Penny's written consent. If damage occurs during shipping, notify the sender at once so that a claim may be filed.

THE ABOVE LIMITED WARRANTY SETS FORTH THE SOLE REMEDY AGAINST HENNY PENNY FOR ANY BREACH OF WARRANTY OR OTHER TERM. BUYER AGREES THAT NO OTHER REMEDY (INCLUDING CLAIMS FOR ANY INCIDENTAL OR CONSEQUENTIAL DAMAGES) SHALL BE AVAILABLE.

The above limited warranty does not apply (a) to damage resulting from accident, alteration, misuse, or abuse; (b) if the equipment's serial number is removed or defaced; or (c) for lamps and fuses. THE ABOVE LIMITED WARRANTY IS EXPRESSLY IN LIEU OF ALL OTHER WARRANTIES, EXPRESS OR IMPLIED, INCLUDING MERCHANTABILITY AND FITNESS, AND ALL OTHER WARRANTIES ARE EXCLUDED. HENNY PENNY NEITHER ASSUMES NOR AUTHORIZES ANY PERSON TO ASSUME FOR IT ANY OTHER OBLIGATION OR LIABILITY.

Revised 01/01/07

HENNY PENNY

6 HEAD ELECTRIC OPEN FRYER

SPECIFICATIONS

Height	61" (155 cm)
Width	24" (61 cm)
Depth	41¾" (107 cm)
Floor Space	Approximately 7 sq. ft. (.65 sq. m.)
Pot Capacity	6 head of chicken - 21 lbs. (9.5 kg) 100 lbs. shortening (45 Kg.)
Electrical	208 VAC, 3 Phase, 50/60 Hz, 17 KW, 47.2 Amps 240 VAC, 3 Phase, 50/60 Hz, 17 KW, 40.9 Amps 200 VAC, 3 Phase, (Delta), 50/60 Hz, 17 KW, 49.1 Amps 240 VAC, 3 Phase, (Delta), 50 Hz, 17 KW, 40.9 Amps 380 VAC, 3 Phase, 50 Hz, 17 KW, 25.8 Amps 415 VAC, 3 Phase, 50 Hz, 17 KW, 23.7 Amps
Heating	Two 8,500 watt electric immersion elements
Shipping Weight	Approximately 593 lbs. (269 kg.)

NOTICE

A data plate, located on the right side panel, gives the information of the type of fryer, serial number, warranty date, and other information pertaining to fryer. Also, the serial number is stamped on the outside of the frypot. See figure below.

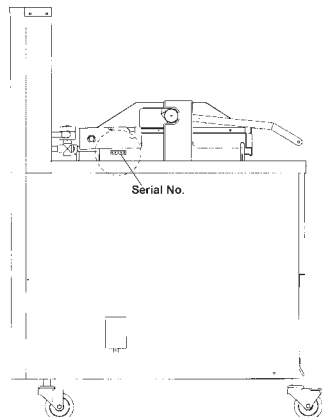

TABLE OF CONTENTS

Section		Page
Section 1.	INTRODUCTION	1-1
	1-1 Introduction	1-1
	1-2 Proper Care	1-1
	1-3 Assistance	1-1
	1-4 Safety	1-2
Section 2.	INSTALLATION	2-1
	2-1 Introduction	2-1
	2-2 Unpacking	2-1
	2-3 Selecting the Fryer Location	2-4
	2-4 Leveling the Fryer	2-4
	2-5 Ventilation of Fryer	2-5
	2-6 Electrical Requirements	2-5
	2-7 International Electrical Requirements	2-6
Section 3.	OPERATION	3-1
	3-1 Operating Components	3-1
	3-2 Lid Operation	3-2
	3-3 Melt Cycle Operation	3-2
	3-4 Switches and Indicators	3-3
	3-5 Filling or Adding Shortening	3-5
	3-6 Basic Operation	3-6
	3-7 Care of Shortening	3-8
	3-8 Filtering Instructions	3-8
	3-9 Changing the Filter Envelope	3-10
	3-10 Cleaning the Frypot	3-10
	3-11 Filter Pump Motor Protector-Manual Reset	3-11
	3-12 Regular Maintenance Schedule	3-11
	3-13 Preventive Maintenance	3-12
	3-14 Programming	3-12
	3-15 Special Program Mode	3-14
Section 4.	TROUBLESHOOTING	4-1
	4-1 Troubleshooting Guide	4-1
	4-2 Error Codes	4-2
GLOSSARY	G-1

Distributors List - Domestic and International

SECTION 1. INTRODUCTION

1-1. INTRODUCTION

The Henny Penny open fryer is a basic unit of food processing equipment. This unit is used only in institutional and commercial food service operations.

NOTICE

As of August 16, 2005, the Waste Electrical and Electronic Equipment directive went into effect for the European Union. Our products have been evaluated to the WEEE directive. We have also reviewed our products to determine if they comply with the Restriction of Hazardous Substances directive (RoHS) and have redesigned our products as needed in order to comply. To continue compliance with these directives, this unit must not be disposed as unsorted municipal waste. For proper disposal, please contact your nearest Henny Penny distributor.



1-2. PROPER CARE

As in any unit of food service equipment, the Henny Penny open fryer does require care and maintenance. Requirements for the maintenance and cleaning are contained in this manual and must become a regular part of the operation of the unit at all times.

1-3. ASSISTANCE

Should you require outside assistance, call your local independent distributor in your area, or call Henny Penny Corp. at 1-800-417-8405 or 1-937-456-8405.

1-4. SAFETY

The Henny Penny open fryer has many safety features incorporated. However, the only way to ensure a safe operation is to fully understand the proper installation, operation, and maintenance procedures. The instructions in this manual have been prepared to aid you in learning the proper procedures. Where information is of particular importance or safety related, the words DANGER, WARNING, CAUTION, and NOTICE are used. Their usage is described below.



SAFETY ALERT SYMBOL is used with **DANGER**, **WARNING**, or **CAUTION** which indicates a personal injury type hazard.



NOTICE is used to highlight especially important information.



CAUTION used without the safety alert symbol indicates a potentially hazardous situation which, if not avoided, may result in property damage.



CAUTION used with the safety alert symbol indicates a potentially hazardous situation which, if not avoided, may result in minor or moderate injury.



WARNING indicates a potentially hazardous situation which, if not avoided, could result in death or serious injury.



DANGER INDICATES AN IMMINENTLY HAZARDOUS SITUATION WHICH, IF NOT AVOIDED, WILL RESULT IN DEATH OR SERIOUS INJURY.

SECTION 2. INSTALLATION

2-1. INTRODUCTION

This section provides the installation and unpacking instructions for the Henny Penny OFE-290, open fryer.

NOTICE

Installation of this unit should be performed only by a qualified service technician.



Do not puncture the fryer with any objects such as drills or screws as component damage or electrical shock could result.

2-2. UNPACKING INSTRUCTIONS

NOTICE

Any shipping damage should be noted in the presence of the delivery agent and signed prior to his or her departure.

1. Cut and remove the metal bands from the carton.
2. Remove the carton lid and lift the main carton off the fryer.
3. Remove corner packing supports (4).
4. Cut the stretch film from around the carrier/rack box and remove it from the top of the fryer lid.
5. Cut and remove the metal bands holding the fryer to the pallet.



All counterweights must be loaded before unlatching the lid, or personal injury could result.

6. Remove the fryer from the pallet.



Take care when moving the fryer to prevent personal injury. The fryer weighs approximately 600 lbs. (270 kg).

**2-2. UNPACKING
INSTRUCTIONS
(Continued)**

7. Remove the counterweights from the pallet, which are strapped to the pallet, under the fryer.



Do not drop. The counterweights weigh approximately 18 lbs. (8.1 kg.) each. Handle with care, or personal injury could result.

8. Remove rear cover.
9. Load the 4 weights into the counterweight assembly. See next page.
10. Replace rear cover.
11. Cut warning tags from the lid assembly. The lid may now be unlatched.
12. Remove the accessories from inside the filter drain pan.
13. Remove the protective paper from the fryer cabinet. Clean exterior surface with a damp cloth.

Optional Ramp Unloading

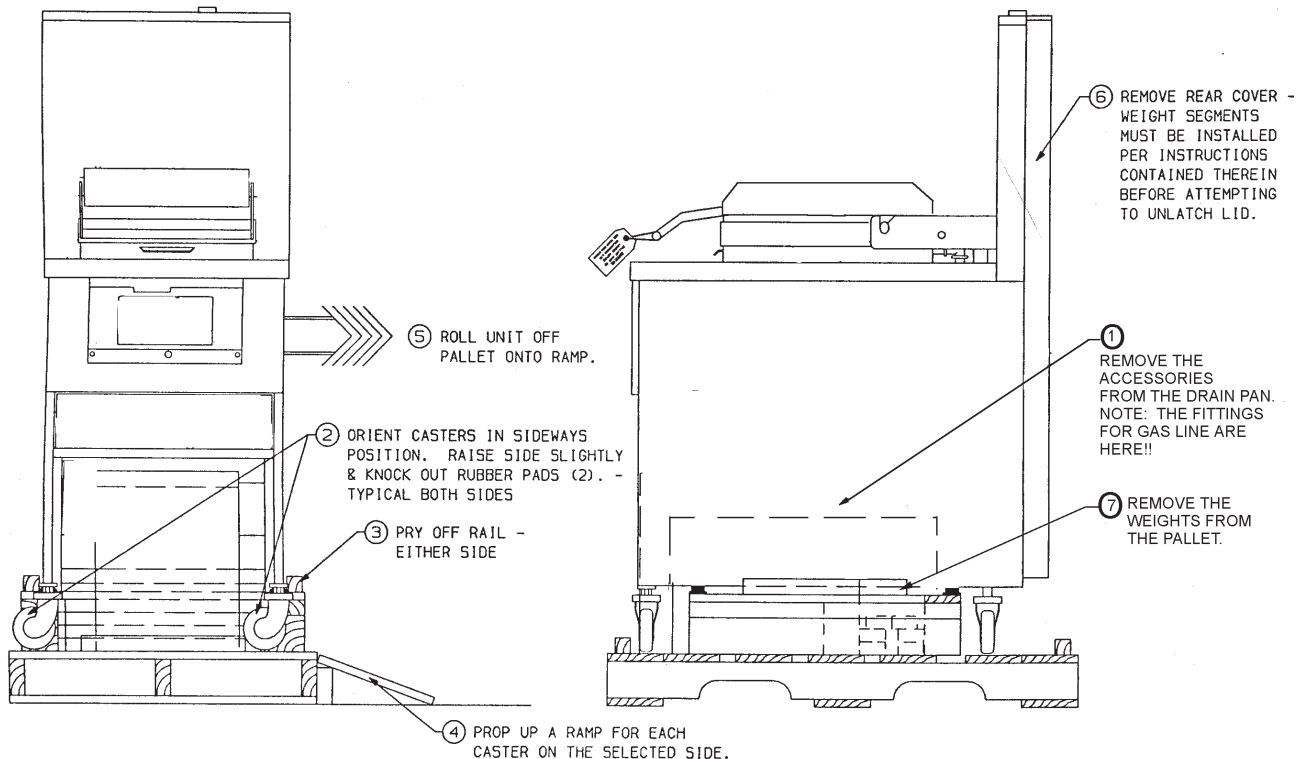

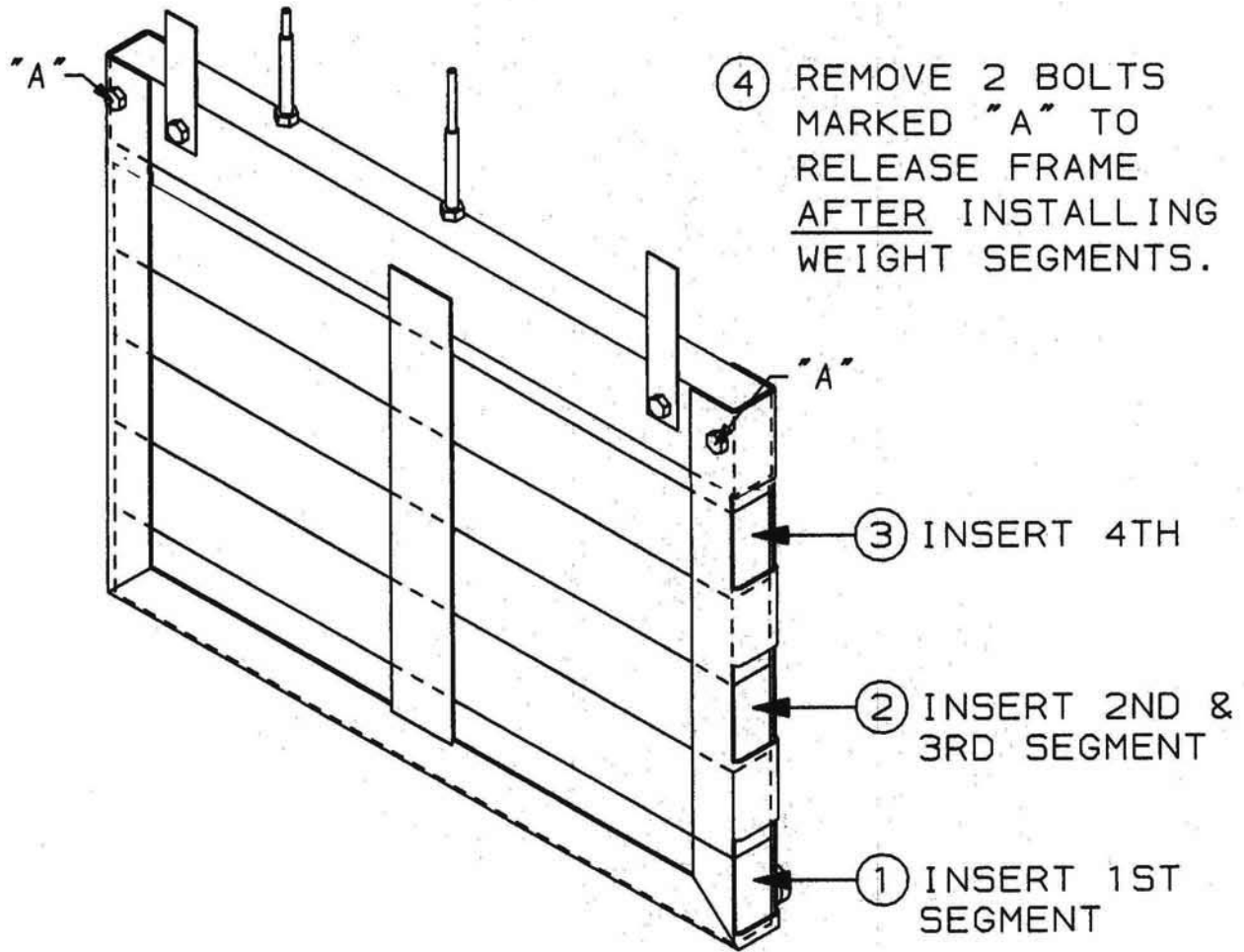

CAUTION

- * EACH WEIGHT SEGMENT WEIGHS APPROXIMATELY 18 LBS. (8.1 KG) – HANDLE WITH CARE.
- * ALL SEGMENTS ARE IDENTICAL.
- * ALL SEGMENTS MUST BE INSTALLED AND SECURED IN THE FRAME BEFORE ATTEMPTING TO UNLATCH LID.

2-3. SELECTING THE FRYER LOCATION

The proper location of the fryer is very important for operation, speed, and convenience. Choose a location which provides easy loading and unloading without interfering with the final assembly of food orders. Operators have found that frying from raw to finish, and holding the product in warmer provides fast continuous service. Landing or dumping tables should be provided next to at least one side of the fryer. Keep in mind the best efficiency will be obtained by a straight line operation, i.e. raw in one side and finish out the other side. Order assembly can be moved away with only a slight loss of efficiency. To properly service the fryer, 24 inches of clearance is needed on all sides of the fryer. Access for servicing can be attained by removing a side panel.



To avoid fire and ruined supplies, the area under the fryer should not be used to store supplies.



To prevent severe burns from splashing hot shortening, position and install fryer to prevent tipping or movement. Restraining ties may be used for stabilization.

2-4. LEVELING THE FRYER

For proper operation, the fryer must be level from side to side and front to back. Using a level placed on the flat areas around the frypot collar, adjust the leveling bolt or casters until the unit is level.



FAILURE TO FOLLOW THESE LEVELING INSTRUCTIONS CAN RESULT IN SHORTENING OVERFLOWING THE FRYPOT WHICH COULD CAUSE SERIOUS BURNS, PERSONAL INJURY, FIRE AND/OR PROPERTY DAMAGE.

2-5. VENTILATION OF FRYER

The fryer should be located with provision for venting into adequate exhaust hood or ventilation system. This is essential to permit efficient removal of steam exhaust and frying odors. Special precautions must be taken in designing an exhaust canopy to avoid interference with the operation of the fryer. We recommend you consult a local ventilation or heating company to help in designing an adequate system.

NOTICE

Ventilation must conform to local, state, and national codes. Consult your local fire department or building authorities.

2-6. ELECTRICAL REQUIREMENTS

The electric fryer requires 208 or 240 volt, three phase, 50/60 Hertz service. The power cord will be already attached to the fryer. Check the data plate mounted just above the lid, on the left side of the back shroud, to determine the correct power supply.



This fryer **must** be adequately and safely grounded (earthed) or electrical shock could result. Refer to local electrical codes for correct grounding (earthing) procedures or in absence of local codes, with The National Electrical Code, ANSI/NFPA No. 70-(the current edition). In Canada, all electrical connections are to be made in accordance with CSA C22.1, Canadian Electrical Code Part 1, and/or local codes.

To avoid electrical shock, this appliance must be equipped with an external circuit breaker which will disconnect all ungrounded (unearthed) conductors. The main power switch on this appliance does not disconnect all line conductors.

A separate disconnect switch with proper capacity fuses or breakers must be installed at a convenient location between the fryer and the power source. It should be an insulated copper conductor rated for 600 volts and 90° C. For runs longer than 50 feet (15.24 m), use the next larger wire size.

**2-7. INTERNATIONAL
ELECTRICAL
REQUIREMENTS**

Units being used outside the United States may not be shipped with the power cord attached to the unit because of the different wiring codes. The fryers are available from the factory wired for 208, 240, 380 and 415 volts, 3 phase, 50 Hertz service. A terminal block is mounted inside the fryer for the cable wiring. A decal on the inside of the right side panel will help in the wiring of the unit.

NOTICE

CE units require a minimum wire size of 4mm to be wired to the terminal block. If a flexible power cord is used, it must be HO7RN type.

To install the power cord, follow these procedures:

1. Remove the right side panel of the unit.
2. Install the cord, with a strain relief, to the junction box.
3. Attach the wires to the terminal block according to the wiring diagram on the side panel.
4. Pull the slack out of the cord and thread it down through the the clamp on the frame, at the rear, left leg of fryer. Then run the cable under the frame and out the rear of the fryer, so it doesn't interfere with the filter drain pan.



The filter drain pan must be as far back under fryer as it will go, and the cover in place. Be sure the hole in the cover lines up with the drain before opening the drain. Failure to follow these instructions causes splashing of shortening and could result in personal injury.

5. Wiring the fryer is now complete.

**2-7. INTERNATIONAL
ELECTRICAL
REQUIREMENTS
(Continued)**

NOTICE

- The supply power cords shall be oil-resistant, sheathed flexible cable, no lighter than ordinary polychloroprene or other equivalent synthetic elastomer-sheathed cord.
- It is recommended that a 30 mA rated protective device such as a residual current circuit breaker (RCCB), or ground fault circuit interrupter (GFCI), be used on the fryer circuit.
- Equipotential Ground Symbol = 



(FOR EQUIPMENT WITH CE MARK ONLY!)

To prevent electric shock hazard this appliance must be bonded to other appliances or touchable metal surfaces in close proximity to this appliance with an equipotential bonding conductor. This appliance is equipped with an equipotential lug for this purpose. The equipotential lug is marked with the following symbol .

BOIL-OVER PREVENTION IN HENNY PENNY COOKERS



FAILURE TO FOLLOW THESE INSTRUCTIONS CAN RESULT IN SHORTENING OVERFLOWING THE FRYPOT WHICH COULD CAUSE SERIOUS BURNS, PERSONAL INJURY, FIRE AND/OR PROPERTY DAMAGE.

- **THE SHORTENING MAY BE STIRRED ONLY DURING THE MORNING START UP PROCEDURE. DO NOT STIR THE SHORTENING AT ANY OTHER TIME.**
- **FILTER THE SHORTENING AT LEAST TWICE A DAY.**
- **FILTER ONLY WHEN “COOL” IS DISPLAYED.**
- **BRUSH ALL CRACKLINGS FROM FRYPOT SURFACES AND THE COLD ZONE DURING THE FILTERING PROCESS.**
- **MAKE SURE THE FRYER IS LEVEL.**
- **BE CERTAIN THE SHORTENING IS NEVER ABOVE THE UPPER FRYPOT “FILL” LINE.**
- **BE CERTAIN THAT THE GAS CONTROL VALVE AND BURNERS ARE PROPERLY ADJUSTED. (GAS UNITS ONLY)**
- **USE RECOMMENDED LOAD SIZE**

FOR ADDITIONAL INFORMATION ON THESE INSTRUCTIONS, REFER TO THE HENNY PENNY OPERATOR MANUAL AND THE KFC STANDARDS LIBRARY.

**FOR ASSISTANCE CALL THE HENNY PENNY SERVICE DEPARTMENT AT
1-800-417-8405.
or
1-937-456-8405**

SECTION 3. OPERATION

3-1. OPERATING COMPONENTS

POWER/PUMP Switch

A three way switch with center OFF position; move the switch to the position marked POWER to operate the fryer; move the switch to the position marked PUMP to operate the filter pump; certain conditions must be met prior to operation of the filter pump; these conditions are covered later in this section

Frypot

This reservoir holds the cooking shortening, and is designed to accommodate the heat exchanger, 6 head of product and an adequate cold zone for collection of cracklings

Carrier

This stainless steel carrier consists of five racks which contain the food product during and after frying

Drain Valve

A two-way ball valve, normally in the closed position; turn the handle to drain the shortening from the frypot into the filter drain pan

Drain Interlock Switch

A microswitch that provides protection for the frypot in the event an operator inadvertently drains the shortening from the frypot while the main switch is in the POWER position; the switch is designed to automatically shut off the heat when the drain valve is opened

Shortening Mixing System

A shortening mixing capability to help ensure shortening is properly mixed to prevent an accumulation of moisture and hence boiling action in the pot; the filter pump is activated by the controls, at preset intervals, to mix the shortening

Lid Latch

A mechanical catch on the front of the lid which engages a bracket on the front of the frypot, when lid is lowered

Air Valve

Pumps air into the shortening, periodically, to keep the shortening at a uniform temperature; this only functions when the unit has been sitting idle for a period of time, and when heating up from a cold start

3-1. OPERATING COMPONENTS

(Continued)

High Limit

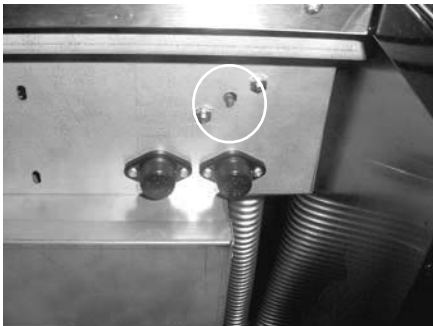

Figure 3-1

This high temperature control senses the temperature of the shortening; if the temperature of the shortening exceeds 450°F (230°C), this control will open and shut off the heat to the frypot; when the temperature of the shortening drops to a safe operation limit, the control must be manually reset by pressing the red reset button, located under the control panel, in the right, front of the fryer

Filter Drain Pan

The removable pan that houses the filter and catches the shortening when it is drained from the frypot; also used to remove and discard old shortening



When hot shortening is in this pan, use extreme care to avoid burns.

Filter Union

Connects the filter to the filter pump, and allows easy removal of the filter and drain pan

Fuses

A protective device which breaks the circuit when the current exceeds the rated value

3-2. LID OPERATION

To close lid:

1. Lower the lid until latch comes into contact with the pot.

To open lid:

1. Unlatch the front lid latch.
2. Lift up on handle to raise lid.

3-3. MELT CYCLE OPERATION

If the shortening is below 185°F (77°-85°C) with the POWER/PUMP switch in the POWER position, the fryer enters the Melt Cycle. The shortening is heated slowly to prevent scorching of the shortening. The heat cycles on and off to ensure slow melting of shortening. At 185°F (85°C) the heat stays on until the Cool Mode is reached, which is 250°F (121°C). The controls maintains this temperature until the COOL button is pressed.

See Filling and Adding Shortening Section.

3-4. SWITCHES AND INDICATORS

Refer to image at end of this section.

Product Selection Buttons

Select the number of heads, or product, to be cooked by pressing the button below the menued item; shortening will then heat to drop temperature of that item

Pressing the same button again begins the Cook Cycle; the display changes from “DROP” to counting down the cook time in minutes and seconds

At the end of the Cook Cycle, the alarm sounds and the display reads “DONE”; press the cycle button that is flashing, to stop the alarm ; the fryer then resets to the Cool Mode

NOTICE

A Cook Cycle can be aborted at any time by pressing and holding the product button.

Time/Temperature Display

A four digit LED type display which shows the remaining cook time during Cook Cycles and also the shortening temperature on demand from the operator

Heat Indicator

Illuminates whenever the control calls for heat; when shortening temperature has been reached, the heat light goes off

HI Temperature Indicator

The display reads “HI” if the shortening temperature is 40° F above the setpoint

Drop Indicator

The display reads “DROP” when the shortening has reached the setpoint temperature (will read “DROP” 2° before setpoint and 4° above setpoint)

Done Indicator

The display reads “DONE” at the end of the Cook Cycle

Temperature Button

Press this button to read the temperature of the shortening during a Cook Cycle

SCAN Button

Pressing this button toggles through the items being programmed

FUNCTION Button

Used in the programming of the controls

EXIT FILL Button

After filtering the fryer, if in the filter lockout mode, the display reads “FILL”, and the EXIT FILL button must be pressed.

3-4. SWITCHES AND INDICATORS Continued)

EXIT COOL Button

After cooking, or filtering the shortening, the temperature automatically goes into the Cool Mode, which keeps shortening at a lower temperature; this temperature extends the shortening life and minimizes the time to heat the shortening for the next Cook Cycle; EXIT COOL button must be pressed to heat up to setpoint temperature



ALTHOUGH THE DISPLAY WILL READ “COOL” DURING THE STANDBY MODE, THE SHORTENING IS HOT AND WILL CAUSE BURNS.

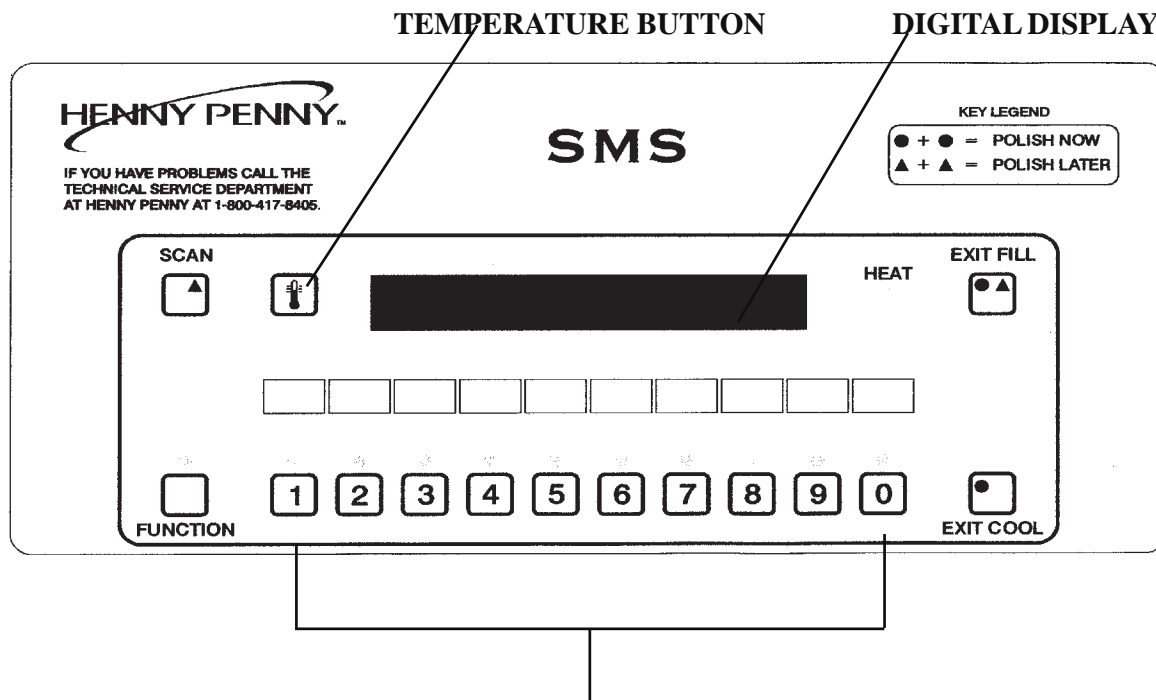

Figure 3-2

3-5. FILLING OR ADDING SHORTENING

CAUTION

The shortening level must always be above the heating elements when the fryer is heating and at the frypot level indicators on the rear of the frypot (Figure 3-3). Failure to follow these instructions could result in a fire and/or damage to the fryer.

When using solid shortening, it is recommended to melt the shortening on an outside heating source before placing it in the frypots. The burner tubes must be completely submerged in shortening. Fire or damage to the frypot could result.

1. It is recommended that a high quality frying shortening be used in the open fryer. Some low grade shortenings have a high moisture content and will cause foaming and boiling over.



To avoid severe burns when pouring hot shortening into frypot, wear gloves and take care to avoid splashing.

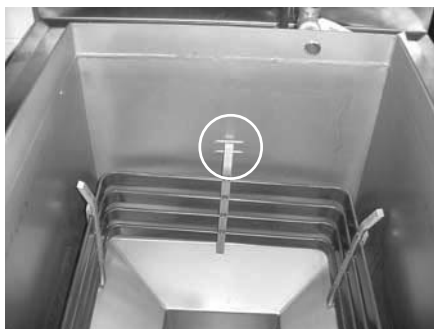

Figure 3-3

2. The electric model requires 100 lbs. (45 Kg.) of shortening. The frypot has 2 level indicator lines inscribed on the rear wall of the frypot which show when the heated shortening is at the proper level. Figure 3-3.
3. Cold shortening should be filled to the lower indicator.



BE CERTAIN THE SHORTENING IS NEVER ABOVE THE UPPER LEVEL INDICATOR LINE. FAILURE TO FOLLOW THESE INSTRUCTIONS CAN RESULT IN SHORTENING OVERFLOWING THE FRYPOT CAUSING SERIOUS BURNS, PERSONAL INJURY, FIRE AND/OR PROPERTY DAMAGE.

For complete instructions, refer to KFC's Standards Library.

3-6. BASIC OPERATION

Follow the procedure below on the initial start-up of the fryer, and each time the fryer is brought from a cold, or shut down condition, back into operation. These are basic, general instructions. Be sure to follow KFC's Standards Library when operating the fryer.

1. Make sure the shortening is filled to the proper level in the frypot; to the lower indicator.



DO NOT OVERLOAD, OR PLACE PRODUCT WITH EXTREME MOISTURE CONTENT INTO THE RACKS. 21 LBS. (9.5 KG.) IS THE MAXIMUM AMOUNT OF PRODUCT PER FRYPOT. FAILURE TO FOLLOW THESE INSTRUCTIONS CAN RESULT IN SHORTENING OVERFLOWING THE FRYPOT WHICH COULD CAUSE SERIOUS BURNS, PERSONAL INJURY, FIRE AND/OR PROPERTY DAMAGE.

2. Turn the POWER/PUMP switch to the POWER position and press the appropriate product button to select the amount of product to be cooked.

3. Stir the shortening as it's heating up from a cold start. Be sure to stir down into the cold zone.



DO NOT STIR THE SHORTENING AT ANY OTHER TIME EXCEPT AT MORNING START-UP. FAILURE TO FOLLOW THESE INSTRUCTIONS CAN RESULT IN SHORTENING OVERFLOWING THE FRYPOT WHICH COULD CAUSE SERIOUS BURNS, PERSONAL INJURY, FIRE, AND/OR PROPERTY DAMAGE.

3-6. BASIC OPERATION
(Continued)

4. Allow fryer to heat until digital display shows “DROP”.
(Press the EXIT COOL button if the display shows COOL”)

NOTICE

The heat cycles on and off approximately 10 degrees before the setpoint temperature, to help prevent overshooting the setpoint temperature. (proportional control)

5. Slide racks of breaded product into carrier on the lid, starting with the bottom rack, to prevent damaged product.

NOTICE

Before loading product onto the racks, lower the racks into the hot shortening to prevent the product sticking to the racks.

6. Lower and latch the lid down and press the appropriate product button.
7. At the end of the cycle, an alarm sounds, and the display shows “DONE”. At this time, press the appropriate product button.
8. Unlatch and raise the lid cautiously.
9. Using the rack handles, remove the racks of product from the carrier, starting with the top rack to prevent damaged product.

**3-7. CARE OF THE
SHORTENING**



FOLLOW THE INSTRUCTIONS BELOW TO AVOID SHORTENING OVERFLOWING THE FRYPOT, WHICH COULD RESULT IN SERIOUS BURNS, PERSONAL INJURY, FIRE, AND/OR PROPERTY DAMAGE.

1. To protect the shortening when the fryer is not in immediate use, the fryer should be put into the Cool Mode.
2. Frying breaded products requires filtering to keep the shortening clean. The shortening should be filtered at least twice a day; after lunch rush and at the end of the day.
3. Maintain the shortening at the proper cooking level. Add fresh shortening as needed.
4. Do not overload the racks with product (21 lbs. (9.5 kgs.) maximum), or place product with extreme moisture content into racks.



WITH PROLONGED USE, THE FLASHPOINT OF SHORTENING IS REDUCED. DISCARD SHORTENING IF IT SHOWS SIGNS OF EXCESSIVE SMOKING OR FOAMING. SERIOUS BURNS, PERSONAL INJURY, FIRE, AND/OR PROPERTY DAMAGE COULD RESULT.

**3-8. FILTERING
INSTRUCTIONS**

The Henny Penny gas 6 head open fryer, Model 290, must be cleaned and the shortening must be cleaned and polished at least twice daily; after lunch rush and at the end of the day. Refer to KFC's Standards Library.

Filter shortening immediately following a Cook Cycle when the shortening temperature is in the Cool Mode; 250° F (121° C) or less.



Drain the shortening at 250° F (121° C) or less. The higher temperatures cause cracklings to burn on the steel frypot surfaces after the shortening has drained.

**3-8. FILTERING
INSTRUCTIONS
(continued)**



ONLY FILTER WHEN “COOL” IS DISPLAYED. FAILURE TO DO SO CAN RESULT IN SHORTENING OVERFLOWING THE FRYPOT, CAUSING SERIOUS BURNS, PERSONAL INJURY, FIRE, AND/OR PROPERTY DAMAGE.

High volume cooking could cause the cold zone to fill quicker with cracklings and cleaning may be required more often. Part of the process involves removing cracklings from the cold zone of the frypot.

1. Turn POWER/PUMP switch to OFF position.
2. Make sure filter drain pan is under fryer and the filter union is fastened to the filter standpipe, coming out of the pan.



The filter drain pan must be as far back under fryer as it will go, and the cover in place. Be sure the hole in the cover lines up with the drain before opening the drain. Failure to follow these instructions causes splashing of shortening and could result in personal injury.

Surfaces of fryer and racks will be hot. Use care when filtering to avoid getting burned.

Shortening Stirrer

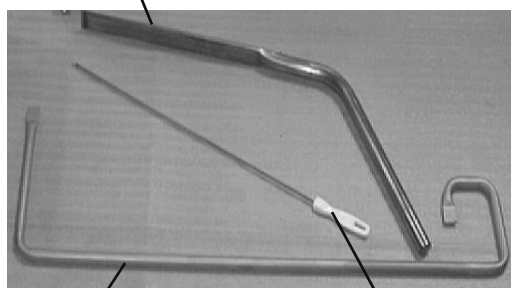

Drain Cleanout Rod

Small White Brush

3. Remove cooking racks, carrier and wipe bottom of lid. Tilt lid out of the way to clean frypot.
4. Pull drain handle towards you to open drain valve. The handle should point straight out to the front of the fryer. Use large white brush to clean cracklings from the elements and from sides and bottom of frypot as shortening drains. Use the drain cleanout rod to push cracklings through drain opening in bottom of frypot if necessary. Using the small straight white brush, clean between the elements and the frypot wall.



BRUSH ALL CRACKLINGS FROM FRYPOT SURFACES AND THE COLD ZONE DURING THE FILTERING PROCESS. FAILURE TO DO SO CAN RESULT IN SHORTENING OVERFLOWING THE FRYPOT, WHICH COULD CAUSE SERIOUS BURNS, PERSONAL INJURY, FIRE AND/OR PROPERTY DAMAGE.

3-8. FILTERING
INSTRUCTIONS
(Continued)

5. Scrape cracklings and crackling ring from frypot and discard. Do not let cracklings drain into filter drain pan. These cracklings can cause a burned taste in gravy. Wipe all surfaces with a clean damp towel. If water drops into cold zone, dry with towel before pumping shortening back into the frypot.
6. Return drain handle to the closed position to close the drain.
7. Turn POWER/PUMP switch to PUMP, and when all shortening has been pumped into frypot swing drain handle to the closed position to close the drain.



IF THERE ARE AIR BUBBLES COMING UP IN THE SHORTENING, IT'S POSSIBLE THAT THE FILTER CONNECTION AT THE UNION ON THE FILTER TUBE IS NOT TIGHTENED PROPERLY. IF SO, TURN OFF THE PUMP AND USE PROTECTIVE CLOTH OR GLOVE WHEN TIGHTENING THE UNION. THIS UNION WILL BE HOT AND SEVERE BURNS WILL RESULT.

3-9. CHANGING THE FILTER
ENVELOPE

The filter envelope should be changed after 10-12 filterings, or whenever it becomes clogged with crumbs. Refer to KFC's Standards Library.



Use protective cloth or glove when disconnecting the filter union or severe burns could result.

If the filter pan is moved while full of shortening, use care to prevent splashing, or severe burns could result.



Be sure that the filter screens, crumb catcher, filter clips and the standpipe are thoroughly dry before assembly of the filter envelope or water will dissolve the filter paper.

3-10. CLEANING THE FRYPOT

After the initial installation of the fryer, as well as before every change of shortening, the frypot should be thoroughly cleaned as follows:

1. Turn the POWER/PUMP switch to OFF position, and unplug unit from wall receptacle.



Moving the fryer or filter drain pan while containing hot shortening is not recommended. Hot shortening can splash out and severe burns could result.

The filter drain pan must be as far back under fryer as it will go, and the cover in place. Be sure the hole in the cover lines up with the drain before opening the drain. Failure to follow these instructions causes splashing of shortening and could result in personal injury.

2. If hot shortening is present in the frypot, it must be drained by slowly pulling the drain handle out towards you.
3. Close the drain valve and discard the shortening.
4. Raise lid, remove the racks and carrier from lid, and tilt lid back, so that the lid won't interfere with cleaning.
5. Refer to KFC's Standard's Library on cleaning instructions.

CAUTION

If the cleaning solution in the frypot starts to foam and boil over, immediately turn the POWER Switch to OFF or damage to components could result.

Do not use steel wool, other abrasive cleaners or cleaners/sanitizers containing chlorine, bromine, iodine or ammonia chemicals, as these will deteriorate the stainless steel material and shorten the life of the unit.

Do not use a water jet (pressure sprayer) to clean the unit, or component damage could result.

NOTICE

Make sure the inside of the frypot, the drain valve opening, and all parts that come in contact with the new shortening are as dry as possible.

3-11. FILTER PUMP MOTOR PROTECTOR-MANUAL RESET

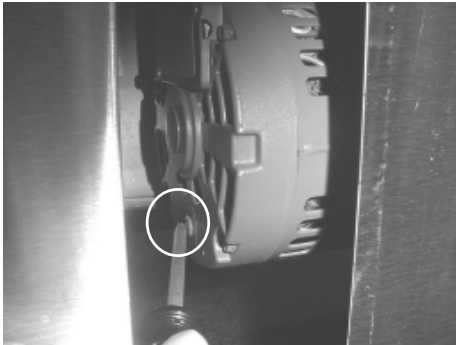

The filter pump motor is equipped with a manual reset button, located on the rear of the motor, in case the motor overheats. If motor won't run, wait about 5 minutes before attempting to reset this protective device to allow motor to cool. Remove the access panel on the left side panel of the unit to reset the button. It takes some effort to reset, and a screwdriver can be used to help reset the button.



To prevent burns caused by splashing shortening, turn the unit's main power switch to the OFF position before resetting the filter pump motor's manual reset protection device.

3-12. REGULAR MAINTENANCE

The Henny Penny open fryer does require care and proper maintenance. The table below provides a summary of scheduled maintenance. The following paragraphs provide step-by-step preventive maintenance procedures to be performed by the operator

<u>Procedure</u>	<u>Frequency</u>
Filtering of shortening	See KFC's Standards Library
Changing of shortening	See KFC's Standards Library
Changing the filter envelope	See KFC's Standards Library
Cleaning the frypot	See KFC's Standards Library
Cleaning Nylatrons	Monthly-see below
Lubricate lid rollers	Annually-see below

3-13. PREVENTIVE MAINTENANCE



Cleaning Nylatron Slides

1. Spray Henny Penny biodegradable, food safe, foaming degreaser (part no. 12226) on Nylatrons.
2. Raise lid up and down several times to spread the degreaser
3. Wipe Nylatron slides to remove food soil, grease, and degreaser residue.

Lubricating Lid Rollers

The lid rollers, in the back of the fryer should be lubricated at least once a year, to allow the lid easy movement.



1. Remove the back shroud of the fryer
2. Using spindle lube, part number 12124, place a small amount of lube on both top and bottom rollers. Make sure to lube both left and right rollers.

3-14. PROGRAMMING

1. Press and hold the FUNCTION button for two seconds. “REG PROGRAM” shows in the display, followed by “CODE”.
2. Press the code 1-2-3. “SELECT PRODUCT” scrolls across the display.

NOTICE

If no buttons are pressed, within approximately 1 minute while in the Program Mode, the controls will revert back to the Cook Mode.

3. Press the appropriate product button, (1-0), to identify what product you want to program.
4. “INT1” and “TIME” flashes on the left side of the display. The right side shows the starting time of the Cook Cycle and can be changed by pressing the appropriate numbers. Ex: Press 1,0,0,0 and 10:00 flashes on the right side of the display, setting the start time at 10 minutes.
5. After setting the time, press and release the FUNCTION button and “INT1” and “TEMP” flashes on the left side of the display. The right side shows the starting temperature and can be changed by pressing the appropriate numbers. Ex: Press 2,5,0 and “250° F” shows on the right side of the display, setting the start temperature at 250° Fahrenheit.
6. After setting the temperature, press and release the FUNCTION button and “INT1”, “LOAD”, and “COMP” flashes on the left side of the display. The factory preset load compensation value shows in the right side of the display.

3-14. PROGRAMMING **(Continued)**

7. After the load compensation, press and release the FUNCTION button. “PROP” and “CONTROL” shows on the left side of the display and the factory preset proportional control temperature shows on the right side of the display.
8. After the proportional control, press and release the FUNCTION button. “ALM 1” and “TIME” flashes in the left side of the display, and the first alarm time shows on the right side of the display. To change the time the alarm sounds, press the appropriate product buttons to set the time. Ex: Press 1,0,0,0. 10:00 flashes on the right side of the display, which means when the timer counts down to 10 minutes, an alarm sounds.
9. After alarm is set, press and release the FUNCTION button. “ALM 1”, “SELF-”, and “CANCEL” flashes in the left side of the display and “YES” or “NO” shows on the right side of the display. The yes and no can be toggled by pressing any of the product buttons, (1-0). “YES” means the alarm tone automatically stops after several beeps. “NO” means some one must manually press the appropriate product button to stop the alarm tone.
10. Repeat steps 9 and 10 for alarms 2 and 3.
11. After alarm 3 is set, press and release the FUNCTION button. “FILTER” and “CYCLES” show on the left side of the display and the Filter Cycle value is on the right side of the display. The value is the number of Cook Cycles that must completed before the control signals the operator that the shortening needs filtered.
12. After the filter value is set, press and release the FUNCTION button. “EOC” and “EXIT” flashes on the left side of the display and “COOL” shows on the right side of the display. The end-of-cycle, (EOC), exit point can be set to COOL, SETP, or FLTR, by pressing any of the product buttons (EOC). At the end of a Cook Cycle the controls can be set to return to Cool Mode, the setpoint temperature, or to signal the operator to filter the shortening.

3-14. PROGRAMMING **(continued)**

13. After the end-of-cycle point is set, press and release the FUNCTION button. “HEAD” flashes on the left side of the display and a number shows on the right side of the display. The number on the right, is the number of head of chicken to be cooked at one time, when that product button is pressed. The number can be changed by pressing the appropriate product button. The control can then accumulate the head count (usage) of that product, based on counting the number of Cook Cycles.

NOTICE

Another product can be programmed while in the program mode by following these procedures:

Press and hold the SCAN button at any time while in the Program Mode and the display will scroll “SELECT PRODUCT”. Then press any of the product buttons, (1-0), and now that product can be programmed.

14. To program second interval, press and release the SCAN button while in the Time Mode of the first mode. “INT2” and “TIME” will flash on the left side of the display. Then follow the steps above, starting with step 4.

3-15. SPECIAL PROGRAM MODE

Review Usage

1. Press and hold the FUNCTION button for two seconds until “REG PROGRAM” shows in the display. As soon as “REG PROGRAM” shows in the display, press and release the FUNCTION button 1 time until “REVIEW USE” shows in the display.
2. “DAILY” shows in the display. Press any of the product buttons to view the usage of that product. Press and hold the FUNCTION button to exit Special Program mode.

Reset Usage

1. Press and hold the FUNCTION button for two seconds until “REG PROGRAM” shows in the display. As soon as “REG PROGRAM” shows in the display, press and release the FUNCTION button 2 times until “RESET USE” shows in display.
2. When “CODE” shows in the display, press 1-3-5. “DAILY” will show in the display, and press any of the Product buttons to reset them to 0.

3-15. SPECIAL PROGRAM MODE

(Continued)

Factory Presets (F/C, Gas/Electric, Speaker Volume, Speaker Frequency, Codes, Initialize System)

1. Press and hold the FUNCTION button for two seconds until “REG PROGRAM” shows in the display. As soon as “REG PROGRAM” shows in the display, press and release the FUNCTION button 3 times until “FAC PRESET” shows in the display.
2. When “CODE” shows on the display, enter 2957. “DEG” and “MODE” flashes in the display. Press any of the product buttons to toggle from °F to °C, and vice versa.
3. Press and release the FUNCTION button and “TYPE” and “FRYR” flashes in the display. Press any of the product buttons to toggle from “GAS” to “ELEC”, or vice versa.
4. Press and release the FUNCTION button twice, and “SPKR” and “VOL” flashes in the display. The volume can be changed from 01 to 10, 10 being the loudest.
5. Press and release the FUNCTION button 3 times, and “SPKR” and “FREQ” will flash in the display. The frequency can be set from 100 to 2000.
6. Press and release the FUNCTION button 10 times, and “INITIALIZE SYSTEM” scrolls across the display. Press and hold any of the product buttons and the display will count down from 5. Once the display counts down, release the product button, and the control will set factory preset parameters into the controls.

NOTICE

Before attempting to change the other modes in the Factory Preset Mode, please call the Henny Penny Technical Service Department at 1-800-417-8405, or 1-937-456-8405.

3-15. SPECIAL PROGRAM MODE

(Continued)

Tech I/O Mode

1. Press and hold the FUNCTION button for two seconds until “REG PROGRAM” shows in the display. As soon as “REG PROGRAM” shows in the display, press and release the FUNCTION button 4 times until “TECH I-O” shows in the display.
2. When “CODE” shows in the display, press 2-4-6 (1-7-7-6 for CE units). “HEAT”, and “PUMP” shows alternately in the display. Also, the LEDs over 1 and 3 flashes alternately.
3. To test the heat circuit, press and hold the 1 button.
4. To test the pump system, press and hold the 3 button.

Appliance Test

Press and hold the FUNCTION button for two seconds until “REG PROGRAM” shows in the display. As soon as “REG PROGRAM” shows in the display, press and release the FUNCTION button 5 times until “APPL TEST” shows in the display.

With the power switch on, the display will show “CURR=”, along with the time it took the unit to heat from 250° to 300° F (121° to 149° C). This is normally recorded from the initial heat up in the morning.

**3-16. SPECIAL PROGRAM
MODE (Continued)**

Heat Control

1. Press and hold the FUNCTION button for two seconds until “REG PROGRAM” shows in the display. As soon as “REG PROGRAM” shows in the display, press and release the FUNCTION button 6 times until “HEAT CNTRL” shows in the display.
2. When “CODE” shows in the display, press 1-2-3-4. “MELT”, “EXIT”, and “TEMP” flashes in the display, along with the shortening temperature at which the unit will exit the melt cycle. This should be set at 180° F (82° C), and should not be changed until the factory is consulted.
3. Press and release the FUNCTION button and ”MELT”, “CYCLE”, and “100s” shows alternately in the display, along with the period (pulse) length of 4000. This should not be changed until the factory is consulted.
4. Press and release the FUNCTION button twice and “MELT”, “ON-”, “TIME”, and “100s”, shows alternately in the display, along with the length of time the heat is on. This should be set at 1700, and should not be changed until the factory is consulted.
5. Press and release the FUNCTION button three times and “COOL”, “SET-”, and “POINT” shows alternately in the display, along with the temperature at which the control exits the melt cycle. This is set at 250° F (121° C), and should not be changed until the factory is consulted.
6. Press and release the FUNCTION button four times and “AUTO”, and “IDLE” shows alternately in the display, along with “OFF”. This should not be changed until the factory is consulted.
7. Press and release the FUNCITON button five times and “AUTO”, “IDLE”, and “MMSS” shows alternately in the display, along with “0:00”. This should not be changed until the factory is consulted.
8. The last 3 functions in the Heat Control Mode are used by the factory only, and should not be changed.

SECTION 4. TROUBLESHOOTING

4-1. TROUBLE SHOOTING GUIDE

Problem	Cause	Correction
Power switch on but fryer completely inoperative	<ul style="list-style-type: none"> • Open circuit 	<ul style="list-style-type: none"> • Fryer plugged in • Check breaker or fuse at wall
Shortening not heating	<ul style="list-style-type: none"> • Drain valve open • High temperature limit tripped 	<ul style="list-style-type: none"> • Close drain valve • Reset high temperature limit; see Operating Controls Section
Foaming or boiling over	<ul style="list-style-type: none"> • See Boil-Over chart on fryer and beginning of Operation Section in this manual 	<ul style="list-style-type: none"> • Follow boil-over procedures from chart
Shortening not draining	<ul style="list-style-type: none"> • Drain valve clogged 	<ul style="list-style-type: none"> • Push cleaning rod through open drain valve.
Filter motor won't run	<ul style="list-style-type: none"> • Motor overheated 	<ul style="list-style-type: none"> • Reset motor; see Filter Motor Protector-Manual Reset Section
Product Color Not Correct: A. Too Dark	<ul style="list-style-type: none"> • Temperature too high • Breading to far in advance 	<ul style="list-style-type: none"> • Check temperature setting in the Program Mode • Bread product closer to frying period
B. Too Light	<ul style="list-style-type: none"> • Temperature too low • Fryer incorrect preheat • Wrong product button pressed 	<ul style="list-style-type: none"> • Check temperature setting in the Program Mode • Allow proper preheat time • Be sure to press the correct product to be cooked
C. Product Greasy	<ul style="list-style-type: none"> • Shortening old • Temperature too low • Frypot overloaded • Product not removed from frypot immediately after end of cycle 	<ul style="list-style-type: none"> • Replace shortening • Check temperature setting in the Program Mode • Reduce cooking load • Remove product form frypot promptly

NOTICE

More detailed troubleshooting information is available in the Technical Manual, available at www.hennypenny.com, or 1-800-417-8405 or 1-937-456-8405.

4-2. ERROR CODES

In the event of a control system failure, the digital display shows an error message. These messages are coded: “E04”, “E05”, “E06”, “E41”. A constant tone is heard when an error code is displayed, and to silence this tone, press any of the product buttons.

DISPLAY	CAUSE	PANEL BOARD CORRECTION
“E04”	Control board overheating	Turn switch to OFF position, then turn switch back to ON; if display still shows “E04”, the board is getting too hot; check for signs of overheating behind the control panel; once panel cools down the controls should return to normal; if “E04” persists, have control panel replaced
“E05”	Shortening overheating	Turn switch to OFF position, then back to ON; if display shows “E05”, the heating circuits and temperature probe should be checked; once the unit cools down, the controls should return to normal; if “E05” persists, have control panel replaced
“E06”	Temperature probe failure	Turn switch to OFF position, then back to ON; if the display shows “E06”, the temperature probe should be checked; once the probe is repaired, or replaced, the controls should return to normal; if “E06” persists, have control panel replaced
“E41”	Programming failure	Turn switch to OFF position, then back to ON; if display shows “E41”, the control should be re-initialized (See Programming Section) if the error code persists, have control panel replaced
“E71”	Pump motor relay failure or wiring problem	Replace relay if contacts are stuck closed; check wiring on POWER/PUMP switch, or at wall receptacle; L1 and N may be reversed

4-2. ERROR CODES (Continued)

CE Only - Along with the error codes from page 4-2, CE units have the following self-diagnostic error codes:

DISPLAY	CAUSE	PANEL BOARD CORRECTION
"E10"	High limit	Reset the high limit by manually pushing up on the red reset button; if the high limit does not reset, the high limit must be replaced
"E15"	Drain switch	Close the drain, using the drain valve handle; if display still shows "E-15", have the drain microswitch checked

GLOSSARY
HENNY PENNY OPEN FRYERS

air valve	a valve on the eight head fryer that allows air into the filter lines when the pump is on in the mixing mode on eight head fryers
airflow switch (gas fryers only)	a switch that senses the amount of airflow coming from the blower; if the airflow falls below a certain level, the switch cuts power to the gas control valve that shuts down the burners
blower (gas fryers only)	located on the rear of a gas fryer, the blower pulls flue gases out of the flue and provides the proper amount of air to the burner tubes for efficient combustion
breeding	a flour and seasoning mixture used to coat the product prior to frying
burner assembly (gas fryers only)	an assembly on gas fryers that houses the pilot light which ignites the gas that heats the fryer
burner tubes (gas fryers only)	the tubes through which heated air is forced to heat the shortening
carrier	a wire frame inside the eight head frypot that holds five racks of product during the cook cycle
casters	the wheels on bottom of the fryer that allow the unit to roll; casters should be locked when unit is in use and not being moved; casters may be adjusted to help level the fryer
cleaning solution	an agent used to clean the frypot; see recommended cleaning procedures
cold zone	an area in the bottom of the frypot where shortening is cooler than the area above; the zone allows the crumbs to settle without burning
cook cycle	a programmed cycle that cooks a particular product at a preselected temperature and for a preselected time
cooking load	the amount of product cooked during a cook cycle
counterweight	the weights shipped with the fryer that, when installed in the counterweight assembly, enable the eight head fryer lid to lift easily
counterweight assembly	an assembly of weights and cables that enable the eight head fryer lid to lift easily
cover	a protective lid for the frypot when fryer is not in use
cracklings	the crumbs of breeding that come off the product during a cook cycle
crumb catcher	the part of the filter assembly on four head fryers that filters crumbs out of the shortening before the shortening is pumped back into the frypot

data plate	a label or plate located on the right side panel of the fryer that indicates the fryer type, serial number, warranty date, and other information
drain handle	the handle used to open and close the drain valve
drain interlock switch	a microswitch that automatically shuts off the fryer heat in the event the drain valve is inadvertently opened while the fryer power switch is in the ON position
drain valve	a valve that allows the shortening to drain from the frypot into the filter drain pan; the fryer power switch should be in the OFF position before the drain valve is opened; the drain valve should remain closed at all other times
dumping table	a table onto which the cooked product is dumped after removal from the fryer frypot
fill lines	the four lines marked on the interior real wall of the frypot that show the proper shortening level (<i>also referred to as level indicator lines</i>)
filter clips	the clips are the part of the filter screen assembly that holds the filter envelope closed
filter drain pan	a pan that slides under the fryer into which shortening is drained
filter envelope	a fiber envelope into which the filter screen is placed; the end of the envelope is folded and held closed with filter clips; a part of the filter screen assembly
filter pan dolly	an optional transport cart for the filter drain pan
filter pump motor	the motor that powers the filtering system
filter screen assembly	an assembly that filters the shortening as it is pumped from the frypot; the assembly is made up of two filter screens, a filter envelope, two filter clips, and a crumb catcher (<i>Note: eight head fryers have two filter screens with no crumb catcher</i>)
filter union	the threaded connection between the fryer and the filter system that can be connected or released without tools
filter valve	the valve that must be opened to pump shortening back into the frypot during the filter cycle (<i>Models OFE-320, and 340</i>)
flame sensors (<i>gas fryers only</i>)	the sensors that shut off the gas supply to gas fryers if the pilot lights go out or do not light
fryer brush	a brush included with the fryer used to scrub the inside of the frypot
frypot	the interior portion of the fryer that holds the shortening and the product while cooking
frypot collar	the top flat surface area around the fryer lid

gas control valve (<i>gas fryers only</i>)	an automatic dual controller that controls gas to both pilot lights and gas pressure to burners on fryers; if either pilot light goes out, the controller shuts off the gas to the other pilot light
gas valve knob (<i>gas fryers only</i>)	the knob that opens and closes the gas control valve
gas pressure regulator (<i>gas fryers only</i>)	a device located on the gas control valve that regulates the gas pressure; the pressure specifications are preset at the factory
heat indicator	the light that illuminates when the shortening is being heated; the light goes off when the preset shortening temperature has been achieved
heating elements	the coils located inside the frypot on electric fryers that heat the shortening
high limit	a temperature control that opens and shuts off the heat to the frypot if it senses shortening temperature in excess of 420°F (212°C)
ignition modules	two modules that send electrical energy to the spark igniters that ignite the pilot lights on gas fryers
L-shaped brush	a brush included with the fryer that is used to clean around the burner tubes and heating elements
landing table	another name for a dumping table (<i>see dumping table</i>)
level indicator lines	the lines marked on the interior rear wall of the frypot that show the proper shortening level (<i>also referred to as fill lines</i>)
lid assembly	an assembly comprised of lid, lid handle, and lid latch which raises and lowers product into shortening on eight head fryers
lid handle	a handle that is attached to the lid and is used to lower the lid into contact with the frypot; the handle is then pulled forward and pushed down to lock the lid in place (<i>see lid latch</i>)
lid latch	a mechanical catch on the front of the fryer lid that engages a bracket located on the front of the frypot; the latch holds the lid down
manual shutoff valve (<i>gas fryers only</i>)	a valve located between the fryer and the wall that shuts off the flow of gas from the supply line; this is not the main shutoff valve for the store
melt cycle	a heat mode that cycles on and off to slowly melt the shortening when the power switch is on and the shortening temperature is below a certain temperature; the melt cycle prevents scorching of the shortening
pilot orifice (<i>gas fryers only</i>)	a controlled opening for the pilot light located on the burner assembly
pilot light (<i>gas fryers only</i>)	a small flame that remains burning even when the fryer is not in use; the flame ignites the gas when the fryer is turned on

power/pump switch	a three-way switch located on the front control panel of the fryer that serves as an off/on switch and a filter switch
product	a food item cooked in the fryer
rack	the wire grid that slides into the carrier to hold product during the cook cycle
setpoint	a preset cooking temperature; the setpoint is a programmable feature
shortening mixing system	an automatic system on eight head fryers that periodically uses the filter pump to mix the shortening in the frypot to prevent an accumulation of moisture to minimize the boiling action in the frypot
shortening shuttle	optional equipment used for shortening disposal
sift breading	the process of removing clumps from breading
spark igniters (<i>gas fryers only</i>)	the igniters that create a spark to ignite the pilot lights on gas fryers (<i>see ignition modules</i>)
standpipe	the pipe through which oil is pumped back into the frypot after the filtering process is complete
standpipe assembly	the pipe and fittings that are part of the shortening filtering process
straight brush	a brush that is included with the fryer that is used to clear the drain in the bottom of the frypot
temperature probe	a round probe that is located in the inside of the frypot that measures the temperature of the oil in the frypot; the temperature probe communicates with the control panel
thermal protector	overheat protection switch for the filter motor that must be manually reset if tripped



Henny Penny Corporation
P.O.Box 60
Eaton, OH 45320

1-937-456-8400
1-937-456-8402 Fax

Toll free in USA
1-800-417-8417
1-800-417-8434 Fax

www.hennypenny.com

* FM05-029-g* Henny Penny Corp., Eaton, Ohio 45320, Revised 8-6-10