

VELOCITY  
SERIES



# OPERATOR'S M A N U A L

**VELOCITY SERIES™ PRESSURE FRYER**

MODEL

**PXE-100**



**HENNY PENNY®**  
Engineered to Last

REGISTER WARRANTY ONLINE AT [WWW.HENNYPENNY.COM](http://WWW.HENNYPENNY.COM)

Original Instructions

Read instructions before operating the appliance



# HENNY PENNY ELECTRIC PRESSURE FRYER

## SPECIFICATIONS

Pot Capacity	8 head of chicken - 24 lbs. (10.8 kg) 76 lbs. oil (34 Kg.)
Electrical	208 VAC, 3 Phase, 50/60 Hz, 17 KW, 47.2 Amps 240 VAC, 3 Phase, 50/60 Hz, 17 KW, 40.9 Amps 480 VAC, 3 Phase, 50/60 Hz, 17 KW, 20.5 Amps
Heating	Two 8,500 watt electric immersion elements

## NOTICE

A data plate, located on the back shroud behind the lid identifies the fryer model, serial number, warranty date, and other information. Also, the serial number is stamped on the outside of the counter top. See figure below.

Serial No. ————

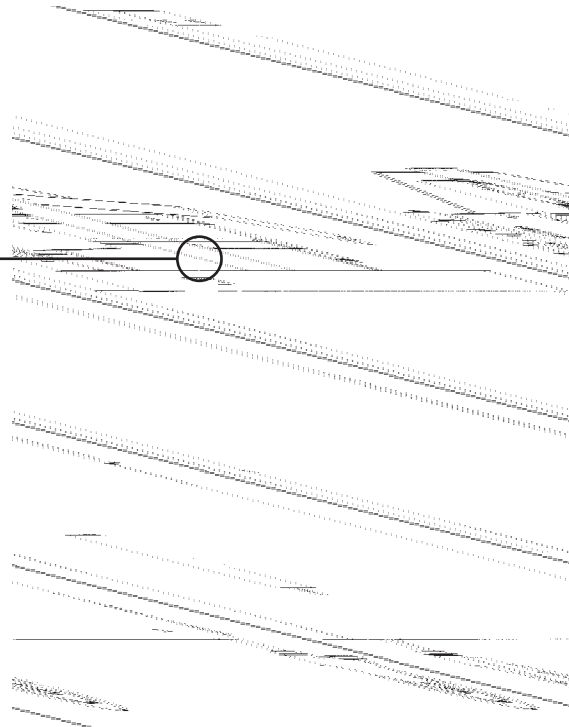

# PXE-100 DIMENSIONS

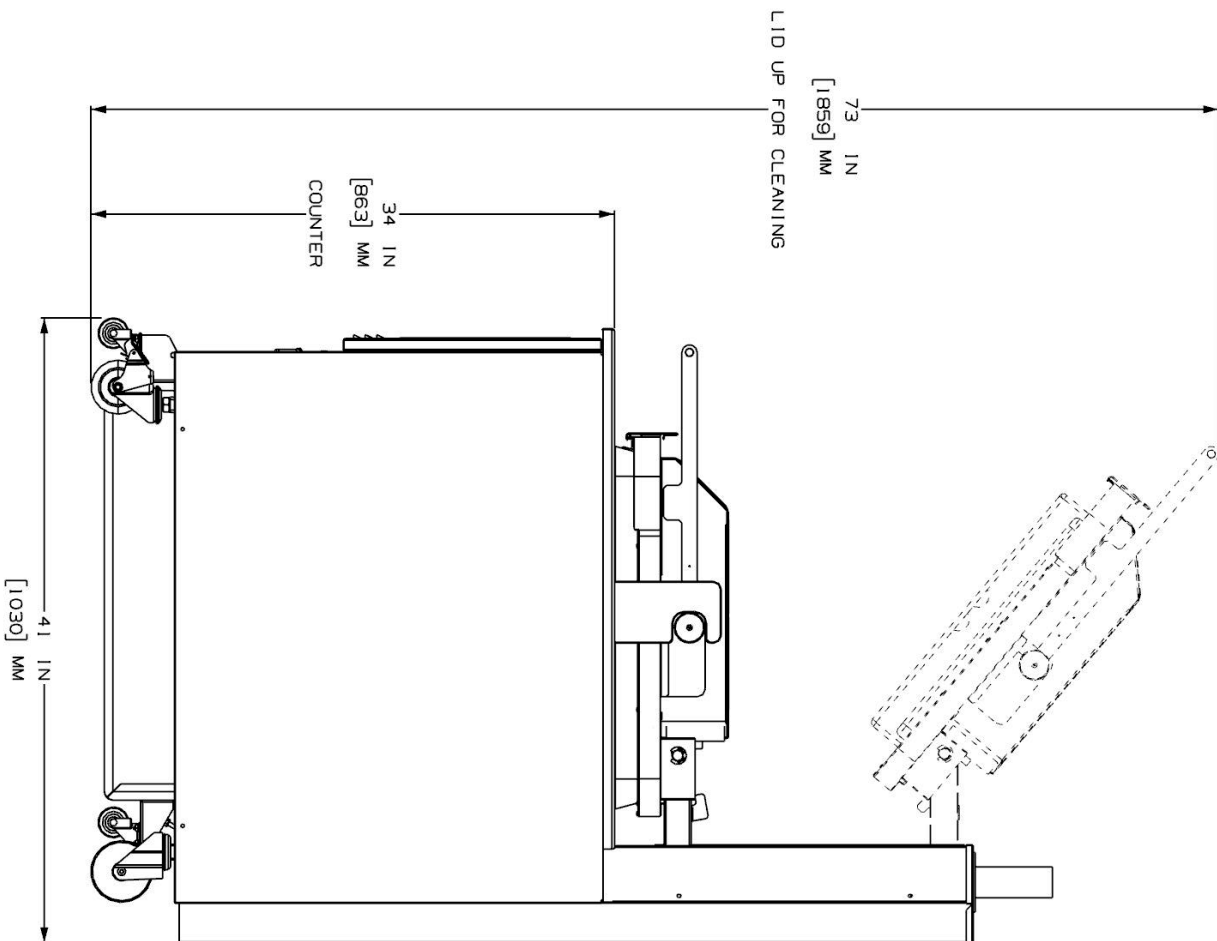
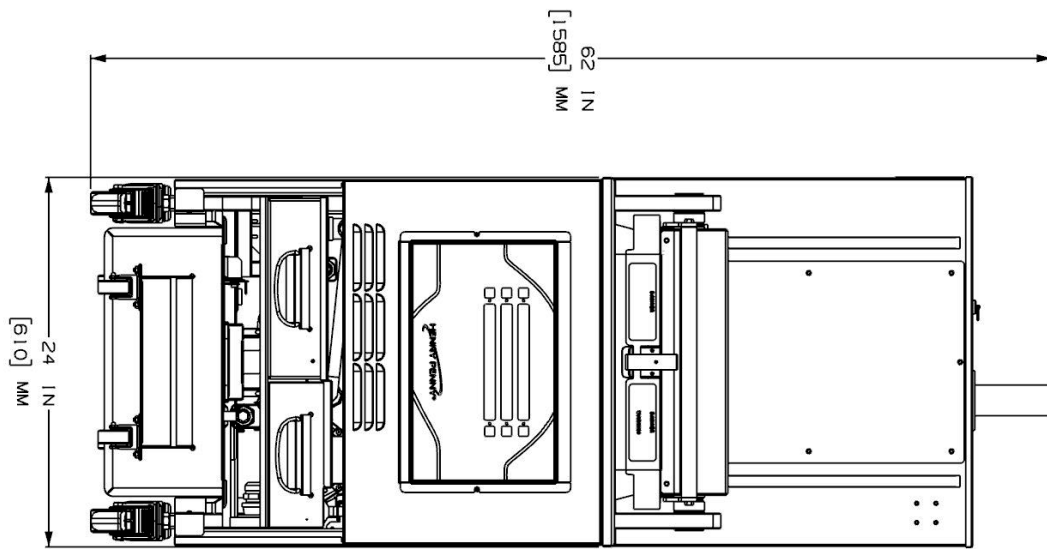

**HENNY PENNY  
8 HEAD ELECTRIC PRESSURE FRYER**



*Fryer must be installed and used in such a way to prevent water from contacting the shortening.*



This appliance is not intended to be operated by means of an external timer or a separate remote control system.



This appliance is not intended for use by persons (including children) with reduced physical, sensory or mental capabilities, or lack of experience and knowledge, unless they have been given supervision or instruction concerning use of the appliance by a person responsible for their safety.

## TABLE OF CONTENTS

Section	Page
Section 1. INTRODUCTION .....	1
1-1 Safety .....	1
1-2 Proper Care .....	2
1-3 Assistance .....	2
Section 2. INSTALLATION .....	3
2-1 Introduction .....	3
2-2 Unpacking.....	3
2-3 Selecting the Fryer Location .....	7
2-4 Leveling the Fryer .....	7
2-5 Ventilation of Fryer.....	8
2-6 Electrical Requirements.....	8
2-7 International Electrical Requirements .....	9
Section 3. OPERATION .....	11
3-1 Operating Components.....	11
3-2 Control Overview .....	12
3-3 Display Options .....	14
3-4 4+Title Option .....	14
3-5 5+Next Option.....	15
3-6 6 Item Option.....	15
3-7 Drain Pan Assembly .....	16
3-8 Product Racking Recommendations.....	17
3-9 Lid Operation.....	18
3-10 Start-up .....	20
3-11 Filling the Oil Tank.....	21
3-12 Condensation Tank .....	21
3-13 Filter Pump Motor Protector-Manual Reset .....	22
3-14 Regular Maintenance Schedule .....	22
3-15 Initial Oil Fill.....	23
3-16 Basic Operation .....	24
3-17 Care of the Oil .....	25
3-18 Main Menu .....	25
3-19 Filtering Instructions .....	26
3-20 Bulk Dispose .....	30
3-21 Changing the Filter Envelope.....	31
3-22 Clean-Out Mode .....	31
3-23 Preventive Maintenance .....	36
Section 4. PROGRAMMING.....	39
4-1 Program Menu .....	39
4-2 Product Programming.....	39
4-3 Special Programming .....	41
Section 5. TROUBLE SHOOTING .....	44
5-1 Troubleshooting Guide.....	44
5-2 Error Codes.....	45

# SECTION 1: INTRODUCTION

## 1-1 SAFETY

The instructions in this manual have been prepared to aid you in learning the proper procedures for your equipment. Where information is of particular importance or is safety related, the words NOTICE, CAUTION, or WARNING are used. Their usage is described below.

If a problem occurs during the first operation of a new unit, recheck the Installation Section of the Operator's Manual.

Before troubleshooting, always recheck the Operation Section of the Operator's Manual.

Where information is of particular importance or is safety related, the words DANGER, WARNING, CAUTION, or NOTICE are used. Their usage is described as follows:



SAFETY ALERT SYMBOL is used with DANGER, WARNING or CAUTION which indicates a personal injury type hazard.



NOTICE is used to highlight especially important information.



*CAUTION used without the safety alert symbol indicates a potentially hazardous situation which, if not avoided, may result in property damage.*



*CAUTION used with the safety alert symbol indicates a potentially hazardous situation which, if not avoided, could result in minor or moderate injury.*



**WARNING indicates a potentially hazardous situation which, if not avoided, could result in death or serious injury.**



**DANGER INDICATES AN IMMINENTLY HAZARDOUS SITUATION WHICH, IF NOT AVOIDED, WILL RESULT IN DEATH OR SERIOUS INJURY.**

**1-1.  
SAFETY  
(CONT.)**



Equipotential Ground Symbol



Waste Electrical and Electronic Equipment (WEEE) Symbol

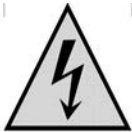

OR



Shock Hazard Symbols



OR



Hot Surface Symbols

**1-2.  
PROPER CARE**

As in all Henny Penny equipment, the unit requires care and maintenance. Requirements for maintenance and cleaning are contained in this manual and must be a regular part of the operation of the unit.

---

**1-3.  
ASSISTANCE**

Should you require outside assistance, call your local distributor in your area, or call 1-800-417-8405 or 1-937-456-8405 for Henny Penny Technical Support.



## SECTION 2: UNPACKING / INSTALLATION

### 2-1. INTRODUCTION

This section provides the installation and unpacking instructions.

#### NOTICE

- Any shipping damage should be noted in the presence of the delivery agent and signed prior to his or her departure.
- Installation of this unit should be performed only by a qualified service technician.

### 2-2. UNPACKING

#### WARNING

- **Take care when moving the fryer to prevent personal injury. The fryer weighs approximately 877 lbs.(398 Kg).**
- **Do not puncture the fryer with any objects such as drills or screws as electrical shock or component damage could result.**

#### CAUTION

*To avoid personal injury, all counter-weights must be installed and secured before attempting to unlatch the lid.*

1. Cut and remove the plastic bands from the main box.
2. Remove the box lid and lift the main box off the fryer.
3. Remove corner packing supports (4).
4. Cut the stretch film from around the carrier/rack box and remove it from the top of the fryer lid.
5. Cut and remove the metal bands holding the fryer to the pallet.
6. Remove the fryer from the pallet. See one unloading method described on 6.

**2-2.  
UNPACKING  
(CONT.)**

 **CAUTION**

*Do not drop counterweights, or personal injury could result. Each counterweight weighs approximately 20 lbs. (9 kg.) each.*

7. Remove the counterweights from the pallet, which are strapped to the pallet, under the fryer.
8. Remove rear service cover.
9. Load the six weights into the counterweight assembly. See page 7.
10. Replace rear service cover.

 **WARNING**

**To avoid personal injury and assure safe operation of unit, rear service cover must be in place.**

11. Cut warning tags from the lid assembly. The lid may now be unlatched.
12. Remove the accessories from inside the filter drain pan.
13. Remove the protective paper from the fryer cabinet. Clean exterior surface with a damp cloth.

## Ramp Unloading

4

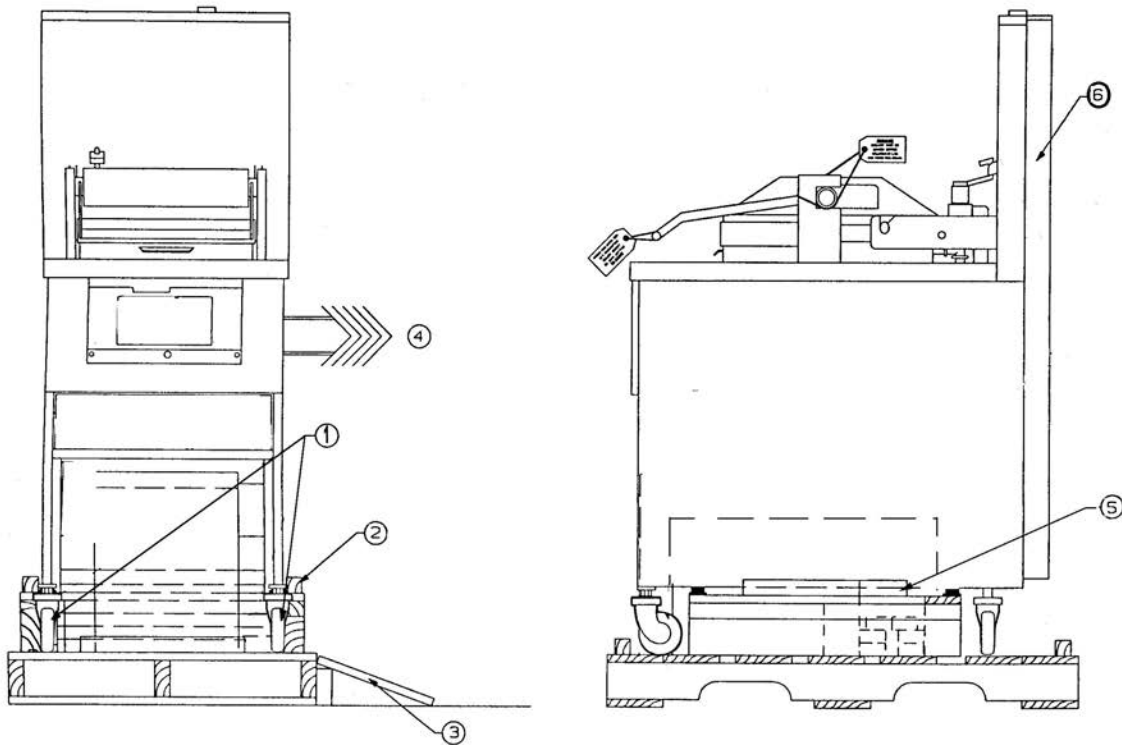

1. Front casters are fixed in the forward position.
2. Pry off the rail on either side of the pallet.
3. Prop up a ramp for each caster on the selected side.

If ramp is not being used, rest the selected side's casters onto the ground and move to step 4.

4. Tilt and roll the unit off the pallet onto the ramp (if available). The front casters will slide onto the ramp.

Pull the pallet from under the unit and set the unit onto the ground.

5. Remove the weights from the pallet.
6. Remove the rear cover. The weight segments must be installed per instructions contained therein before attempting to unlatch the lid.

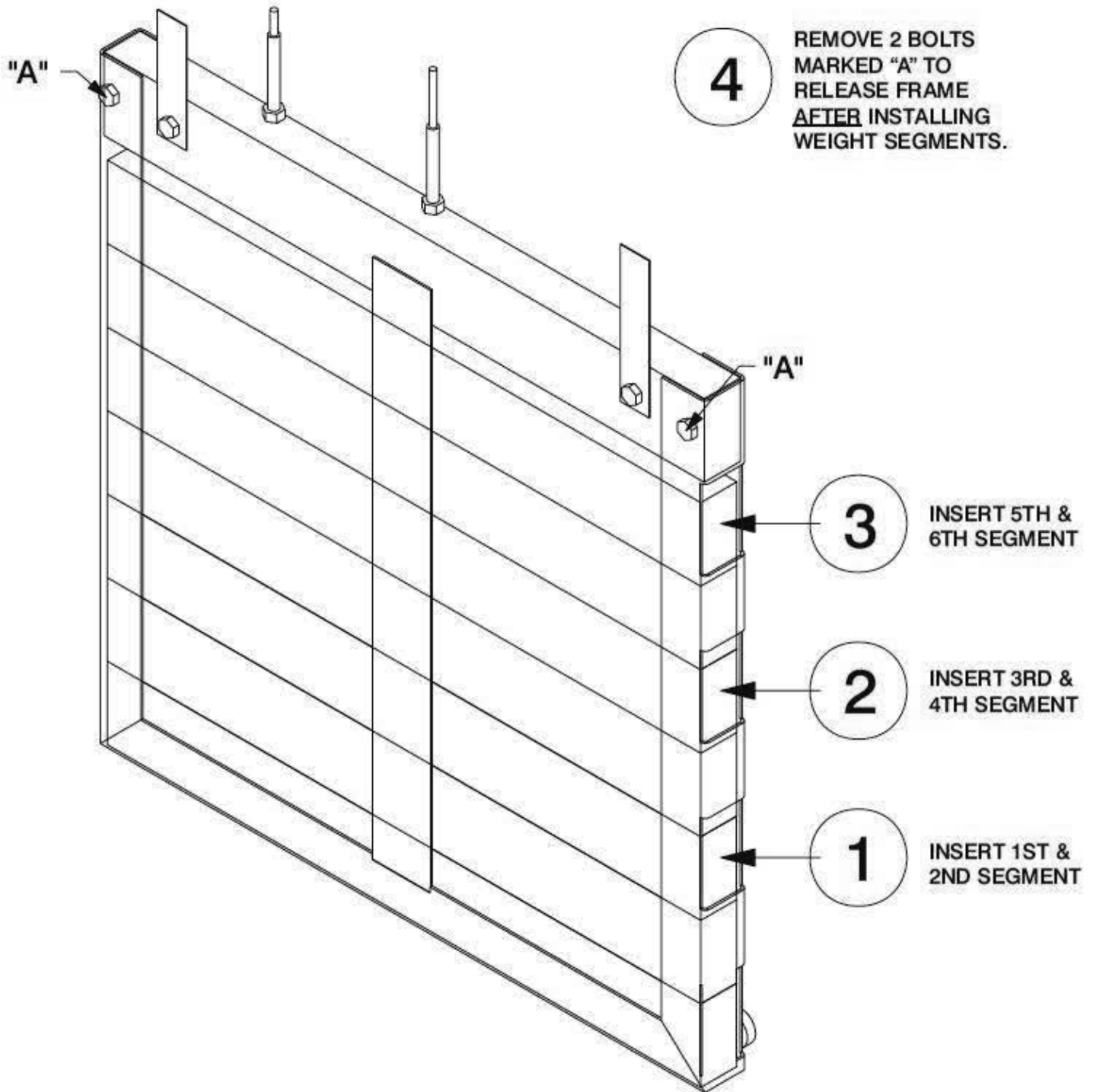

**CAUTION**

TO AVOID PERSONAL INJURY,  
ALL SEGMENTS MUST BE  
INSTALLED AND SECURED IN  
THE FRAME BEFORE ATTEMPTING  
TO UNLATCH LID.

**NOTICE**

- EACH WEIGHT SEGMENT WEIGHS APPROXIMATELY 20 LBS. (9.0 KG)
- ALL SEGMENTS ARE IDENTICAL

**2-3.  
SELECTING THE  
LOCATION**

The proper location of the fryer is very important for operation, speed, and convenience. Choose a location which provides easy loading and unloading without interfering with the final assembly of food orders. Operators find that frying from raw to finish, and holding the product in a warmer provides fast continuous service. Landing or dumping tables should be provided next to the fryer. The best efficiency will be obtained by a straight line operation, i.e. raw in one side and finish out the other side. Order assembly can be moved away with only a slight loss of efficiency.

To properly service the fryer, 24 inches (60.96 cm) of clearance is needed on all sides of the fryer. Access for servicing by removing a side panel.

**CAUTION  
FIRE HAZARD**

*To avoid fire and ruined supplies, the area under the fryer should not be used to store supplies.*

**WARNING  
BURN RISK**

**To prevent severe burns from splashing hot oil, position and install fryer to prevent tipping or movement. Restraining ties may be used for stabilization.**

---

**2-4.  
LEVELING THE  
FRYER**

For proper operation, level the fryer from side to side and front to back. Use level on the flat areas around the frypot collar.

**DANGER**

**FAILURE TO FOLLOW THESE LEVELING INSTRUCTIONS CAN RESULT IN OIL OVERFLOWING THE FRYPOT WHICH COULD CAUSE SERIOUS BURNS, PERSONAL INJURY, FIRE AND/OR PROPERTY DAMAGE.**

**2-5.  
VENTILATION OF  
FRYER**

The fryer should be located with provision for venting into adequate exhaust hood or ventilation system to permit efficient removal of steam exhaust and frying odors. The exhaust canopy must be designed to avoid interference with the operation of the fryer. Consult a local ventilation or heating company to help in designing an adequate system.

**NOTICE**

Ventilation must conform to local, state, and national codes. Consult your local fire department or building authorities.

**2-6.  
ELECTRICAL  
REQUIREMENTS**

The electric fryer requires 208, 240 or 480 volt, three phase, 50/60 Hertz service. The power cord may be already attached to the fryer, or provided at installation. Check the data plate to determine the correct power supply.



**This fryer must be adequately and safely grounded (earthed) or electrical shock could result. Refer to local electrical codes for correct grounding (earthing) procedures or in absence of local codes, with The National Electrical Code, ANSI/NFPA No. 70-(the current edition). In Canada, all electrical connections are to be made in accordance with CSA C22.1, Canadian Electrical Code Part 1, and/or local codes. To avoid electrical shock, this appliance must be equipped with an external circuit breaker which will disconnect all ungrounded (unearthed) conductors. The main power switch on this appliance does not disconnect all line conductors**

A separate disconnect switch meeting overvoltage category III conditions with proper capacity fuses or breakers must be installed at a convenient location between the fryer and the power source. It should be an insulated copper conductor rated for 600 volts and 90°C. For runs longer than 50 feet (15.24 m), use the next larger wire size.

**2-7.  
INTERNATIONAL  
ELECTRICAL  
REQUIREMENTS**

Units being used outside the United States may not be shipped with the power cord attached to the unit because of the different wiring codes. The fryers are available from the factory wired for 200, 240, 380 and 415 volts, 3 phase, 50 Hertz service. A terminal block is mounted inside the fryer for the cable wiring.

**NOTICE**

- CE units require a minimum wire size of 4mm to be wired to the terminal block. If a flexible power cord is used, it must be HO7RN type.
- The supply power cords shall be oil-resistant, sheathed flexible cable, no lighter than ordinary polychloroprene or other equivalent synthetic elastomer-sheathed cord.
- It is recommended that a 30 mA rated protective device such as a residual current circuit breaker (RCCB), or ground fault circuit interrupter (GFCI), be used on the fryer circuit.



**(FOR EQUIPMENT WITH CE MARK ONLY!) To prevent electric shock hazard this appliance must be bonded to other appliances or touchable metal surfaces in close proximity to this appliance with an equipotential bonding conductor. This appliance is equipped with an equipotential lug for this purpose. The equipotential lug is marked**



## **BOIL-OVER PREVENTION IN HENNY PENNY FRYER**



**FAILURE TO FOLLOW THESE INSTRUCTIONS CAN RESULT IN OIL OVERFLOWING THE FRYPOT WHICH COULD CAUSE SERIOUS BURNS, PERSONAL INJURY, FIRE AND/OR PROPERTY DAMAGE.**

- **THE OIL MAY BE STIRRED ONLY DURING THE MORNING START UP PROCEDURE. DO NOT STIR THE OIL AT ANY OTHER TIME.**
- **BRUSH ALL CRACKLINGS FROM FRYPOT SURFACES DURING THE POT CLEAN OUT PROCESS.**
- **MAKE SURE THE FRYER IS LEVEL.**
- **BE CERTAIN THE OIL IS NEVER ABOVE THE UPPER FRYPOT “FILL” LINE.**
- **BE CERTAIN THAT THE GAS CONTROL VALVE AND BURNERS ARE PROPERLY ADJUSTED. (GAS UNITS ONLY)**
- **USE RECOMMENDED PRODUCT LOAD SIZE (MAXIMUM 24 LB).**

**FOR ASSISTANCE CALL THE HENNY PENNY SERVICE DEPARTMENT AT  
1-800-417-8405.  
OR  
1-937-456-8405**



## SECTION 3: OPERATION

### 3-1. OPERATING COMPONENTS

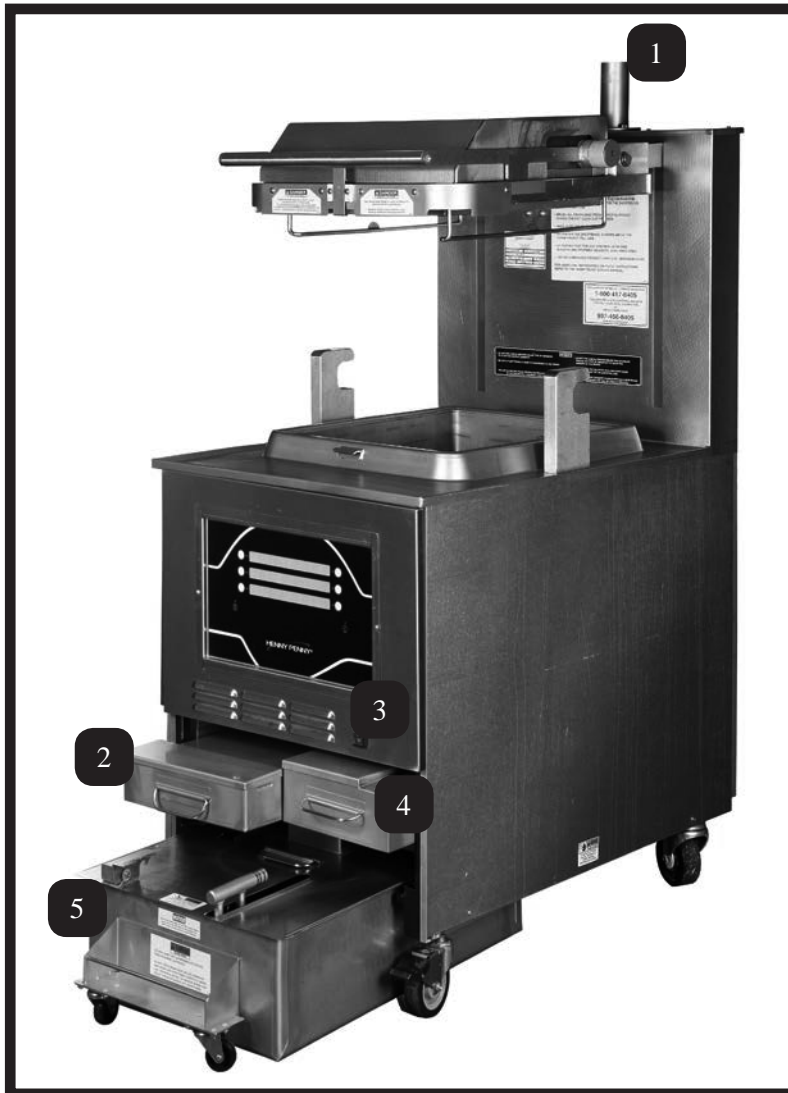

Item No.	Description	Function
1	Steam-Stack	Houses the dead-weight. Releases steam when pressurized
2	Fresh Oil Tank	Tops the pot off with fresh oil when low
3	Power Switch	Turns power to the unit ON/ OFF
4	Condensation Pan	Reservoir that hold excess condensation that drains from the pot
5	Oil Drain Pan	Oil is drained into this pan and then is pumped through filters to help prolong the use of the oil

**3-2.  
CONTROL  
OVERVIEW**

This section gives a control board overview and explains all the buttons, displays and features.



Figure 3-1

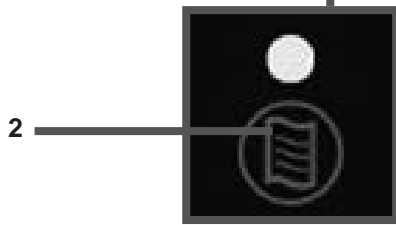

Figure 3-2

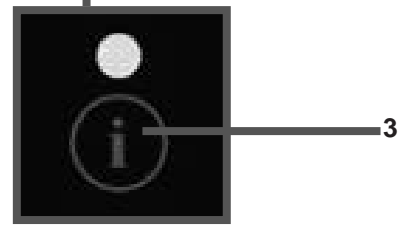

Figure 3-3

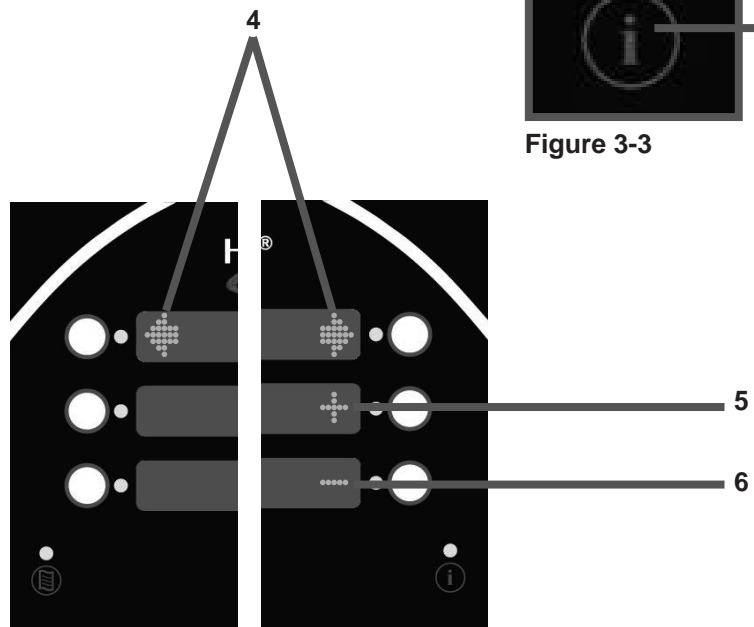

Figure 3-4

**3-2.  
CONTROL  
OVERVIEW  
(CONT.)**

Fig.	Item No.	Description	Function
3-1	1	Buttons	When the light is illuminated next to the button, this indicates this button has a product or action that can be reached by pressing.
3-2	2	Menu Button	Pressing and holding this button will access the “MAIN” menu which includes features such as filter, info mode, and programming.
3-3	3	Info Button	<ul style="list-style-type: none"> <li>• Press this button once to display the pressure and temperature</li> <li>• Press this button twice to activate the “WIPE” feature</li> <li>• Press this button three times to get “LAST FILTER” information</li> </ul>
3-4	4	Arrow Displays	When an arrow is displayed, this indicates there is another screen or option. To access the next option/screen, press the button next to the desired arrow.
3-4	5	Plus Display	<p>The plus sign is displayed when the value of the time/temp/letters can be changed. Pressing the button next to the plus sign will increase the value.</p> <p>Will be represented in the manual by: +</p>
3-4	6	Minus Display	<p>The minus sign is displayed when the value of the time/temp/letters can be changed. Pressing the button next to the minus sign will decrease the value.</p> <p>Will be represented in the manual by: -</p>

### 3-3. DISPLAY OPTIONS

This section describes the three (3) cook display options that this unit is equipped with. The three options are as listed below:

- 4+TITLE
- 5+NEXT
- 6 ITEMS

To change the display option, see SPECIAL PROGRAM section.

### 3-4. 4+TITLE OPTION

The 4+TITLE option shows up to four cook items along with the title of the particular menu you are in.

When in a cook menu, the title of the menu will be displayed in the top section.



Pressing the either arrow button will allow you to scroll right or left through each menu option.

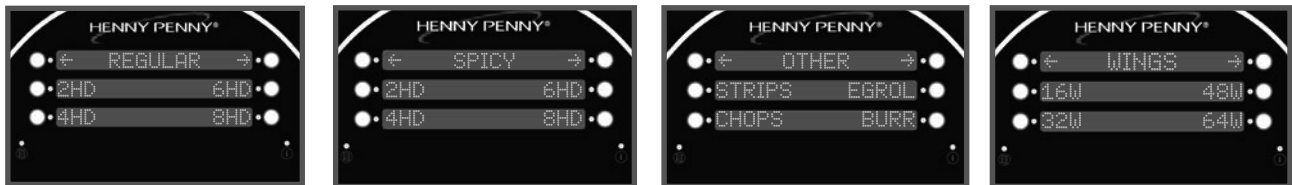

Pressing the button next to the item you want to cook starts the heating process. "DROP>" will be displayed when unit is ready to cook the selected item.

**3-5.  
5+NEXT OPTION**



The 5+NEXT option shows up to five cook items, along with a button that steps to the next cook menu.

All the cook options are displayed on the screen with the bottom-right reading “next>”. Pressing the button next to “next>” will access the next set of cook options.

**3-6.  
6 ITEMS OPTION**



The 6 ITEM option lets the user control all six items on the cook menu. If there is more than one cook menu, the user must program navigation links to other menus.

If there are more than 6 products that will be cooked, and this option is selected, one of the buttons must be designated as a link to a sub-menu, or those options will not be accessible in this option.

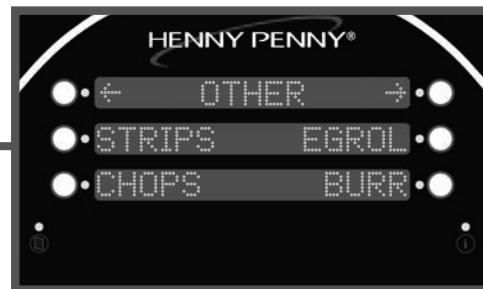

See the programming section for information on setting up menus.

**3-7.  
DRAIN PAN  
ASSEMBLY**

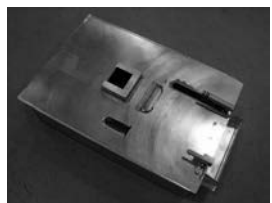
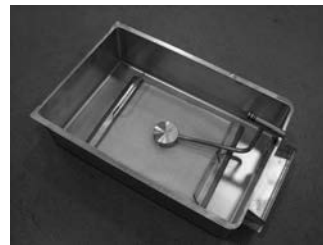
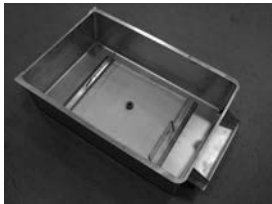
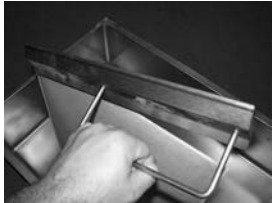
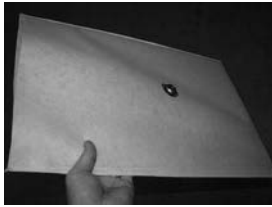

1. Slide a filter envelope onto the filter screen so the plug is protruding through the hole.

**NOTICE**

During assembly, be sure to apply oil to all O-rings to lubricate to help prevent tears and loss.

2. Slide the two handle clamps onto the ends of the filter screen assembly with the handles facing the same direction of the plug.
3. Place the filter screen into the bottom of the drain pan with the plug side up.
4. Lining up the hole of the pickup tube with the plug of the filter screen, press the tube down.
5. Position the pick up tube so that the guides slide into the notches located on the holder in the front of the drain pan. Press down on the pick up tube to confirm it is fully engaged on the filter screen plug and in the holder.

6. Place the crumb catcher into the drain pan so the legs straddle the filter screen.
7. Place lid onto drain pan.
8. Push the drain pan into place and lock it into place using the locking latch.
9. To remove the drain pan for cleaning, reverse this procedure.

3-8.  
**PRODUCT RACKING  
RECOMMENDATIONS**

The bottom position is to be avoided on small loads because it is closer to the cold zone. (The oil is cooler at the bottom of the frypot and hotter at the top.) With bigger loads, however, there is generally enough turbulence in the oil that the bottom rack gets sufficient heat.

The top position is to be avoided on small loads because of insufficient oil coverage. With bigger loads, the top rack has good oil coverage because the volume of product on the lower racks raises the overall oil level.



**8-Head:** Load all four racks as shown.

**6-Head:** Load only racks 1, 2 and 3.

**4-Head:** Load only racks 2 and 3.

**2-Head:** Load only rack 2.

**3-9.  
LID OPERATION**



- **LID MUST BE FULLY LATCHED PRIOR TO STARTING COOK CYCLE OR PRESSURIZED OIL AND STEAM MAY ESCAPE FRYPOT. SEVERE BURNS WILL RESULT.**
- **TO AVOID SERIOUS PERSONAL INJURY, DO NOT OPERATE WITHOUT LID COVER IN PLACE AND ALL COMPONENTS INSTALLED.**
- **TO AVOID SERIOUS PERSONAL INJURY, DO NOT TAMPER WITH ANY COMPONENT OF LID LOCKING MECHANISM.**

**To close lid:**

1. Lower the lid until lid latches into place.
2. Pull lid handle forward until it stops.
3. Lift up on the lid handle until it stops.
4. Bring lid handle out towards you until it stops.
5. Push lid handle down, latching lid in place.



**3-9.  
LID OPERATION  
(CONT.)**



**! DANGER**

**DO NOT LIFT HANDLE OR FORCE LID LATCH OPEN BEFORE THE CONTROL ALARM SOUNDS, AND IS BLINKING “DONE” IN DISPLAY.**

**To open lid:**

1. Gently raise handle until it stops.
2. Push handle back until it stops.

**CAUTION**

*Lower the handle before attempting to raise the lid, or damage to the lid could result.*

3. Lower handle.
4. Push handle back.
5. Unlatch the front lid latch and raise the lid.

**NOTICE**

If lid becomes difficult to operate, stop using the fryer and call for service. Cables need replaced.

## 3-10. START-UP

If the oil is below 180°F (82°C), with the Main Power switch in the ON position, the display will flash “START UP” “AUTO-MELT”. The oil heats slowly to prevent scorching of the oil. The heat cycles on and off to slowly heat the oil. When the oil temperature reaches 215°F (102°C), Auto-Melt mode terminates and the fryer begins heating up to the Auto-Mix temperature of 360°F (182°C).

During Start-up, the display will inform the user by displaying a bar graph to represent the stages of the start-up process. These stages consist of the following:

- **Melt (“Mlt”)**-Auto-Melt mode.
- **Mix (“Mix”)**-Automatic filter to ensure oil is mixed to prevent cold pockets.
- **Top Off (“Top”)**- Checks to see if oil level is filled to the proper mark. If the unit senses the oil level is low, it will run an Auto-Top Off.
- **Polish (“Pol”)**-The unit will run a polish cycle.



During each stage, the bar graph will fill as each stage nears completion. The duration of each stage depends on the temperature of the oil at the initial start and the set-points that the unit has in place.

Once the start-up is complete, the display will go to the main cook menu and is ready for operations.

**3-11.  
FILLING THE OIL  
TANK**



The fresh oil tank automatically tops off the oil in the frypot when it senses the oil level is low. User should add fresh oil to the tank as needed. DO NOT add fresh oil directly to the frypot.

1. Pull the fresh oil tank out of the front of the fryer.
2. Open the fresh oil tank lid and locate the marks on the inside wall of the tank.
3. Use fresh oil, fill the fresh oil tank to the marks on the inside of the tank.
4. Shut the lid and slide back into position.

If the fresh oil tank runs low or is empty, the display will read “FILL OIL TANK” and the left image in the middle display will flash to represent the location of the tank on the fryer.



This prompt will appear when the unit attempts to top off the oil three times and is unsuccessful.

Follow the above steps to fill the tank. Once the tank is filled press the button next to “√OK”.

**3-12.  
CONDENSATION  
TANK**



Excess condensation from the pot drains into the condensation tank. The tank is equipped with a weep hole to indicate the tank is full and needs to be emptied.

To empty, slide the condensation tank completely out of the unit and empty into a drain or sink.

Place back into fryer after emptying.

**3-13.  
FILTER PUMP  
MOTOR  
PROTECTOR-  
MANUAL RESET**

The filter pump motor is equipped with a manual reset button located on the rear of the motor. Wait about 5 minutes before attempting to reset this protective device to allow motor to cool. Remove the condensation pan to reveal the reset button. It takes some effort to reset, and a screwdriver can be used to help reset the button.



To prevent burns caused by splashing oil, turn the unit's main power switch to the OFF position before resetting the filter pump motor's manual reset protection device.

**3-14.  
REGULAR  
MAINTENANCE  
SCHEDULE**

As in all food service equipment, the Henny Penny pressure fryer does require care and proper maintenance. The table below provides a summary of scheduled maintenance. The following paragraphs provide preventive maintenance procedures to be performed by the operator.

<b>Procedure</b>	<b>Frequency</b>
Changing of oil .....	As indicated
Changing the filter envelope .....	Daily
Cleaning the frypot .....	Daily
Cleaning the Nylatrons .....	Monthly-see Preventive Maintenance
Lubricate Carriage Wheels.....	Annually-see Preventive Maintenance
Cleaning the deadweight assy. ....	Monthly-see Preventive Maintenance
Inspect Counter-Weight Cables.....	Annually-see Preventive Maintenance

This unit is equipped with a WIPE mode. This mode gives 10 seconds to wipe the control board clean of any debris without activating the buttons.



1. Press the (i) two times.
2. Press the button next to the √ to confirm.
3. The control board will start a count down timer for 10 seconds.
4. Once the 10 seconds expires, the control will return to the previous screen.

**3-15.  
INITIAL OIL FILL**

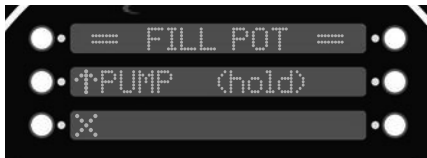

Figure 3-3

**CAUTION**

*The oil level must always be above the heating elements when the fryer is heating and at the frypot level indicators on the rear of the frypot (Figure 3-3). Failure to follow these instructions could result in a fire and/or damage to the fryer.*

Before filling the pot, the oil lines need purged in order to ensure all water or dirty oil is cleared.

1. Access the “FILTER MENU” (see section 3-19 FILTER INSTRUCTIONS).
2. Select “6. FILL FROM OIL TANK”.
3. Push and hold the “FILL” button until fresh oil enters the pot. Release the button.
4. Use a towel to wipe the pot clean of water and dirty oil.
5. It is recommended that a high quality frying oil be used in the pressure fryer. Some low grade oils have a high moisture content and cause foaming and boiling over.

**WARNING  
BURN RISK**

**To avoid severe burns when pouring hot oil into frypot, wear gloves and take care to avoid splashing.**

6. The electric model requires 76 lbs. (34.5 kg.) of oil. The frypot has 2 level indicator lines inscribed on the rear wall of the frypot which show when the heated oil is at the proper level. Figure 3-3.
7. Cold oil should be filled to the lower indicator.

**DANGER  
OVERFLOW RISK**

**BE CERTAIN THE OIL IS NEVER ABOVE THE UPPER LEVEL INDICATOR LINE. FAILURE TO FOLLOW THESE INSTRUCTIONS CAN RESULT IN OIL OVERFLOWING THE FRYPOT CAUSE SERIOUS BURNS, PERSONAL INJURY, FIRE AND/OR PROPERTY DAMAGE.**

**3-16.**  
**BASIC OPERATION**

Follow the procedure below on the initial start-up of the fryer, and each time the fryer is brought from a cold, or shut down condition, back into operation. These are basic, general instructions.

 **DANGER**  
**OVERFLOW RISK**

**DO NOT OVERLOAD, OR PLACE PRODUCT WITH EXTREME MOISTURE CONTENT INTO THE RACKS. 24 LBS. (10.9 KG.) IS THE MAXIMUM AMOUNT OF PRODUCT PER FRYPOT. FAILURE TO FOLLOW THESE INSTRUCTIONS CAN RESULT IN OIL OVERFLOWING THE FRYPOT WHICH COULD CAUSE SERIOUS BURNS, PERSONAL INJURY, FIRE AND/OR PROPERTY DAMAGE.**

1. Make sure the frypot is filled to the proper level with oil, to the lower level indicator.
2. Turn the POWER switch to the ON position
3. Allow fryer to heat until set point.

**NOTICE**

Push the (i) button to see set point and true temperature of oil

**NOTICE**

The heat cycles on and off approximately 10 degrees before the setpoint temperature, to help prevent overshooting the setpoint temperature. (proportional control)

4. Select product button and allow the temperature to reach set point. Once set point has been reached, the display will read "DROP".
5. Before loading product onto the racks, lower racks into the hot oil to keep the product from sticking to the racks.
6. Slide racks of breaded product into carrier on the lid, starting with the bottom tier, to prevent damaged product.
7. Lower and lock the lid down and press the start button.

**3-16.  
BASIC OPERATION  
(CONT.)**

8. At the end of the cycle, pressure begins venting automatically, alarm sounds, and the display shows “DONE”. At this time, press the “DONE” button.
9. Unlock and raise the lid cautiously.
10. Use the rack handles, remove the racks of product from the carrier, starting with the top rack.

**3-17.  
CARE OF THE OIL**



**FOLLOW THE INSTRUCTIONS BELOW TO AVOID OIL OVERFLOWING THE FRYPOT, WHICH COULD RESULT IN SERIOUS BURNS, PERSONAL INJURY, FIRE, AND/OR PROPERTY DAMAGE.**

1. To protect the oil when the fryer is not in immediate use, the fryer should be put into the Cool Mode by selecting a product menu.
2. Frying breaded products requires filtering to keep the oil clean.
3. The proper level of cooking oil is automatically maintained. See Filling the Oil Tank for procedures for filling the fresh oil tank.
4. Do not overload the racks with product (24 lbs. (10.9 kgs.) maximum), or place product with extreme moisture content into racks.

**3-18.  
MAIN MENU**

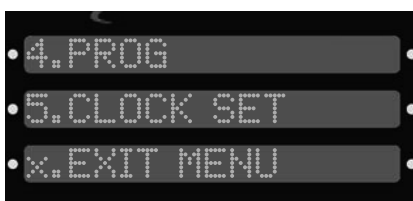

The Main Menu is activated by pressing and holding the Menu button (lower left corner of the control). Once the menu appears, release the button.

The Main Menu options are displayed as follows:

1. FILTER
2. INFO MODE
3. USB/DATA
4. PROGRAM
5. CLOCK SET
- x. EXIT MENU

**3-19.  
FILTERING  
INSTRUCTIONS**



**WITH PROLONGED USE, THE FLASHPOINT OF OIL IS REDUCED. DISCARD OIL IF IT SHOWS SIGNS OF EXCESSIVE SMOKING OR FOAMING. SERIOUS BURNS, PERSONAL INJURY, FIRE, AND/OR PROPERTY DAMAGE COULD RESULT.**

The Henny Penny electric 8 head fryer the fryer automatically performs a polish during morning startup, automatically filters after every cook cycle, and requires a single “Daily” maintenance filter each day; after lunch rush and at the end of the day.

Filter oil immediately following a Cook Cycle when the oil temperature is in the Cool Mode.



*Drain the oil at 250° F (121° C) or less. Higher temperatures cause cracklings to burn on the steel frypot surfaces after the oil has drained.*

1. Push and hold  until the display reads \*MAIN\*.
2. Press 1 to enter the “Filter” menu. Use the buttons next to the arrows on the display to access the next set of options.
3. Push the menu button again to cycle to next set of options.

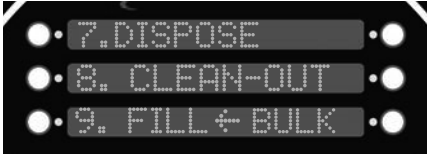
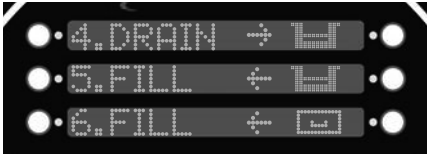

**Filter Options:**

1. QUICK
2. DAILY
3. POLISH
4. DRAIN TO PAN
5. FILL FROM PAN
6. FILL FROM OIL TANK
7. DISPOSE
8. CLEAN-OUT
9. FILL FROM BULK
- x. EXIT MENU



**3-19.  
FILTERING  
INSTRUCTIONS  
(CONT.)**



**Quick Filter**

Option 1 allows you to perform a quick filter of the oil. After every cook cycle, the fryer will automatically run a quick filter. You can choose to do one at any time by selecting this option.

1. Once you have pressed 1 for “QUICK FILTER”, a “CONFIRM” prompt will appear on display. You can cancel by pressing the button next to the X or confirm by pressing the button next to the ✓.
2. Once you have confirmed YES, the drain will open automatically and the oil will start to drain. The display will show arrows pointing down indicating it is draining.

**NOTICE**

During this filter cycle, the oil will not fully drain. It maintains a constant level during filter. The display will show the arrows pointing up and down with a sequence of tracing light to indicate it is still filtering.

3. After a few moments, the drain will close and the oil will return to the pot. As it is close to being filled, the display will make a chirp sound and a timer will start counting down on the lower left hand side. The display will show arrows pointing up to show it is filling.
4. In some circumstances, the fryer might not detect the oil returning to the pot, and may ask “IS Pot FILLED?”.
5. Check the oil level to confirm all oil has returned to pot. If oil is at the correct level mark located in pot, press “YES”. If oil is not at the level marker, press “NO” and pump will continue pumping.

**3-19.  
FILTERING  
INSTRUCTIONS  
(CONT.)**

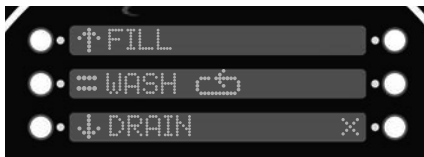

**Daily Filter**

Option 2 allows you to perform a daily filter of the oil. This filter cycle will drain the pot completely enabling the user to clean the pot.

1. Once you have pressed 2 for “DAILY FILTER”, a “CONFIRM” prompt will appear on display. You can cancel by pressing the button next to the X or confirm by pressing the button next to the ✓.
2. Once you have confirmed YES, the drain will open automatically and the oil will start to drain. The display will show arrows pointing down indicating it is draining.
3. As the oil is draining, a brush symbol appears to remind you to scrub the pot. Use a brush, scrub the walls and bottom of pot. .
4. Three prompts will appear on the display. “Fill”, “Wash”, “Drain”.
  - To wash all the crumbs down the drain, select the “WASH” option and unit will start the wash cycle. Display will show “WASHING”. Once completed, display will show previous display with options.
  - You can stop the wash cycle any time by pressing the button next to “STOP”.
5. Once pot is scrubbed and washed, press “FILL” to return the oil to the pot.
6. After a few moments, the drain will close and the oil will return to the pot. As it is close to being filled, the display will make a chirp sound and a timer will start counting down on the lower left hand side. The display will show arrows pointing up to show it is filling.
7. Once the timer has counted down, the display will prompt “IS Pot FILLED?”
8. Check the oil level to confirm all oil has returned to pot. If oil is at the correct level mark located in pot, press “YES”. If oil is not at the level marker, press “NO” and pump will continue pumping.

**3-19.  
FILTERING  
INSTRUCTIONS  
(CONT.)**

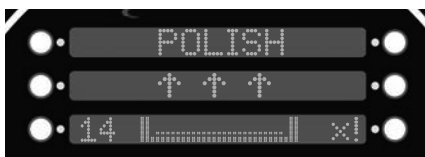
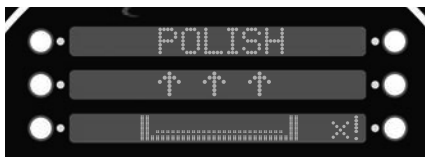
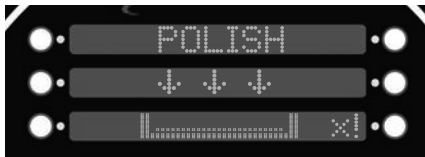
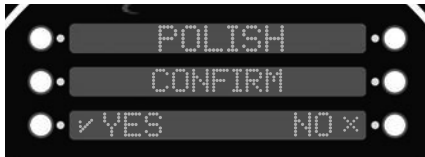

**Polish**

Option 3 allows you to polish oil.

1. Once you have pressed 3 for “POLISH”, a “CONFIRM” prompt will appear on display. You can cancel by pressing the button next to the X or confirm by pressing the button next to the ✓.
2. Once you have confirmed YES, the drain will open automatically and the oil will start to drain. The display will show arrows pointing down indicating it is draining.
3. A timer will start at the bottom left corner of the display for 15:00 minutes. This will cycle the oil until the timer expires.
4. Once polish is complete, the display will indicate the oil is returning to the pot.
5. After a moment, the display will make a chirp sound and a timer will start.
6. Once the timer has counted down, the display will prompt “IS Pot FILLED?”
7. Check the oil level to confirm all oil has returned to pot. If oil is at the correct level mark located in pot, press “YES”. If oil is not at the level marker, press “NO” and pump will continue pumping.

**3-20.**  
**BULK DISPOSE**

Option 7 will access “DISPOSE”. The bulk dispose option allows the oil to be discarded to an external discard tank from the drain pan.

Confirm controls are set to the particular set up in the location. See Special Programming for further detail on set up.

1. Display will read “DRAIN Pot?”. Press the button next to “√” for “YES”. The display will read “DRAINING” while to oil drains to the drain pan.

If at any point “DRAINING” needs to be canceled, pressing the “x!” button will stop draining and give the options to either “Fill”, “RESUME”, or “QUIT”.

“FILL” - Returns what oil has drained back to the pot.

“RESUME” - Continue draining

“QUIT” - Return the “FILTER” menu

2. Next, the display will prompt to “PURGE”. This step is to clear the lines of any old oil.

Press and hold the “PUMP” button on the display while watching the pot. Once clean oil starts to come out of the jets, release the button. Allow a few moments for the old oil to fully drain in to the pan.

3. Press the “NEXT” button once all the old oil has been purged.
4. The display reads “DISPOSE”. Press and release the “PUMP” button. The old oil in the drain pan will now start to dispose.
5. Once the drain pan is empty of old oil, press the “STOP” button to shut off the pump motor.
6. Confirm all oil is cleared from the drain pan. If further pumping is required, press “PUMP” to continue. Then press “STOP” when completed.
7. Press “done” and the display will read “EXIT?”. Press “√YES” when completed.
8. If the fryer’s power switch is on, the display says “TURN OFF UNTIL FILLED”. This display continues until the fryer is turned off.
9. Be sure to refill the fryer with new oil before turning it on again.

**3-21.  
CHANGING THE  
FILTER ENVELOPE**

The filter envelope should be changed daily, or whenever it becomes clogged with crumbs.

Refer back to the Drain Pan Assembly section for instructions.

**⚠ WARNING  
BURN RISK**

Use protective cloth or glove when disconnecting the filter union or severe burns could result. If the filter pan is moved while full of oil, use care to prevent splashing, or severe burns could result.

**NOTICE**

Be sure that the filter screens, crumb catcher and filter clips are thoroughly dry before assembly of the filter envelope or water will dissolve the filter paper.

**3-22.  
CLEAN-OUT MODE**

**CAUTION**

*Do not use steel wool, other abrasive cleaners or cleaners/sanitizer containing chlorine, bromine, iodine or ammonia chemicals, as these will deteriorate the stainless steel material and shorten the life of the unit.*

*Do not use a water jet (pressure sprayer) to clean the unit, or component damage could result.*

*Do not bang brushes or scrapers on the pot band. Damage to the pot band may cause gaps around the gasket and will not build pressure properly.*

**NOTICE**

Make sure the inside of the frypot, the drain valve opening, and all parts that come in contact with the new oil are as dry as possible.

**⚠ DANGER  
BURN RISK**

**DO NOT CLOSE LID WITH WATER AND/OR CLEANER IN FRYPOT. WATER UNDER PRESSURE BECOMES SUPERHEATED. WHEN LID IS OPENED, ESCAPING WATER AND STEAM WILL RESULT IN SEVERE BURNS.**

**3-22.  
CLEAN-OUT MODE  
(CONT.)**

After the initial installation of the fryer, as well as before every change of oil, the frypot should be thoroughly cleaned as follows:

1. Be sure the oil is disposed properly. If the unit has bulk oil, see Bulk Dispose (Section 3-20) for instructions.
2. Turn the POWER switch to OFF position.

**WARNING**

**Moving the fryer or filter drain pan while containing hot oil is not recommended. Hot oil can splash out and severe burns could result. The filter drain pan must be as far back under fryer as it will go, and the cover in place. Be sure the hole in the cover lines up with the drain before opening the drain. Failure to follow these instructions causes splashing of oil and could result in personal injury.**

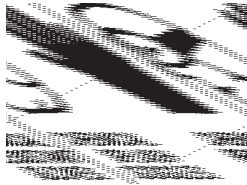

3. Raise lid, remove the racks and carrier from lid, and tilt lid back, so that the lid won't interfere with cleaning.
4. Fill the pot with warm water half way between the bottom and the oil level indicators.
5. Add 8 to 10 ounces of fryer cleaning solution.

**WARNING**

**Always wear chemical splash goggles or face shield and protective rubber gloves when cleaning the frypot as the cleaning solution is highly alkaline. Avoid splashing or other contact of the solution with your eyes or skin. Severe burns and possible blindness will result. Carefully read the instructions on the cleaner. If solution comes in contact with your eyes, rinse thoroughly with cool water and see a physician immediately.**

6. Fill the pot with more warm water so that the water reaches the crumb ring on the side of the pot.
7. Depending on the preferred cleaning method, see the appropriate section below to continue the Clean-Out mode.

Options:

- Cold-Soak Clean Out
- Heated Clean-Out

**Cold-Soak Clean-Out**

If unit is set to Cold-Soak mode (See SP-22 in the Special Program section), follow the following steps.

8. If the unit is not turned off, the control will prompt "TURN FRYER OFF."

**3-22.  
CLEAN-OUT MODE  
(CONT.)**

9. With the fryer off, the display will read, “-OFF-” “(soaking)” with “done√” in the bottom right-hand display.
10. Use a scrub brush to periodically scrub the vat walls to loosen any crumbs or debris.
11. Once the desired time, according to the uses discretion, has expired, press the button next to “done√”.
12. The display will show “DONE SOAKING?” “YES” “NO”. If not done soaking, press “NO” to return to the “OFF” “(soaking)” screen.

If completed with the soaking process, press the button next to “YES” to continue to the CLEAN-OUT: DRAINING THE WATER section.

**Heated Clean-Out**

If unit is set to Heated Clean-Out mode (See SP-22 in the Special Program section), follow the following steps.

8. If the unit is not turned on, the control will prompt “TURN FRYER ON.”
9. Once the unit is powered on, “==CLEAN OUT==” “heating” along with the current temperature of the water will show in the display. The unit starts heating to the preset temperature (see SP-23 in the Special Program section).

**NOTICE**

At any point that Clean-Out mode needs to be canceled, press the button next to the “x!”. This will skip the heating phase and go straight to the CLEAN-OUT: DRAINING THE WATER section.

10. Once the temperature preset is reached, “==CLEAN OUT==” “cleaning” along with the preset time (see SP-24 in the Special Program section). The time will start to count down.
11. When the “cleaning” phase is completed, “\*DONE\*” flashes in the display then prompts to “TURN FRYER OFF”.
12. Power the unit OFF and the display shows “OFF” and the current temperature of the water.

**WARNING  
BURN RISK**

Allow the water time to cool before proceeding to the next steps or burns may result.

Press the button next to “next▶” to proceed to draining the water. See CLEAN-OUT: DRAINING THE WATER section.

**3-22.  
CLEAN-OUT MODE  
(CONT.)**



**Clean-Out: Draining the Water**

The display will read “IS CART OR PAN IN PLACE?”. A bucket, tub or the drain pan needs to be in place under the drain before proceeding to draining.

**NOTICE**

If using the drain pan, remove all the internal parts so the pan is empty. **DO NOT** put the lid onto the pan. Must remain open for this procedure.

When placing the drain pan under the unit, **DO NOT** push it all the way back. Slide it under the unit so that it is under the drain and can still see into the pan.

13. Once a bucket, tub or drain pan is in place, press the button next to “YES√”.
14. The display will show “▼DRAN (hold)”. Press and hold the illuminated button. The water will start to drain into the bucket/tub/pan.
15. Once the level of the water is at a comfortable level, release the button and the water will stop draining.
16. Remove the bucket/tub/pan from under the fryer and dispose.
17. Repeat the following steps until the pot is empty.
18. Once the pot is empty, press the button next to “next▶”.
19. The display will ask “IS POT EMPTY?”. Confirm that all the water is cleared from the pot. Press “√YES” if so,. Otherwise, press “NOx” and continue the draining process.

**Rinse Pot with Clean Water**

20. Place the bucket/tub/pan in place under the drain.
21. The screen will read “▼OPEN DRAIN”. Press the button to fully open the drain.
22. With the drain open, use clean water to rinse the side walls and bottom of the pot.

Be sure not to over fill the receiving container.

23. When completed with rinsing, Press the button next to “▶◀CLOSE DRN” to close the drain.
24. Remove the container from under the fryer and dispose.



**3-22.  
CLEAN-OUT MODE  
(CONT.)**



25. Repeat the following steps as needed to ensure all the cleaner is out of the pot.
26. Once the pot is rinsed clean of all chemical water, press the button next to “next▶”.

**Purge Oil Lines**

This step is to clear the oil lines of any remaining water that may be left over from cleaning or rinsing.

Confirm the Fresh Oil Tank has new oil in it.

27. The display will read “=PURGE=”▶PUMP”.
28. Press and hold the button next to “▶PUMP” until clean, fresh oil comes through the jets in the bottom of the pot.
29. To clear the oil from the pot, refer back to the **Rinse Pot with Clean Water** section.
30. Once pot is rinsed, press the button next to “next▶”.

**Wipe Pot**

31. The display will read “=WIPE=”▼OPEN DRAIN”.
32. Place a bucket, tub, or drain pan under the fryer.
33. Press the button next to “▼OPEN DRAIN” to open the drain.
34. Use a clean towel to wipe the sides and bottom of the pot. Guide all the remaining water and debris down the drain.
35. Press the button next to “▶◀CLOSE DRN” to close the drain.
36. Remove the bucket/tub/pan and discard the contents.
37. Press the button next to “next▶”.

**Exit Confirmation**

38. The display will read “EXIT CLEAN-OUT?”.
39. If the clean-out process is completed, press the button next to “√YES”.
40. If the drain is open, the control will automatically close the drain.
41. The display will read “KEEP OFF UNTIL FILLED”.

**3-22.  
CLEAN-OUT MODE  
(CONT.)**



42. If the power switch is in the ON position, move it to the OFF position to power off the unit.
43. Fill the pot with fresh oil to the lower indicator.
44. Once the pot is filled with fresh oil, the fryer is ready for normal operations.

**3-23.  
PREVENTIVE  
MAINTENANCE**



**Cleaning slides (Nylatrons) - Monthly**

1. Spray Henny Penny biodegradable, food safe, foaming degreaser (part no. 12226) on Nylatrons.
2. Raise lid up and down several times to spread the degreaser.
3. Wipe Nylatrons to remove food soil, grease, and degreaser residue.



**Lubricating Carriage Wheels - Annually**

The carriage wheels, in the back of the fryer, should be lubricated at least once a year, to allow the lid easy movement.

1. Remove the back shroud of the fryer.
2. Use spindle lube, part number 12124, place a small amount of lube on all four (4) wheels, both top and bottom wheels. Make sure to lube both left and right rollers.

**3-23.  
PREVENTIVE  
MAINTENANCE  
(CONT.)**

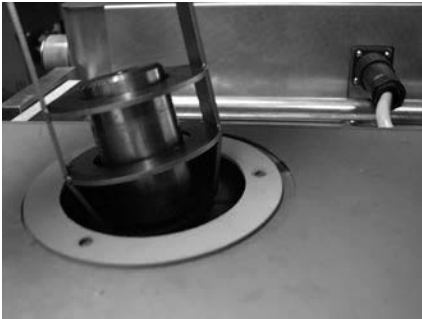

Cleaning DeadWeight-Monthly

**⚠ DANGER  
BURN RISK**

**DO NOT REMOVE DEADWEIGHT ASSEMBLY  
WHILE FRYER IS OPERATING OR SEVERE  
BURNS OR OTHER INJURIES WILL RESULT.**

**⚠ WARNING  
BURN RISK**

**Allow the steam stack enough time to cool before  
proceeding with the following steps.**

1. Loosen the 3 thumb screws that secure the steam stack to the top of the fryer. Do NOT fully remove the screws from the steam stack.
2. Pull the steam stack out of the fryer revealing the deadweight.
3. Use a towel to wipe any build up from the dead-weight.
4. Place the gasket onto the factory location, aligning the 3 screw holes.
5. Place the steam stack back into place and tighten the 3 thumb screws.

**3-23.  
PREVENTIVE  
MAINTENANCE  
(CONT.)**



**Figure 1**

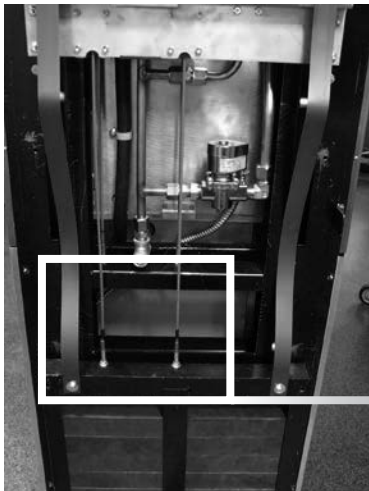

**View of the counter-weights  
with cover removed**



**Inspect Counter-weight Cables-Annually**

Henny Penny 8 head fryers use two cables in the counter-weight mechanism that helps in the raising and lowering of the lid. Cables should be visually inspected yearly, either as part of a planned maintenance program or during a routine service call. Cables more than 10 years old should be replaced regardless of inspection results.

**NOTICE**

If lid becomes difficult to operate, stop using the fryer and call for service. Cables need replaced.

1. Use a 3/8" socket, remove the 6 keps nuts around exterior of rear cover, shown in Figure 1.
2. Lift up on the rear cover and pull out at the bottom to clear threaded studs.
3. Inspect the counter-weight cables. If cables have cracks in the jacket, missing pieces in the jacket, or other obvious signs of wear, call for service to have both cables replaced.

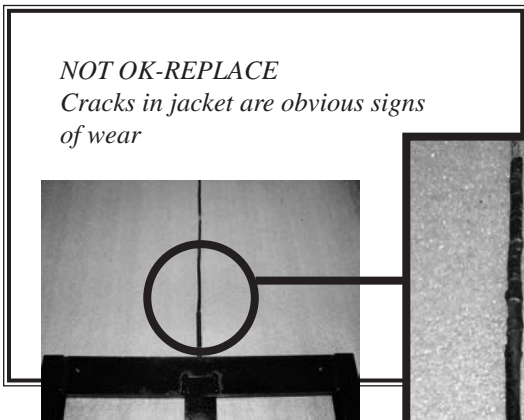

**CAUTION**

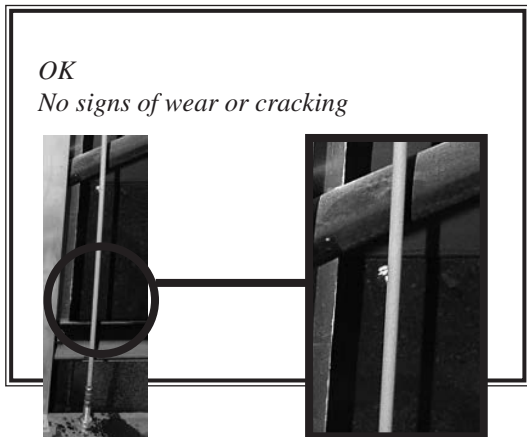

## SECTION 4: PROGRAMMING

### 4-1. PROGRAM MENU



This section shows how to access the programming (“PROG”) menu that access the products, cook and special program.

- |                    |                   |
|--------------------|-------------------|
| 1. PRODUCTS        | 6. FILTER CONTROL |
| 2. COOK MENUS      | 7. TECH MODE      |
| 3. SPECIAL PROGRAM | 8. STATS MODE     |
| 4. DATA COMM       | 9. LANGUAGE       |
| 5. HEAT CONTROL    | x. EXIT MENU      |

### 4-2. PRODUCT PROGRAMMING

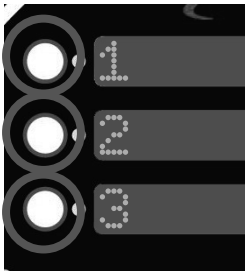

This section describes how to program a new product into an empty slot or over ride a current product.

1. Press and hold the  button until \*MAIN\* shows in the display.
2. Select “4. PROG”.
3. Select “1. PRODUCTS”.
4. Enter code 1,2,3 and the display will show what is the current layout with the products.
5. Select an empty slot or any product that is desired to override by pressing the button next to it. Use the buttons next to the + or - to scroll through the list of products.
6. Once the desired product or /BLANK is in the middle display, pressing the right arrow will advance to the first step in programming that product.
7. Press the button next to “<-change” to proceed to changing the name. The name is what is displayed in the title section of the display.
8. Using the buttons next to the + or - to change the letter in the name. Once the correct letter is displayed, press the button next the arrows to move to the next letter.

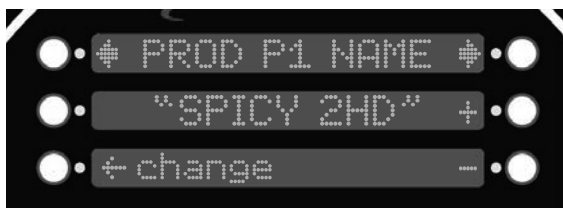
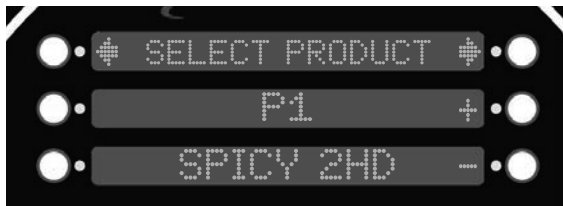

To delete any letters or numbers that may be left over during an override or placed accidentally, press the arrow buttons until you reach the letter or number you desire to delete. Using the + or - buttons, advance the letters until a blank is displayed.

**4-2.  
PRODUCT  
PROGRAMMING  
(CONT.)**

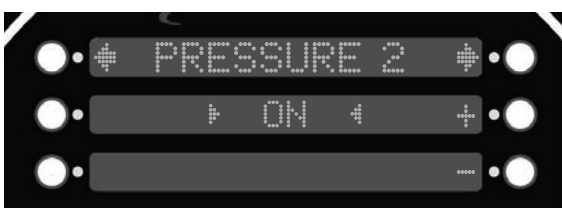

9. Press the button next to the  $\checkmark$  to confirm complete.
10. Press the right-arrow button to advance to "LINK ID". The Link ID is what is displayed in the cook menu. This is used as an abbreviation or short name.

Press the button next to "<-change" to proceed with changing the Link ID.



11. Using the buttons next to the + or - to change the letters. Once complete, press the right-arrow button to advance to the "COOK TIME".
12. Using the buttons next to the left set of + or - to change the minutes in the timer. The right set of + or - are used to change the seconds. Once complete, press the right-arrow button to advance to "TEMP 1".
13. Using the buttons next to the + or - to change the numbers in the temperature. Once complete, press the right-arrow button to advance to "PRESSURE".
14. Using the buttons next to the + or - to change it to either "ON" or "OFF". Press the right arrow to advance to the "STEP 2 AT" options.
15. "STEP 2 AT" will determine at what time the next set or temperature and pressure settings will activate. Use the + or - to change the time then press the right arrow to advance to "TEMP 2".
16. Use the + or - to adjust the temperature then press the right arrow to advance to "PRESSURE 2" to either "ON" or "OFF".
17. Using the + or - buttons to select either "ON" or "OFF". Repeat these steps until complete cook cycle is set. Once the final pressure is set, advance to the next step.
18. Once complete, enter 0:00 in the time and this will automatically be the end of the cook cycle.



**4-3.  
SPECIAL  
PROGRAMMING**

SP-1 • TEMP UNITS  
SP-2 • LANGUAGE  
SP-3 • SYSTEM INIT  
SP-4 • RADIO SYSTEM ENABLED?  
SP-5 • AUDIO VOL (Loudness)  
SP-6 • AUDIO TONE (Frequency)  
SP-7 • MELT CYCLE  
SP-8 • START-UP POLISH ENABLED?  
SP-9 • START-UP GO WHERE?  
SP-10 • COOK MENUS OPTION  
SP-11 • COOK MENU BUTTONS  
SP-12 • COOK DONE GO WHERE?

This section shows how to access the Special Program area of the controls in order to program cook menus, clock, and other features.

1. Push and hold  until the display reads \*MAIN\*.
2. Enter the code: 1, 2, 3
3. Press the  again to access the next set of options.
4. Press 4 to enter the “PROG” menu. Use the buttons next to the arrows on the display to access the next set of options. Special Programming consist of the following:
5. Use the left or right arrows to navigate through the options.

SP-13 • AUTO-MENU MINUTES  
SP-14 • AUTO-MENU GO WHERE?  
SP-15 • COOL TEMP  
SP-16 • PROD PROG T1>T2>T3)?  
SP-17 • BULK DISPOSE?  
SP-18 • BULK SUPPLY?  
SP-19 • COOKING: SHOW PSI?  
SP-20 • CHANGE MGR CODE  
SP-21 • CHANGE USAGE CODE  
SP-22 • CLEAN-OUT TYPE  
SP-23 • CLEAN-OUT TEMP  
SP-24 • CLEAN-OUT MINUTES

**SP-1 • TEMPERATURE DISPLAY UNITS**

1. Use the + or - to change between Fahrenheit (F°) or Celsius (C°).

**SP-2 • OPERATION LANGUAGE**

1. Use the + or - buttons to scroll through the list of languages.

**SP-3 • SYSTEM INITIALIZE**

1. Press and hold the button next to “hold->” for three seconds.
2. System will re-initialize back to default settings.

**SP-5 • AUDIO VOLUME (Loudness)**

1. Use the + or - buttons will adjust the volume of the speaker between 0-10.
2. Press the button next to “test” on the display.

**4-3.  
SPECIAL  
PROGRAMMING  
(CONT.)**

**SP-6 • AUDIO TONE (Frequency)**

1. Press the + or - to adjust the frequency setting,
2. Press the button next to “test” on the display.

**SP-7 • MELT CYCLE**

Specify the desired Melt Mode heating cycle.

1. Use the + or - to select wither “Solid” or “Liquid”.

**SP-8 • START-UP POLISH ENABLED?**

Specify whether or not an automatic polish operation should be performed as part of the normal, morning startup process.

1. Use the + or - to select either “YES” or “NO”.

**SP-9 • START-UP GO WHERE?**

Specify where the control should go after exiting Melt. Choices are “STAY PROD”, “PREV MENU”, or go specifically to any of the ten Cook Menus.

1. Use + or - to navigate through options.

**SP-10 • COOK MENUS (Cook Menu Configuration)**

1. Use the + or - buttons to navigate through cook menu options.
  - “4+TITLE”
  - “5+NEXT”
  - “6 ITEMS”

See *MENU OPTIONS* for descriptions and examples.

**SP-17 • BULK DISPOSE?**

1. Use the + or - buttons to navigate through the three options:
  - “NONE”
  - “FRONT”
  - “REAR”
2. “NONE”- Oil dispose is by draining into a disposal cart or shuttle.
3. “FRONT”- Dispose by pumping through the front hose connection by press and holding the illuminated button.
4. “REAR”- Dispose by pumping through the rear plumbing connection.



**4-3.  
SPECIAL  
PROGRAMMING  
(CONT.)**

**SP-18 • BULK OIL SUPPLY?**

1. Use the + or - buttons to select either “YES” or “NO” for whether or not a bulk oil supply is available for refilling the ATO oil tank and vat with fresh oil.

**SP-22 • CLEAN-OUT TYPE**

This section list the two options for Clean Out Modes

- Cold-Soak
- Heater

1. Use te + or - to change the options.

**SP-23 • CLEAN-OUT TEMP**

NOT AVAILABLE FOR COLD-SOAK OPTION

Set the desired temperature for the water during Clean Out Mode.

1. Use the + or - to change the temperature.

**SP-24 • CLEAN-OUT MINUTES**

NOT AVAILABLE FOR COLD-SOAK OPTION

Set the desired time for the Clean-Out Mode.

1. Use the + or - to change the minutes.

## 4-4. FILTER CONTROL

Filter Control Mode allows the parameters during a filter cycle to be modified for the best results depending on the oil type being used.

Each parameter are grouped into sections that control a particular settings. The section are grouped as follows. See the next page for the full list of Filter Control programs.

- Quick Filter Settings
- Daily Filter Settings
- Polish Settings
- Auto-Top Off Settings
- Start-Up Mode Settings
- Cook Mode Auto Mix Settings
- Miscellaneous Settings

To access Filter Control:

1. Press and hold the  button until \*MAIN\* shows in the display.
2. Select “4. PROG”.
3. Select “6. FLTR CTRL”.
4. Enter code 1,2,3.
5. Use the left or right arrows to navigate through the options.

**4-4.  
FILTER CONTROL  
(CONT.)**

**Quick Filter Settings**

- FC-1 “QUICK FILTER: AFTER ‘X’ COOKS”
- FC-2 “QUICK FILTER: DROP OIL: TIME”
- FC-3 “QUICK FILTER: DROP OIL: DRAIN OPENING”
- FC-4 “QUICK FILTER: FILTER: TIME”
- FC-5 “QUICK FILTER: FILTER: DRAIN OPENING”
- FC-6 “QUICK FILTER: FILL: DETECT AT LEVEL PROBE, KEEP PUMPING”
- FC-7 “QUICK FILTER: NORMAL FILL TIME”
- FC-8 “QUICK FILTER: FILL: NO DETECT: MAX PUMP”

**Daily Filter Settings**

- FC-9 “DAILY FILTER: DROP OIL TIME”
- FC-10 “DAILY FILTER + POLISH: FILL: DETECT AT LEVEL PROBE, KEEP PUMPING”
- FC-11 “DAILY FILTER: FILL: NO DETECT: MAX PUMP”

**Polish Settings**

- FC-12 “POLISH: DROP OIL: TIME”
- FC-13 “POLISH: DROP OIL: DRAIN OPENING”
- FC-14 “POLISH: FILTER: TIME”
- FC-15 “POLISH: FILTER: DRAIN OPENING”
- FC-16 “POLISH: NORMAL FILL TIME”
- FC-17 “POLISH: FILL: NO DETECT: MAX PUMP”

**Auto-Top Off Settings**

- FC-18 “AUTO-TOPOFF: ENABLED?”
- FC-19 “AUTO-TOPOFF: PUMP TIME”
- FC-20 “AUTO-TOPOFF: REPEAT”
- FC-21 “AUTO-TOPOFF: AFTER X ATTEMPTS, CHECK ATO”
- FC-22 “COOK MODE - FORCED ATO CHECK AFTER ‘X’ COOKS”

**Start-Up Mode Settings**

- FC-23 “START-UP: NEEDED IF TEMP < X”
- FC-24 “START-UP MIX: ENABLED?”
- FC-25 “START-UP MIX: PRE-HEAT MAX TEMP”
- FC-26 “START-UP MIX: DROP OIL: TIME”
- FC-27 “START-UP MIX: FILTER: TIME”
- FC-28 “START-UP MIX: NORMAL FILL TIME”
- FC-29 “START-UP MIX: FILL: NO DETECT: MAX PUMP”
- FC-30 “START-UP ATO CHECK: ENABLED?”
- FC-31 “START-UP ATO CHECK: PRE-HEAT MAX TEMP”
- FC-32 “START-UP POLISH: ENABLED?”
- FC-33 “START-UP POLISH: PRE-HEAT MAX TEMP”

**Cook Mode Auto Mix Settings**

- FC-34 “COOK MODE AUTO-MIX: ENABLED?”
- FC-35 “COOK MODE AUTO-MIX: DROP OIL: TIME”
- FC-36 “COOK MODE AUTO-MIX: FILTER: TIME”
- FC-37 “COOK MODE AUTO-MIX: NORMAL FILL TIME”
- FC-38 “COOK MODE AUTO-MIX: FILL: NO DETECT: MAX PUMP”
- FC-39 “COOK MODE AUTO-MIX: DESIRED BOTTOM TEMP”
- FC-40 “COOK MODE AUTO-MIX: MIN REQUIRED OIL TEMP”
- FC-41 “COOK MODE AUTO-MIX: MIN REPEAT”
- FC-42 “COOK MODE TIMED AUTO-MIX, IF BAD BOTTOM PROBE”

**Dispose Settings**

- FC-43 “DISPOSE: DROP OIL: DRAIN OPENING”

**Miscellaneous Settings**

- FC-44 “ALWAYS ASK ‘IS POT FILLED?’”
- FC-45 “ANY FILL: NOT FILLED, EXTRA PUMP TIME”

**4-4.  
FILTER CONTROL  
(CONT.)**

## Quick Filter Settings

These parameters control the Quick Filter operation, which activates automatically after a cook cycle, and may also be initiated manually from the Filter Menu.

The Quick Filter has three basic steps:

1. **DROP:** Opens the drain and drops the oil level by a certain amount. Depending on settings, could drop the oil level just a few inches during this phase, or could drain the entire pot.
2. **FILTER:** Runs the filter pump with the drain partially open for a given time, pumping the oil through the filter paper to clean the oil. This operation typically holds a relatively constant oil level in the pot.
3. **FILL:** Closes the drain fully and runs the filter pump to refill the pot. Watches for a temperature rise on the upper temperature probe (level probe) to indicate that the pot has refilled. Runs the pump a bit longer to get the last of the oil out of the filter pan, then turns the pump off.

### **NOTICE**

The Start-up Mix and the Cook Mode Auto-Mix operations are specialized versions of the Quick Filter, and share some of the Quick Filter programmable parameters. For example, both of the Mix operations use the Quick Filter's "Max Pump Time" setting.

#### **FC-1 "QUICK FILTER: AFTER 'X' COOKS"**

Controls automatic activation of the Quick Filter after the specified number of cook cycles.

1. Enter a new value by using the product numbers.
2. Press the button next to  $\sqrt{\quad}$  to accept the new value.
3. Press the button next to X to return to default or previous setting.

**4-4.  
FILTER CONTROL  
(CONT.)**

**FC-2 “QUICK FILTER: DROP OIL: TIME”**

**FC-3 “QUICK FILTER: DROP OIL: DRAIN  
OPENING”**

For the “Drop” phase: how long to spend dropping the oil level, and how far to open the drain valve during this step.

1. Enter a new value by using the product numbers.
2. Press the button next to √ to accept the new value.
3. Press the button next to X to return to default or previous setting.

**NOTICE**

For very thin (low viscosity) cooking oils, drain opening setting may need to reduce from the default value.

**FC-4 QUICK FILTER: FILTER TIME**

**FC-5 QUICK FILTER: FILTER DRAIN POSITION**

At the end of “Drop” (drop oil level) phase, the drain closes down to a partially open position and the filter pump runs for the specified “Filter Time”.

1. Enter a new value by using the product numbers.
2. Press the button next to √ to accept the new value.
3. Press the button next to X to return to default or previous setting.

**NOTICE**

For very thin (low viscosity) cooking oils, you might need to reduce the drain opening setting from the default value.

**FC-6 QUICK FILTER: FILL--DETECT AT LEVEL  
PROBE, KEEP PUMPING**

When refilling the pot, specifies how long to keep pumping after the oil initially reaches or splashes on the upper probe and the expected temperature rise is observed.

1. Enter a new value by using the product numbers.
2. Press the button next to √ to accept the new value.
3. Press the button next to X to return to default or previous setting.

**4-4.  
FILTER CONTROL  
(CONT.)**

**FC-7 QUICK FILTER: FILL--NO DETECT: MAX PUMP**

The expected time it takes to refill the vat at the end of a Quick Filter.

1. Enter a new value by using the product numbers.
2. Press the button next to  $\sqrt{\phantom{x}}$  to accept the new value.
3. Press the button next to X to return to default or previous setting.

**FC-8 “QUICK FILTER: FILL: NO DETECT: MAX PUMP”**

If the fryer pumps for this amount of time during the Fill phase without observing a temperature rise on the upper temperature probe, the control turns the pump off, and asks “IS POT FILLED?”.

1. Enter a new value by using the product numbers.
2. Press the button next to  $\sqrt{\phantom{x}}$  to accept the new value.
3. Press the button next to X to return to default or previous setting.

**NOTICE**

For 50 Hz systems, or if the control routinely gives up before the pot is refilled, you might need to increase the “max pump” time from the default value. 50 Hz pumps may run more slowly than 60 Hz pumps.

**Daily Filter Settings**

**FC-9 “DAILY FILTER: DROP OIL: TIME”**

Controls the time duration of the initial draining of the pot.

1. Enter a new value by using the product numbers.
2. Press the button next to  $\sqrt{\phantom{x}}$  to accept the new value.
3. Press the button next to X to return to default or previous setting.

**4-4.  
FILTER CONTROL  
(CONT.)**

**FC-10 “DAILY FILTER + POLISH: FILL: DETECT AT LEVEL PROBE, KEEP PUMPING”**

When refilling the pot, specifies how long to keep pumping after the oil reaches the upper probe and the expected temperature rise is observed.

1. Enter a new value by using the product numbers.
2. Press the button next to  $\sqrt{\quad}$  to accept the new value.
3. Press the button next to X to return to default or previous setting.

**NOTICE**

In a Daily Filter, a Fill operation can be stopped by the user at any time.

**FC-11 “DAILY FILTER: FILL: NO DETECT: MAX PUMP”**

If the fryer pumps for this amount of time during the Fill phase without observing a temperature rise on the upper temperature probe, the control turns the pump off, and asks “IS POT FILLED?”. If pot is not filled completely, press “NO” and the pump will attempt to fill further.

1. Enter a new value by using the product numbers.
2. Press the button next to  $\sqrt{\quad}$  to accept the new value.
3. Press the button next to X to return to default or previous setting.

**NOTICE**

For 50 Hz systems, or if the control routinely gives up before the pot is refilled, you might need to increase the “max pump” time from the default value. 50 Hz pumps run more slowly than 60 Hz pumps.

**4-4.  
FILTER CONTROL  
(CONT.)**

## Polish Settings

### **FC-12 “POLISH: DROP OIL: TIME”**

### **FC-13 “POLISH: DROP OIL: DRAIN OPENING”**

For the “Drop” phase: how long to spend dropping the oil level, and how far to open the drain valve during this step.

1. Enter a new value by using the product numbers.
2. Press the button next to  $\checkmark$  to accept the new value.
3. Press the button next to X to return to default or previous setting.

## **NOTICE**

For very thin (low viscosity) cooking oils, you might need to reduce the drain opening setting from the default value.

### **FC-14 “POLISH: FILTER: TIME”**

### **FC-15 “POLISH: FILTER: DRAIN OPENING”**

At the end of the “Drop” (drop oil level) phase, the drain closes down to a partially open position and the filter pump runs for the specified “Filter Time”.

1. Enter a new value by using the product numbers.
2. Press the button next to  $\checkmark$  to accept the new value.
3. Press the button next to X to return to default or previous setting.

## **NOTICE**

For very thin (low viscosity) cooking oils, you might need to reduce the drain opening setting from the default value.

### **FC-16 “POLISH: NORMAL FILL TIME”**

The expected time it takes to refill the vat at the end of a Polish operation. When refilling the vat, if the fryer pumps for one and a half times this expected time, the “Slow Filling” warning is activated, alerting that the fryer is pumping more slowly than expected.

1. Enter a new value by using the product numbers.
2. Press the button next to  $\checkmark$  to accept the new value.
3. Press the button next to X to return to default or previous setting.



**4-4.  
FILTER CONTROL  
(CONT.)**

**FC-17 “POLISH: FILL: NO DETECT: MAX PUMP”**

If the fryer pumps for this amount of time during the Fill phase without observing a temperature rise on the upper temperature probe, the control turns the pump off, and asks “IS POT FILLED?”. If pot is not filled completely, press “NO” and the pump will attempt to fill further.

1. Enter a new value by using the product numbers.
2. Press the button next to  $\checkmark$  to accept the new value.
3. Press the button next to X to return to default or previous setting.

**NOTICE**

For 50 Hz systems, or if the control routinely gives up before the pot is refilled, you might need to increase the “max pump” time from the default value. 50 Hz pumps run more slowly than 60 Hz pumps.

**Auto-Top Off Settings**

**FC-18 “AUTO-TOPOFF: ENABLED?”**

Enables or disables all Auto-Topoff (ATO) operations.

1. Press the + or - to select either “YES” or “NO”.

Disabling the Auto-Topoff feature would normally be done only if the tophoff system itself has failed, in order to avoid the “Fill Oil Tank” messages that occur if the fryer doesn’t detect oil at the proper level after 3 attempts.

**FC-19 “AUTO-TOPOFF: PUMP TIME”**

Specifies how long the ATO pump runs for each individual ATO pulse.

1. Enter a new value by using the product numbers.
2. Press the button next to  $\checkmark$  to accept the new value.
3. Press the button next to X to return to default or previous setting.

This setting may be manually adjusted as needed. Ideally, each ATO pulse pumps about 1/8” to 3/16” (5 mm) of fresh oil into the pot.

**4-4.  
FILTER CONTROL  
(CONT.)**

**FC-20 “AUTO-TOPOFF: REPEAT”**

Specifies how long the control waits before assessing the oil level and generating a second ATO pulse if the oil level is still low.

1. Enter a new value by using the product numbers.
2. Press the button next to  $\checkmark$  to accept the new value.
3. Press the button next to X to return to default or previous setting.

**FC-21 “AUTO-TOPOFF: AFTER X ATTEMPTS, CHECK ATO”**

After each ATO pulse, the control monitors the level probe temperature to see if the oil has been brought up to the proper level. If not, a second ATO pulse is given. After a certain number of pulses, as specified by this setting, if the oil level still has not been brought up to the proper level, the control beeps and displays “FILL OIL TANK”.

1. Enter a new value by using the product numbers.
2. Press the button next to  $\checkmark$  to accept the new value.
3. Press the button next to X to return to default or previous setting.

**NOTICE**

If “X” pulses of oil haven’t brought the level up, the control assumes that the oil tank is empty -- that no oil is being pumped into the pot -- and displays the “Fill Oil Tank” message.

If the fryer is configured to use a Bulk Oil Supply system, the message displayed is “CHECK BULK OIL SUPPLY” rather than “FILL OIL TANK”. In this case, it is possible that the remote bulk supply tank is empty, that the bulk supply plumbing connection is not connected to the fryer, or that the bulk supply electrical connection is not connected.

**FC-22 “COOK MODE - FORCED ATO CHECK AFTER ‘X’ COOKS”**

1. Enter a new value by using the product numbers.
2. Press the button next to  $\checkmark$  to accept the new value.
3. Press the button next to X to return to default or previous setting.

**4-4.  
FILTER CONTROL  
(CONT.)**

## Start-Up Mode Settings

### **FC-23 “START-UP: NEEDED IF TEMP < X”**

If the oil temperature is below 215°F when the fryer is turned on, the fryer always executes a Melt Mode -- regardless of this “Start-up Needed” setting. Melt Mode is important in assuring gentle heating of the oil when it is thick and perhaps not yet flowing well.

1. Enter a new value by using the product numbers.
2. Press the button next to  $\checkmark$  to accept the new value.
3. Press the button next to X to return to default or previous setting.

### **FC-24 “START-UP MIX: ENABLED?”**

Phase 2 of the morning startup procedure is to execute the Start-up Mix operation: drop all of the oil into the drain pan, filter it for a short time, and pump it back into the vat. This feature is important in thermally mixing the oil to eliminate cold spots and eliminate the milky oil in the bottom of the pot.

This setting controls whether or not the Mix operation is performed automatically as part of morning start-up. It is recommended that the Start-up Mix feature is always enabled.

1. Press the + or - to select either “YES” or “NO”.

### **FC-25 “START-UP MIX: PRE-HEAT MAX TEMP”**

The Start-Up Mix procedure consists of two steps:

- Heat up the oil to the Mix Preheat temperature.
- Drop the oil, filter, and refill the pot.

1. Enter a new value by using the product numbers.
2. Press the button next to  $\checkmark$  to accept the new value.
3. Press the button next to X to return to default or previous setting.

**4-4.  
FILTER CONTROL  
(CONT.)**

**FC-26 “START-UP MIX: DROP OIL: TIME”**

This setting specifies how long the oil should drain during the “Drop” phase of the Start-up Mix.

1. Enter a new value by using the product numbers.
2. Press the button next to  $\checkmark$  to accept the new value.
3. Press the button next to X to return to default or previous setting.

**FC-27 “START-UP MIX: FILTER: TIME”**

This setting specifies how long the oil should circulated during the “Filter” phase of the Start-up Mix,

1. Enter a new value by using the product numbers.
2. Press the button next to  $\checkmark$  to accept the new value.
3. Press the button next to X to return to default or previous setting.

**FC-28 “START-UP MIX: NORMAL FILL TIME”**

The expected time it takes to refill the vat at the end of a Start-up Mix operation.

1. Enter a new value by using the product numbers.
2. Press the button next to  $\checkmark$  to accept the new value.
3. Press the button next to X to return to default or previous setting.

**FC-29 “START-UP MIX: FILL: NO DETECT: MAX PUMP”**

If the fryer pumps for this amount of time during the Fill phase without observing a temperature rise on the upper temperature probe, the control turns the pump off, and asks “IS POT FILLED?”. If pot is not filled completely, press “NO” and the pump will attempt to fill further.

1. Enter a new value by using the product numbers.
2. Press the button next to  $\checkmark$  to accept the new value.
3. Press the button next to X to return to default or previous setting.

**4-4.  
FILTER CONTROL  
(CONT.)**

**FC-30 “START-UP ATO CHECK: ENABLED?”**

Specifies whether or not the ATO (auto-topoff) Check -- the third step of the Start-up Mode -- is enabled.

1. Press the + or - to select either “YES” or “NO”.

**FC-31 “START-UP ATO CHECK: PRE-HEAT MAX TEMP”**

The Start-Up Auto-Polish procedure consists of two steps:

- Heat up the oil to the Polish Preheat temperature.
  - Drop the oil, filter (for a long time), and refill the pot.
1. Enter a new value by using the product numbers.
  2. Press the button next to  $\sqrt{\quad}$  to accept the new value.
  3. Press the button next to X to return to default or previous setting.

**FC-32 “START-UP POLISH: ENABLED?”**

Phase 4 of the morning startup procedure is to execute the Start-up Auto-Polish: drop the oil into the drain pan, filter it for a long time, and pump it back into the pot. This feature is important in cleaning the oil and restoring clarity to it. Filter powder should be added to the drain pan in order for the Polish operation to be most effective.

1. Press the + or - to select either “YES” or “NO”.

**FC-33 “START-UP POLISH: PRE-HEAT MAX TEMP”**

The Start-Up Auto-Polish procedure consists of two steps:

- Heat up the oil to the Polish Preheat temperature.
  - Drop the oil, filter (for a long time), and refill the pot.
1. Enter a new value by using the product numbers.
  2. Press the button next to  $\sqrt{\quad}$  to accept the new value.
  3. Press the button next to X to return to default or previous setting.

**4-4.  
FILTER CONTROL  
(CONT.)**

## Cook Mode Auto Mix Settings

### **FC-34 “COOK MODE AUTO-MIX: ENABLED?”**

This setting determines whether or not the Cook Mode Auto-Mix feature is enabled.

1. Press the + or - to select either “YES” or “NO”.

### **FC-35 “COOK MODE AUTO-MIX: DROP OIL: TIME”**

This setting specifies how long the oil should drain during the “Drop Oil” phase of the Cook Mode Auto-Mix.

1. Enter a new value by using the product numbers.
2. Press the button next to  $\checkmark$  to accept the new value.
3. Press the button next to X to return to default or previous setting.

### **FC-36 “COOK MODE AUTO-MIX: FILTER: TIME”**

The Cook Mode Auto-Mix is a modified Quick Filter operation. It consists of three phases: Drop (drop the oil level), Filter (circulate it through the filter paper), and Fill (pump the oil back into the pot).

1. Enter a new value by using the product numbers.
2. Press the button next to  $\checkmark$  to accept the new value.
3. Press the button next to X to return to default or previous setting.

### **FC-37 “COOK MODE AUTO-MIX: NORMAL FILL TIME”**

The expected time it takes to refill the vat at the end of an auto-mix operation.

1. Enter a new value by using the product numbers.
2. Press the button next to  $\checkmark$  to accept the new value.
3. Press the button next to X to return to default or previous setting.

**4-4.  
FILTER CONTROL  
(CONT.)**

**FC-38 “COOK MODE AUTO-MIX: FILL: NO  
DETECT: MAX PUMP”**

If the fryer pumps for this amount of time during the Fill phase without observing a temperature rise on the upper temperature probe, the control turns the pump off, and asks “IS POT FILLED?”. If pot is not filled completely, press “NO” and the pump will attempt to fill further.

1. Enter a new value by using the product numbers.
2. Press the button next to  $\checkmark$  to accept the new value.
3. Press the button next to X to return to default or previous setting.

**FC-39 “COOK MODE AUTO-MIX: DESIRED  
BOTTOM TEMP”**

The purpose of the Cook Mode Auto-Mix operation is to attempt to keep the bottom of the pot hot enough that crumbs don't stick.

1. Enter a new value by using the product numbers.
2. Press the button next to  $\checkmark$  to accept the new value.
3. Press the button next to X to return to default or previous setting.

**FC-40 “COOK MODE AUTO-MIX: MIN REQUIRED  
OIL TEMP”**

This is the minimum oil temperature required in order to activate an Auto-Mix operation.

1. Enter a new value by using the product numbers.
2. Press the button next to  $\checkmark$  to accept the new value.
3. Press the button next to X to return to default or previous setting.

**FC-41 “COOK MODE AUTO-MIX: MIN REPEAT”**

This setting controls how often a bottom-temperature triggered Auto-Mix can repeat.

1. Enter a new value by using the product numbers.
2. Press the button next to  $\checkmark$  to accept the new value.
3. Press the button next to X to return to default or previous setting.

**4-4.  
FILTER CONTROL  
(CONT.)**

**FC-42 “COOK MODE TIMED AUTO-MIX, IF BAD BOTTOM PROBE”**

This option is used only if the temperature probe on the bottom of the pot has failed or is disconnected.

1. Enter a new value by using the product numbers.
2. Press the button next to  $\sqrt{\quad}$  to accept the new value.
3. Press the button next to X to return to default or previous setting.

**Dispose Settings**

**FC-43 “DISPOSE: DROP OIL: DRAIN OPENING”**

This setting specifies the drain opening to be used when draining the oil to a disposal cart, shuttle, or bucket for disposal. (Does not apply to Bulk Dispose operations.)

1. Enter a new value by using the product numbers.
2. Press the button next to  $\sqrt{\quad}$  to accept the new value.
3. Press the button next to X to return to default or previous setting.

**Miscellaneous Settings**

**FC-44 “ALWAYS ASK ‘IS POT FILLED?’”**

This option can be engaged to always ask -- at the end of each Quick Filter, Auto-Mix, and Polish operation -- if the pot is filled. Normally, the control asks “Is Pot Filled?” only if it has pumped for a long time attempting to fill the pot, but no temperature rise was observed on the upper temperature probe.

1. Press the + or - to select either “YES” or “NO”.

**FC-45 “ANY FILL: NOT FILLED, EXTRA PUMP TIME”**

When refilling the pot at the end of a Quick Filter, Auto-Mix, or Polish operation, the control closes the drain and runs the pump until a suitable temperature rise is observed on the upper temperature probe (the level probe). If no temperature rise is seen after pumping for a reasonable maximum pumping time, the control stops, turns the pump off, and asks “Is Pot Filled?”.

1. Enter a new value by using the product numbers.
2. Press the button next to  $\sqrt{\quad}$  to accept the new value.
3. Press the button next to X to return to default or previous setting.



## SECTION 5: TROUBLESHOOTING

### 5-1. TROUBLESHOOTING GUIDE

<b>PROBLEM</b>	<b>CAUSE</b>	<b>CORRECTION</b>
Power switch on but fryer completely inoperative	<ul style="list-style-type: none"> <li>• Open circuit</li> </ul>	<ul style="list-style-type: none"> <li>• Fryer plugged in</li> <li>• Check breaker or fuse at wall</li> </ul>
Pressure not exhausting at end of Cook Cycle	<ul style="list-style-type: none"> <li>• Solenoid or exhaust line clogged</li> </ul>	<ul style="list-style-type: none"> <li>• Turn off and allow fryer to cool to release the pressure in frypot; have all lines, solenoid and exhaust tank cleaned</li> </ul>
Relief valve vents	<ul style="list-style-type: none"> <li>• Operating pressure too high</li> <li>• Deadweight clogged</li> </ul>	<ul style="list-style-type: none"> <li>• Turn off and allow fryer to cool to release the pressure in frypot; clean deadweight; see Preventive Maintenance Section</li> </ul>
Pressure does not build	<ul style="list-style-type: none"> <li>• Not enough product in frypot</li> <li>• Metal shipping spacer not removed from deadweight assy.</li> <li>• Pressure not programmed</li> <li>• Lid gasket leaking</li> </ul>	<ul style="list-style-type: none"> <li>• Place full capacity product in frypot when Use fresh oil.</li> <li>• Remove shipping spacer; see Unpacking Instructions Section</li> <li>• Check programming</li> <li>• Reverse or replace lid gasket</li> </ul>
Oil not heating	<ul style="list-style-type: none"> <li>• Drain valve open</li> <li>• High temperature limit tripped</li> </ul>	<ul style="list-style-type: none"> <li>• Close drain valve.</li> <li>• Reset high temperature limit; see Operating Components Section</li> </ul>
Foaming or boiling over	<ul style="list-style-type: none"> <li>• See Boil-Over chart on fryer and beginning of Operation Section in this manual</li> </ul>	<ul style="list-style-type: none"> <li>• Follow Boil-Over procedures from chart</li> </ul>
Oil not draining	<ul style="list-style-type: none"> <li>• Drain valve clogged</li> </ul>	<ul style="list-style-type: none"> <li>• Push cleaning rod through open drain valve</li> </ul>
Filter motor won't run	<ul style="list-style-type: none"> <li>• Motor overheated</li> </ul>	<ul style="list-style-type: none"> <li>• Reset motor; see Filter Pump Motor Protector-Manual Reset Section</li> </ul>

### **NOTICE**

More detailed troubleshooting information is available in the Technical Manual, available at [www.hennypenny.com](http://www.hennypenny.com), or 1-800-417-8405 or 1-937-456-8405.

**5-2.  
ERROR CODES**

In the event of a control system failure, the digital display will show an “Error Message”. These messages are coded: “E04”, “E05”, “E06”, “E41”. A constant tone is heard when an error code is displayed, and to silence this tone, press any of the product buttons.

DISPLAY	CAUSE	CORRECTION
“E-4” “CPU TOO HOT”	Control board overheating	Turn switch to OFF position, then turn switch back to ON; if display still shows “E04”, the board is getting too hot; check for signs of overheating behind the control panel; once panel cools down the controls should return to normal; if “E04” persists, replace the control
“E-5” “OIL TOO HOT”	Oil overheating	Turn switch to OFF position, then back to ON; if display shows “E05”, the heating circuits and temperature probe should be checked; once the unit cools down, the controls should return to normal; if “E05” persists, replace the control.
“E-6A” “MAIN TEMP PROBE FAILED” (Open Circuit)	Temperature probe failure	Turn switch to OFF position, then back to ON; if the display shows “E06”, the temperature probe should be checked; once the temperature probe is repaired, or replaced, the controls should return to normal; if “E06” persists, replace the control.
“E-6B” “MAIN TEMP PROBE FAILED” (Shorted)		
“E-10”	High limit tripped (Software prior to version 1.60)	Check the error log to find out the fry pot temperature at the time the high limit tripped. If this temperature was very low, this could be a sign that the fry pot was turned on with low or no oil. If this was the case, fill the pot with oil and reset the high limit. If the trip temperature was several degrees above the oil set point temperature, test for a sticking contactor and replace if faulty. If the high limit tripped at an oil temperature, inspect the high limit thermocouples for carbon build up and clean if necessary. If no carbon found, see high limit troubleshooting.

DISPLAY	CAUSE	CORRECTION
<p>“E-10A” “HIGH LIMIT TRIPPED”</p>	<p>High limit tripped while vat main probe temperature was at or above 300°F.</p>	<p>Check the error log to find out the fry pot temperature at the time the high limit tripped. If this was several degrees above the oil set point temperature, test for a sticking contactor and replace if faulty. If the trip temperature was near the oil set point temperature, inspect the high limit thermocouples for carbon build up and clean if necessary. If no carbon found, see high limit troubleshooting.</p>
<p>“E-10B” “HIGH LIMIT TRIPPED”</p>	<p>High limit tripped while vat main probe temperature was below 300°F.</p>	<p>Check the error log to find out the fry pot temperature at the time the high limit tripped. If this temperature was very low, this could be a sign that the fry pot was turned on with low or no oil. If this was the case, fill the pot with oil and reset the high limit. If the high limit tripped at a higher temperature, inspect the high limit thermocouples for carbon build up and clean if necessary. If no carbon found, see high limit troubleshooting.</p>
<p>“E-10C” “HIGH LIMIT TRIPPED”</p>	<p>High limit tripped while actually cooking (Not simply in cook mode, but actually with cook cycle running).</p>	<p>Check the error log to find out the fry pot temperature at the time the high limit tripped. If this was several degrees above the oil set point temperature, test for a sticking contactor and replace if faulty. If the trip temperature was near the oil set point temperature, inspect the high limit thermocouples for carbon build up and clean if necessary. If no carbon found, see high limit troubleshooting.</p>
<p>“E-10D” “HIGH LIMIT TRIPPED”</p>	<p>High limit tripped less than 5 minutes after fryer was performing an AutoFilter or Quick Filter and the control returned to cook mode on its own after detecting that the oil was pumped up (based on temperature rise on level probe).</p>	<p>Check the error log to find out the fry pot temperature at the time the high limit tripped. If this was several degrees above the oil set point temperature, test for a sticking contactor and replace if faulty. If the trip temperature was near the oil set point temperature, inspect the high limit thermocouples for carbon build up and clean if necessary. If no carbon found, see high limit troubleshooting.</p>

DISPLAY	CAUSE	CORRECTION
<p>“E-10F” “HIGH LIMIT TRIPPED”</p>	<p>High limit tripped while filtering (including AutoFilter, Daily Filter, Polish, Dispose, Drain to Pan, Fill from Pan, etc.).</p>	<p>Check the error log to find out the fry pot temperature at the time the high limit tripped. If this was several degrees above the oil set point temperature, test for a sticking contactor and replace if faulty. If the trip temperature was near the oil set point temperature, inspect the high limit thermocouples for carbon build up and clean if necessary. If no carbon found, see high limit troubleshooting.</p>
<p>“E-10M” “HIGH LIMIT TRIPPED”</p>	<p>High limit tripped while fryer was in Melt Mode.</p>	<p>Check the error log to find out the fry pot temperature at the time the high limit tripped. If this temperature was very low, this could be a sign that the fry pot was turned on with low or no oil. If this was the case, fill the pot with oil and reset the high limit. If the high limit tripped at a higher temperature, inspect the high limit thermocouples for carbon build up and clean if necessary. If no carbon found, see high limit troubleshooting.</p>
<p>“E-10S” “HIGH LIMIT TRIPPED”</p>	<p>High limit tripped while vat was in Start-up Mode (not incl. Melt mode), but not while it was executing one of the filter operations.</p>	<p>Check the error log to find out the fry pot temperature at the time the high limit tripped. If this temperature was very low, this could be a sign that the fry pot was turned on with low or no oil. If this was the case, fill the pot with oil and reset the high limit. If the high limit tripped at a higher temperature, inspect the high limit thermocouples for carbon build up and clean if necessary. If no carbon found, see high limit troubleshooting.</p>
<p>“E-10Y” “HIGH LIMIT TRIPPED”</p>	<p>High limit tripped less than 5 minutes after user responded “YES” to an “Is Pot Filled?” question.</p>	<p>Check the error log to find out the fry pot temperature at the time the high limit tripped. If this temperature was very low, this could be a sign that the fry pot was turned on with low or no oil. If this was the case, fill the pot with oil and reset the high limit. If the high limit tripped at a higher temperature, inspect the high limit thermocouples for carbon build up and clean if necessary. If no carbon found, see high limit troubleshooting.</p>
<p>“E-13”</p>	<p>Pressure transducer failed</p>	<ul style="list-style-type: none"> <li>• Replace pressure transducer</li> </ul>

DISPLAY	CAUSE	CORRECTION
<p>“E-14” “PRESSURE TOO HIGH”</p>	<p>Pressure is too high within the frypot</p>	<ul style="list-style-type: none"> <li>• Check deadweight chamber for any obstruction</li> <li>• Check the steam exhaust passage for obstruction</li> </ul>
<p>“E-15C” “DRAIN VALVE ERROR”</p>	<p>The control energized the drain valve to close it, and waited a reasonable amount of time, but didn’t see the expected feedback signal that would have confirmed that the drain valve was fully closed.</p>	<p>Check the drain valve for obstruction. Carefully remove any obstruction found. If no obstruction, check to make sure both connections to the drain valve are plugged in securely. If connections are secure, operate the drain valve using the drain valve test in tech mode. If no drain valve movement, test to make sure the drain valve is getting 24VDC from control board when testing both directions (open and closed) from connector P9 pins 3&amp;4. If voltage is present and no movement, replace drain valve motor. If no DC voltage, replace control board</p>
<p>“E-15P” “DRAIN VALVE ERROR”</p>	<p>The control energized the drain valve to open it, and waited a reasonable amount of time, but didn’t see the expected feedback signal that would have confirmed that the drain valve was fully open.</p>	<p>Check to make sure both connections to the drain valve are plugged in securely. If connections are secure, operate the drain valve using the drain valve test in tech mode. If no drain valve movement, test to make sure the drain valve is getting 24VDC from control board when testing both directions (open and closed) from connector P9 pins 3&amp;4. If voltage is present and no movement, replace drain valve motor. If no DC voltage, replace control board</p>
<p>“E-18A” “LEVEL SENSOR FAILED” (Open Circuit)</p>	<p>The oil level probe has failed</p>	<ul style="list-style-type: none"> <li>• If circuit is open, check connection</li> <li>• Replace probe</li> </ul>
<p>“E-18B” “LEVEL SENSOR FAILED” (Shorted)</p>		
<p>“E-41P” “-1- LOST”</p>	<p>System data lost. Both the RAM copy and stored copy of the settings have been lost. Settings are reset to default</p>	<ul style="list-style-type: none"> <li>• Replace control board if occurs repeatedly</li> </ul>

<b>DISPLAY</b>	<b>CAUSE</b>	<b>CORRECTION</b>
“E-41S” “SYSTEM DATA LOST”	System data lost. Both the RAM copy and stored copy of the settings have been lost. Settings are reset to default	<ul style="list-style-type: none"> <li>• Replace control board if occurs repeatedly</li> </ul>
“E-46C” “INTERNAL SD MEM ERR”	Issue with microSD chip	<ul style="list-style-type: none"> <li>• Check to ensure chip is not ejected from slot</li> </ul>
“E-46W” “DATA SAVE FAILED”	Unable to communicate and save data to the microSD chip  Corrupt file	<ul style="list-style-type: none"> <li>• Replace control board if occurs repeatedly</li> </ul>
“E-47” “ANALOG SYSTEM OR 12 VOLT FAILED”	Problem reading the A-to-D Analog to Digital converter inputs	<ul style="list-style-type: none"> <li>• Initialize the CPU board</li> <li>• Replace control board</li> </ul>
“E-48” “INPUT SYSTEM ERROR”	Failure of the CPU board	<ul style="list-style-type: none"> <li>• Replace control board</li> </ul>
“E-54C” “MAIN TEMP CIRCUIT FAILURE”	Fault on the CPU board	<ul style="list-style-type: none"> <li>• Initialize the CPU board</li> <li>• Replace control board</li> </ul>
“E-54D” “MAIN TEMP DSC ERROR”	Fault on the CPU board	<ul style="list-style-type: none"> <li>• Initialize the CPU board</li> <li>• Replace control board</li> </ul>
“E-70A” “FAN JUMP MISSING”	Jumper wire is loose or missing from 15 pin connector	<ul style="list-style-type: none"> <li>• Check connector for loose connection</li> </ul>

<b>DISPLAY</b>	<b>CAUSE</b>	<b>CORRECTION</b>
“E-70B” “PWR SWITCH OR WIRES FAILED”	Short in wires/ loose connection  Power switch may be faulty	<ul style="list-style-type: none"> <li>• Check connection</li> <li>• Replace power switch</li> </ul>
“E-70C” “DRN JUMPER MISSING”	Loose connection on the 15 pin connector	Check connection
“E-84”		Should you require outside assistance, call your local distributor in your area, or call 1-800-417-8405 or 1-937-456-8405.
“E-85A” “LID LOCK EXT SWITCH MISSING”		Should you require outside assistance, call your local distributor in your area, or call 1-800-417-8405 or 1-937-456-8405.
“E-85B” “LID LOCK EXT SWITCH STUCK ON”		Should you require outside assistance, call your local distributor in your area, or call 1-800-417-8405 or 1-937-456-8405.
“E-85C” “LID LOCK RET SWITCH STUCK ON”		Should you require outside assistance, call your local distributor in your area, or call 1-800-417-8405 or 1-937-456-8405.
“E-85D” “LID LOCK RET SWITCH STUCK ON”		Should you require outside assistance, call your local distributor in your area, or call 1-800-417-8405 or 1-937-456-8405.
“E-85E” “LID LOCK CABLE ERROR”		Should you require outside assistance, call your local distributor in your area, or call 1-800-417-8405 or 1-937-456-8405.
“E-93” “24V DC SUPPLY”		Should you require outside assistance, call your local distributor in your area, or call 1-800-417-8405 or 1-937-456-8405.



**Henny Penny Corporation  
P.O.Box 60  
Eaton, OH 45320**

**1-937-456-8400  
1-937-456-8402 Fax**

**Toll free in USA  
1-800-417-8417  
1-800-417-8434 Fax**

**[www.hennypenny.com](http://www.hennypenny.com)**