



HOSHIZAKI

Instruction Manual

Cubelet Icemaker/Dispenser

Models

DCM-300BAH(-OS)

DCM-500B_H(-OS)

DCM-751B_H(-OS)



⚠ WARNING

Only qualified service technicians should install and service the appliance. To obtain the name and phone number of your local Hoshizaki Certified Service Representative, visit www.hoshizaki.com. No installation or service should be undertaken until the technician has thoroughly read this Instruction Manual. Likewise, the owner/manager should not proceed to operate the appliance until the installer has instructed them on its proper operation. Failure to install, operate, and maintain the appliance in accordance with this manual will adversely affect safety, performance, component life, and warranty coverage and may result in costly water damage. Proper installation is the responsibility of the installer. Product failure or property damage due to improper installation is not covered under warranty.

Hoshizaki provides this manual primarily to assist qualified service technicians in the installation, maintenance, and service of the appliance.

Should the reader have any questions or concerns which have not been satisfactorily addressed, please call, send an e-mail message, or write to the Hoshizaki Technical Support Department for assistance.

Phone: 1-800-233-1940; (770) 487-2331

Fax: 1-800-843-1056; (770) 487-3360

E-mail: techsupport@hoshizaki.com

HOSHIZAKI AMERICA, INC.

618 Highway 74 South

Peachtree City, GA 30269

Attn: Hoshizaki Technical Support Department

NOTE: To expedite assistance, all correspondence/communication **MUST** include the following information:

- Model Number _____
- Serial Number _____
- Complete and detailed explanation of the problem.

IMPORTANT

This manual should be read carefully before the appliance is installed and operated. Read the warnings and guidelines contained in this manual carefully as they provide essential information for the continued safe use and maintenance of the appliance. Retain this manual for any further reference that may be necessary.

CONTENTS

Important Safety Information	4
I. Specifications.....	6
A. Electrical and Refrigerant Data	6
1. DCM-300BAH(-OS).....	6
2. DCM-500B_H(-OS)	6
3. DCM-751B_H(-OS)	7
B. Dimensions/Connections	8
1. Air-Cooled Models (DCM-300BAH(-OS), DCM-500BAH(-OS)).....	8
2. Air-Cooled Models (DCM-751BAH(-OS)).....	9
3. Water-Cooled Models (DCM-500BWH(-OS)).....	10
4. Water-Cooled Models (DCM-751BWH(-OS)).....	11
II. Installation and Operating Instructions	12
A. Location	12
B. Checks Before Installation.....	13
C. How to Remove Panels.....	14
D. Setup.....	15
E. Electrical Connection	15
F. Water Supply and Drain Connections	16
1. Icemaker	17
2. Water-Cooled Condenser.....	18
G. Final Checklist	20
H. Startup	21
I. Dispense Mode Switch	23
J. Alarm Safeties.....	23
III. Maintenance	24
A. Maintenance Schedule.....	25
B. Cleaning and Sanitizing Instructions.....	26
IV. Preparing the Appliance for Periods of Non-Use	30
V. Disposal	32

Important Safety Information

Throughout this manual, notices appear to bring your attention to situations which could result in death, serious injury, damage to the appliance, or damage to property.

⚠ WARNING Indicates a hazardous situation which could result in death or serious injury.

NOTICE Indicates a situation which could result in damage to the appliance or property.

IMPORTANT Indicates important information about the installation, use, and care of the appliance.

⚠ WARNING

The appliance should be destined only to the use for which it has been expressly conceived. Any other use should be considered improper and therefore dangerous. The manufacturer cannot be held responsible for injury or damage resulting from improper, incorrect, and unreasonable use. Failure to install, operate, and maintain the appliance in accordance with this manual will adversely affect safety, performance, component life, and warranty coverage and may result in costly water damage.

To reduce the risk of death, electric shock, serious injury, or fire, follow basic precautions including the following:

- Only qualified service technicians should install and service the appliance.
- The appliance must be installed in accordance with applicable national, state, and local codes and regulations.
- Electrical connection must be hard-wired and must meet national, state, and local electrical code requirements. Failure to meet these code requirements could result in death, electric shock, serious injury, fire, or damage.
- The appliance requires an independent power supply of proper capacity. See the nameplate for electrical specifications. Failure to use an independent power supply of proper capacity can result in a tripped breaker, blown fuse, damage to existing wiring, or component failure. This could lead to heat generation or fire.
- **THE APPLIANCE MUST BE GROUNDED.** Failure to properly ground the appliance could result in death or serious injury.
- To reduce the risk of electric shock, do not touch the power switch or control switch with damp hands.
- Move the power switch to the "OFF" position and turn off the power supply before servicing. Lockout/Tagout to prevent the power supply from being turned back on inadvertently.
- Do not place fingers or any other objects into the ice discharge opening.
- Do not make any alterations to the appliance. Alterations could result in electric shock, injury, fire, or damage.

⚠ WARNING, continued

- The appliance is not intended for use by persons (including children) with reduced physical, sensory, or mental capabilities, or lack of experience and knowledge, unless they have been given supervision or instruction concerning use of the appliance by a person responsible for their safety.
- Children should be properly supervised around the appliance.
- Do not climb, stand, or hang on the appliance or allow children or animals to do so. Serious injury could occur or the appliance could be damaged.
- Do not use combustible spray or place volatile or flammable substances near the appliance. They might catch fire.
- Keep the area around the appliance clean. Dirt, dust, or insects in the appliance could cause harm to individuals or damage to the appliance.

NOTICE

- Follow the water supply, drain connection, and maintenance instructions carefully to reduce the risk of costly water damage.
- In areas where water damage is a concern, install in a contained area with a floor drain.
- Install the appliance in a location that stays above freezing. Normal operating ambient temperature must be within 45°F to 100°F (7°C to 38°C).
- Do not leave the appliance on during extended periods of non-use, extended absences, or in sub-freezing temperatures. To properly prepare the appliance for these occasions, follow the instructions in "IV. Preparing the Appliance for Periods of Non-Use."
- Do not place objects on top of the appliance.
- The ice storage bin is for ice use only. Do not store anything else in the ice storage bin.

I. Specifications

A. Electrical and Refrigerant Data

The rating label and nameplate provide electrical and refrigerant data. The rating label can be seen by removing the front panel. The nameplate is located on the rear panel. For certification marks, see the nameplate.

We reserve the right to make changes in specifications and design without prior notice.

1. DCM-300BAH(-OS)

Single Phase	
Model Number	DCM-300BAH(-OS)
AC Supply Voltage	115-120/60/1
Compressor	115V 6.0RLA 29.0LRA
Gear Motor	120V 1.45FLA 80W
Fan Motor	115V 0.8FLA 16W
Agitating Motor	115V 0.9FLA 55W
Dispensing Motor	115V 0.9FLA 55W
Other	120V 0.2A
Maximum Fuse Size	20 AMPS
Max. HACR Breaker (USA Only)	20 AMPS
Max. Circuit Breaker (Canada Only)	20 AMPS
Minimum Circuit Ampacity	20 AMPS
Design Pressure	HI-460PSI LO-290PSI
Refrigerant	404A 15.9 OZ.

2. DCM-500B_H(-OS)

Single Phase		
Model Number	DCM-500BAH(-OS)	DCM-500BWH(-OS)
AC Supply Voltage	115-120/60/1	115-120/60/1
Compressor	120V 7.5RLA 54.5LRA	120V 7.5RLA 54.5LRA
Gear Motor	120V 2.4FLA 1/4HP	120V 2.4FLA 1/4HP
Fan Motor	120V 1.0FLA 50W	- - -
Agitating Motor	120V 0.9FLA 55W	120V 0.9FLA 55W
Dispensing Motor	120V 0.9FLA 55W	120V 0.9FLA 55W
Other	120V 0.2A	115V 0.2A
Maximum Fuse Size	20 AMPS	20 AMPS
Max. HACR Breaker (USA Only)	20 AMPS	20 AMPS
Max. Circuit Breaker (Canada Only)	20 AMPS	20 AMPS
Minimum Circuit Ampacity	20 AMPS	20 AMPS
Design Pressure	HI-460PSI LO-290PSI	HI-460PSI LO-290PSI
Refrigerant	404A 1 LB 4.1 OZ.	404A 11.5 OZ.

3. DCM-751B_H(-OS)

Single Phase		
Model Number	DCM-751BAH(-OS)	DCM-751BWH(-OS)
AC Supply Voltage	115-120/60/1	115-120/60/1
Compressor	115V 14.6RLA 77LRA	115V 14.6RLA 77LRA
Gear Motor	120V 3.0FLA 1/4HP	120V 3.0FLA 1/4HP
Fan Motor	120V 1.0FLA 50W	- - -
Agitating Motor	120V 1.8FLA(TOTAL) 110W	120V 1.8FLA(TOTAL) 110W
Dispensing Motor	120V 0.9FLA 55W	120V 0.9FLA 55W
Other	120V 0.6A	120V 0.6A
Maximum Fuse Size	20 AMPS	20 AMPS
Max. HACR Breaker (USA Only)	20 AMPS	20 AMPS
Max. Circuit Breaker (Canada Only)	20 AMPS	20 AMPS
Minimum Circuit Ampacity	20 AMPS	20 AMPS
Design Pressure	HI-460PSI LO-290PSI	HI-460PSI LO-290PSI
Refrigerant	404A 1 LB 10 OZ.	404A 1 LB 6 OZ.

B. Dimensions/Connections

1. Air-Cooled Models (DCM-300BAH(-OS), DCM-500BAH(-OS))

Unit: mm [in.]

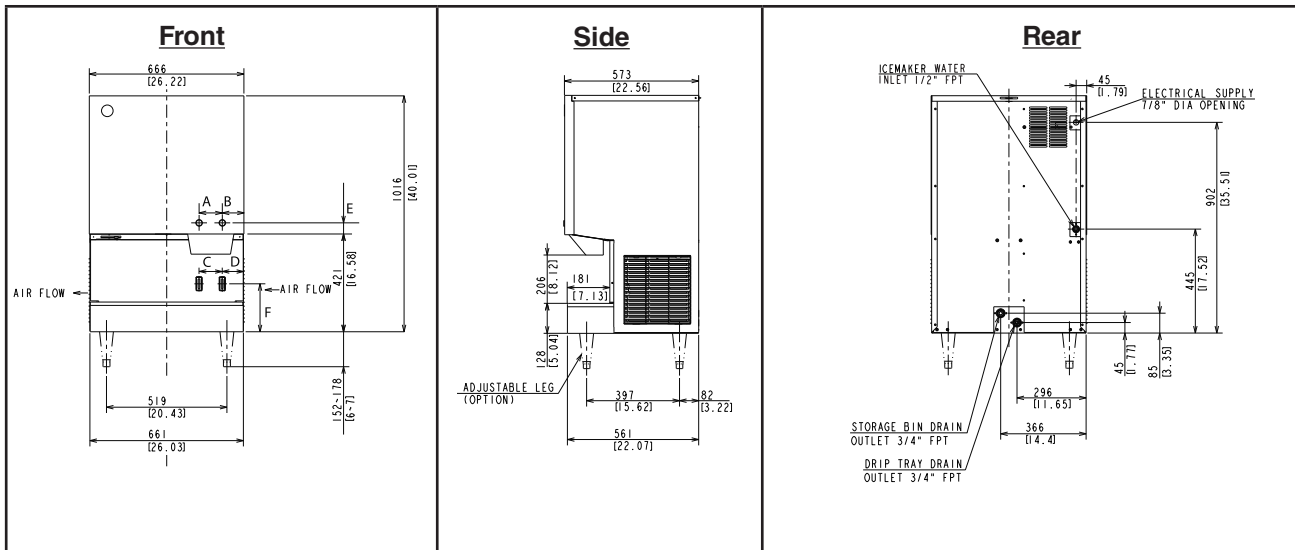

NOTICE

Allow 6" (15 cm) clearance at rear and sides for proper air circulation and ease of maintenance and/or service should they be required. Allow 24" (61 cm) clearance at top to allow for removal of the auger.

	DCM-300BAH DCM-500BAH	DCM-300BAH-OS DCM-500BAH-OS
A	100 [3.94]	NA
B	93 [3.66]	NA
C	NA	100 [3.94]
D	NA	99 [3.90]
E	48 [1.89]	NA
F	NA	207 [8.14]

2. Air-Cooled Models (DCM-751BAH(-OS))

Unit: mm [in.]

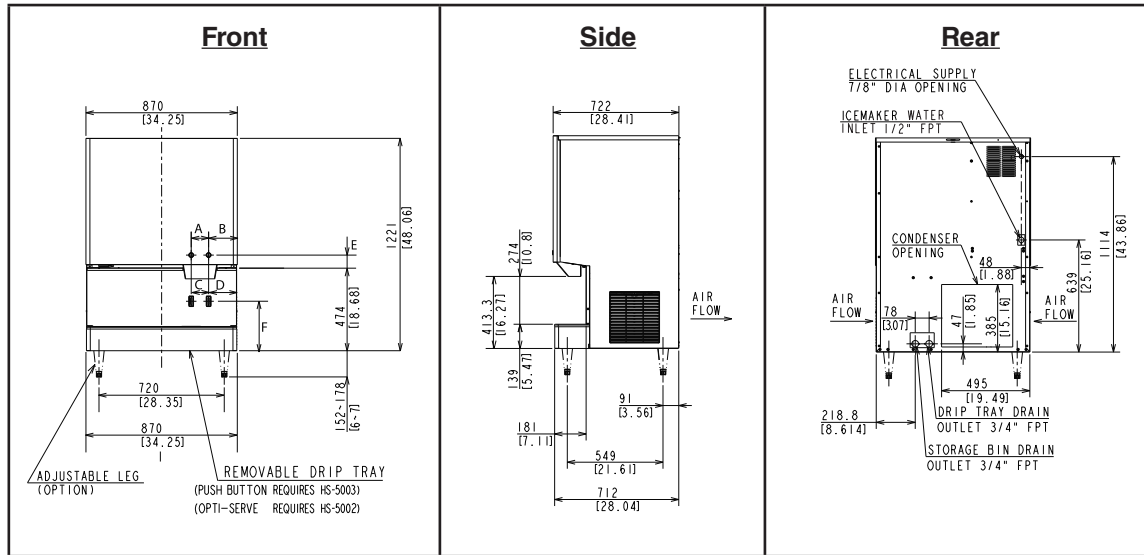

NOTICE

Allow 6" (15 cm) clearance at rear and sides for proper air circulation and ease of maintenance and/or service should they be required. Allow 24" (61 cm) clearance at top to allow for removal of the auger.

	DCM-751BAH	DCM-751BAH-OS
A	100 [3.94]	NA
B	165 [6.5]	NA
C	NA	100 [3.94]
D	NA	165 [6.5]
E	76 [2.99]	NA
F	NA	284 [11.20]

3. Water-Cooled Models (DCM-500BWH(-OS))

Unit: mm [in.]

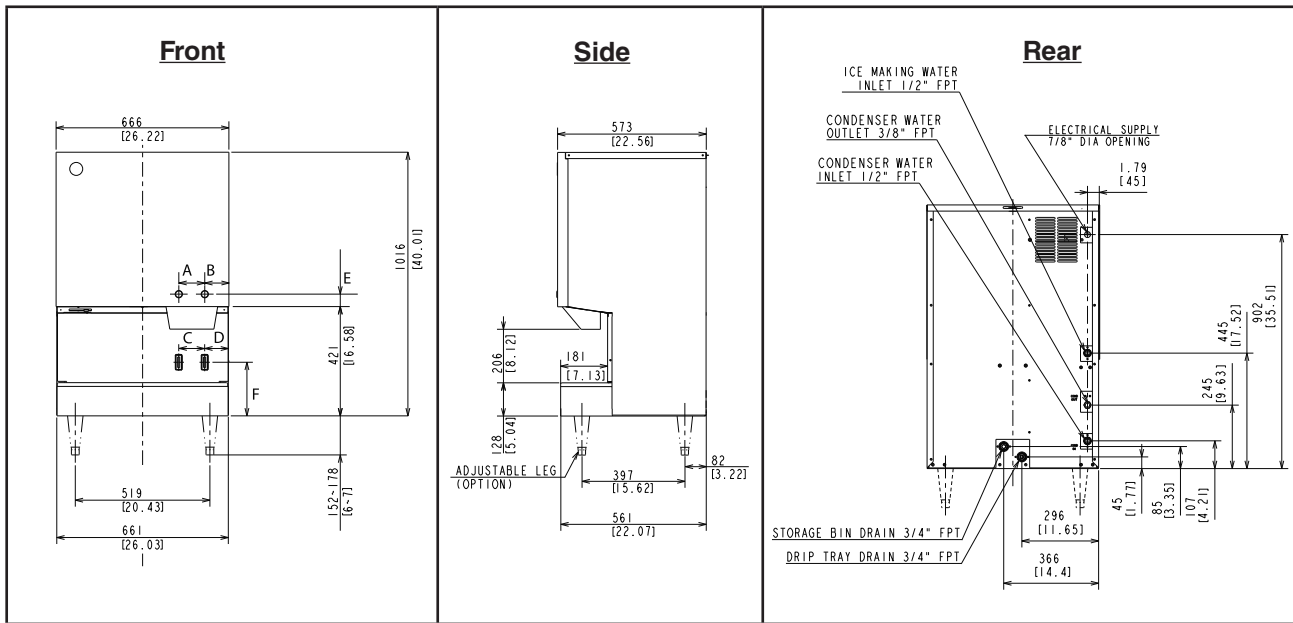

NOTICE

Allow 6" (15 cm) clearance at rear and sides for proper air circulation and ease of maintenance and/or service should they be required. Allow 24" (61 cm) clearance at top to allow for removal of the auger.

	DCM-500BWH	DCM-500BWH-OS
A	100 [3.94]	NA
B	93 [3.66]	NA
C	NA	100 [3.94]
D	NA	99 [3.90]
E	48 [1.89]	NA
F	NA	207 [8.14]

4. Water-Cooled Models (DCM-751BWH(-OS))

Unit: mm [in.]

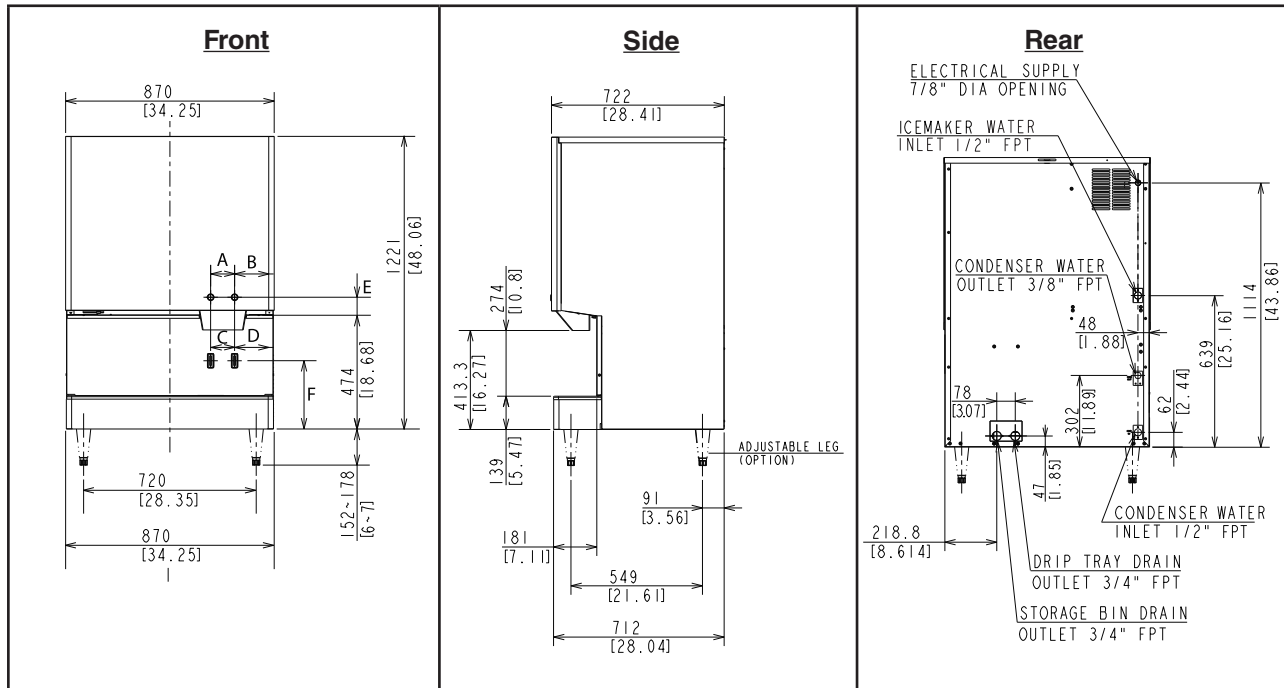

NOTICE

Allow 6" (15 cm) clearance at rear and sides for proper air circulation and ease of maintenance and/or service should they be required. Allow 24" (61 cm) clearance at top to allow for removal of the auger.

	DCM-751BWH	DCM-751BWH-OS
A	100 [3.94]	NA
B	165 [6.5]	NA
C	NA	100 [3.94]
D	NA	165 [6.5]
E	76 [2.99]	NA
F	NA	284 [11.2]

II. Installation and Operating Instructions

⚠ WARNING

- The appliance must be installed in accordance with applicable national, state, and local codes and regulations.
- Failure to install, operate, and maintain the appliance in accordance with this manual will adversely affect safety, performance, component life, and warranty coverage and may result in costly water damage.
- **CHOKING HAZARD:** Ensure all components, fasteners, and thumbscrews are securely in place after installation. Make sure that none have fallen into the ice storage bin.

A. Location

NOTICE

- The appliance is not intended for outdoor use. Normal operating ambient temperature must be within 45°F to 100°F (7°C to 38°C); Normal operating water temperature must be within 45°F to 90°F (7°C to 32°C). Operation of the appliance, for extended periods, outside of these normal temperature ranges may affect appliance performance.
 - The appliance will not work at sub-freezing temperatures. To prevent damage to the water supply line, drain the appliance if the air temperature is going to go below 32°F (0°C). See "IV. Preparing the Appliance for Periods of Non-Use."
 - Opti-Serve Model (-OS): Sunlight, direct and indirect, can have an effect on the operation of the dispense sensors. If a problem is noticed, the appliance should be moved out of direct sunlight and/or farther away from any outside windows.
- The appliance should not be located next to ovens, grills, or other high heat producing equipment.
 - Allow 6" (15 cm) clearance at rear and sides for proper air circulation and ease of maintenance and/or service should they be required. Allow 24" (61 cm) clearance at top to allow for removal of the auger.
 - The location should provide a firm and level foundation for the appliance.

B. Checks Before Installation

- Visually inspect the exterior of the shipping container and immediately report any damage to the carrier. Upon opening the container, any concealed damage should also be immediately reported to the carrier.
- Remove the shipping carton, tape, and packing material. If any are left in the appliance, it will not work properly.
- See the nameplate on the rear panel, and check that your voltage supplied corresponds with the voltage specified on the nameplate.
- Remove the panels to prevent damage when installing the appliance. See "II.C. How to Remove Panels."
- Remove the package containing the accessories.
- Remove the protective plastic film from the panels. If the appliance is exposed to the sun or to heat, remove the film after the appliance cools.
- Check that the refrigerant lines do not rub or touch lines or other surfaces, and that the fan blade (if applicable) turns freely.
- This appliance can be installed on a countertop or on an optional stand. If using an optional stand, see the table below. For further options, contact your local Hoshizaki distributor.

Model Number	SD Stand
DCM-300BAH(-OS)	SD-450/SD-500
DCM-500B_H(-OS)	
DCM-751B_H(-OS)	SD-700/SD-750

- The drip tray on the front of the DCM-751B_H(-OS) is removable for installations using an in-counter drain. Drip tray removal requires HS-5003 for DCM-751 B_H or HS-5002 for DCM-751B_H-OS.

DCM on Hoshizaki Stand
SD-450 or SD-700

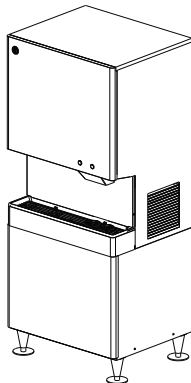

DCM on Hoshizaki Stand
SD-500 or SD-750

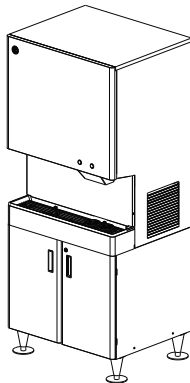

DCM-751B_H with
Drip Tray Removal Kit
HS-5003

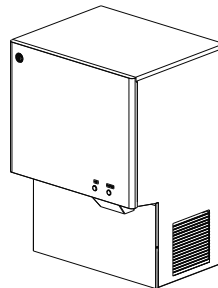

DCM-751B_H-OS with
Drip Tray Removal Kit
HS-5002

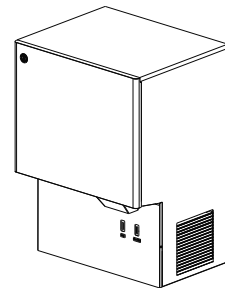

C. How to Remove Panels

See Fig. 1

- Front Panel: Remove the screw. Lift up and towards you. Disconnect the connector on push-button models.
- Top Panel: Lift up at front slightly, push rearward and lift off.
- Apron Panel: Remove the screws and pull towards you. Disconnect the connectors on optical-sensor models.
- Side Panel: Remove the screws and pull towards you.
- Ice Storage Bin Cover: Remove the thumbscrews and pull towards you.

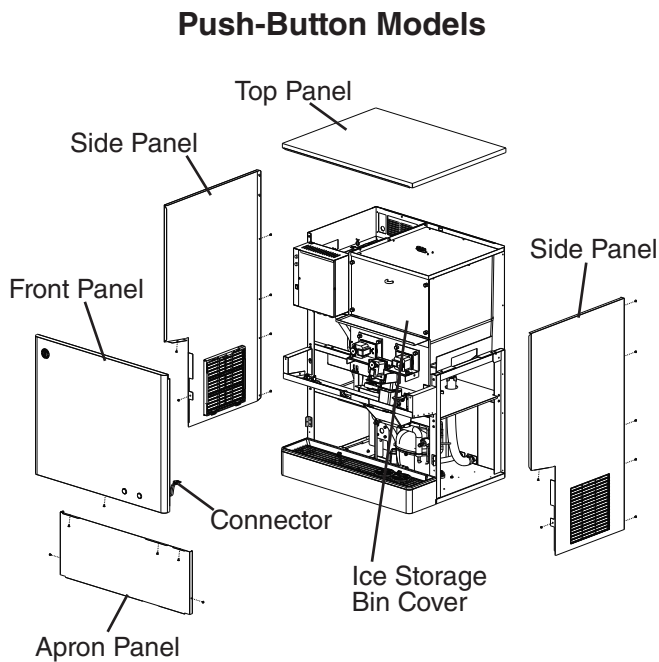

Fig. 1

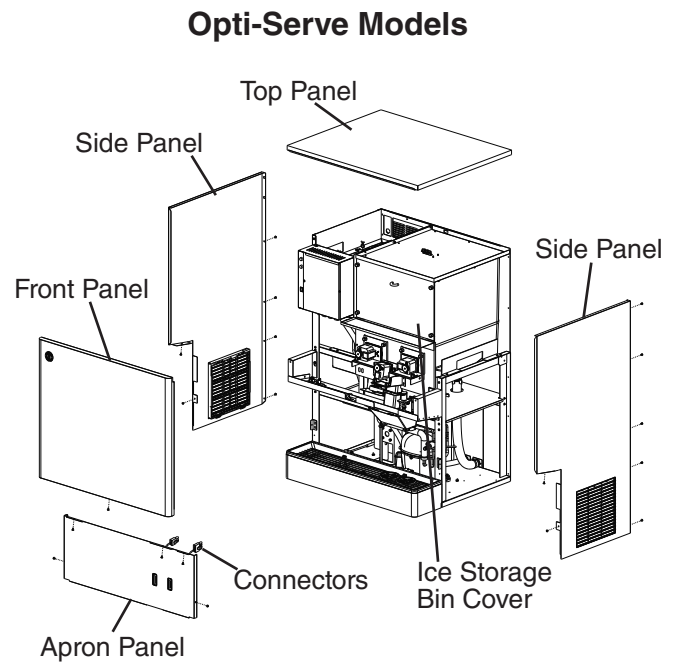

Fig. 2

D. Setup

- 1) Position the appliance in the selected permanent location. If applicable, attach optional 6" legs or attach to an optional stand. If attaching to a stand, refer to the instructions included with the stand. If removing the drip tray, refer to the instructions included with the HS kit (HS-5003 for DCM-751 B_H or HS-5002 for DCM-751B_H-OS).
- 2) Level the appliance in both the left-to-right and front-to-rear directions. If using optional 6" legs or an optional stand, adjust the legs to make the appliance level.
- 3) If mounting flat to a counter, seal the perimeter where the appliance contacts the counter with approved caulk compound in a smooth and easily cleanable manner.
- 4) Replace the panels in their correct positions.

E. Electrical Connection

⚠ WARNING

For All Models

- Electrical connection must be hard-wired and must meet national, state, and local electrical code requirements. Failure to meet these code requirements could result in death, electric shock, serious injury, fire, or damage.
- The appliance requires an independent power supply of proper capacity. See the nameplate for electrical specifications. Failure to use an independent power supply of proper capacity can result in a tripped breaker, blown fuse, damage to existing wiring, or component failure. This could lead to heat generation or fire.
- **THE APPLIANCE MUST BE GROUNDED.** Failure to properly ground the appliance could result in death or serious injury.
- Electrical connection must be made in accordance with the instructions on the "WARNING" tag, provided with the pig tail leads in the junction box. See Fig. 3.

- Usually an electrical permit and services of a licensed electrician are required.
- The maximum allowable voltage variation is ± 10 percent of the nameplate rating.
- The white lead must be connected to the neutral conductor of the power source.
NOTICE! Miswiring may result in damage to the appliance.
- The opening for the power supply connection is 7/8" DIA to fit a 1/2" trade size conduit.

Fig. 3

⚠ WARNING ELECTRICAL CONNECTION

THIS UNIT MUST BE GROUNDED

Failure to properly ground or wire this unit could result in death, serious injury, or severe damage to the icemaker. The white lead must be connected to the neutral conductor of the power source. See diagram below.

115-120/60/1

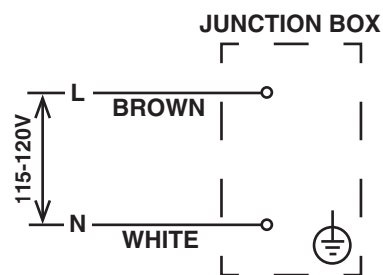

F. Water Supply and Drain Connections

See Fig. 4, 5, and 6

⚠ WARNING

Water supply and drain connections must be installed in accordance with applicable national, state, and local regulations.

NOTICE

- Normal operating water temperature must be within 45°F to 90°F (7°C to 32°C). Operation of the appliance, for extended periods, outside of this normal temperature range may affect appliance performance.
 - Water supply pressure must be a minimum of 10 PSIG and a maximum of 113 PSIG. If the pressure exceeds 113 PSIG, the use of a pressure reducing valve is required.
 - External filters, strainers, or softeners may be required depending on water quality. Contact your local Hoshizaki Certified Service Representative or local Hoshizaki distributor for recommendations.
-
- A plumbing permit and services of a licensed plumber may be required in some areas.
 - The ice storage bin drain line, drip tray drain line, and water-cooled condenser drain line (if applicable) must be run separately.
 - Drain lines must have 1/4" fall per foot (2 cm per 1 m) on horizontal runs to get a good flow. A vented tee connection is also required for proper flow.
 - Drain lines should not be piped directly to the sewer system. An air gap of a minimum of 2 vertical inches (5 cm) must be between the end of the drain pipes from the ice storage bin, drip tray, and water-cooled condenser (if applicable) and the floor drain.

1. Icemaker

- Icemaker water supply inlet is 1/2" female pipe thread (FPT). A minimum of 1/4" nominal ID copper water tubing or equivalent is required for the icemaker water supply line.
- An icemaker water supply line shut-off valve and drain valve should be installed.
- Ice storage bin and drip tray drain outlets are 3/4" FPT. A minimum of 3/4" nominal ID hard pipe or equivalent is required for the ice storage bin and drip tray drain lines.

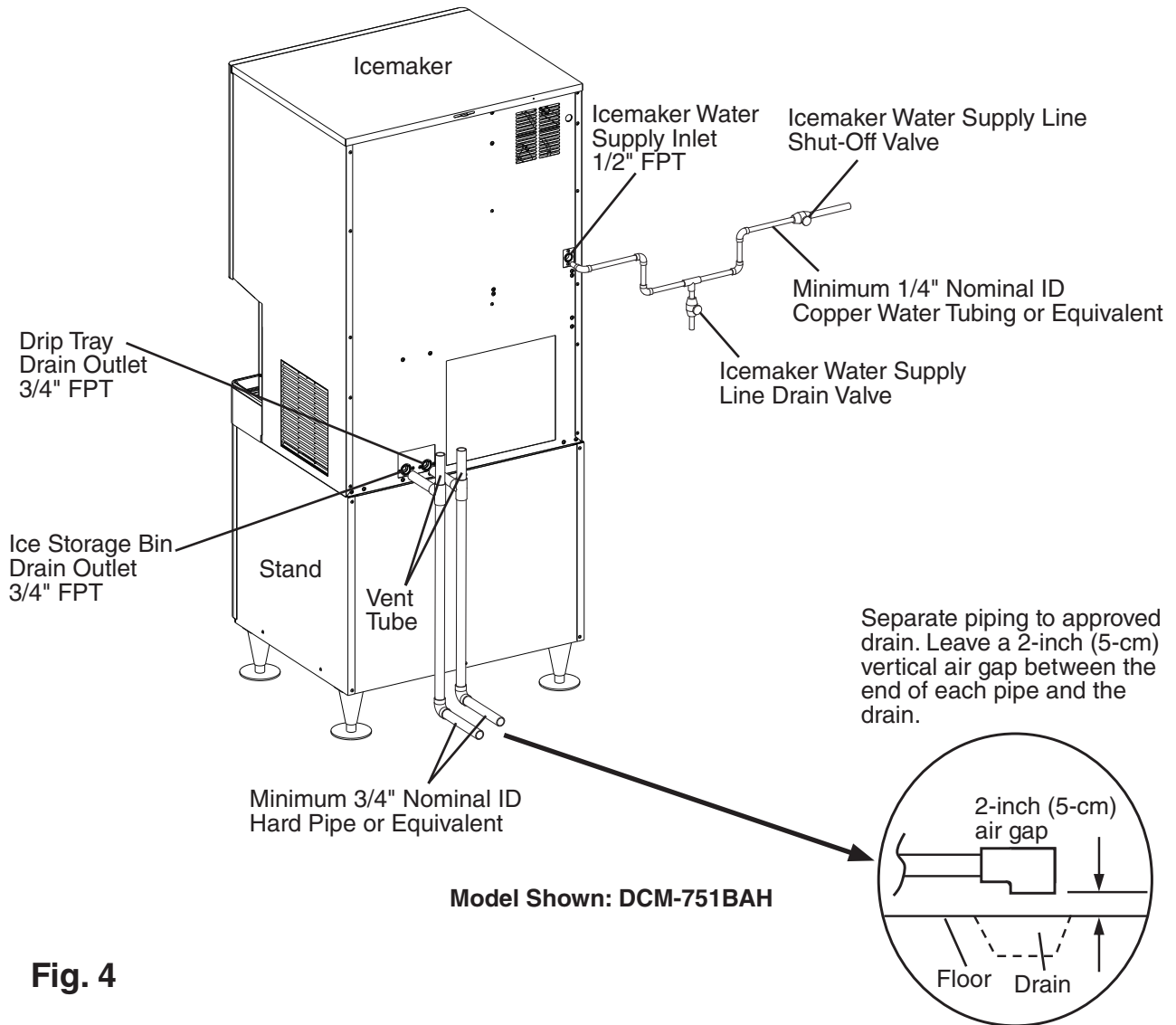
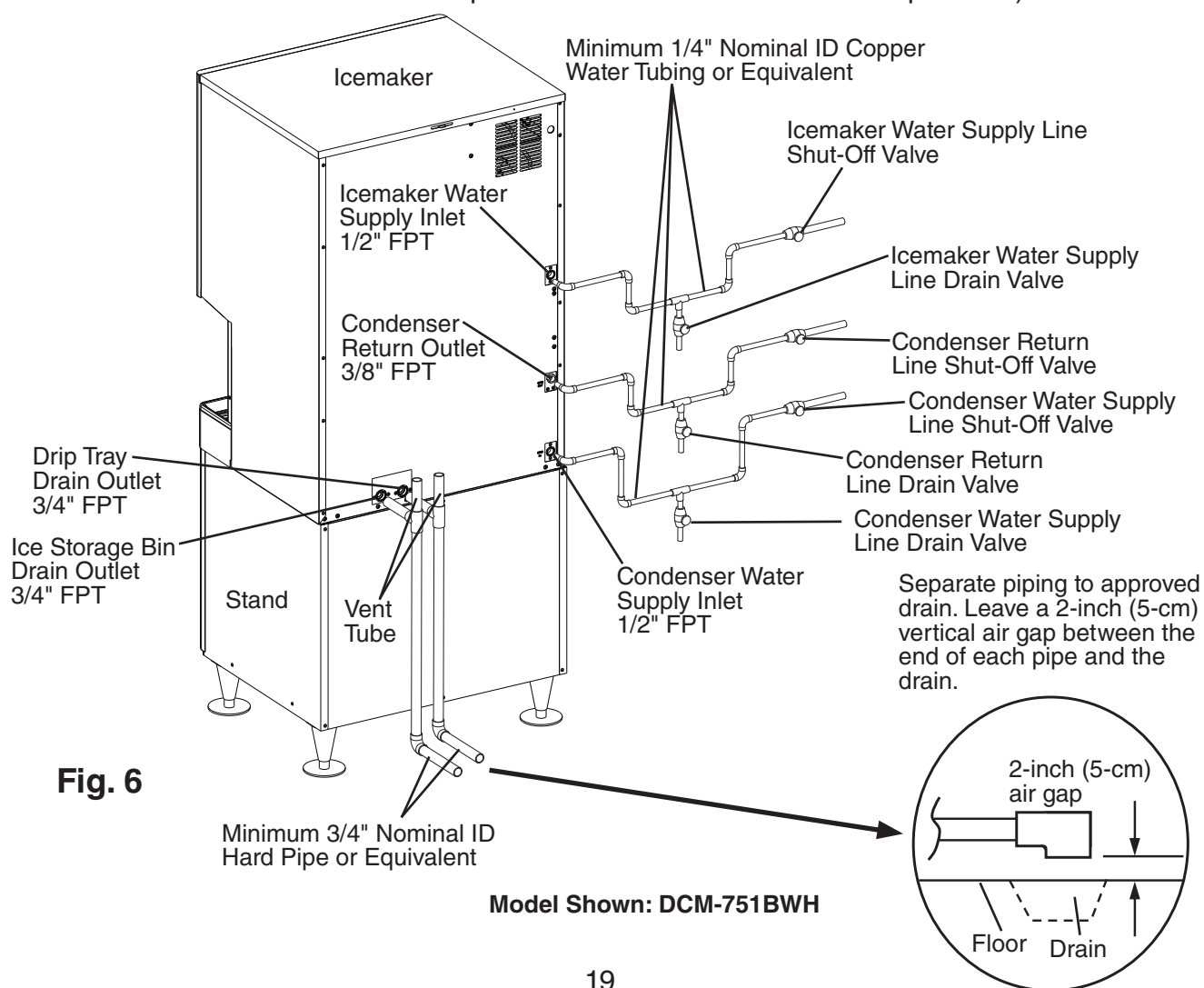

Fig. 4

b) Connection to a Closed Loop System

- Condenser water supply inlet is 1/2" female pipe thread (FPT). A minimum of 1/4" nominal ID copper water tubing or equivalent is required for the condenser water supply line.
- Condenser return outlet is 3/8" FPT. A minimum of 1/4" nominal ID copper water tubing or equivalent is required for the condenser return line.
- Shut-off valves and drain valves should be installed at both the condenser water supply inlet and condenser return outlet.
- The water supply to the condenser should not drop below 4 GPM.
- The pressure differential between the condenser water supply inlet and condenser return outlet must be no less than 10 PSIG.
- When using a glycol blend, the solution mixture should be less than 30% glycol.
- In order to maintain the proper high side pressure, the condenser water supply inlet temperature should not drop below 45°F (7°C) and the condenser drain outlet temperature must be in the 104°F to 115°F (40°C to 46°C) range. Once the icemaker installation is complete, confirm the condenser drain outlet temperature 5 minutes after a freeze cycle starts. If the condenser drain outlet temperature is not in the proper range, use a flat blade screwdriver to rotate the adjustment screw on the water-regulating valve until the temperature is in the proper range (rotate counterclockwise to raise temperature or clockwise to lower temperature).



G. Final Checklist

WARNING

CHOKING HAZARD: Ensure all components, fasteners, and thumbscrews are securely in place after installation. Make sure that none have fallen into the ice storage bin.

- 1) Is the icemaker level?
- 2) Is the icemaker in a site where the ambient temperature is within 45°F to 100°F (7°C to 38°C) and the water temperature within 45°F to 90°F (7°C to 32°C) all year around?
- 3) Is there at least 6" (15 cm) clearance at rear and sides and 24" (61 cm) at top for proper air circulation and ease of maintenance and service?
- 4) Have the shipping carton, tape, and packing material been removed from the icemaker?
- 5) If the icemaker is mounted flat to a counter, has the perimeter where the icemaker contacts the counter been sealed with approved caulk compound? If the icemaker is on a stand, has it been secured to the stand as outlined in the stand's instructions? On DCM-751B_H(-OS) if the drip tray has been removed, has the icemaker been secured to the counter as outlined in the HS kit's instructions (HS-5003 for DCM-751B_H or HS-5002 for DCM-751B_H-OS)?
- 6) Have all electrical and water connections been made? Do electrical and water connections meet all national, state, and local code and regulation requirements?
- 7) Has the power supply voltage been checked or tested against the nameplate rating? Has a proper ground been installed to the appliance?
- 8) Are the water supply and drain lines sized as specified? Are the water supply line shut-off valve(s) and drain valve(s) installed? Has the water supply pressure been checked to ensure a minimum of 10 PSIG and a maximum of 113 PSIG?
- 9) Is the compressor snug on all mounting pads? Have the refrigerant lines been checked to make sure they do not rub or touch other lines or surfaces? Has the fan blade (if applicable) been checked to make sure it turns freely?
- 10) Are all components, fasteners, and thumbscrews securely in place?
- 11) Has the end user been given the instruction manual, and instructed on how to operate the appliance and the importance of the recommended periodic maintenance?
- 12) Has the end user been given the contact information of an authorized service agent?
- 13) Has the warranty card been filled out and forwarded to the factory for warranty registration?

H. Startup

⚠ WARNING

- All parts are factory-adjusted. Improper adjustments may adversely affect safety, performance, component life, and warranty coverage.
- If the icemaker is turned off, wait for at least 3 minutes before restarting the icemaker to prevent damage to the compressor.
- At startup, confirm that all internal and external connections are free of leaks.

- 1) Open the water supply line shut-off valve(s).
- 2) Move the control switch to the "OFF" position. See Fig. 7.
- 3) Remove the front panel, then move the power switch to the "ON" position. Replace the front panel in its correct position, then turn on the power supply.
Note: This unit will not run if the safety switch is not engaged.
- 4) Move the control switch to the "ICE" position to start the automatic icemaking process.
- 5) Once the unit starts to produce ice, allow it to run for another 30 minutes.
- 6) Move the control switch to the "OFF" position, pause momentarily, then move to the "DRAIN" position. Allow the water system to drain for 5 minutes.
Note: a) A momentary pause in the "OFF" position is necessary to de-energize the control board when moving the control switch between "ICE" and "DRAIN." Otherwise there is a delay of several minutes before the new selection takes effect.
b) If the control switch is left in the "DRAIN" position for 10 minutes or more, a 2-beep alarm sounds every 5 seconds. Move the control switch out of the "DRAIN" position to clear the alarm.
- 7) Move the dispense mode switch to the "CONTINUOUS" position, then dispense all of the ice from the ice storage bin.
Note: Ice dispenses continuously for a maximum of 60 seconds per activation.
- 8) Remove the front panel, then remove the ice storage bin cover.
- 9) Move the control switch to the "ICE" position.

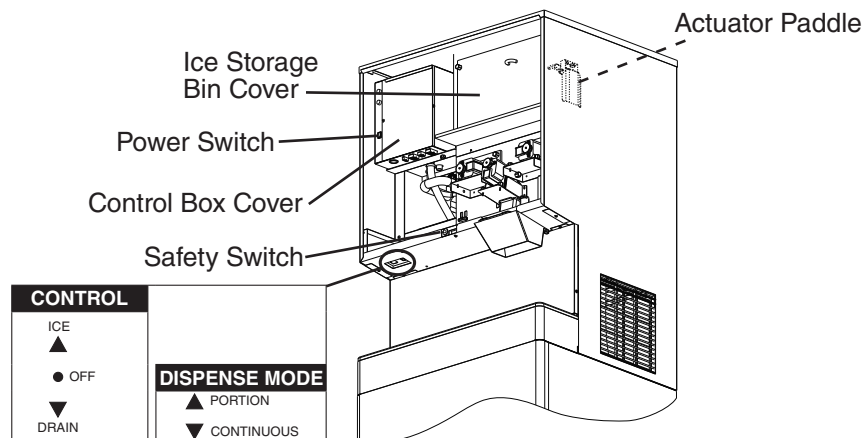
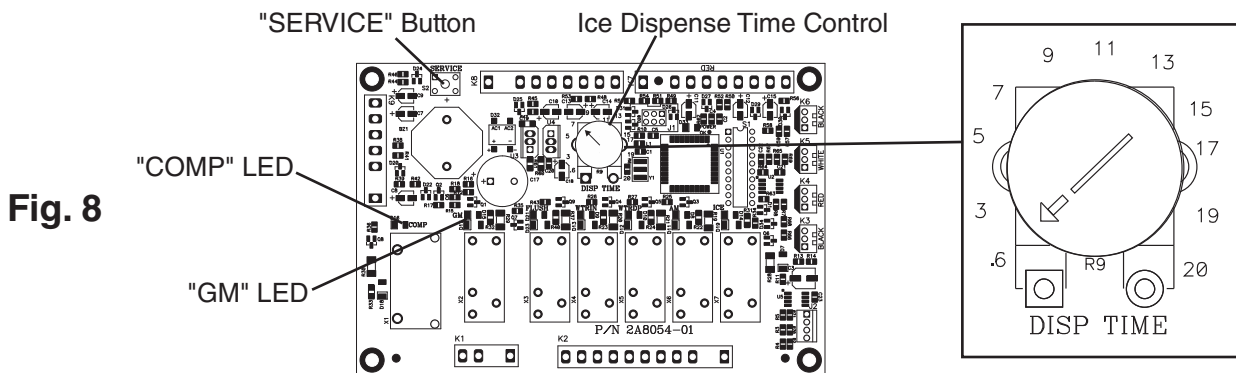

Fig. 7

- 10) Confirm bin control operation: Remove the control box cover and ice storage bin cover, move the control switch to the "ICE" position, then engage the safety switch on the front frame. See Fig. 7. After the "GM" LED on the control board turns on (5 sec.), the 5-min. ice purge timer starts. Bypass the 5-min. ice purge timer by pressing the "SERVICE" button on the control board. See Fig. 8. **WARNING! Risk of electric shock. Care should be taken not to touch live terminals.** Otherwise, wait for the 5-min. ice purge timer to terminate and the compressor to start. Next, press and hold the actuator paddle located inside the ice storage bin. **WARNING! Keep hands, hair, and loose clothing clear of the agitator(s) inside the ice storage bin.** 6 to 10 sec. later, the 90-sec. compressor shutdown timer starts. Once the 90-sec. compressor shutdown timer terminates, the compressor de-energizes and the 60-sec. gear motor shutdown timer starts. Once the 60-sec. gear motor timer terminates, the gear motor de-energizes.
- 11) Release the actuator paddle and disengage the safety switch. Move the control switch to the "OFF" position, then move the power switch to the "OFF" position. Turn off the power supply. Replace the control box cover and ice storage bin cover in their correct positions.
- 12) Clean the ice storage bin liner, cover, and components using a neutral cleaner. Rinse thoroughly after cleaning. **WARNING! CHOKING HAZARD: Ensure all components, fasteners, and thumbscrews are securely in place. Make sure that none have fallen into the ice storage bin.** Replace the ice storage bin cover in its correct position.
- 13) Move the power switch to the "ON" position, then replace the front panel in its correct position. Turn on the power supply, then move the control switch to the "ICE" position to start the automatic icemaking process.



I. Dispense Mode Switch

The dispense mode switch has "CONTINUOUS" and "PORTION" positions. When the dispense mode switch is in the "CONTINUOUS" position, ice dispenses continuously for a maximum of 60 seconds per activation. When the dispense mode switch is in the "PORTION" position, ice dispenses for the amount of time determined by the ice dispense time setting. The ice dispense time control is located on the control board. The dial indicates dispense time in seconds and is adjustable between 0.6 and 20 seconds. See Fig. 8. When shipped, the ice dispense time control is set to the minimum dispense time of 0.6 sec. At this setting, approximately 0.72 oz. of ice is dispensed. Approximately 1.2 oz. of ice is dispensed per second.

J. Alarm Safeties

Should an alarm occur, follow the instructions in the table below to address the alarm. If an alarm continues to occur, contact an authorized service agent.

⚠ WARNING	
<ul style="list-style-type: none"> • Only qualified service technicians should service the appliance. • To reduce the risk of electric shock, do not touch the icemaker power switch or control switch with damp hands. • Before Servicing: Move the icemaker's power switch to the "OFF" position. Turn off the power supply. Lockout/Tagout to prevent the power supply from being turned back on inadvertently. 	

No. of Beeps (every 5 sec.)	Type of Alarm	Reset Options
1	Low Water Safety UFS open > 90 sec. after WV energized.	Automatic reset once water supply is restored and UFS closes.
2	Control Switch In "DRAIN" position longer than 10 min.	Automatic reset once the control switch is moved to the "ICE" position.
3	High-Pressure Switch First and second activation in 1 hr.	Automatic reset once pressure drops below the high pressure threshold and HPS closes.
4	High-Pressure Switch Third activation in 1 hr.	Call for service. To avoid possible catastrophic failure, it is recommended to leave the icemaker off until this alarm is resolved. Manual reset. Turn power off and on again.
5	Freeze Timer WV off > 30 min. since last WV activation.	Manual reset. Turn power off and on again.
6	Low Voltage 92VAC ± 5% or less	"POWER OK" LED turns off if voltage protection operates.
7	High Voltage 147VAC ± 5% or more	The control voltage safeties automatically reset when voltage is corrected.
8	Gear Motor CCR contacts fail to close.	Manual reset. Turn power off and on again.

Legend: **CCR**—compressor control relay; **UFS**—upper float switch; **HPS**—high-pressure switch; **WV**—inlet water valve

III. Maintenance

The appliance must be maintained in accordance with the instruction manual and labels provided. Consult with your local Hoshizaki Certified Service Representative about maintenance service.

⚠ WARNING

- Only qualified service technicians should service the appliance.
- To reduce the risk of electric shock, do not touch the power switch or control switch with damp hands.
- **Before Servicing:** Move the power switch to the "OFF" position. Turn off the power supply. Lockout/Tagout to prevent the power supply from being turned back on inadvertently.
- **CHOKING HAZARD:** Ensure all components, fasteners, and thumbscrews are securely in place after any maintenance is done to the appliance. Make sure that none have fallen into the ice storage bin.

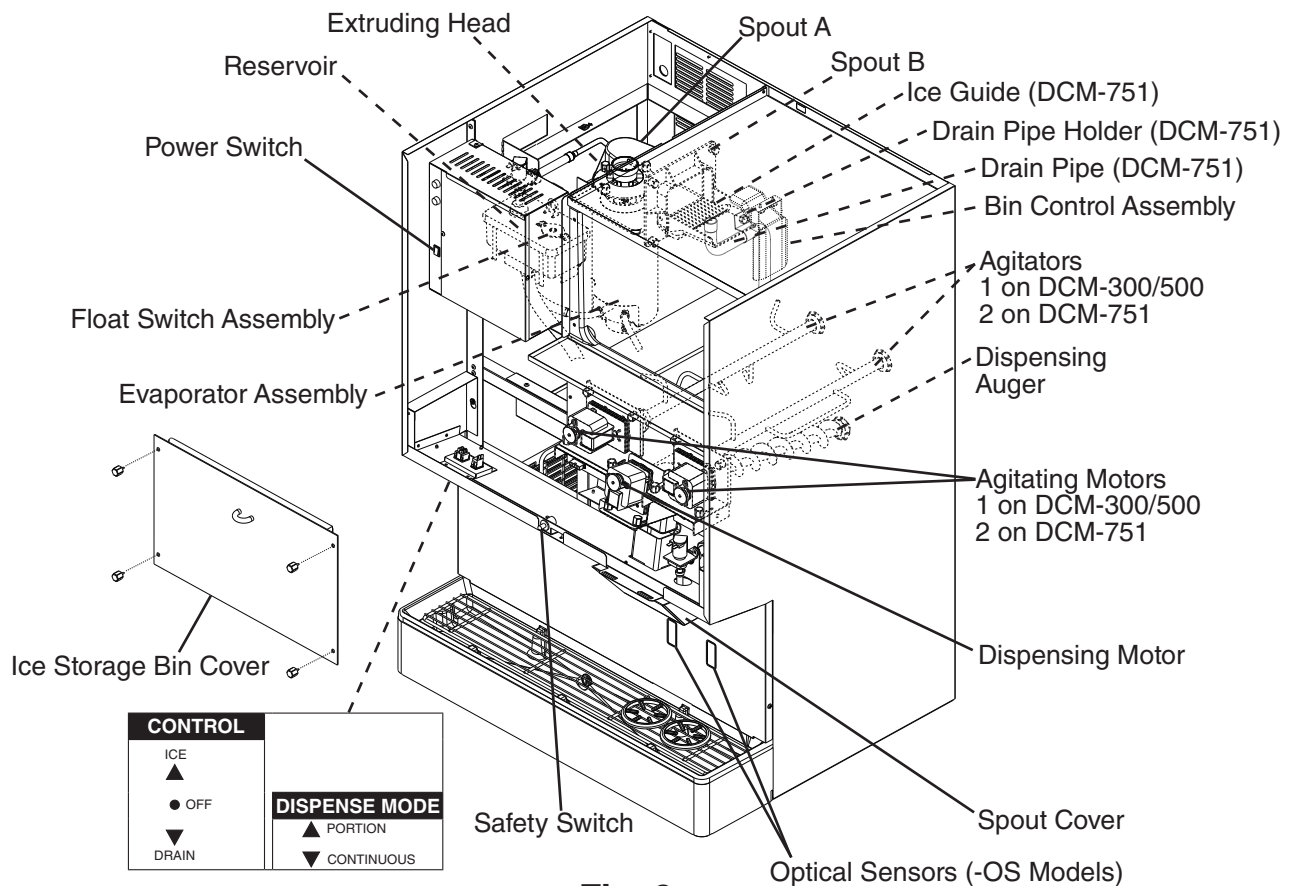

Fig. 9

Model Shown: DCM-751BWH-OS

A. Maintenance Schedule

The maintenance schedule below is a guideline. More frequent maintenance may be required depending on water quality, the appliance's environment, and local sanitation regulations.

Maintenance Schedule		
Frequency	Area	Task
Bi-Weekly	Air Filters	Inspect. Wash with warm water and neutral cleaner if dirty.
Monthly	External Water Filters	Check for proper pressure and change if necessary.
	Icemaker Exterior	Wipe down with a clean, soft cloth. Use a damp cloth containing a neutral cleaner to wipe off oil or dirt build up. Clean any chlorine staining (rust colored spots) using a non-abrasive cleanser.
Every 6 Months	Icemaker and Ice Storage Bin	Clean and sanitize per the cleaning and sanitizing instructions provided in this manual.
	Evaporator Condensate Drain Pan and Gear Motor Drain Pan	Wipe down with a clean cloth and warm water. Slowly pour one cup of sanitizing solution (prepare as outlined in the sanitizing instructions in this manual) into the evaporator condensate drain pan. Be careful not to overflow the pan. This solution will flow down to the gear motor drain pan and out the drain line to sanitize these areas. Repeat with a cup of clean water to rinse.
	Icemaker, Ice Storage Bin, and Drip Tray Drains	Check to make sure they are clear.
	Extruding Head Seal Bolts	Inspect for leakage around seal bolts. Tighten (see torque value below) or replace as necessary. Seal bolts must be replaced once removed because seal material is one-time use only. If new seal bolts do not have preapplied threadlocker, apply Loctite 243 or equivalent threadlocker to seal bolt threads. • <i>Torque:</i> 11.1 ft-lb/15 N·m
Yearly	Inlet Water Valve and Drain Valve	Close the icemaker water supply line shut-off valve and drain the water system. Clean the inlet water valve screen and clean and inspect the drain valve.
	Water Hoses	Inspect the water hoses and clean/replace if necessary.
	Condenser	Inspect. Clean if necessary by using a brush or vacuum cleaner.
	Icemaker	Inspect for oil spots, loose components, fasteners, and wires.
	Upper Bearing (extruding head)	Check for wear using .02" round stock or pin gauge. Replace both upper bearing and lower bearing if wear exceeds factory recommendations. See the Service Manual for details.
After 3 Years, then Yearly	Upper Bearing (extruding head); Lower Bearing and O-Ring (lower housing); Mechanical Seal; Evaporator Cylinder; Auger	Inspect. Replace both upper bearing and lower bearing if wear exceeds factory recommendations. Replace the mechanical seal if the seal's contact surfaces are worn, cracked, or scratched. See the Service Manual for details.

B. Cleaning and Sanitizing Instructions

The icemaker must be cleaned and sanitized at least twice a year. More frequent cleaning and sanitizing may be required in some conditions.

WARNING

- To prevent injury to individuals and damage to the icemaker, do not use ammonia type cleaners.
- Carefully follow any instructions provided with the cleaning and sanitizing solutions.
- Always wear liquid-proof gloves and goggles to prevent the cleaning and sanitizing solutions from coming into contact with skin or eyes.
- After cleaning and sanitizing, do not use ice made from the cleaning and sanitizing solutions. Be careful not to leave any solution on the parts or in the ice storage bin.

1. Water System

a) Cleaning Solution

Dilute 9.6 fl. oz. (0.29 l) of Hoshizaki "Scale Away" with 1.6 gal. (6.0 l) of warm water. This is a minimum amount. Make more solution if necessary. **IMPORTANT! For safety and maximum effectiveness, use the solution immediately after dilution.**

b) Cleaning Procedure

- 1) Close the icemaker water supply line shut-off valve.
- 2) Move the control switch to the "OFF" position, pause momentarily, then move to the "DRAIN" position. See Fig. 9. Allow the water system to drain for 5 minutes.
Note: a) A momentary pause in the "OFF" position is necessary to de-energize the control board when moving the control switch between "ICE" and "DRAIN." Otherwise there is a delay of several minutes before the new selection takes effect.
b) If the control switch is left in the "DRAIN" position for 10 minutes or more, a 2-beep alarm sounds every 5 seconds. Move the control switch out of the "DRAIN" position to clear the alarm.
- 3) Move the dispense mode switch to the "CONTINUOUS" position, then dispense all of the ice from the ice storage bin.
- 4) Move the control switch to the "OFF" position, then turn off the power supply. Remove the front and top panels, then move the power switch to the "OFF" position.
- 5) Remove the ice storage bin cover. Remove spout B, then remove spout A.
- 6) Pour the cleaning solution over the extruding head until the evaporator assembly and the reservoir are full and the solution starts to overflow into the drain pan.
Note: If there is excess scale on the extruding head, fill the evaporator assembly and reservoir as described above, then use a clamp on the reservoir hose between the reservoir and evaporator assembly to block flow. Pour additional cleaning solution over the extruding head until the evaporator assembly is completely full.

- 7) Replace spout A, spout B, and the ice storage bin cover in their correct positions.
- 8) Allow the icemaker to sit for 10 minutes before operation. If you placed a clamp on the reservoir hose in step 6, remove it before operation.
- 9) In bad or severe water conditions, clean the float switch assembly as described below. Otherwise, continue to step 10.
 - a. Remove the float switch assembly from the reservoir cover.
 - b. Wipe down the float switch assembly with the cleaning solution.
 - c. Rinse the float switch assembly thoroughly with clean water.
 - d. Replace the float switch assembly in its correct position.
- 10) Move the power switch to the "ON" position and replace the panels in their correct positions. Turn on the power supply, then move the control switch to the "ICE" position. Make ice using the solution until the icemaker stops making ice.
Note: This unit will not run if the safety switch is not engaged.
- 11) Move the control switch to the "OFF" position, pause momentarily, then move to the "DRAIN" position. Allow the water system to drain for 5 minutes.
- 12) Move the control switch to the "OFF" position, pause momentarily, then move to the "ICE" position. Open the icemaker water supply line shut-off valve to supply water to the reservoir.
- 13) After the gear motor starts, move the control switch to the "OFF" position, pause momentarily, then move to the "DRAIN" position. Allow the water system to drain for 5 minutes.
Note: If you do not sanitize the unit, move the control switch to the "OFF" position, pause momentarily, then move to the "ICE" position after the water system drains. Allow the icemaker to run for 30 minutes, then move the control switch to the "OFF" position. Turn off the power supply, then remove the front panel and ice storage bin cover. Move the power switch to the "OFF" position. Go to step 12 in "III.B.2.c) Cleaning and Sanitizing Procedure."
- 14) Move the control switch to the "OFF" position, then turn off the power supply.
- 15) Close the icemaker water supply line shut-off valve.

c) Sanitizing Solution

Dilute 0.82 fl. oz. (25 ml) of a 5.25% sodium hypochlorite solution (chlorine bleach) with 1.6 gal. (6.0 l) of warm water. This is a minimum amount. Make more solution if necessary. **IMPORTANT! For safety and maximum effectiveness, use the solution immediately after dilution.**

d) Sanitizing Procedure - Following Cleaning Procedure

- 1) Make sure the control switch is in the "OFF" position, the power supply is off, and the icemaker water supply line shut-off valve is closed.
- 2) Remove the front and top panels, then move the power switch to the "OFF" position.
- 3) Remove the ice storage bin cover. Remove spout B, then remove spout A.
- 4) Pour the sanitizing solution over the extruding head until the evaporator assembly and the reservoir are full and the solution starts to overflow into the drain pan.
- 5) Replace spout A, spout B, and the ice storage bin cover in their correct positions.
- 6) Allow the icemaker to sit for 10 minutes before operation.
- 7) Move the power switch to the "ON" position and replace the panels in their correct positions. Turn on the power supply, then move the control switch to the "ICE" position. Make ice using the solution until the icemaker stops making ice.
- 8) Move the control switch to the "OFF" position, pause momentarily, then move to the "DRAIN" position. Allow the water system to drain for 5 minutes.
- 9) Move the control switch to the "OFF" position, pause momentarily, then move to the "ICE" position. Open the icemaker water supply line shut-off valve to supply water to the reservoir.
- 10) After the gear motor starts, move the control switch to the "OFF" position, pause momentarily, then move to the "DRAIN" position. Allow the water system to drain for 5 minutes.
- 11) Move the control switch to the "OFF" position, pause momentarily, then move to the "ICE" position. Allow the icemaker to run for 30 minutes, then clean and sanitize the dispensing components as outlined below.

2. Dispensing Components

Perform after cleaning and sanitizing the water system as outlined above.

a) Cleaning Solution

Dilute 9.6 fl. oz. (0.29 l) of Hoshizaki "Scale Away" with 1.6 gal. (6.0 l) of warm water.

b) Sanitizing Solution

Dilute 0.82 fl. oz. (25 ml) of a 5.25% sodium hypochlorite solution (chlorine bleach) with 1.6 gal. (6.0 l) of warm water.

c) Cleaning and Sanitizing Procedure

- 1) Move the control switch to the "OFF" position, then turn off the power supply.
- 2) Remove the front and top panels, then move the power switch to the "OFF" position.

- 3) Remove the ice storage bin cover.
- 4) Remove the motor bracket thumbscrews, first from the vertical plane and then from the horizontal plane. While holding on to the corresponding agitator or auger, move the agitating motor or the dispensing motor towards you. Remove the agitator(s) and the dispensing auger from the ice storage bin. See Fig. 9.
Note: DCM-300 and DCM-500 models have 1 agitator and DCM-751 models have 2 agitators.
- 5) Remove the bin control assembly. See Fig. 10.
- 6) Remove the snap pin, shaft, and actuator.
- 7) Remove spout B, spout A, and their gaskets.
- 8) Remove the spout cover, ice dispensing spout, and water dispensing nozzle. See Fig. 11. On DCM-751 model, also remove the ice guide, drain pipe holder, and drain pipe from the ice storage bin. See Fig. 9.
- 9) Immerse the agitator(s), dispensing auger, and parts removed in steps 5 through 8 in the cleaning solution for 15 min. Rinse the parts thoroughly with clean water, then immerse the parts into the sanitizing solution for 15 min. Rinse the parts thoroughly with clean water. On optical sensor models (-OS), wipe the optical sensors with cleaning solution and then with a clean, damp cloth.
- 10) Wipe the shutter located above the ice dispensing spout thoroughly with a clean cloth.
- 11) Reassemble the bin control assembly and replace all parts in the reverse order of which they were removed.
- 12) Pour warm water into the ice storage bin and melt any remaining ice. Clean the ice storage bin liner and the ice storage bin cover using a neutral cleaner. Rinse thoroughly after cleaning. Replace the ice storage bin cover in its correct position.
- 13) Move the power switch to the "ON" position, then replace the panels in their correct positions. Turn on the power supply, then move the control switch to the "ICE" position to start the automatic icemaking process.

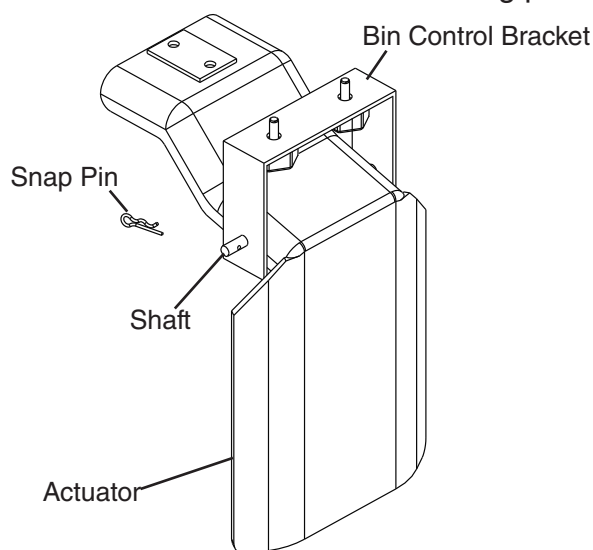

Fig. 10

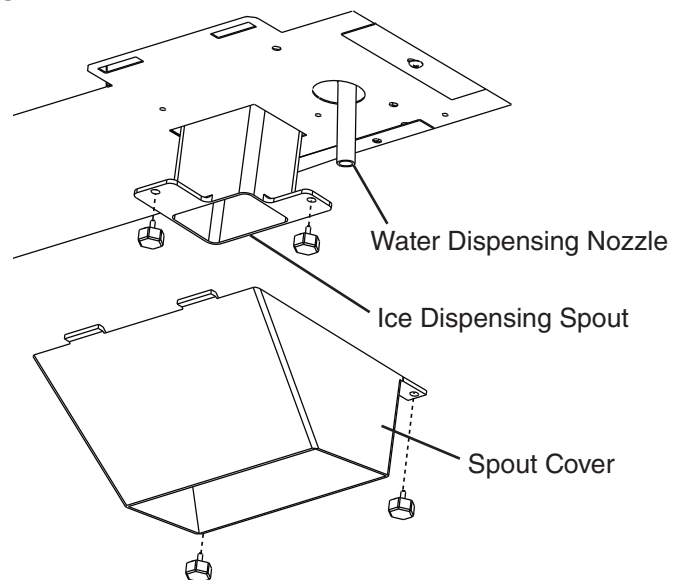

Fig. 11

IV. Preparing the Appliance for Periods of Non-Use

NOTICE

When storing the appliance for an extended time or in sub-freezing temperatures, follow the instructions below to prevent damage.

When the appliance is not used for two or three days under normal conditions, it is sufficient to move the power switch to the "OFF" position. When storing the appliance for an extended time or in sub-freezing temperatures, follow the instructions below.

1. Remove the ice from the ice storage bin, drain the water system, and remove the water from the icemaker water supply line:

- 1) Close the icemaker water supply line shut-off valve and open the icemaker water supply line drain valve.
- 2) Move the control switch to the "OFF" position, pause momentarily, then move to the "DRAIN" position. Allow the water system to drain for 5 minutes.
Note: a) A momentary pause in the "OFF" position is necessary to de-energize the control board when moving the control switch between "ICE" and "DRAIN." Otherwise there is a delay of several minutes before the new selection takes effect.
b) If the control switch is left in the "DRAIN" position for 10 minutes or more, a 2-beep alarm sounds every 5 seconds. Move the control switch out of the "DRAIN" position to clear the alarm.
- 3) Move the dispense mode switch to the "CONTINUOUS" position, then dispense all of the ice from the ice storage bin.
- 4) Attach a compressed air or carbon dioxide supply to the icemaker water supply line drain valve.
- 5) While engaging the water dispense switch, blow out the water dispense valve using the compressed air or carbon dioxide supply. After blowing out the water dispense valve, leave the compressed air or carbon dioxide supply flowing. Move the control switch to the "OFF" position, pause momentarily, then move to the "ICE" position to open the inlet water valve and briefly blow out the inlet water valve. After blowing out the inlet water valve, move the control switch to the "OFF" position.
- 6) Close the icemaker water supply line drain valve.
- 7) Turn off the power supply, then remove the front panel and move the power switch to the "OFF" position.
- 8) Remove the ice storage bin cover. Clean the ice storage bin liner and the ice storage bin cover using a neutral cleaner. Rinse thoroughly after cleaning. Replace the ice storage bin cover and the front panel in their correct positions.
Note: If your unit has a water-cooled condenser, leave the front panel off and go to the next section.

2. On water-cooled model only, remove the water from the water-cooled condenser:

- 1) Make sure the control switch and the power switch are in the "OFF" position and that the power supply is off. Remove the top, apron, and left side panels.
- 2) Close the condenser water supply line shut-off valve. If connected to a closed loop system, also close the condenser return line shut-off valve.
- 3) Open the condenser water supply line drain valve. If connected to a closed loop system, also open the condenser return line drain valve.
- 4) Attach a compressed air or carbon dioxide supply to the condenser water supply line drain valve.
- 5) Open the water regulating valve by using a screwdriver to pry up on the spring retainer underneath the spring. While holding the valve open, blow out the condenser using the compressed air or carbon dioxide supply until water stops coming out.
- 6) Close the drain valve(s).
- 7) Replace the panels in their correct positions.

V. Disposal

The appliance contains refrigerant and must be disposed of in accordance with applicable national, state, and local codes and regulations. Refrigerant must be recovered by properly certified service personnel.

HOSHIZAKI AMERICA, INC.

618 Hwy. 74 South, Peachtree City, GA 30269 USA (P) 770.487.2331 (F) 770.487.3360 hoshizakiamerica.com 1A4171-010