

# Hoshizaki America, Inc.

## Commercial Refrigerators & Freezers

Models  
SafeTemp®



“A Superior Degree  
of Reliability”

[www.hoshizaki.com](http://www.hoshizaki.com)

## SERVICE MANUAL



Number: 73096  
Issued: 10-9-2000  
Revised: 3-7-2007

## **IMPORTANT**

Only qualified service technicians should attempt to service or maintain this unit. No such service or maintenance should be undertaken until the technician has thoroughly read this Service Manual.

HOSHIZAKI provides this manual primarily to assist qualified service technicians in the service and maintenance of the unit.

Should the reader have any questions or concerns which have not been satisfactorily addressed, please call, write or send an e-mail message to the HOSHIZAKI Technical Support Department for assistance.

HOSHIZAKI AMERICA, INC.  
618 Highway 74 South  
Peachtree City, GA 30269

Attn: HOSHIZAKI Technical Support Department

Phone: 1-800-233-1940 Technical Service

(770) 487-2331

Fax: 1-800-843-1056

(770) 487-3360

E-mail: techsupport@hoshizaki.com

Web Site: [www.hoshizaki.com](http://www.hoshizaki.com)

NOTE: To expedite assistance, all correspondence/communication MUST include the following information:

- Model Number
  
- Serial Number
  
- Complete and detailed explanation of the problem

Please review this manual. It should be read carefully before the unit is serviced or maintenance operations are performed. Only qualified service technicians should service and maintain the unit. This manual should be made available to the technician prior to service or maintenance.

## CONTENTS

I. Specifications.....	5
A. Nameplate Ratings.....	5
B. Dimensions .....	5
1. Notes for All Units .....	5
2. RH1-AAC(-HD), FH1-AAC(-HD) .....	6
3. RH2-AAC(-HD), FH2-AAC(-HD) .....	7
4. RH3-AAC(-HD) .....	8
II. General Information .....	9
A. Sequence of Operation and Timing Charts.....	9
1. Refrigerator .....	9
2. Freezer .....	11
B. Control Module.....	13
1. Settings and Adjustments.....	13
2. Service Menu .....	14
C. Thermistors .....	16
1. Cabinet Thermistor (SEN1: white and black leads) .....	16
2. Defrost Thermistor (SEN2: black and red leads) .....	16
3. Thermistor Check Procedure.....	16
D. Compressor Protector .....	17
E. Safety Devices .....	17
1. Pressure Switch.....	17
2. Defrost Protection.....	17
F. Perimeter Frame Heater .....	17
III. Service Diagnosis .....	18
A. Diagnosis Chart .....	18
IV. Removal and Replacement of Components .....	21
A. Service for Refrigerant Lines .....	21
1. Refrigerant Recovery.....	21
2. Brazing .....	21
3. Evacuation and Recharge [R-134a, R-404A] .....	22
B. Removal and Replacement of Compressor .....	23
C. Removal and Replacement of Expansion Valve .....	24
D. Removal and Replacement of Evaporator .....	25
E. Removal and Replacement of Door Gasket.....	25
F. Removal and Replacement of Door Closure Spring .....	26
G. Door Re-Hinging.....	27
H. Removal and Replacement of Control Module .....	28
I. Removal and Replacement of Thermistors .....	29

V. Cleaning Instructions .....	32
VI. Wiring Diagrams .....	33
A. RH1-AAC(-HD).....	33
B. RH2-AAC(-HD).....	34
C. RH3-AAC(-HD).....	35
D1. FH1-AAC(-HD) (auxiliary code P-7 and earlier).....	36
D2. FH1-AAC(-HD) (auxiliary code P-8 and later).....	37
E1. FH2-AAC(-HD) (auxiliary code P-5 and earlier).....	38
E2. FH2-AAC(-HD) (auxiliary code P-6 and later).....	39

# I. Specifications

## A. Nameplate Ratings

	AC Supply Voltage	Amperes	Design Pressure (PSIG)		Refrigerant and Refrigerant Charge	
			HI	LO	R-404A	R-134a
RH1-AAC / RH1-AAC-HD	115/60/1	5.0	240	120		9.3 OZ
FH1-AAC / FH1-AAC-HD	115/60/1	12	475	250	15.2 OZ	
RH2-AAC / RH2-AAC-HD	115/60/1	7.0	240	120		11.6 OZ
FH2-AAC / FH2-AAC-HD	115/60/1	15.5	450	250	20.1 OZ	
RH3-AAC / RH3-AAC-HD	115/60/1	12.0	250	120		20.6 OZ
RH1-AAC-W	115/60/1	7.0	450	200	12.2 OZ	

## B. Dimensions

### 1. Notes for All Units

- 1) Units shipped with 4" casters
- 2) Optional legs have 25.4 mm (1 in.) height adjustment

	Door Opening		Total Refrigerated Volume ft <sup>3</sup>	Total Shelf Space ft <sup>2</sup>
	Width mm (in.)	Height mm (in.)		
RH1-AAC / FH1-AAC	554.8 (21.8)	1507 (59.3)	22.3	11.5
RH1-AAC-HD / FH1-AAC-HD	554.8 (21.8)	681.7 (26.8)	22.3	
RH2-AAC / FH2-AAC	554.8 (21.8)	1507 (59.3)	48.3	25.9
RH2-AAC-HD / FH2-AAC-HD	554.8 (21.8)	681.7 (26.8)	48.3	
RH3-AAC	554.8 (21.8)	1507 (59.3)	73.7	40.3
RH3-AAC-HD	554.8 (21.8)	681.7 (26.8)	73.7	

See the nameplate for electrical and refrigeration specifications. The nameplate is located on the right side wall of the cabinet interior.

Note: We reserve the right to make changes in specifications and design without prior notice.

**2. RH1-AAC(-HD), FH1-AAC(-HD)**

mm (in.)

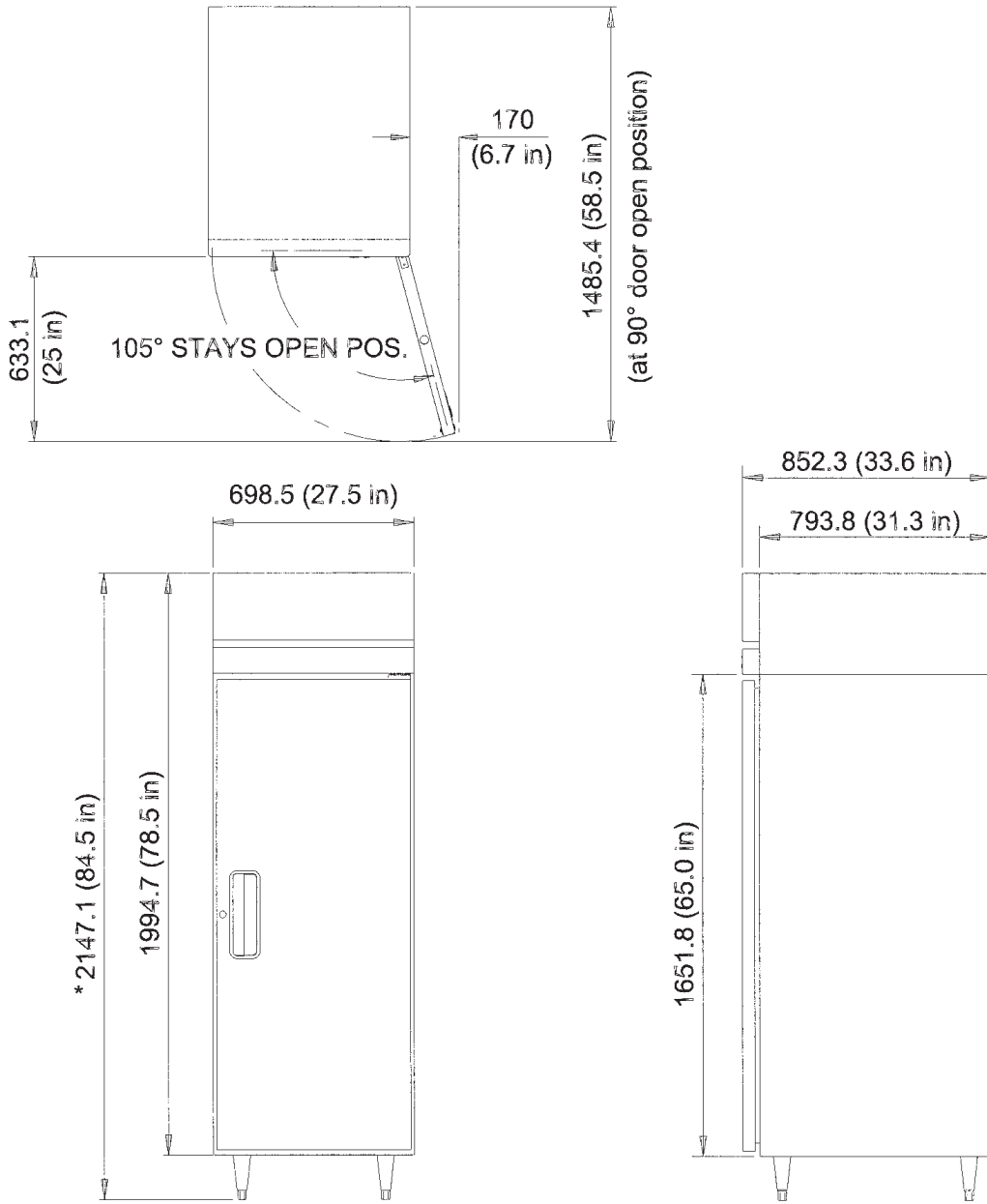

**\* Shown with optional 6" legs; 4" casters are standard**

### 3. RH2-AAC(-HD), FH2-AAC(-HD)

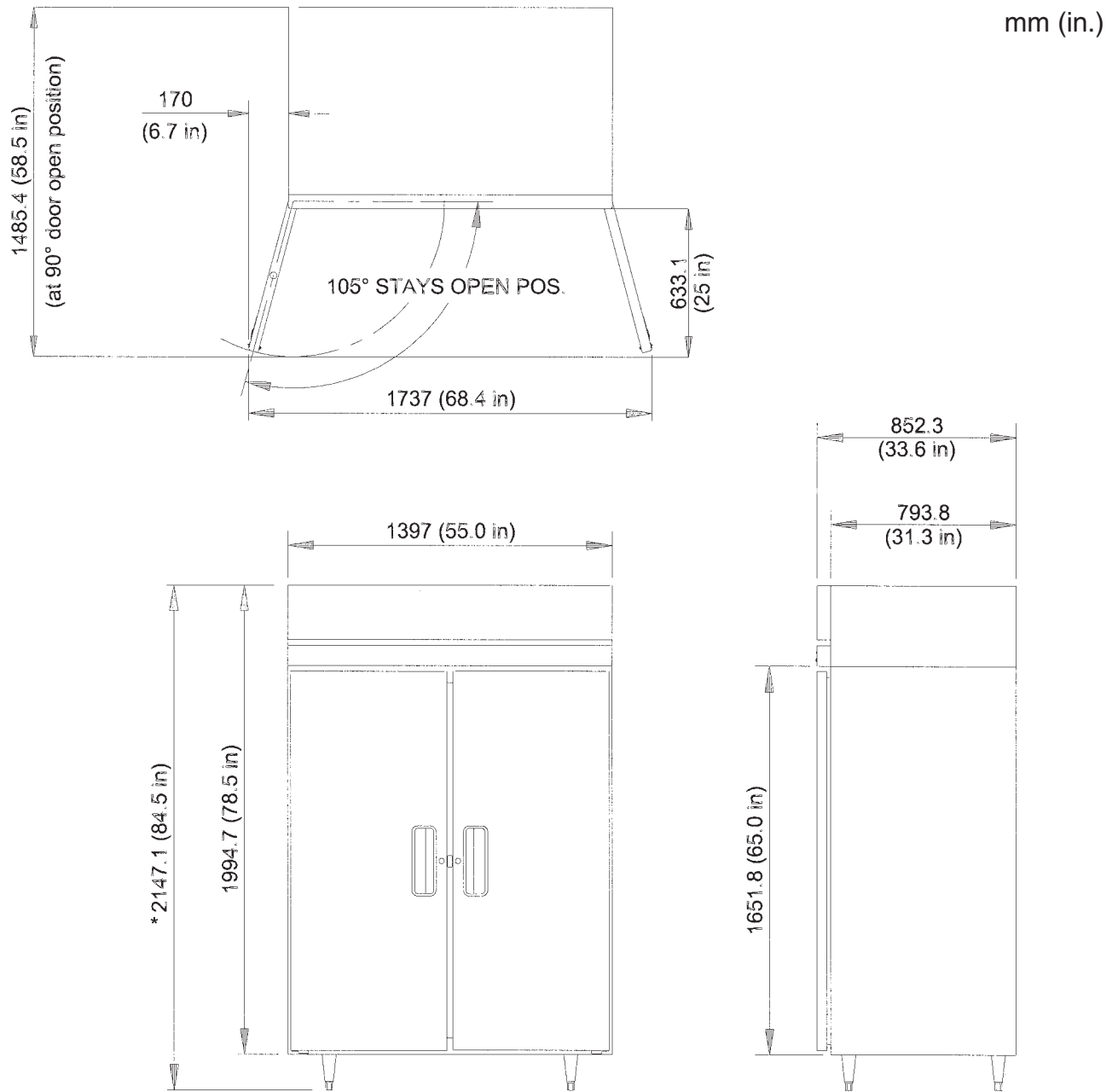

\* Shown with optional 6" legs; 4" casters are standard

#### 4. RH3-AAC(-HD)

mm (in.)

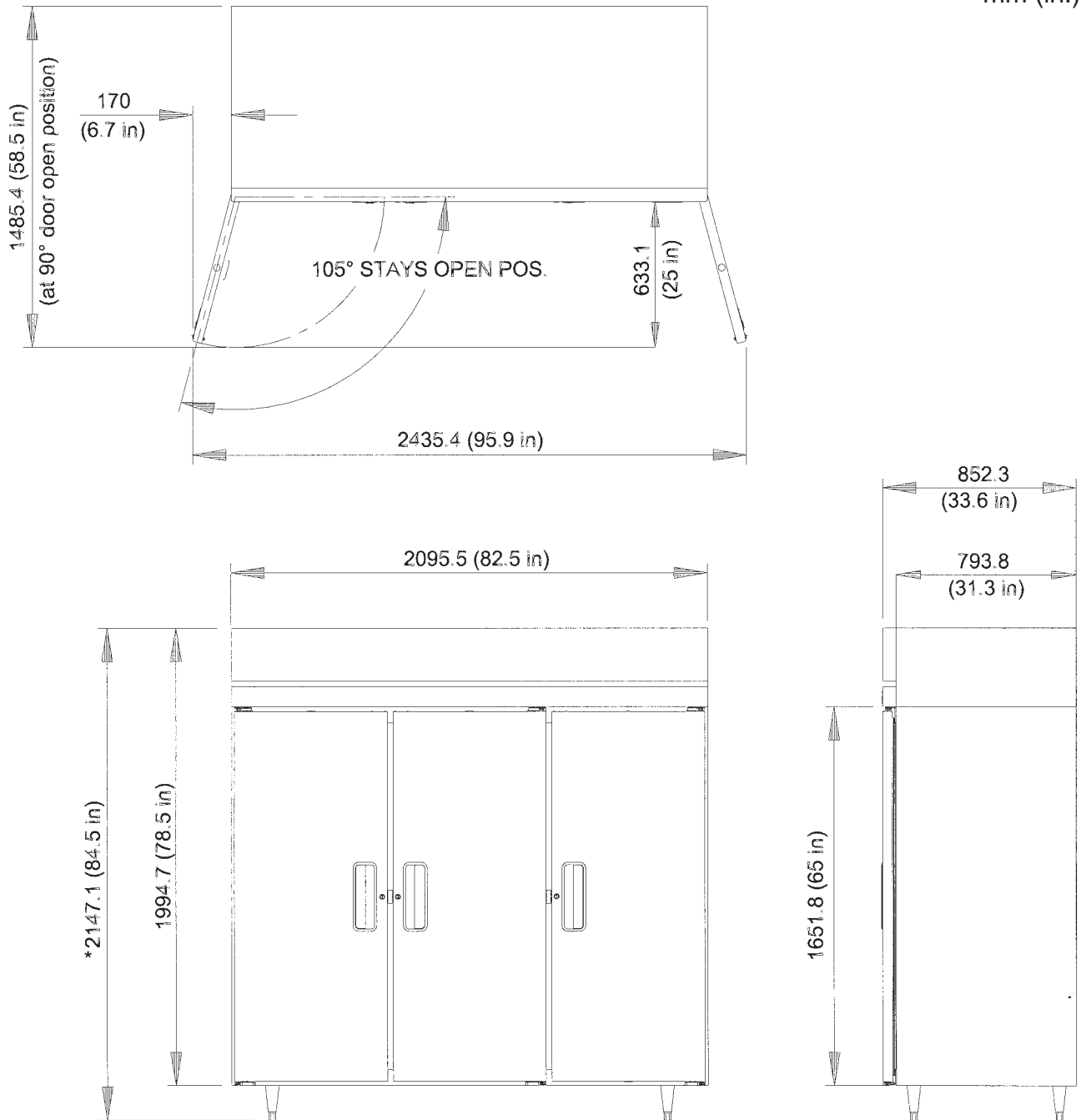

\* Shown with optional 6" legs; 4" casters are standard



---

## II. General Information

### A. Sequence of Operation and Timing Charts

#### 1. Refrigerator

##### a) Sequence of Operation

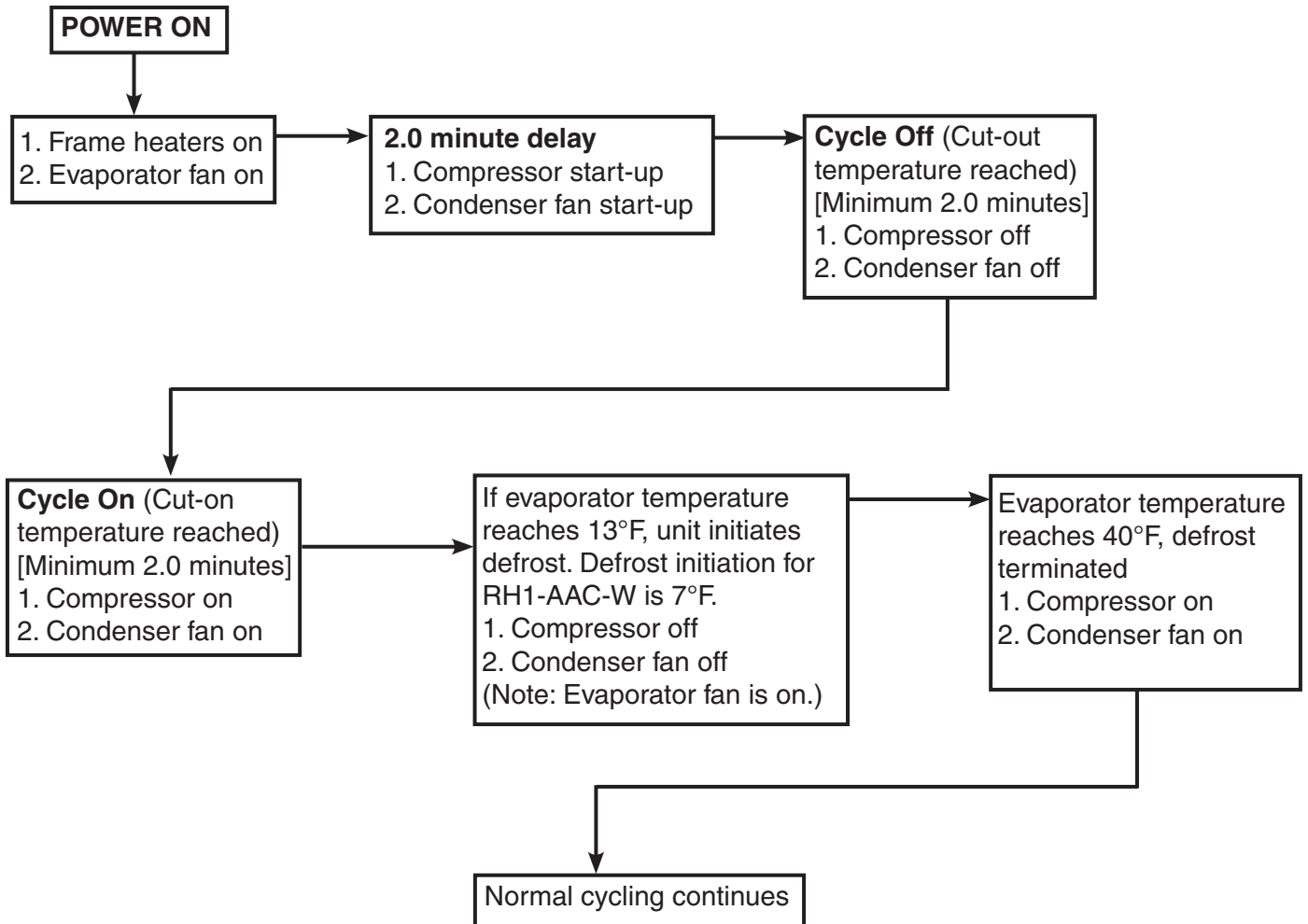

Note: The start circuit of the compressor is timed such that at power-up and during any compressor off time, there will be at least a 2 minute delay before the compressor will start. The compressor has a 2 minute minimum run time during every run cycle. The only exception is when the overload activates and deactivates.

**b) Timing Chart**  
For Refrigerator

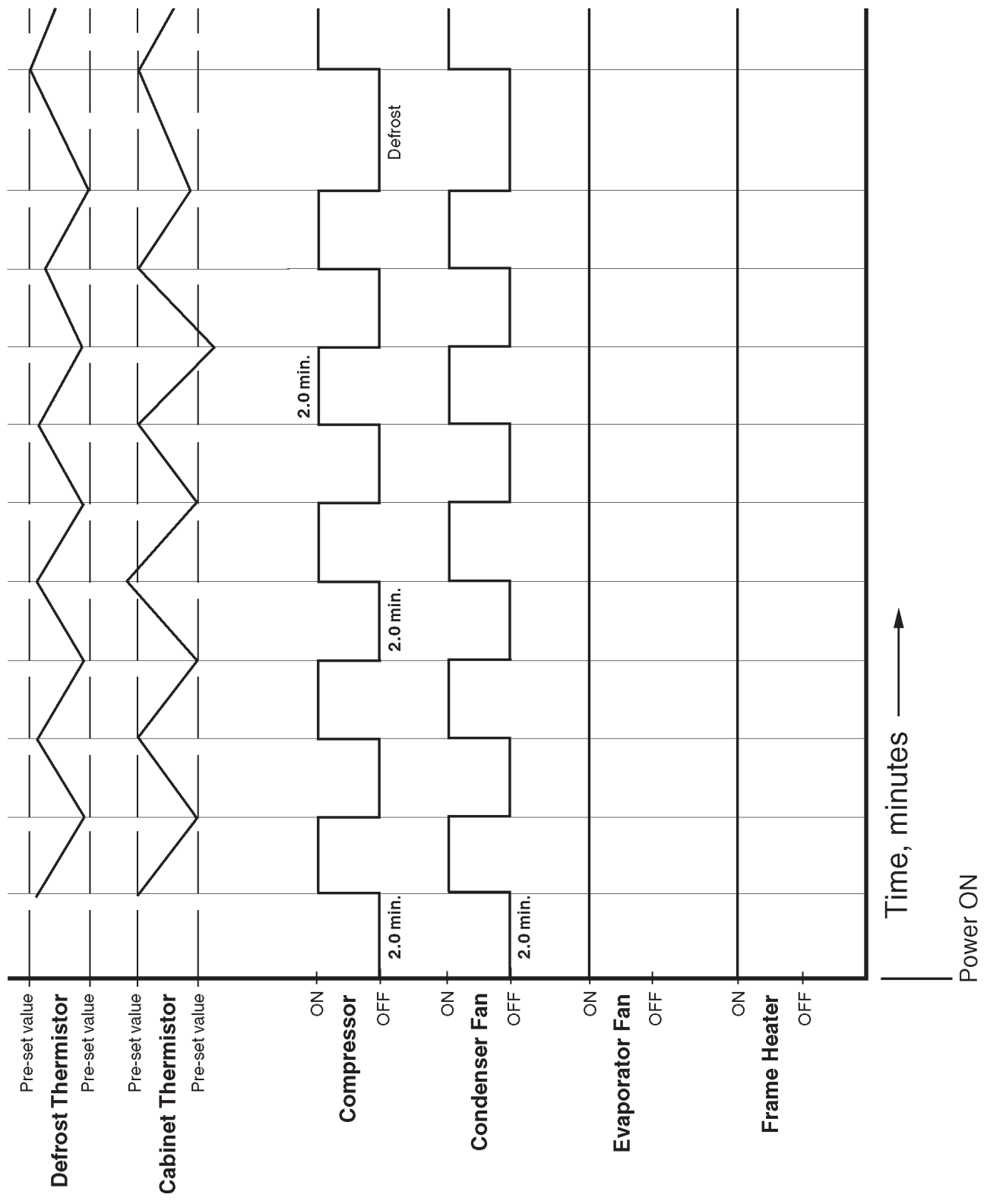

## 2. Freezer

### a) Sequence of Operation

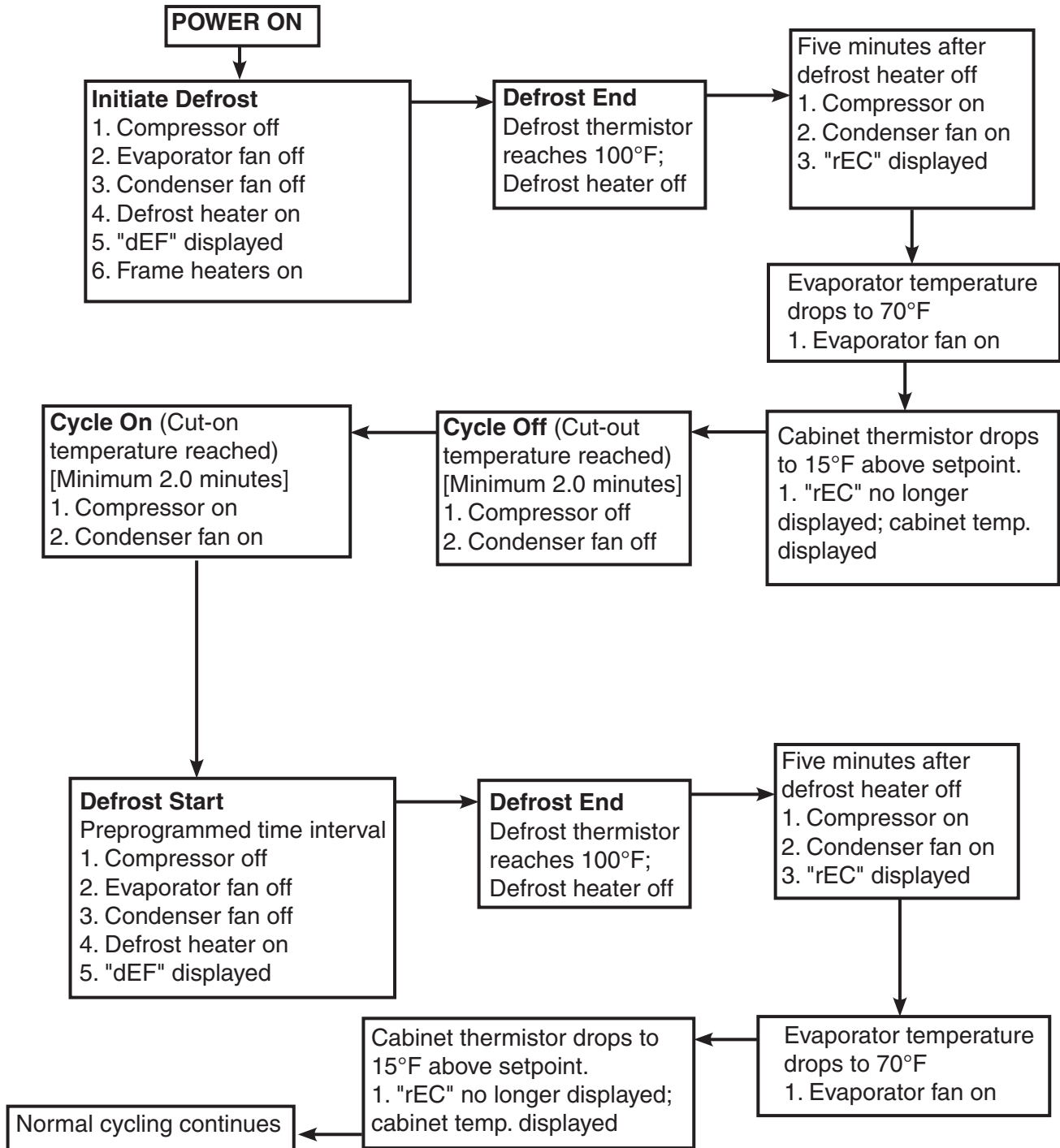

Note: For freezers, defrost will be initiated at power-up. To bypass initial defrost, press and hold the up arrow button on the control module while turning on the toggle switch. The display should read a temperature. There will be at least a 2 minute delay before the compressor will start even if the initial defrost cycle is bypassed. The compressor has a 2 minute minimum run time during every run cycle. The only exception is when the overload activates and deactivates.

**b) Timing Chart**  
For Freezer

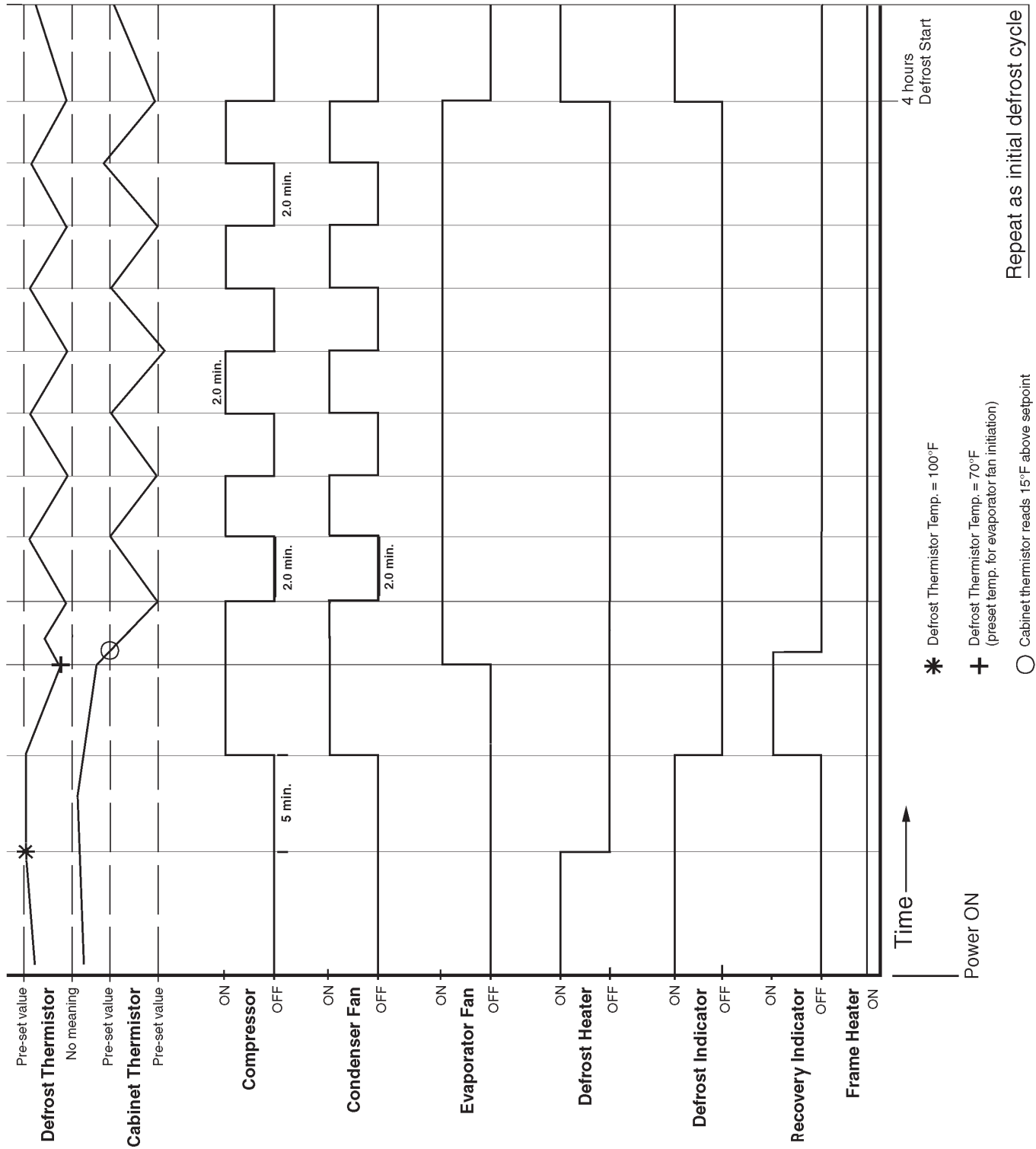

## B. Control Module

The control module for -AAC models is located on the face of the refrigeration circuit, behind the front panel. To open the front panel, swing the bottom of the panel up and allow the panel hinges to catch securely on the side panel frames in the locked position; the control module can then be accessed.

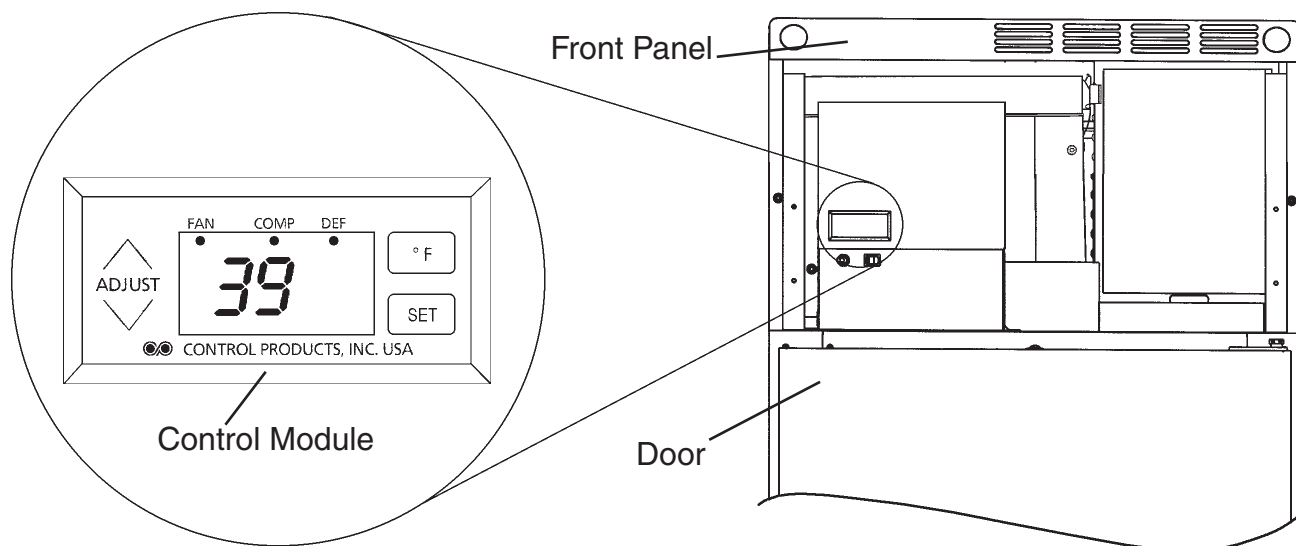

### 1. Settings and Adjustments.

#### a) *Current Temperature Display*

- The cabinet temperature is displayed on the control module. The cabinet temperature is displayed in °F only.
- The cabinet temperature is updated every 2 seconds.
- When the fan, compressor and defrost are initiated, the corresponding indicator lights will switch on.

#### b) *Temperature Setpoint*

The temperature setpoint is the temperature at which the compressor comes on. For refrigerators, the temperature differential for the compressor to turn off is 5°F below the setpoint. For freezers, the temperature differential for the compressor to turn off is 6°F below the setpoint. If necessary, adjust the setpoint temperature as follows:

- 1) Press "SET." The display reads: **SP1**
- 2) Press "SET." The display reads: **Current Setpoint**
- 3) Use the up/down arrows to change the setpoint. For refrigerators, the cabinet temperature is adjustable between 37°F and 55°F. The factory default is 39°F. For freezers, the cabinet temperature is adjustable between -10°F and 28°F. The factory default is -1°F for the FH1-AAC(-HD) and 0°F for the FH2-AAC(-HD).
- 4) Press "SET" to save. If no button is pressed in 15 seconds, the display will return to normal, and the setpoint will remain unchanged.

## c) Defrost

### (1) For Refrigerators

This unit uses an off-cycle defrost. A thermistor in the evaporator coil determines the need for a defrost. When the sensor reaches the initiation setpoint, the unit enters defrost. When the unit reaches the termination setpoint, the unit ends defrost. The off-cycle defrost requires no programming; it automatically initiates and terminates.

### (2) For Freezers

This unit is preset at the factory to defrost 6 times per day for general conditions. Please note that the defrost is a heated defrost, and therefore will have a tendency to raise the cabinet temperature. Cabinet temperature is not displayed during defrost; "dEF" is displayed in its place. Five minutes after defrost ends, the display changes to "rEC" (recovery period). Once the cabinet thermistor drops to 15°F above the setpoint, the display reverts back to cabinet temperature.

## 2. Service Menu

The menu may be used to view settings and the defrost thermistor temperature and to make adjustments to the defrost frequency.

To access this menu, press and hold the "°F" and down arrow buttons. Once released, you will have access to the menu. To advance to the next display press "°F". To store changed settings, you may either advance through all menus by pressing "°F" until you return to cabinet temperature, or you may press "SET". Either procedure will store changed settings and return to the cabinet temperature.

### WARNING

This unit has been factory tested with the default settings listed. If a value is changed from the default, field problems may result. If a value has been changed from the default and you need to change it back, use the up or down arrow buttons.

Display	Indication	Default	
		Refrigerator	Freezer
dIF	Next display is cabinet differential setting	-5°F	-6°F
-5	Indicates that the cabinet differential is set to -5°F.		
HI	Next display is the maximum allowable setpoint (from the setpoint menu).	55°F	28°F
55	Indicates that the maximum allowable setpoint is 55°F.		
LO	Next display is the minimum allowable setpoint (from the setpoint menu).	37°F	-10°F
37	Indicates that the minimum allowable setpoint is 37°F.		
CAL	Next display is for calibration of the thermistor.	NA	NA
0	Do not adjust, unless replacing thermistors.		

Display	Indication	Default	
		Refrigerator	Freezer
dEF	Next display after these is the defrost initiation temperature.	13°F (7°F for RH1-AAC-W)	NA
In1 (Refrigerator Only)			
13			
dEF	Next display after these is the defrost termination temperature.	40°F	NA
End (Refrigerator Only)			
40			
dEF	Next display after these is the number of hours between defrosts.	NA	Every 4 hours
Int (Freezer Only)			
4			
dEF	Next display after these is the maximum allowable time for a defrost. The freezer's target is to terminate before this value is reached. This value is a safety.	NA	60 min.
dUr (Freezer Only)			
60			
dEF	Next display after these is the defrost termination temperature. The freezer's target is to terminate at this value.	NA	100°F
HI (Freezer Only)			
100			
SHo	Next display after these is the short cycle timer. The short cycle time is the minimum time the compressor must remain off in an off cycle or on in an on cycle.	2.0 min.	2.0 min.
CyC			
2			
FAn	Next display after these is the re-initiation temperature of the evaporator fan after a defrost.	NA	70°F
HI (Freezer Only)			
0			
COI	Next display after these is the defrost sensor temperature.	NA	NA
SEn			
20			

## C. Thermistors

Thermistors (semiconductors) are used for cabinet temperature control and defrost termination. The resistance varies depending on temperature. No adjustment is required. If necessary, check for resistance between thermistor leads and visually check the thermistor mounting.

### 1. Cabinet Thermistor (SEN1: white and black leads)

This temperature reading can be identified by looking at the temperature shown on the display. However, in some cases the display may be reading "dEF". In this case turn the unit to the "OFF" position. Next press the up arrow button while turning the unit "ON" with the toggle switch. This will by-pass the initial defrost cycle and allows the display to show the cabinet thermistor reading. This temperature should correspond closely with the actual cabinet temperature.

### 2. Defrost Thermistor (SEN2: black and red leads)

This temperature reading can be found by entering the service menu. To access this menu, press and hold the "°F" and down arrow buttons. Once released, "dIF" is displayed and you have access to the menu. To advance to the next display, press the "°F" button. Press "°F" until "SEn" is displayed. Press "°F" one more time and this reading should be the evaporator coil temperature.

Note: This thermistor is mounted in the evaporator; therefore, when the machine is in the freeze cycle you will see temperatures that correspond to actual evaporator temperature.

### 3. Thermistor Check Procedure

- 1) Unplug the unit from the electrical outlet and disconnect thermistor leads on the control module.
- 2) Remove the thermistor.
- 3) Immerse the thermistor sensor portion in a glass containing ice water for 2 or 3 minutes.
- 4) Check for a resistance between thermistor leads. Replace the thermistor if it exceeds the normal reading. See "IV.I. Removal and Replacement of Thermistors."

Temperature		Resistance $\Omega$
°F	°C	
0	-17.8	704
10	-12.2	713
32	0.0	812
50	10.0	880
70	21.1	961
90	32.2	1,046



## **D. Compressor Protector**

When a combined temperature/amperage value is above the limit specified by the compressor manufacturer, a protector will operate independently, turning off the compressor. The compressor will restart when this protector has reset.

Note:

1. Compressor protector resets automatically.
2. If the condenser fan is operating and the compressor is off, it is likely that the protector has operated.

## **E. Safety Devices**

### **1. Pressure Switch**

When pressure on the high-side of the refrigeration circuit is detected to be above a preset limit, a pressure switch will activate causing power to be interrupted to the compressor relay. This power interruption will shut down the compressor. The pressure switch will reset automatically. When the pressure switch resets, power will be resupplied to the compressor. See "VI. Wiring Diagrams" for preset values.

### **2. Defrost Protection**

For freezers, primary defrost termination is controlled by the defrost thermistor. However, two additional safeties are also present:

- 1) Time Termination - 1 hour maximum
- 2) Safety Defrost Thermostat - In-line with the heaters and independent of the control module.

## **F. Perimeter Frame Heater**

This unit is equipped with a perimeter frame heater. This prevents the formation of condensate on the front frame of the unit under high humidity conditions. If operating the unit under conditions where condensate will not form, these heaters may be turned off using the switch on the control box.

### III. Service Diagnosis

#### A. Diagnosis Chart

Problem	Possible Cause	Remedy	
[1] Compressor will not start—no current draw.	a) Power Supply	1. "OFF" position.	1. Move to "ON" position.
		2. Loose connection.	2. Tighten.
		3. Failure.	3. Call electrician.
	b) Cord and Plug	1. Defective.	1. Replace.
	c) Ground Fault Circuit Interrupter	1. Tripped.	1. Check and reset.
		2. Defective.	2. Replace.
	d) Transformer	1. Open coil winding.	1. Check continuity and replace.
	e) Wiring to Control Module	1. Loose connection.	1. Tighten.
		2. Faulty.	2. Check continuity and replace.
	f) High Pressure Switch	1. Bad contacts.	1. Check continuity and replace.
	g) Thermistor	1. Defective.	1. See "II.C. Thermistors." Check and replace.
h) Control Module	1. Defective.	1. Replace control module.	
i) Compressor Overload	1. Defective (contacts open).	1. Replace.	
j) Compressor	1. Open windings.	1. Check continuity and replace.	
	k) Compressor Relay	1. Bad contacts.	1. Replace.
		2. Open coil winding.	2. Check and replace.
[2] Compressor will not run—draws current and trips on overload.	a) Voltage	1. Too low.	1. Call electrician.
	b) Start Relay	1. Bad contacts.	1. Replace.
		2. Open coil windings.	2. Replace.
	c) Compressor	1. Locked rotor.	1. Replace.
d) Start Capacitor	1. Defective.	1. Check and replace.	
[3] Compressor runs intermittently and trips on overload.	a) Voltage	1. Too low.	1. Call electrician.
		2. Too high.	2. Call electrician.
	b) Condenser Filter	1. Clogged.	1. Clean filter.
	c) Refrigerant Line or Component	1. Plugged or restricted.	1. Clean and replace drier.
	d) Condenser Fan Motor	1. Failed	1. Replace.
	e) Refrigerant	1. Overcharged.	1. Evacuate and recharge.
2. Non-condensibles in system.		2. Evacuate and recharge.	
f) Location of Unit	1. Restricted air flow to condenser.	1. Move unit or increase ventilation.	
[4] Cabinet temperature too high; compressor will not start.	a) Thermistor	1. Defective.	1. See "II.C. Thermistors." Check and replace.
	b) Compressor Relay	1. Defective.	1. Check and replace.
	c) Control Module	1. Defective.	1. Replace.

Problem	Possible Cause		Remedy
[5] Cabinet temperature too high.	a) Setpoint	1. Incorrect.	1. Correct setpoint. See "II.B.1.b) Temperature Setpoint."
	b) Door	1. Not sealing, or open for long intervals.	1. Check for sealing, check for door open at time of warm cabinet temperature.
	c) Defrost	1. Not enough defrosts occurring per day. Operation in humid conditions.	1. See "II.B.1.c) Defrost."
	d) Refrigerant	1. Leak.	1. Repair leak and recharge.
	e) Fan Motor	1. Defective.	1. Check and replace.
	f) Air Filter	1. Clogged.	1. Clean.
	g) Condenser	1. Dirty.	1. Clean.
	h) Thermistor	1. Defective.	1. See "II.C. Thermistors." Check and replace.
	i) Control Module	1. Defective.	1. Replace.
[6] Cabinet temperature display indicator does not illuminate properly.	a) Control Module	1. Defective.	1. Replace.
[7] Cabinet temperature too low.	a) Thermistor	1. Defective.	1. See "II.C. Thermistors." Check and replace.
	b) Compressor Relay	1. Defective; contacts welded.	1. Replace.
	c) Control Module	1. Defective.	1. Replace.
[8] Evaporator does not defrost completely.	a) Defrost Thermistor	1. Defective.	1. See "II.C. Thermistors." Check and replace.
	b) Defrost	1. Not enough defrosts occurring per day. Operation in humid conditions.	1. See "II.B.1.c) Defrost."
	c) Defrost Heaters (freezers only)	1. Defective.	1. Replace heaters.
	d) Safety Defrost Thermostat (freezers only)	1. Defective, turning off heaters prematurely, or fused open.	1. Replace safety defrost thermostat.
[9] Defrost cycle lasts too long.	a) Defrost Thermistor	1. Defective.	1. Replace.
	b) Control Module.	1. Defective.	1. Replace.
	c) Defrost	1. Not enough defrosts occurring per day. Operation in humid conditions.	1. See "II.B.1.c) Defrost."
	d) Defrost Heaters. (freezers only)	1. Defective.	1. Replace heaters.
	e) Safety Defrost Thermostat (freezers only)	1. Defective, turning off heaters prematurely, or fused open.	1. Replace safety defrost thermostat.

Problem	Possible Cause		Remedy
[10] Condensate water overflow.	a) Cabinet Contents	1. Loading of large volumes of warm, moist, uncovered product.	1. Cover product with plastic wrap.
	b) Location of Unit	1. Unit located near high humidity source such as fryer, steamer, etc.	1. Relocate.
	c) Seals	1. Poor sealing around evaporator, door gaskets.	1. Adjust or replace.
	d) Environment	1. Extreme environment and door-opening conditions.	1. Adjust conditions.
[11] Abnormal Noise	a) Fasteners	1. Loose fasteners allow vibration of part.	1. Tighten fasteners.
	b) Compressor	1. Problem with mount.	1. Properly mount compressor. Replace any missing grommets.
		2. Floodback to compressor.	2. Check for signs of floodback to compressor. Evacuate and recharge if necessary.
		3. Defective.	3. Replace.
	c) Fan	1. Fan blade loose.	1. Adjust and tighten.
		2. Defective motor.	2. Replace.
d) Relay	1. Chattering.	1. Replace.	

---

## IV. Removal and Replacement of Components

### IMPORTANT

1. Ensure all components, fasteners and thumbscrews are securely in place after the equipment is serviced.
2. The Polyol Ester (POE) oils used in R-134a and R-404A units can absorb moisture quickly. Therefore it is important to prevent moisture from entering the system when replacing or servicing parts.
3. Always install a new drier every time the sealed refrigeration system is opened. Do not replace the drier until after all other repair or replacement has been made.
4. Do not leave the system open for longer than 15 minutes when replacing or servicing parts.

### A. Service for Refrigerant Lines

#### WARNING

Do not use R-134a or R-404A as a mixture with pressurized air for leak testing. Refrigerant leaks can be detected by charging the unit with a trace of refrigerant, raising the pressure with nitrogen and using an electronic leak detector.

#### 1. Refrigerant Recovery

The unit is provided with refrigerant access valves. Using proper refrigerant practices recover the refrigerant from the access valves and store it in an approved container. Do not discharge the refrigerant into the atmosphere.

#### 2. Brazing

#### WARNING

1. Refrigerants R-134a and R-404A themselves are not flammable at atmospheric pressure and temperatures up to 212°F (100°C) for R-134a and 176°F (80°C) for R-404A.
2. Refrigerants R-134a and R-404A themselves are not explosive or poisonous. However, when exposed to high temperatures (open flames) R-134a and R-404A can be decomposed to form hydrofluoric acid and carbonyl fluoride both of which are hazardous.
3. Always recover the refrigerant and store it in an approved container. Do not discharge the refrigerant into the atmosphere.
4. Do not use silver alloy or copper alloy containing arsenic.
5. Do not use R-134a or R-404A as a mixture with pressurized air for leak testing. Refrigerant leaks can be detected by charging the unit with a trace of refrigerant, raising the pressure with nitrogen and using an electronic leak detector.

- 1) Always install a new drier every time the sealed refrigeration system is opened. Do not replace the drier until after all other repair or replacement has been made. Install the new drier with the arrow on the drier in the direction of the refrigerant flow.
- 2) Braze all fittings while purging with nitrogen gas flowing at a pressure of 3 to 4 PSIG.
- 3) Check for leaks using nitrogen gas (140 PSIG) and soap bubbles. Do not use R-134a or R-404A as a mixture with pressurized air for leak testing. Refrigerant leaks can be detected by raising the pressure with nitrogen and a trace of refrigerant, using an electronic leak detector.

Note: Because the pipes in the evaporator case are specially coated to resist corrosion, it is important to make connections outside the evaporator case when possible. If it is necessary to braze inside the evaporator case, use sandpaper to remove the coating from the brazing connections before unbrazing the components.

### 3. Evacuation and Recharge [R-134a, R-404A]

- 1) Attach a vacuum pump to the system. Be sure the charging hoses are connected to both high and low-side lines.

#### **IMPORTANT**

The vacuum pump may be the same as those for current refrigerants. However, the rubber hose and gauge manifold to be used for evacuation and refrigerant charge should be exclusively for POE oils.

- 2) Turn on the vacuum pump. Never allow the oil in the vacuum pump to flow backward.
- 3) Allow the vacuum pump to pull down to a 29.9" Hg vacuum. Evacuating period depends on pump capacity.
- 4) Close the low-side valve and high-side valve on the service manifold.
- 5) Disconnect the vacuum pump, and attach a refrigerant service cylinder to the high-side line. Remember to loosen the connection and purge the air from the hose. See the nameplate for the required refrigerant charge. Hoshizaki recommends only virgin refrigerant or reclaimed refrigerant which meets ARI Standard No. 700-88 be used.
- 6) A liquid charge is recommended for charging an R-134a or R-404A system. Invert the service cylinder and place it on scales. Open the high-side, service manifold valve.
- 7) Allow the system to charge with liquid until the proper charge weight is met.
- 8) If necessary, add any remaining charge to the system through the low-side. Use a throttling valve or liquid dispensing device to add the remaining liquid charge through the low-side access port with the unit running.
- 9) Close the two refrigerant access valves and disconnect the hoses and service manifold.
- 10) Cap the access valves to prevent a possible leak.

## B. Removal and Replacement of Compressor

### IMPORTANT

Always install a new drier every time the sealed refrigeration system is opened. Do not replace the drier until after all other repair or replacement has been made. Install the new drier with the arrow on the drier in the direction of the refrigerant flow.

Note: When replacing a compressor with a defective winding, be sure to install the new start capacitor and start relay supplied with the replacement compressor. Due to the ability of the POE oil in the compressor to absorb moisture quickly, the compressor must not be opened more than 15 minutes for replacement or service. Do not mix lubricants of different compressors even if both are charged with R-134a or R-404A, except when they use the same lubricant.

- 1) Unplug the unit from the electrical outlet.
- 2) Remove the panels.
- 3) Recover the refrigerant and store it in an approved container.
- 4) Remove the terminal cover on the compressor, and disconnect the compressor wiring.
- 5) Remove the hold-down bolts, washers, rubber grommets and sleeves.
- 6) Remove the discharge and suction pipes.
- 7) Remove the compressor. Unpack the new compressor package.
- 8) Attach the rubber grommets of the prior compressor.
- 9) Place the compressor in position and secure it using the bolts and washers.
- 10) Remove the drier, then place the new drier in position.
- 11) Remove plugs from the suction, discharge and process pipes.
- 12) Braze all fittings while purging with nitrogen gas flowing at a pressure of 3 to 4 PSIG.
- 13) Check for leaks using nitrogen gas (140 PSIG) and soap bubbles.
- 14) Evacuate the system, and charge it with refrigerant. See the nameplate for the required refrigerant charge.
- 15) Connect the terminals and replace the terminal cover in its correct position.
- 16) Replace the panels in their correct positions.
- 17) Plug the unit back in.

## C. Removal and Replacement of Expansion Valve

### IMPORTANT

Sometimes moisture in the refrigeration circuit exceeds the drier capacity and freezes up at the expansion valve. Always install a new drier every time the sealed refrigeration system is opened. Do not replace the drier until after all other repair or replacement has been made. Install the new drier with the arrow on the drier in the direction of the refrigerant flow.

- 1) Unplug the unit from the electrical outlet.
- 2) Remove the panels.
- 3) Recover the refrigerant and store it in an approved container.
- 4) Remove the insulation and the expansion valve bulb on the suction line.
- 5) Remove the expansion valve cover and disconnect the expansion valve. Place the new expansion valve in position.
- 6) Remove the drier, then place the new drier in position.
- 7) Braze all fittings while purging with nitrogen gas flowing at a pressure of 3 to 4 PSIG.

### WARNING

Always protect the valve body by using a damp cloth to prevent the valve from overheating. Do not braze with the valve body exceeding 250°F (121°C).

- 8) Check for leaks using nitrogen gas (140 PSIG) and soap bubbles.
- 9) Evacuate the system, and charge it with refrigerant. See the nameplate for the required refrigerant charge.
- 10) Attach the expansion valve bulb to the suction line in the same location as the previous bulb. The bulb should be at the 12 o'clock position on the tube. Be sure to secure the bulb with the clamp and holder and to insulate it.
- 11) Place the expansion valve cover in position.
- 12) Replace the panels in their correct positions.
- 13) Plug the unit back in.



## D. Removal and Replacement of Evaporator

### IMPORTANT

Always install a new drier every time the sealed refrigeration system is opened. Do not replace the drier until after all other repair or replacement has been made. Install the new drier with the arrow on the drier in the direction of the refrigerant flow.

- 1) Unplug the unit from the electrical outlet.
- 2) Remove the panels and the top cover over the evaporator.
- 3) Recover the refrigerant and store it in an approved container.
- 4) Remove the insulation tubing, and disconnect the evaporator inlet and outlet tubing. Elevate the evaporator to avoid overheating the evaporator housing.
- 5) Place the new evaporator in position.
- 6) Remove the drier, then place the new drier in position.
- 7) Check for leaks using nitrogen gas (140 PSIG) and soap bubbles.
- 8) Evacuate the system, and charge it with refrigerant. See the nameplate for the required refrigerant charge.
- 9) Replace the removed parts in the reverse order of which they were removed.
- 10) Replace the top cover and the panels in their correct positions.
- 11) Plug the unit back in.

## E. Removal and Replacement of Door Gasket

### CAUTION

In order to get a proper gasket fit, it is important not to stretch gasket material during assembly.

- 1) Remove old gasket by pulling it directly out of the vinyl gasket retainer.
- 2) Thoroughly clean the gasket area with mild soap and water prior to installing the new gasket.
- 3) The new gasket should be installed by assembling it at the corners first, then working toward the center at the top, bottom and sides.
- 4) The arrow-shaped portion of the gasket should be firmly seated in the retainer groove for proper assembly. This can be checked by lifting the edge of the gasket and observing the engagement.

## F. Removal and Replacement of Door Closure Spring

### CAUTION

Wear eye protection and use caution when removing the tension screw (step 3).

- 1) Open the front panel assembly to gain access to the upper hinge brackets.
- 2) Remove the bushing cover from the top of the spring cartridge assembly.

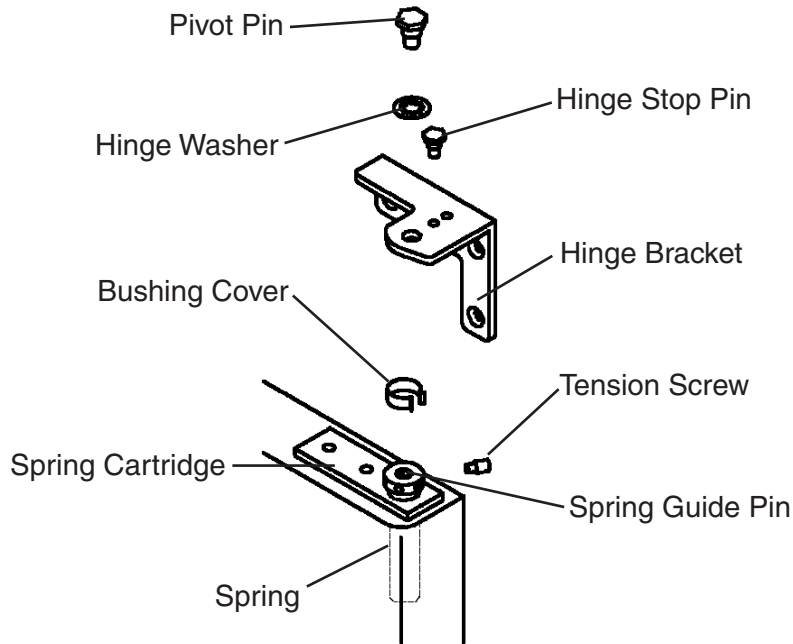

- 3) Insert a small drift pin or long leg of an allen wrench into one of the threaded tension screw holes in the spring guide pin. Turn the spring guide pin to access the tension screw. Securely hold the spring guide pin in this position while removing the tension screw. Carefully rotate (walk) the spring guide pin to release spring tension.
- 4) Use a 1/2" socket wrench to remove the top pivot pin and hinge washer from the top hinge bracket.
- 5) Firmly grasp the door and pull it forward at the top. Then raise the door, disengaging it from the bottom pivot pin.
- 6) Remove the spring guide pin and spring from the spring cartridge.
- 7) Replace the spring with one of the same color. Be certain that the spring ends are engaged in both the spring cartridge and the top of spring guide pin.
- 8) Repeat steps 1 through 7 for additional doors as necessary.
- 9) Reverse procedure to reassemble door(s) to cabinet.

Side	Color	Part Number
Left	Blue	4A3312-02
Right	Black	4A3312-01

Note: Tighten spring guide pin one complete rotation to set proper spring tension.

## G. Door Re-Hinging

The door on any unit is reversible as shown below. Depending on the model and door configuration, instructions for re-hinging the door(s) will vary. Instructions for re-hinging are provided in the kits listed below.

Convert	Door Type	Kit Number
Right to Left	Full	HS-3527
Left to Right	Full	HS-3528
Right to Left	Half	HS-3529
Left to Right	Half	HS-3530

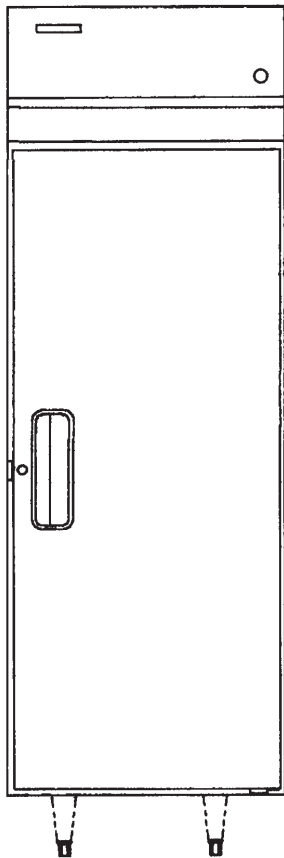

The door hinges on the right cabinet wall.

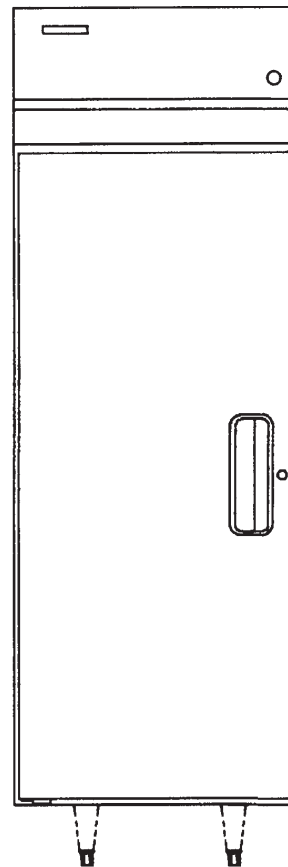

The door is rotated and hinged on the left cabinet wall.

## H. Removal and Replacement of Control Module

### IMPORTANT

1. Both thermistors, cabinet and defrost, must be replaced with the ones supplied by the factory with the replacement control module.
2. Thermistors are factory calibrated to the new control module. No control module calibration is needed.
3. When connecting wires to the control module terminals, make sure that no wire strands are touching neighboring wires. Otherwise, the unit may not operate correctly.

- 1) Unplug the unit from the electrical outlet.
- 2) Remove the panels and the top cover over the evaporator.
- 3) Open the control box cover.
- 4) Unhook all wiring connections to the control module.
- 5) Remove the control module by carefully squeezing the mounting tabs and pushing the control module through the front of the control box.
- 6) Remove the cabinet thermistor. Route the cabinet thermistor (white and black) in the same manner as the original one.  
Note: It may be helpful to pull the wire leads of the new thermistor through the protective sheathing at the condenser using the old thermistor.
- 7) Connect the new cabinet thermistor leads (white and black) to the terminals of SEN1. Connect the white lead to terminal "S" and the black lead to terminal "G".  
Note: There is a blank terminal between terminals "S" and "G".
- 8) Remove the defrost thermistor (red and black) from the evaporator. Route the replacement defrost thermistor using the same routing as the original. Be careful not to pull or damage the metal end cap of the thermistor sensor. Wire tie the thermistor wiring to the plastic clip. To prevent condensate water from running into the thermistor, provide a low point in the wiring below the thermistor.
- 9) Connect the new defrost thermistor leads (red and black) to the terminals of SEN2. Connect the red lead to terminal "S" and the black lead to terminal "G".
- 10) Tie the excess thermistor wire length together and place it behind the control box. Insert the new control module into the front of the control box taking care not to damage it.
- 11) Hook all wiring connections back to the control module. Be sure wires are not touching at the terminal block.
- 12) Replace all parts and panels in their correct positions.
- 13) Plug the unit back in.

## I. Removal and Replacement of Thermistors

### IMPORTANT

When replacing a faulty thermistor, it is necessary to:

- a) Verify the control module calibration.
- b) Replace both the cabinet and defrost thermistors.

- 1) Unplug the unit from the electrical outlet.
- 2) Remove the panels and the top cover over the evaporator.
- 3) Open the control box cover.
- 4) Disconnect all thermistor leads from the control module.

### 1. Determine Control Module Calibration

Note: The control module has been factory adjusted to the original thermistors.

Therefore, calibration must be checked and adjusted when replacing thermistors only.

- 5) Connect the new defrost thermistor leads to the terminals of SEN2. The red lead connects to terminal "S" and the black lead connects to terminal "G". Be sure wires are not touching at the terminal block.
- 6) Connect the 32°F resistor (included in HS-3540 kit) to SEN1 terminals "G" and "S".
- 7) Securely close the control box cover.
- 8) Plug the unit back in.
- 9) Press and hold the up arrow button on the control module while turning the power switch to the "ON" position. Temperature is displayed.
- 10) If the display reads 32°F, the control module is properly calibrated. Skip to step 20. If the display does not read 32°F, the control module must be reset and calibrated. Continue to step 11.

### 2. Reset Control Module

- 11) Enter the menu for the control module by pressing the down arrow button and the "°F" button at the same time and release. The display should now read "dIF." Press the "°F" button until it reads "CAL" - press "°F" once more it should read "00."
- 12) If it **does** read "00" skip to step 15. If it **does not** read "00" press the up or down arrow button to change it to "00."
- 13) Press the "SET" button and wait for the temperature display to stabilize.
- 14) If the control reads 32°F, the control is properly calibrated. Skip to step 20. If the control does not read 32°F, the control module must be calibrated. Continue to step 15.

### 3. Calibrate Control Module

- 15) Make a note of the display temperature.
- 16) Enter the menu for the control module by pressing the down arrow button and the "°F" button at the same time and release. The display should now read "dIF." Press the "°F" button until it reads "CAL" - press "°F" once more it should read "00."
- 17) Press the up or down arrow button to change "00" to the number in the chart below that corresponds to the display temperature noted at step 15.

If temperature is:	Change 00 in Cal (Step 1)
28°F	04
29°F	03
30°F	02
31°F	01
32°F	Do Not Change
33°F	-01
34°F	-02
35°F	-03
36°F	-04

- 18) Press the "SET" button and wait for the temperature display to stabilize.
- 19) If the display reads 32°F, the control is properly calibrated. Go to step 20. If the display does not read 32°F, restart from step 11.

### 4. Thermistor Installation

- 20) Place the power switch in the "OFF" position.
- 21) Unplug the unit from the electrical outlet.
- 22) Open the control box cover and gain access to the back of the control module.
- 23) Remove the calibration resistor.
- 24) Remove the cabinet thermistor. Install the new cabinet thermistor. Route the cabinet thermistor (white and black) in the same manner as the original one.  
Note: It may be helpful to pull the wire leads of the new thermistor through the protective sheathing at the condenser using the old thermistor.
- 25) Connect the new cabinet thermistor leads (white and black) to the terminals of SEN1. Connect the white lead to terminal "S" and the black lead to terminal "G".  
Note: There is a blank terminal between terminals "S" and "G".
- 26) Remove the defrost thermistor (red and black) from the evaporator. Route the replacement defrost thermistor using the same routing as the original. Be careful not to pull or damage the metal end cap of the thermistor sensor. Wire tie the thermistor wiring to the plastic clip. To prevent condensate water from running into the thermistor, provide a low point in the wiring below the thermistor.
- 27) Connect the new defrost thermistor leads (red and black) to the terminals of SEN2. Connect the red lead to terminal "S" and the black lead to terminal "G".

- 28) Tie the excess thermistor wire length together and place it behind the control box.
- 29) Connect all wiring to the control module. Be sure wires are not touching at the terminal block connection.
- 30) Replace all parts and panels in their correct positions.
- 31) Plug the unit back in.

---

## V. Cleaning Instructions

### 1. Exterior

Wipe the exterior occasionally with a clean, soft cloth. Use a damp cloth containing a neutral cleaner to wipe off oil or dirt build up.

### 2. Interior

Spills should be wiped up promptly to avoid unpleasant odors. The cabinet interior should be cleaned periodically with a mild soap or detergent.

### 3. Door Gaskets

Both door gaskets should be cleaned regularly with mild soap and water to remove dirt and grease.

### 4. Air Filter

Check the filter at least once a month. If it is dirty, use warm water and a neutral cleaner to wash the filter. The filter is located behind the upper front panel. This filter can be removed by bending the condenser filter bracket back, sliding the filter up and out and allowing the bracket spring back into place.

### 5. Condenser

Check the condenser once a year and use a brush or vacuum cleaner to clean the unit as required.

Condenser Filter Bracket

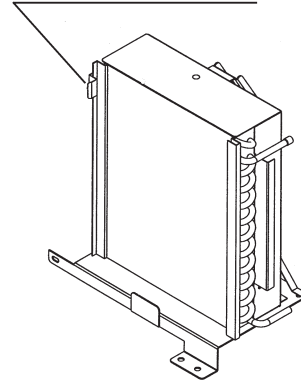



# VI. Wiring Diagrams

## A. RH1-AAC(-HD)

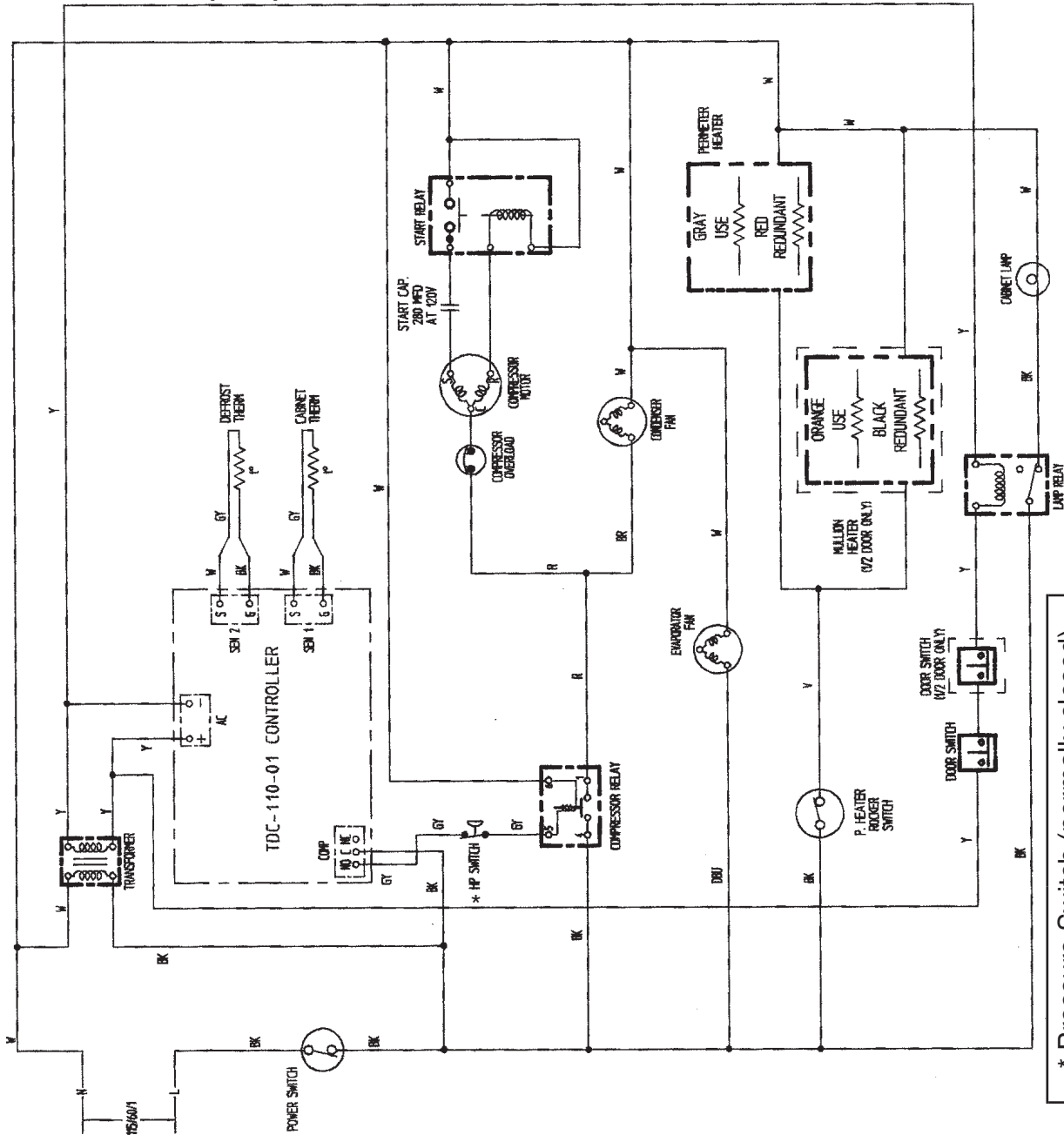

* Pressure Switch (normally closed)	
Cut-out (open)	270±10 PSIG
Cut-in (closed)	190±20 PSIG

WIRE COLOR CODE	
BR	BROWN
W	WHITE
BK	BLACK
R	RED
O	ORANGE
GY	GRAY
P	PINK
DBL	DARKBLUE
V	VIOLET
Y	YELLOW
LB	LIGHTBLUE

**CAUTION**

Before diagnosing and/or servicing the unit, confirm that you have the proper wiring diagram by checking against the diagram located on the evaporator case cover.

## B. RH2-AAC(-HD)

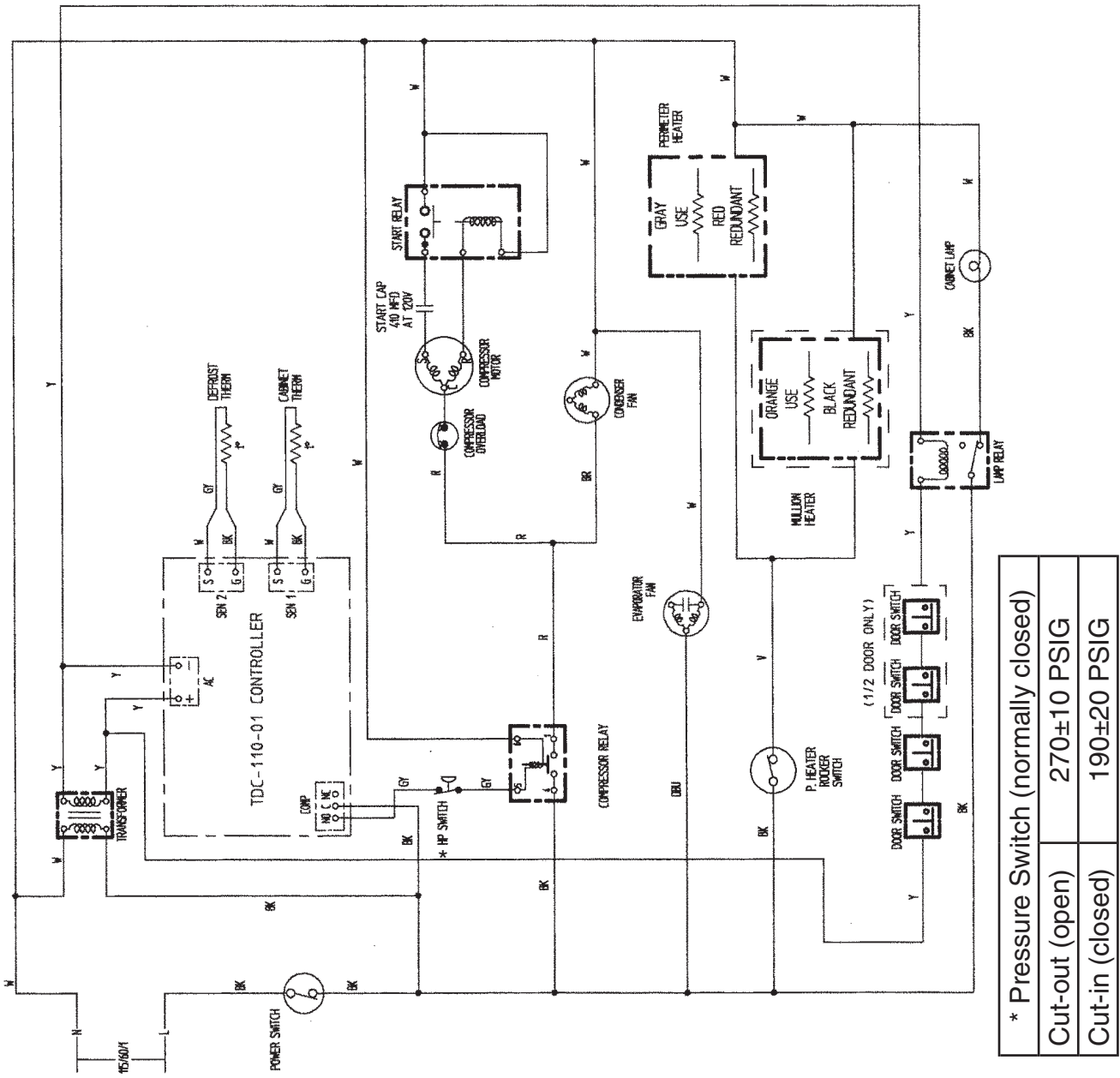

WIRE COLOR CODE

BR	BROWN
W	WHITE
BK	BLACK
R	RED
O	ORANGE
GR	GRAY
P	PINK
DBL	DARKBLUE
V	VIOLET
Y	YELLOW
BRU	LIGHTBLUE

* Pressure Switch (normally closed)	
Cut-out (open)	270±10 PSIG
Cut-in (closed)	190±20 PSIG

**CAUTION**

Before diagnosing and/or servicing the unit, confirm that you have the proper wiring diagram by checking against the diagram located on the evaporator case cover.

# C. RH3-AAC(-HD)

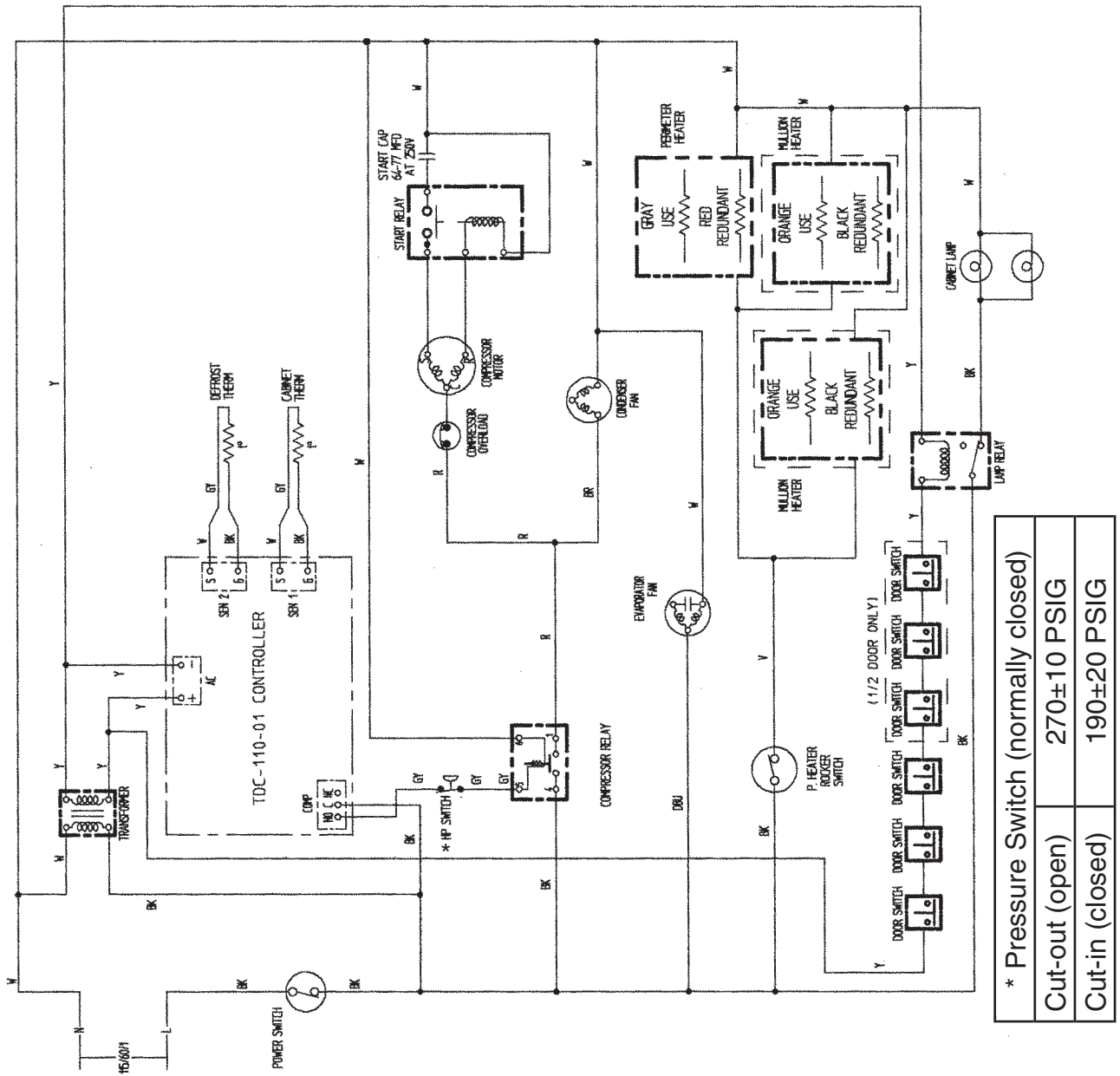

WIRE COLOR CODE

BR	BROWN
W	WHITE
BK	BLACK
R	RED
O	ORANGE
GY	GRAY
P	PINK
DBU	DARKBLUE
V	VIOLET
Y	YELLOW
LBLU	LIGHTBLUE

* Pressure Switch (normally closed)	
Cut-out (open)	270±10 PSIG
Cut-in (closed)	190±20 PSIG

## CAUTION

Before diagnosing and/or servicing the unit, confirm that you have the proper wiring diagram by checking against the diagram located on the evaporator case cover.

# D1. FH1-AAC(-HD) (auxiliary code P-7 and earlier)

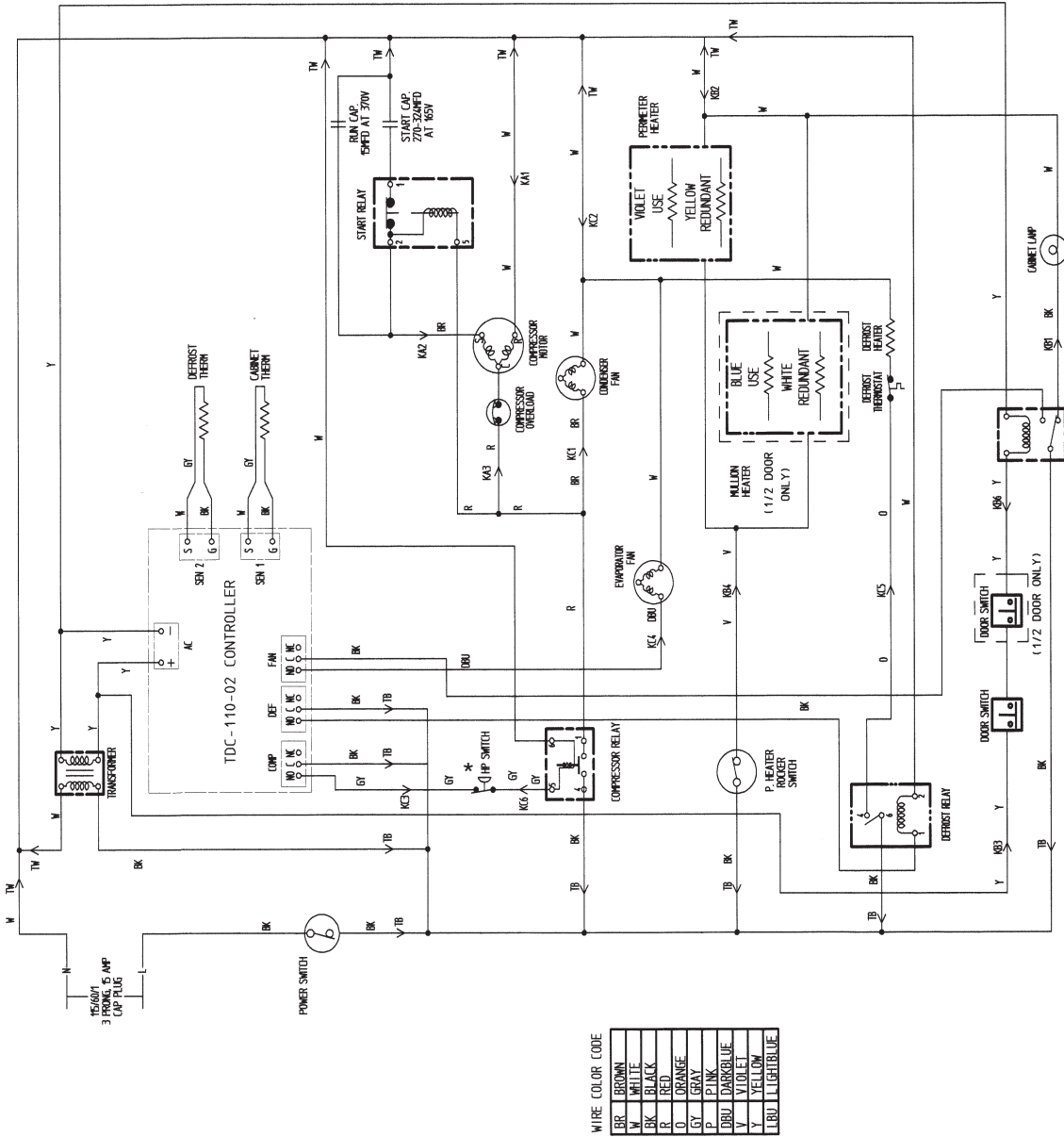

* Pressure Switch (normally closed)	
Cut-out (open)	490±10 PSIG
Cut-in (closed)	370±20 PSIG

**CAUTION**

Before diagnosing and/or servicing the unit, confirm that you have the proper wiring diagram by checking against the diagram located on the evaporator case cover.

## D2. FH1-AAC(-HD) (auxiliary code P-8 and later)

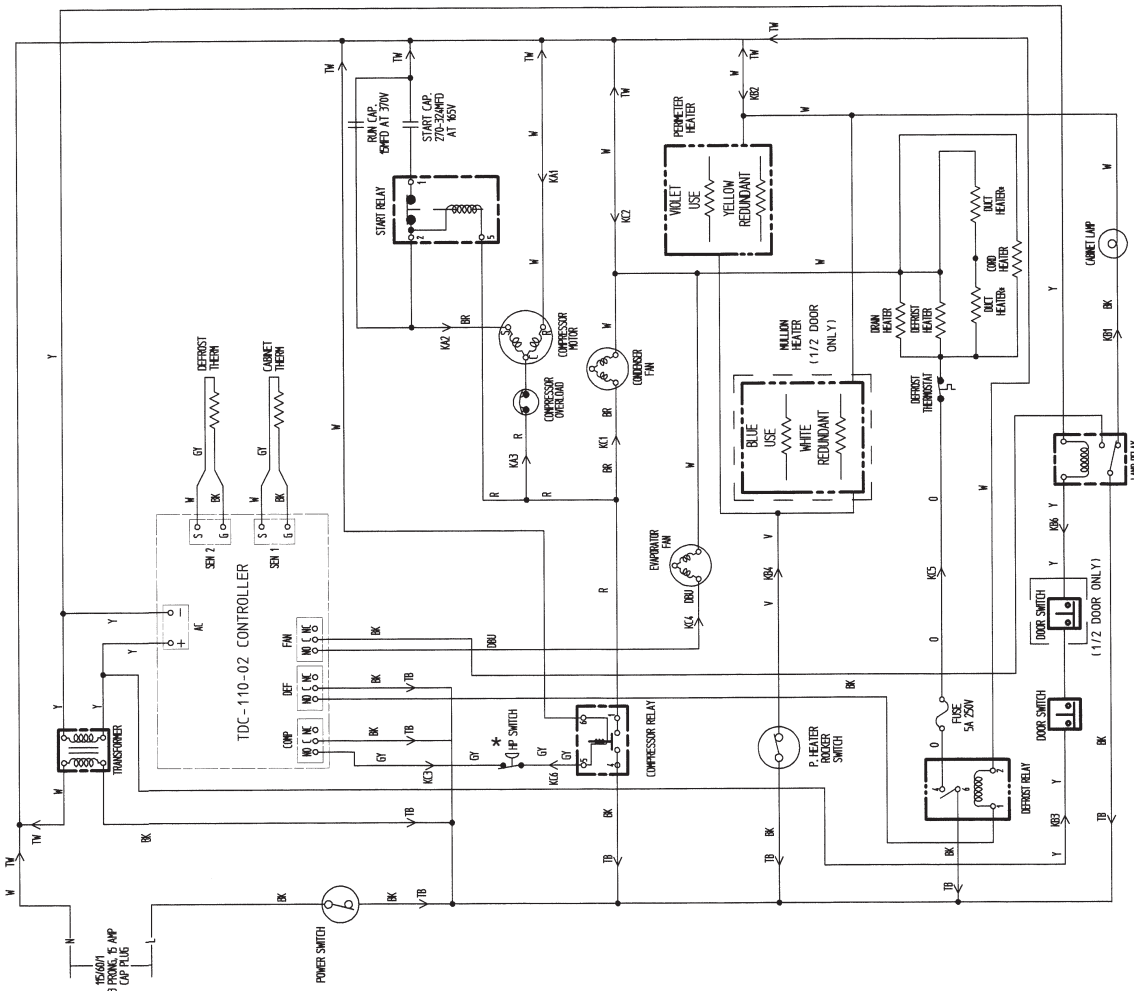

\* DUCT HEATERS MUST BE WIRED IN SERIES.

WIRE COLOR CODE

BR	BROWN
W	WHITE
BLK	BLACK
R	RED
OR	ORANGE
GRY	GRAY
P	PINK
DBLU	DARKBLUE
V	VIOLET
Y	YELLOW
LBLU	LIGHTBLUE

* Pressure Switch (normally closed)	
Cut-out (open)	490±10 PSIG
Cut-in (closed)	370±20 PSIG

**CAUTION**

Before diagnosing and/or servicing the unit, confirm that you have the proper wiring diagram by checking against the diagram located on the evaporator case cover.

# E1. FH2-AAC(-HD) (auxiliary code P-5 and earlier)

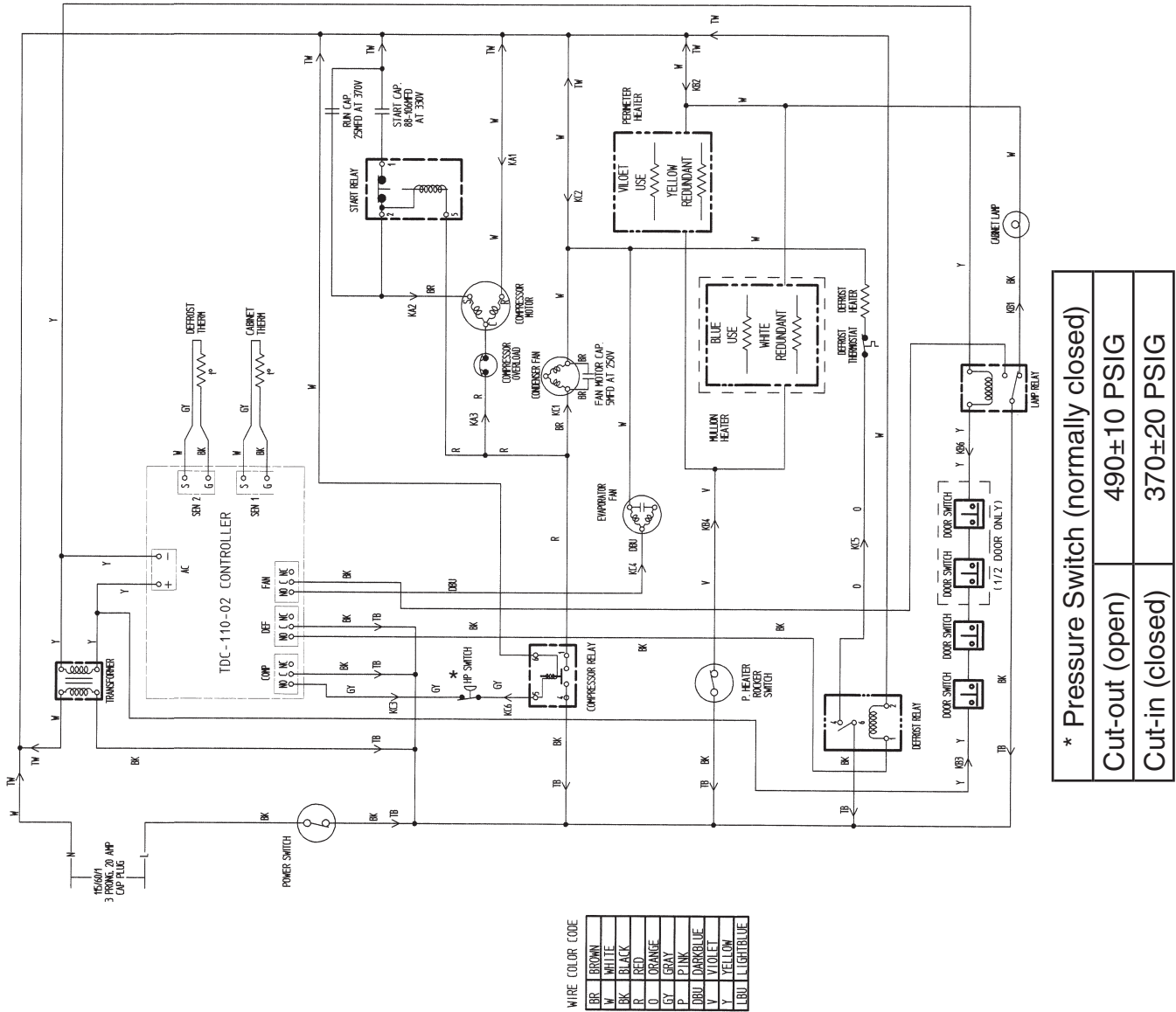

**CAUTION**

Before diagnosing and/or servicing the unit, confirm that you have the proper wiring diagram by checking against the diagram located on the evaporator case cover.

## E2. FH2-AAC(-HD) (auxiliary code P-6 and later)

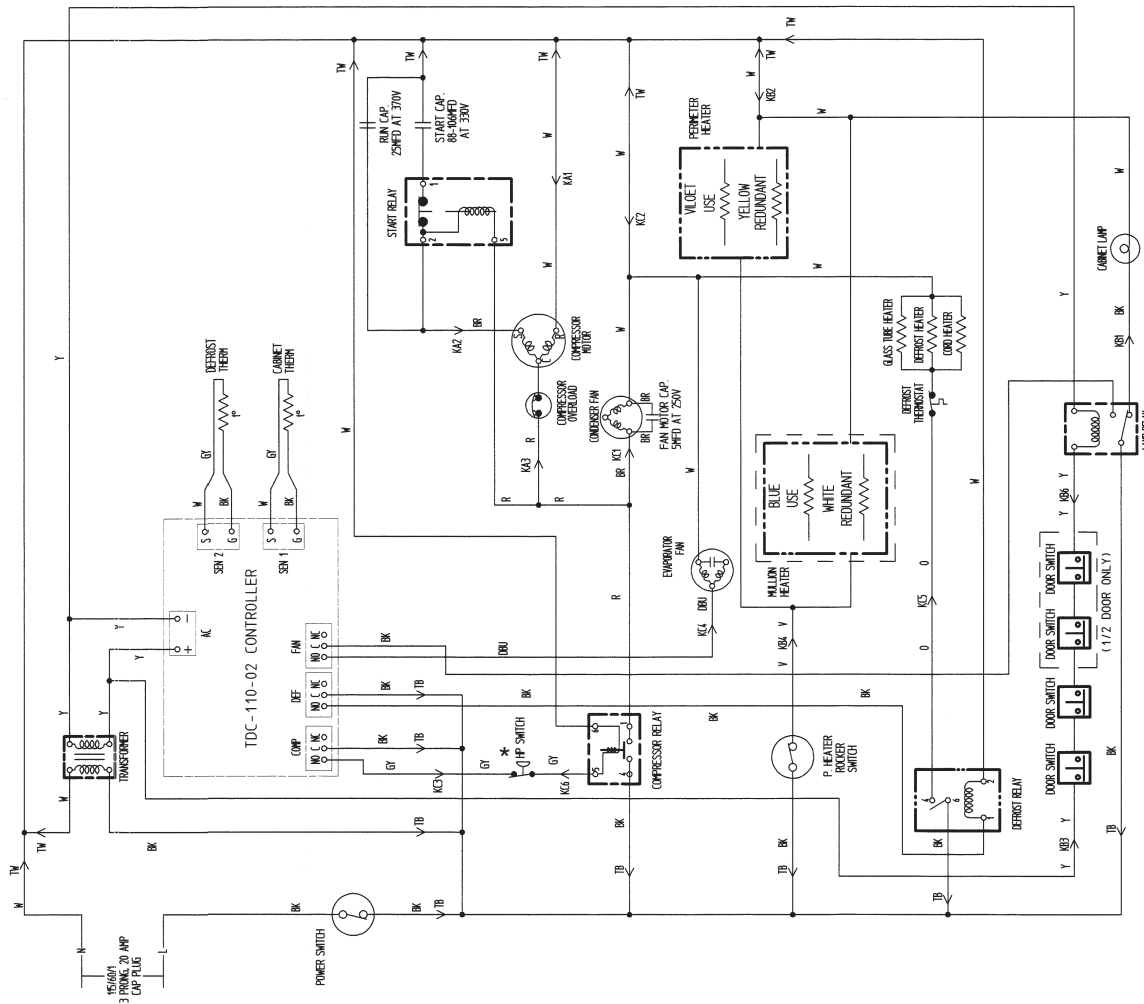

WIRE COLOR CODE

BR	BROWN
W	WHITE
BK	BLACK
R	RED
O	ORANGE
GY	GRAY
P	PINK
DBL	DARKBLUE
V	VIOLET
Y	YELLOW
LBL	LIGHTBLUE

* Pressure Switch (normally closed)	
Cut-out (open)	490±10 PSIG
Cut-in (closed)	370±20 PSIG

**CAUTION**

Before diagnosing and/or servicing the unit, confirm that you have the proper wiring diagram by checking against the diagram located on the evaporator case cover.

# F. RH1-AAC-W

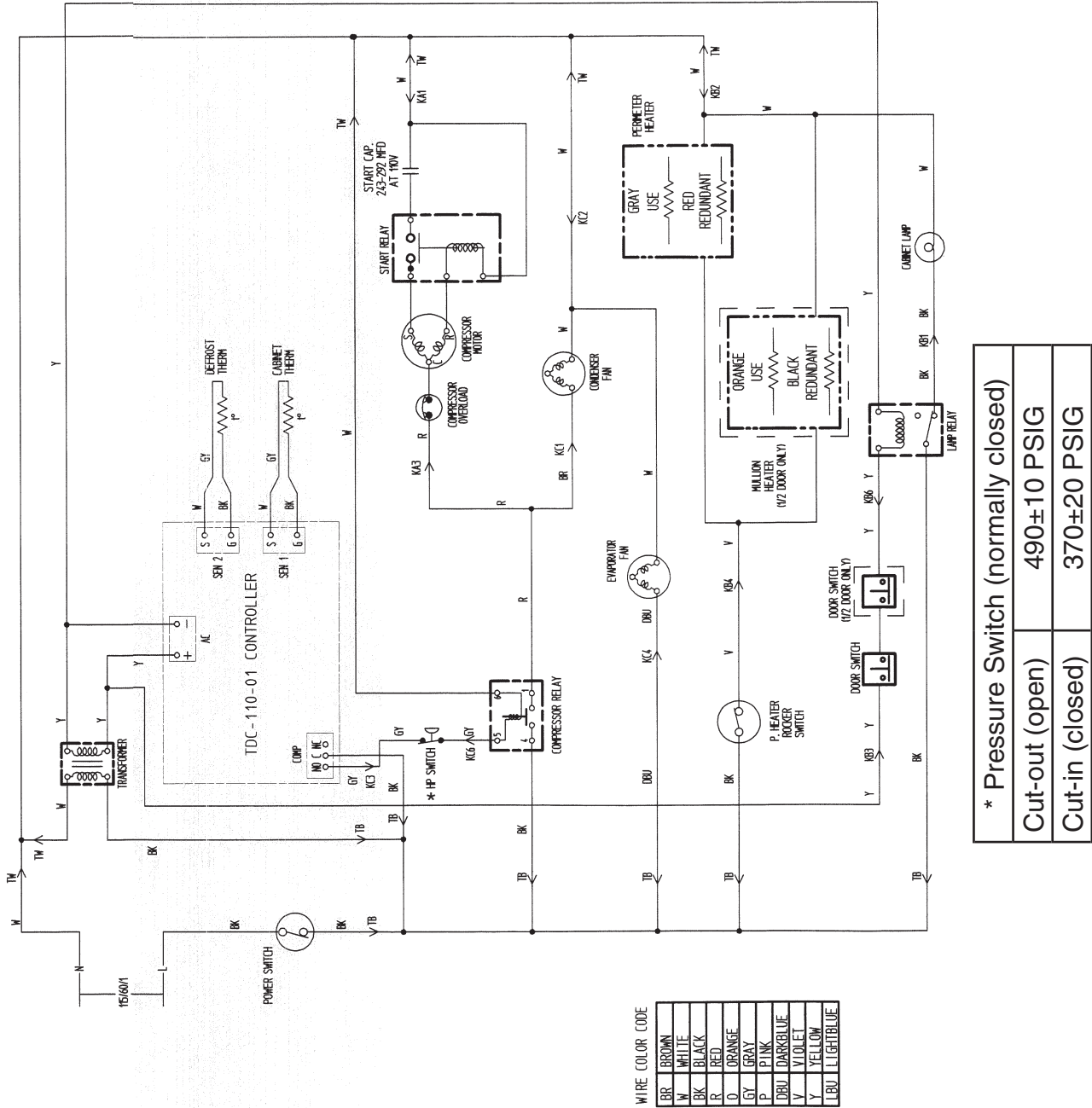

**CAUTION**

Before diagnosing and/or servicing the unit, confirm that you have the proper wiring diagram by checking against the diagram located on the evaporator case cover.