

SERVICE MANUAL

FOR JACKSON MODELS:

JPX-140

JPX-160

JPX-200



TABLE OF CONTENTS

<u>SECTION</u>	<u>DESCRIPTION</u>	<u>PAGE</u>
I.	INSTRUCTIONS	
	Installation Instructions	1
	Chemical Dispensing Equipment	2
	Chemical Timer Adjustments	3
	Operation Instructions	5
	PC Board	7
II.	TROUBLESHOOTING	8
III.	JPX-140	
	Specifications of the JPX-140	9
	Dimensions JPX-140	10
	Front Assembly	11
	Electrical Panel	12
	Front and Bottom View	13
	Wash Arm/Rinse Arm Assemblies	15
	Inside Tub View	17
	Rear View	18
	Miscellaneous	19
	Electrical Diagram: 208-240 Volt, 60 Hertz, 1 Phase	20
IV.	JPX-160	
	Specifications of the JPX-160	21
	Dimensions JPX-160	22
	JPX-160 Front View	23
	Electrical Panel	24
	Front and Bottom View	25
	Rear View	27
	Wash Arm/Rinse Arm Assemblies	28
	Inside Tub View	30
	Miscellaneous	31
	Electrical Diagram: 208-240 Volt, 60 Hertz, 1 Phase	32
	Electrical Diagram: 12 Volt Circuit	33
JPX-160 Components Diagram	34	
V.	JPX-200	
	Specifications of the JPX-200	35
	Dimensions JPX-200	36
	Main Assembly	37
	Electrical Panel	38
	Front and Bottom View	39
	Rear View	41
	Wash Arm/Rinse Arm Assemblies	42
	Inside Tub View	43
	Miscellaneous	44
	Electrical Diagram: 208-240 Volt, 60 Hertz, 1 Phase	45
	Electrical Diagram: 12 Volt Circuit	46
JPX-200 Components	47	

INSTALLATION INSTRUCTIONS

INSTALLATION INSTRUCTIONS

VISUAL INSPECTION: Before installing the unit, check the container and machine for damage. A damaged container is an indicator that there may be some damage to the machine. If there is damage to both the container and machine, do not throw away the container. The dishmachine has been inspected and packed at the factory and is expected to arrive to you in new, undamaged condition. However, rough handling by carriers or others may result in there being damage to the unit while in transit. If such a situation occurs, do not return the unit to Jackson; instead, contact the carrier and ask them to send a representative to the site to inspect the damage to the unit and to complete an inspection report. You must contact the carrier within 48 hours of receiving the machine. Also, contact the dealer through which you purchased the unit.

UNPACKING THE DISHMACHINE: Once the machine has been removed from the container, ensure that there are no missing parts from the machine. This may not be obvious at first. If it is discovered that an item is missing, contact Jackson immediately to have the missing item shipped to you.

LEVEL THE DISHMACHINE: The dishmachine is designed to operate while being level. This is important to prevent any damage to the machine during operation and to ensure the best results when washing ware. The unit comes with adjustable bullet feet, which can be turned using a pair of channel locks or by hand if the unit can be raised safely. Ensure that the unit is level from side to side and from front to back before making any connections.

PLUMBING THE DISHMACHINE: All plumbing connections must comply with all applicable local, state, and national plumbing codes. The plumber is responsible for ensuring that the incoming water line is thoroughly flushed prior to connecting it to any component of the dishmachine. It is necessary to remove all foreign debris from the water line that may potentially get trapped in the valves or cause an obstruction. Any valves that are fouled as a result of foreign matter left in the water line, and any expenses resulting from this fouling, are not the responsibility of the manufacturer.

CONNECTING THE DRAIN LINE: The JPX-140 model covered in this manual has a gravity discharge drain. Remove the drain plug from the tub and the unit will drain itself. The unit comes with a flexible drain hose that should be connected to the drain. The drain hose connection must drain downward and away from the machine.

The drain for the JPX-160 & JPX-200, is a pumped discharge drain. Both of these dishmachines must be drained into a stand pipe (like a household washing machine). If they are not, they will siphon themselves empty. The stand pipe for the JPX-160 is between 20 and 24 inches tall. The stand pipe for the JPX-200 is between 24 and 28 inches tall. All piping from the machine to the drain must be a minimum 1" I.P.S. and shall not be reduced.

There must also be an air gap between the machine drain line and the floor sink or drain. If a grease trap is required by code, it should have a flow capacity of 5 gallons per minute.

PRIMING THE DRAIN LINE: For the JPX-160 and JPX-200 models, prime the drain pump before use when the machine is full of water. Lower the end of the drain hose and allow some water to drain from the hose. Raise the end of the hose and connect it to its installation position.

WATER SUPPLY CONNECTION: Ensure that you have read the section entitled "PLUMBING THE DISHMACHINE" above before proceeding. Install the water supply line (1/2" pipe size minimum) to the vacuum breaker on the back of the machine. For ease of ser-

vice, the final water line connection to the machine should be using a length of flexible hose, suitable for the pressure and temperature of the incoming water. It is recommended that a water shut-off valve be installed in the water line between the main supply and the machine to allow access for service.

The water supply line is to be capable of 20 ± 5 PSI "flow" pressure at the recommended temperature indicated on the data plate.

In areas where the water pressure fluctuates or is greater than the recommended pressure, it is suggested that a water pressure regulator be installed. The JPX series units do not come with water pressure regulators as standard equipment.

Do not confuse static pressure with flow pressure. Static pressure is the line pressure in a "no flow" condition (all valves and services are closed). Flow pressure is the pressure in the fill line when the fill valve is opened during the cycle.

It is also recommended that a shock absorber (not supplied with the JPX series units) be installed in the incoming water line. This prevents line hammer (hydraulic shock), induced by the solenoid valve as it operates, from causing damage to the equipment.

PLUMBING CHECK: Slowly turn on the water supply to the machine after the incoming fill line and the drain line have been installed. Check for any leaks and repair as required. All leaks must be repaired prior to placing the machine in operation.

ELECTRICAL POWER CONNECTION: Electrical and grounding connections must comply with the applicable portions of the National Electrical Code ANSI/NFPA 70 (latest edition) and/or other electrical codes.

Disconnect electrical power supply and place a tag at the disconnect switch to indicate that you are working on the circuit.

Refer to the data plate for machine operating requirements, machine voltage, total amperage load and serial number.

To install the incoming power lines for the JPX-140, route the power lines through the grommet located in the rear AT THE TOP OF THE MACHINE.

WARNING: do not attempt to route incoming power lines to the dispenser terminal block located at the bottom of the JPX-140! Contact your authorized Jackson service agency or Jackson technical service if there are any questions.

To install the incoming power lines for the JPX-160 & JPX-200 route the power lines through the grommet located at the rear of the machine towards the bottom. Install the service wires (L1, L2 & Ground) to the appropriate terminals on the terminal block. It is recommended that "DE-OX" or another similar anti-oxidation agent be used on all power connections.

VOLTAGE CHECK: Ensure that the power switch is in the OFF position and apply power to the dishmachine. Check the incoming power at the terminal block and ensure it corresponds to the voltage listed on the data plate. If not, contact a qualified service agency to examine the problem. Do not run the dishmachine if the voltage is too high or too low. Shut off the service breaker and mark it as being for the dishmachine. Advise all proper personnel of any problems and of the location of the service breaker. Replace the control box cover and tighten down the screws.

CHEMICAL DISPENSING EQUIPMENT

This page does not apply to the JPX-140 dishmachine. This unit is not supplied with chemical pumps.

The JPX-160 and JPX-200 dishmachines are supplied with detergent and rinse additive chemical feeder pumps.

TO PREPARE PUMPS FOR OPERATION

Locate the open ends of the chemical tubes, insert the end of each tube onto the hub on the brass weight, and place each one in the appropriate container.

- A. **Red Tubing = Detergent**
- B. **Blue Tubing = Rinse Aid**

PRIMING CHEMICAL FEEDER PUMPS

Chemical feeder pumps need priming when the machine is first installed or if for some reason the chemical lines have been removed and air is allowed to enter.



CAUTION: Water must be in the sump and wash tank prior to the dispensing of chemicals.

1. Verify that the proper chemical tube inlet is in the correct container.
2. The detergent pump shall prime itself, provided there is sufficient chemical available.
3. Detergent is automatically dispensed as required during the wash cycle.
4. When it is required to fill the rinse agent tubes, e.g. on installation or if the container has been allowed to empty, the system may be primed as follows:
 - a) Ensure a cycle is not in progress.
 - b) Press and hold the drain switch until "rinse-prime" appears in the display.
 - c) On models with drain pump the message "draining" will appear first. The message "rinse-prime" will appear after a further few seconds. DO NOT release the switch when the "draining" message is showing, as this will start a drain cycle. If this is accidentally done, switch off to cancel the drain cycle.
 - d) The rinse-agent pump will run until the switch is released.
 - e) Observe the rinse agent travelling along the tube. Release the switch when the tubing is full.



Warning: Some of the chemicals used in dishwashing may cause chemical burns if they come in contact with your skin. Wear appropriate protective gear when handling these chemicals. If you do come in contact with these chemicals flush the area with fresh water.



This equipment is not recommend for use with deionized water or other aggressive fluids. Use of deionized water or other aggressive fluids will result in corrosion and failure of materials and components. Use of deionized water or other aggressive fluids will void the manufacturer's warranty.

CHEMICAL TIMER ADJUSTMENTS

This page does not apply to the JPX-140 dishmachine.

In general, it should not be necessary to alter the machine settings. The factory settings have been established to give the best results.

IMPORTANT: To avoid wasting chemicals, remove tubes from soap and rinse-agent bottles before using the Service Mode. The system will always give an initial dose during the first cycle after switch-on, even though the wash tank may still be full.

TO ENTER ENGINEERING MODE WITHOUT REMOVING THE TOP PANEL:

PREPARATION: Open the door and observe at the top right of the door frame. Notice the door switch shaft by which the door switch is operated. This serves as the "enter" button.

The "mode" switch is used to scroll between menu options and variable values.

TO ENTER ENGINEERING MODE:

1. Turn machine off, wait until the display is blank.
2. Open the door and hold a pencil or similar item against the door switch shaft.
3. Switch on and as soon as the display appears press the door switch shaft 5 times within 4 seconds.
4. The display should change to "rinse overlap", thus showing you are in the Engineering Mode.

Scrolling through the menu is achieved by use of the two switches mentioned above; it must be switched off ("down" position) to stop the scrolling.



DANGER: DO NOT start the FILL test or the WASH PUMP test by pressing the door switch button. Close the door instead because water will start spraying.

NOTE: If it is necessary to abandon a test or other operation in the Service Mode, or when you wish to revert to normal use, switch OFF and ON again.

CHEMICAL TIMER ADJUSTMENTS CONTINUED

Use the chart below to determine the initial time values for INITIAL RINSE, CYCLE RINSE, INITIAL SOAP, and CYCLE SOAP based on the desired concentration of the chemical being used. Check the concentration of the chemicals after running a few cycles and readjust as necessary.

JPX-160

Chemical Ratio (parts water to one part chemical)	Chemical Concentration (percent in water)	Chemical Concentration (ounces per 10 gallons water)	Initial Rinse (sec)	Cycle Rinse (sec)	Initial Detergent (sec)	Cycle Detergent (sec)
5000	0.02%	0.3	7	4	3	1
3000	0.03%	0.4	12	7	5	1
2500	0.04%	0.5	14	8	6	2
2000	0.05%	0.6	18	10	8	2
1500	0.07%	0.9	24	14	10	3
1000	0.10%	1.3	36	20	16	4
800	0.13%	1.6	45	26	20	5
600	0.17%	2.1	60	34	26	6
400	0.25%	3.2	90	51	39	9
300	0.33%	4.3	119	68	52	13
250	0.40%	5.1	143	82	63	15
200	0.50%	6.4	179	102	78	19

JPX-200

Chemical Ratio (parts water to one part chemical)	Chemical Concentration (percent in water)	Chemical Concentration (ounces per 10 gallons water)	Initial Rinse (sec)	Cycle Rinse (sec)	Initial Detergent (sec)	Cycle Detergent (sec)
5000	0.02%	0.3	11	5	8	1
3000	0.03%	0.4	18	9	14	2
2500	0.04%	0.5	22	10	16	2
2000	0.05%	0.6	27	13	21	2
1500	0.07%	0.9	36	17	27	3
1000	0.10%	1.3	54	26	41	5
800	0.13%	1.6	67	32	52	6
600	0.17%	2.1	90	43	69	8
400	0.25%	3.2	134	64	103	12
300	0.33%	4.3	179	85	137	16
250	0.40%	5.1	215	102	165	19
200	0.50%	6.4	269	128	206	24

I
N
S
T
R
U
C
T
I
O
N
S

OPERATION INSTRUCTIONS

INSTRUCTIONS

PREPARATION: Before proceeding with the start-up of the unit, verify the following:

1. Remove all solid wastes in order to avoid obstructing strainers, drain and wash jets.
2. Ware that is encrusted with soil should be presoaked prior to being placed in the machine.
3. When placing dishes into the racks, do not allow them to lean on each other.
4. Place cups and similar items upside down in the racks.
5. Ensure that the drain stopper is inserted and tight on units supplied with a drain stopper.
6. Ensure that the wash arms are installed and secure.

POWER UP: To energize the unit, turn on the power at the service breaker. The voltage should have been previously verified as being correct. If not, the voltage will have to be verified.

FILLING THE WASH TUB:

JPX-140: Put the Blue Mode Switch in the STANDBY (up) position. Ensure that the door is closed completely and place the Power Switch in the ON position (the switch should illuminate). The unit will begin to fill with water in both the wash tank and the rinse tank.

JPX-160/JPX-200: For the initial fill, put the Power Switch in the ON position and the AUTO/STANDBY Switch in STANDBY. Close the door. The unit will automatically fill.

Note: Depending upon the wash temperature, the unit may go into a FAST HEAT cycle. The machine will fill and drain water from the rinse tank into the wash tank to get the wash temperature up to the minimum (150° F) temperature.

The unit will stop filling once the correct level is attained. Ensure that the unit is level and that incoming flow pressure is 20 ± 5 PSI.

To prevent a cycle from starting after the door is closed, the Mode Switch must be turned to "STANDBY" before the door is closed.

WARM UP CYCLES: Warm-up cycles are not required on the JPX-140 dishmachine. When the machine reaches the proper operating temperatures, the blue "READY" light on the front panel will be illuminated.

WARE PREPARATION: Proper preparation of ware will help ensure good results and less re-washes. If not done properly, ware may not come out clean and the efficiency of the dishmachine will be reduced. It is important to remember that a dishmachine is not a garbage disposal and that simply throwing unscrapped dishes into the machine simply defeats the purpose altogether of washing the ware. Scraps should be removed from ware prior to being loaded into a rack. Pre-rinsing and pre-soaking are good ideas, especially for silverware and casserole dishes. Place cups and glasses upside down in racks so that they do not hold water during the cycle. The dishmachine is meant not only to clean, but to sanitize as well, to destroy all of the bacteria

that could be harmful to human beings. In order to do this, ware must be properly prepared prior to being placed in the machine.

DAILY MACHINE PREPARATION: Refer to the section entitled "PREPARATION" at the top of this page and follow the instructions there. Afterwards, check that all of the chemical levels are correct and/or that there is plenty of detergent available for the expected workload.

WASHING A RACK OF WARE:

JPX-140: To wash a rack of ware, open the door completely (being careful of hot water that may drip from the top of the unit), manually load the detergent into the wash chamber, and slide the rack into the unit. Wait until the blue "READY" light on the front panel is illuminated, indication that the water in the machine has been heated to the proper operating temperature. Put the STANDBY Switch into the AUTO (down) position. Close the door and the unit will start automatically. Once the cycle is completed, open the door (again watching for dripping hot water) and remove the rack of clean ware and allow ware to air dry. Replace with a rack of soiled ware and close the door. The process will then repeat itself.

JPX-160/JPX-200: Once the display indicates "unit ready", open the door. Place the rack of soiled ware in the unit. Put the AUTO/STANDBY Switch in the AUTO position. Select the desired wash cycle length (2 or 4 minutes) by placing the Cycle Switch in the desired position (up for 2 minutes and down for 4 minutes). Close the door. The machine will start automatically. Once the cycle is completed, open the door and remove the rack of clean ware. Replace with a rack of soiled ware and close the door. The cycle will begin again.

OPERATIONAL INSPECTION: Based upon usage, the wash strainers may become clogged with soil and debris as the workday progresses. Operators should regularly inspect the wash strainer to ensure it has not become clogged. If the strainers do, it will reduce the washing capability of the machine. Instruct operators to clean out the wash strainer at regular intervals or as required by work load.

SHUTDOWN AND CLEANING: At the end of the workday, close the door. Wait until the cycle is complete and the MODE Switch lamp is out. Move the MODE Switch UP into the STANDBY position, open the door to remove the last rack of ware. On pumped drain machines, the RIGHT hand switch is blue. On units supplied with a drain stopper, remove the drain stopper and put in a safe place. (NOTE: The wash tank water will be hot so caution is advised). Close the door. Press and hold down the Drain Switch until the message "DRAINING" appears. IMMEDIATELY release the switch and the drain cycle will start. The display will tell you when the cycle is complete. Move the POWER Switch to Off position.

OPERATION INSTRUCTIONS (CONTINUED)

SHUTDOWN AND CLEANING: Remove the central knob (A) to remove the wash arms. Check the nozzles to ensure they are not clogged with debris. If they are, simply unscrew the nozzle retainer for the affected nozzle and remove it to clean out the debris. Flush the arms out with fresh water. **IMPORTANT:** Remove only one nozzle at a time to ensure that you replace all of the nozzles as required. Each of the wash nozzles are embossed with either an S or a D. Use the diagrams to the right to refer to nozzle placement. There are no differences in each of the rinse nozzles.

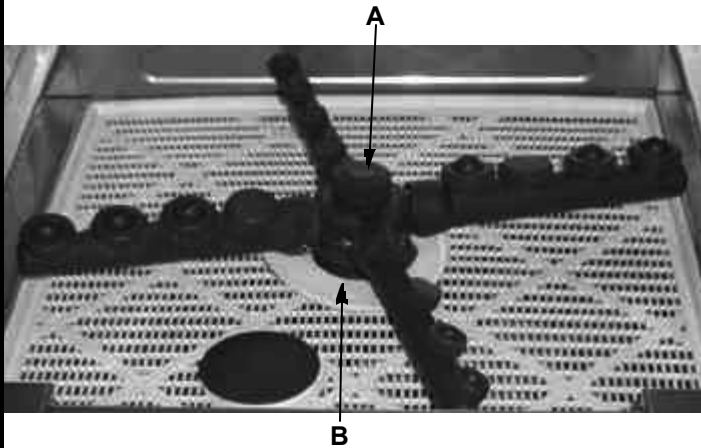

Remove the lower deflector washer (B) and clean. Notice how the washer for the lower arm is installed with the lip up. This is very important. If the deflector washer is not re-installed the same way, wash performance will suffer tremendously. The upper deflector washer (C) is only removable by removing the screws that attach it to the top of the unit. In the event this reflector is removed to be cleaned, make sure it is reattached with the lip facing downward away from the top of the unit as shown in the picture below.

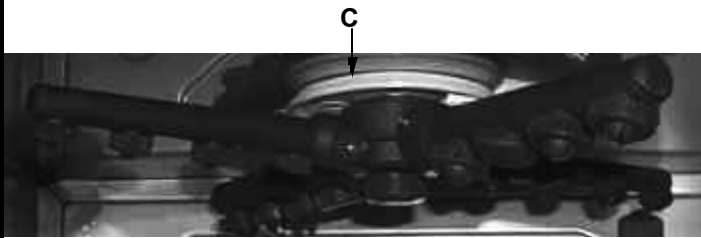

Remove the rear, left and right strainer supports and clean as required. Remove the wash and drain strainers and clean them as required. Wipe out the entire tub. Use a damp cloth to clean the tank, never use abrasive material such as steel wool or a wire brush to clean the tank. Use only cleaners specified for stainless steel and always follow the manufacturer's instructions on use of the cleaner.

WARNING: Do not use substances containing chlorine or bleach or anything containing hypochlorite compounds, as these chemicals will damage the stainless steel surfaces, and in time will render the machine useless. Such damage is not covered by the warranty.

JPX-140
Wash/Rinse Arm
Assembly

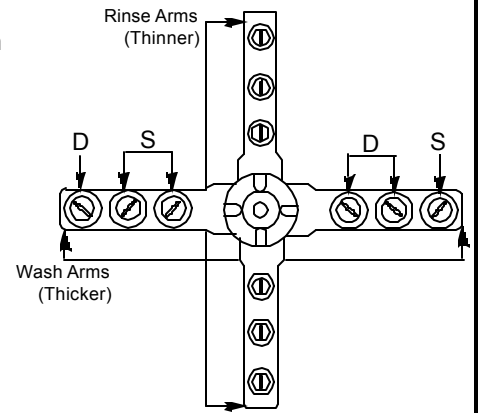

JPX-160
Wash/Rinse Arm
Assembly

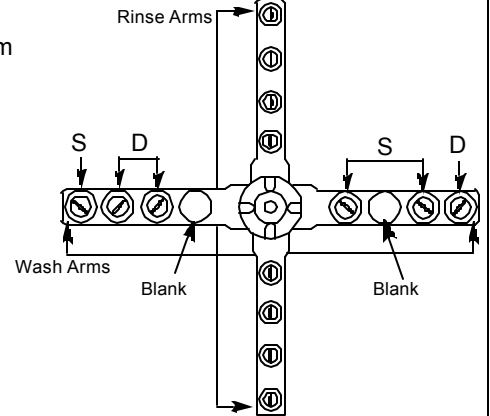

JPX-200
Wash/Rinse Arm
Assembly

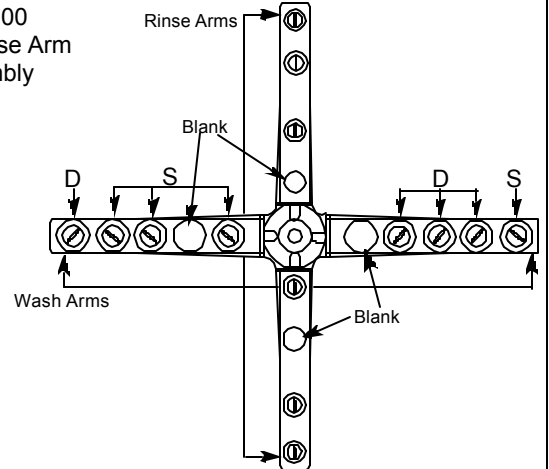

PC BOARD

Red lights will illuminate when the corresponding output signal is "on".

Display Contrast Adjuster. Turn clockwise to adjust the brightness of the display. It will not unscrew. When it reaches the brightest spot, it will restart at the dimmest setting.

For use only in the engineering/programming mode only

Scroll Down

Scroll Up

Enter

Green LED

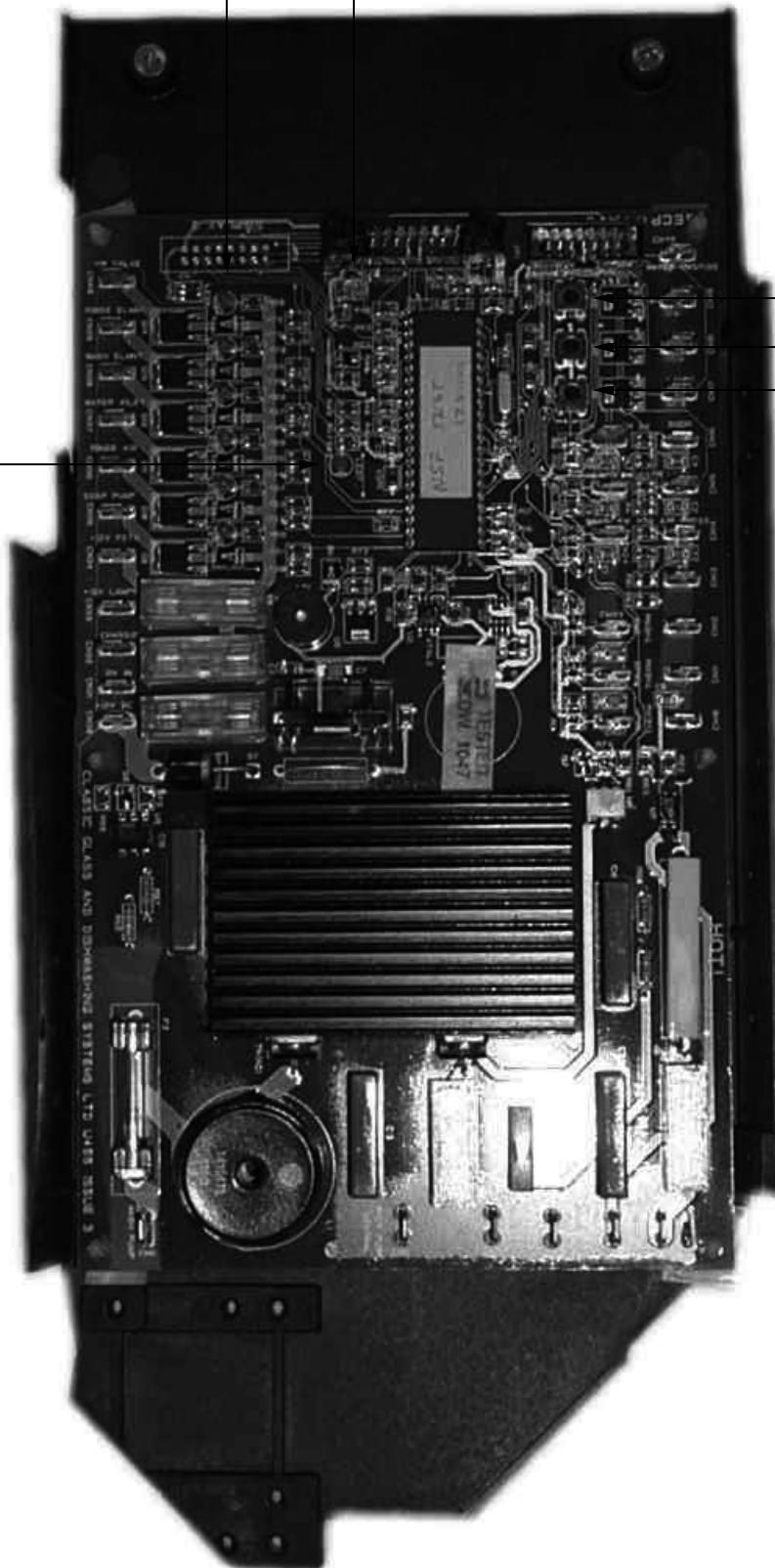

TROUBLESHOOTING SECTION

WARNING: Inspection, testing and repair of electrical equipment should be performed only by qualified service personnel. Certain procedures in this section require electrical tests or measurements while power is applied to the machine. **Exercise extreme caution at all times.** If test points are not easily accessible, disconnect power, attach test equipment and reapply power to test. When replacing electrical parts, disconnect power at source circuit breaker.

Problem: The tank does not fill up, machine does not start, or the dishmachine does not rinse.

1. Check that the water supply valve is open.
2. Check the water softener supply and connections.
3. Check the connections and fuses of the supply.
4. Examine the air vessel at the rear right of the wash tank. When the machine is empty, the lower edge of this vessel must not be touching the water remaining in the tank. This situation can be avoided by a small adjustment to the feet or legs, to tilt the machine slightly forwards.

Problem: The tank only fills up very slowly.

1. Check that the water supply is giving good pressure.
2. Check that the water line pressure during the fill or rinse is in the range of 15 to 25 PSI. If it is lower, ask your dealer to fit a booster pump to increase pressure.
3. Check that the rinse jets are not blocked by limescale or solid wastes.
4. Check if water hoses are trapped or kinked.
5. Check if the bushing at the center of the wash/rinse arm assemblies are loose or missing - this allows dirt into the rinse jets, which may be blocked.

Problem: Water marks on glasses.

1. Use correct chemicals, which do not produce foam and which are specially designed for this type of commercial dishmachine.
2. Check that rinse jets are not blocked and the water pressure is adequate.
3. Check the water hardness. If there is any sign of grey or brown deposits on the inside of the tank or on the wash elements, you probably have hard water. Ask your dealer to install a water softener.

Problem: Wash arms do not rotate freely.

1. Disassemble the wash arms and carefully clean, as described above. Check for signs of limescale deposit; a water softener may be required.
2. Check that the inlet pressure is higher than 2 1/2 bar (static) or 1 to 1 1/2 bar during fill or rinse. If it is lower, ask your dealer to fit a pump to increase the pressure.
3. Check if the deflector disc is missing or is upside down (should be the same way up as a saucer).
4. Check if the bushes at the center of the rotating arm assemblies are loose or missing - this allows dirt into the rinse jets, may be blocked.

SPECIFICATIONS of the JPX-140

PERFORMANCE/CAPABILITIES

OPERATING CAPACITY (RACKS/HOUR)

RACKS PER HOUR	13
DISHES PER HOUR	91
GLASSES PER HOUR	260

OPERATING CYCLE (SECONDS)

WASH TIME	226
RINSE TIME	14
TOTAL CYCLE TIME	240

TANK CAPACITY (GALLONS)

WASH TANK	2.8
BOOSTER TANK	1.25

TEMPERATURES

WASH---°F (MINIMUM)	150
RINSE---°F (MINIMUM)	180

ELECTRICAL REQUIREMENTS

WASH PUMP MOTOR HP 1/2

NOTE: Typical Electrical Circuit is based upon (1) 125% of the full amperage load of the machine and (2) typical fixed-trip circuit breaker sizes as listed in the NEC 2002 Edition. Local codes may require more stringent protection than what is displayed here. Always verify with your electrical service contractor that your circuit protection is adequate and meets all applicable national and local codes. These numbers are provided in this manual simply for reference and may change without notice at any given time.

<u>VOLTS</u>	<u>PH</u>	<u>HZ</u>	<u>RINSE HEATER RATINGS</u>	<u>TOTAL AMPS</u>	<u>TYPICAL ELECTRICAL CIRCUIT</u>
208	1	60	2.7 KW@208V	24	30 AMP
230	1	60	3.3 KW@230V	26	35 AMP

WATER REQUIREMENTS

INLET TEMPERATURE	140°F
WATER LINE SIZE I.P.S. (Minimum)	1/2"
DRAIN LINE SIZE I.D (Minimum)	1"
FLOW PRESSURE P.S.I.	20 ± 5
GALLONS PER RACK	.49
GALLONS PER HOUR	6.4

NOTE: Always refer to the machine data plate for specific electrical and water requirements. The material provided on this page is for reference only and may be subject to change without notice.

This equipment is not recommend for use with deionized water or other aggressive fluids. Use of deionized water or other aggressive fluids will result in corrosion and failure of materials and components. Use of deionized water or other aggressive fluids will void the manufacturer's warranty.

DIMENSIONS of the JPX-140

JPX 140

A. 1/2" FNPT 140°F. WATER CONNECTION

B. DRAIN HOSE CONNECTION FOR GRAVITY DRAIN FROM THE UNIT. UNIT SUPPLIED WITH 1" I.D. X 1 1/2" O.D. X 6'-0" LONG FLEXIBLE HOSE.

C. ELECTRICAL CONNECTION

D. DISPENSER CONNECTION

2 1/2" MIN. WALL CLEARANCE

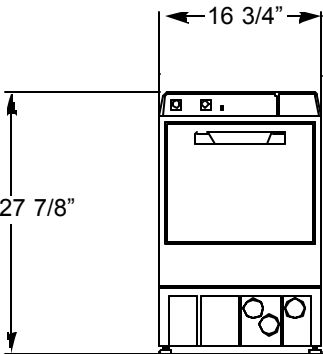
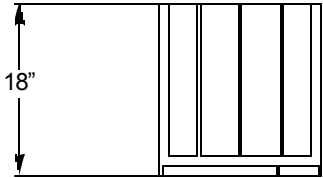
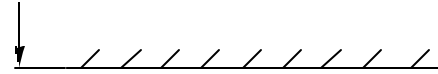

DOOR IN OPEN POSITION

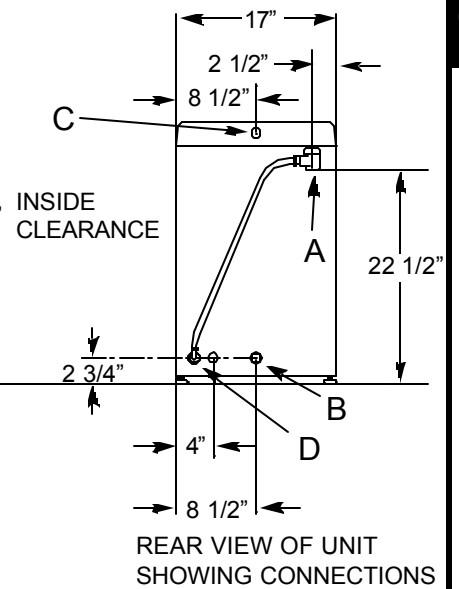
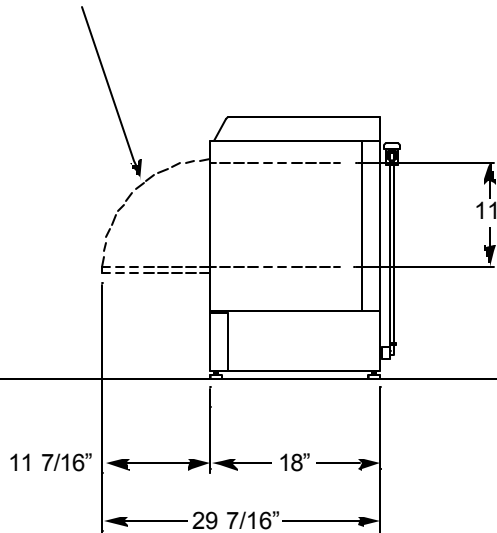

FRONT ASSEMBLY



J
P
X
1
4
0

<u>ITEM</u>	<u>QTY</u>	<u>DESCRIPTION</u>	<u>Mfg. No.</u>
01	1	Door Microswitch with Assembly	2020-162-27-23
02	1	ON/OFF Switch	2020-142-27-10
03	1	Mode Switch	2020-142-27-11
04	1	Ready Light	2020-142-27-18
05	1	Metal Facia Plate for Switches	2020-142-67-95
06	1	Black Plastic Top Panel	2020-142-27-34
07	1	Wash Gauge	2020-142-67-97
08	1	Handle	2020-162-27-73
09	1	Door	2020-142-27-50
10	1	Rinse Gauge	2020-142-67-96
11	1	Lower Front Panel	2020-142-27-53
12	1	Rinse Gauge	2020-162-27-60

ELECTRICAL PANEL

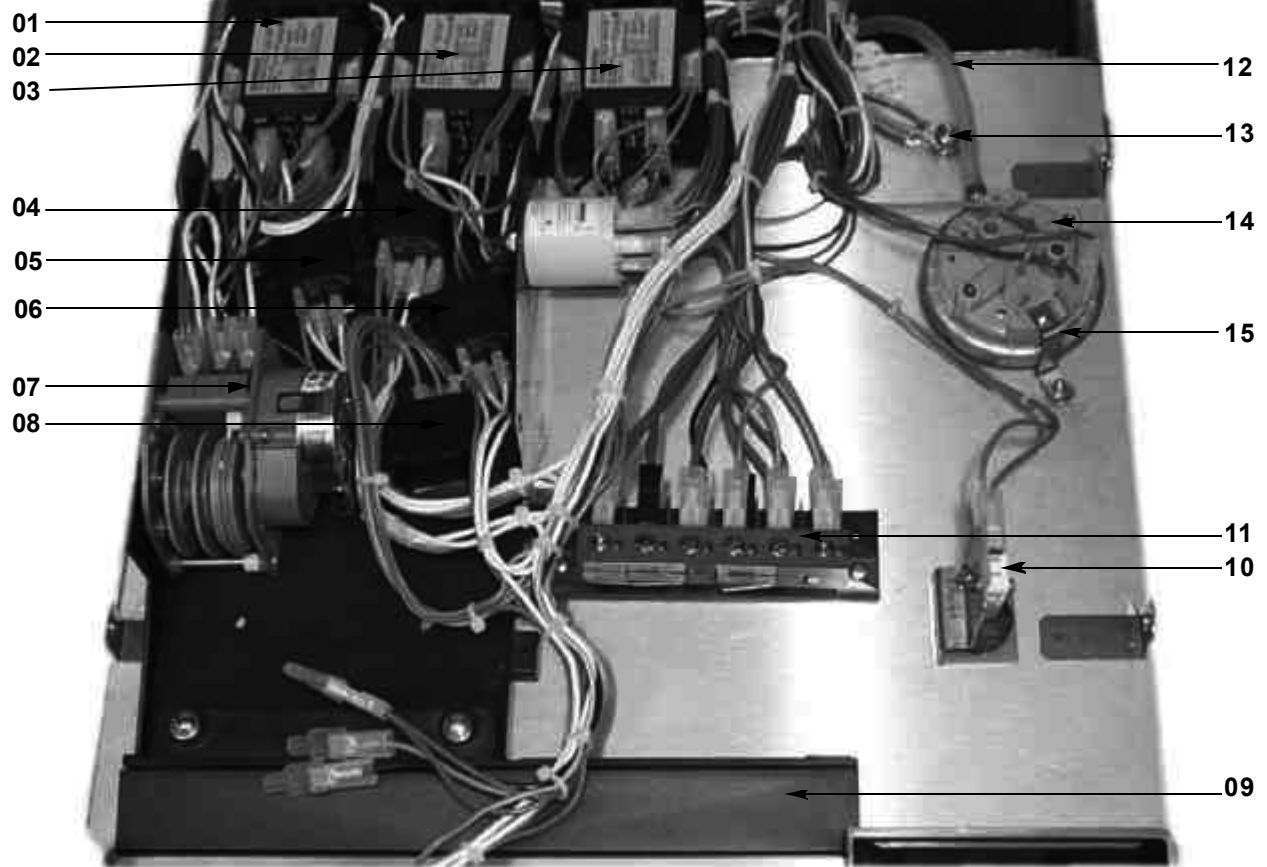

<u>ITEM</u>	<u>QTY</u>	<u>DESCRIPTION</u>	<u>Mfg. No.</u>
01	1	Contactors, 240V	2020-142-28-54
02	1	Contactors, 240V	2020-142-28-54
03	1	Contactors, 240V	2020-142-28-54
04	1	Relay, 240V, 4 Pin	2020-142-28-50
05	1	Relay, 240V, 5 Pin	2020-142-28-51
06	1	Relay, 240V, 4 Pin	2020-142-28-50
07	1	Timer, 2 Minute	2020-142-27-06
07	1	Timer, 4 Minute	2020-142-37-21
08	1	Relay, 240V, 4 Pin	2020-142-28-50
09	1	Black Plastic Support for Facia	2020-162-28-11
10	1	Door Microswitch with Assembly	2020-162-27-23
11	1	Terminal Block	2020-162-27-20
12	1	Hose	2020-162-28-24
13	1	Grounding Nut	2020-162-27-60
14	1	Gray Pressure Switch	2020-162-27-21
15	1	Hold Down Bracket	2020-162-26-80

FRONT AND BOTTOM VIEW

J P X
1 4 0

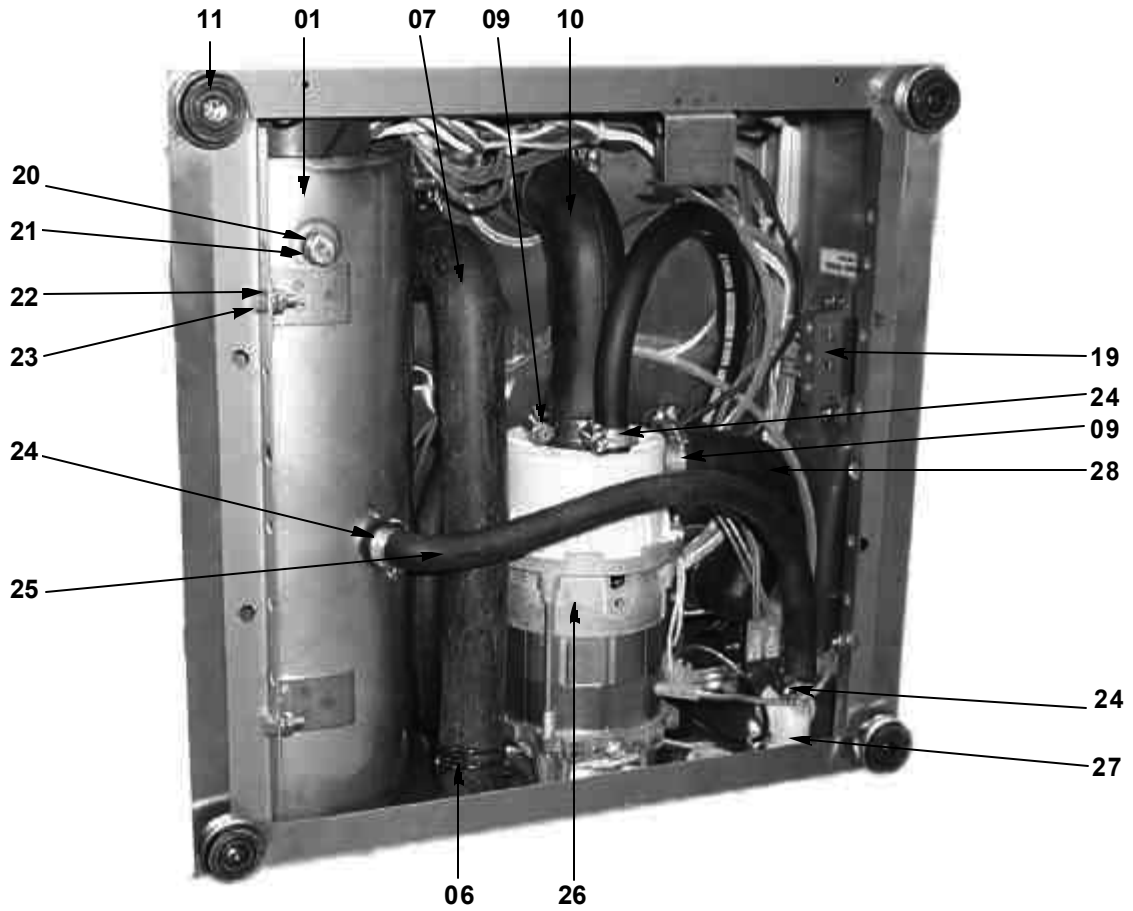
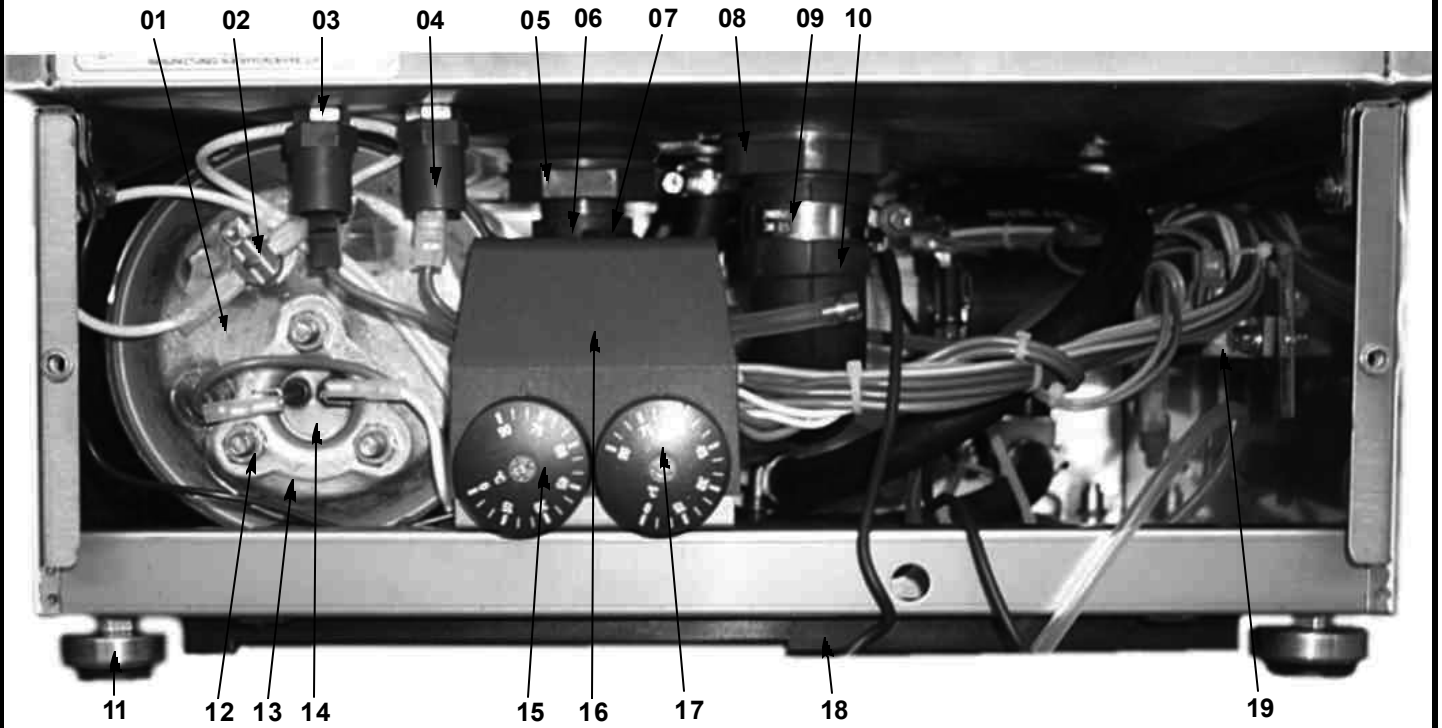

FRONT AND BOTTOM VIEW (CONTINUED)

<u>ITEM</u>	<u>QTY</u>	<u>DESCRIPTION</u>	<u>Mfg. No.</u>
01	1	Rinse Tank	2020-142-28-03
02	1	Rinse Tank Thermal Switch	2020-142-27-16
03	1	Wash Element with Washer and Nuts	2020-162-27-04
04	2	Terminal Guard	2020-162-28-00
05	1	Nut, 1", Plastic	2020-142-27-64
06	2	Hose Clamp	2020-162-27-59
07	1	Drain Hose	2020-162-28-06
08	1	Nut, Plastic	2020-162-27-91
09	2	Hose Clamp	2020-162-27-62
10	1	Pump Inlet Hose	2020-142-27-90
11	4	Foot, Machine	2020-162-27-43
12	3	Hex Nut	2020-162-27-93
13	1	Heater Gasket	2020-142-27-92
14	1	Rinse Heater Element	2020-142-28-49
15	1	Thermostat	2020-142-26-98
16	1	Support Bracket	2020-142-67-99
17	1	Thermostat	2020-142-26-98
18	1	Base Cover	2020-142-27-51
19	1	Terminal Block	2020-142-68-00
20	1	Washer, Fiber	2020-162-28-05
21	1	Bolt, Drain	2020-162-28-04
22	2	Screw	2020-162-27-98
23	2	Nut	2020-162-27-93
24	3	Hose Clamp	2020-162-27-60
25	1	Hose, Rinse	2020-162-28-24
26	1	Wash Pump Motor	2020-162-28-23
27	1	Valve, Solenoid Water Inlet	2020-142-27-02
28	1	Outlet Hose	2020-142-26-95

J
P
X
1
4
0

WASH ARM/RINSE ARM ASSEMBLIES

J P X
1 4 0

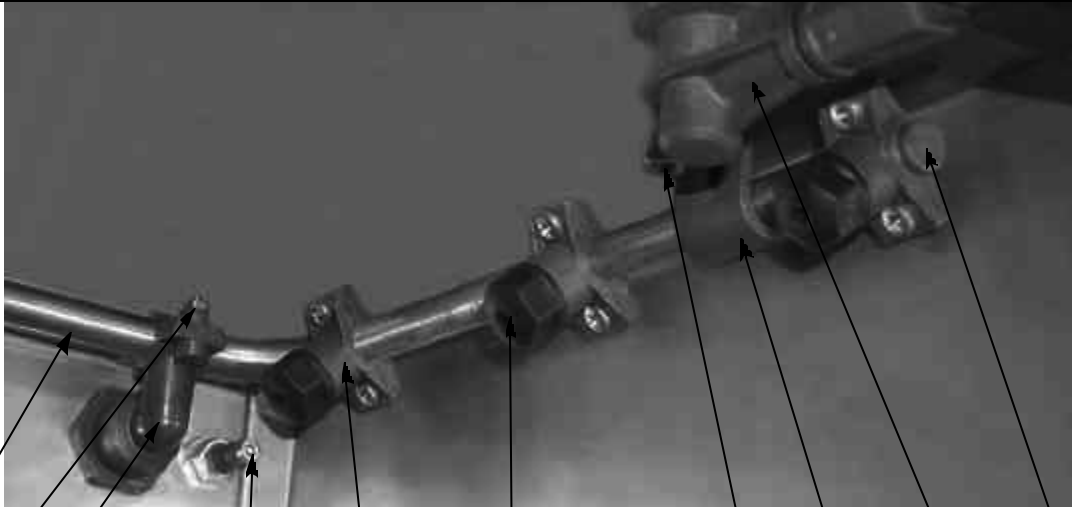

01 02 03 04 05 07 08 09 10 11 12 14 15 16 17 18 19 20

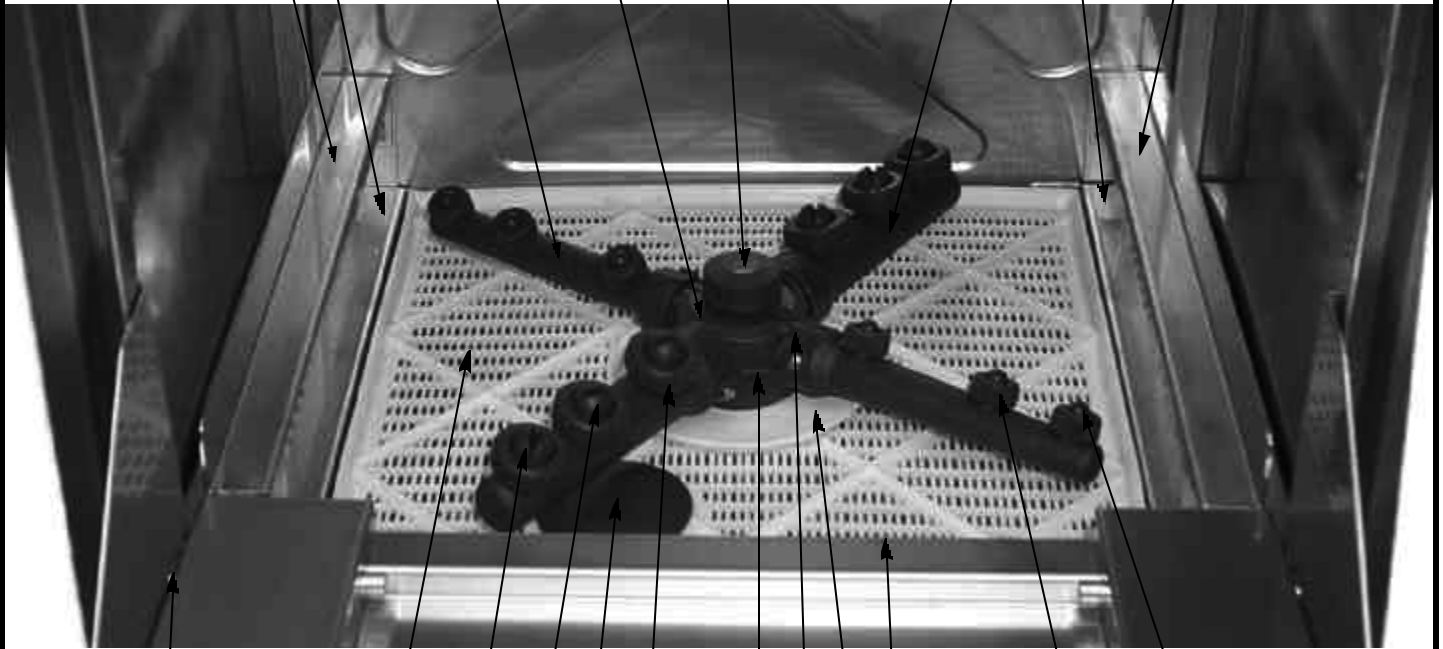

06 13 14 24 25 26 27 28 29 30 31

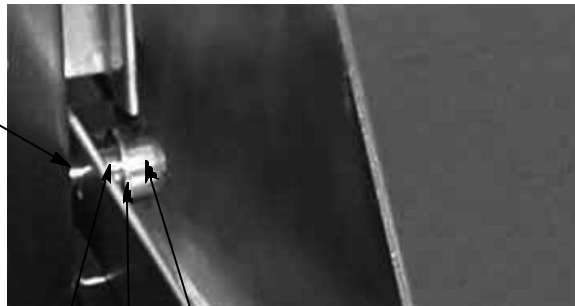

21 22 23

WASH ARM/RINSE ARM ASSEMBLIES (CONTINUED)

<u>ITEM</u>	<u>QTY</u>	<u>DESCRIPTION</u>	<u>Mfg. No.</u>
01	1	Rinse Arm Pipe (Cross Tube)	2020-142-68-01
02	1	Hex Nut	2020-142-26-48
03	1	Elbow, Rinse Halo	2020-142-68-02
04	1	Ramp, Left Hand Basket	2020-162-28-09
05	1	Support, Left Hand Filter	2020-142-27-55
06	6	Jet, Rinse	2020-162-26-57
07	1	Elbow, Soap Assembly	2020-162-27-35
08	2	Rinse Arm	2020-142-26-42
09	4	Rinse Jet Nozzle	2020-142-68-03
10	2	O-Ring, Wash Arm	2020-162-26-59
11	6	Nozzle Cap	2020-142-68-04
12	1	Bolt, 8mm, Spindle	2020-162-26-71
13	6	Nut, Rinse Jet	2020-162-26-56
14	1	Support, Front Filter	2020-162-28-21
15	2	Wash Arm	2020-162-26-75
16	2	Rinse Jet Support	2020-142-26-44
17	1	Support, Right Hand Filter	2020-142-27-56
18	1	Door Switch Assembly	2020-142-68-05
19	1	Ramp, Right Hand Basket	2020-162-28-10
20	2	Rinse Halo Endcap	2020-142-68-00
21	2	Pin, Hinge	2020-162-28-07
22	2	C-Clip, Hinge Pin	2020-162-27-38
23	2	Spacer, Hinge Pin	2020-162-27-39
24	1	Flange, Bottom	2020-162-26-42
25	2	O-Ring, Rinse Arm	2020-162-26-60
26	1	Center Boss	2020-202-26-39
27	1	Filter, Plastic	2020-162-28-18
28	3	Jet, Wash L/H "S"	2020-162-26-65
29	3	Jet, Wash R/H "D"	2020-162-26-54
30	1	Plug, Drain	2020-162-26-92
31	6	Nut, Wash Jet	2020-162-26-63

J
P
X
1
4
0

INSIDE TUB VIEW

J
P
X
1
4
0

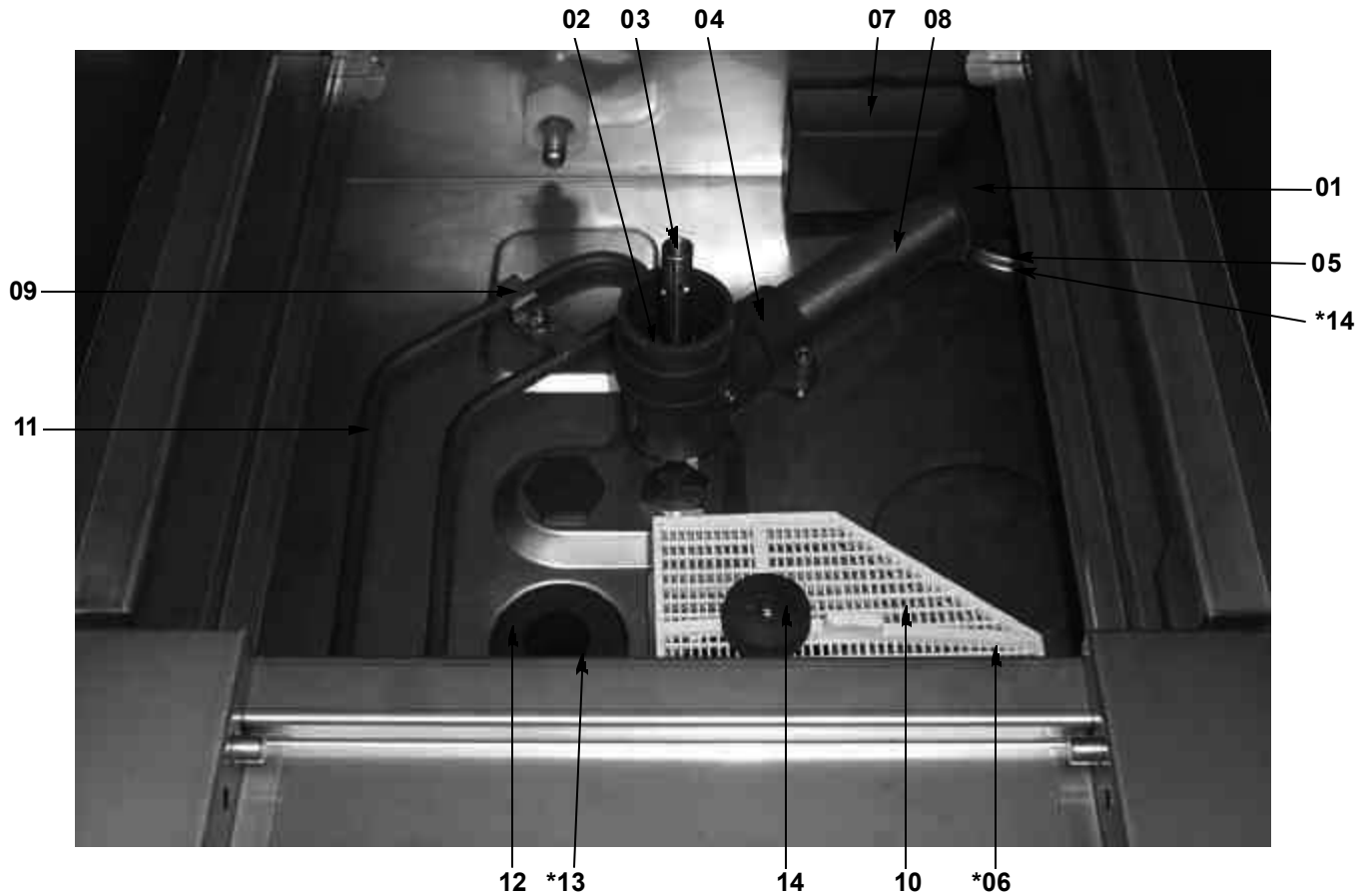

* Represents an item not shown.

<u>ITEM</u>	<u>QTY</u>	<u>DESCRIPTION</u>	<u>Mfg. No.</u>
01	1	Elbow Assembly	2020-162-26-46
02	1	Spacer, Bottom Spindle	2020-162-26-69
03	1	Spindle	2020-142-26-68
04	1	Bottom Boss Assembly	2020-202-26-53
05	1	O-Ring	2020-162-27-83
06	1	Base, Wash Filter	2020-142-27-87
07	1	Tube, Transfer	2020-142-26-51
08	1	Air Bell Assembly	2020-162-26-97
09	1	Hold Down Bracket	2020-142-68-07
10	1	Body, Wash Filter	2020-162-27-86
11	1	Element, Wash with Washer and Nuts	2020-162-27-04
12	1	Waste Boss	2020-162-26-94
13	1	O-Ring	2020-162-27-62
14	1	Nut, Filter	2020-162-27-82

REAR VIEW

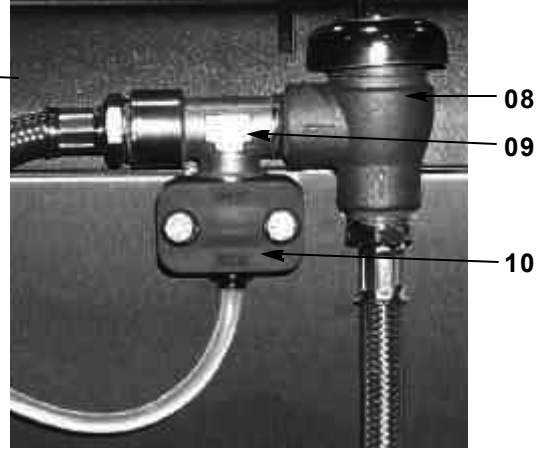
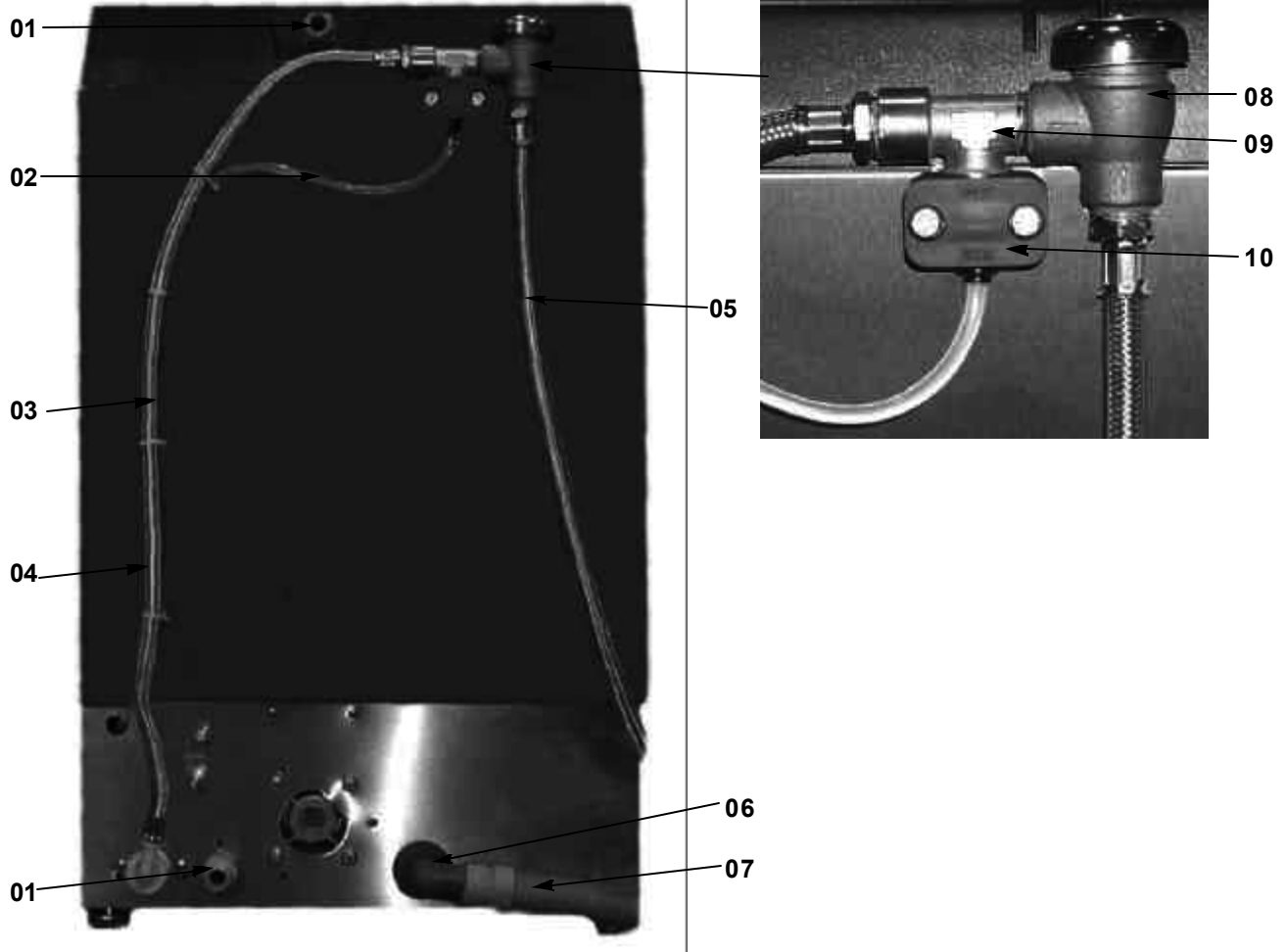

J
P
X
1
4
0

<u>ITEM</u>	<u>QTY</u>	<u>DESCRIPTION</u>	<u>Mfg. No.</u>
01	2	Conduit Connector	2020-142-68-81
02	1	Hose, 4-6 mm	2020-142-68-82
03	1	Water Inlet Hose	2020-162-27-84
04	1	Hose, 4-6 mm	2020-142-68-82
05	1	Drain Elbow	2020-142-26-96
06	1	Gray Drain Hose	2020-162-28-57
07	1	Waste Hose	2020-142-68-83
08	1	Vacuum Breaker	2020-142-68-84
09	1	Tee	2020-142-68-85
10	1	Bracket	2020-142-68-80

MISCELLANEOUS

J
P
X
1
4
0

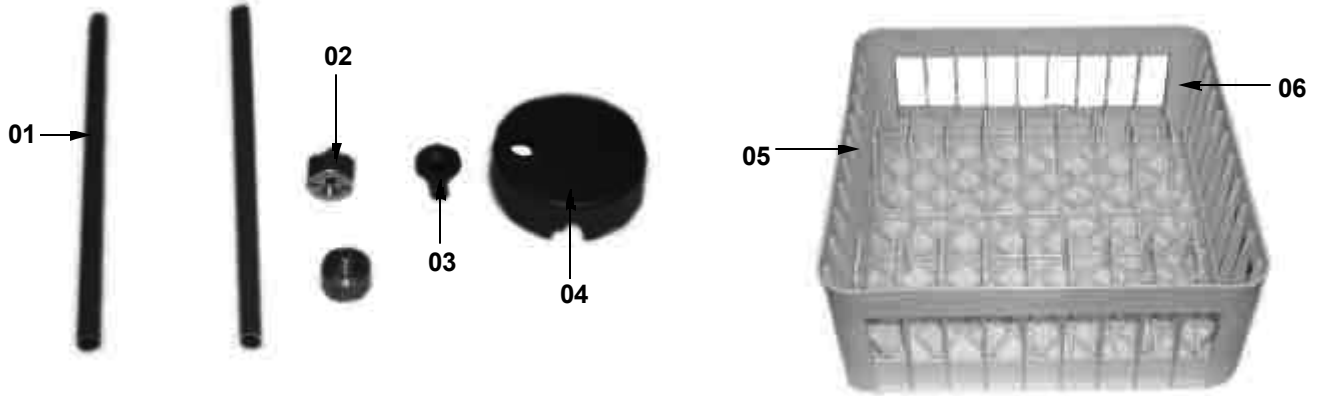

09

07

09

08

<u>ITEM</u>	<u>QTY</u>	<u>DESCRIPTION</u>	<u>Mfg. No.</u>
01	2	Line Stiffener	2020-142-68-09
02	2	Line Weight	2020-142-68-10
03	1	Nut, Cover	2020-142-28-01
04	1	Cover, Rinse Element	2020-142-27-99
05	1	Plate Rack	2020-142-68-11
06	1	Dish Rack	2020-142-68-12
07	1	Catch, Ball Assembly	2020-162-27-31
08	1	Switch, Micro Door Assembly	2020-162-27-23
09	2	External Corner Piece	2020-162-27-33
10	2	Internal Corner Piece	2020-162-27-32

JPX-140 ELECTRICAL DIAGRAM 208-240 VOLT, 60 HERTZ, 1 PHASE

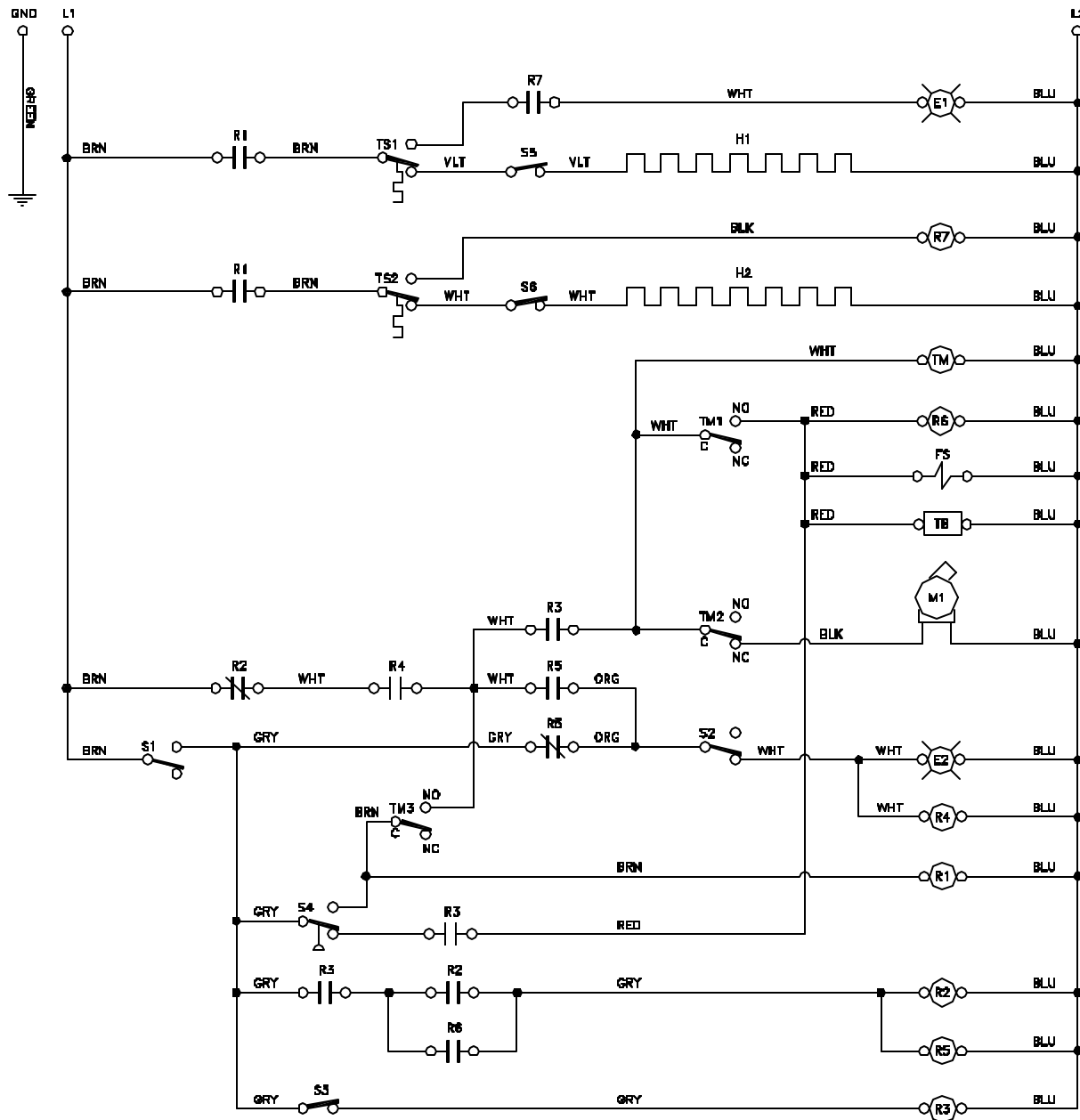

LEGEND

L1 L2	POWER DISTRIBUTION BLOCK	S1	POWER SWITCH
GND	GROUND	S2	MODE SWITCH
H1	WASH HEATER	S3	DOOR MICRO SWITCH
H2	RINSE HEATER	S4	PRESSURE SWITCH
M1	WASH PUMP MOTOR	S5	WASH THERMAL SWITCH
TM	TIMER MOTOR	S6	RINSE THERMAL SWITCH
R1	ELEMENT CONTACTOR	TS1	WASH THERMOSTAT
R2	LOGIC CONTACTOR	TS2	RINSE THERMOSTAT
R3	DOOR CONTACTOR	FS	FILL SOLENOID
R4	TIMER RELAY	TB	TERMINAL BOARD
R5	MODE RELAY	E1	READY LIGHT
R6	HOLDING RELAY	E2	CYCLE LIGHT
R7	TEMPERATURE RELAY		

SPECIFICATIONS of the JPX-160

J
P
X

1
6
0

PERFORMANCE/CAPABILITIES

OPERATING CAPACITY (RACKS/HOUR)	
RACKS PER HOUR	24
DISHES PER HOUR	192
GLASSES PER HOUR	600

OPERATING CYCLE (SECONDS)

WASH TIME	107
RINSE TIME	14
TOTAL CYCLE TIME	121

TANK CAPACITY (GALLONS)

WASH TANK (MINIMUM)	3.4
RINSE TANK	1.4

TEMPERATURES

WASH---°F (MINIMUM)	150
RINSE---°F	180

ELECTRICAL REQUIREMENTS

WASH PUMP MOTOR HORSEPOWER 1/2

NOTE: Typical Electrical Circuit is based upon (1) 125% of the full amperage load of the machine and (2) typical fixed-trip circuit breaker sizes as listed in the NEC 2002 Edition. Local codes may require more stringent protection than what is displayed here. Always verify with your electrical service contractor that your circuit protection is adequate and meets all applicable national and local codes. These numbers are provided in this manual simply for reference and may change without notice at any given time.

<u>VOLTS</u>	<u>PH</u>	<u>HZ</u>	<u>RINSE HEATER RATINGS</u>	<u>TOTAL AMPS</u>	<u>TYPICAL ELECTRICAL CIRCUIT</u>
208	1	60	2.7 KW@208V	24	30 AMP
230	1	60	3.3 KW@230V	26	35 AMP

WATER REQUIREMENTS

INLET TEMPERATURE	140°F
GALLONS PER RACK	.59
GALLONS PER HOUR	14.2
WATER LINE SIZE I.P.S. (Minimum)	1/2"
DRAIN LINE SIZE I.D.	1"
FLOW PRESSURE P.S.I.	20 ± 5

FRAME DIMENSIONS

WIDTH	19"
DEPTH	20"
HEIGHT	29 5/8"
MAXIMUM INSIDE CLEARANCE	14"

NOTE: Always refer to the machine data plate for specific electrical and water requirements. The material provided on this page is for reference only and may be subject to change without notice.

This equipment is not recommend for use with deionized water or other aggressive fluids. Use of deionized water or other aggressive fluids will result in corrosion and failure of materials and components. Use of deionized water or other aggressive fluids will void the manufacturer's warranty.

DIMENSIONS of the JPX-160

2 1/2" MIN. WALL CLEARANCE

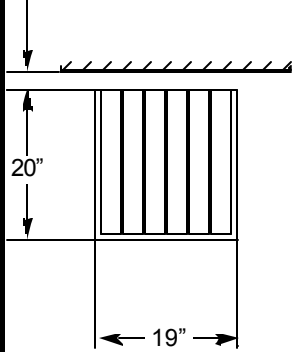

A. 1/2" FNPT 140°F. WATER CONNECTION

B. DRAIN HOSE CONNECTION FOR PUMPED DRAIN FROM THE UNIT. DISCHARGE HEIGHT MUST BE MAINTAINED. UNIT SUPPLIED WITH 1" I.D. X 1 1/2" O.D. X 6'-0" LONG FLEXIBLE HOSE.

C. ELECTRICAL CONNECTION

DOOR IN OPEN POSITION

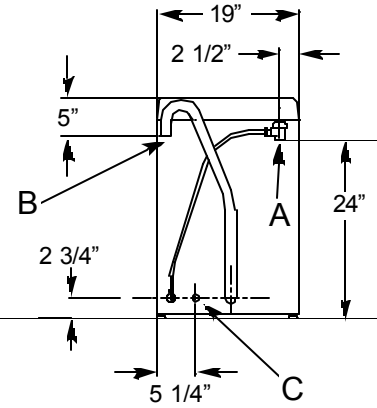
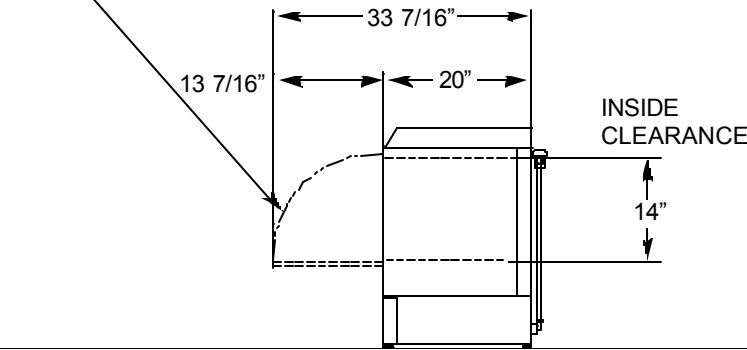
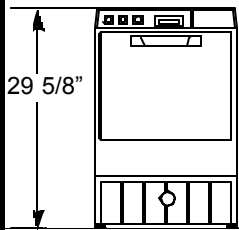

REAR VIEW OF UNIT SHOWING CONNECTIONS

JPX 160

JPX-160 FRONT VIEW



J
P
X

1
6
0

<u>ITEM</u>	<u>QTY</u>	<u>DESCRIPTION</u>	<u>Mfg. No.</u>
01	1	Handle	2020-162-27-73
02	1	Power Switch	2020-142-27-10
03	1	Mode Switch	2020-162-27-12
04	1	Drain Switch	2020-162-27-14
05	1	Metal Facia Panel for Switches	2020-162-28-12
06	1	Digital Display	2020-162-28-55
07	1	Top Black Panel	2020-162-28-08
08	4	Foot for Machine	2020-162-27-43
09	1	Gauge	2020-162-28-75
10	1	Front Panel	2020-162-28-17
11	1	Door	2020-162-28-14

ELECTRICAL PANEL

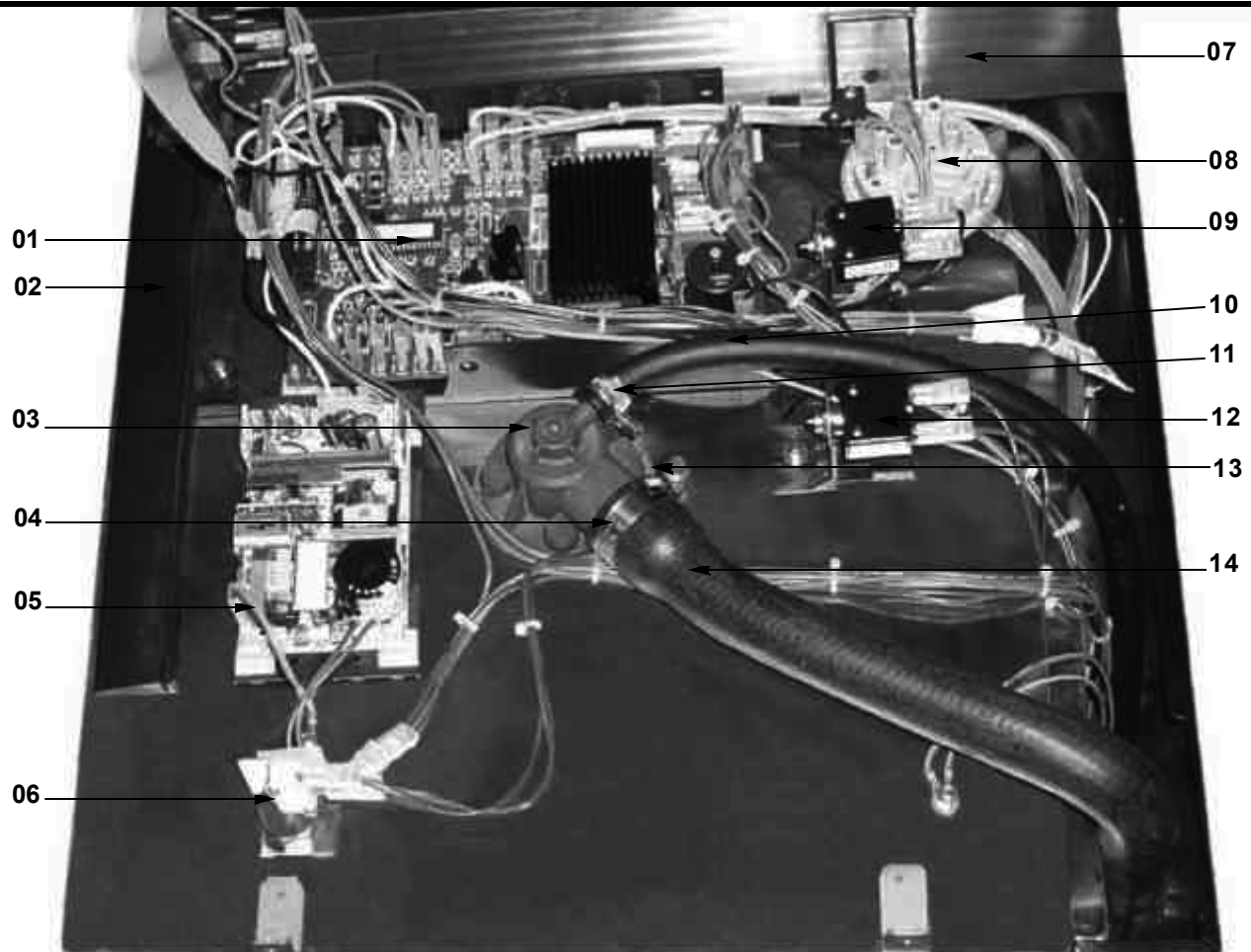

J P X
1 6 0

<u>ITEM</u>	<u>QTY</u>	<u>DESCRIPTION</u>	<u>Mfg. No.</u>
01	1	PCB	2020-162-28-74
02	1	Black Plastic Support for Facia	2020-162-28-11
03	1	Top Boss	2020-162-26-78
04	1	Hose Clamp	2020-162-27-62
05	1	Power Supply Unit	2020-162-28-76
06	1	Door Microswitch with Assembly	2020-162-27-23
07	1	Top Panel	2020-162-28-08
08	1	Gray Pressure Switch	2020-162-27-21
09	1	Thermal Circuit Breaker, 4 Amp	2020-162-68-91
10	1	Hose, Rinse	2020-162-28-24
11	1	Hose Clamp	2020-162-27-60
12	1	Thermal Circuit Breaker, 4 Amp	2020-162-68-91
13	1	Gasket	2020-162-26-80
14	1	Outlet & Pipe	2020-162-26-79

FRONT AND BOTTOM VIEW

J
P
X
1
6
0

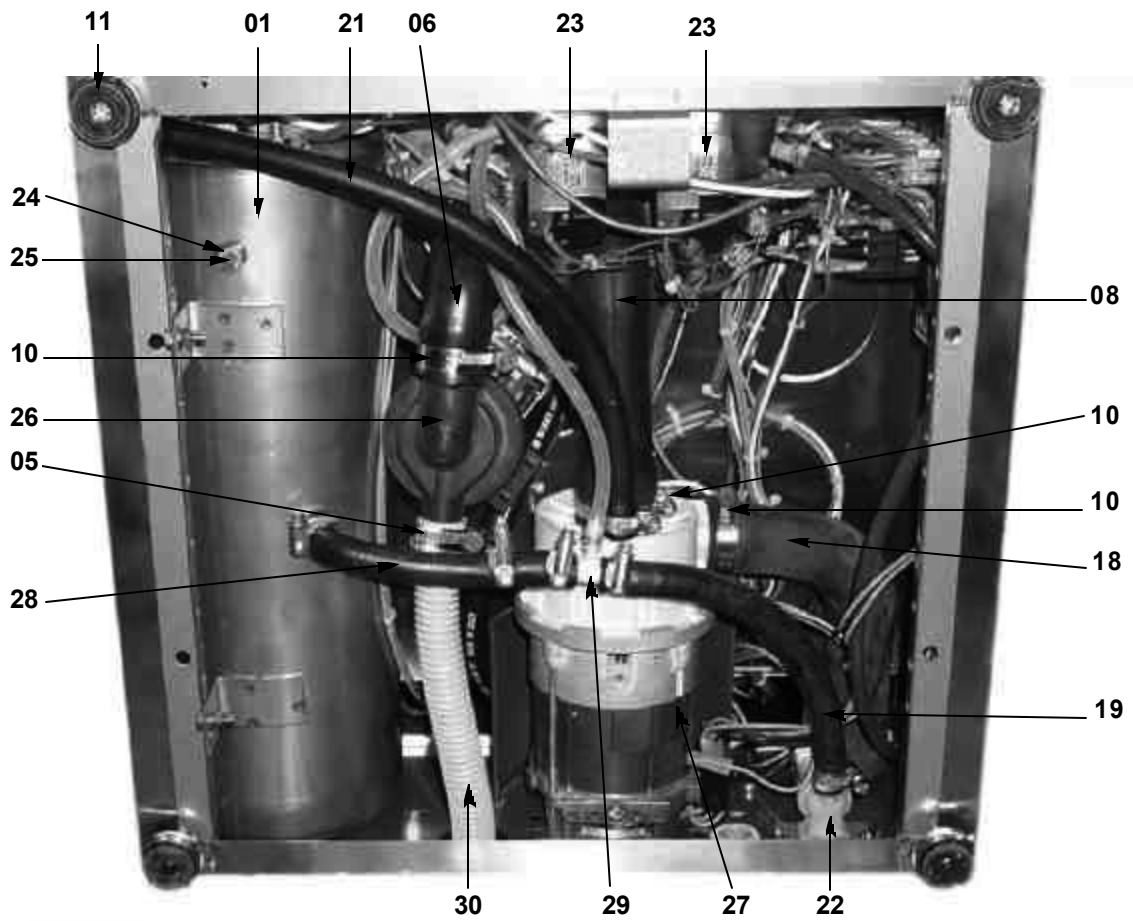
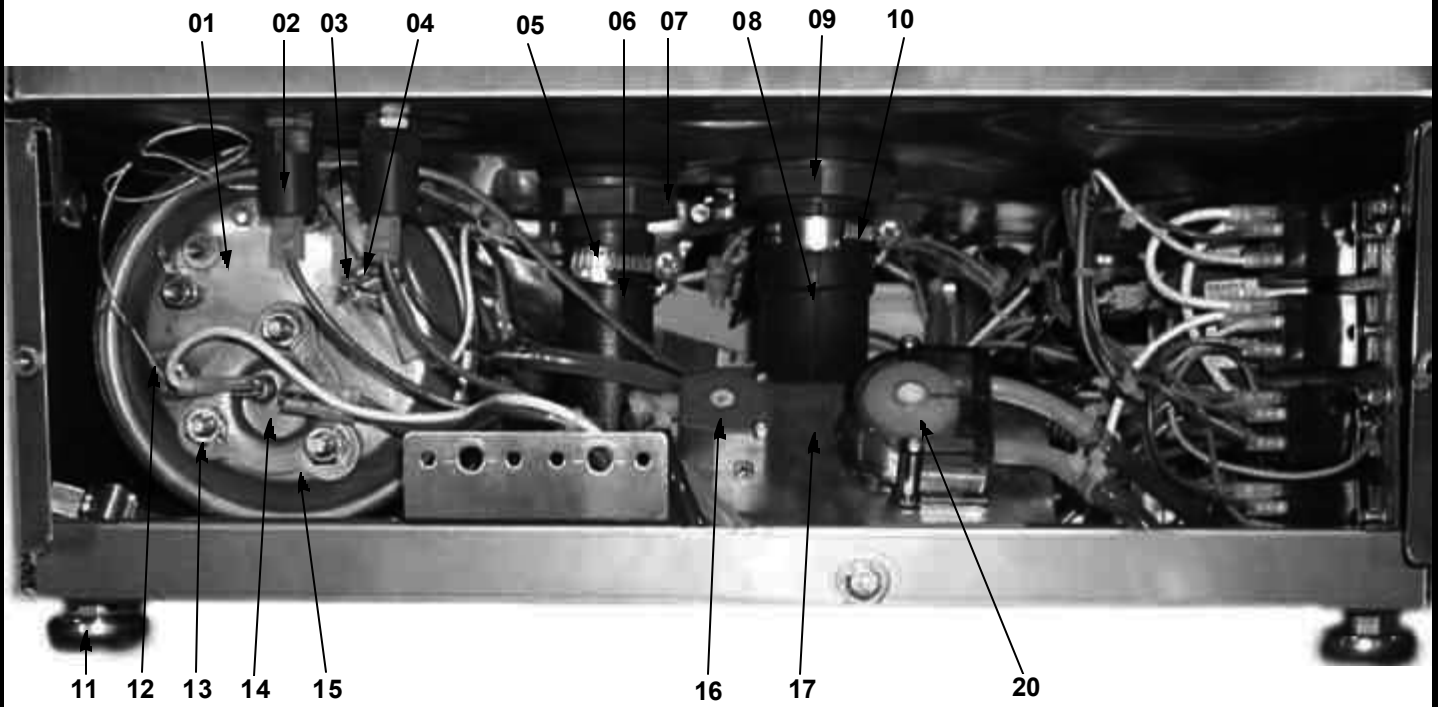

FRONT AND BOTTOM VIEW (CONTINUED)

<u>ITEM</u>	<u>QTY</u>	<u>DESCRIPTION</u>	<u>Mfg. No.</u>
01	1	Rinse Tank	2020-162-28-28
02	2	Terminal Guard	2020-162-28-00
03	1	Nut, Thermal Switch	2020-162-27-96
04	1	Thermostat, High Limit, Rinse Tank	2020-162-27-17
05	2	Hose Clamp	2020-162-27-59
06	1	Hose, Drain Pump Inlet	2020-162-28-06
07	1	Nut, 1" Plastic	2020-142-27-64
08	1	Pump Inlet Hose	2020-162-27-90
09	1	Nut, Plastic	2020-162-27-91
10	4	Hose Clamp	2020-162-27-62
11	4	Foot, Machine	2020-162-27-43
12	1	Thermostat	2020-162-68-13
13	3	Nut, Element Securing	2020-162-27-93
14	1	Heater, Rinse	2020-142-28-49
15	1	Gasket, Heater Element	2020-142-27-92
16	1	Pump Head, Rinse Agent	2020-162-28-31
17	1	Bracket, Soap Pump	2020-162-27-75
18	1	Outlet & Pipe	2020-162-26-79
19	1	Hose, Rinse	2020-162-28-24
20	1	Pump Head, Soap	2020-162-28-30
21	1	Hose, Rinse	2020-162-28-24
22	1	Solenoid Valve, 12 Volts	2020-162-27-03
23	2	Motor, Soap/Rinse Aid Pump	2020-162-28-33
24	1	Washer, Fiber	2020-162-28-05
25	1	Bolt, Drain	2020-162-28-04
26	1	Pump, Drain	2020-162-28-56
27	1	Wash Pump	2020-162-28-23
28	1	Hose, Rinse	2020-162-28-24
29	1	Tee	2020-162-27-26
30	1	Hose, Gray Waste	2020-162-28-57

J P X
1 6 0

REAR VIEW

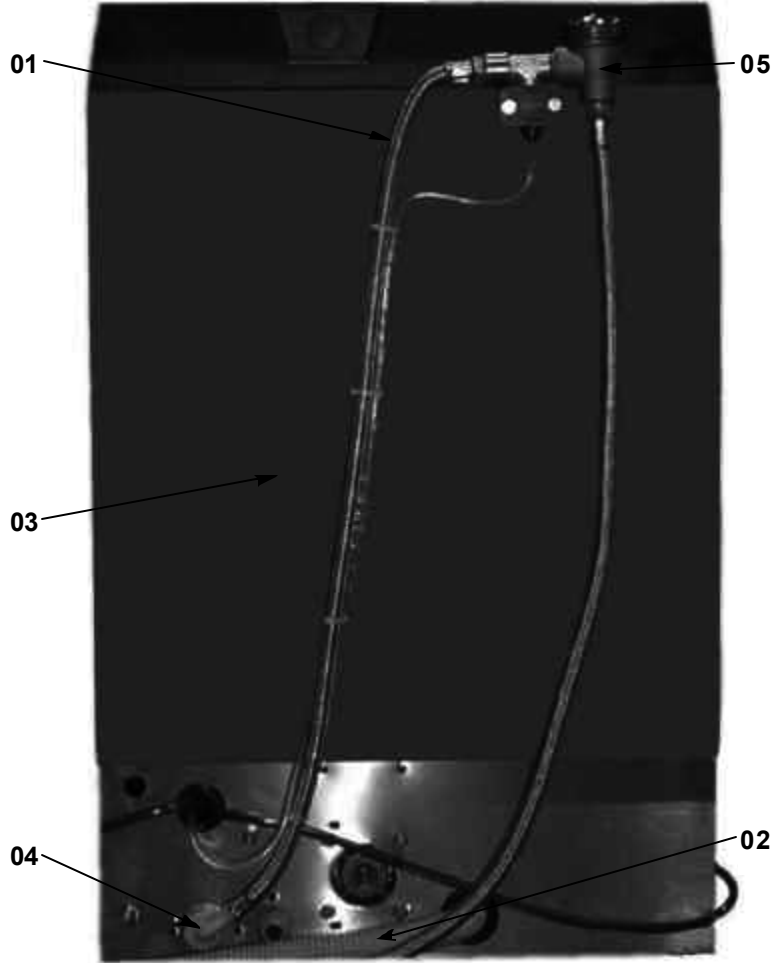

J
P
X
1
6
0

<u>ITEM</u>	<u>QTY</u>	<u>DESCRIPTION</u>	<u>Mfg. No.</u>
01	1	Water Inlet Hose	2020-162-27-84
02	1	Drain Hose	2020-162-28-57
03	1	Back Panel	2020-162-28-13
04	1	Solenoid	2020-162-27-03
05	1	Vacuum Breaker	2020-142-68-84

WASH ARM/RINSE ARM ASSEMBLIES

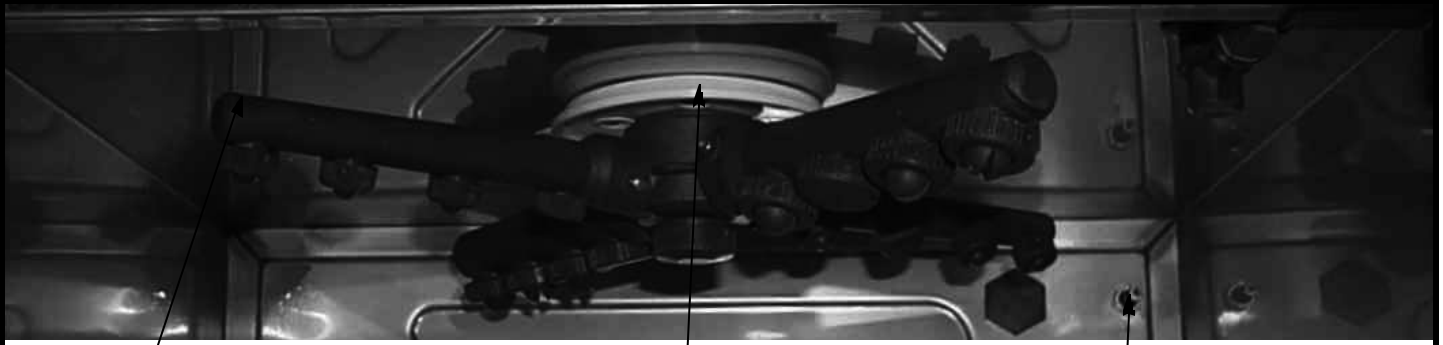

01 02 03 04 05 07 08 09 10

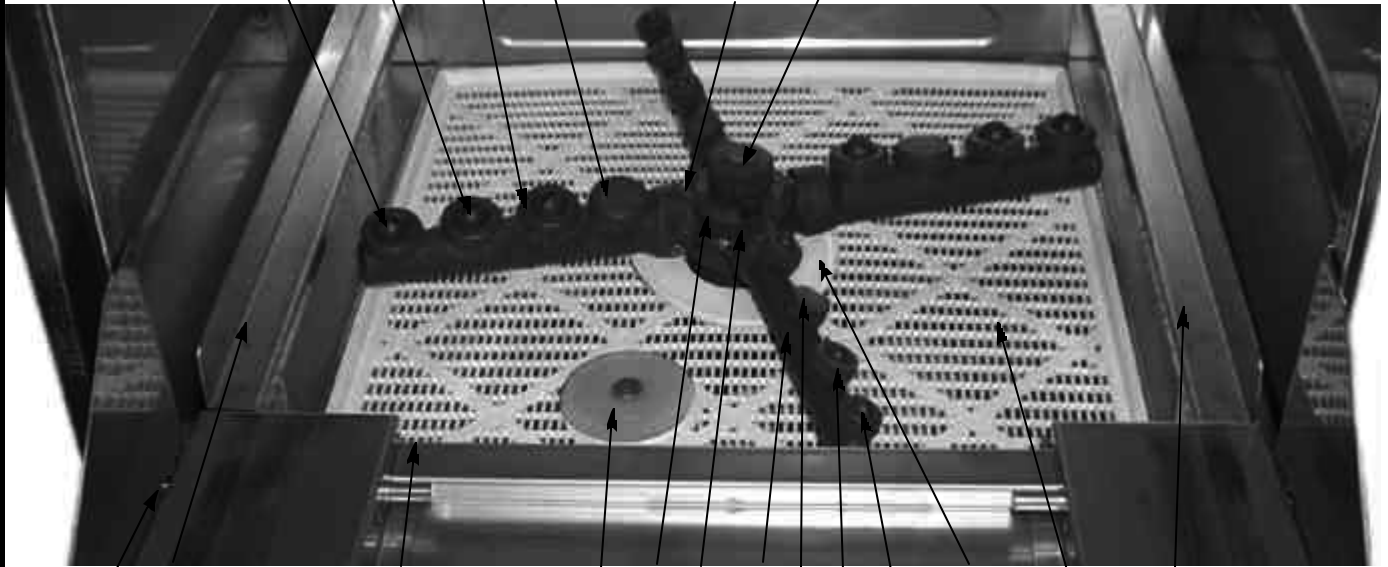

14 *18 19 20 21 22 23 24 17 16 15 06

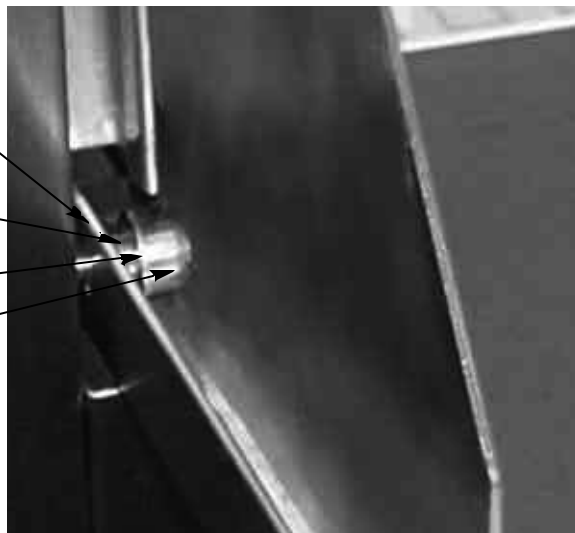

*11
*12
*13

J P X
1 6 0

WASH ARM/RINSE ARM ASSEMBLIES (CONTINUED)

J
P
X
1
6
0

<u>ITEM</u>	<u>QTY</u>	<u>DESCRIPTION</u>	<u>Mfg. No.</u>
01	4	Wash Arm	2020-162-26-75
02	3	Jet, Wash L/H "S"	2020-162-26-65
03	3	Jet, Wash R/H "D"	2020-162-26-54
04	6	Nut, Wash Jet	2020-162-26-63
05	2	Blank, Wash Jet	2020-162-26-64
06	1	Ramp, Right Hand Basket	2020-162-28-10
07	1	Flange, Top	2020-162-26-82
08	4	O-Ring, Wash Arm	2020-162-26-59
09	2	Bolt, 8mm Spindle	2020-162-26-71
10	1	Elbow, Soap Assembly	2020-162-27-35
11	2	Pin, Hinge	2020-162-28-07
12	2	C-Clip, Hinge Pin	2020-162-27-38
13	2	Spacer, Hinge Pin	2020-162-27-39
14	1	Ramp, Left Hand Basket	2020-162-28-09
15	1	Filter, Plastic	2020-162-28-18
16	1	Flange, Bottom	2020-162-26-42
17	12	Jet, Rinse	2020-162-26-57
18	1	Support, Front Filter	2020-162-28-21
19	1	Plug, Drain	2020-162-26-92
20	1	Center Boss	2020-202-26-39
21	4	O-Ring, Rinse Arm	2020-162-26-60
22	4	Rinse Arm	2020-162-26-76
23	4	Blank, Rinse Jet	2020-162-26-58
24	12	Nut, Rinse Jet	2020-162-26-56

INSIDE TUB VIEW

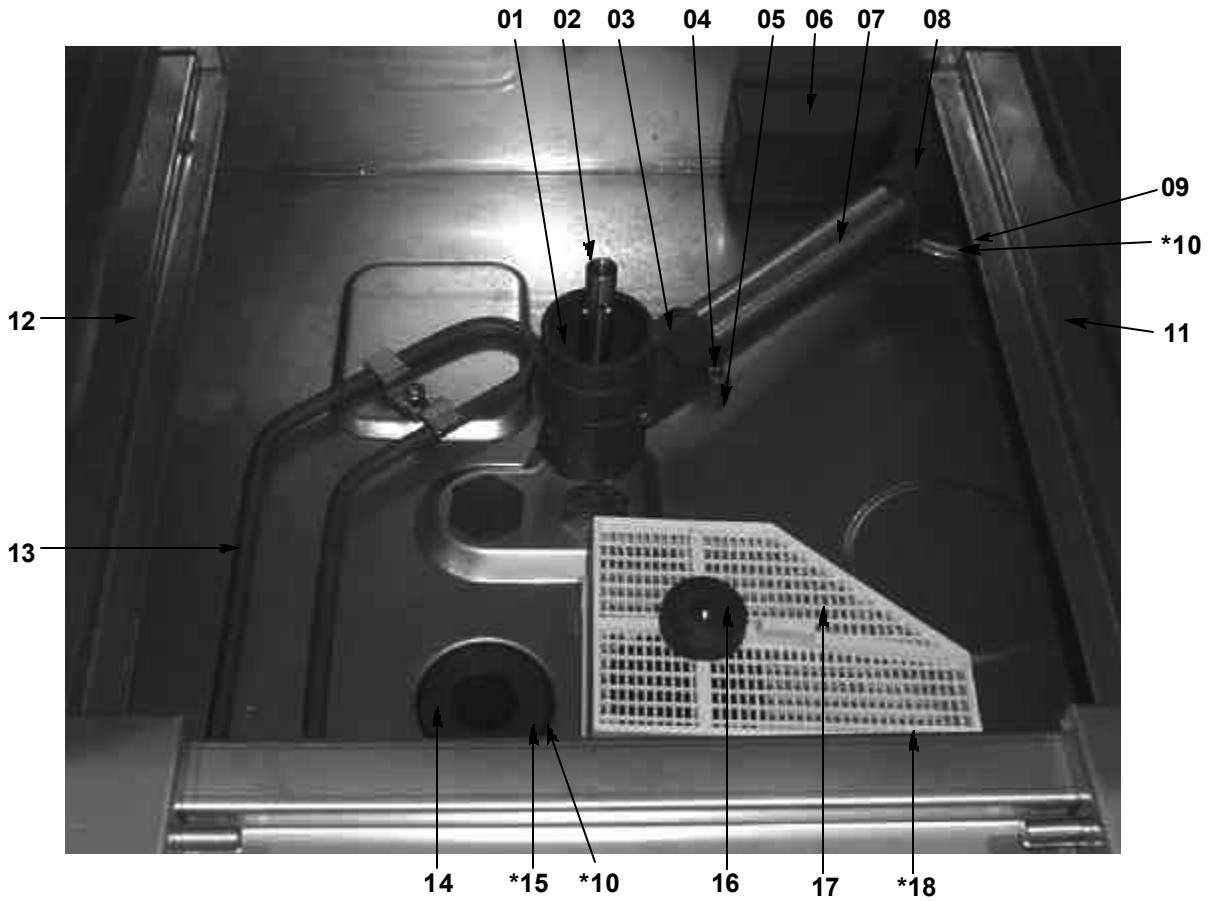

<u>ITEM</u>	<u>QTY</u>	<u>DESCRIPTION</u>	<u>Mfg. No.</u>
01	1	Spacer, Bottom Spindle	2020-162-26-69
02	1	Spindle	2020-162-26-67
03	1	Bottom Boss Assembly	2020-202-26-53
04	1	Screw	2020-162-27-40
05	1	Nut	2020-162-27-47
06	1	Air Trap Assembly	2020-162-26-97
07	1	Tube, Transfer	2020-162-26-74
08	1	Elbow, Assembly	2020-162-26-46
09	1	O-Ring	2020-162-27-83
10*	2	Nut, 1" Plastic	2020-142-27-64
11	1	Right Filter Support	2020-162-28-20
12	1	Left Filter Support	2020-162-28-19
13	1	Element, Wash	2020-162-27-04
14	1	Waste Boss	2020-162-26-94
15*	1	O-Ring	2020-162-27-61
16	1	Nut, Filter	2020-162-27-82
17	1	Wash Filter Body	2020-162-27-86
18	1	Wash Filter Base	2020-162-27-87

J P X
1 6 0

MISCELLANEOUS

J
P
X
1
6
0

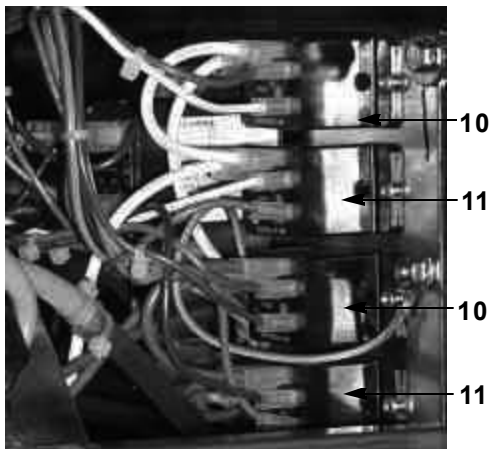
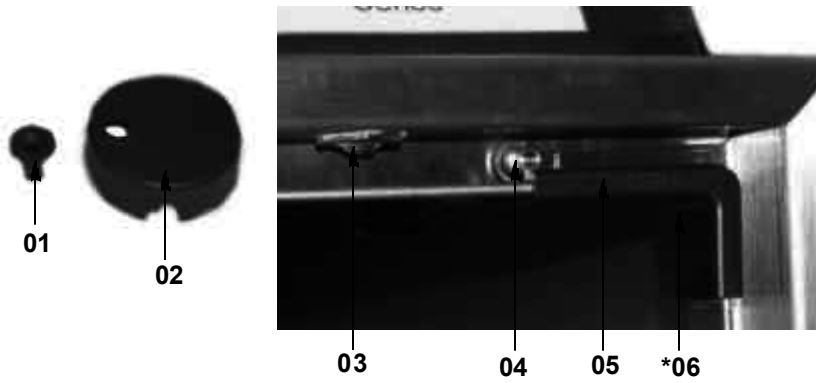

Front View



Bottom Right Side View

<u>ITEM</u>	<u>QTY</u>	<u>DESCRIPTION</u>	<u>Mfg. No.</u>
01	1	Nut, Cover	2020-142-28-01
02	1	Cover, Rinse Element	2020-142-27-99
03	1	Catch, Ball Assembly	2020-162-27-31
04	1	Switch, Micro Door with Assembly	2020-162-27-23
05	2	Corner Piece, External	2020-162-27-33
06	2	Corner Piece, Internal	2020-162-27-32
07	1	Dish Rack	2020-162-68-14
08	1	Plate Rack	2020-162-68-15
09	1	Terminal Block	2020-162-27-20
10	2	Contactor, 240 Volt, 3NO/1NC	2020-142-28-54
11	2	Contactor, 12 Volt Coil, B6C	2020-162-28-53
12	1	Contactor, Safety 240 Volt	2020-162-68-16

JPX-160 ELECTRICAL DIAGRAM 208-240 VOLT, 60 HERTZ, 1 PHASE

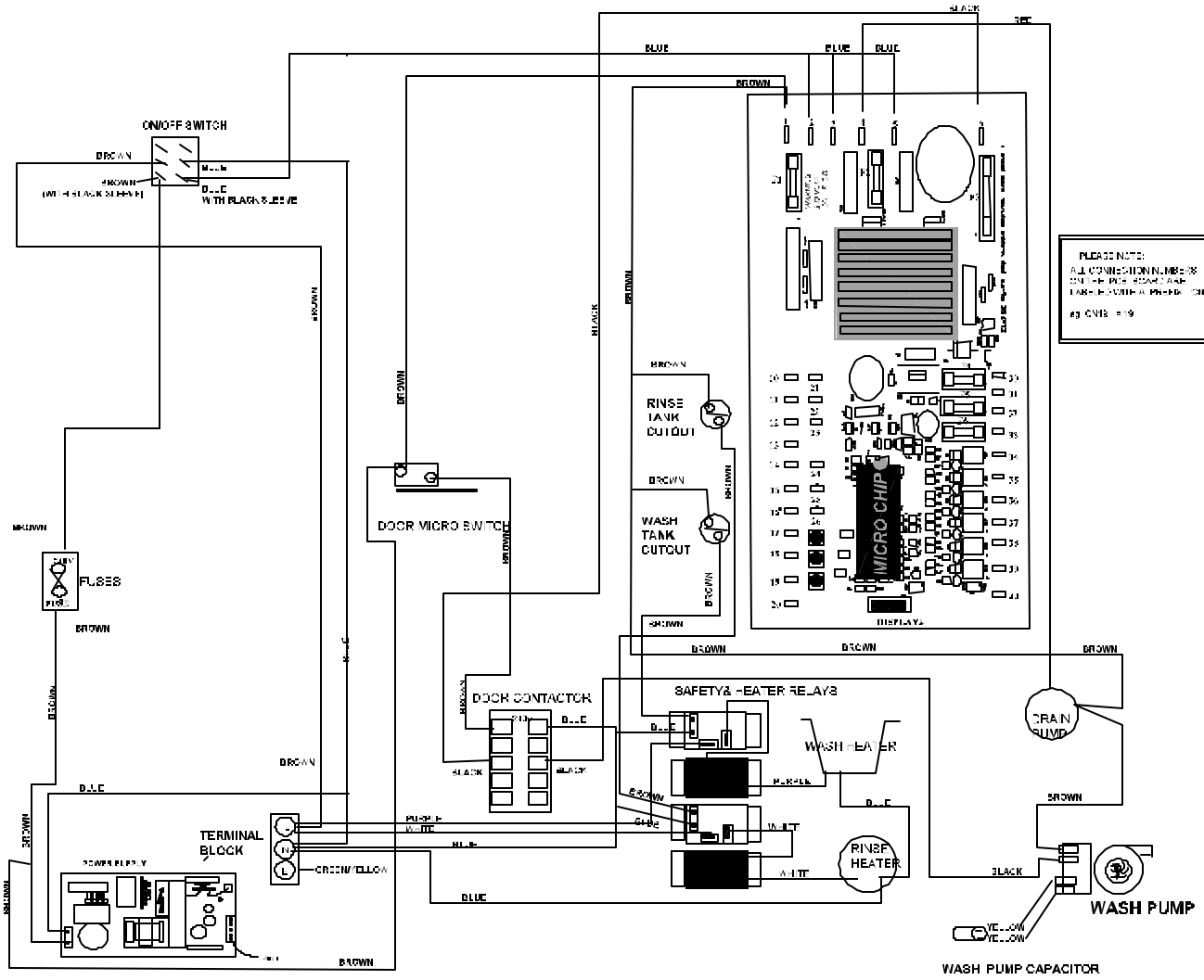

JPX 160

JPX-160 ELECTRICAL DIAGRAM 12 VOLT CIRCUIT

JPX 160

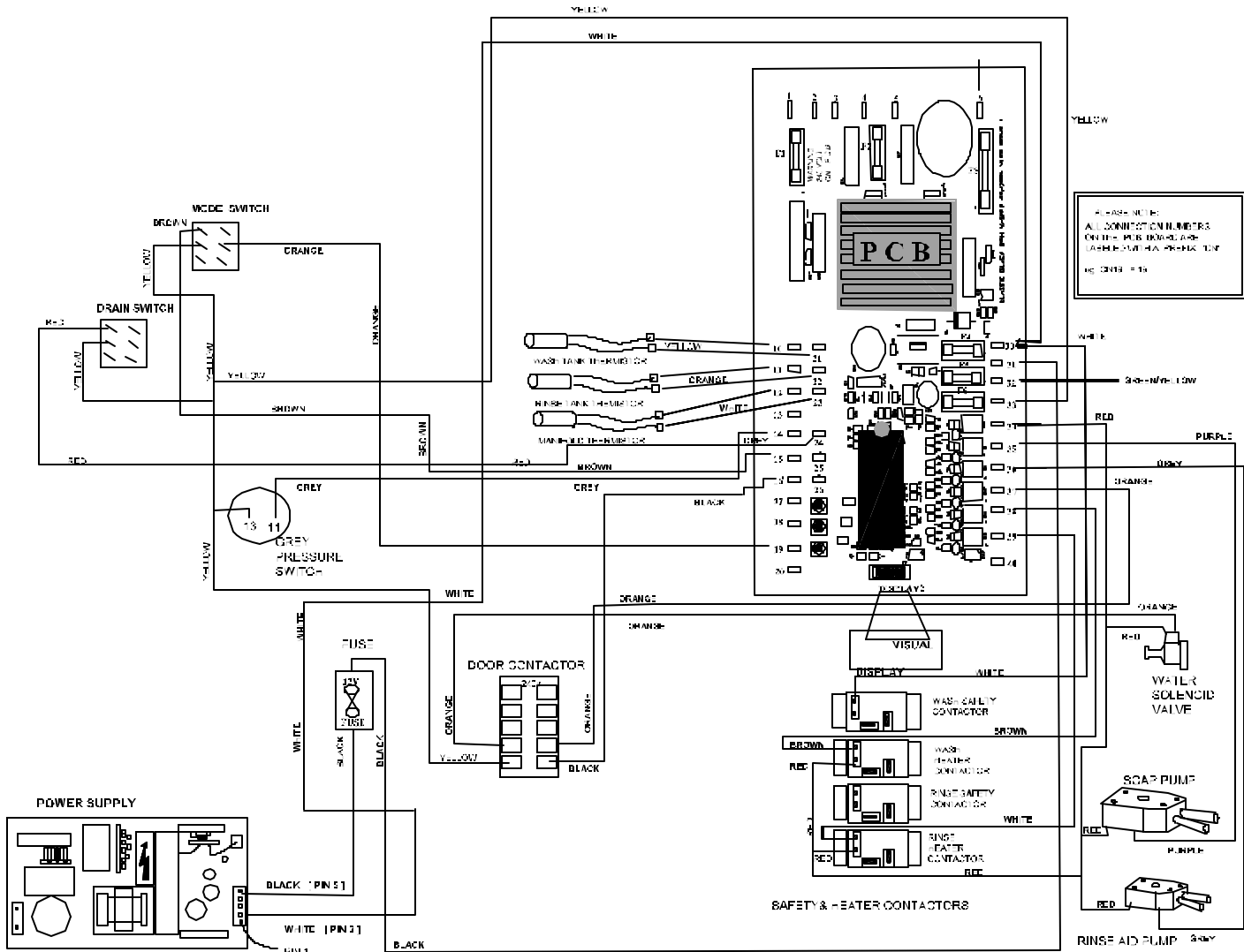

JPX-160 COMPONENTS DIAGRAM

JPX 160

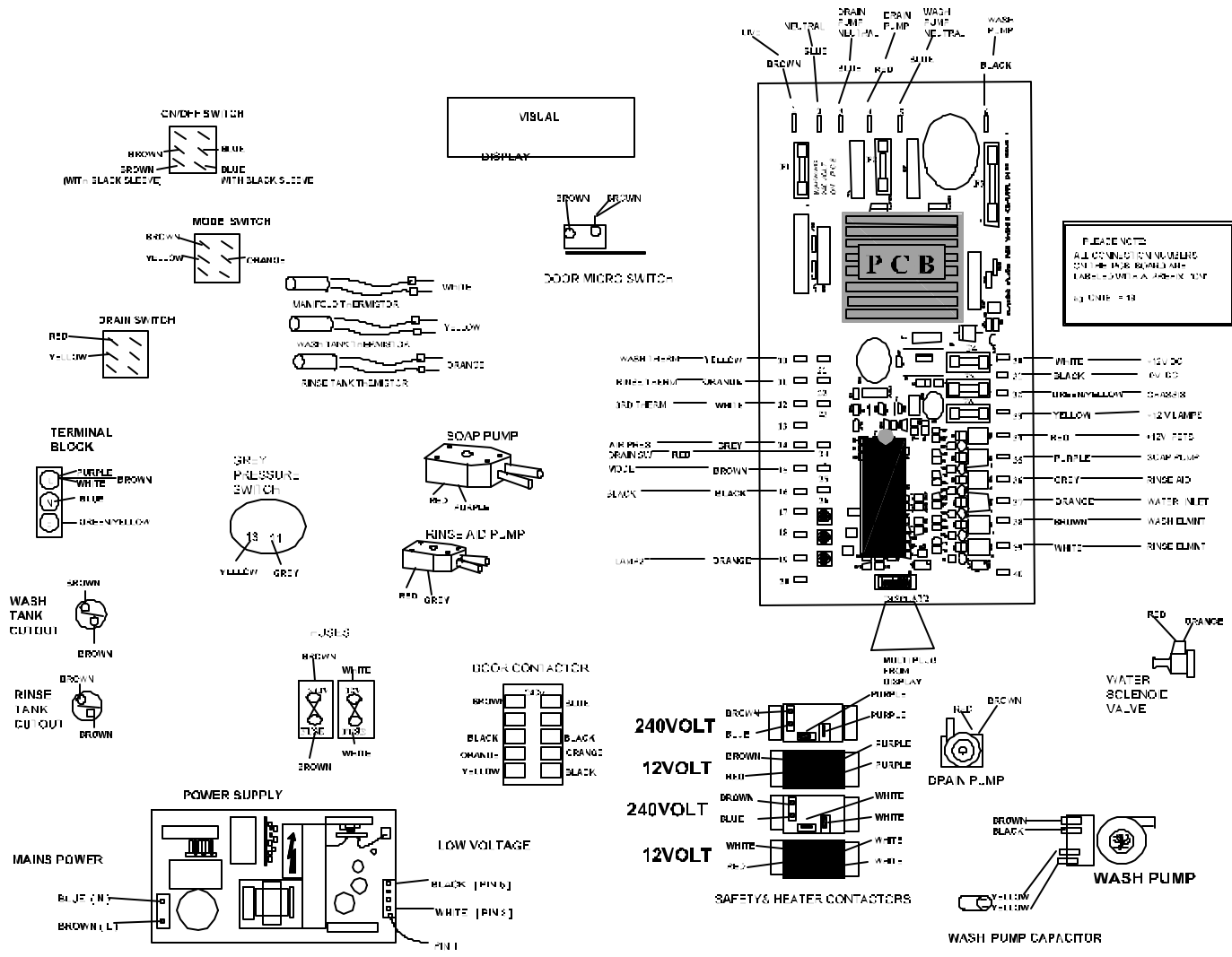

SPECIFICATIONS of the JPX-200

J
P
X
2
0
0

PERFORMANCE/CAPABILITIES

OPERATING CAPACITY (RACKS/HOUR)

RACKS PER HOUR	24
DISHES PER HOUR	600
GLASSES PER HOUR	600

OPERATING CYCLE (SECONDS)

SHORT CYCLE

WASH TIME	105
RINSE TIME	15
TOTAL CYCLE TIME	120

LONG CYCLE

WASH TIME	225
RINSE TIME	15
TOTAL CYCLE TIME	240

TANK CAPACITY (GALLONS)

WASH TANK (MINIMUM)	8.7
RINSE TANK	2.1

TEMPERATURES

WASH---°F (MINIMUM)	150
RINSE---°F	180

ELECTRICAL REQUIREMENTS

WASH PUMP MOTOR HORSEPOWER 1

NOTE: Typical Electrical Circuit is based upon (1) 125% of the full amperage load of the machine and (2) typical fixed-trip circuit breaker sizes as listed in the NEC 2002 Edition. Local codes may require more stringent protection than what is displayed here. Always verify with your electrical service contractor that your circuit protection is adequate and meets all applicable national and local codes. These numbers are provided in this manual simply for reference and may change without notice at any given time.

VOLTS	PH	HZ	RINSE HEATER RATINGS	TOTAL AMPS	TYPICAL ELECTRICAL CIRCUIT
208	1	60	6 KW@208V	45	60 AMP
230	1	60	7.3 KW@230V	48	60 AMP

WATER REQUIREMENTS

INLET TEMPERATURE	140°F
GALLONS PER RACK	.98
GALLONS PER HOUR	23.5
WATER LINE SIZE I.P.S. (Minimum)	1/2"
DRAIN LINE SIZE I.D.	1"
FLOW PRESSURE P.S.I.	20 ± 5

FRAME DIMENSIONS

WIDTH	23"
DEPTH	23 3/4"
HEIGHT	32 1/4"
MAXIMUM INSIDE CLEARANCE	14"

NOTE: Always refer to the machine data plate for specific electrical and water requirements. The material provided on this page is for reference only and may be subject to change without notice.

This equipment is not recommend for use with deionized water or other aggressive fluids. Use of deionized water or other aggressive fluids will result in corrosion and failure of materials and components. Use of deionized water or other aggressive fluids will void the manufacturer's warranty.

DIMENSIONS of the JPX-200

A. 1/2" FNPT 140°F. WATER CONNECTION

B. DRAIN HOSE CONNECTION FOR PUMPED DRAIN FROM THE UNIT. DISCHARGE HEIGHT MUST BE MAINTAINED. UNIT SUPPLIED WITH 1" I.D. X 1 1/2" O.D. X 6'-0" LONG FLEXIBLE HOSE.

C. ELECTRICAL CONNECTION

2 1/2" MIN. WALL CLEARANCE

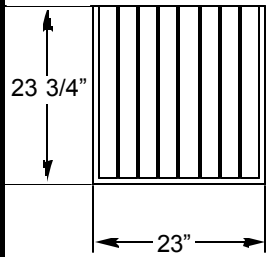

DOOR IN OPEN POSITION

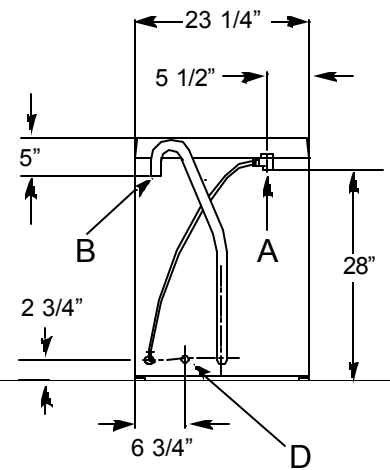
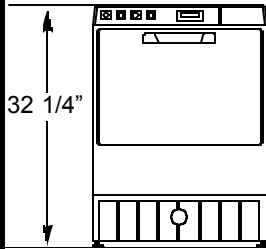
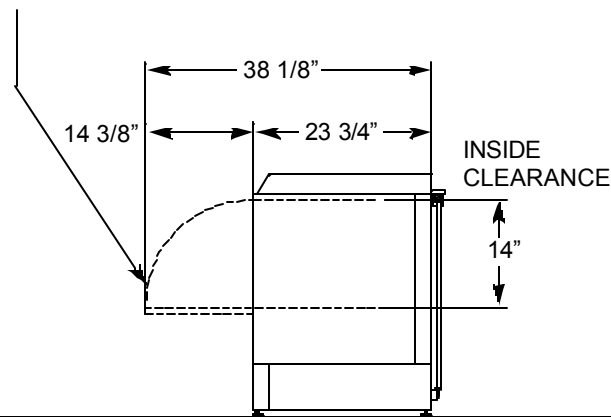

REAR VIEW OF UNIT
SHOWING CONNECTIONS

JPX
200

MAIN ASSEMBLY



J
P
X
2
0
0

<u>ITEM</u>	<u>QTY</u>	<u>DESCRIPTION</u>	<u>Mfg. No.</u>
01	1	Top Panel	2020-202-26-23
02	1	Power Switch	2020-142-27-10
03	1	Mode Switch	2020-162-27-12
04	1	Slow/Fast Switch	2020-202-27-15
05	1	Drain Switch	2020-162-27-14
06	1	Visual Display	2020-162-28-55
07	1	Metal Facia for Switches	2020-202-26-27
08	1	Door Handle	2020-162-27-73
09	1	Pressure Gauge	2020-162-28-75
10	1	Door	2020-202-26-90
11	4	Foot	2020-162-27-43
12	1	Front Bottom Panel	2020-202-26-31

ELECTRICAL PANEL

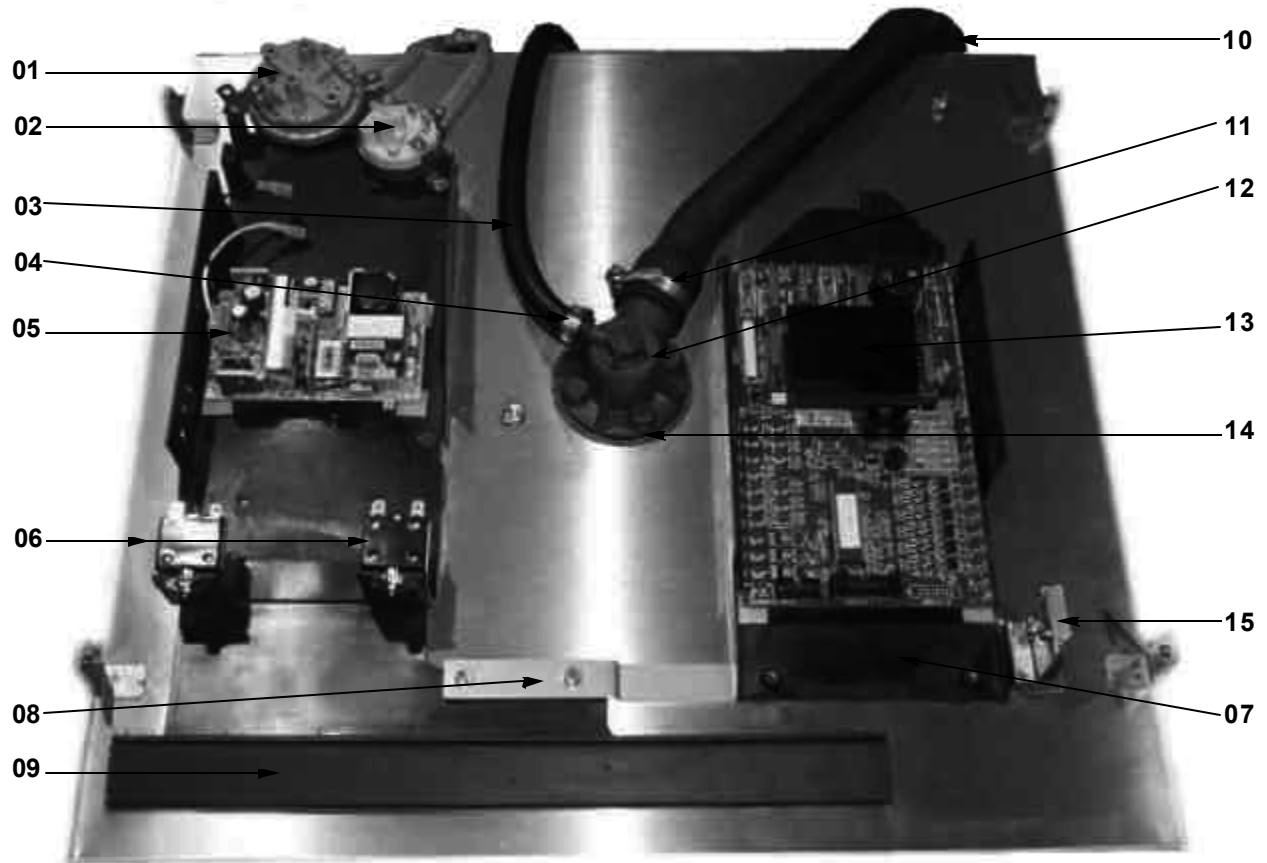

J P X
2 0 0

<u>TEM</u>	<u>QTY</u>	<u>DESCRIPTION</u>	<u>Mfg. No.</u>
01	1	Gray Pressure Switch	2020-162-27-21
02	1	Switch, Pressure, Small (Brown/White)	2020-162-27-22
03	1	Hose, Rinse	2020-162-28-24
04	1	Hose Clamp	2020-162-27-60
05	1	Power Supply Unit	2020-162-28-76
06	2	Switches	2020-162-68-91
07	1	PCB Support Bracket	2020-202-69-10
08	1	Bracket	2020-202-69-09
09	1	Black Plastic Support for Facia	2020-202-26-26
10	1	Outlet & Pipe	2020-202-26-89
11	1	Hose Clamp	2020-162-27-62
12	1	Top Boss	2020-162-26-78
13	1	PCB	2020-162-28-74
14	1	Gasket	2020-162-26-80
15	1	Door Microswitch Assembly	2020-162-27-23

FRONT AND BOTTOM VIEW

J
P
X
2
0
0

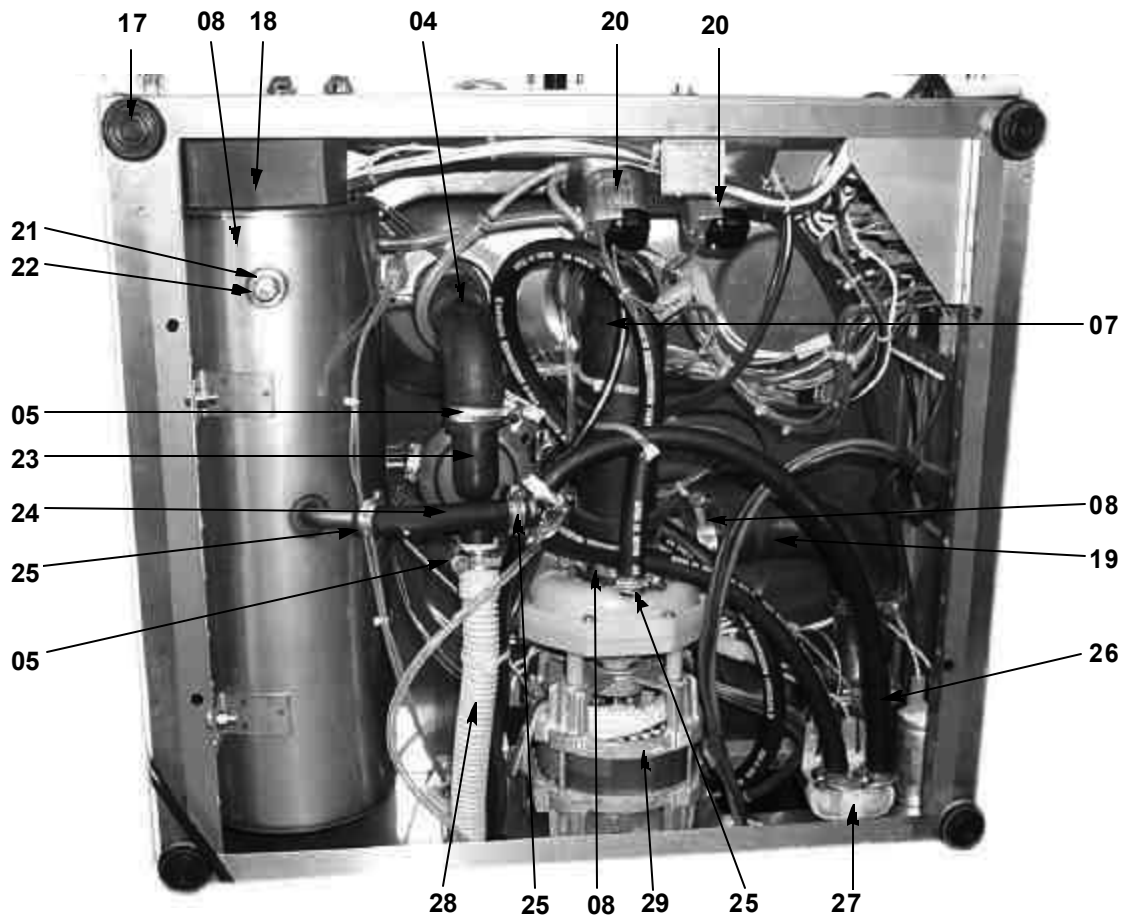
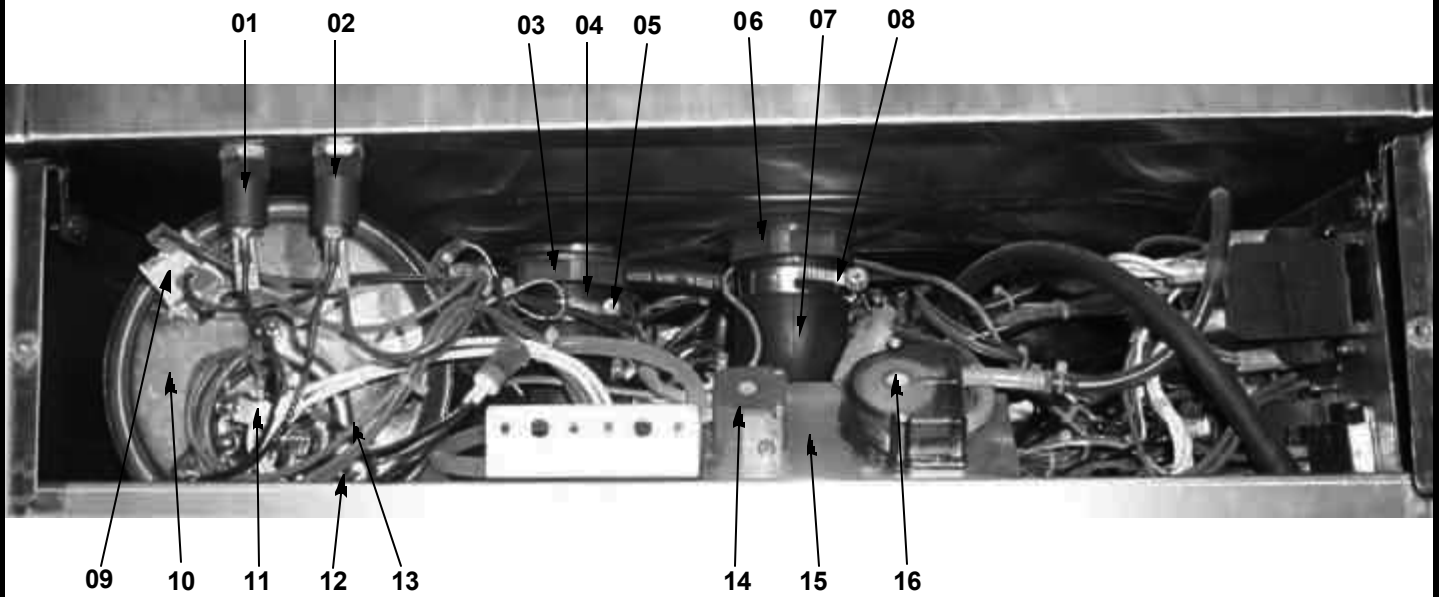

FRONT AND BOTTOM VIEW (CONTINUED)

<u>ITEM</u>	<u>QTY</u>	<u>DESCRIPTION</u>	<u>Mfg. No.</u>
01	1	Wash Element with Washers and Nuts	2020-202-28-39
02	2	Terminal Guard	2020-162-28-00
03	1	Nut, Plastic	2020-162-27-91
04	1	Hose, Pump Drain Inlet	2020-202-28-36
05	3	Hose Clamp	2020-162-27-59
06	1	Nut, 1" Plastic	2020-202-28-48
07	1	Pump Inlet Hose	2020-202-28-47
08	3	Hose Clamp	2020-162-27-62
09	1	Rinse Tank Thermal Switch	2020-162-27-17
10	1	Rinse Tank	2020-202-26-38
11	1	Rinse Heater	2020-202-28-66
12	1	Rinse Heater Gasket	2020-202-28-67
13	3	Nut, Hex	2020-162-27-93
14	1	Pump Head, Rinsing Agent	2020-162-28-31
15	1	Bracket, Soap Pump	2020-162-27-75
16	1	Pump Head, Soap	2020-162-28-30
17	4	Foot, Machine	2020-162-27-43
18	1	Cover, Rinse Heater	2020-162-28-00
19	1	Outlet & Pipe	2020-202-26-89
20	2	Motor, Pump Head	2020-162-28-33
21	1	Washer, Fiber	2020-162-28-05
22	1	Bolt, Drain	2020-162-28-04
23	1	Pump, Drain	2020-162-28-56
24	1	Hose, Rinse	2020-162-28-24
25	2	Hose Clamp	2020-162-27-60
26	2	Hose Clamp	2020-162-27-60
27	1	Solenoid Valve, 12V, Double, Water	2020-202-37-20
28	1	Hose, Gray Waste	2020-162-28-57
29	1	Wash Pump	2020-202-28-40

J P X
2 0 0

REAR VIEW

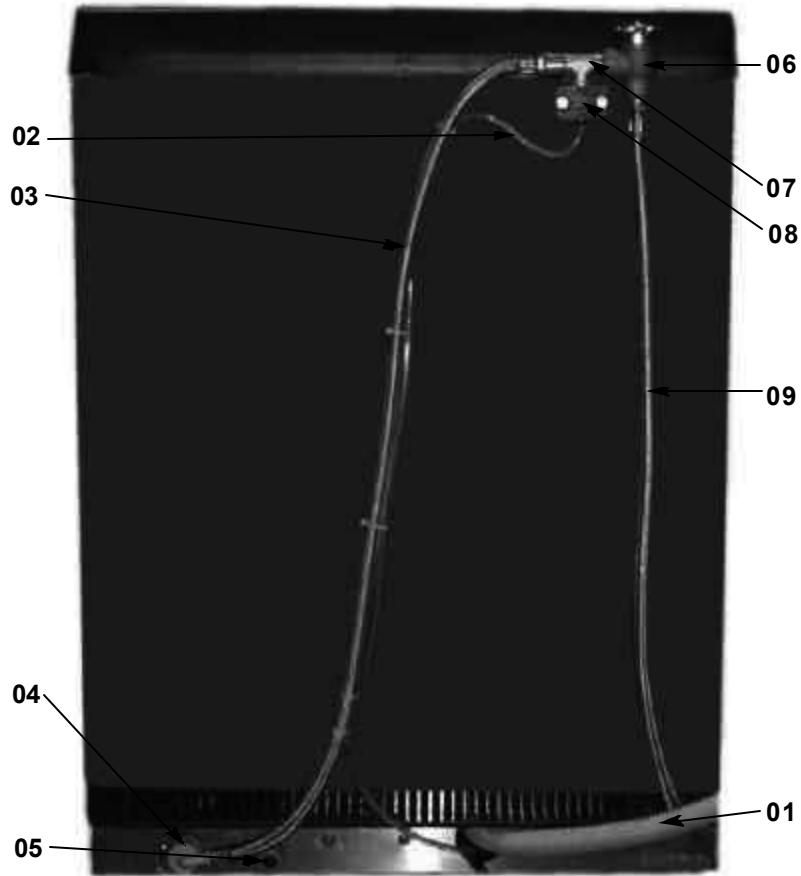

J
P
X
2
0
0

<u>TEM</u>	<u>QTY</u>	<u>DESCRIPTION</u>	<u>Mfg. No.</u>
01	1	Drain Hose	2020-162-28-57
02	1	Water Inlet Hose	2020-162-27-84
03	1	Back Panel	2020-202-26-28
04	1	Solenoid Valve, 12V Double Water	2020-202-37-20
05	1	Conduit Connector Fitting	2020-202-69-07
06	1	Vacuum Breaker	2020-142-68-84
07	1	Tee	2020-142-68-85
08	1	Tee	2020-202-69-08
09	1	Hose	2020-162-27-84

WASH ARM/RINSE ARM ASSEMBLIES

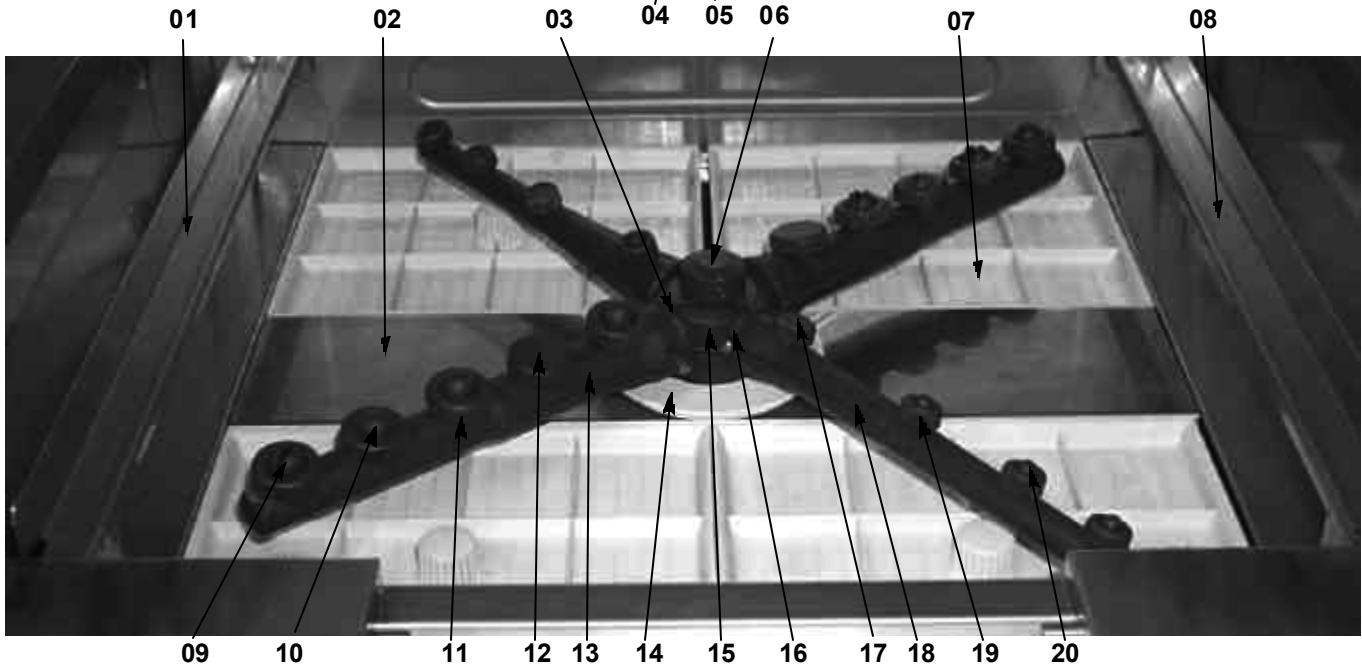

<u>ITEM</u>	<u>QTY</u>	<u>DESCRIPTION</u>	<u>Mfg. No.</u>
01	1	Left Hand Basket Ramp	2020-202-26-24
02	1	Center Filter Support	2020-202-26-34
03	2	Wash Arm O-Ring	2020-162-26-59
04	4	Screw	2020-162-26-50
05	1	Top Flange	2020-162-26-82
06	1	Bolt, 8mm Spindle	2020-162-26-71
07	4	Primary Filter	2020-202-26-32
08	1	Right Hand Basket Ramp	2020-202-26-25
09	4	Wash Jet, L/H, "S"	2020-162-26-65
10	4	Wash Jet, R/H, "D"	2020-162-26-54
11	8	Wash Jet Nut	2020-162-26-63
12	2	Wash Jet Blank	2020-162-26-64
13	2	Wash Arm	2020-202-26-86
14	1	Bottom Flange	2020-162-26-42
15	1	Center Boss	2020-202-26-39
16	2	Rinse Arm O-Ring	2020-162-26-60
17	2	Rinse Jet Blank	2020-162-26-58
18	2	Rinse Arm	2020-202-26-87
19	6	Rinse Jet Nut	2020-162-26-56
20	6	Rinse Jet	2020-162-26-57

INSIDE TUB VIEW

J P X
2 0 0

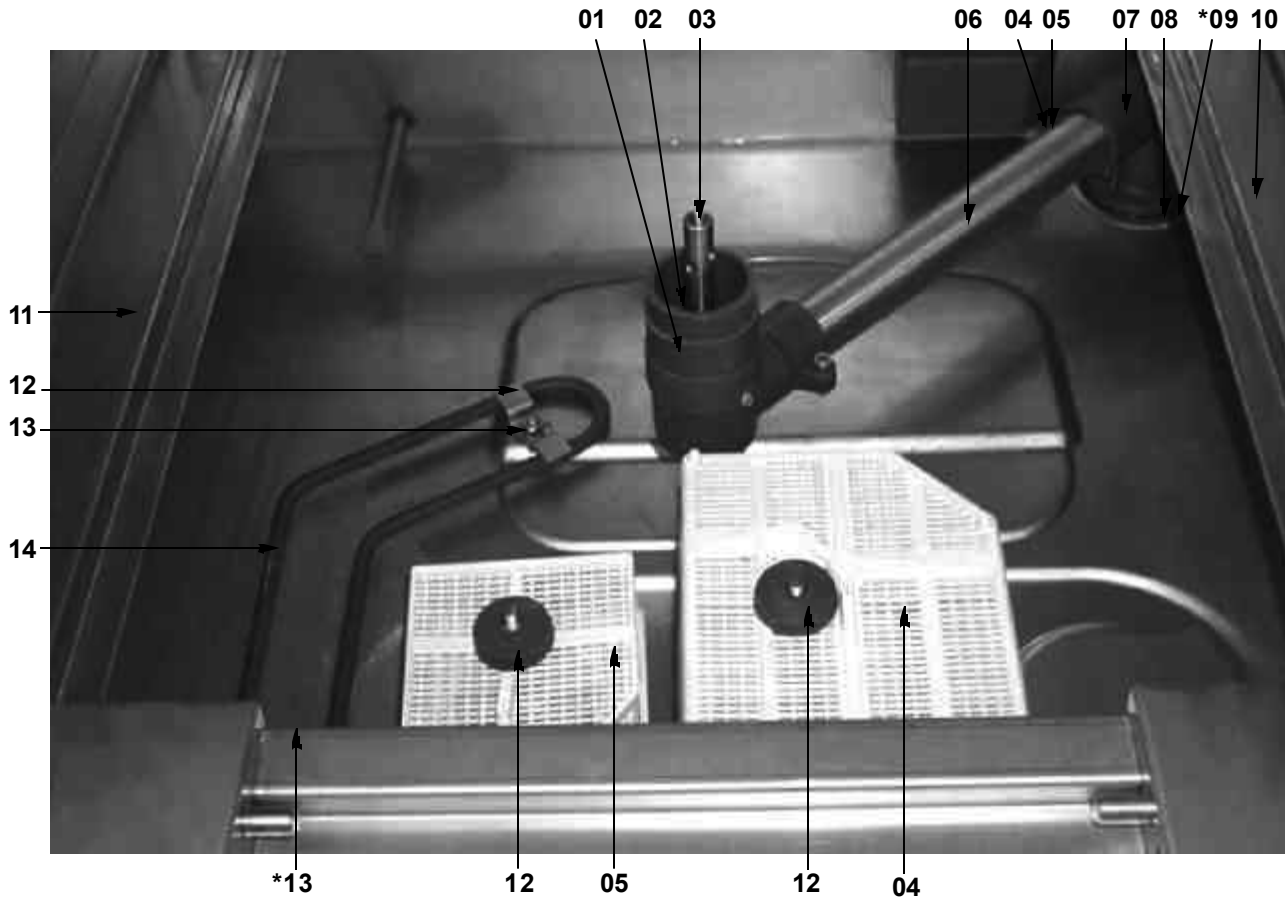

* Indicates Item Not Shown

<u>ITEM</u>	<u>QTY</u>	<u>DESCRIPTION</u>	<u>Mfg. No.</u>
01	1	Bottom Boss Assembly	2020-202-26-53
02	1	Bottom Spindle Spacer	2020-202-26-70
03	1	Top Spindle	2020-162-26-67
04	1	Wash Filter	2020-202-28-43
05	1	Drain Filter	2020-202-27-85
06	1	Tube, Transfer	2020-202-26-85
07	1	Elbow Assembly	2020-202-26-47
08	1	O-Ring	2020-162-27-83
09	1	Nut, 1" Plastic	2020-142-27-64
10	1	Support, Right Filter	2020-162-28-20
11	1	Support, Left Filter	2020-162-28-19
12	2	Filter Nut	2020-162-27-82
13	1	Support, Front Filter	2020-202-26-35
14	1	Wash Element with Washers and Nuts	2020-202-28-39

MISCELLANEOUS

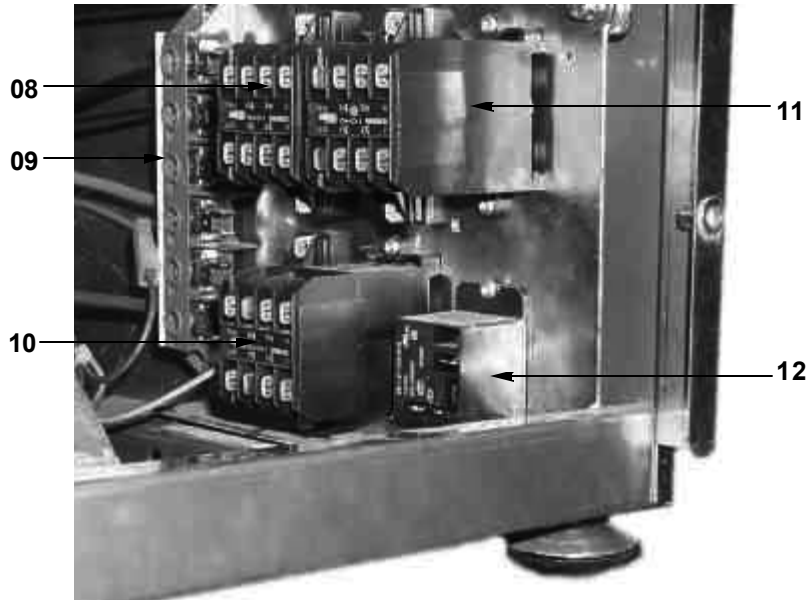
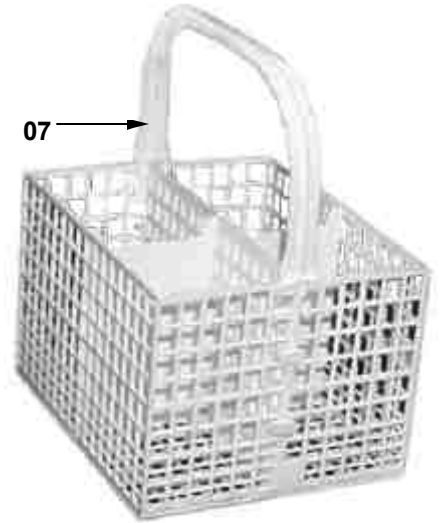
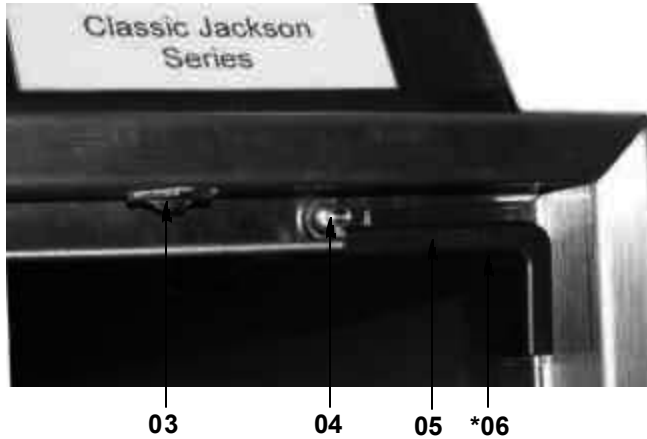

J
P
X
2
0
0

<u>ITEM</u>	<u>QTY</u>	<u>DESCRIPTION</u>	<u>Mfg. No.</u>
01	1	Rinse Element Cover	2020-142-27-99
02	1	Cover Nut	2020-142-28-01
03	1	Catch Ball Assembly	2020-162-27-31
04	1	Door Microswitch Assembly	2020-162-27-23
05	2	External Corner Piece	2020-162-27-33
06	2	Internal Corner Piece	2020-162-27-32
07	1	Silverware Strainer Basket	2020-202-68-26
08	1	Contactor, 240V	2020-142-28-54
09	1	Terminal Block	2020-202-27-19
10	1	Contactor, 240V	2020-142-28-54
11	1	Contactor, 12V	2020-162-28-53
12	1	Contactor, 12V Wash Heater Relay	2020-162-28-52

JPX-200 ELECTRICAL DIAGRAM 208-230 VOLT, 60 HERTZ, 1 PHASE

JPX 200

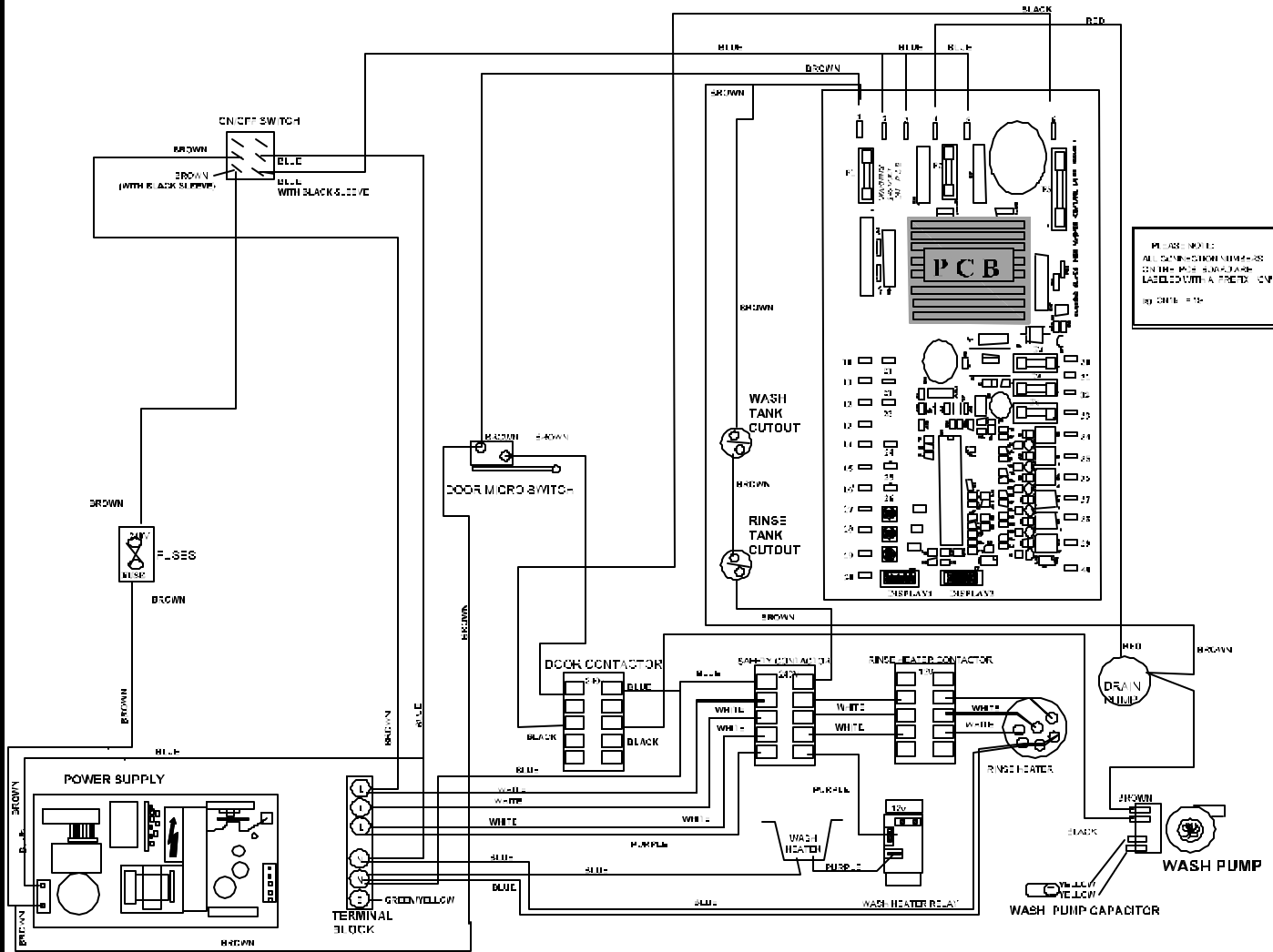

JPX-200 ELECTRICAL DIAGRAM 12 VOLT CIRCUIT

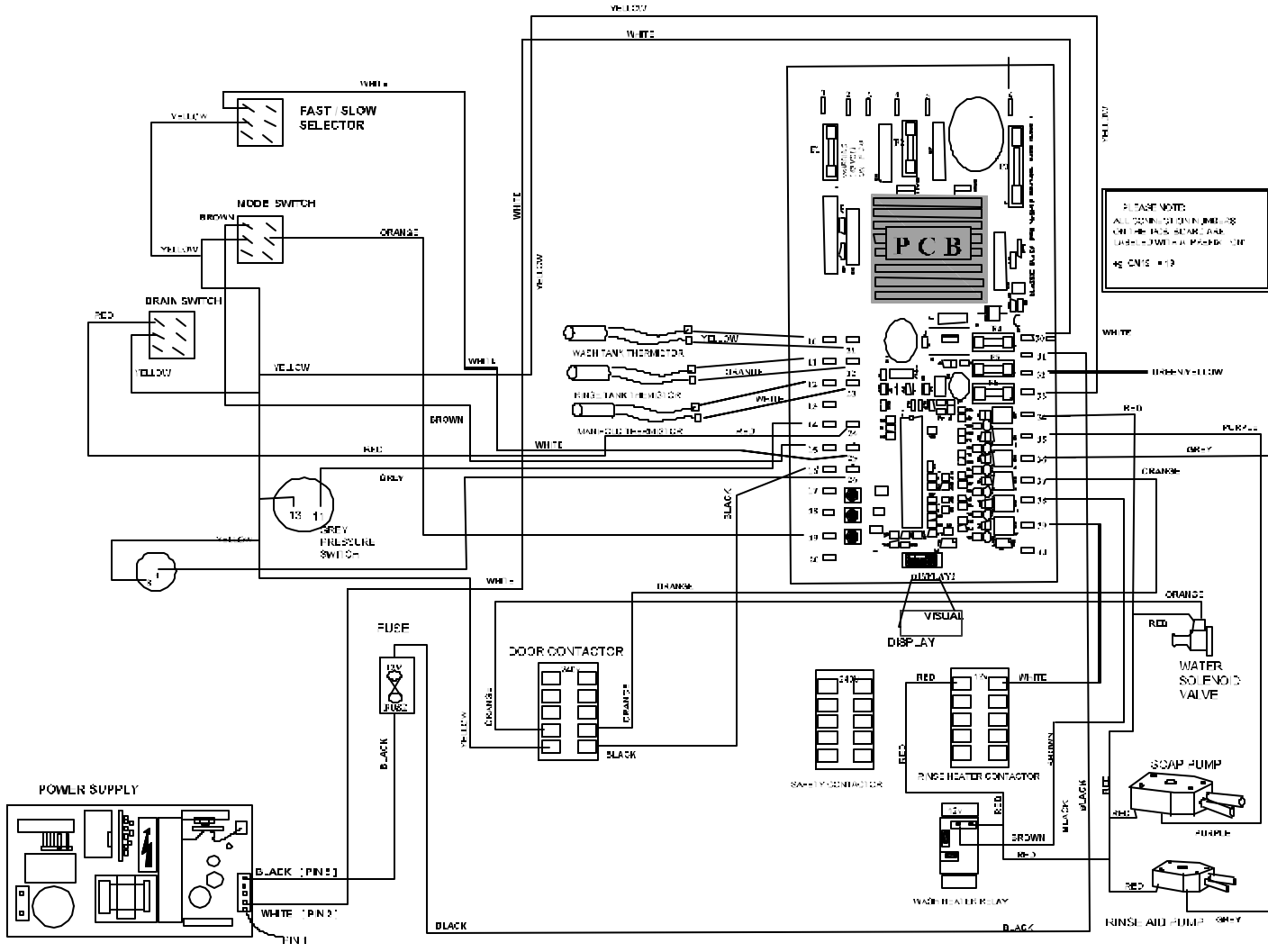

JPX 200

JPX-200 COMPONENTS DIAGRAM

J
P
X
2
0
0

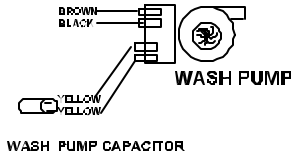
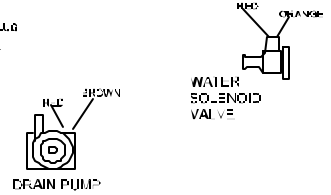
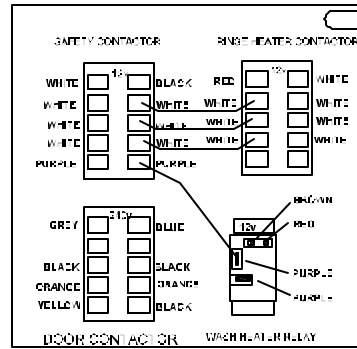
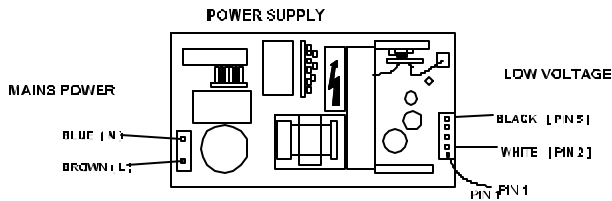
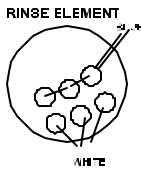
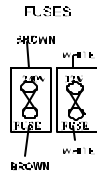
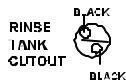
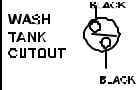
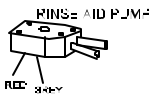
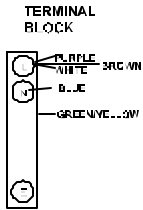
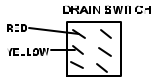
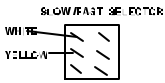
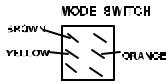
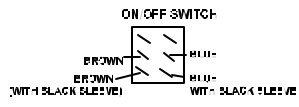

PLEASE NOTE:
ALL CONNECTION NUMBERS
ON THE PCB BOARD ARE
LABELLED WITH A FREQUENCY
BY CNIS - 9

