

MB MASTER-BILT® Refrigeration Solutions



BMG/TMG -27, 48, 52, 74, 80 LAE CONTROLLER Installation & Operations Manual

Master-Bilt Products
908 Highway 15 North
New Albany, MS 38652
Phone: (800) 684-8988

PN 075-90000
Rev 4-26-11

TABLE OF CONTENTS

INTRODUCTION.....	4
STORE CONDITIONS.....	4
WARNING LABELS AND SAFETY INSTRUCTIONS.....	5
PRE-INSTALLATION INSTRUCTIONS.....	6
Inspection for Shipping Damage.....	6
INSTALLATION INSTRUCTIONS.....	6
General Instructions.....	6
Mechanical	6
Electrical.....	7
Leg and Condensate Pan Installation.....	8
Doors	8
ELECTRONIC CONTROLLER.....	9-10
SERVICE INSTRUCTIONS	11
TEMPERATURE SENSORS AND FAN MOTOR REPLACEMENT.....	12
FINAL CHECK LIST.....	12
MASTER-BILT PART NUMBERS	13
ACCESSORIES	13
SALE AND DISPOSAL	14
WIRING DIAGRAMS BMG/TMG.....	15-17

INTRODUCTION

Thank you for purchasing a Master-Bilt cabinet. This manual contains important instructions for installing, using, and servicing a Master-Bilt **BMG/TMG** case. A parts list is included with this manual. Read all these documents carefully before installing or servicing your equipment.

STORE CONDITIONS

The Master-Bilt **BMG/TMG** cases are designed to operate in the controlled environment of an air-conditioned store. The store temperature should be at or below 75°F and a relative humidity of 55% or less. At higher temperature or humidity conditions, the performance of these cases may be affected and the capacity diminished.

The Master-Bilt **BMG/TMG** should not be positioned where it is directly exposed to rays of sun or near a direct source of radiant heat or airflow. This will adversely affect the case and will result in poor performance.

If this case is to be located against a wall, there should be at least 4" space between the wall and the back of the case. This space will allow for the circulation of air behind the case, which will prevent condensation on the exterior surfaces.



NOTICE

Read this manual before installing your cabinet. Keep the manual and refer to it before doing any service on the equipment. Failure to do so could result in personal injury or damage to the cabinet.



DANGER

Improper or faulty hook-up of electrical components on the refrigeration units can result in severe injury or death.

All electrical wiring hook-ups must be done in accordance with all applicable local, regional or national standards.



NOTICE

Installation and service of the refrigeration and electrical components of the cabinet must be performed by a refrigeration mechanic and/or a licensed electrician.

The portions of this manual covering refrigeration and electrical components contain technical instructions intended only for persons qualified to perform refrigeration and electrical work.

This manual cannot cover every installation, use or service situation. If you need additional information, call or write us:

Customer Service Department
Master-Bilt Products
Highway 15 North
New Albany, MS 38652
Phone (800) 684-8988
Fax (800) 684-8988

WARNING LABELS AND SAFETY INSTRUCTIONS



This symbol is the safety-alert symbol. When you see this symbol on your cabinet or in this manual, be alert to the potential for personal injury or damage to your equipment.

Be sure you understand all safety messages and always follow recommended precautions and safe operating practices.



NOTICE TO EMPLOYERS

You must make sure that everyone who installs, uses or services your cabinet is thoroughly familiar with all safety information and procedures.

Important safety information is presented in this section and throughout the manual. The following signal words are used in the warnings and safety messages:

DANGER: Severe injury or death will occur if you ignore the message.

WARNING: Severe injury or death can occur if you ignore the message.

CAUTION: Minor injury or damage to your cabinet can occur if you ignore the message.

NOTICE: This is important installation, operation or service information. If you ignore the message, you may damage your cabinet.

The warning and safety labels shown throughout this manual are placed on your Master-Bilt Products cabinet at the factory. Follow all warning label instructions. If any warning or safety labels become lost or damaged, call your customer service department at (800) 684-8988 for replacements.

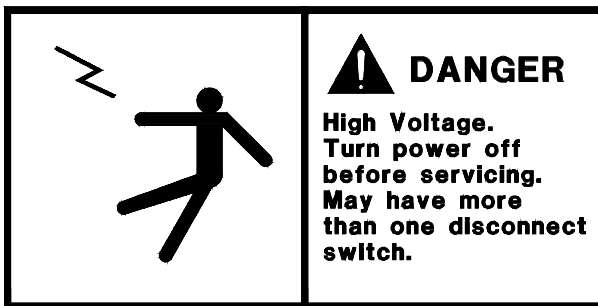

This label is attached to the cabinet power cord label and on the wiring channel.

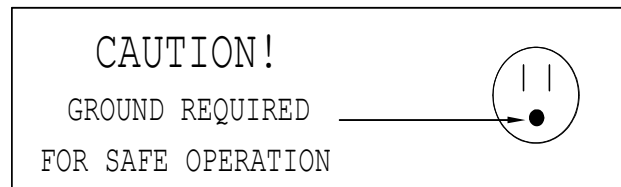

This label is located on top of the electrical control on models with a power cord.

PRE-INSTALLATION INSTRUCTIONS

INSPECTION FOR SHIPPING DAMAGE

You are responsible for filing all freight claims with the delivering truck line. Inspect all cartons and crates for damage as soon as they arrive. If damage is noted to shipping crates or cartons or if a shortage is found, note this on the bill of lading (all copies) prior to signing.

If damage is discovered when the cabinet is uncrated, immediately call the delivering truck line and follow up the call with a written report indicating concealed damage to your shipment. Ask for an immediate inspection of your concealed damage item. Crating material must be retained to show the inspector from the truck line.

INSTALLATION INSTRUCTIONS

GENERAL INSTRUCTIONS

1. Be sure the equipment is properly installed by competent service people.
2. Keep the equipment clean and sanitary so it will meet your local sanitation codes. Clean the cabinet with a mild detergent and water, then rinse.
3. Rotate your stock so that older stock does not accumulate. This is especially important for ice cream. A "First-In, First-Out" rotation practice will keep the products in good salable condition.
4. Do not place product in the case when it is soft or partially thawed. Also, product should not be put in the case for at least 6 hours after it is started.
5. Stock cases as quickly as possible, exposing only small quantities to store temperatures for short periods of time.
6. When replacing burned out fluorescent tubes, be sure that the electrical power to the lighting circuit is turned off.

NOTICE TO STORE OWNERS / MANAGERS

Moisture or liquid around or under the cabinet is a potential slip/fall hazard for persons walking by or working in the general area of the cabinet. Any cabinet malfunction or housekeeping problem that creates a slip/fall hazard around or under the cabinet should be corrected immediately.

If moisture or liquid is observed around or under a Master-Bilt cabinet, an immediate investigation should be made by qualified personnel to determine the source of the moisture or liquid. The investigation should determine if the cabinet is malfunctioning or if there is a drainpipe leaking.

MECHANICAL

Remove front grille and check refrigeration lines to see that they are free (not touching each other or compressor). Spin condenser fan blade to see that it is free.

The compressor is hermetic, it is internally spring mounted and ready to run.

Remove cabinet from crate base and slide into location. Cabinet must be level from side to side and front to back for correct draining of coil pan and for self-closing doors to operate correctly. Allow minimum of 4" between back of cabinet and wall and between top of cabinet and ceiling for proper condensing unit air circulation.

To comply with Sanitation requirements the cabinet must be mounted on legs (6" high min.) or casters or the base must be sealed to the floor (BMG) with an N.S.F. listed silicone sealant.

Hang provided NSF Listed thermometer at front of top shelf unless cabinet provided with electronic control.

ELECTRICAL



WARNING

Before servicing electrical components in the case or the doors or door frames make sure all power to case is off. Always use a qualified technician.



NOTICE

For models with electronic ballast only:



For replacement ballast, use only ballast that complies with UL Type CC rating if unit is equipped with electronic ballast.

Check voltage and amps drawn on (Page 12-15) to determine proper line and fuse or circuit breaker size. Check power supply for low voltage. If voltage reads "120" with no load, and it drops below "100 or less" when the compressor tries to start, it is an indication of too small supply wiring or too long to run.

It is recommended that a separate circuit be run for each cabinet to prevent another appliance blowing the fuse or breaker, causing loss of product.

IMPORTANT

This cabinet is pre-wired internally for 120-volt circuits. "Tapping" or feeding the 115-volt circuit from 230-volt supply may result in overloaded circuit breakers or blown fuses and damage to electrical system, thereby voiding the warranty.

The cabinet should be grounded.

LEG AND CONDENSATE PAN INSTALLATION FOR TOP MOUNT CABINETS ONLY

1. Screw legs into existing crate mounting holes.
2. Mount pan and bracket assembly to rear of cabinet with 2 large sheet metal screws (supplied). Be sure pan is located directly under cabinet drain

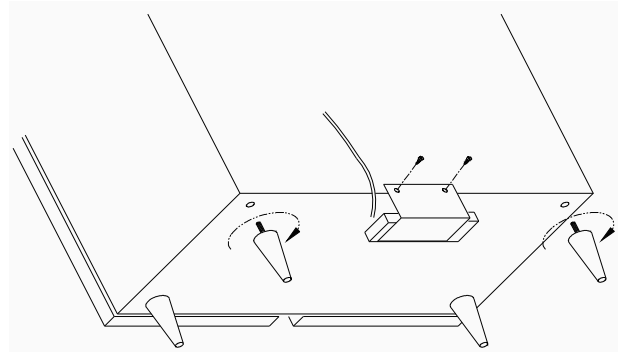

DOORS

The **BMG/TMG** cabinets have Anthony glass doors that are equipped with a patented TorqueMaster™ hinge system. The doors are easily adjusted using a flathead screwdriver (Fig.3).

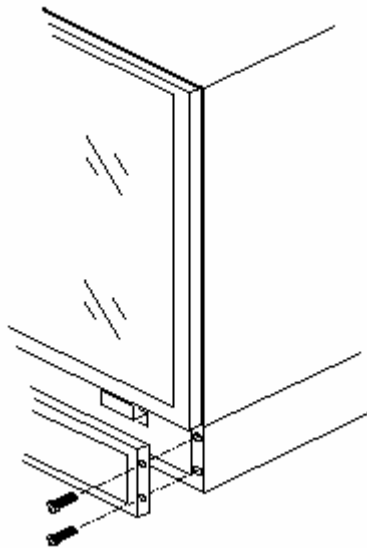

Figure 4

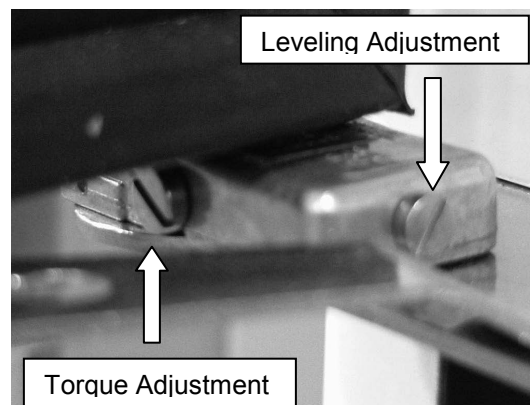

Figure 3

GRILL

To remove the door shipping clamps, remove the 4 shipping screws from the grill and remove the screws from the clamps (Fig.4), and replace grill.

MASTER-BILT ELECTRONIC REFRIGERATION CONTROL

DESCRIPTION



Fig.1 — Front panel



Info / Setpoint button.



Manual defrost / Decrease button.

INDICATIONS



Thermostat output



Fan output



Auxiliary output



Activation of 2nd parameter set



Alarm



Increase / manual activation button.



Exit / Stand-by button.

OPERATION

DISPLAY

During normal operation, the display shows either the temperature measured or one of the following indications:

DEF	Defrost in progress	HI	Room high temperature alarm
REC	Recovery after defrost	LO	Room low temperature alarm
OFF	Controller in stand-by	E1	Probe T1 failure
CL	Condenser clean warning	E2	Probe T2 failure
DO	Door open alarm		

INFO MENU

The information available in this menu is:

T1	Instant probe 1 temperature	TLO	Minimum probe 1 temperature recorded
T2	Instant probe 2 temperature	CND	Compressor working weeks
THI	Maximum probe 1 temperature recorded	LOC	Keypad state lock

Compressor When power is first turned on to the control, the LED indicator for the Thermostat output will go through the start-up delay. After a one-minute delay the compressor comes on. The LED indicator stays on while compressor relay is energized. Display will show actual box temperature. Picture above is the display layout. The compressor will be cycled off when the actual box temperature reaches its set point. The Thermostat output indicator will be off.





Fan The fans will run constantly for BMG/TMG cooler application. The Evaporator fan will also cut off when the evaporator temp is above the fan stop temperature setting.

Defrost The control uses off cycle defrost for the BMG/TMG cooler.











MANUAL DEFROST

Defrosting may also be induced manually by keeping the defrost button for 5 seconds. Once defrost has started, the defrost will go through a defrost and drip time pull down cycle.

HOW TO CHANGE THE SETPOINT

- Press button  for at least half second, to display the setpoint value.
- By keeping button  pressed, use button  or  to set the desired value (adjustment is within the minimum **SPL** and the maximum **SPH** limit).
- When button  is released, the new value is stored.

HOW TO CHANGE a parameter value

- The setup menu is accessed by pressing button + for 5 seconds.
- With button  or  select the parameter to be modified.
- Press button  to display the value.
- By keeping button  pressed, use button  or  to set the desired value.
- When button  is released, the newly programmed value is stored and the following parameter is displayed.
- To exit from the setup, press button  or wait for 30 seconds.

LIST OF PARAMETERS

Here is a list of the parameters the value of which can be changed in the programming mode, as well as their ranges.

Display Symbol	Parameter	Range	Master-Bilt's BMG/TMG Setting
SP	Temperature Set Point	SPL...SPH	35°F
HYS	Temperature Differential	1 to 255°F	5°
SPL	Minimum Temperature limit setpoint	-50...SPH	27°F
SPH	Maximum Temperature limit setpoint	SPH... 120°	50°F
AHA	High Temperature Alarm	-50...120°	65°F
ALA	Low Temperature Alarm	50...120°	0°F
ATD	Temperature Alarm Delay	0...120min	30min
DFR	Number of Defrost Cycle per 24hr	0...24	Off Cycle
DLI	Defrost Termination Temperature	-50...120°	-
DTO	Maximum Defrost Duration	1...120min	30min

ELECTRICAL CONNECTIONS

The controller is provided with a screw terminal block to connect cables with a cross section up to 2,5 mm². Before connecting cables make sure the power supply complies with the control's requirements. Separate the probe cables from the power supply cables, the outputs and the power connections. Do not exceed the maximum current allowed on each relay, in case of heavier loads use a suitable external relay or contactor's.

PROBE CONNECTIONS

The probes shall be mounted with the bulb upwards to prevent damage due to casual liquid infiltration. It is recommended to place the thermostat probe at the warmest location of return air streams to correctly measure the average room temperature. Place the defrost termination probe among the evaporator fins in the coldest place, where most ice is formed, far from heaters or from the warmest place during defrost, to prevent premature defrost termination.

SERVICE INSTRUCTIONS

1. High head pressure and high back pressure:
 - A. Condenser coil clogged or restricted
 - B. Condenser fan motor defective.
 - C. Air discharge in rear of cabinet restricted.
2. Low back pressure and low head pressure:
 - A. Restriction in system.
 - B. Refrigerant undercharged.
 - C. Leak in system
3. Pressure normal – cabinet warm:
 - A. Coil blocked with frost (see #4).
 - B. Refrigerant undercharged.
 - C. Control set too warm.
4. Cabinet not cycling – coil blocked with frost:
 - A. Defective temperature controller.
 - B. Refrigerant overcharged.
 - C. Location too hot.
 - D. Condenser clogged.
 - E. Condenser fan motor defective.
5. Compressor starts and runs – but cycles on overload:
 - A. Low voltage
 - B. Relay defective.
 - C. Overload defective.
 - D. High head pressure (see #1).

TEMPERATURE SENSORS AND FAN MOTOR REPLACEMENT

Before making any change, technician should:

1. Disconnect power to the cabinet
2. Remove screws from venturi and pull down

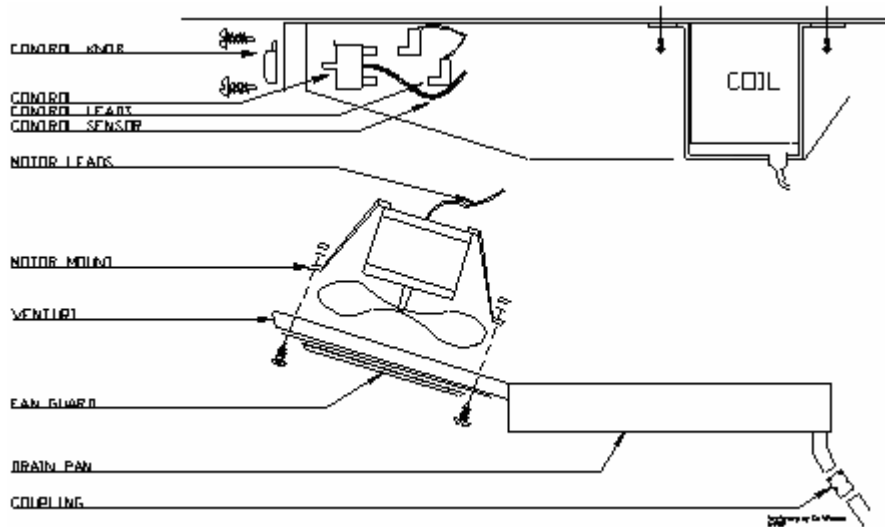

To change a temperature sensor (cabinet zone sensor or defrost termination sensor), simply disconnect the sensor wires from the controller and replace the new sensor in the original position. Use plastic tie to tighten the zone sensor. Insert the sensor for defrost termination firmly into the evaporator coil, in between the fins. Make sure the sensor wires do not touch or are not close to any heater rods

To change fan motor – disconnect fan motor leads – remove screws from fan guards and motor mounts.

FINAL CHECK LIST

- A. Check operating pressures.
- B. Check electrical requirements of unit to supply voltage.
- C. Set temperature control for desired temperature range.
- D. Check sight glass for proper refrigerant charge if provided
- E. Check condensing unit for vibrating or rubbing tubing. Dampen and clamp as required.

MASTER-BILT PART LIST

The table below gives Master-Bilt part numbers. Use this chart when ordering replacement parts for your **BMG/TMG** cabinets. Always Advise Cabinet Serial Number When Ordering Parts

Description	BMG/TMG-27	BMG/TMG-48	BMG/TMG-52	BMG/TMG-74	BMG/TMG-80
Accumulator	09-00812	09-00813	09-00813	09-00812	09-00812
Ballast	23-01709	23-01704	23-01704	23-01704	23-01704
Bulb	23-01575	23-01575	23-01575	23-01575	23-01575
Lamp Holder	23-50562	23-50562	23-50562	23-50562	23-50562
Capillary Tube	11-01450	11-01450	11-01450	11-01450	11-01450
Condensate Heater "B"	17-00380				
Condensate Heater "T"	17-00421	17-00421	17-00421	17-00421	17-00421
Compressor "B"	03-50330	03-50330	03-50330	03-14901	03-14901
Compressor "T"	03-50330	03-50330	03-50330	03-14901	03-14901
Condensing Coil "B"	07-13253	07-13253	07-13253	07-13296	07-13296
Condensing Coil "T"					
Door-L.H.	31-02491	31-02492	31-02513	31-02492	31-02513
Door R.H.		31-02493	31-02514		
Door Trim	29-01379	29-01379	29-01379	29-01379	29-01379
Drier	09-09309	09-09309	09-09309	09-09309	09-09307
Evaporator Coil	07-13293	07-13293	07-13293	07-13311	07-13311
Evaporator Fan Blade	15-13106	15-13106	15-13106	15-13106	15-13106
Evaporator Fan Guard	25-01324	25-01324	25-01324	25-01324	25-01324
Evaporator Fan Motor	13-13181	13-13181	13-13181	13-13181	13-13181
Female Door Plug	21-00568	21-00568	21-00568	21-00568	21-00568
Leg "T"	27-00558	27-00558	27-00558	27-00558	27-00558
Light Switch	19-13118	19-13118	19-13118	19-13118	19-13118
Pilaster	200I166XX	200-16156C	200-16156C	200-16156C	200-16156C
Power Cord "B" 120/15A 220/15A	21-01201	21-01201	21-01201	21-01513 21-01243	21-01513 21-01243
Power Cord "T" 120/15A 220/15A	21-01454	21-01454	21-01454	21-01454 21-01243	21-01454 21-01243
Electronic Control	19-14243	19-14243	19-14243	19-14243	19-14243
Temperature Sensor T1	19-14244	19-14244	19-14244	19-14244	19-14244
Temperature Sensor T2	19-14245	19-14245	19-14245	19-14245	19-14245
External Relay	19-14284	19-14284	19-14284	19-14284	19-14284
Thermometer	44-00963	44-00963	44-00963	44-00963	44-00963
14-1/16" X 45"		25-01296		25-01296	
15-7/8" X 45"	25-01294		25-01294		25-01294
18-3/4" X 45"		25-01295	25-01295	25-01295	25-01295

Accessories

Description	BMG/TMG-27	BMG/TMG-48	BMG/TMG-52	BMG/TMG-74	BMG/TMG-80
Baskets (Cantilever)		A200-16600	A302-16600	A200-16600	A302-16600
Castors (4) 3" Diameter	A200-11140	A200-11140	A200-11140		
Castors (6) 3" Diameter				A212-11140	A212-11140
Legs 6"	A200-11170	A200-11170	A200-11170	A212-11170	A212-11170
Shelves (Cantilever)	33-01473	33-01474	33-01475	33-01474	33-01475

SALE AND DISPOSAL

OWNER RESPONSIBILITY

If you sell or give away your Master-Bilt cabinet you must make sure that all safety labels and the Installation - Service Manual are included with it. If you need replacement labels or manuals, Master-Bilt will provide them free. Contact the customer service department at Master-Bilt at (800) 684-8988.

The customer service department at Master-Bilt should be contacted at the time of sale or disposal of your cabinet so records may be kept of its new location

If you sell or give away your Master-Bilt cabinet and you evacuate the refrigerant charge before shipment, Master-Bilt recommends that the refrigerant charge be properly recovered in compliance with section 608 of the Clean Air Act effective November 1995 and in accordance with all applicable local, regional, or national standards.

